



TECHNICAL MANUAL

WIRELESS LAN INTERFACE

WF-RAC

CONTENTS

1.	APPLICABLE MODELS	1
2.	EXTERIOR DIMENSIONS	2
3.	ELECTRICAL WIRING	2
4.	WIRING CONNECTION	3
5.	PRINTED-CIRCUIT BOARD COMPONENT LAYOUT	3
6.	FUNCTIONS LIST	4
7.	MAIN UNIT INSTALLATION MANUAL	7
8.	MAIN UNIT USER'S MANUAL	18
9.	APPLICATION OPERATION MANUAL	34
10.	FAQ (Troubleshooting)	86
11.	TIMER FUNCTION OPERATION EXPLANATION	97

1. APPLICABLE MODELS

Part name	Model	Applicable models
Wireless LAN interface	WF-RAC	ZSX · ZS · ZR · ZMX · ZM series

2. EXTERIOR DIMENSIONS

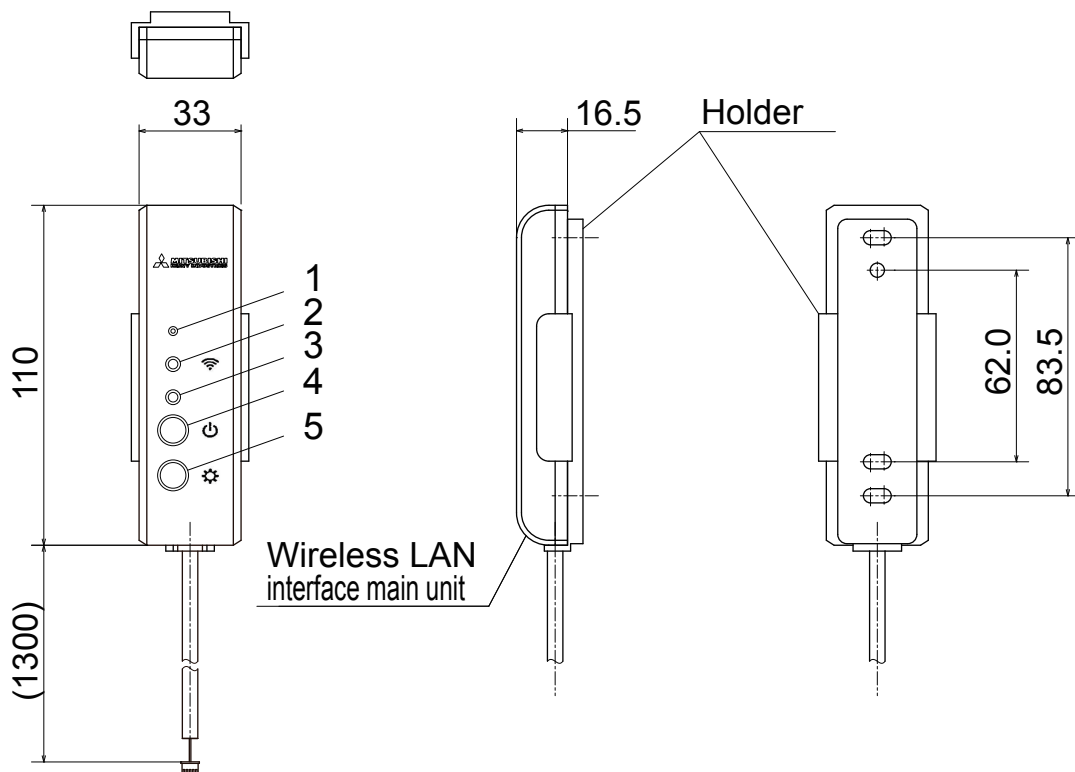

No.	Name
1	Reset button
2	Communication LED
3	Running LED
4	Power button
5	Set button

3. ELECTRICAL WIRING

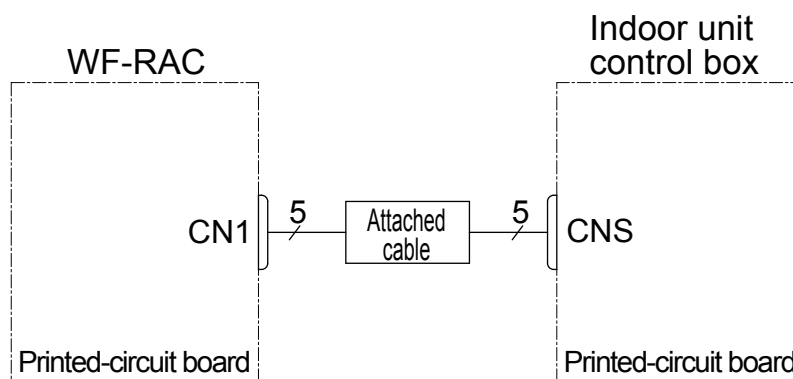

Symbol	Name
CNS,CN1	Connector

4. WIRING CONNECTION

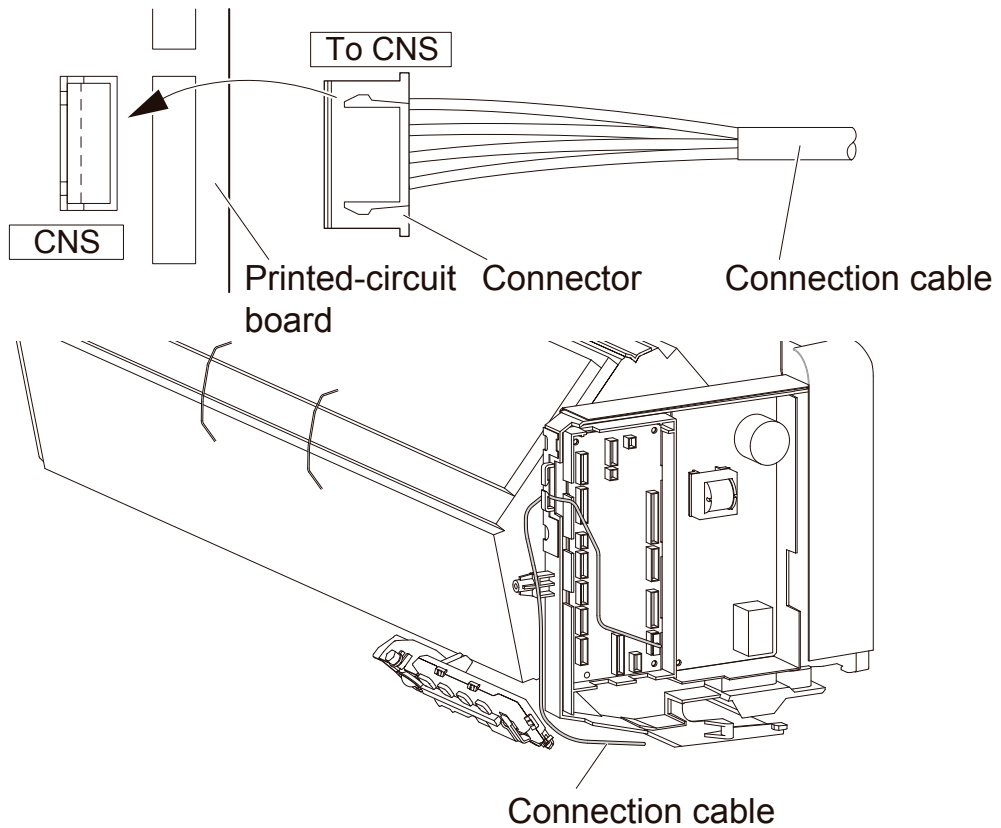

5. PRINTED-CIRCUIT BOARD COMPONENT LAYOUT

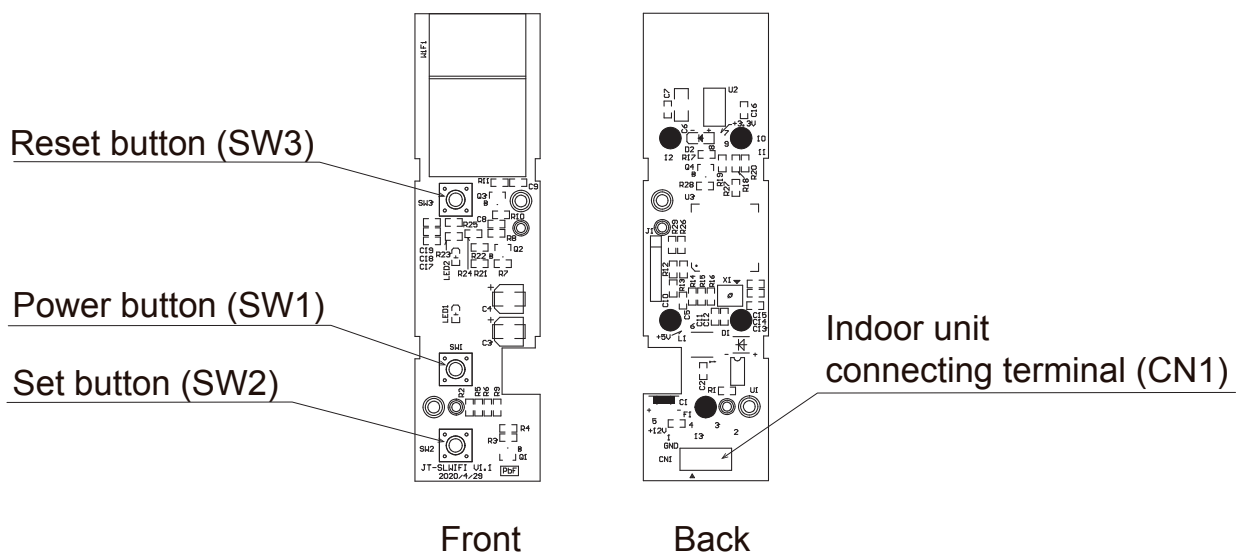

6. FUNCTIONS LIST

SRK50ZS-W/A Operable Table

Function	Setting	Operation by remote control		Operation by option parts (Before)		Operation by option parts (After)	
		Not connected Option parts	Connecting Option parts	Wired remote control (SC-BIKN2)	Smart M-Air (WF-RAC)	Wired remote control (SC-BIKN2)	Smart M-Air (WF-RAC)
ON/OFF	ON	○	○	○	○	○	○
	OFF	○	○	○	○	○	○
OPERATION MODE select	AUTO	○	○	○	○	○	○
	COOL	○	○	○	○	○	○
	HEAT	○	○	○	○	○	○
	DRY	○	○	○	○	○	○
	FAN	○	○	○	○	○	○
	SELF CLEAN	○	○	× (Displayed as FAN)	× (Displayed as FAN)	× (Displayed as FAN)	× (Displayed as FAN)
	ALLERGEN CLEAR	○	○	× (Displayed as FAN)	× (Displayed as FAN)	× (Displayed as FAN)	× (Displayed as FAN)
	NIGHT SETBACK	○	○	× (Displayed as HEAT)	× (Displayed as HEAT)	× (Displayed as HEAT)	× (Displayed as HEAT)
	Home leave mode	–	–	○	○*1	○	○*1
Temperature adjustment	18°C~30°C	○	○	○*2	○*2	○*2	○*2
FAN SPEED	AUTO	○	○	○	○	○	○
	HIGH POWER	○	○	× (Displayed as Hi)	× (Displayed as ■■■)	× (Displayed as Hi)	× (Displayed as ■■■)
	Hi	○	○	○ (Displayed as PHI)	○ (Displayed as ■■■)	○ (Displayed as PHI)	○ (Displayed as ■■■)
	Me	○	○	○ (Displayed as Hi)	○ (Displayed as ■■■)	○ (Displayed as Hi)	○ (Displayed as ■■■)
	Lo	○	○	○ (Displayed as Me)	○ (Displayed as ■■)	○ (Displayed as Me)	○ (Displayed as ■■)
	ULo	○	○	○ (Displayed as Lo)	○ (Displayed as ■)	○ (Displayed as Lo)	○ (Displayed as ■)
	ECO	○	○	× (Displayed as Lo)	× (Displayed as ■)	× (Displayed as Lo)	× (Displayed as ■)
Air flow direction adjustment	Up/down (1 step)	○	○	○	○	○	○
	Up/down (2 step)	○	○	○	○	○	○
	Up/down (3 step)	○	○	× (Displayed as 2 step)	× (Displayed as 2 step)	× (Displayed as 2 step)	× (Displayed as 2 step)
	Up/down (4 step)	○	○	○ (Displayed as 3 step)	○ (Displayed as 3 step)	○ (Displayed as 3 step)	○ (Displayed as 3 step)
	Up/down (5 step)	○	○	○ (Displayed as 4 step)	○ (Displayed as 4 step)	○ (Displayed as 4 step)	○ (Displayed as 4 step)
	Up/down (swing)	○	○	○	○	○	○
	Up/down (flap stopped)	○	○	× (Displayed as 2 step)	× (Displayed as 2 step)	× (Displayed as 2 step)	× (Displayed as 2 step)
	Left/right (leftmost)	○	○	○	○	○	○
	Left/right (left)	○	○	○	○	○	○
	Left/right (middle)	○	○	○	○	○	○
	Left/right (right)	○	○	○	○	○	○
	Left/right (rightmost)	○	○	○	○	○	○
	Left/right (wide)	○	○	○	○	○	○
	Left/right (spot)	○	○	○	○	○	○
	Left/right (swing)	○	○	○	○	○	○
	Left/right (louver stopped)	○	○	× (Displayed as middle)	× (Displayed as middle)	× (Displayed as middle)	× (Displayed as middle)
	3D AUTO	○	○	○	○	○	○
MENU function	Various TIMERS	○	×	×	×	○	○
	WEEKLY TIMER(Remote control)	○	×	×	×	○	○
	WEEKLY TIMER(Optional parts)	–	–	○	○	○	○
	installation location setting	○	○	×	×	×	×
	Silent	○	○	○	×	○	×
	Wireless LAN connection setting	○	○	×	○	×	○
	Wireless LAN communication	○	○	×	○	×	○
	Initialization of wireless LAN	○	○	×	○	×	○
	Fan control in heating thermo-OFF	○	○	○	×	○	×
	Display brightness adjustment	○	○	×	×	×	×
	Shut-off reminder alert	–	–	–	○	–	○

○ : Operation/Setting Available
 × : Operation/Setting/Display N/A
 – : No function

*1 : Operates with the default settings of the indoor unit (operation switching is cooling or heating display)
 *2 : The setting is in 0.5 °C increments, but the indoor unit is controlled only in 1 °C increments.
 0.5 °C is controlled by rounding up (e.g. remote control setting 24.5 °C → indoor unit 25 °C setting)

SRK60ZSX-W/A Operable Table

Function	Setting	Operation by remote control		Operation by option parts (Before)		Operation by option parts (After)	
		Not connected Option parts	Connecting Option parts	Wired remote control (SC-BIKN2)	Smart M-Air (WF-RAC)	Wired remote control (SC-BIKN2)	Smart M-Air (WF-RAC)
ON/OFF	ON	○	○	○	○	○	○
	OFF	○	○	○	○	○	○
OPERATION MODE select	AUTO	○	○	○	○	○	○
	COOL	○	○	○	○	○	○
	HEAT	○	○	○	○	○	○
	DRY	○	○	○	○	○	○
	FAN	○	○	○	○	○	○
	SELF CLEAN	○	○	× (Displayed as FAN)	× (Displayed as FAN)	× (Displayed as FAN)	× (Displayed as FAN)
	ALLERGEN CLEAR	○	○	× (Displayed as FAN)	× (Displayed as FAN)	× (Displayed as FAN)	× (Displayed as FAN)
	NIGHT SETBACK	○	○	× (Displayed as HEAT)	× (Displayed as HEAT)	× (Displayed as HEAT)	× (Displayed as HEAT)
	Home leave mode	-	-	○	○*1	○	○*1
Temperature adjustment	18°C~30°C	○	○	○*2	○*2	○*2	○*2
FAN SPEED	AUTO	○	○	○	○	○	○
	HIGH POWER	○	○	× (Displayed as Hi)	× (Displayed as ■■■)	× (Displayed as Hi)	× (Displayed as ■■■)
	Hi	○	○	○ (Displayed as PHi)	○ (Displayed as ■■■)	○ (Displayed as PHi)	○ (Displayed as ■■■)
	Me	○	○	○ (Displayed as Hi)	○ (Displayed as ■■■)	○ (Displayed as Hi)	○ (Displayed as ■■■)
	Lo	○	○	○ (Displayed as Me)	○ (Displayed as ■■)	○ (Displayed as Me)	○ (Displayed as ■■)
	Ulo	○	○	○ (Displayed as Lo)	○ (Displayed as ■)	○ (Displayed as Lo)	○ (Displayed as ■)
Air flow direction adjustment	Up/down (1 step)	○	○	○	○	○	○
	Up/down (2 step)	○	○	○	○	○	○
	Up/down (3 step)	○	○	× (Displayed as 2 step)	× (Displayed as 2 step)	× (Displayed as 2 step)	× (Displayed as 2 step)
	Up/down (4 step)	○	○	○ (Displayed as 3 step)	○ (Displayed as 3 step)	○ (Displayed as 3 step)	○ (Displayed as 3 step)
	Up/down (5 step)	○	○	○ (Displayed as 4 step)	○ (Displayed as 4 step)	○ (Displayed as 4 step)	○ (Displayed as 4 step)
	Up/down (swing)	○	○	○	○	○	○
	Up/down (flap stopped)	○	○	× (Displayed as 2 step)	× (Displayed as 2 step)	× (Displayed as 2 step)	× (Displayed as 2 step)
	Left/right (leftmost)	○	○	○	○	○	○
	Left/right (left)	○	○	○	○	○	○
	Left/right (middle)	○	○	○	○	○	○
	Left/right (right)	○	○	○	○	○	○
	Left/right (rightmost)	○	○	○	○	○	○
	Left/right (wide)	○	○	○	○	○	○
	Left/right (spot)	○	○	○	○	○	○
	Left/right (swing)	○	○	○	○	○	○
Left/right (lower stopped)	○	○	× (Displayed as middle)	× (Displayed as middle)	× (Displayed as middle)	× (Displayed as middle)	
3D AUTO	○	○	○	○	○	○	
MENU function	Various TIMERS	○	×	×	×	○	○
	WEEKLY TIMER(Remote control)	○	×	×	×	○	○
	WEEKLY TIMER(Option parts)	-	-	○	○	○	○
	installation location setting	○	○	×	×	×	×
	Silent	○	○	○	×	○	×
	Wireless LAN connection setting	○	○	×	○	×	○
	Wireless LAN communication	○	○	×	○	×	○
	Initialization of wireless LAN	○	○	×	○	×	○
	Fan control in heating thermo-OFF	○	○	○	×	○	×
	Display brightness adjustment	○	○	×	×	×	×
	HIGH POWER/ECO	○	○	○	×	○	×
	AUTO OFF	○	○ (1 hour only)	○ (1 hour only)	×	○ (1 hour only)	×
	Shut-off reminder alert	-	-	-	○	-	○

○ : Operation/Setting Available

× : Operation/Setting/Display N/A

- : No function

*1 : Operates with the default settings of the indoor unit (operation switching is cooling or heating display)

*2 : The setting is in 0.5 °C increments, but the indoor unit is controlled only in 1 °C increments.

0.5 °C is controlled by rounding up (e.g. remote control setting 24.5 °C → indoor unit 25 °C setting)

SRK100ZR-W Operable Table

Function	Setting	Operation by remote control		Operation by option parts (Before)		Operation by option parts (After)	
		Not connected Option parts	Connecting Option parts	Wired remote control (SC-BIKN2)	Smart M-Air (WF-RAC)	Wired remote control (SC-BIKN2)	Smart M-Air (WF-RAC)
ON/OFF	ON	○	○	○	○	○	○
	OFF	○	○	○	○	○	○
OPERATION MODE select	AUTO	○	○	○	○	○	○
	COOL	○	○	○	○	○	○
	HEAT	○	○	○	○	○	○
	DRY	○	○	○	○	○	○
	FAN	○	○	○	○	○	○
	SELF CLEAN	○	○	× (Displayed as FAN)	× (Displayed as FAN)	× (Displayed as FAN)	× (Displayed as FAN)
	ALLERGEN CLEAR	○	○	× (Displayed as FAN)	× (Displayed as FAN)	× (Displayed as FAN)	× (Displayed as FAN)
	NIGHT SETBACK	○	○	× (Displayed as HEAT)	× (Displayed as HEAT)	× (Displayed as HEAT)	× (Displayed as HEAT)
Home leave mode	-	-	○	○ *1	○	○ *1	
Temperature adjustment	18°C~30°C	○	○	○ *2	○ *2	○ *2	○ *2
FAN SPEED	AUTO	○	○	○	○	○	○
	HIGH POWER	○	○	× (Displayed as Hi)	× (Displayed as ■■■)	× (Displayed as Hi)	× (Displayed as ■■■)
	Hi	○	○	○ (Displayed as PHi)	○ (Displayed as ■■■)	○ (Displayed as PHi)	○ (Displayed as ■■■)
	Me	○	○	○ (Displayed as Hi)	○ (Displayed as ■■■)	○ (Displayed as Hi)	○ (Displayed as ■■■)
	Lo	○	○	○ (Displayed as Me)	○ (Displayed as ■■)	○ (Displayed as Me)	○ (Displayed as ■■)
	ULo	○	○	○ (Displayed as Lo)	○ (Displayed as ■)	○ (Displayed as Lo)	○ (Displayed as ■)
	ECO	○	○	× (Displayed as Lo)	× (Displayed as ■)	× (Displayed as Lo)	× (Displayed as ■)
Air flow direction adjustment	Up/down (1 step)	○	○	○	○	○	○
	Up/down (2 step)	○	○	○	○	○	○
	Up/down (3 step)	○	○	× (Displayed as 2 step)	× (Displayed as 2 step)	× (Displayed as 2 step)	× (Displayed as 2 step)
	Up/down (4 step)	○	○	○ (Displayed as 3 step)	○ (Displayed as 3 step)	○ (Displayed as 3 step)	○ (Displayed as 3 step)
	Up/down (5 step)	○	○	○ (Displayed as 4 step)	○ (Displayed as 4 step)	○ (Displayed as 4 step)	○ (Displayed as 4 step)
	Up/down (swing)	○	○	○	○	○	○
	Up/down (flap stopped)	○	○	× (Displayed as 2 step)	× (Displayed as 2 step)	× (Displayed as 2 step)	× (Displayed as 2 step)
	Left/right (leftmost)	○	○	○	○	○	○
	Left/right (left)	○	○	○	○	○	○
	Left/right (middle)	○	○	○	○	○	○
	Left/right (right)	○	○	○	○	○	○
	Left/right (rightmost)	○	○	○	○	○	○
	Left/right (wide)	○	○	○	○	○	○
	Left/right (spot)	○	○	○	○	○	○
	Left/right (swing)	○	○	○	○	○	○
Left/right (louver stopped)	○	○	× (Displayed as middle)	× (Displayed as middle)	× (Displayed as middle)	× (Displayed as middle)	
3D AUTO	○	○	○	○	○	○	
MENU function	Various TIMERS	○	×	×	×	○	○
	WEEKLY TIMER(Remote control)	○	×	×	×	○	○
	WEEKLY TIMER(Option parts)	-	-	○	○	○	○
	Installation location setting	○	○	×	×	×	×
	Silent	○	○	○	×	○	×
	Wireless LAN connection setting	-	-	×	○	×	○
	Wireless LAN communication	-	-	×	○	×	○
	Initialization of wireless LAN	-	-	×	○	×	○
	Fan control in heating thermo-OFF	-	-	○	×	○	×
	Shut-off reminder alert	-	-	-	○	-	○

○ : Operation/Setting Available
 × : Operation/Setting/Display N/A
 - : No function

*1 : Operates with the default settings of the indoor unit (operation switching is cooling or heating display)
 *2 : The setting is in 0.5 °C increments, but the indoor unit is controlled only in 1 °C increments.
 0.5 °C is controlled by rounding up (e.g. remote control setting 24.5 °C → indoor unit 25 °C setting)

7. MAIN UNIT INSTALLATION MANUAL



RKZO12A105

- This INSTALLATION MANUAL can also be viewed on the home page of MITSUBISHI HEAVY INDUSTRIES THERMAL SYSTEMS, LTD.
- Please download USER'S MANUAL (including the guarantee form) via the QR code or from the home page described later.





Safety precautions Please read these safety precautions carefully before installing and using this product.

- Be sure to follow these precautions because they describe important safety-related information.

 WARNING	Failure to follow warnings may cause serious consequences such as death or severe injury.
 CAUTION	Failure to follow cautions may cause injury and/or property damage. Depending on the situation, failure to follow cautions may lead to serious consequences.

- The "graphic symbols" in this document have the following meanings.

	Prohibited.
	Be sure to follow instructions.

- After the installation work is completed, check the installation according to the installation work check items. Request your customer to keep this installation manual at the customer's site.

 **WARNING**

- Do not bundle, roll, or step on connection cables to prevent cables from becoming deformed.
(Deformation may cause heat generation, fire, or electric shocks due to loose connection, insulation failure, current exceeding the allowable limit, etc.)
- Do not install this product near automatic control equipment such as an automatic door or fire-alarm device.
(Such improper installation may cause an accident due to malfunction of equipment.)
- Do not install this product at a location in a hospital, etc. where the use of wireless devices is prohibited.
(Such improper installation may cause malfunction of medical equipment due to a wireless device.)
- Do not use this product near a person with a cardiac pacemaker or implanted defibrillator.
(Such improper use may cause malfunction of a medical device.)
- Do not disassemble, modify, or repair this product.
(Such an activity may cause an electric shock, fire, or any injury.)



- For installation work, request the sales outlet for the product or an authorized dealer to install the product.
(Improper installation may cause a water leakage, electric shock, or fire.)

 **WARNING**

- In the installation work, install the product securely according to this installation manual, and be sure to use accessories and specified parts for installation.
(Improper installation may cause a water leakage, electric shock, or fire.)
- The electrical engineering work must be performed by a qualified electrical worker according to the technical standards concerning electrical equipment, interior wiring regulation, and installation manual.
(Improper work may cause an electric shock or fire.)
- For wiring, use the specified cable, and connect the cable securely. Then, fix the terminal connection part securely to prevent external force from being transmitted to the connection part through the cable.
(Improper connection may cause any failure, heat generation, or fire.)
- Before installation, unplug the main unit of the air-conditioner.
(Installation work without unplugging the equipment may cause an electrical shock.)
- When you unplug the connection cable, hold the connector to unplug the cable.
(Improper work may cause an electric shock or fire.)

WARNING



- This appliance is not intended for use by persons (including Children) with reduced physical, sensory or mental capabilities, or lack of experience and knowledge, unless they have been given supervision or instruction concerning use of the appliance by a person responsible for their safety.
- This appliance can be used by children aged from 8 years and above and persons with reduced physical, sensory or mental capabilities or lack of experience and knowledge if they have been given supervision or instruction concerning use of the appliance in a safe way and understand the hazards involved.
- Children shall not play with the appliance.
- Cleaning and user maintenance shall not be made by children without supervision.
- Children should be supervised to ensure that they do not play with the appliance.
- If cable is damaged, it must be replaced by the manufacturer, its service agent or a similarly qualified person in order to avoid a hazard.

 **CAUTION**



- Do not use the product near another wireless device, microwave, cordless phone, fax machine, etc.
(Improper use may cause malfunction.)



- To prevent any failure due to electrical discharge, touch your hand with metal around you to remove static electricity from your body before you touch this product.
(Improper operation may cause any failure.)
- Be sure to keep dry because the product is not waterproof.
(Improper connection may cause any failure, heat generation, or fire.)

1. Selecting the installation location and installing the main body

<Selecting the installation location>

Install this product in a location that satisfies the following conditions with the agreement of your customer.

- A location where this product is not exposed to direct sunlight
- A location where this product is not influenced by a heating device such as a stove
- A location with no moisture, and where this product is not exposed to water
- A location where this product is not exposed directly to oil droplets or steam
- A location without projections or depressions on the installation surface
- A location at least 1m away from a TV set, stereo, or radio (the image may be disturbed, and noise may be generated.)
- A location where this product is not influenced by a high-frequency or electrical device

<Cautions for installation>

- Do not mount the holder and main unit inside the indoor unit.
- Fix the holder on a wall, pillar, etc. securely with attached screws. (Do not mount it on a clay wall, etc.)
- Install the connection cable securely by sliding the main unit from above to prevent the cable from being trapped in the holder.
- Install the main unit within the range where the connection cable can reach the indoor unit.
(The length of the connection cable is about 1.3m.)
- Never extend the connection cable because this product may fail to operate normally if the cable is extended.
- Remove the body from the holder and install it in a position where the body label can be seen. (SSID and KEY (Password) may need to be checked.)

<When installing the holder and main unit inside an indoor unit in which they can be included>

- Do not install them inside an indoor unit, except when a unit can include them.

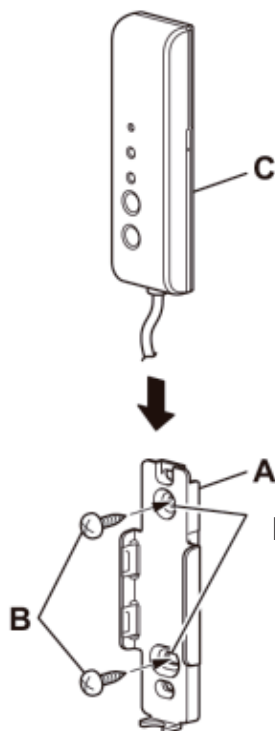

Holes for mounting the unit on a wall

Accessories supplied with this product

Check the accessories supplied with this product.

Symbol	Part name	Quantity
A	Holder	1
B	Holder mounting screw	2
C	Main unit	1
D	Installation manual (this document)	1

2. Connecting this product with the indoor unit

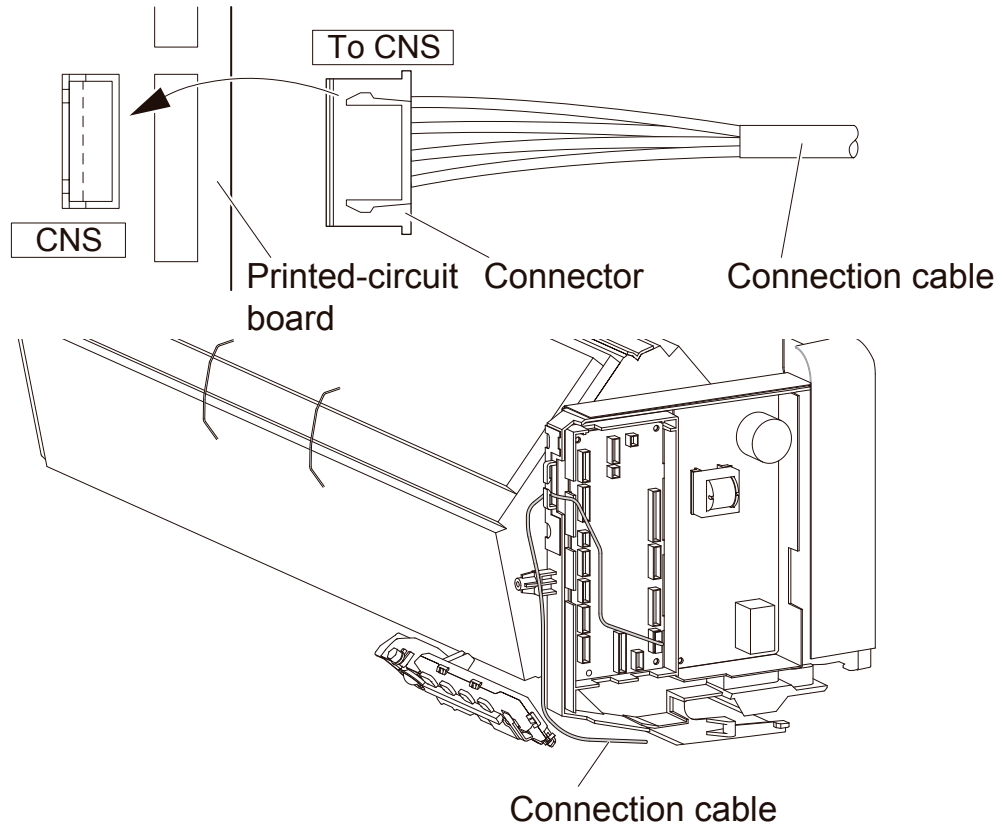

Connect the indoor unit connection cable to the indoor control printed-circuit board.

- For the connection of the indoor unit, refer to the “description for connecting the interface kit” in the installation manual of the indoor unit.
- Connect the connector of the indoor unit connection cable to the terminal (CNS) on the indoor control board by installing the cable along the wiring route from below.
- Securely connect the connector of the indoor connection cable to the CNS terminal on the indoor control board.
- About the handling of the connection cable
If the connection cable is too long, the redundant cable section should be stored loosely in a space on the back of the indoor unit.

After the installation work is completed, be sure to check the following.

Installation work check items

- Is the holder fixed securely?
- Is the cable trapped? Is the connection cable under a load?
- Is the connector connected properly and securely?
- Did you forget to tighten a screw on the main body of the indoor unit?
- Turn ON the power to the indoor unit. After that, do the Communication LED and Running LED become ON for about 10 seconds and then OFF? (If the Communication LED and Running LED blink alternately at intervals of 10 seconds, check the connection.)

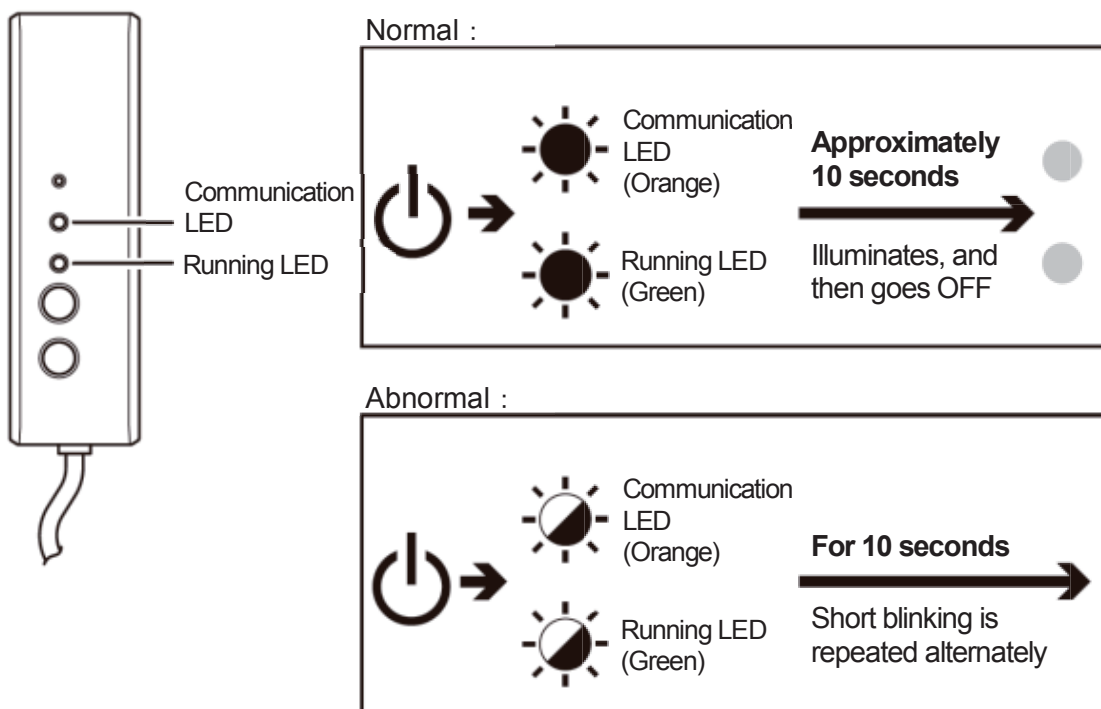

- Did you explain the cautions in the user's manual to the customer?
 - Did you pass the installation manual to your customer and request the customer to thoroughly read and store the manual?
- * If you have any question on the installation, please contact us at the URL on the last page for inquiry.

Notes for users

- Before using the product, the user needs to install the dedicated application.
The user needs to install the smartphone application and then set up a connection with the interface. Set up a connection with the interface according to the user's manual downloaded via the following QR code or from the URL.
- The application is free. Communications charges are applied to downloading and operation.
- The application name “Smart M-Air” and download service names “Google Play” and “App Store” may be changed in the future.

How to install the “Smart M-Air” smartphone application	
<p>For Android</p> <ol style="list-style-type: none"> 1. Open [Google Play]. 2. Search for [Smart M-Air]. 3. Install the application according to the instructions on the screen. 	<p>For iOS (iPhone)</p> <ol style="list-style-type: none"> 1. Open [App Store]. 2. Search for [Smart M-Air]. 3. Install the application according to the instructions on the screen.
<p>User's Manual</p> <p>Refer to the home page of MITSUBISHI HEAVY INDUSTRIES THERMAL SYSTEMS, LTD.</p> <p>http://www.mhi-mth.co.jp/en/products/detail/air-conditioner_users_manual.html</p>	

- CE Marking
Refer to the home page of MITSUBISHI HEAVY INDUSTRIES THERMAL SYSTEMS, LTD.
https://www.mhi-mth.co.jp/en/technology/ce_marking.php

mitsubishi Heavy Industries Thermal Systems, Ltd.

2-3, Marunouchi 3-chome, Chiyoda-ku, Tokyo, 100-8332, Japan
<http://www.mhi-mth.co.jp/en/>

Mitsubishi Heavy Industries Air-Conditioning Europe, Ltd.

5 The Square, Stockley Park, Uxbridge, Middlesex, UB11 1ET, United Kingdom
Tel : +44-333-207-4072
Fax: +44-333-207-4089
<http://www.mhiae.com/>

MHIAE SERVICES B.V.

(Wholly-owned subsidiary of MITSUBISHI HEAVY INDUSTRIES AIR-CONDITIONING EUROPE, LTD.)

Herikerbergweg 238, Luna ArenA, 1101 CM Amsterdam, Netherlands
P.O.Box 23393 1100 DW Amsterdam, Netherlands
Tel : +31-20-406-4535
<http://www.mhiaeservices.com/>

Mitsubishi Heavy Industries Air-Conditioners Australia, Pty. Ltd.

Block E, 391 Park Road, Regents Park, NSW, 2143 PO BOX 3167, Regents Park, NSW, 2143
Tel : +61-2-8774-7500
Fax: +61-2-8774-7501
<https://www.mhiala.com.au>

8. MAIN UNIT USER'S MANUAL

RKZO12A106 

Safety precautions

Please read these safety precautions carefully before using this product and use the product properly.

- Be sure to follow these precautions as they describe important safety-related information.

 **WARNING**

Failure to follow warnings may cause serious consequences, such as death or severe injury.

 **CAUTION**



Failure to follow cautions may cause injury and/or property damage. Depending on the situation, failure to follow cautions may lead to serious consequences.

- The “graphic symbols” in this document have the following meanings.



 Prohibited.

 Be sure to follow instructions.

 **WARNING**

-  • Do not disassemble, modify, or repair this product.
(Improper work may cause a fire, electrical shock, or injury.)
 - Do not immerse the wireless LAN interface in water, splash water on it, or handle it with wet hands.
(Improper handling may cause an electric shock or fire.)
 - Do not use the product at a location where the use of wireless devices is prohibited such as in a hospital, etc.
(Radio waves from this product may affect medical electrical devices, resulting in an accident due to malfunction.)
 - Do not turn ON the wireless LAN interface function near a person wearing a pacemaker or defibrillator or at a place where they may be used.
(Such improper operation may affect the operation of the pacemaker, resulting in an accident.)
 - Do not turn ON the wireless LAN interface function near automatic control equipment such as an automatic door or fire-alarm device.
(Such improper installation may cause an accident due to malfunction of equipment.)
-  • For installation of the product, request the sales outlet for the product or an authorized dealer.
(Improper work may cause an electric shock or fire.)
 - If abnormal smell, abnormal sound, overheating, or smoke occurs, immediately unplug the air conditioner or turn OFF the breaker.
(Failure to do so may cause a fire or failure.)
→ Request inspection from the sales outlet for the product.
 - If the wireless LAN interface is dropped or broken, unplug the air conditioner or turn OFF the breaker.
(Failure to do so may cause a fire or electrical shock.)
→ Request inspection from the sales outlet for the product.

 **CAUTION**

-  • Do not install the product in a place where inflammable gas may leak.
(Improper installation may cause ignition.)
 - Do not install the product in a place within the reach of infants.
(Improper installation may cause injury.)
 - Do not get on an unstable step when setting or maintaining the wireless LAN interface.
(Such an activity may cause injury.)
-
-  • Unplug the air conditioner when it will not be used for a long period of time.
(Failure to do so may cause heat generation or ignition due to dust.)
 - Do not drop or bump the product. Also, do not apply strong pressure to the product.
(Improper use may cause malfunction or failure.)
 - Depending on the communication state, the operation contents set by a smartphone may not be communicated to the air conditioner.
Be sure to confirm the contents on the main screen displayed on the application.

 **WARNING****Note for Using This Product**

When operating the air conditioner away from home, carefully confirm the state of the air conditioner, its periphery, and people in the room beforehand to ensure safety. Failure to do so may cause death, serious injury, or property damage in some cases.

■ Check the following points in advance (while at home).

- The air conditioner must be free from any abnormality. There is no adverse effect on persons and the room even when there is a change in wind speed etc. (For example, no objects are easily blown away. Such objects may fall due to wind, resulting in a fire, injury, or property damage.)
- Thoroughly grasp the setting state such as a timer reservation set by another person.
(Unexpected operation or stopping may impact health, or may affect animals and plants.)

■ Check the following points before operation and while in operation from an outdoor location

- If you know someone is in the room with the air conditioner installed, notify the person beforehand that you will operate the air conditioner from a position where you cannot see it.
(If the person is on a step, he/she may be surprised and fall by sudden operation or stopping. Also, an abrupt change in outdoor and indoor temperatures may impact health.)
 - Temperature control and operation stopping can also be performed using the indoor remote control.
 - Do not use the air conditioner when there are only people in the room who cannot control the temperature by themselves such as the disabled, the elderly, and infants.
- Frequently check the settings and state of operation.
(An abrupt change in indoor and outdoor temperatures may impact health or may affect animals and plants.)
 - If the communication state is poor due to radio wave interference caused by an obstacle or microwave oven, the operation content may not be reflected.
- If an issue occurs in the air conditioner, stop operation immediately and consult the sales outlet for the product. Confirm again that the operation is stopped on the operation screen.

Note on Wireless Communication (Radio Wave)

Wireless LAN and Radio Act

- This wireless LAN interface has construction design certification. Therefore, application for the license is not necessary.
- This product is certified to meet the technical standard as a wireless facility of a specified low-power radio station based on the Radio Act. Therefore, a radio station license is not necessary when using this product.
- Wireless LAN may be subject to wiretapping or malicious access because it transmits and receives data using radio waves. Before using wireless LAN, thoroughly understand the risk. In addition, manage the SSID and KEY of the wireless LAN interface and wireless LAN router and also the log-in ID and password for operation away from home so as to prevent them from being known by other people. In the event that the product is operated away from home by malicious access, turn OFF the function of the wireless LAN interface.
- This product cannot be connected directly to communication lines provided by telecommunication carriers. When connecting this product to the Internet, be sure to connect it to the Internet via a router.
- If a barrier that barely transmits a radio wave (such as metal and reinforced concrete) exists between this product and a wireless LAN router, the product may not operate because it may receive radio wave noises or the radio wave reaching distance may be shortened.
- Radio waves transmitted from this product have extremely little impact on medical electrical devices. However, keep a distance of 20cm or more from such a device (pacemaker-installed part, etc.) for safe management when using the product.
- Use of this product near a device emitting electric waves such as a microwave oven and cordless phone may affect communication via wireless LAN. If the product fails to communicate properly, or if a cordless phone fails to send/receive a call properly, be sure to use the product and the phone at least 1 meter away from each other.
- If you have any other problems, consult the sales outlet for the product.

Names of Parts

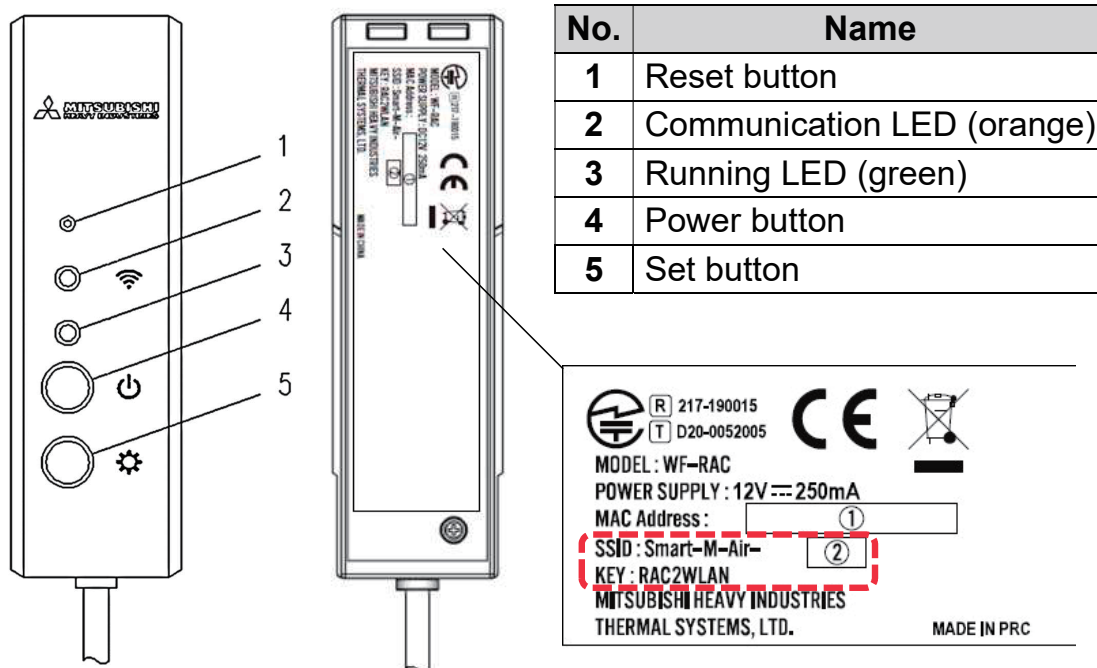

Operations of buttons

Button	Pressing duration	Operation state
Reset button * Press this button by using something with a fine tip, such as the tip of a pen.	Less than 3 seconds	Reset (restart)
	3 seconds or more	Restores information in wireless LAN interface to factory-default information (initialisation).
Power button	2 seconds or more	Switch between ON and OFF of the power
Set button	Less than 2 seconds	Sets WPS function (simple setting function) to valid.
	2 seconds or more	Sets AP function to valid.

LED display

Description of operation	Communication LED (orange)	Running LED (green)
Connecting with WPS function.	Connecting: OFF After connected: ON for 2 seconds	Flashing every second
Connecting in AP	Connecting: OFF After connected: ON for 2 seconds	Flashes: ON for 2 seconds and OFF for 0.5 seconds.
After starting communication with the application or server	Flashes every 0.1 seconds each time transmitting/receiving data.	ON
The power is OFF and "LED ON" of the application is OFF	OFF	
During reset (restart)	Turns ON for 10 seconds.	
At initialization	Flashing 10 times for 10 seconds.	
Not connected to indoor unit*	The Communication LED and Running LED flash 3 times alternately for 10 seconds.	
Interface in abnormal state*	The Communication LED and Running LED flash 4 times alternately for 10 seconds.	

* For details, refer to FAQ in menu of the application.

Specifications

Power source	DC12V supplied from air conditioner
Power consumption	Max. 3W
Outside dimension	110mm (height) x 33mm (width) x 16.5mm (depth)
Mass (main unit)	About 80g
Material	Casing: ABS + PC
Operation guarantee environment	Temperature 0 - 40°C, humidity 75% or less
Part name	Wireless LAN interface
Model name	WF-RAC
Cable length	1.3m
Wireless communication method	IEEE 802.11b/g/n 2.4GHz band
Compatible standards	2014/53/EU

* For supported models, refer to air conditioner catalogs, etc. for confirmation.

System configuration (for remote control)

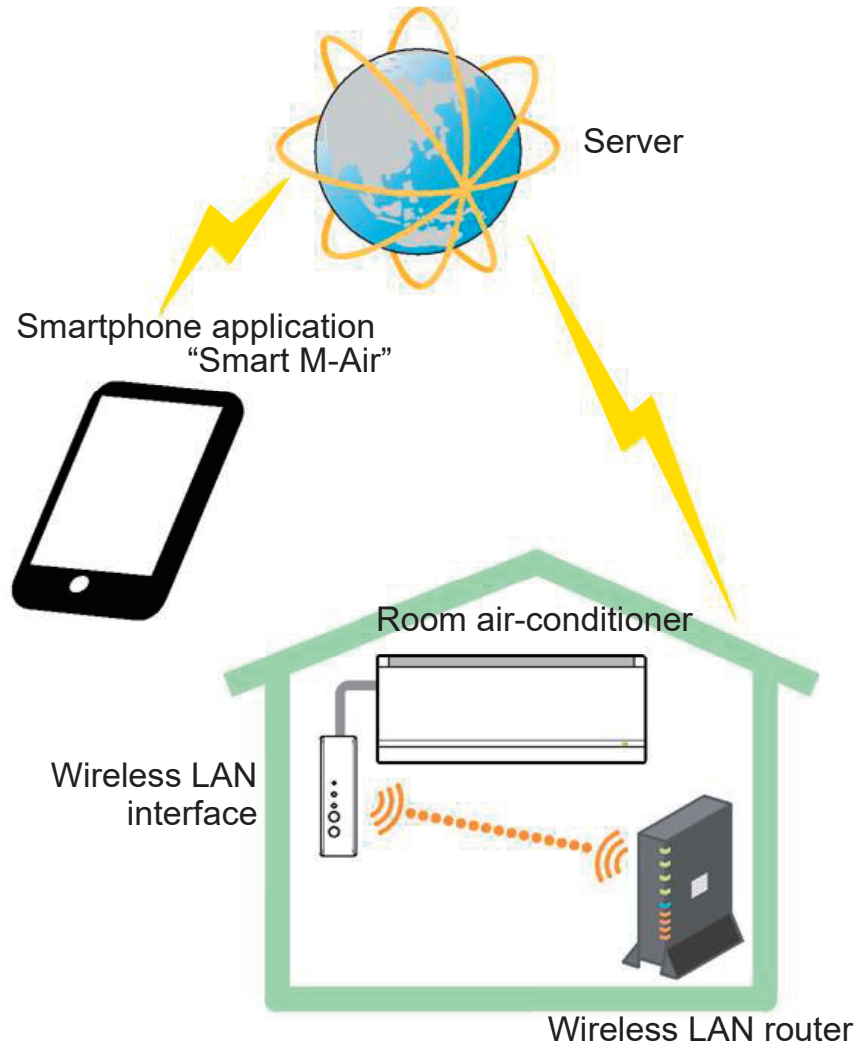

Connecting to Network via Wireless LAN

The following procedure may partly differ depending on the model to be connected. For the latest User's Manual, refer to the home page of our air conditioner products.

Preparation before connection

Check beforehand.

Prepare the following items.

- Smartphone (tablet PC)
 - Supported OS Android™ 8 to 10
 - iPhone 12 to 14
- Internet line and communication equipment (modem, router, ONU, etc.)
- Router (wireless LAN access point)

Connect the smartphone (tablet PC) to the router via Wi-Fi.

Open “Wi-Fi” on the Settings screen of the smartphone, and select SSID of the router to be used. Then, establish the connection by entering the password of the router.

1. Install the application.

How to install “Smart M-Air”

How to install the “Smart M-Air” smartphone application	
For Android 1. Open [Google Play]. 2. Search for [Smart M-Air]. 3. Install the application according to the instructions on the screen.	For iOS (iPhone) 1. Open [App Store]. 2. Search for [Smart M-Air]. 3. Install the application according to the instructions on the screen.
Application Operation Manual Refer to the home page of MITSUBISHI HEAVY INDUSTRIES THERMAL SYSTEMS, LTD. http://www.mhi-mth.co.jp/en/products/detail/air-conditioner_users_manual.html	



- The application is free. Communication charges are applied to download and operate.
- The application name “Smart M-Air” and download service names “Google Play” and “App Store” may be changed in the future.
- For the settings, contents, and latest supported OS of the application, refer to our home page or the User's Manual on our home page.

2. Confirm that the router to be used is equipped with the WPS function (simple setting function).

WPS: Use when you connect to the router only by operating buttons.

AP: Use when you connect to the router by entering and setting SSID and KEY (password).

3. Connect the air conditioner to the network.

Please display the Air Conditioner List screen according to the Smart M-Air Operation Manual.

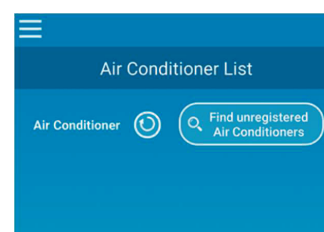

Wireless LAN router equipped with WPS function (simple setting function)

- (1) Press the Power button for 2 seconds or more on the wireless LAN interface. The power is switched from OFF to ON, and the Running LED stays ON.
- (2) Press the Set button for less than 2 seconds to enter WPS mode. Confirm that the Running LED flashes (every second).
 - Perform the following setting within 2 minutes. If 2 minutes has passed, perform the procedure again from (1).
 - * The WPS and AP modes cannot be switched. Therefore, if you fail to set the mode, wait for 2 minutes (5 minutes in AP mode) before performing the setting again.
- (3) Press the WPS button on the router*. The buttons generally look like this .
 - The operation method of the WPS button differs depending on the router. For details, refer to the manual provided with the router.
 - * If an automatic connection function other than the WPS function is used, operate the automatic connection button by referring to the manual provided with the router.

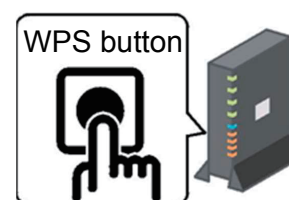

- (4) When the connection is complete, the Communication LED lights up for 2 seconds. Start the application and tap the “Find unregistered air conditioners” button on the air conditioner list screen.
- Confirm that an icon of the unregistered air conditioner is added. If it is not displayed, confirm again that steps (1) to (3) have been performed properly.
 - If it is not connected, wait at least two minutes and wait until the green LED lights up all the time, try again from (2).
 - Confirm that the last 4 digits of the SSID labelled on the wireless LAN interface is displayed as the name of the air conditioner.

Last 4 digits of the SSID



Wireless LAN router NOT equipped with WPS function

- If the wireless LAN router is not equipped with the WPS function, use the procedure below to connect the wireless LAN router interface.
- (1) Press the Power button for 2 seconds or more on the wireless LAN interface. The power is switched from OFF to ON, and the Running LED stays ON.
 - (2) Press the Set button for 2 seconds or more to enter AP mode. Confirm that the Running LED flashes (ON for 2 seconds and then OFF for 0.5 second).
 - Perform the above within 5 minutes. If 5 minutes has passed, perform the procedure again from (1).
 - * The WPS and AP modes cannot be switched. Therefore, if you fail to set the mode, wait for 2 minutes (5 minutes in AP mode) before performing the setting again.
 - (3) Connect the smartphone to the wireless LAN interface. Open the Wi-Fi setting of the smartphone. Select the SSID labelled on the wireless LAN interface, and enter the KEY (password) indicated on the label.

- (4) Start the application and tap the “Find unregistered air conditioners” button on the air conditioner list screen.
- Confirm that an icon of the unregistered air conditioner is added.
 - Confirm that the last four digits of the SSID labelled on the wireless LAN interface is displayed as the name of the air conditioner.



- (5) Select the wireless LAN router to which the smartphone is connected on the wireless LAN setting screen of the application.
- If the wireless LAN router is not displayed on the list, enter the SSID and KEY (password) of the wireless LAN router directly.
- (6) When the connection is complete, the Communication LED lights up for 2 seconds. The connection between the wireless LAN interface and the wireless LAN router is established.
Confirm that the air conditioner is added on the list screen. If it is not displayed, confirm again that steps 1 to 5 have been performed properly.
- * If you fail to connect even after confirming the screen again, the number of devices connected with the wireless LAN router may have reached its upper limit, or the router may not be operating or may have failed. Therefore, check the wireless LAN router according to the user’s manual of the router.
 - * If the Internet line is disconnected, contact your Internet provider for confirmation.
 - * If the interface cannot be connected to the application even by following the setting procedure in this manual, refer to FAQ in the menu of the application.

4. Start the application and operate the air conditioner at home (away from home).

- Setting is complete if the connected air conditioner is displayed on the equipment list screen. If it is not displayed, update the screen by tapping the “Find unregistered air conditioners” button on the “Air Conditioner List” screen.
- To operate the connected air conditioner away from home, open the “Application Settings” screen on the main menu, and switch to the “Remote operation mode” on the “Switch Operation Modes” screen. A log-in ID and password must be set. **The setting operation can be performed only at home.**

Login ID : _____

Password : _____

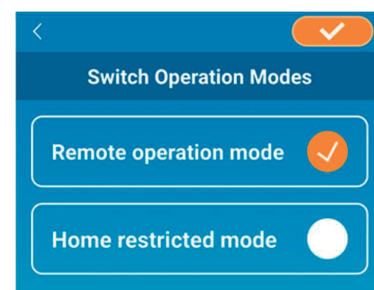
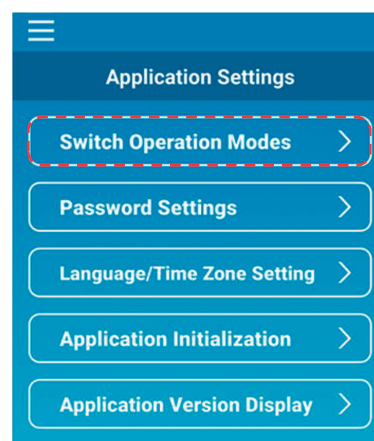

- * Note that if the mode is switched to the home dedicated operation mode, the account information used in the “Remote operation mode” is deleted.
- * While the air conditioner is used in the “Remote operation mode”, it may temporarily stop due to the maintenance of the server.
- * If you fail to confirm the air conditioner status or operate the air conditioner by using the smartphone, the communication line of the smartphone may be disconnected. In such a case, confirm the connection status according to the user’s manual of the smartphone.
- * If the application is operating slowly, stop the other applications.
- * Always keep the application up to date.

In case:

- Turning OFF the wireless LAN interface function
 - Press the Power button for 2 seconds or more, and the Running LED and Communication LED turn OFF.
- It is not behaving as it should
 - Press the Reset button for less than 3 seconds, and the Running LED and Communication LED turn ON for 10 seconds, and then Reset.
- Initializing wireless LAN interface
 - Press the Reset button for 3 seconds or more, and the Running LED and Communication LED flash 10 times for 10 seconds, then it is initialized. If the interface is reset, it is needed to set a login ID and password again.
- Moving or disposing of the air conditioner, necessary changing of the user
 - Be sure to reset the wireless LAN interface (by pressing the Reset button for 3 seconds or more).
- Disposing of this product
 - Follow the ordinances established by your local government.
- Cleaning the product, unplug the air conditioner and wipe with a soft dry cloth. If the product is dirty, wipe with a cloth that is moistened with lukewarm water and wrung sufficiently. When using a chemical dustcloth, follow its precautions.
- Turning ON the LED
Switch to the Home restricted mode in the application and tap the LED ON.

“iPhone” is a trademark of Apple Inc. registered in the U.S. and other countries.

App Store is a service mark of Apple Inc.

“Android™” and “Google Play” are trademarks or registered trademarks of Google LLC.

“Wi-Fi Protected Setup™” is a trademark or registered trademark of Wi-Fi Alliance.

Other company names and product names that appear in this manual are trademarks or registered trademarks of their respective companies.

mitsubishi Heavy Industries Thermal Systems, Ltd.

2-3, Marunouchi 3-chome, Chiyoda-ku, Tokyo, 100-8332, Japan
<http://www.mhi-mth.co.jp/en/>

Mitsubishi Heavy Industries Air-Conditioning Europe, Ltd.

5 The Square, Stockley Park, Uxbridge, Middlesex, UB11 1ET, United Kingdom
Tel : +44-333-207-4072
Fax: +44-333-207-4089
<http://www.mhiae.com/>

MHIAE SERVICES B.V.

(Wholly-owned subsidiary of MITSUBISHI HEAVY INDUSTRIES AIR-CONDITIONING EUROPE, LTD.)

Herikerbergweg 238, Luna ArenA, 1101 CM Amsterdam, Netherlands
P.O.Box 23393 1100 DW Amsterdam, Netherlands
Tel : +31-20-406-4535
<http://www.mhiaeservices.com/>

Mitsubishi Heavy Industries Air-Conditioners Australia, Pty. Ltd.

Block E, 391 Park Road, Regents Park, NSW, 2143 PO BOX 3167, Regents Park, NSW, 2143
Tel : +61-2-8774-7500
Fax: +61-2-8774-7501
<https://www.mhiala.com.au>

9. APPLICATION OPERATION MANUAL

Smart M-Air

Operation Manual

Table of contents

1. Application Features	37
2. Manipulation modes	38
Remote operation mode	38
Home restricted mode	38
Demo mode	38
3. Preparation for Use	39
Smartphone setting	39
Application initial setting	39
Creating user account	41
Registering air conditioner	44
Wireless LAN settings of air conditioner	45
Naming air conditioner	47
4. Basic Usage	49
Starting / Stopping air conditioner operation	49
Switching operation mode	49
Changing temperature	50
Changing fan speed and airflow direction	51
5. Using Favourites	52
6. Using Options	54
Shut-off reminder alert	55
Air-conditioner error notification	56
Hi temp / low temp alert	57
Watching function	58
Home leave mode	58
Cooling specific	59
LED ON	59
Number of smartphones	59
7. Setting Weekly Timer	60

8. Setting Timer by Specifying Date via Calendar	62
Clear the timer set from the calendar	63
9. Displaying Electricity Bill Graph	65
10. Updating Firmware	66
11. Main Menu	68
Canceling demo mode	69
12. Checking Alerts	70
13. Changing Application Settings	72
Switch Operation Modes	73
Switching to “Remote operation mode”	73
Switching to “Home restricted mode”	74
Reset Password	76
Language/Time Zone Settings	78
Application Initialization	79
Application Version Display	81
14. Troubleshooting	82
When the air conditioner that you want to register does not appear in the air conditioner list screen	82
How to delete a registered air conditioner	82
When an abnormality notification appears in the air conditioner list	83
When you forget your password and cannot log in	84

1. Application Features

You can operate the air conditioner in each room at home or from outside.

- Setting operation reservation of every day of the week for each air conditioner
- Checking the power consumption of an air conditioner
- Setting the shut-off reminder alert
- Alerting if an air conditioner is abnormal

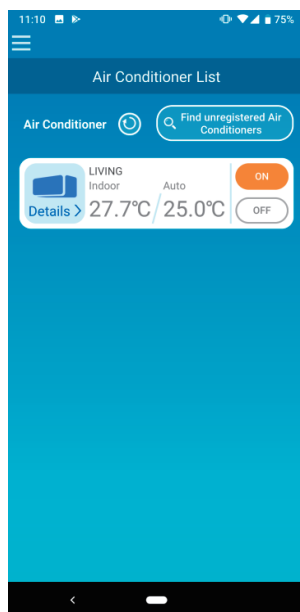

Figure 1-1



Figure 1-2

Note

Depending on the function of the connected air conditioner, the following operation will not be reflected in the operation of the air conditioner.

- Left/Right, 3D AUTO, Home leave mode, Electricity Bill Graph

When the wireless LAN interface is connected, the timer setting is disabled on your home remote control depending on your air conditioner.

Please use the timer function of the application to set the timer.

2. Manipulation modes

- Remote operation mode

This mode allows you to operate the registered air conditioner via the smartphone application when you are out of the office.

Also, you can register and operate the air conditioner at home through a smartphone application.

- Home restricted mode

This mode allows you to register and operate the air conditioner at home via the smartphone application.

You can operate without data communication to the server.

Operation is not available when you are out.

- Demo mode

If you don't have an air conditioner compatible with a smartphone app, This mode allows you to experience the operation feel of remote operation mode.

3. Preparation for Use

- Smartphone setting

Turn on Wi-Fi of your smartphone.



Figure 3-1

- Application initial setting

Tap the Smart M-Air icon.

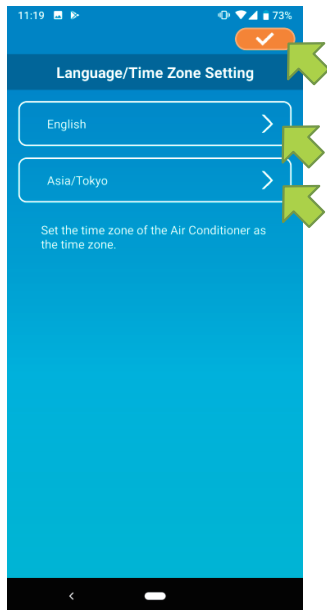

Figure 3-2



The application starts.

Figure 3-3



After startup, the “Language/Time Zone Settings” screen appears.

Select a language to use in the application.

Select a time zone. Select the time zone in which the air conditioner to operate via the application exists.

Finally, tap  on the top right to complete the setting.

Figure 3-4

The “Terms of Service” screen appears.

Read the text to the bottom and check the description.

If you agree it and use the application, tap [Agree].

When you tap [I don't agree], the application exits.

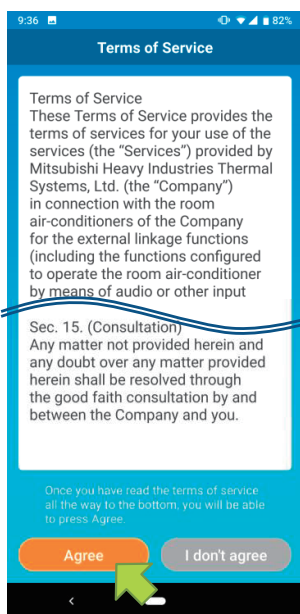

Android

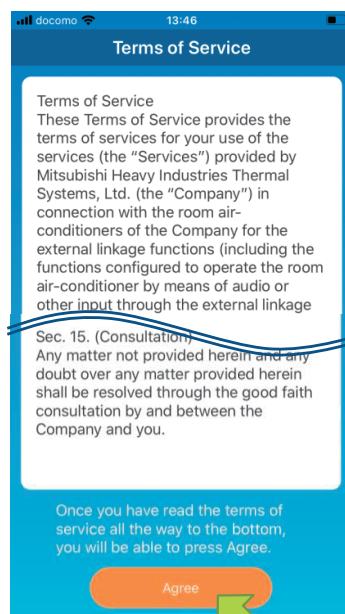

iOS

Figure 3-5

On the startup screen, select a mode to use.

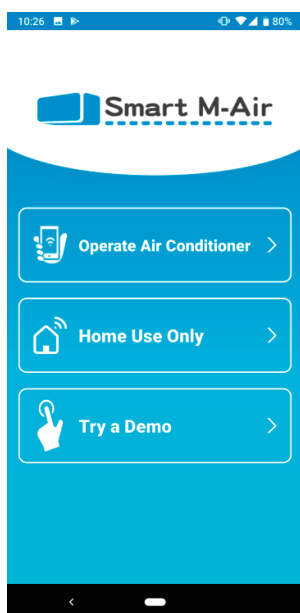

Figure 3-6

■ Operate Air Conditioner (Remote operation mode)

Tap " Operate Air Conditioner " for remote control or to use optional functions such as weekly timer.

→ To ["Creating user account"](#)

■ Home Use Only (Home restricted mode)

Tap " Home Use Only " to operate only at home. Some functions are restricted, but you can change to remote operation mode at any time.

→ To ["Registering air conditioner"](#)

Switching operation mode

→ To ["Changing Application Settings"](#)

■ Try a Demo (Demo Mode)

Tap " Try a Demo " to try out the app's features. (Some features only)

→ To ["4. Basic Usage"](#)

• Creating user account

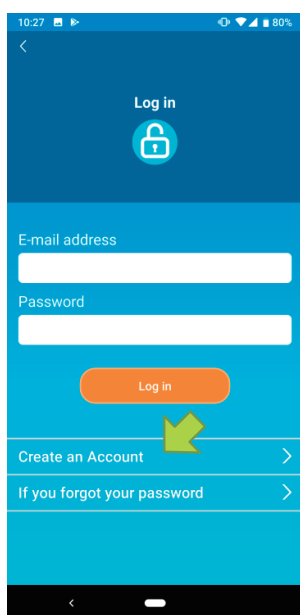

Figure 3-7

Tap [Create an Account].

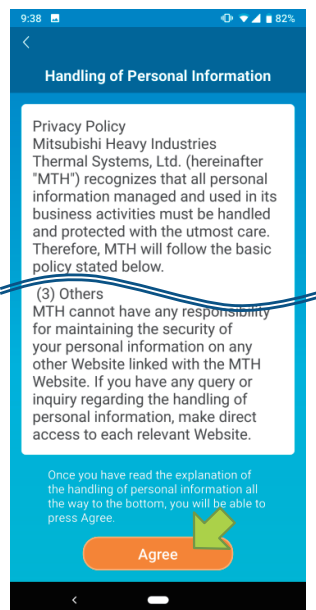

Figure 3-8

Read the text of Handling of Personal Information to the bottom and check the description.

If you agree it and use the application, tap [Agree].

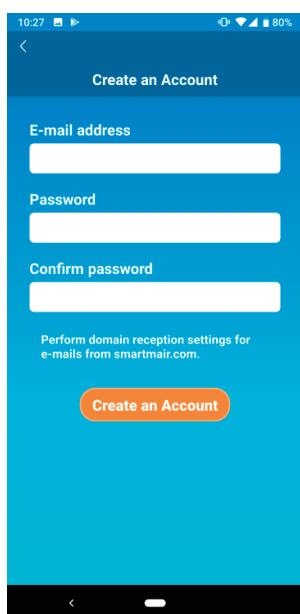

Figure 3-9

The “Create an Account” screen appears. Enter your e-mail address and password and tap the [Create an Account] button.

Note

- A password must be between 8 to 16 characters including at least one alphabetic character and one numeric character.

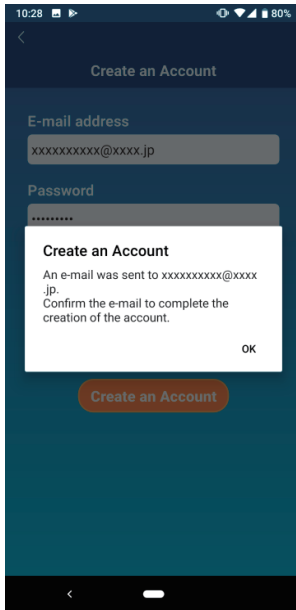

Figure 3-10

When the pop-up message “Create an Account” appears, tap [OK].

The email containing the URL of the authentication screen will be sent to the email address you entered, so please click the URL within 24 hours to complete the account creation.

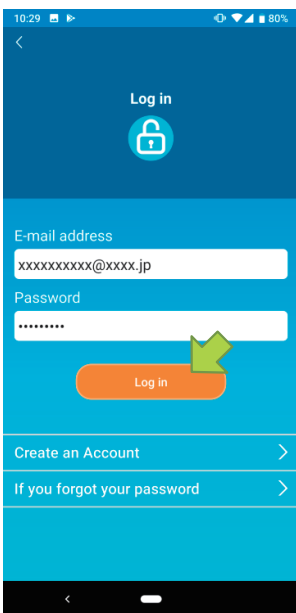

Figure 3-11

After the account is created, the “Log in” Screen appears on the application.

Click the URL written in the e-mail, enter the registered e-mail address and password, and tap the [Log in] button.

If you forget your password and cannot log in, tap " If you forgot your password " and set a new password.

→ To [“Reset Password”](#)

• Registering air conditioner

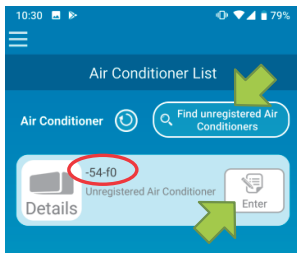

Figure 3-12

Use the “Air Conditioner List” screen to register an air conditioner to operate.

Tap the "Find unregistered Air Conditioners" button to display air conditioners that are not registered on your smartphone.

The air conditioner name (-54-f0 locations) displays the last 6 digits of the SSID on the label of the wireless LAN interface.

Tap the [Enter] button.

- When the air conditioner is not displayed on the list screen
→ To [“When the air conditioner that you want to register does not appear in the air conditioner list screen”](#)
- To delete a registered air conditioner
→ To [“How to delete a registered air conditioner”](#)

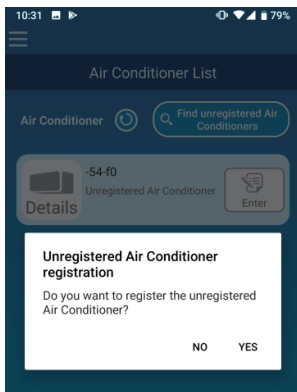

Figure 3-13

To register the air conditioner, tap [YES] on the pop-up message displayed.

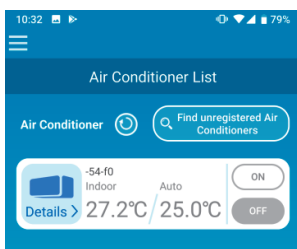

Figure 3-14

- Wireless LAN settings of air conditioner

If your wireless LAN router does not support WPS, manually make wireless LAN settings of your air conditioner.

Set the wireless LAN interface to the AP mode, and then change the Wi-Fi connection destination of your smartphone to “Smart-M-Air-XXXX”.

“XXXX” is the last 4 alphanumeric characters of the MAC address of the wireless LAN interface.

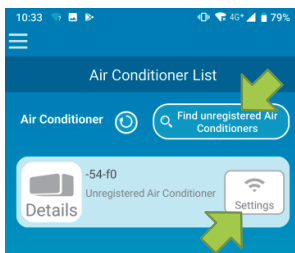

On the “Air Conditioner List” screen, tap the [Find unregistered Air Conditioners] button. The target air conditioner appears.

Tap the [Settings] button.

Figure 3-15

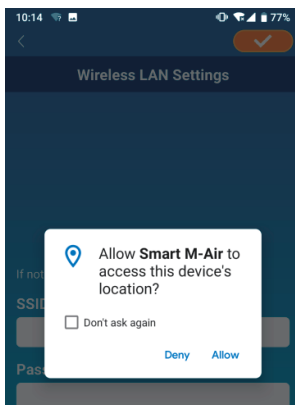

If you are prompted to permit access to location information, tap [Allow].

Figure 3-16

When you tap the network you want to set from the displayed list, the SSID appears in the "SSID" entry field at the bottom of the screen, enter "Your home Wi-Fi password" below it, and tap  in the upper right.

If the network you want to set is not displayed in the list, enter "SSID" and "Your home Wi-Fi password" directly, then tap  on the upper right to set.

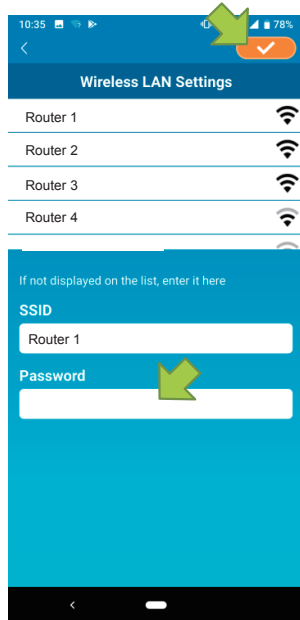

Andoroid

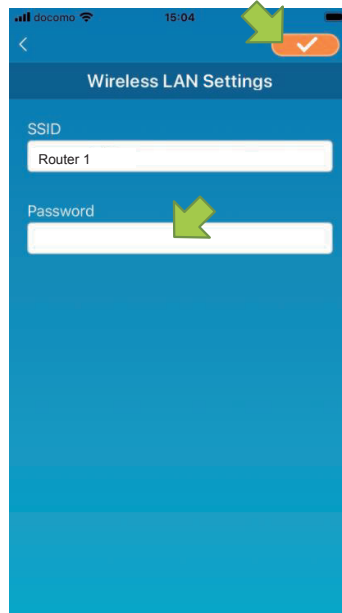

iOS

Figure 3-17

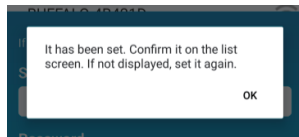

Figure 3-18

After the wireless LAN settings is completed, The air conditioner is registered.

- Naming air conditioner

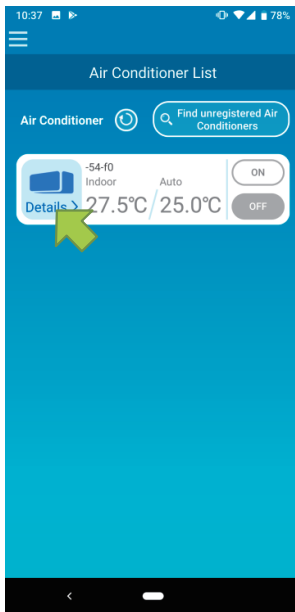

Figure 3-19

If you want to change the name of the air conditioner displayed in the application such as the air conditioner list screen, tap "Details" to display the detailed screen of the air conditioner.

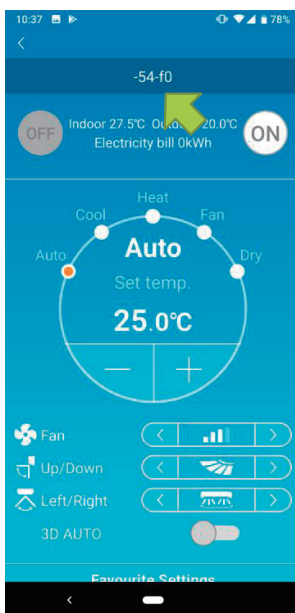

Figure 3-20

Press and hold down (1 sec) an air conditioner name. The "Edit Air Conditioner name" dialog appears. Use this to change the name.

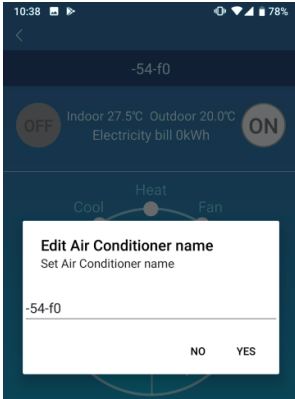

Figure 3-21

Enter a new air conditioner name and tap [YES].

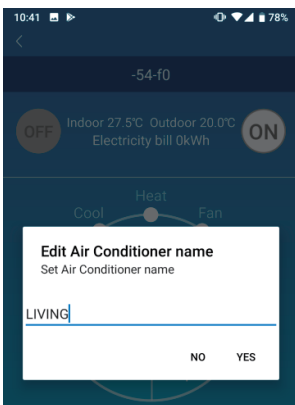

Figure 3-22

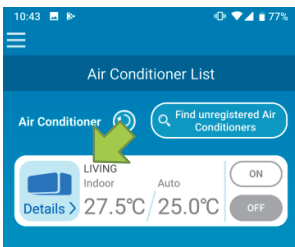

Figure 3-23

4. Basic Usage

- Starting / Stopping air conditioner operation

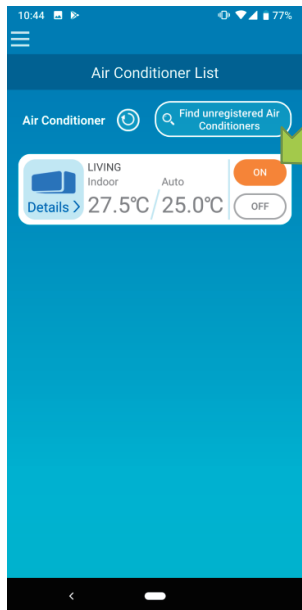

Figure 4-1

To start or stop the operation, tap the [ON] / [OFF] button of the air conditioner that you want to operate on the “Air Conditioner List” screen.

When the button color changes, switching is complete. (Grayed out when off)

To update to the latest information, tap .

Note

- When operating an air conditioner from an external location, it may take up to one minute to complete the air conditioner operation.

- Switching operation mode

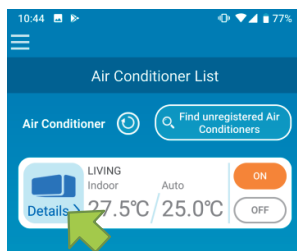
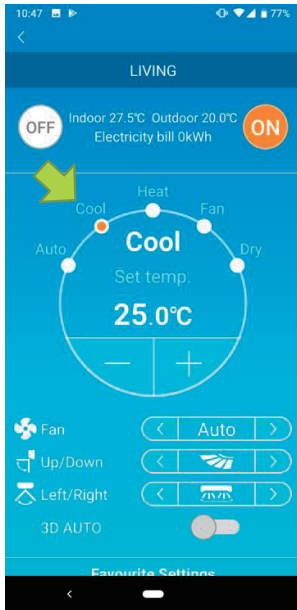

Figure 4-2

Tap an air conditioner that you want to switch the operation mode on the “Air Conditioner List” screen.



To change the “Operation mode”, tap each mode from “Auto” to “Dry”.

Figure 4-3

- Changing temperature





To set a desired temperature, tap  /  . The current set temperature appears in the circle.

Figure 4-4



When the operation mode is Fan, Set temp. shows "-".

Figure 4-5

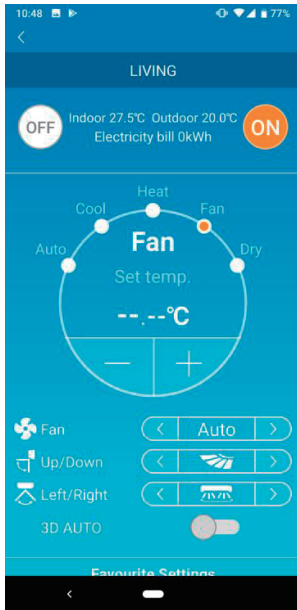
- Changing fan speed and air flow direction



Tap < / > to change settings.

Figure 4-6

5. Using Favourites



Figure 5-1

Register your desired settings of “Set temp”, “Operation mode”, “Fan”, “Up / Down” and “Left / Right” with Favourite. Tapping the [Favourite] button changes the current settings to the registered settings.

On the air conditioner details screen, press and hold down (1 sec) the [Favourite 1] or [Favourite 2] button. The “Favourite” screen appears.



Figure 5-2

Change each item to your favourite setting, and tap  on the upper right to add it to Favourites.

Press  in the upper left of the screen to return to the operation screen.



When you tap the [Favourite 1] or [Favourite 2] button, the current settings are changed to the favourite settings you tapped.

Figure 5-3

6. Using Options

You can make various option settings such as alerts and LED lighting, and check the number of accounts registered with an air conditioner.

Home restricted mode : Only “Home leave mode”, “Cooling specific”, and “LED ON” are operable.

Demo mode : Options are not operable.

You can switch to remote operation mode using "Changing Application Settings" in the main menu.

→ To [“Changing Application Settings”](#)

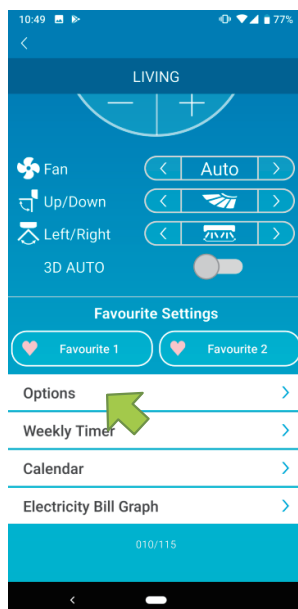

Tap [Options] on the lower part of the air conditioner details screen. The “Options” screen appears.

Figure 6-1

Only "LED ON" is ON by default.

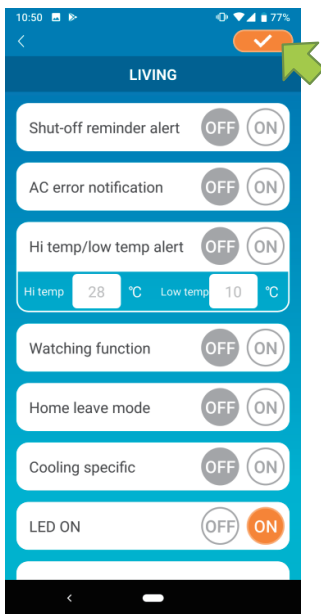

Switch between [ON] and [OFF], and tap  on the top right of the screen to save the settings you changed.

Note

- Shut-off reminder alert, AC error notification, Hi temp / low temp alert, Watching function, Home leave mode can be used with "Remote operation mode".

Figure 6-2

• Shut-off reminder alert

If you are more than 1 km away from the air conditioner you are driving, you can receive a push notification to the smartphone application.

- To receive alerts, tap [ON].

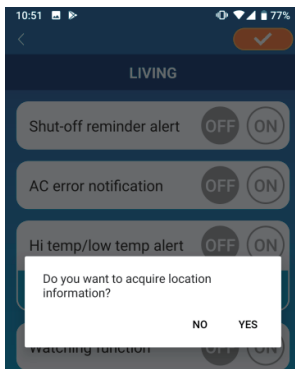

When the pop-up message "Do you want to acquire location information?" appears, tap [YES] and then tap  on the top right.

Figure 6-3

- To not to receive alerts, tap [OFF].

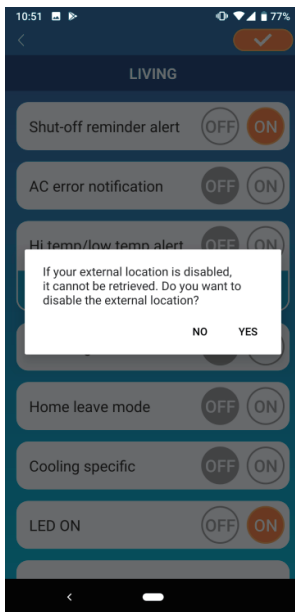

When the pop-up message “If your external location is disabled, it cannot be retrieved. Do you want to disable the external location?” appears, tap [YES] and then tap  on the top right.

Figure 6-4



Note

- Acquisition of location information is performed by using the location of your smartphone as the location of the air conditioner. Perform location information acquisition near your air conditioner.

- AC error notification (Air conditioner error notification)

If any abnormality is detected in your air conditioner, an e-mail is sent to the registered e-mail address.

→ To “[When an abnormality notification appears in the air-conditioner list](#)”

- To receive notifications, tap [ON] and then tap  on the top right.
- To not to receive notifications, tap [OFF] and then tap  on the top right.

- Hi temp / low temp alert

When your smartphone reaches the specified high/low temperature condition, a push notification is sent to the smartphone application.

- To receive alerts, tap [ON] and enter the high and low temperatures and then tap  on the top right.

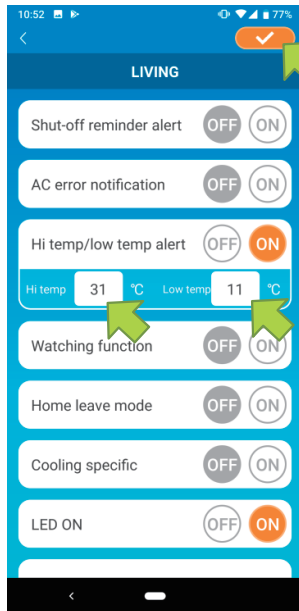

Note

- When the room temperature is higher / lower than the temperature specified here, alerts are sent. If you set the high temperature at 31°C, an alert is sent when the room temperature exceeds 31°C. No alert is sent at 31°C.
- Setting only either of high or low temperature receives alerts only for high or low temperature.

Figure 6-5



- To not to receive alerts, tap [OFF] and then tap  on the top right.

• Watching function

When the air conditioner is controlled other than your smartphone, an e-mail is sent to the registered e-mail address.

Note

- The notification also applies to the operation with the timer of the air conditioner itself and the end of internal clean operation.

- To receive alerts, tap [ON] and then tap  on the top right.
- To not to receive alerts, tap [OFF] and then tap  on the top right.

• Home leave mode

When the room temperature is lower than a certain temperature, heating is turned on automatically.

When the room temperature is higher than a certain temperature, cooling is turned on automatically.

- To use “Home leave mode”, tap [ON].

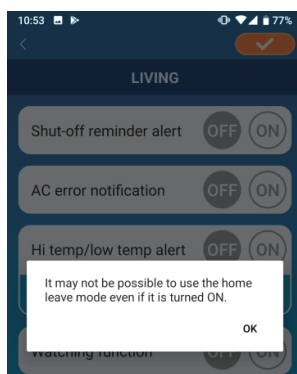



Figure 6-6

When the pop-up message “It may not be Possible to use the Home leave mode even if it is turned ON.” appears, tap [OK] and then tap  on the top right.

Note

- There is no "Home leave mode" depending on the air conditioner connected. In this case, "ON" has no effect.

- To not to use “Home leave mode”, tap [OFF] and then tap  on the top right.

- Cooling specific

If you set it as an air conditioner for cooling only, you won't be able to use the heating in the smartphone application.

- To use “Cooling specific”, tap [ON] and then tap on  the top right.

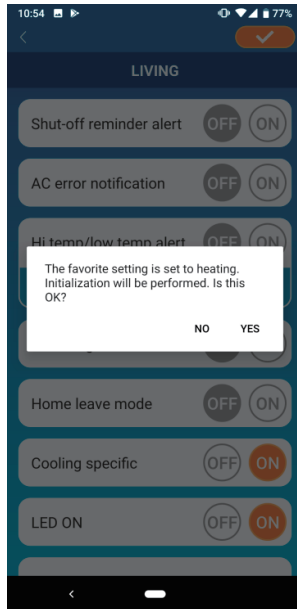

- When “ON” is set or “Heat” is set to favourites, the pop-up message asking whether to initialize favourites appears.



If you tap [YES] on the pop-up message, the “Cooling specific” setting is turned “ON” to initialize the favourite with heating set.

Figure 6-7

- To not to use “Cooling specific”, tap [OFF] and then tap  on the top right.

- LED ON

Lights up the LED of the wireless LAN interface.

- To use LED lighting, tap [ON] and then tap  on the top right.
- To not to use LED lighting, tap [OFF] and then tap  on the top right.

- Number of smartphones

Displays the number of smartphones registered with the air conditioner.

7. Setting Weekly Timer

Makes the timer setting for every day of the week.

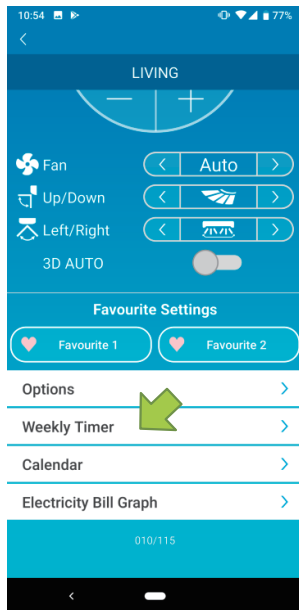

Tap [Weekly Timer] on the lower part of the air conditioner details screen.

The “Weekly Timer” screen appears.

Figure 7-1

Tap  on the top right of the screen to save the settings you changed.

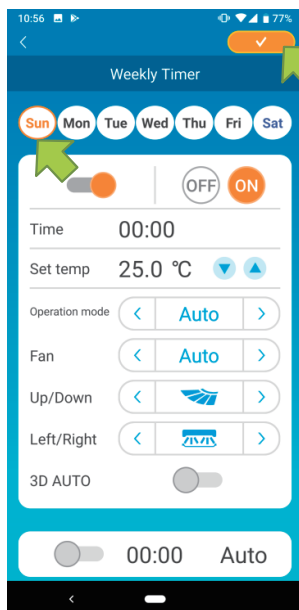

Tap the day of the week you want to set to display the timer list for that day of the week.

You can set up to six timers for each day of the week, but you cannot set the same time for the same day.

Figure 7-2

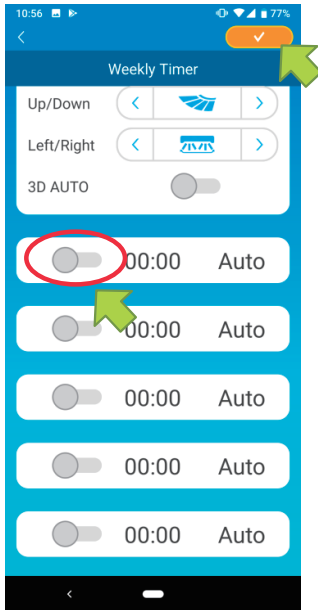

A disabled timer shows the time and operation mode only.

Tap the switch at  to enable and edit.

Edit each item and tap  on the top right to set the timer on the target day.

Figure 7-3

The timer you set here is applied to every week on that day.

To turn off the timer only on a certain day, or to apply the timer of another day, set individually from the “Calendar” screen.

8. Setting Timer by Specifying Date via Calendar

When you set the weekly timer, the same timer is applied to the same day every week. To turn off the timer or set the timer of a different day on a certain day, set individually from the “Calendar” screen.

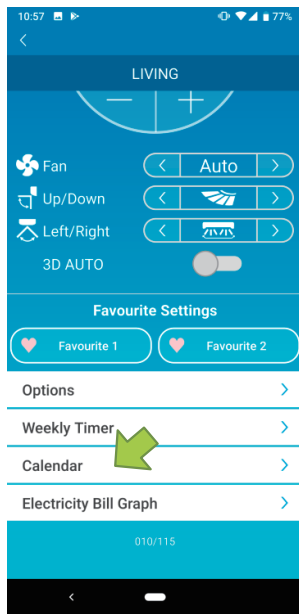

Tap [Calendar] on the lower part of the air conditioner details screen.

The [Calendar] screen appears.

Figure 8-1

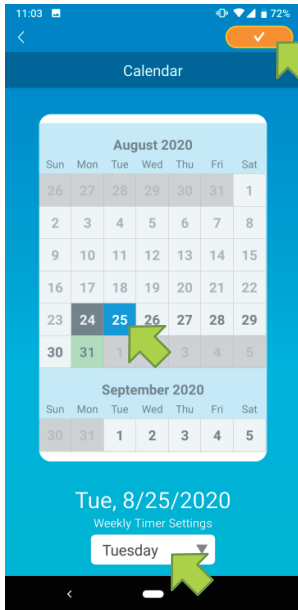



Figure 8-2

Tap the date of the calendar. Select the timer of the day of the week that you want to apply from “Weekly Timer Settings” and tap  on the top right of the screen.

If you select “OFF” from “Weekly Timer Settings”, the weekly timer is not applied.

When the timer of a different day of the week is applied or the timer is turned off, the date appears in green.

- Clear the timer set from the calendar

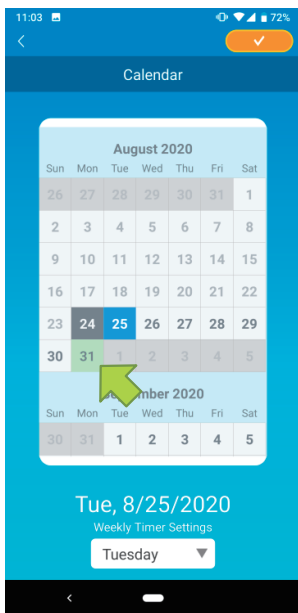
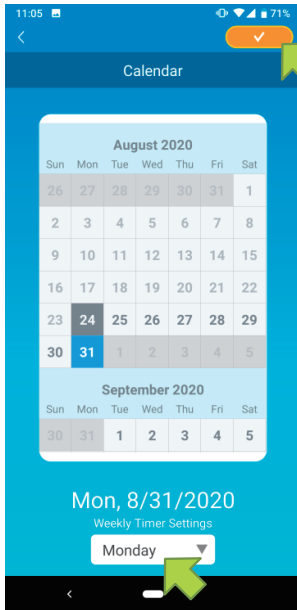

Figure 8-3

Tap the date whose timer you want to clear.



From “Weekly Timer Settings”, select the same day of the week as the date to clear and tap .

Figure 8-4



When cleared, the background of the date is displayed in white.

Figure 8-5

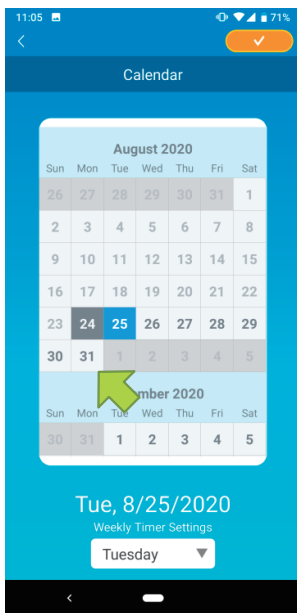
9. Displaying Electricity Bill Graph

Displays an electricity bill by month on a graph. You can also set the electricity unit cost.

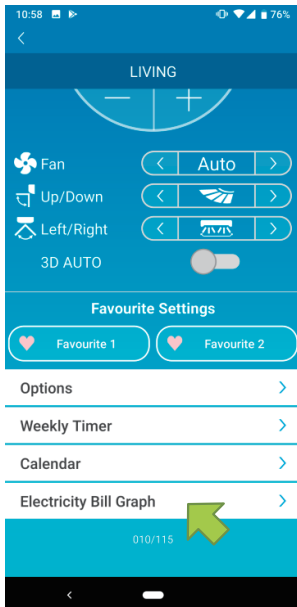

Figure 9-1

Note

Depending on the type of air conditioner you connect, the function may be disabled.

Tap [Electricity Bill Graph] on the lower part of the air conditioner details screen.

The “Electricity Bill Graph” screen appears.

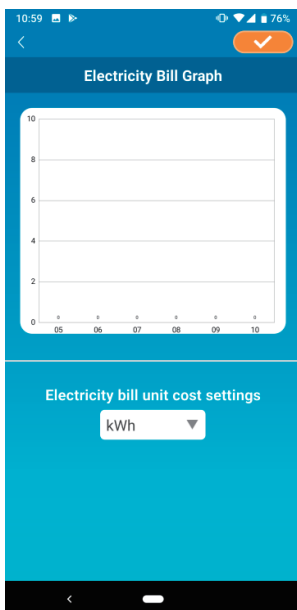

Figure 9-2

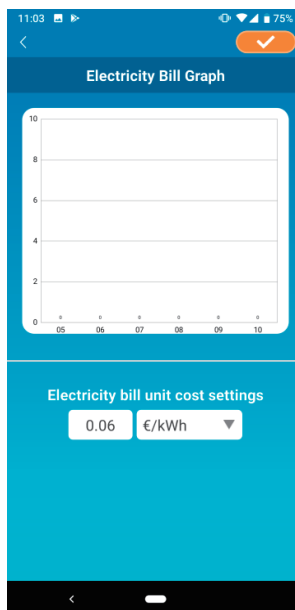



Figure 9-3

If you change the electricity bill unit cost settings, you can enter a unit price by changing the unit of measure.

After editing, tap  to save the setting.

10. Updating Firmware

If the firmware of your wireless LAN interface is not up to date, an exclamation mark **!** appears on the “Air Conditioner List” screen.

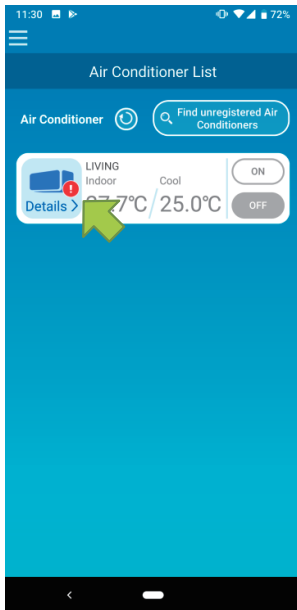

Tap [Details] to display the air conditioner details screen.

Figure 10-1

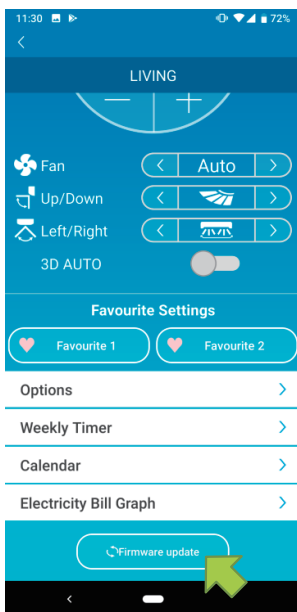

Tap the [Firmware update] button.

Note

- Perform the firmware update in the same wireless LAN area as the air conditioner.
- Please turn off the air conditioner in advance.
- If firmware update is disabled, the button is not enabled.

Figure 10-2

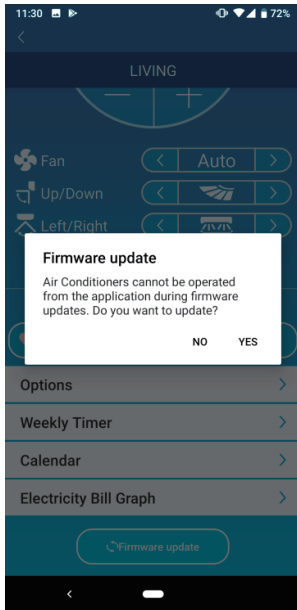

Tap [YES] to update the firmware to the latest one.

The firmware update takes 10 minutes (Max).
The operation from the application is not accepted during that period.

If after 10 minutes (Max) the "Firmware update" button appears, retry the firmware update.

Figure 10-3

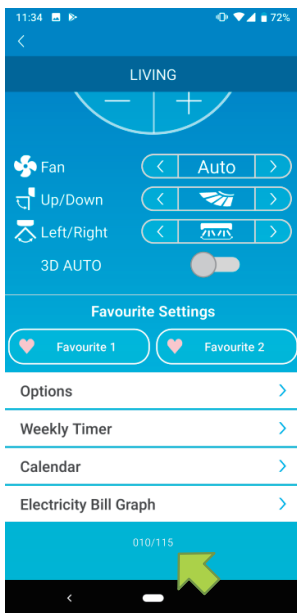

When the firmware becomes up to date, the firmware version appears instead of the [Firmware update] button.

Figure 10-4

11. Main Menu

Tap the menu button (☰) that appears on the top left in the screen such as “Air Conditioner List”, to display the main menu.

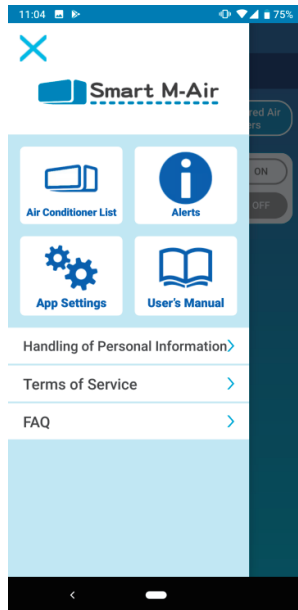
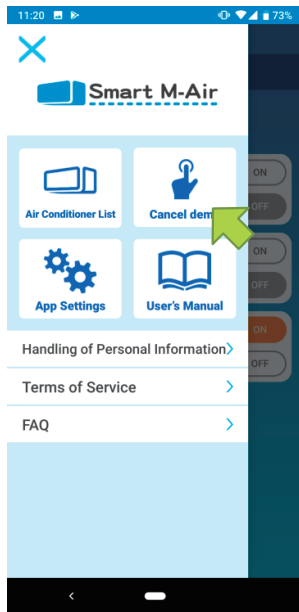

Figure 11-1

- Air Conditioner List : Operates or sets an Air conditioner.
- Alerts : Checks alerts.
- App Settings : Switches the operation mode or sets the password.
- User's Manual : Displays the user's manual.
- Handling of Personal Information : Displays the handling of personal information.
- Terms of Service : Displays the terms of service.
- FAQ : Displays the FAQ.

- Canceling demo mode



In the demo mode
Cancel demo : Exits the demo mode.

Figure 11-2

12. Checking Alerts

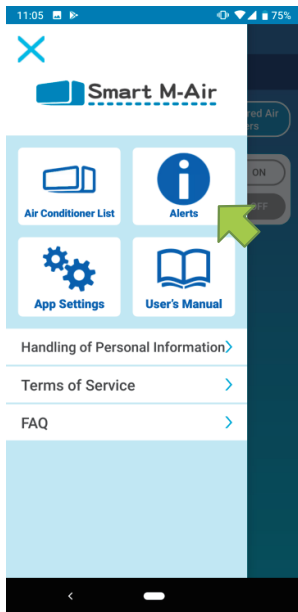

Open the main menu and tap [Alerts].

Figure 12-1

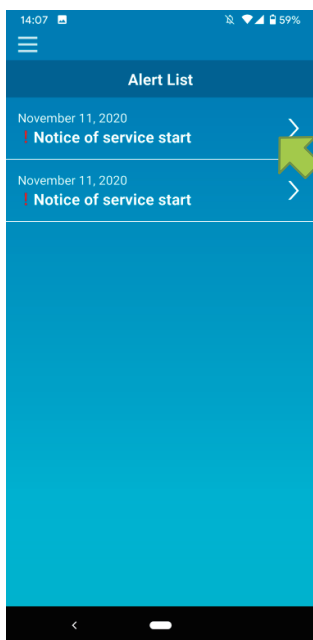

A list of alerts appears.

Tap each alert to display the alert details screen and check it.

! appears to the alert that is not checked in the alert details screen.

Figure 12-2

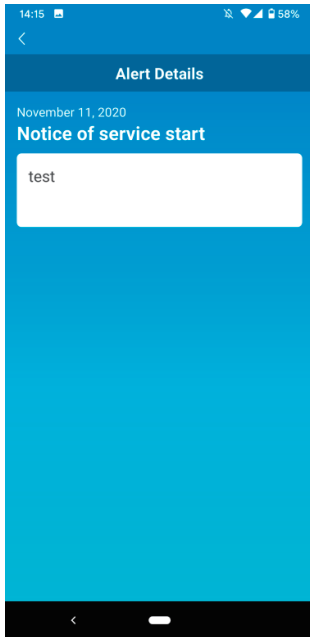

Figure 12-3

13. Changing Application Settings

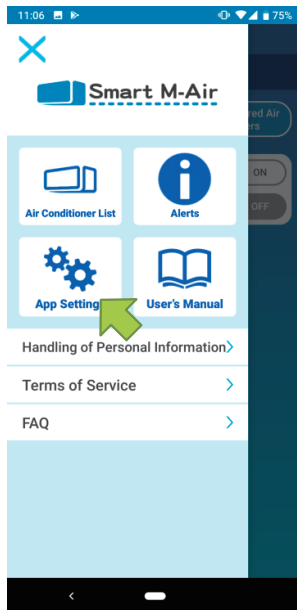

Figure 13-1

Open the main menu and tap [App Settings].

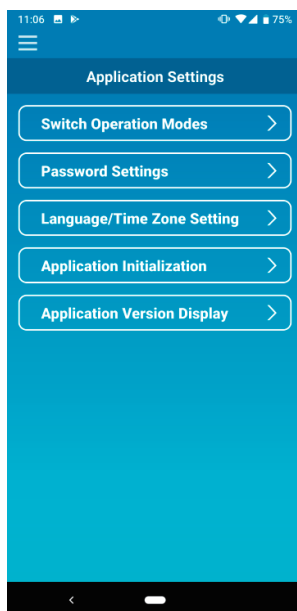

Figure 13-2

The “Application Settings” screen appears.

- Switch Operation Modes: Switches between the remote operation mode and home restricted mode.
 - To [“Switch Operation Modes”](#)
- Password Settings: Sets a password.
 - To [“Reset Password”](#)
- Language/Time Zone Settings: Sets a language to use in the smartphone application and a time zone for an air conditioner.
 - To [“Language/Time Zone Settings”](#)
- Application Initialization: Initializes the smartphone application.
 - To [“Application Initialization”](#)
- Application Version Display: Displays the version of your smartphone application.
 - To [“Application Version Display”](#)

Note

- In "Home restricted mode", you cannot operate "Password Settings". In "Try a Demo", only "Language/Time Zone Settings" and "Application Version Display" can be operated. Functions that cannot be operated are displayed in gray, and nothing is displayed even if you tap them.

• Switch Operation Modes

You can see the current operation mode.

To switch the operation mode, select the desired mode and tap  .

• Switching to “Remote operation mode”

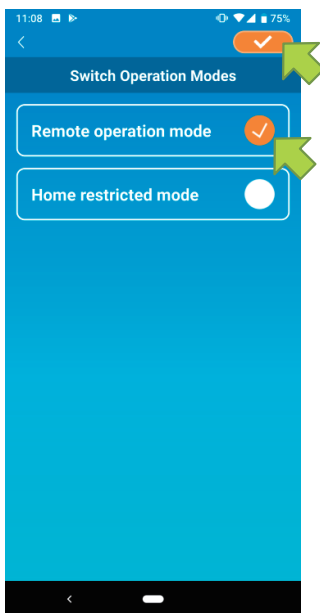

Tap [Remote operation mode] → Tap  on the top right to switch the mode.

Figure 13-3

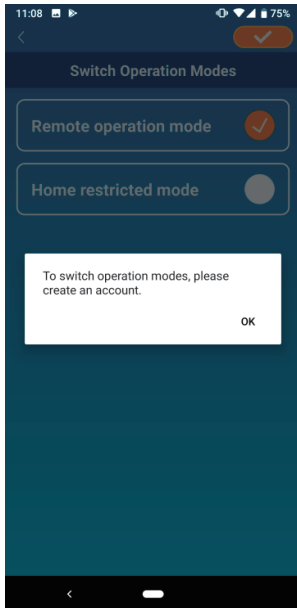

Figure 13-4

When the account creation pop-up message appears, tap [OK], agree with the handling of personal information, and create an account.

→ To [“Creating user account”](#)

• Switching to “Home restricted mode”

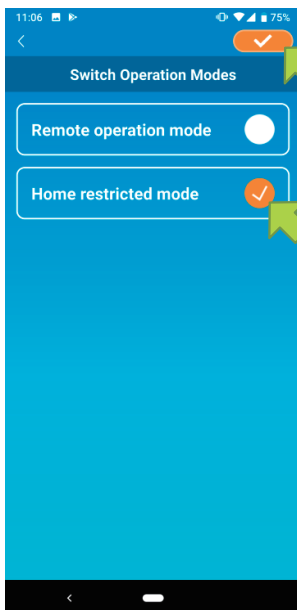



Figure 13-5

Tap [Home restricted mode] → Tap  on the top right to switch the mode.

Note

- Note that if you switch the mode to “Home restricted mode”, the account information used in “Remote operation mode” is deleted.

The popup for remote control disabled and the popup for deleting server data will appear, so tap [YES].

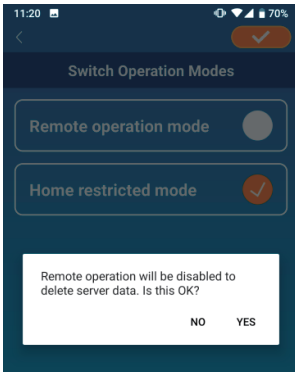

Figure 13-6

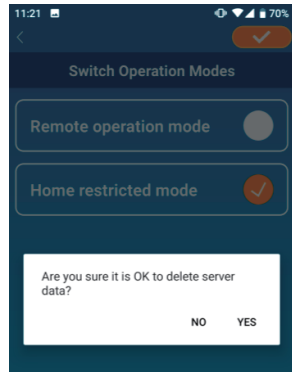

Figure 13-7

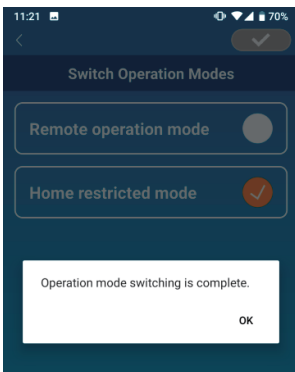

Figure 13-8

When the operation mode switching completion pop-up message appears, tap [OK].

• Reset Password

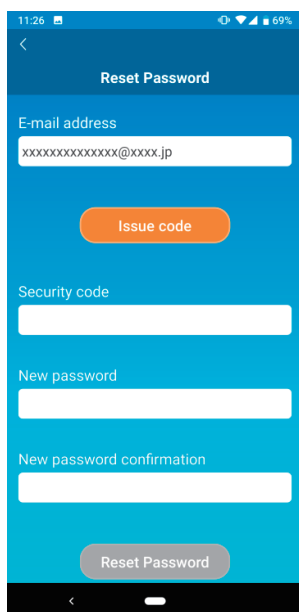



Figure 13-9

Enter the registered e-mail address and tap the [Issue code] button.

Note

- After tapping the [Issue code] button, keep this screen displayed until the password resetting is completed.
If you tap  and return to the previous screen, these operations are canceled.

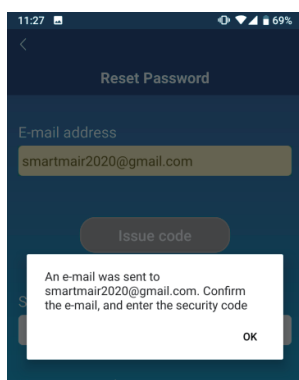

Figure 13-10

When the e-mail sending pop-up message appears, tap [OK].

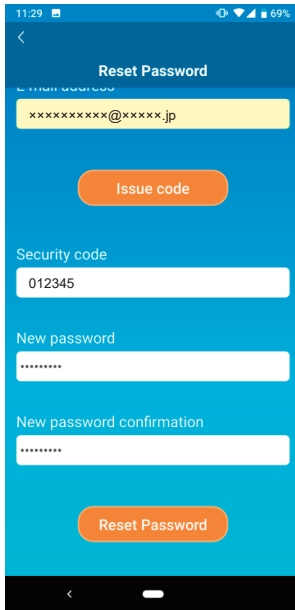

Figure 13-11

An e-mail with a security code will be sent to the e-mail address you entered. Enter “Security code” and “New password” and tap [Reset Password] to update your password.

Note

- A password must be between 8 to 16 characters including at least one alphabetic character and one numeric character.

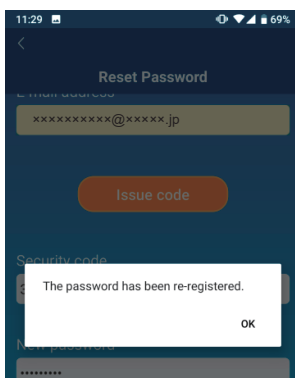
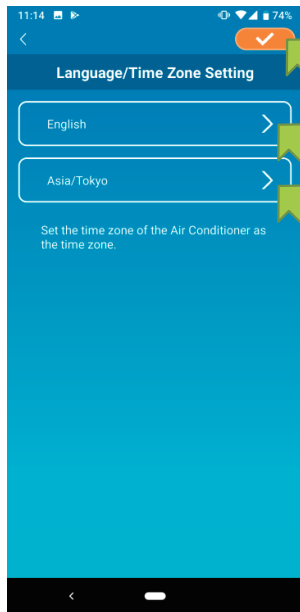

Figure 13-12

- Language/Time Zone Settings



The “Language/Time Zone Settings” screen appears.

Select a language to use in the application.

Select a time zone. Select the time zone in which the air conditioner to operate via the application exists.

Finally, tap  on the top right to complete the setting.

Figure 13-13

- Application Initialization

Initializes the smartphone application.

Note

- Note that if you initialize the application in “Remote operation mode”, the information of the account logged in is deleted.
-



Tap [Initialize the application].

Figure 13-14

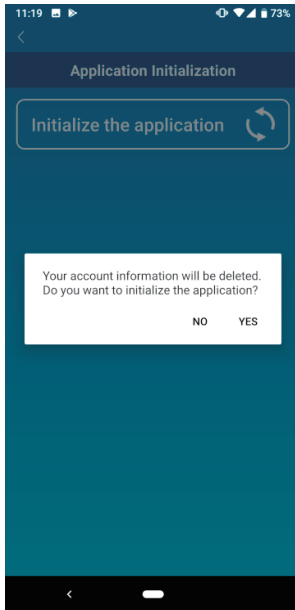

When the pop-up message “Your account information will be deleted. Do you want to initialize the application?” appears, tap [YES].

Figure 13-15

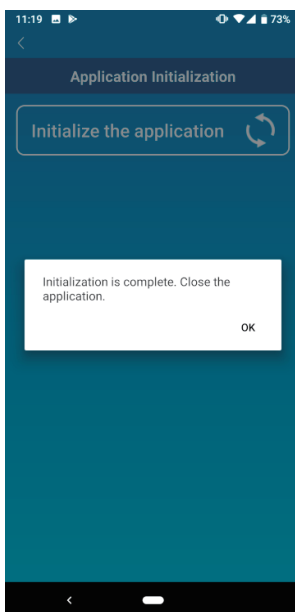

When the pop-up message "Initialization is complete. Close the application." appears, tap [OK] to close the application.

Figure 13-16

- Application Version Display

Displays the version of your smartphone application.

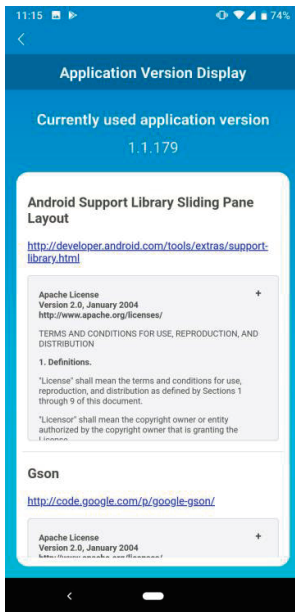
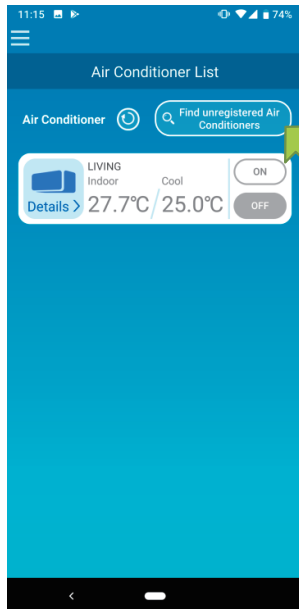

Figure 13-17

14. Troubleshooting

- When the air conditioner that you want to register does not appear in the air conditioner list screen



Tap the [Find unregistered Air Conditioners] Button to search unregistered air conditioners and update the “Air Conditioner List” screen.

Figure 14-1

- How to delete a registered air conditioner

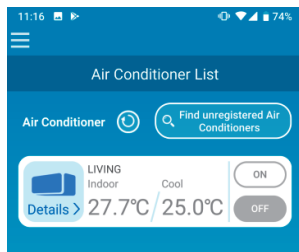

To delete a registered air conditioner, press and hold down (2 seconds) the icon of the target air conditioner.

Figure 14-2

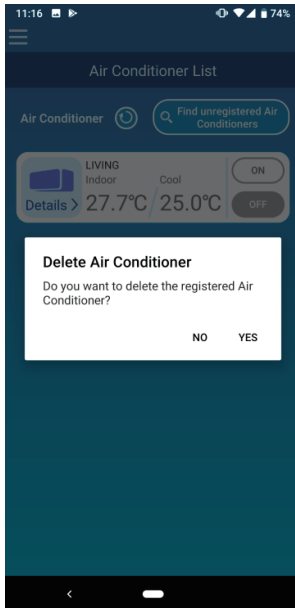

Figure 14-3

When the deleting air conditioner pop-up Message appears, tap [YES].

- When an abnormality notification appears in the air conditioner list

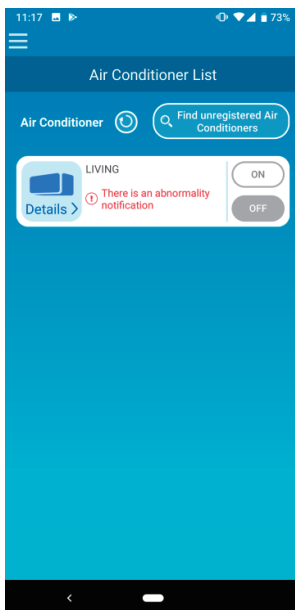
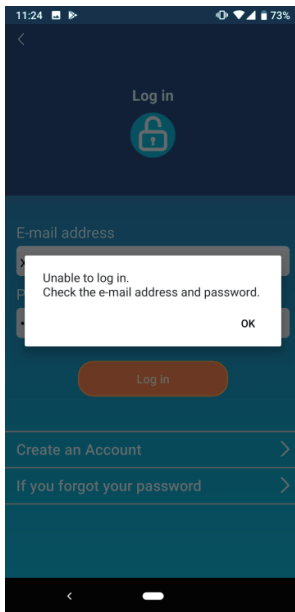

Figure 14-4

When an abnormality notification appears, air conditioner abnormality has been detected. Contact your dealer.

When “AC error notification” of the option settings is enabled, an e-mail is sent to the registered e-mail address.

- When you forget your password and cannot log in



If you forgot your password and failed to log in, tap [OK] on the pop-up message, tap [If you forgot your password] to display the “Reset Password” screen, and set a new password.

→ To [“Reset Password”](#)

Figure 14-5

mitsubishi Heavy Industries Thermal Systems, Ltd.

2-3, Marunouchi 3-chome, Chiyoda-ku, Tokyo, 100-8332, Japan
<http://www.mhi-mth.co.jp/en/>

Mitsubishi Heavy Industries Air-Conditioning Europe, Ltd.

5 The Square, Stockley Park, Uxbridge, Middlesex, UB11 1ET, United Kingdom
Tel : +44-333-207-4072
Fax: +44-333-207-4089
<http://www.mhiae.com/>

MHIAE SERVICES B.V.

(Wholly-owned subsidiary of MITSUBISHI HEAVY INDUSTRIES AIR-CONDITIONING EUROPE, LTD.)
Herikerbergweg 238, Luna ArenA, 1101 CM Amsterdam, Netherlands
P.O.Box 23393 1100 DW Amsterdam, Netherlands
Tel : +31-20-406-4535
<http://www.mhiaeservices.com/>

Mitsubishi Heavy Industries Air-Conditioners Australia, Pty. Ltd.

Block E, 391 Park Road, Regents Park, NSW, 2143 PO BOX 3167, Regents Park, NSW, 2143
Tel : +61-2-8774-7500
Fax: +61-2-8774-7501
<https://www.mhiala.com.au>

10. FAQ (Troubleshooting)

Usage fee

Is it free to download and use the application?

The use of the application is free of charge.

* Separate communication fees are required when downloading the application and accessing the server.

Usage conditions

How can I install the application?

Install the application as shown in the table below.

How to install the “Smart M-Air” smartphone application	
<p>For Android</p> <ol style="list-style-type: none"> 1. Open [Google Play]. 2. Search for [Smart M-Air]. 3. Install the application according to the instructions on the screen. 	<p>For iOS (iPhone)</p> <ol style="list-style-type: none"> 1. Open [App Store]. 2. Search for [Smart M-Air]. 3. Install the application according to the instructions on the screen.
<p>User's Manual</p> <p>Refer to the home page of MITSUBISHI HEAVY INDUSTRIES THERMAL SYSTEMS, LTD.</p> <p>http://www.mhi-mth.co.jp/en/products/detail/air-conditioner_users_manual.html</p>	

Can I remotely operate any of Mitsubishi Heavy Industries Thermal Systems' air conditioners?

You can operate products manufactured in 2010 or later excluding the housing series. Optional parts and construction by an authorized dealer are required separately. For details, consult the sales outlet for the product.

Can I use the application to do what I can do with the remote control?

The operable functions of the smartphone differs from that of the remote control. You cannot operate some of functions with the application.

Can I use the application in an environment with no Internet connection?

Yes. Note that a wireless LAN router* is required additionally.

In this case, you cannot operate an air conditioner while on the go.

You can operate it only at home.

* A wireless LAN router compatible with IEEE 802.11b, g, or n (2.4 GHz band) is required.

Operation with a mobile Wi-Fi router is not guaranteed.

I cannot update the application to the latest one. What should I do?

Your smartphone's OS may be out of date.

The supported OS are:

Android : Version 8 or 10

iOS : Version 12 or 14

* Operation on other versions is not guaranteed.

Can I operate one air conditioner with multiple smartphones?

You can operate it with up to four smartphones.

Can I operate multiple air conditioners with one smartphone?

Yes.

Can I use the wireless LAN interface together with the wireless remote control?

Yes. However, you cannot use it while using the wired remote control.

Can I establish connection in any wireless LAN environment?

The wireless LAN environment must be compatible with the following standard:

Wireless networking standard : IEEE 802.11b/g/n, 2.4 GHz*

Channel : 1 to 13

Encryption method : WPA-PSK (TKIP), WPA-PSK (AES),
WAP2-PSK (TKIP), WPA2-PSK (AES)

* 5GHz is not supported.

Before purchasing an air conditioner, I want to check that wireless LAN radio waves can reach the installation location of the air conditioner.

After connecting your smartphone to the wireless LAN router, move to the installation location, and check the number of lines of the Wi-Fi antenna symbol on the smartphone.

The service can be used if the wireless LAN is still connected and the number of lines of the Wi-Fi antenna symbol is full or one less than full.

* This is only for a guideline and does not guarantee connection.

Connection may not be possible depending on the usage status of the other wireless LAN devices or the conditions of obstacles or devices generating radio waves.

How can I check the MAC address of an air conditioner?

See the label affixed to the wireless LAN interface.

Can I use the ping command to test the response from an air conditioner?

The ping command is not supported for response check.

What is the communication port number?

No port number is specified.

Can I use a mobile Wi-Fi router and the like?

Operation with a mobile Wi-Fi router and the like is not guaranteed.

Can I use a wireless LAN repeater?

Operation with a wireless LAN repeater is not guaranteed.

Can I use it in an environment with only a wired LAN?

You need a wireless LAN access point such as a commercially available wireless LAN router. To use the wireless LAN interface, a wireless connection to the Internet is required.

Can I connect and use HEMS devices that support the ECHONET Lite standard?

No, you cannot. The ECHONET Lite standard is not supported.

I cannot connect to the wireless LAN access point by using the WPS function.

- If you are far from the wireless LAN access point or there are many obstacles in between, approach the access point and try again.
- If the MAC address filtering is enabled in the wireless LAN access point settings, disable it or allow the MAC address of the wireless LAN interface.
- If the SSID of the wireless LAN access point is set to the stealth mode, cancel it.

When connecting to a wireless LAN access point with no WPS function in the instructed procedure, its SSID is not displayed in the access point list. (For Android only)

- Check that the SSID of the wireless LAN access point is not set to the stealth mode. If it is set to the stealth mode, cancel it.

Functionality

What is the e-mail address and password used to create an account of "Remote operation mode"?

Set an e-mail address that you want to receive the air conditioner information. You are recommended to set the e-mail address that can be viewed on your smartphone.

Set a password between 8 to 16 characters including both alphabetic and numeric characters.

Can I use the registered e-mail address for the application installed on another smartphone?

You can use one account for only one smartphone.

Therefore you cannot use the e-mail address with your previously registered smartphone.

When I operate with the smartphone application, I hear no reception sound from the air conditioner.

There is no reception sound when you operate with the smartphone application.

Which takes precedence between the remote control operation and smartphone application operation?

The operation performed later has priority.

However, you cannot operate with the smartphone application within 1 minute after another user operates.

When turning ON (starting) an air conditioner with the smartphone application, what happens to the air conditioner settings (such as the operation mode and fan)?

The air conditioner operates according to the smartphone application settings.

Can I operate an air conditioner with my smartphone while it is performing internal cleaning?

The air conditioner stops the internal cleaning and operates according to the operation from the smartphone.

In which part of the air conditioner is the displayed room temperature measured?

The sensor of your home air conditioner indoor unit registered with the application measures the displayed room temperature.

Can I update the firmware of the wireless LAN interface?

You can update it with the smartphone application.

No push notification or e-mail is sent to my smartphone, such as a shut-off reminder alert and watching function.

Check that each notification function is turned "ON" via "Options" of each air conditioner setting screen.

If it is turned "OFF," no notification is sent when the notification function is "OFF."

Do the functions of the application differ between Android and iPhone?

The functions are the same.

Can I use it with an Android or iOS-equipped tablet?

An Android-equipped tablet is supported. An iOS-equipped tablet is not supported yet.

Do I need to reset the wireless LAN interface after a power failure?

No, resetting is not required.

I forgot my account ID and password.

The ID is your e-mail address. Reset the password via "If you forgot your password" on the "Log in" screen.

In the air conditioner list, the air conditioner icon grayed out and disabled.

Check the following:

- Use the latest application and firmware of wireless LAN interface.
- Check that the indoor unit is powered on.
- Check that the Running LED of the wireless LAN interface lights up.
If it lights out, press the power button 2 seconds or more to activate it.
- Check that the wireless LAN access point is connected to the Internet normally.
- When operating remotely while on the go, switch to "Remote operation mode" on the "Switch Operation Modes" screen.
- Check that the smartphone line is not disconnected.
- Press the Reset button on the wireless LAN interface for less than 3 seconds. The wireless LAN interface restarts.

The smartphone application does not work.

Check the following:

- Update the application to the latest version, and upgrade to the recommended OS.
- Quit all applications running in the background.
- Check that the OS is compatible with the latest application.
If the OS is incompatible, upgrade the OS and install the application again.

What should I do if I change my smartphone model?

Install the application again. When using the remote operation mode, use the e-mail address that has been used before you change your smartphone model.

I cannot connect the wireless LAN interface to the wireless LAN access point by using the WPS function.

Please try several times. If you cannot establish the connection, perform the operation described in "Wireless LAN router NOT equipped with WPS function" of the Wireless LAN Interface User's Manual.

Can I turn off the lamp of the wireless LAN interface?

You can turn off the lamp with the smartphone application. To turn it off, switch "LED ON" of "Options" on each air conditioner setting screen to "OFF".

Can anyone install the wireless LAN interface?

For the installation, contact your dealer.

Is the connection checked by the air conditioner contractor?

No, please check it by the user itself.

Can I use the same account with multiple smartphones?

No. You can use one account for only one smartphone.

If you log in to the second smartphone with the registered account, you will be prompted to log in again when you try to remote control with the first smartphone.

The air conditioner has stopped automatically.

Check the following:

- Check if another user is operating.
- Check that the timer is set.
- Check if any abnormality occurred on the air conditioner.
When remote control is enabled, an e-mail is sent to the registered e-mail address or displayed on the application.
Read the message and contact the service front center.
- Check your home Internet connection. If there is no Internet connection for 24 hours, the air conditioner is turned off.

In the alert list, some alerts are marked with an exclamation mark.

What does it mean?

It indicates an unread alert. Please read it.

I forgot the e-mail address and password registered with my account.

For the e-mail address, check the address of the e-mail received from "smartmair.com".

For the password, newly set the password via "If you forgot your password" on the "Log in" screen.

I want to delete a registered air conditioner from the application.

To delete a registered air conditioner, press and hold down the icon of the target air conditioner on the "Air Conditioner List" screen.

Can I perform allergen clear operation with a smartphone application?

No.

I changed my address. Do I need to make the settings again?

If your wireless LAN access point has not changed, resetting is unnecessary.

However, make sure that the wireless LAN interface communicates normally with the wireless LAN access point.

I accidentally initialized the wireless LAN interface. What should I do?

Establish connection to your wireless LAN access point according to the manual. If you are using "Home restricted mode," delete the air-conditioner from the Air Conditioner List, and register it again by clicking the "Find unregistered air conditioners" button.

I bought a new wireless LAN access point. Can I operate it with my smartphone without change?

No. Connect the wireless LAN interface and the wireless LAN access point.

I accidentally deleted the application from my smartphone. I installed the application again. Can I return to the same status as before the deletion?

Please perform the following:

- If you are using "Remote operation mode" before deleting the application, create an account again using the registered e-mail address. In such a case, no confirmation e-mail for account creation is sent. Proceed to the log in process. On the "Air Conditioner List" screen, tap the "Find unregistered air conditioners" button to re-register the air conditioner that has been registered.
- If you are using "Home restricted mode" before deleting the application, on the "Air Conditioner List" screen, tap the "Find unregistered air conditioners" button to re-register the air conditioner that has been registered.

I want to change the font size of the application.

Cannot change.

The weekly timer doesn't work as configured.

Please confirm as follows.

- Make sure that no one else is using it. The timer setting will not be reflected if it is operated about one minute before the set time. In addition, the settings may have been changed because the operations you performed later become effective.
- Please check if there is something wrong with the air conditioner. When remote control is enabled, you can receive mail to the registered mail address. It is displayed on the application. Please check the details and contact the Service Front Center.
- Check your Internet connection at home. If the Internet connection is disconnected at the set time, the timer setting is not reflected.

Can I check the driving status with the application?

You can check the operation mode, set temperature, etc.

What can I do with the app other than driving (On/Off)?

Changing the operating mode (Auto, Cool, Heat, Fan, and Dry)
You can operate air volume, wind direction, temperature setting, timer operation, and other optional functions.
For details, refer to "Smart M-Air Operation Manual".

Can I set up clean or power save operation with the application?

You cannot set it in the application.

Is there anything I can do only with the application?

You can operate the air conditioner in each room at home or from outside.
There are also timer reservations by day of the week and function to notify you that you forgot to stop the operation.
For details, refer to "Smart M-Air Operation Manual".

Can I drive continuously with the application?

Continuous operation is possible up to 24 hours after the operation command is issued from the application.
(If there is no operation from the application for 24 hours, the air conditioner stops automatically.)

Cannot change airflow "Fan" in Dry mode.

If you are in Dry mode, the air flow "Fan" is limited.
The airflow setting from the application is valid only for "Auto", and even if you select a mode different from "Auto", the actual operation is "Auto".

What is a weekly timer?

You can set up to six timers for each day of the week.
(Timer is 5 Minute Units)
Each timer setting is either run or stop.

How many patterns can I store as favorite settings?

1 smartphone (1 App) can store 2 patterns per registered air conditioner.

The smartphone cannot connect to the wireless LAN interface.

Check your smartphone's Internet connection environment.
Because of the function of the application, it is necessary to operate in the Internet connection environment, so please check and set it.

You cannot operate it even if you operate the application. (Not updated)

Depending on the wireless LAN connection environment, it may fail to recognize the wireless LAN interface.

In this case, you may be able to operate by the following operations.

- Tap the Refresh button.
- I "OFF" the Wi-Fi function on my smartphone and "ON" it again.
- Reset the wireless LAN interface.

If the above procedure does not work, check the wireless LAN connection environment.

After setting the connection between the wireless LAN interface and the wireless LAN router in WPS mode, pressing "Find unregistered Air Conditioners" does not display the air conditioner.

Depending on the wireless LAN connection environment, it may fail to recognize the wireless LAN interface.

In this case, you may be able to operate by the following operations.

- Tap the Refresh button.
- I "OFF" the Wi-Fi function on my smartphone and "ON" it again.
- Reset the wireless LAN interface.

If the above procedure does not work, check the wireless LAN connection environment.

"Shut-off reminder alert" cannot be turned on by option setting.

When changing "Shut-off reminder alert" from OFF to ON, make sure that your smartphone is connected to the same network as the wireless LAN network to which the air conditioner is connected.

Depending on the wireless LAN connection environment, it may fail to recognize the wireless LAN interface.

In this case, you may be able to operate by the following operations.

- Tap the Refresh button.
- I "OFF" the Wi-Fi function on my smartphone and "ON" it again.
- Reset the wireless LAN interface.

If the above procedure does not work, check the wireless LAN connection environment.

Unable to update firmware.

Firmware update is not available during operation or clean operation (Fan operation indication).

Turn off the air conditioner before updating the firmware.

Depending on the wireless LAN connection environment, it may fail to recognize the wireless LAN interface.

In this case, you may be able to operate by the following operations.

- Tap the Refresh button.
- I "OFF" the Wi-Fi function on my smartphone and "ON" it again.
- Reset the wireless LAN interface.

If the above procedure does not work, check the wireless LAN connection environment.

The timer was set using the calendar function, but the air conditioner was already running before the operation command was issued.

Up to the set time on the selected day of the week

(Weekly Timer Settings),

the operation status from the previous day is inherited.

If the last setting of the previous day is the operation command, will remain in operation until the stop command comes.

(If there is no command for 24 hours, it stops automatically.)

If you want to stop it, review the settings.

Timer cannot be set with a home remote control.

When the wireless LAN interface is connected, the timer setting is disabled on your home remote control depending on your air conditioner.

Please use the timer function of the application to set the timer.

Electricity Bill Graph is not displayed.

Some models don't have the function depending on the connected air conditioner. If the function is not installed, the electric charge is displayed as 0.

Is the Electricity Bill Graph displayed for each air conditioner?

It is displayed for each air conditioner.

11. TIMER FUNCTION OPERATION EXPLANATION

(1) Overview

This section describes the indoor operation statuses in which the timer is set by the wireless remote control when an optional device is connected (wired remote control, remote control device, etc.).

Depending on the type of indoor unit, there are the following 2 types of indoor operation status.

- (a) Indoor units with the timer setting turned off from an optional device •••(2). Depends on the indoor unit operation status [indoor unit with the timer setting turned off] before and after receiving a signal from the wireless remote control.

List of indoor unit types



SRK20ZSX-W/A, SRK25ZSX-W/A, SRK35ZSX-W/A, SRK50ZSX-W/A, SRK60ZSX-W/A
 SRK20ZSX-WT/A, SRK25ZSX-WT/A, SRK35ZSX-WT/A, SRK50ZSX-WT/A, SRK60ZSX-WT/A
 SRK20ZSX-WB/A, SRK25ZSX-WB/A, SRK35ZSX-WB/A, SRK50ZSX-WB/A, SRK60ZSX-WB/A
 SRK20ZS-W/A, SRK25ZS-W/A, SRK35ZS-W/A, SRK50ZS-W/A
 SRK20ZS-WT/A, SRK25ZS-WT/A, SRK35ZS-WT/A, SRK50ZS-WT/A
 SRK20ZS-WB/A, SRK25ZS-WB/A, SRK35ZS-WB/A, SRK50ZS-WB/A
 SRK63ZR-W, SRK71ZR-W, SRK80ZR-W, SRK100ZR-W
 SRR25ZS-W, SRR35ZS-W, SRR50ZS-W, SRR60ZS-W
 SRF25ZS-W, SRF35ZS-W, SRF50ZSX-W

- (b) Indoor units with the timer setting turned on from an optional device •••(3). Depends on the indoor unit operation status [indoor unit with the timer setting turned on] before and after receiving a signal from the wireless remote control.

Indoor unit types with updated service codes from (a)

(2) Indoor unit operation status [indoor unit with the timer setting turned off] before and after receiving a signal from the wireless remote control

Indoor unit operation status before receiving a signal	Signal from the wireless remote control(except from the timer function only)	Indoor unit operation status after receiving a signal					
		When an option is not connected			When an option is connected		
		Timer status	RUN LED	TIMER LED	Timer status	RUN LED	TIMER LED
Stopped	ON TIMER	① Standby running ② Warming-up running ③ (Running) Timer setting time elapsed	OFF ON ↓	ON ↓ OFF	Timer does not operate (Running)	ON ↓ ↓	OFF ↓ ↓
	OFF TIMER	Does not operate	OFF	OFF	Does not operate	OFF	OFF
	SLEEP TIMER	① Timer ON (Running) ② (Stop) Timer setting time elapsed	ON OFF	ON OFF	Timer does not operate (Running)	ON ↓	OFF ↓
	ON+OFF TIMER	① Standby running ② Warming-up running ③ (Running) Timer setting time elapsed ④ (Stop) Timer setting time elapsed	OFF ON ↓ OFF	ON ↓ OFF	Timer does not operate (Running)	ON ↓ ↓	OFF ↓ ↓
	OFF+ON TIMER	Does not operate	OFF	OFF	Does not operate	OFF	OFF
	SLEEP+ON TIMER	① Timer ON (Running) ② Standby running: timer setting time elapsed ③ Warming-up running ④ (Running) Timer setting time elapsed	ON OFF ON ↓	ON ↓ OFF	Timer does not operate (Running)	ON ↓ ↓	OFF ↓ ↓
	WEEKLY TIMER (When RUN setting → STOP setting)	① Timer ON (Stopped) ② (Running) Timer setting time elapsed ③ (Stop) Timer setting time elapsed	OFF ON OFF	ON ↓ ↓	Timer does not operate (Stopped)	OFF ↓ ↓	OFF ↓ ↓
Running	ON TIMER	① Standby running ② Warming-up running ③ (Running) Timer setting time elapsed	OFF ON ↓	ON ↓ OFF	Timer does not operate (Stopped)	ON ↓ ↓	OFF ↓ ↓
	OFF TIMER	① Timer ON (Running) ② (Stop) Timer setting time elapsed	ON OFF	ON OFF	Timer does not operate (Running)	ON ↓	OFF ↓
	SLEEP TIMER	① Timer ON (Running) ② (Stop) Timer setting time elapsed	ON OFF	ON OFF	Timer does not operate (Running)	ON ↓	OFF ↓
	ON+OFF TIMER	① Standby running ② Warming-up running ③ (Running) Timer setting time elapsed ④ (Stop) Timer setting time elapsed	OFF ON ↓ OFF	ON ↓ OFF	Timer does not operate (Running)	ON ↓ ↓	OFF ↓ ↓
	OFF+ON TIMER	① Timer ON (Running) ② Standby running: timer setting time elapsed ③ Warming-up running ④ Timer OFF (Running)	ON OFF ON ↓	ON ↓ OFF	Timer does not operate (Running)	ON ↓ ↓	OFF ↓ ↓
	SLEEP+ON TIMER	① Timer ON (Running) ② Standby running: timer setting time elapsed ③ Warming-up running ④ (Running) Timer setting time elapsed	ON OFF ON ↓	ON ↓ OFF	Timer does not operate (Running)	ON ↓ ↓	OFF ↓ ↓
	WEEKLY TIMER (When STOP setting → RUN setting)	① Timer ON (Running) ② (Stop) Timer setting time elapsed ③ (Running) Timer setting time elapsed	ON OFF ON	ON ↓ ↓	Timer does not operate (Running)	ON ↓ ↓	OFF ↓ ↓

 Different operation from when an option is not connected
 Same operation as when an option is not connected

Ex. 1

Timer control signal from the wireless remote control

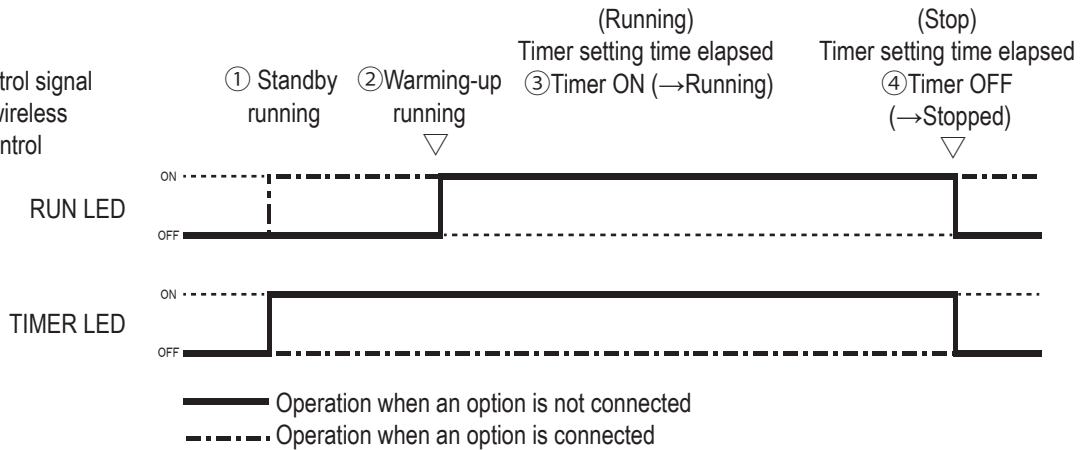

- TIMER LED remains OFF
- Air conditioner turns ON at the same time the control signal from the wireless remote control is received
- Operation does not stop at the OFF time.

**Ex. 2
WEEKLY TIMER**

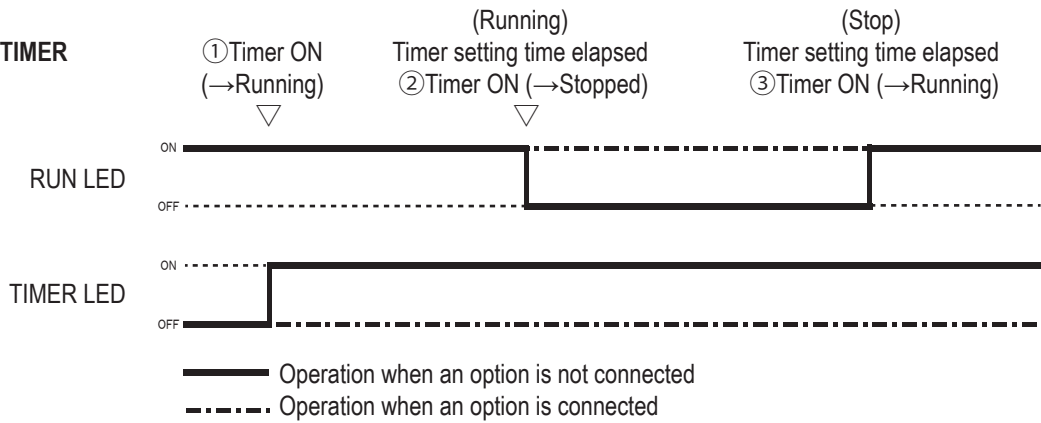

- TIMER LED remains OFF
- Running continues during the Stop period (②→③).

(3) Indoor unit operation status before and after receiving a signal from the wireless remote control
[Indoor unit with a timer setting enabled from an optional device]

For each indoor operation status including timer settings, the indoor run/stop status when the run/stop signal was changed due to operation or timer settings from an optional device is shown in the table below. Operations that cancel the wireless remote control timer setting through an operation from an optional device are shown with □.

Indoor unit running status	Signal from the optional device		
	Run/Stop During SW operation	Run signal by timer control	Stop signal by timer control
Before the OFF TIMER setting time elapses (Before the SLEEP TIMER setting time elapses)	Run ⇒ Stop	Run (No change)	Run ⇒ Stop
ON TIMER on standby	On standby ⇒ Run	On standby ⇒ Run	On standby ⇒ Stop
Warming-up running	Run ⇒ Stop	Run (No change)	Run ⇒ Stop
Running	Run ⇒ Stop	Run (No change)	Run ⇒ Stop
Stopped	Stop ⇒ Run	Stop ⇒ Run	Stop (No change)
After the ON time of the WEEKLY TIMER (Running)	Run ⇒ Stop	Run (No change)	Run ⇒ Stop
After the OFF time of the WEEKLY TIMER (Stopped)	Stop ⇒ Run	Stop ⇒ Run	Stop (No change)

Ex. 3

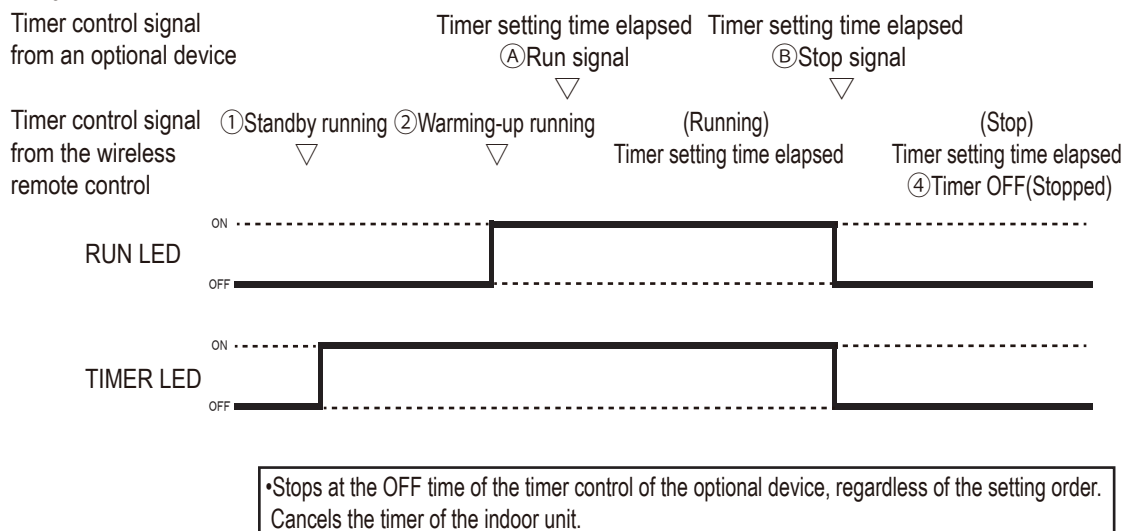

Ex. 4

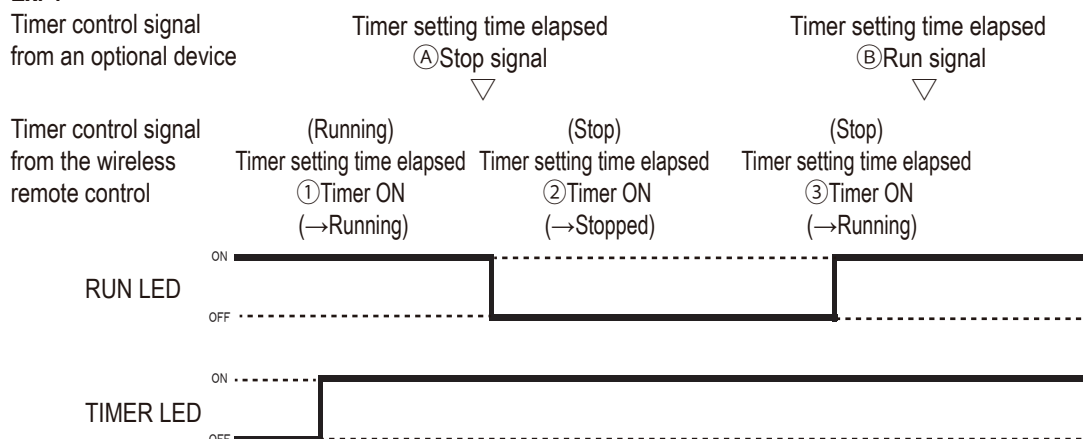

WIRELESS LAN INTERFACE



MITSUBISHI HEAVY INDUSTRIES THERMAL SYSTEMS, LTD.

2-3, Marunouchi 3-chome, Chiyoda-ku, Tokyo, 100-8332, Japan

<http://www.mhi-mth.co.jp/en/>

Because of our policy of continuous improvement, we reserve the right to make changes in all specifications without notice.

© Copyright MITSUBISHI HEAVY INDUSTRIES THERMAL SYSTEMS, LTD.