



TECHNICAL MANUAL

INVERTER WALL MOUNTED TYPE RESIDENTIAL AIR-CONDITIONERS (Split system, air to air heat pump type)

SRK25ZSP-W
SRK35ZSP-W
SRK45ZSP-W
SRK50ZSP-W

CONTENTS

1. SPECIFICATIONS	3
2. EXTERIOR DIMENSIONS	8
(1) Indoor units	8
(2) Outdoor units	9
(3) Wireless remote control	11
3. ELECTRICAL WIRING	12
(1) Indoor units	12
(2) Outdoor units	13
4. NOISE LEVEL	15
5. PIPING SYSTEM	26
6. RANGE OF USAGE & LIMITATIONS	27
7. CAPACITY TABLES	29
8. APPLICATION DATA	31
9. OUTLINE OF OPERATION CONTROL BY MICROCOMPUTER	39
(1) Operation control function by wireless remote control	39
(2) Unit ON/OFF button	40
(3) Auto restart function	40
(4) Installing two air-conditioners in the same room	40
(5) High power operation	41
(6) Economy operation	41
(7) Air flow direction adjustment	41
(8) Timer operation	42
(9) Outline of heating operation	42
(10) Outline of cooling operation	44
(11) Outline of automatic operation	44
(12) Protection control function	45
10. MAINTENANCE DATA	53
(1) Cautions	53
(2) Items to check before troubleshooting	53
(3) Troubleshooting procedure (If the air-conditioner does not run at all)	53
(4) Troubleshooting procedure (If the air-conditioner runs)	54
(5) Self-diagnosis table	55
(6) Service mode (Trouble mode access function)	56
(7) Inspection procedures corresponding to detail of trouble	64

(8) Phenomenon observed after short-circuit, wire breakage on sensor 68
 (9) Checking the indoor electrical equipment 69
 (10) How to make sure of wireless remote control 70
 (11) Outdoor unit inspection points 71
11. TECHNICAL INFORMATION 74

■ How to read the model name

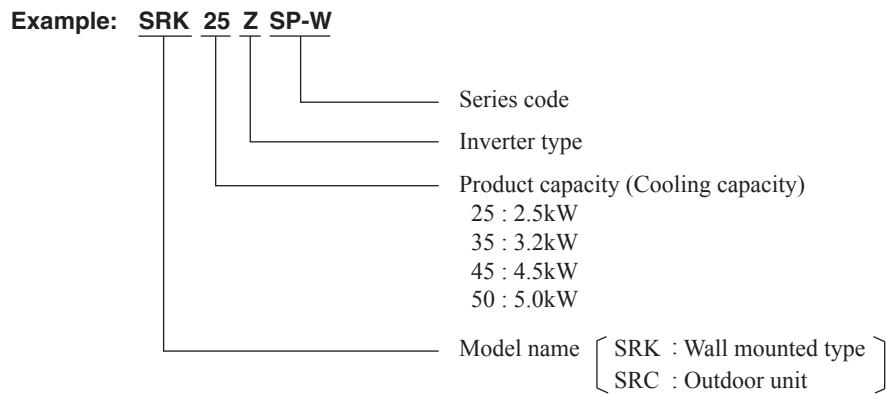

1. SPECIFICATIONS

Model SRK25ZSP-W

Item		Model	SRK25ZSP-W				
			Indoor unit SRK25ZSP-W		Outdoor unit SRC25ZSP-W		
Power source			1 Phase, 220 - 240V, 50Hz				
Operation data	Nominal cooling capacity (range)	kW	2.5 (0.9 (Min.) - 3.1 (Max.))				
	Nominal heating capacity (range)	kW	2.8 (1.0 (Min.) - 4.1 (Max.))				
	Heating capacity (H2)	kW	-				
	Power consumption	Cooling	kW	0.710 (0.20 - 1.01)			
		Heating		0.690 (0.20 - 1.43)			
		Heating (H2)		-			
	Max power consumption		1.65				
	Running current	Cooling	A	3.6 / 3.4 / 3.3 (220/ 230/ 240 V)			
		Heating		3.5 / 3.4 / 3.2 (220/ 230/ 240 V)			
	Inrush current, max current			3.6 / 3.4 / 3.3 (220/ 230/ 240 V) Max. 9			
	Power factor	Cooling	%	90			
		Heating		89			
	EER	Cooling		3.52			
	COP	Heating		4.05			
		Heating (H2)		-			
Sound power level	Cooling	dB(A)	57		57		
	Heating		57		56		
Sound pressure level	Cooling	dB(A)	Hi: 45 Me: 34 Lo: 23	47			
	Heating		Hi: 43 Me: 34 Lo: 26	45			
Silent mode sound pressure level			-		-		
Exterior dimensions (Height x Width x Depth)	mm		267 × 783 × 210		540 × 645(+57) × 275		
Exterior appearance (Equivalent color)			Fine snow Munsell : (8.0Y 9.3/0.1), RAL : 9003		Stucco white Munsell : (4.2Y 7.5/1.1), RAL : 7044		
Net weight	kg		7.0		26.5		
Compressor type & Quantity			-		RM-C5077SBE7 (Rotary type) × 1		
Compressor motor (Starting method)	kW		-		0.75 (Inverter driven)		
Refrigerant oil (Amount, type)	ℓ		-		0.3 (DIAMOND FREEZE MB75)		
Refrigerant (Type, amount, pre-charge length)	kg		R32 0.550 in outdoor unit (Incl. the amount for the piping of 10m)				
Heat exchanger			Louver fins & inner grooved tubing		M fins & inner grooved tubing		
Refrigerant control			Capillary tubes + Electronic expansion valve				
Fan type & Quantity			Tangential fan × 1		Propeller fan × 1		
Fan motor (Starting method)	W		30 × 1 (Direct drive)		24 × 1 (Direct drive)		
Air flow	Cooling	m ³ /min	Hi: 10.0 Me: 7.3 Lo: 4.2		23.7		
	Heating		Hi: 9.5 Me: 7.3 Lo: 5.2		19.7		
Available external static pressure	Pa		0		0		
Outside air intake			Not possible		-		
Air filter, Quality / Quantity			Polypropylene net (Washable)		-		
Shock & vibration absorber			Rubber sleeve (for fan motor)		Rubber sleeve (for fan motor & compressor)		
Electric heater			-		-		
Operation control	Remote control		Wireless remote control				
	Room temperature control		Microcomputer thermostat				
	Operation display		RUN: Green , TIMER: Yellow				
Safety equipments			Compressor overheat protection, Overcurrent protection, Frost protection, Serial signal error protection, Indoor fan motor error protection, Heating overload protection(High pressure control), Cooling overload protection				
Installation data	Refrigerant piping size (O.D)	mm	Liquid line: ϕ 6.35 (1/4")		Gas line: ϕ 9.52 (3/8")		
	Connecting method		Flare connection		Flare connection		
	Attached length of piping	m	Liquid line : 0.46 / Gas line : 0.39		-		
	Insulation for piping		Necessary (Both sides), independent				
	Refrigerant line (one way) length	m	Max.15				
	Vertical height diff. between O.U. and I.U.	m	Max.10 (Outdoor unit is higher) / Max.10 (Outdoor unit is lower)				
Drain hose			Hose connectable (VP16)		Hole ϕ 20 x 2 pcs.		
Drain pump, max lift height	mm		-		-		
Recommended breaker size	A		16				
L.R.A. (Locked rotor ampere)	A		3.6 / 3.4 / 3.3 (220/ 230/ 240 V)				
Interconnecting wires	Size x Core number		1.5mm ² × 4 cores (Including earth cable) / Terminal block (Screw fixing type)				
IP number			IPX0		IPX4		
Standard accessories			Mounting kit				
Option parts			-				
Notes			(1) The data are measured at the following conditions. The pipe length is 5m.				
Operation	Item	Indoor air temperature		Outdoor air temperature		Standards	
		DB	WB	DB	WB		
	Cooling	27°C	19°C	35°C	24°C	ISO5151-T1	
	Heating	20°C	-	7°C	6°C	ISO5151-H1	
Heating (H2)	20°C	-	2°C	1°C	ISO5151-H2		
(2) This air-conditioner is manufactured and tested in conformity with the ISO.							
(3) Sound level indicates the value in an anechoic chamber. During operation these values are somewhat higher due to ambient conditions.							
(4) Select the breaker size according to the own national standard.							

Model SRK35ZSP-W

Item		Model	SRK35ZSP-W				
			Indoor unit SRK35ZSP-W		Outdoor unit SRC35ZSP-W		
Power source			1 Phase, 220 - 240V, 50Hz				
Operation data	Nominal cooling capacity (range)	kW	3.2 (0.9 (Min.) - 3.7 (Max.))				
	Nominal heating capacity (range)	kW	3.6 (1.0 (Min.) - 4.6 (Max.))				
	Heating capacity (H2)	kW	-				
	Power consumption	Cooling	kW	0.910 (0.20 - 1.32)			
		Heating		0.930 (0.20 - 1.43)			
	Max power consumption	Heating (H2)	kW	-			
		Heating (H2)		1.65			
	Running current	Cooling	A	4.4 / 4.3 / 4.1 (220/ 230/ 240 V)			
		Heating		4.5 / 4.3 / 4.2 (220/ 230/ 240 V)			
	Inrush current, max current			4.5 / 4.3 / 4.2 (220/ 230/ 240 V)		Max. 9	
	Power factor	Cooling	%	93			
		Heating		93			
	EER	Cooling		3.52			
	COP	Heating		3.87			
		Heating (H2)		-			
Sound power level	Cooling	dB(A)	58		59		
	Heating		58		60		
Sound pressure level	Cooling	dB(A)	Hi: 45 Me: 36 Lo: 23		48		
	Heating		Hi: 44 Me: 36 Lo: 28		48		
Silent mode sound pressure level			-		-		
Exterior dimensions (Height x Width x Depth)	mm		267 x 783 x 210		540 x 645(+57) x 275		
Exterior appearance (Equivalent color)			Fine snow Munsell : (8.0Y 9.3/0.1), RAL : 9003		Stucco white Munsell : (4.2Y 7.5/1.1), RAL : 7044		
Net weight	kg		7.0		28.5		
Compressor type & Quantity			-		RM-C5077SBE7(Rotary type) x 1		
Compressor motor (Starting method)	kW		-		0.75 (Inverter driven)		
Refrigerant oil (Amount, type)	ℓ		-		0.3 (DIAMOND FREEZE MB75)		
Refrigerant (Type, amount, pre-charge length)	kg		R32 0.68 in outdoor unit (Incl. the amount for the piping of 15m)				
Heat exchanger			Louver fins & inner grooved tubing		M fins & inner grooved tubing		
Refrigerant control			Capillary tubes + Electronic expansion valve				
Fan type & Quantity			Tangential fan x 1		Propeller fan x 1		
Fan motor (Starting method)	W		30 x1 (Direct drive)		24 x1 (Direct drive)		
Air flow	Cooling	m ³ /min	Hi: 9.5 Me: 6.8 Lo: 4.2		22.8		
	Heating		Hi: 9.6 Me: 7.4 Lo: 5.5		22.0		
Available external static pressure	Pa		0		0		
Outside air intake			Not possible		-		
Air filter, Quality / Quantity			Polypropylene net (Washable)		-		
Shock & vibration absorber			Rubber sleeve (for fan motor)		Rubber sleeve (for fan motor & compressor)		
Electric heater			-		-		
Operation control	Remote control		Wireless remote control				
	Room temperature control		Microcomputer thermostat				
	Operation display		RUN: Green , TIMER: Yellow				
Safety equipments			Compressor overheat protection, Overcurrent protection, Frost protection, Serial signal error protection, Indoor fan motor error protection, Heating overload protection(High pressure control), Cooling overload protection				
Installation data	Refrigerant piping size (O.D)	mm	Liquid line: ϕ 6.35 (1/4")		Gas line: ϕ 9.52 (3/8")		
	Connecting method		Flare connection		Flare connection		
	Attached length of piping	m	Liquid line : 0.46 / Gas line : 0.39		-		
	Insulation for piping		Necessary (Both sides), independent				
	Refrigerant line (one way) length	m	Max.15				
	Vertical height diff. between O.U. and I.U.	m	Max.10 (Outdoor unit is higher) / Max.10 (Outdoor unit is lower)				
Drain hose			Hose connectable (VP16)		Hole ϕ 20 x 2 pcs.		
Drain pump, max lift height	mm		-		-		
Recommended breaker size	A		16				
L.R.A. (Locked rotor ampere)	A		4.5 / 4.3 / 4.2 (220/ 230/ 240 V)				
Interconnecting wires	Size x Core number		1.5mm ² × 4 cores (Including earth cable) / Terminal block (Screw fixing type)				
IP number			IPX0		IPX4		
Standard accessories			Mounting kit				
Option parts			-				
Notes (1) The data are measured at the following conditions.			The pipe length is 5m.				
Operation	Item	Indoor air temperature		Outdoor air temperature		Standards	
		DB	WB	DB	WB		
	Cooling	27°C	19°C	35°C	24°C		
	Heating	20°C	-	7°C	6°C		
Heating (H2)	20°C	-	2°C	1°C	ISO5151-H2		
(2) This air-conditioner is manufactured and tested in conformity with the ISO.							
(3) Sound level indicates the value in an anechoic chamber. During operation these values are somewhat higher due to ambient conditions.							
(4) Select the breaker size according to the own national standard.							

Model SRK45ZSP-W

Item		Model	SRK45ZSP-W				
			Indoor unit SRK45ZSP-W		Outdoor unit SRC45ZSP-W		
Power source			1 Phase, 220 - 240V, 50Hz				
Operation data	Nominal cooling capacity (range)	kW	4.5 (1.3 (Min.) - 4.8 (Max.))				
	Nominal heating capacity (range)	kW	5.0 (1.2 (Min.) - 5.8 (Max.))				
	Heating capacity (H2)	kW	-				
	Power consumption	Cooling	kW	1.350 (0.29 - 1.71)			
		Heating		1.360 (0.27 - 1.84)			
	Max power consumption	Heating (H2)	kW	-			
		Heating (H2)		2.68			
	Running current	Cooling	A	6.3 / 6.1 / 5.8 (220/ 230/ 240 V)			
		Heating		6.4 / 6.1 / 5.8 (220/ 230/ 240 V)			
	Inrush current, max current			6.4 / 6.1 / 5.8 (220/ 230/ 240 V) Max. 14.5			
	Power factor	Cooling	%	97			
		Heating		97			
	EER	Cooling		3.33			
	COP	Heating		3.68			
		Heating (H2)		-			
Sound power level	Cooling	dB(A)	56		63		
	Heating		62		64		
Sound pressure level	Cooling	dB(A)	Hi: 44 Me: 39 Lo: 24		51		
	Heating		Hi: 48 Me: 41 Lo: 30		51		
Silent mode sound pressure level			-		-		
Exterior dimensions (Height x Width x Depth)	mm		267 x 783 x 210		595 x 780(+62) x 290		
Exterior appearance (Equivalent color)			Fine snow Munsell : (8.0Y 9.3/0.1), RAL : 9003		Stucco white Munsell : (4.2Y 7.5/1.1), RAL : 7044		
Net weight	kg		7.5		36.0		
Compressor type & Quantity			-		9RS102XDA21(Rotary type) x 1		
Compressor motor (Starting method)	kW		-		1.50 (Inverter driven)		
Refrigerant oil (Amount, type)	ℓ		-		0.32 (FW50S)		
Refrigerant (Type, amount, pre-charge length)	kg		R32 1.10 in outdoor unit (Incl. the amount for the piping of 15m)				
Heat exchanger			Louver fins & inner grooved tubing		M fins & inner grooved tubing		
Refrigerant control			Capillary tubes + Electronic expansion valve				
Fan type & Quantity			Tangential fan x 1		Propeller fan x 1		
Fan motor (Starting method)	W		30 × 1 (Direct drive)		24 × 1 (Direct drive)		
Air flow	Cooling	m ³ /min	Hi: 9.0 Me: 7.2 Lo: 3.8		35.6		
	Heating		Hi: 12.0 Me: 9.2 Lo: 6.2		33.4		
Available external static pressure	Pa		0		0		
Outside air intake			Not possible		-		
Air filter, Quality / Quantity			Polypropylene net (Washable)		-		
Shock & vibration absorber			Rubber sleeve (for fan motor)		Rubber sleeve (for fan motor & compressor)		
Electric heater			-		-		
Operation control	Remote control		Wireless remote control				
	Room temperature control		Microcomputer thermostat				
	Operation display		RUN: Green , TIMER: Yellow				
Safety equipments			Compressor overheat protection, Overcurrent protection, Frost protection, Serial signal error protection, Indoor fan motor error protection, Heating overload protection(High pressure control), Cooling overload protection				
Installation data	Refrigerant piping size (O.D)	mm	Liquid line: ϕ 6.35 (1/4")		Gas line: ϕ 12.7 (1/2")		
	Connecting method		Flare connection		Flare connection		
	Attached length of piping	m	Liquid line : 0.46 / Gas line : 0.39		-		
	Insulation for piping		Necessary (Both sides), independent				
	Refrigerant line (one way) length	m	Max.25				
	Vertical height diff. between O.U. and I.U.	m	Max.15 (Outdoor unit is higher) / Max.15 (Outdoor unit is lower)				
Drain hose			Hose connectable (VP16)		Hole ϕ 20 x 2 pcs.		
Drain pump, max lift height	mm		-		-		
Recommended breaker size	A		20				
L.R.A. (Locked rotor ampere)	A		6.4 / 6.1 / 5.8 (220/ 230/ 240 V)				
Interconnecting wires	Size x Core number		1.5mm ² × 4 cores (Including earth cable) / Terminal block (Screw fixing type)				
IP number			IPX0		IPX4		
Standard accessories			Mounting kit				
Option parts			-				
Notes (1) The data are measured at the following conditions.			The pipe length is 5m.				
	Item	Indoor air temperature	Outdoor air temperature		Standards		
Operation		DB	WB	DB	WB		
	Cooling	27°C	19°C	35°C	24°C	ISO5151-T1	
	Heating	20°C	-	7°C	6°C	ISO5151-H1	
	Heating (H2)	20°C	-	2°C	1°C	ISO5151-H2	
(2) This air-conditioner is manufactured and tested in conformity with the ISO.							
(3) Sound level indicates the value in an anechoic chamber. During operation these values are somewhat higher due to ambient conditions.							
(4) Select the breaker size according to the own national standard.							

Model SRK50ZSP-W

Item		Model	SRK50ZSP-W				
			Indoor unit SRK50ZSP-W		Outdoor unit SRC50ZSP-W		
Power source			1 Phase, 220 - 240V, 50Hz				
Operation data	Nominal cooling capacity (range)	kW	5.0 (1.3 (Min.) - 5.2 (Max.))				
	Nominal heating capacity (range)	kW	5.6 (1.2 (Min.) - 5.8 (Max.))				
	Heating capacity (H2)	kW	-				
	Power consumption	Cooling	kW	1.740 (0.29 - 1.86)			
		Heating		1.660 (0.27 - 1.84)			
	Heating (H2)	-					
	Max power consumption		2.68				
	Running current	Cooling	A	7.9 / 7.6 / 7.3 (220/ 230/ 240 V)			
		Heating		7.6 / 7.3 / 7.0 (220/ 230/ 240 V)			
	Inrush current, max current			7.9 / 7.6 / 7.3 (220/ 230/ 240 V) Max. 14.5			
	Power factor	Cooling	%	99			
		Heating		99			
	EER	Cooling		2.87			
	COP	Heating		3.37			
		Heating (H2)		-			
Sound power level	Cooling	dB(A)	59		65		
	Heating		63		66		
Sound pressure level	Cooling		Hi: 46 Me: 39 Lo: 24		52		
	Heating		Hi: 48 Me: 41 Lo: 30		52		
Silent mode sound pressure level			-		-		
Exterior dimensions (Height x Width x Depth)	mm		267 x 783 x 210		595 x 780(+62) x 290		
Exterior appearance (Equivalent color)			Fine snow Munsell : (8.0Y 9.3/0.1), RAL : 9003		Stucco white Munsell : (4.2Y 7.5/1.1), RAL : 7044		
Net weight	kg		7.5		36.0		
Compressor type & Quantity			-		9RS102XDA21(Rotary type) x 1		
Compressor motor (Starting method)	kW		-		1.50 (Inverter driven)		
Refrigerant oil (Amount, type)	ℓ		-		0.32 (FW50S)		
Refrigerant (Type, amount, pre-charge length)	kg		R32 1.10 in outdoor unit (Incl. the amount for the piping of 15m)				
Heat exchanger			Louver fins & inner grooved tubing		M fins & inner grooved tubing		
Refrigerant control			Capillary tubes + Electronic expansion valve				
Fan type & Quantity			Tangential fan x 1		Propeller fan x 1		
Fan motor (Starting method)	W		30 × 1 (Direct drive)		24 × 1 (Direct drive)		
Air flow	Cooling	m ³ /min	Hi: 9.9 Me: 7.2 Lo: 3.8		37.7		
	Heating		Hi: 12.0 Me: 9.2 Lo: 6.2		35.6		
Available external static pressure	Pa		0		0		
Outside air intake			Not possible		-		
Air filter, Quality / Quantity			Polypropylene net (Washable)		-		
Shock & vibration absorber			Rubber sleeve (for fan motor)		Rubber sleeve (for fan motor & compressor)		
Electric heater			-		-		
Operation control	Remote control		Wireless remote control				
	Room temperature control		Microcomputer thermostat				
	Operation display		RUN: Green , TIMER: Yellow				
Safety equipments			Compressor overheat protection, Overcurrent protection, Frost protection, Serial signal error protection, Indoor fan motor error protection, Heating overload protection(High pressure control), Cooling overload protection				
Installation data	Refrigerant piping size (O.D)	mm	Liquid line: ϕ 6.35 (1/4")		Gas line: ϕ 12.7 (1/2")		
	Connecting method		Flare connection		Flare connection		
	Attached length of piping	m	Liquid line : 0.46 / Gas line : 0.39		-		
	Insulation for piping		Necessary (Both sides), independent				
	Refrigerant line (one way) length	m	Max.25				
	Vertical height diff. between O.U. and I.U.	m	Max.15 (Outdoor unit is higher) / Max.15 (Outdoor unit is lower)				
Drain hose			Hose connectable (VP16)		Hole ϕ 20 x 2 pcs.		
Drain pump, max lift height	mm		-		-		
Recommended breaker size	A		20				
L.R.A. (Locked rotor ampere)	A		7.9 / 7.6 / 7.3 (220/ 230/ 240 V)				
Interconnecting wires	Size x Core number		1.5mm ² × 4 cores (Including earth cable) / Terminal block (Screw fixing type)				
IP number			IPX0		IPX4		
Standard accessories			Mounting kit				
Option parts			-				
Notes (1) The data are measured at the following conditions.			The pipe length is 5m.				
Operation	Item	Indoor air temperature		Outdoor air temperature		Standards	
		DB	WB	DB	WB		
	Cooling	27°C	19°C	35°C	24°C	ISO5151-T1	
	Heating	20°C	-	7°C	6°C	ISO5151-H1	
Heating (H2)	20°C	-	2°C	1°C	ISO5151-H2		
(2) This air-conditioner is manufactured and tested in conformity with the ISO.							
(3) Sound level indicates the value in an anechoic chamber. During operation these values are somewhat higher due to ambient conditions.							
(4) Select the breaker size according to the own national standard.							

Weight list (Package)

【Indoor unit & outdoor unit】

Unit : kg

Material Model		Gross weight	Packing parts weight	Paper	Foam poly-styrene	Plastic	Steel	Aluminium	Wood	Glass	Others
Indoor	SRK25ZSP-W	9.0	0.94	0.64	0.24	0.06	0.00	0.00	0.00	0.00	0.00
	SRK35ZSP-W	9.0	0.94	0.64	0.24	0.06	0.00	0.00	0.00	0.00	0.00
	SRK45ZSP-W	9.5	0.94	0.64	0.24	0.06	0.00	0.00	0.00	0.00	0.00
	SRK50ZSP-W	9.5	0.94	0.64	0.24	0.06	0.00	0.00	0.00	0.00	0.00
Outdoor	SRC25ZSP-W	28.0	1.64	1.36	0.24	0.04	0.00	0.00	0.00	0.00	0.00
	SRC35ZSP-W	30.0	1.64	1.36	0.24	0.04	0.00	0.00	0.00	0.00	0.00
	SRC45ZSP-W	38.0	2.13	1.78	0.27	0.08	0.00	0.00	0.00	0.00	0.00
	SRC50ZSP-W	38.0	2.13	1.78	0.27	0.08	0.00	0.00	0.00	0.00	0.00

2. EXTERIOR DIMENSIONS

(1) Indoor units

Models SRK25ZSP-W, 35ZSP-W, 45ZSP-W, 50ZSP-W

Symbol	Content
A	Gas piping SRK25,35 $\phi 9.52 (3/8")$ (Flare) SRK45,50 $\phi 12.7 (1/2")$ (Flare)
B	Liquid piping $\phi 6.35 (1/4")$ (Flare)
C	Hole on wall for right rear piping ($\phi 65$)
D	Hole on wall for left rear piping ($\phi 65$)
E	Drain hose VP16
F	Outlet for wiring
G	Outlet for piping (on both side)

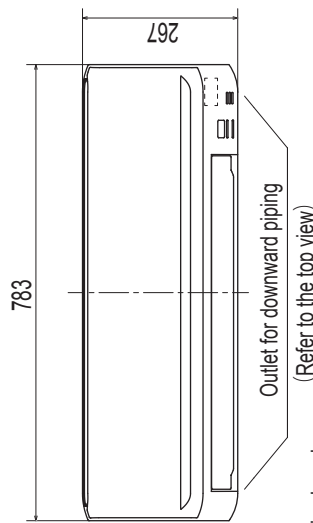
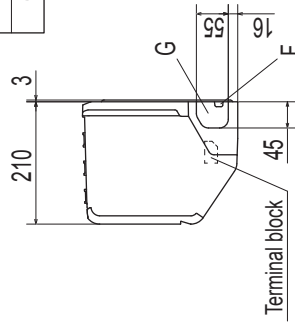
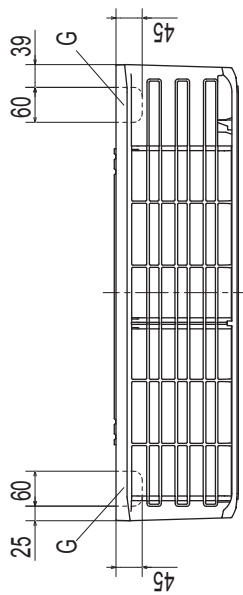

※	Service space	65
	Recommendation	80

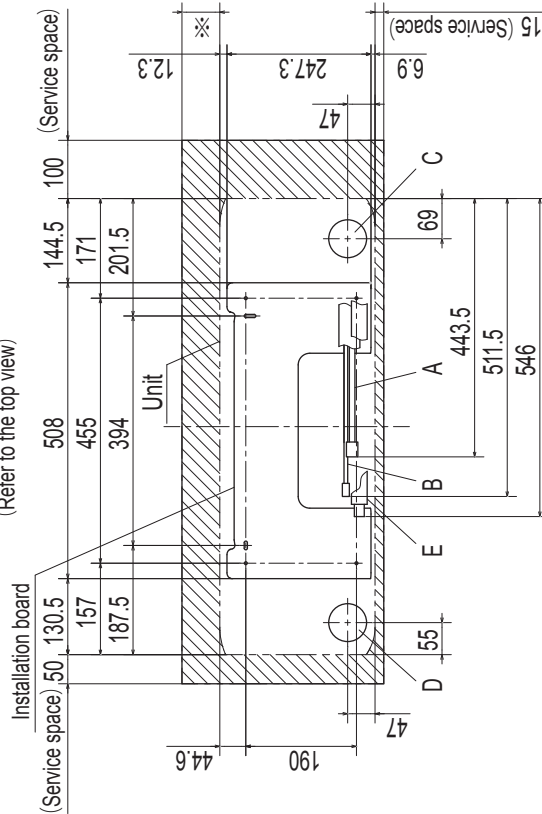

Space for installation and service when viewing from the front

Wireless remote control

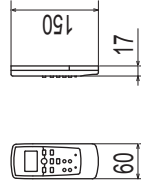

Note (1) The model name label is attached on the underside of the indoor unit.

Unit:mm

(2) Outdoor units
Models SRC25ZSP-W, 35ZSP-W

Notes

- (1) The unit must not be surrounded by walls on the four sides.
- (2) The unit must be fixed with anchor bolts.
- (3) An anchor bolt must not protrude more than 15mm.
- (4) If the unit is installed in the location where there is a possibility of strong winds, place the unit such that the direction of air from the outlet gets perpendicular to the wind direction.
- (5) Leave 200mm or more space above the unit.
- (6) The wall height on the outlet side should be 1200mm or less.

Symbol	Content
A	Service valve connection (gas side) φ9.52 (3/8") (Flare)
B	Service valve connection (liquid side) φ6.35 (1/4") (Flare)
C	Pipe/cable draw-out hole
D	Drain discharge hole φ20 × 2 places
E	Anchor bolt hole M10-12 × 4 places

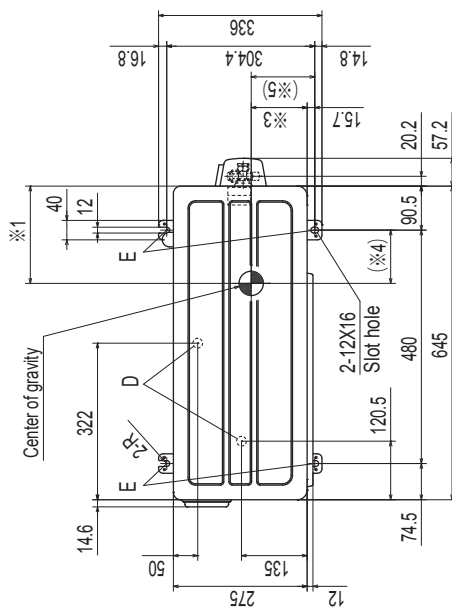

Dimensions	※1	※2	※3	※4	※5
Model					
SRC25ZSP-W	200	240	115	109.5	130.7
SRC35ZSP-W	215	240	140	124.5	155.7

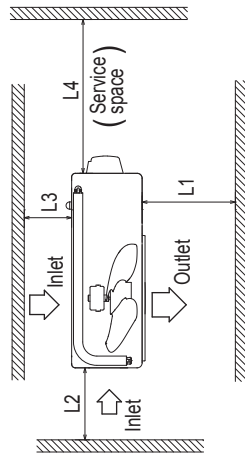

Installation space (mm)	Value
L1	280 or more
L2	100 or more
L3	80 or more
L4	250 or more

Unit:mm

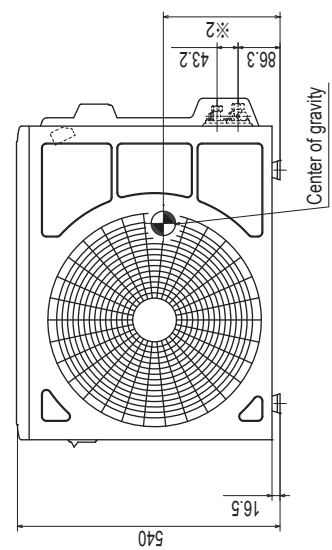
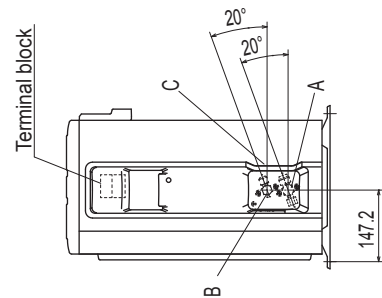

RCW000Z007

Models SRC45ZSP-W, 50ZSP-W

Notes

- (1) The unit must not be surrounded by walls on the four sides.
- (2) The unit must be fixed with walls on the four sides. An anchor bolt must not protrude more than 15mm.
- (3) If the unit is installed in the location where there is a possibility of strong winds, place the unit such that the direction of air from the outlet gets perpendicular to the wind direction.
- (4) Leave 200mm or more space above the unit.
- (5) The wall height on the outlet side should be 1200mm or less.
- (6) The model name label is attached on the right side of the unit.

Symbol	Content
A	Service valve connection (gas side) ϕ 12.7 (1/2") (Flare)
B	Service valve connection (liquid side) ϕ 6.35 (1/4") (Flare)
C	Pipe / cable draw-out hole
D	Drain discharge hole ϕ 20 x 2 places
E	Anchor bolt hole M10-12 x 4 places

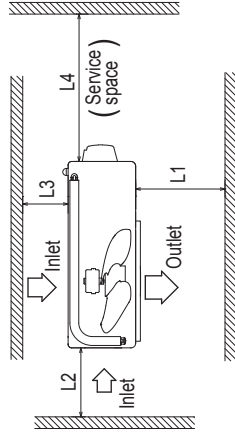
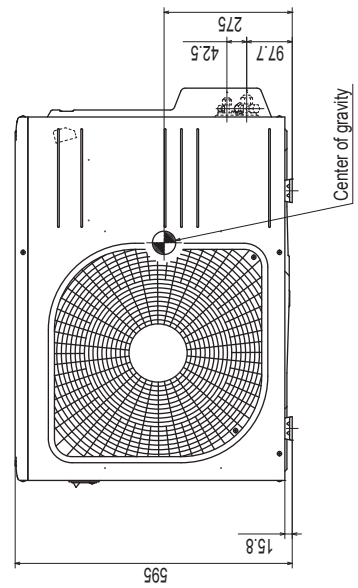
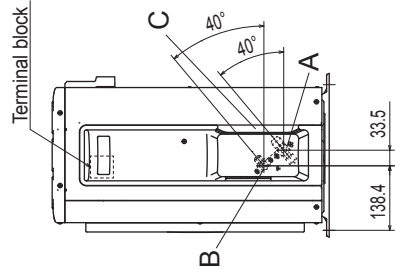
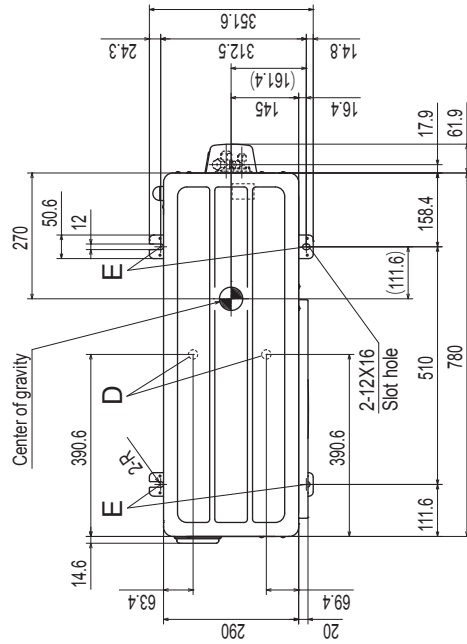

Installation space (mm)	
L1	280 or more
L2	100 or more
L3	80 or more
L4	250 or more

Unit:mm

RCV000Z038

(3) Wireless remote control

Unit: mm

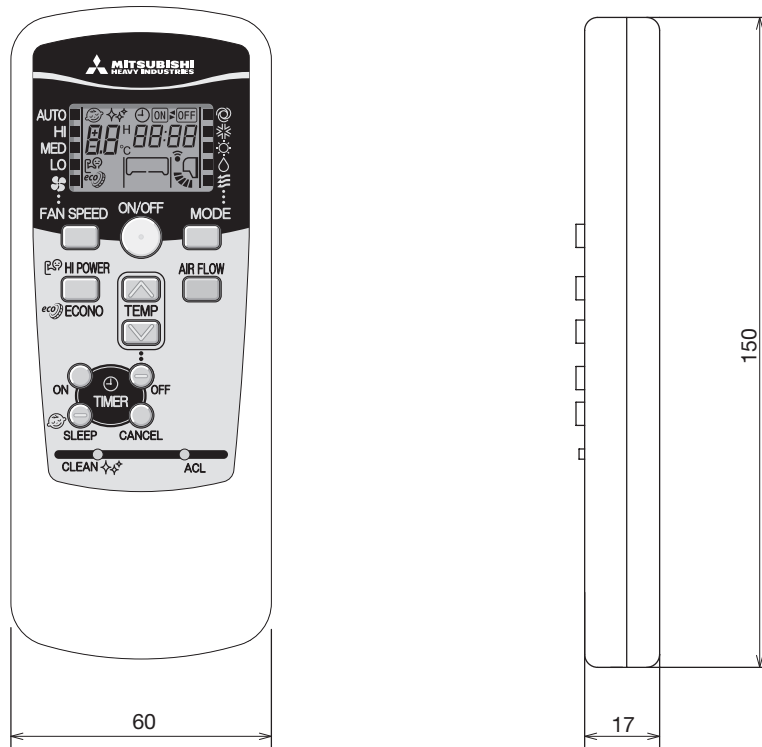

3. ELECTRICAL WIRING

(1) Indoor units

Models SRK25ZSP-W, 35ZSP-W, 45ZSP-W, 50ZSP-W

Meaning of marks	
Item	Description
CNE	Connector
CNF	
CNG	
CNM	
CNU	

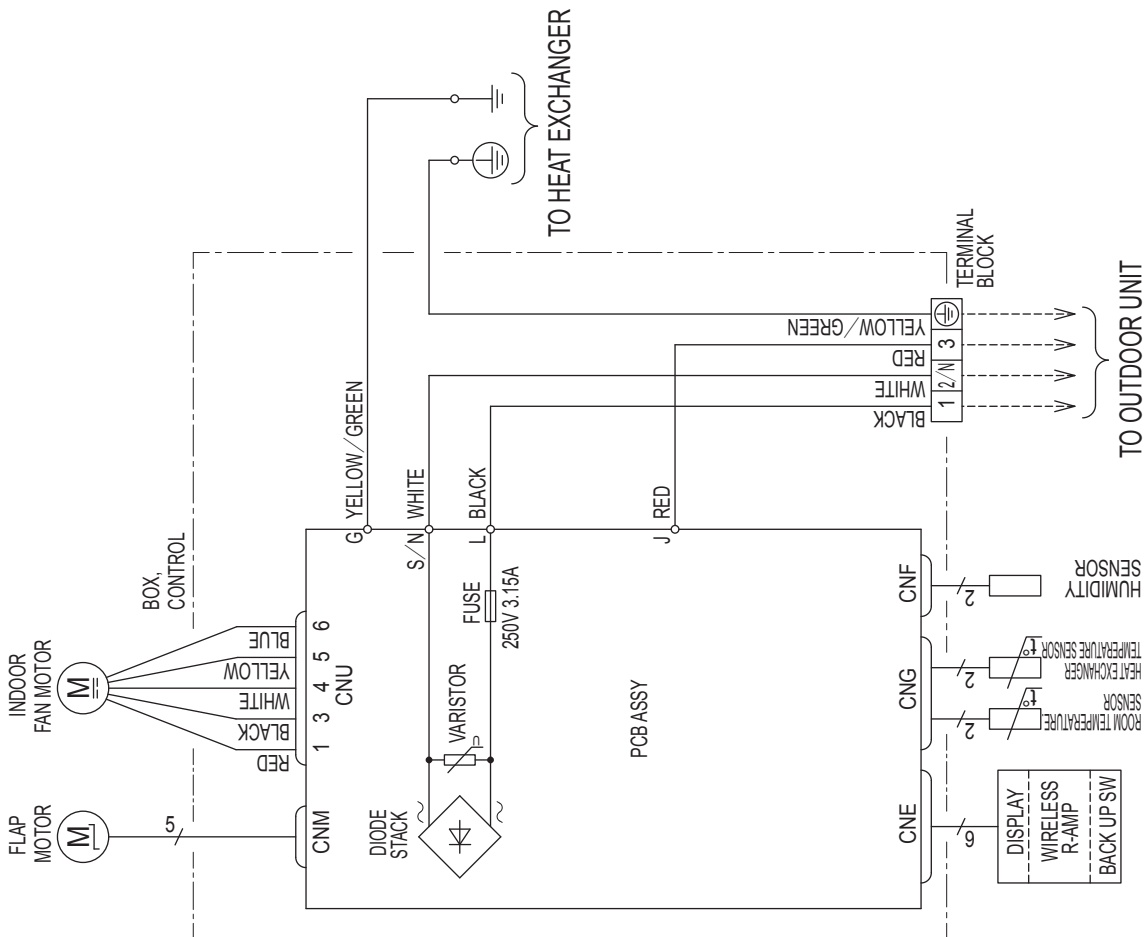

RLC000Z107

(2) Outdoor units
 Models SRC25ZSP-W, 35ZSP-W

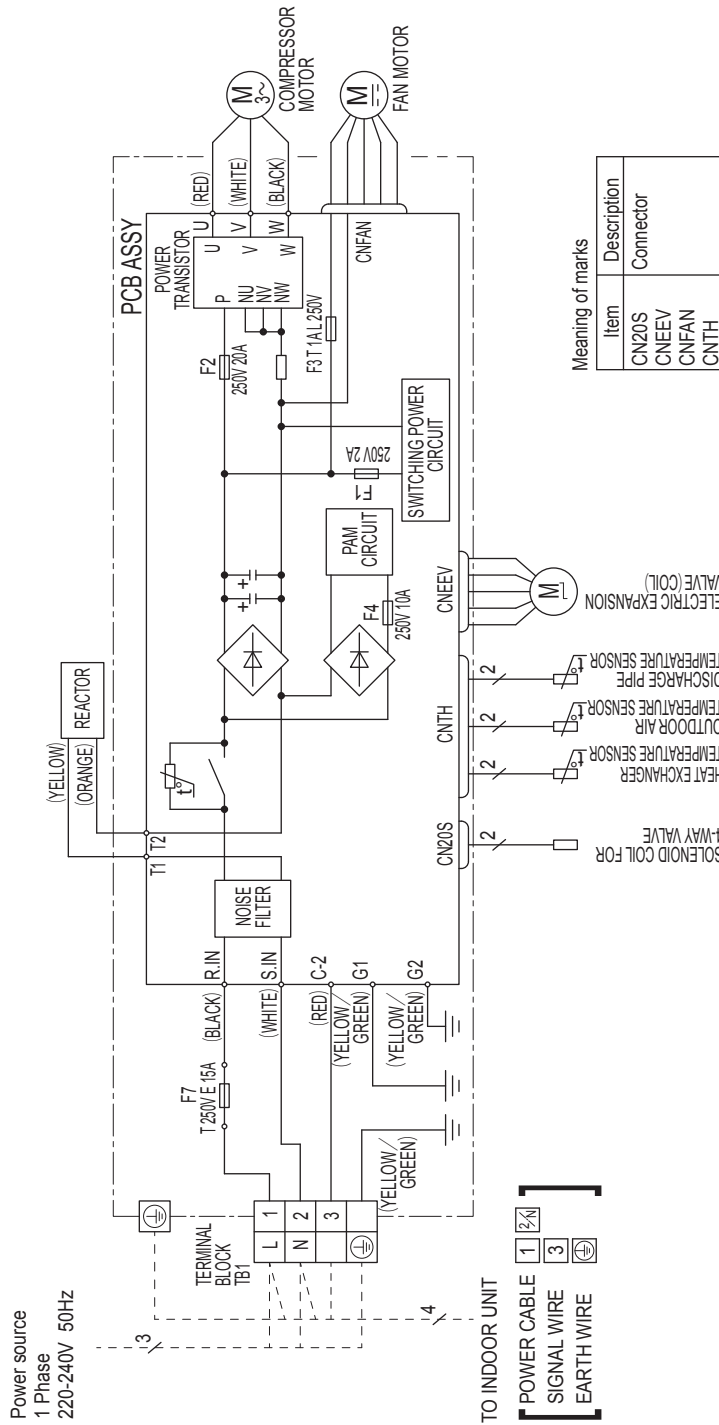

Power cable, indoor-outdoor connecting wires

Model	MAX running current (A)	Power cable wire size x number*	Power cable length (m)	Connecting cable wire size x number*
25.35	9	2.0mm ² x 3	22	1.5mm ² x 4

* The wire numbers include Earth wire (Yellow/Green).

• Switchgear or circuit breaker capacity should be chosen according to national or regional electricity regulations.

• The power cable specifications are based on the assumption that a metal or plastic conduit is used with no more than three cables contained in a conduit and a voltage drop is 2%. For an installation falling outside of these conditions, please follow the national or regional electricity regulations.

Models SRC45ZSP-W, 50ZSP-W

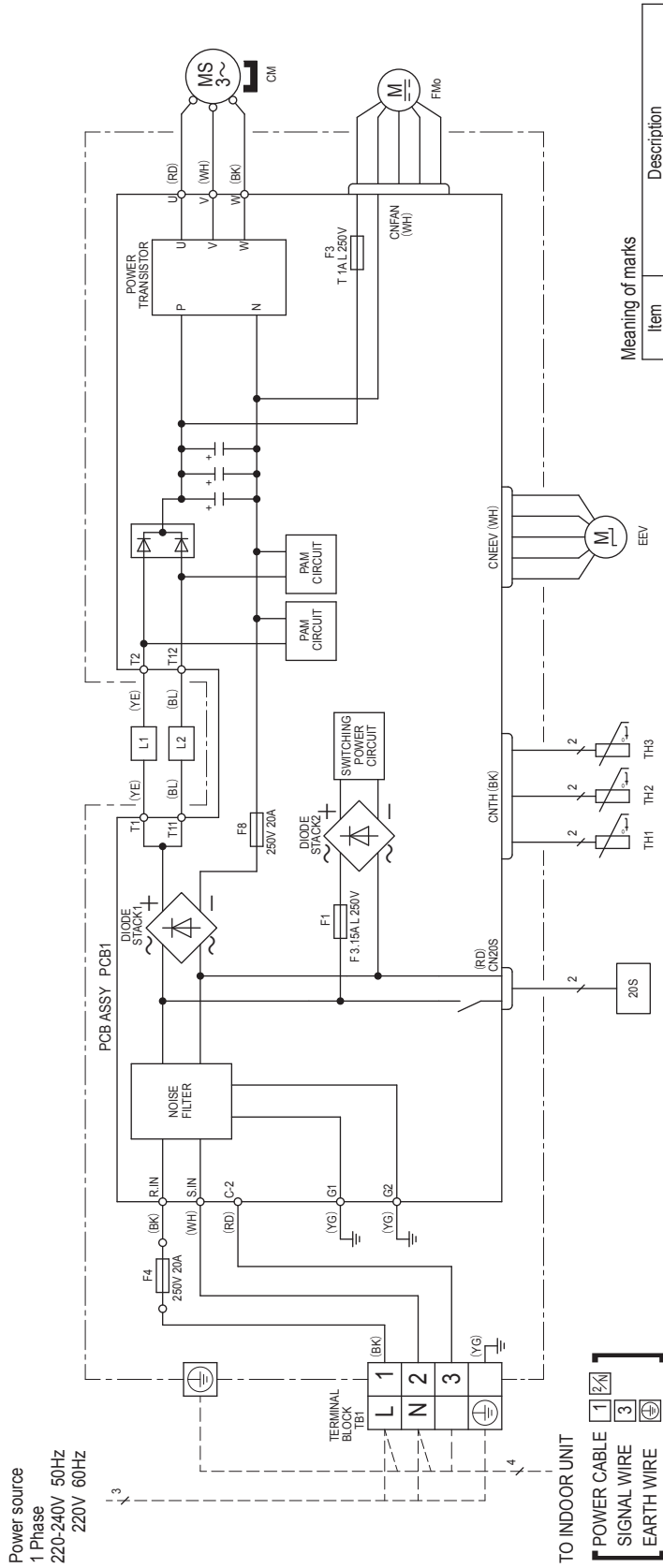

Meaning of marks

Item	Description
20S	4-way valve (coil)
CN20S	Connector
CNEEV	
CNFAN	
CNTH	
CM	Compressor motor
EEV	Electric expansion valve (coil)
FMo	Fan motor
L1,2	Reactor
TH1	Heat exchanger temperature sensor
TH2	Outdoor air temperature sensor
TH3	Discharge pipe temperature sensor

Color marks

Mark	Color
BK	Black
BL	Blue
RD	Red
WH	White
YE	Yellow
YG	Yellow / Green

Power cable, indoor-outdoor connecting wires

Model name	MAX running current (A)	Power cable wire size x number*	Power cable length (m)	Connecting cable wire size x number*
SRC45, 50ZSP-W	14.5	2.5mm ² x 3	17	1.5mm ² x 4

- * The wire numbers include Earth wire (Yellow / Green).
- * Switchgear or circuit breaker capacity should be chosen according to national or regional electricity regulations.
- * The power cable specifications are based on the assumption that a metal or plastic conduit is used with no more than three cables contained in a conduit and a voltage drop is 2%. For an installation falling outside of these conditions, please follow the national or regional electricity regulations.



Power source
1 Phase
220-240V 50/60Hz
220V 60Hz

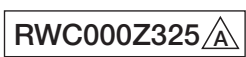

4. NOISE LEVEL

(1) Sound power level

Model SRK25ZSP-W

(Indoor unit)

Model	SRK25ZSP-W	
Noise level	Cooling	57 dB(A)
	Heating	57 dB(A)

Condition	ISO5151 T1/H1
MODE	Rated capacity value (Hi)

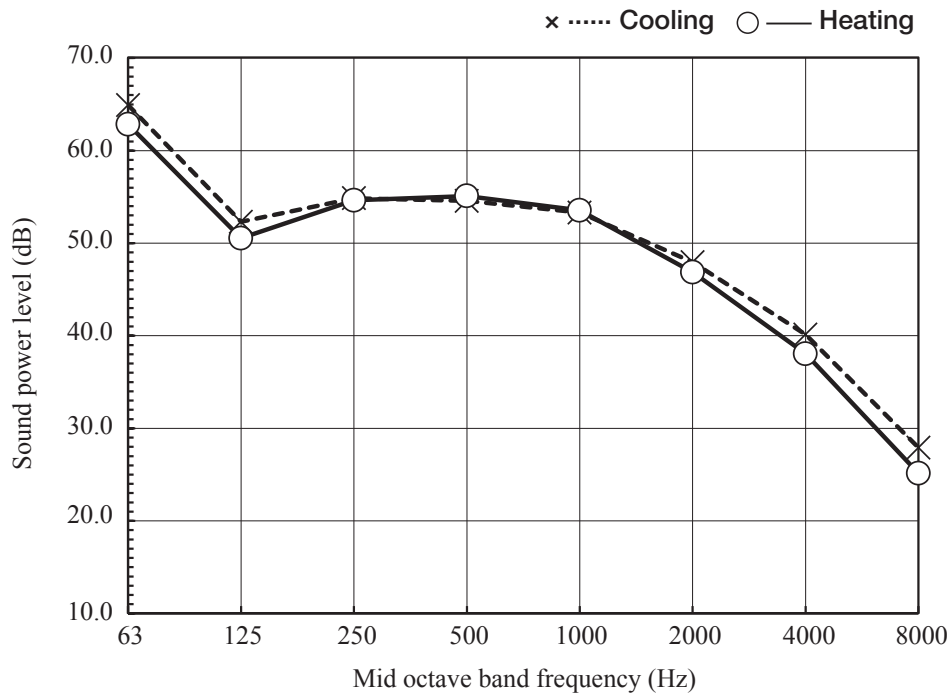

(Outdoor unit)

Model	SRC25ZSP-W	
Noise level	Cooling	57 dB(A)
	Heating	56 dB(A)

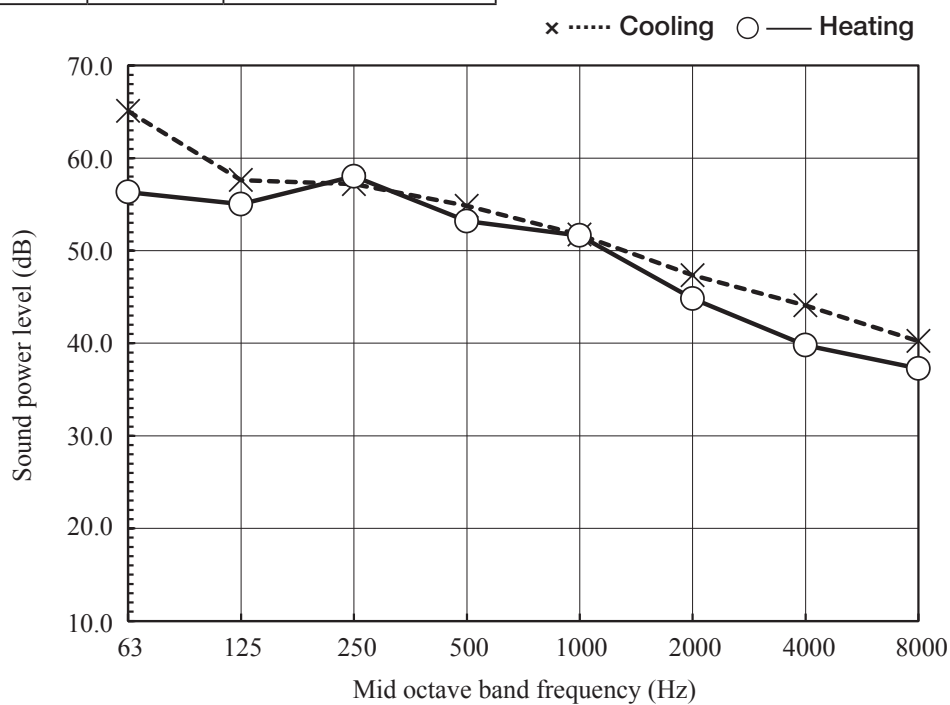

Model SRK35ZSP-W

(Indoor unit)

Model	SRK35ZSP-W	
Noise level	Cooling	58 dB(A)
	Heating	58 dB(A)

Condition	ISO5151 T1/H1
MODE	Rated capacity value (Hi)

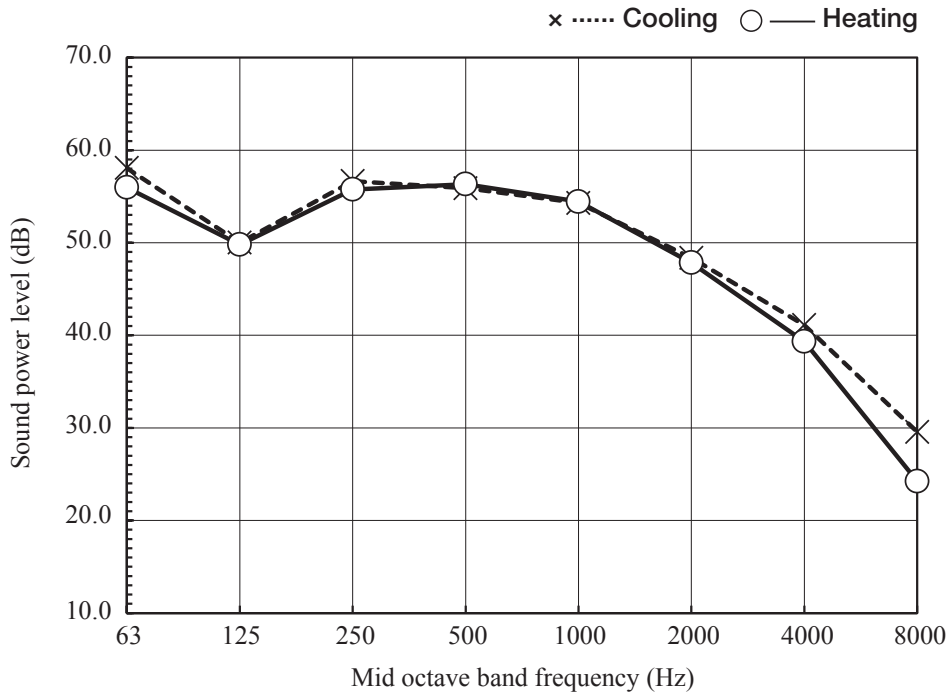

(Outdoor unit)

Model	SRC35ZSP-W	
Noise level	Cooling	59 dB(A)
	Heating	60 dB(A)

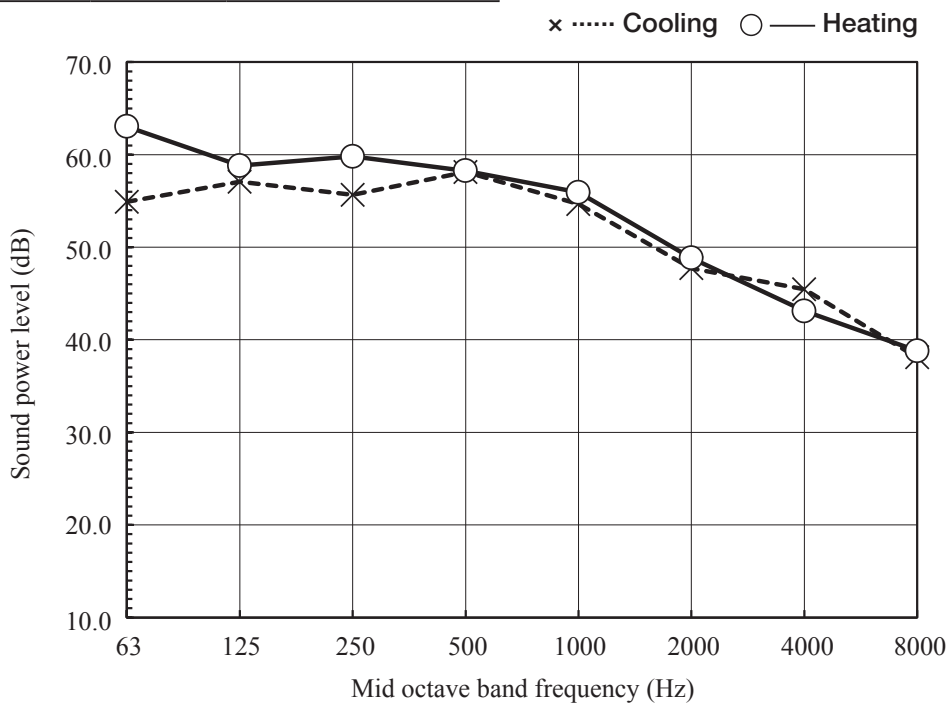

Model SRK45ZSP-W

(Indoor unit)

Model	SRK45ZSP-W	
Noise level	Cooling	56 dB(A)
	Heating	62 dB(A)

Condition	ISO5151 T1/H1
MODE	Rated capacity value (Hi)

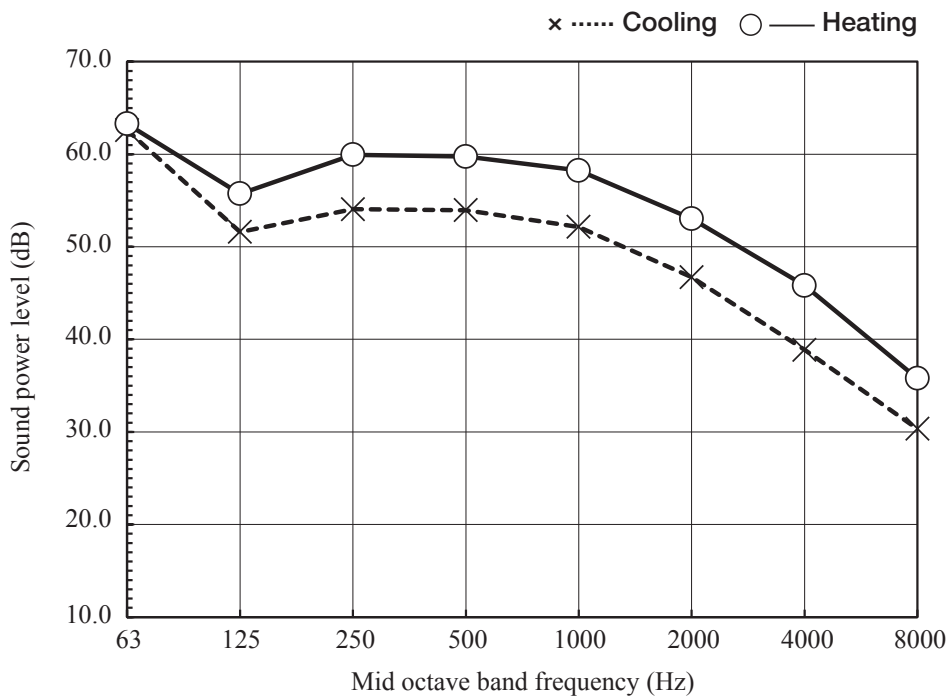

(Outdoor unit)

Model	SRC45ZSP-W	
Noise level	Cooling	63 dB(A)
	Heating	64 dB(A)

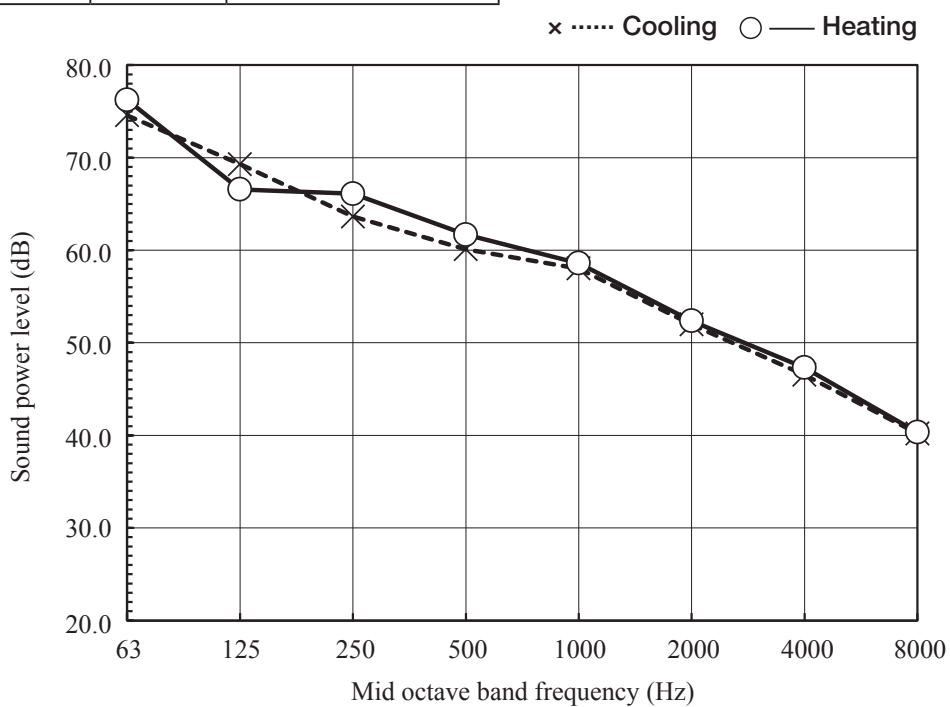

Model SRK50ZSP-W

(Indoor unit)

Model	SRK50ZSP-W	
Noise level	Cooling	59 dB(A)
	Heating	63 dB(A)

Condition	ISO5151 T1/H1
MODE	Rated capacity value (Hi)

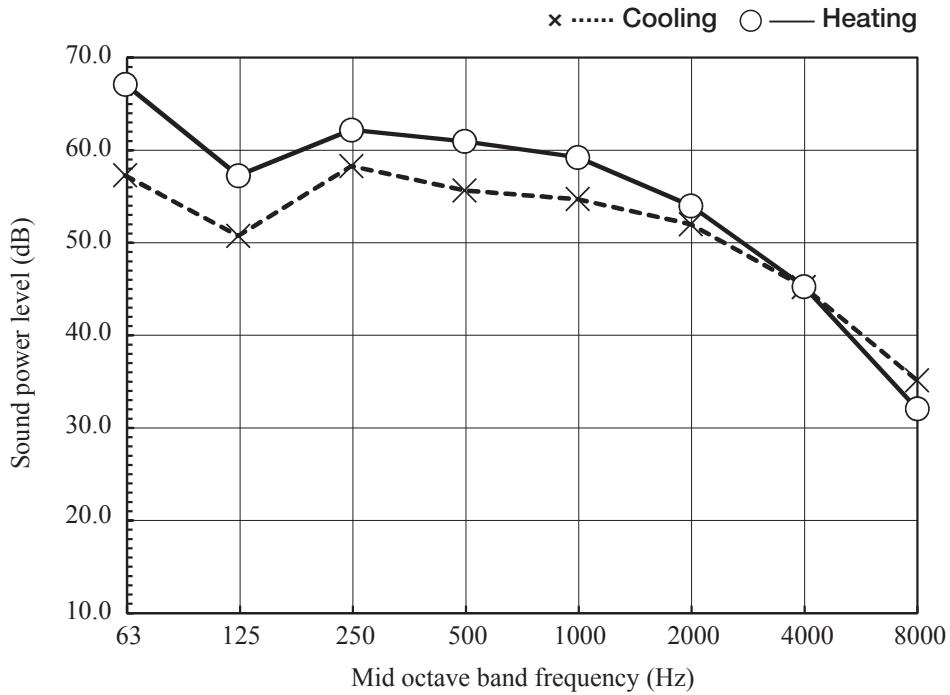

(Outdoor unit)

Model	SRC50ZSP-W	
Noise level	Cooling	65 dB(A)
	Heating	66 dB(A)

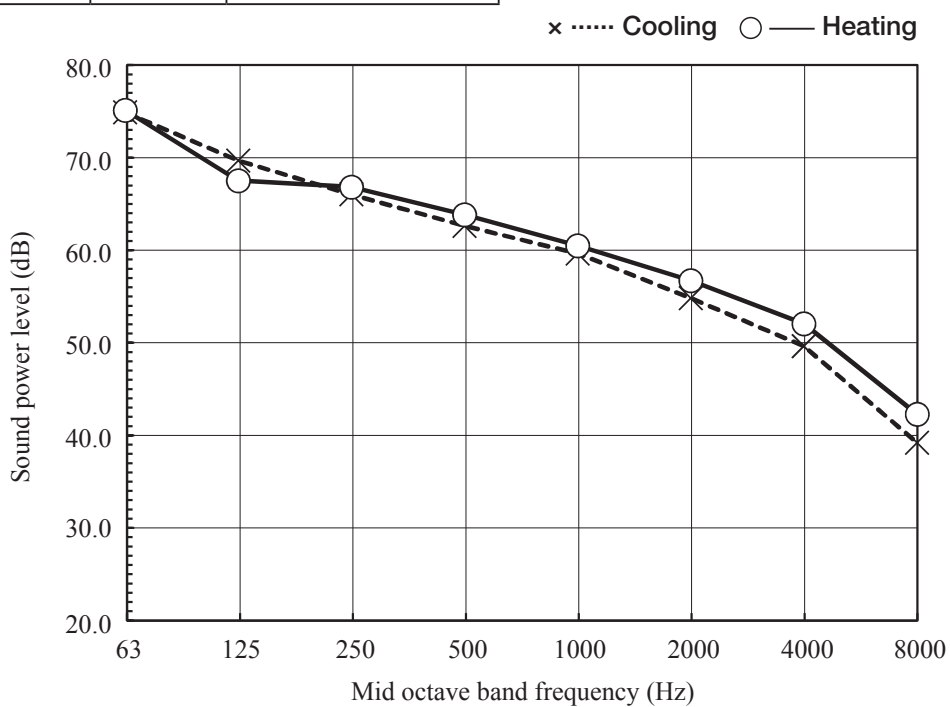

(2) Sound pressure level
 (a) Rated capacity value
 Model SRK25ZSP-W

Condition	ISO5151 T1/H1
MODE	Rated capacity value (Hi)

(Indoor unit)

Model	SRK25ZSP-W	
Noise level	Cooling	45 dB(A)
	Heating	43 dB(A)

● Mike position

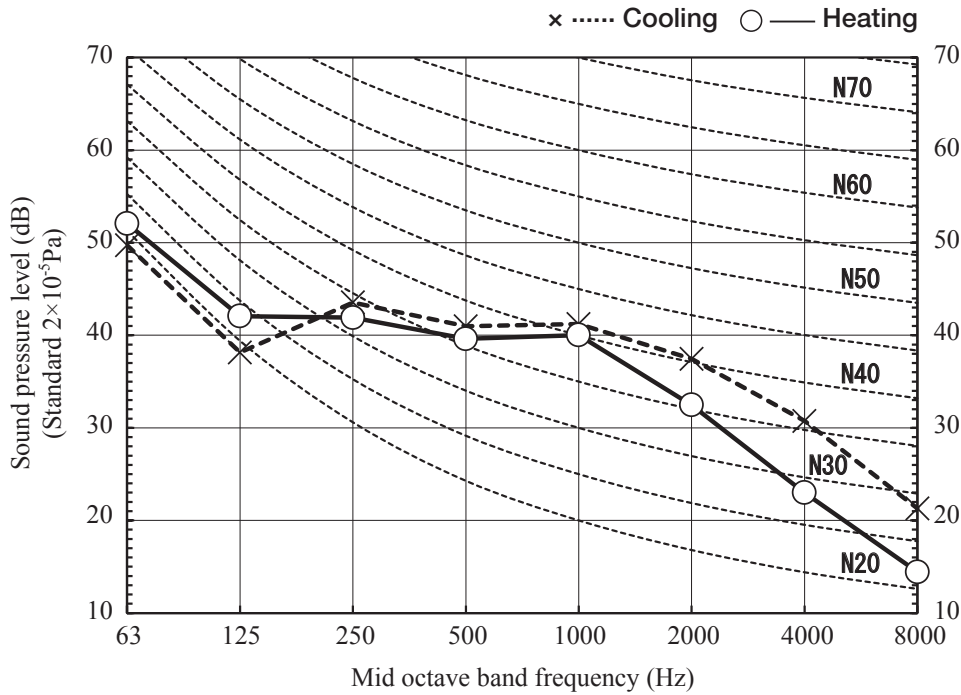

(Outdoor unit)

Model	SRC25ZSP-W	
Noise level	Cooling	47 dB(A)
	Heating	45 dB(A)

● Mike position: at highest noise level in position as mentioned below
 Distance from front side 1m

x Cooling o — Heating

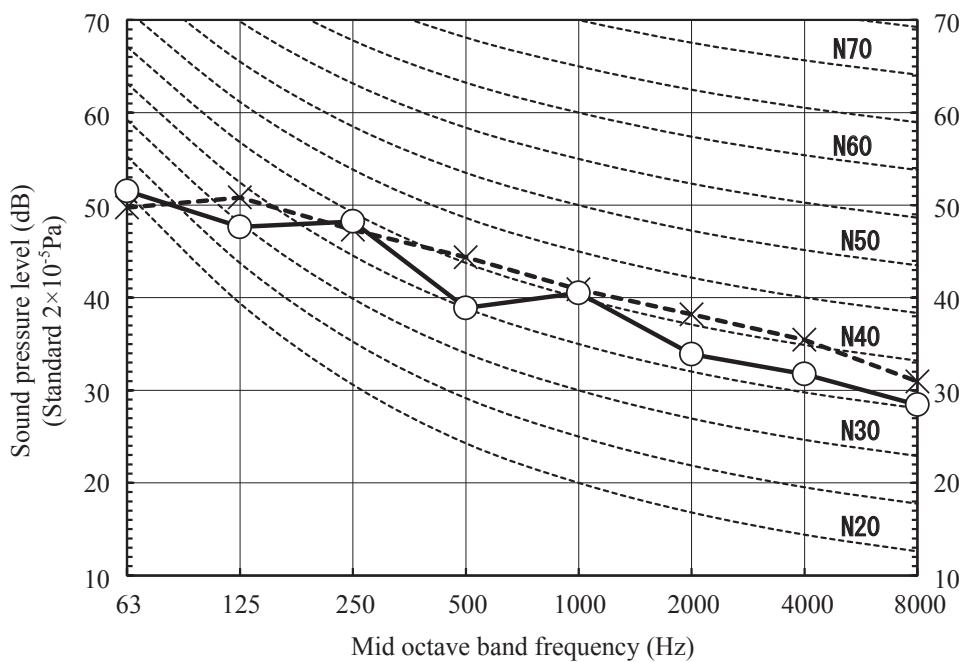

Model SRK35ZSP-W

(Indoor unit)

Model	SRK35ZSP-W	
Noise level	Cooling	45 dB(A)
	Heating	44 dB(A)

Condition	ISO5151 T1/H1
MODE	Rated capacity value (Hi)

● Mike position

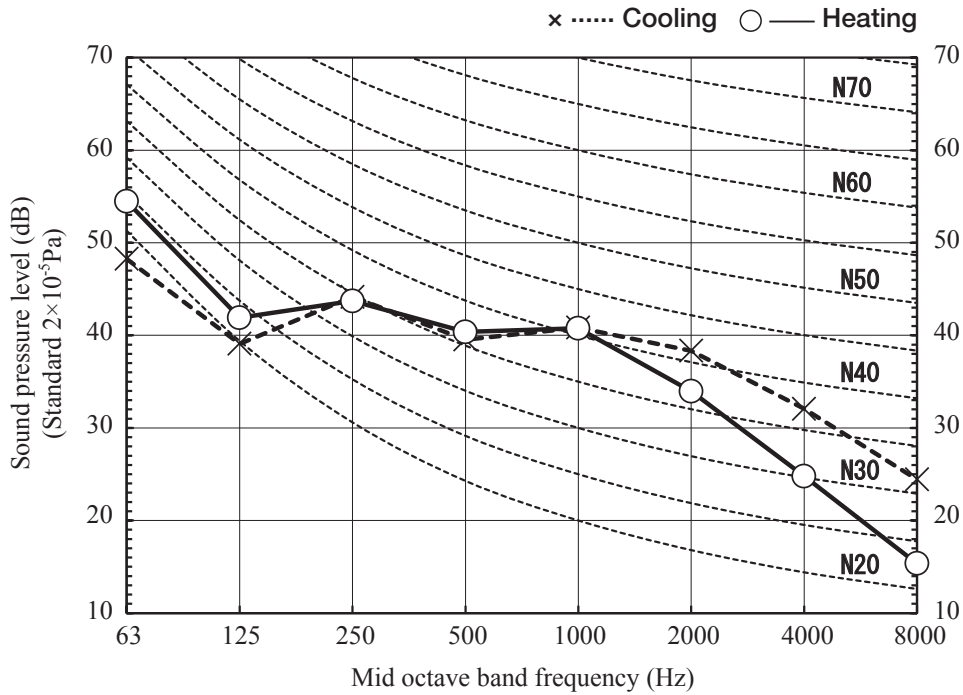

(Outdoor unit)

Model	SRC35ZSP-W	
Noise level	Cooling	48 dB(A)
	Heating	48 dB(A)

● Mike position: at highest noise level in position as mentioned below
Distance from front side 1m

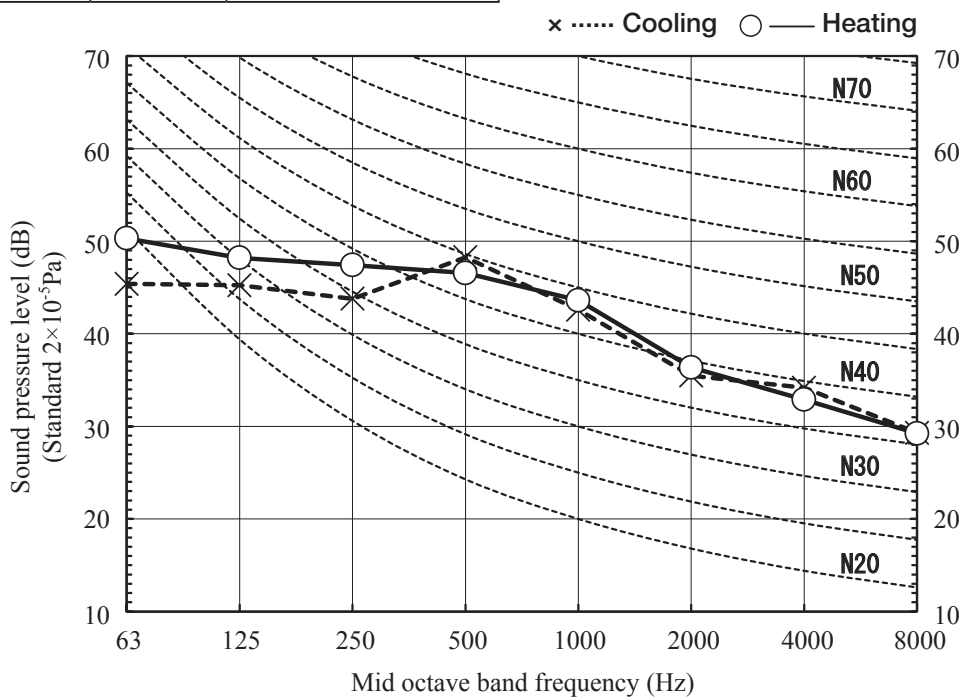

Model SRK45ZSP-W

(Indoor unit)

Model	SRK45ZSP-W	
Noise level	Cooling	44 dB(A)
	Heating	48 dB(A)

Condition	ISO5151 T1/H1
MODE	Rated capacity value (Hi)

● Mike position

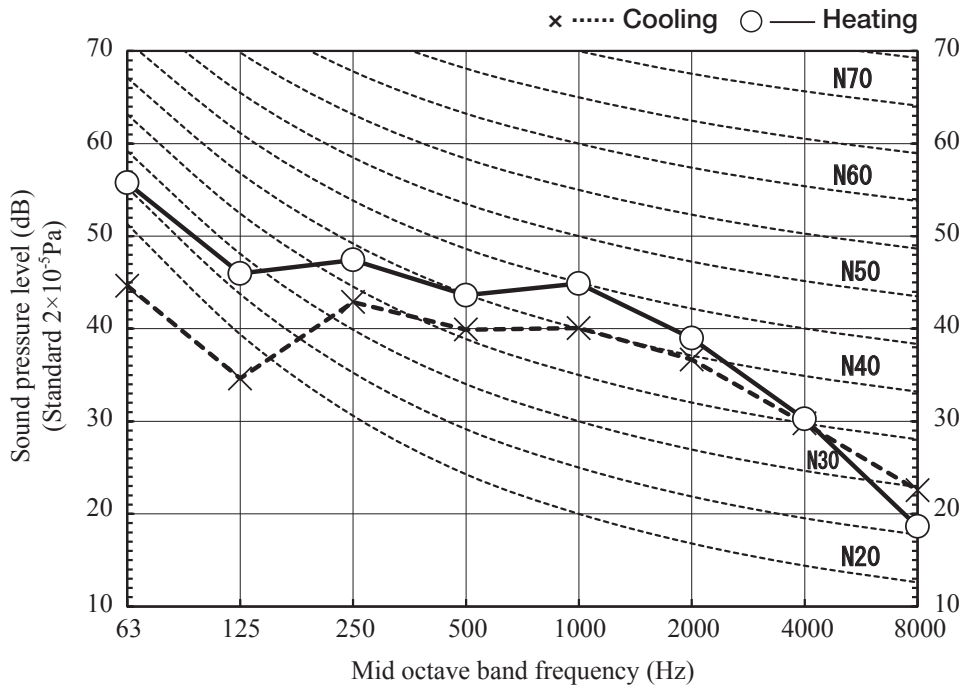

(Outdoor unit)

Model	SRC45ZSP-W	
Noise level	Cooling	51 dB(A)
	Heating	51 dB(A)

● Mike position: at highest noise level in position as mentioned below
Distance from front side 1m

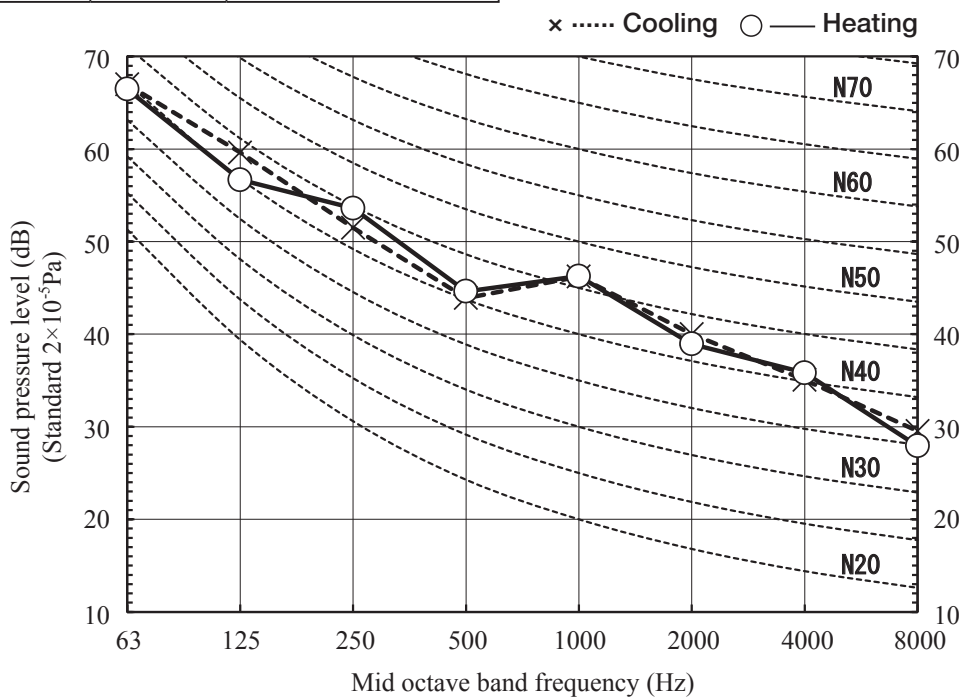

Model SRK50ZSP-W

(Indoor unit)

Model	SRK50ZSP-W	
Noise level	Cooling	46 dB(A)
	Heating	48 dB(A)

Condition	ISO5151 T1/H1
MODE	Rated capacity value (Hi)

● Mike position

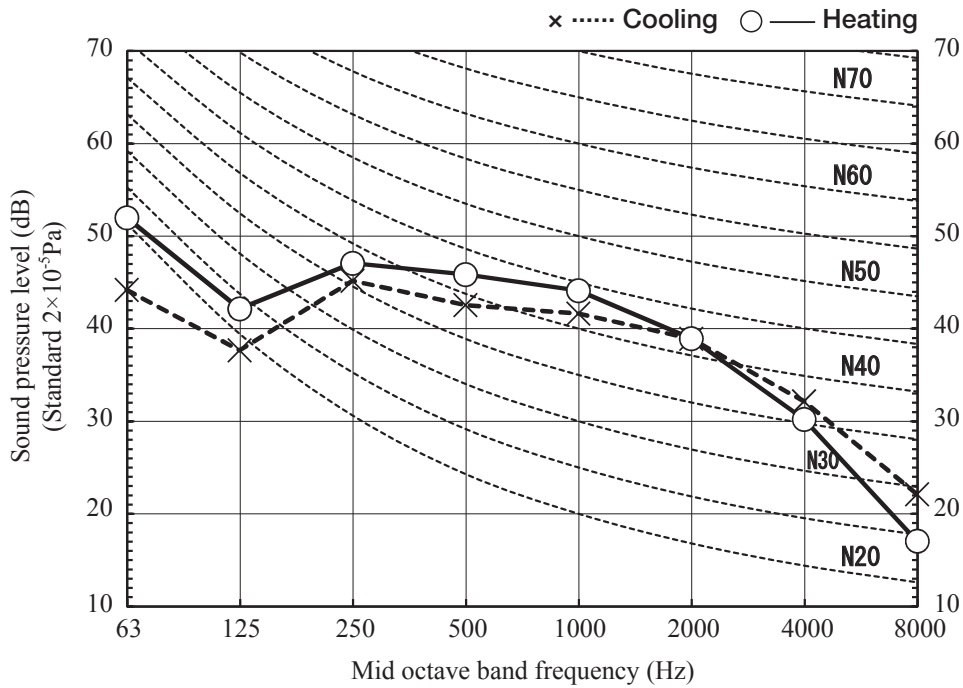

(Outdoor unit)

Model	SRC50ZSP-W	
Noise level	Cooling	52 dB(A)
	Heating	52 dB(A)

● Mike position: at highest noise level in position as mentioned below
Distance from front side 1m

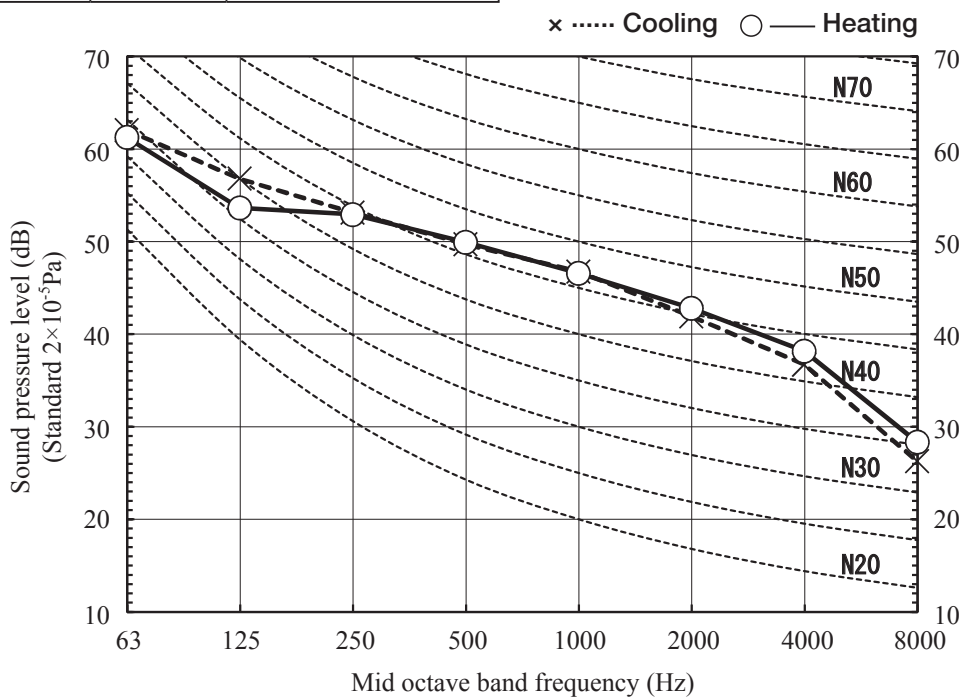

(b) Each fan speed mode

Condition	ISO5151 T1/H1
-----------	---------------

MODE	Me
------	----

(Indoor unit)

Model	SRK25ZSP-W	
Noise level	Cooling	34 dB(A)
	Heating	34 dB(A)

● Mike position

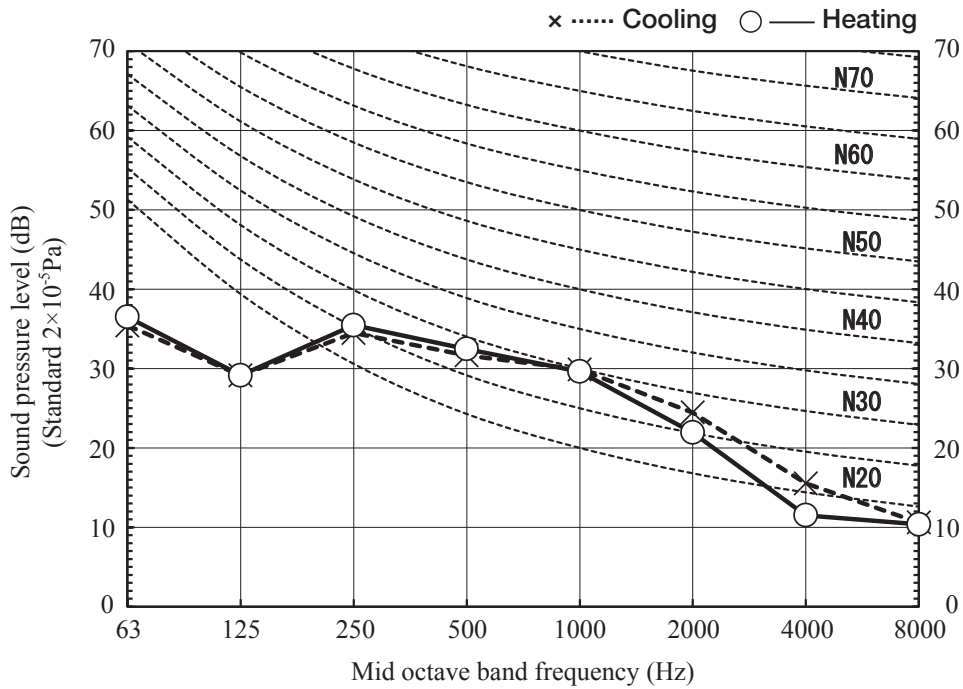

(Indoor unit)

Model	SRK25ZSP-W	
Noise level	Cooling	23 dB(A)
	Heating	26 dB(A)

MODE	Lo
------	----

● Mike position

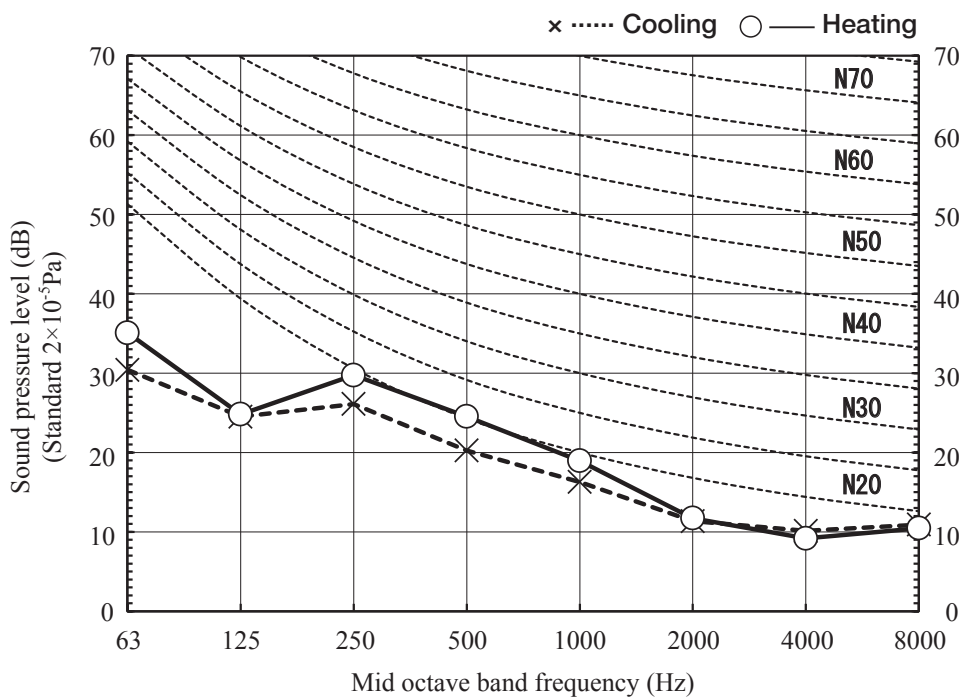

(Indoor unit)

Model	SRK35ZSP-W	
Noise level	Cooling	36 dB(A)
	Heating	36 dB(A)

Condition	ISO5151 T1/H1
-----------	---------------

MODE	Me
------	----

● Mike position

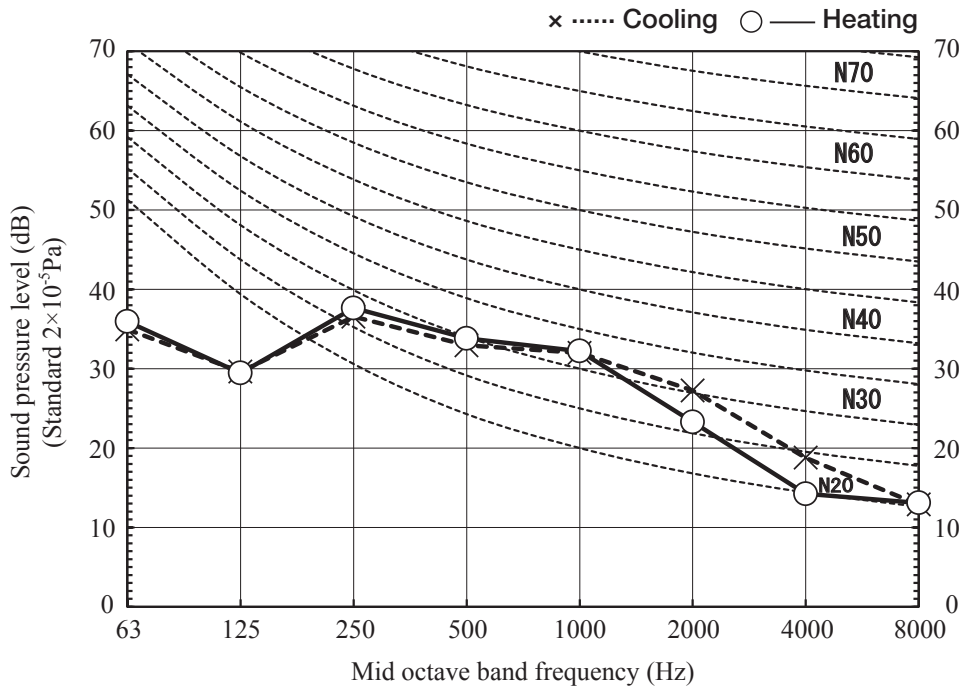

(Indoor unit)

Model	SRK35ZSP-W	
Noise level	Cooling	23 dB(A)
	Heating	28 dB(A)

MODE	Lo
------	----

● Mike position

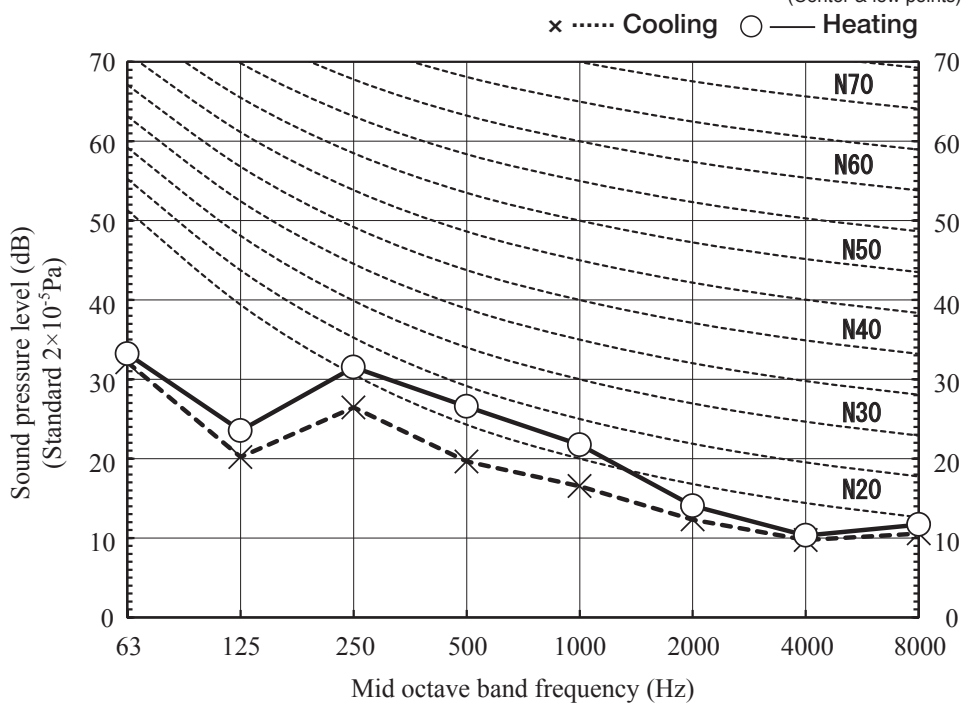

(Indoor unit)

Model	SRK45ZSP-W, 50ZSP-W	
Noise level	Cooling	39 dB(A)
	Heating	41 dB(A)

Condition	ISO5151 T1/H1
MODE	Me

● Mike position

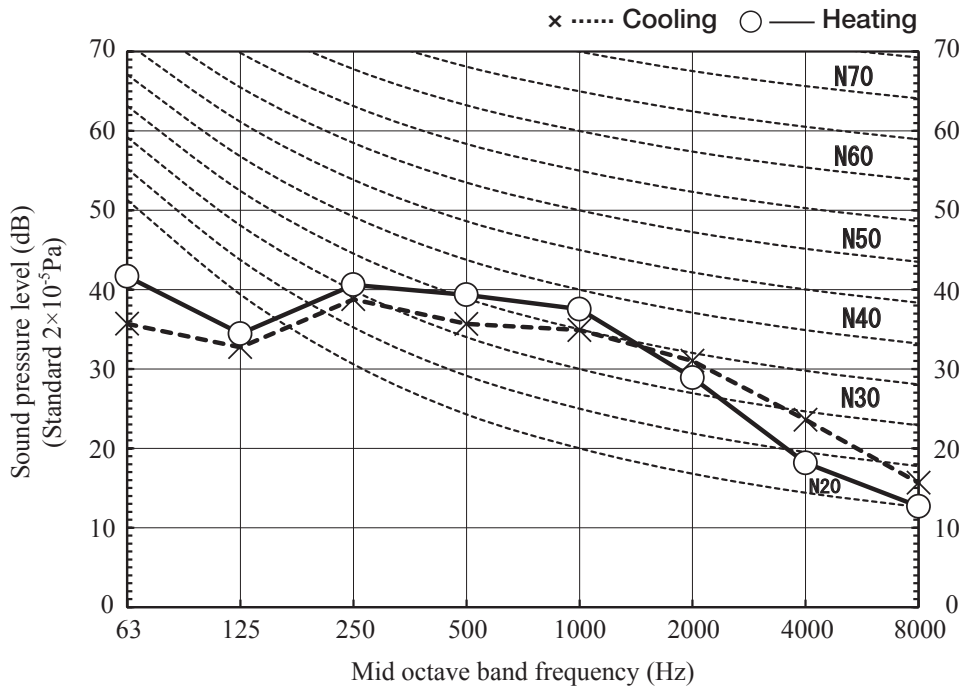
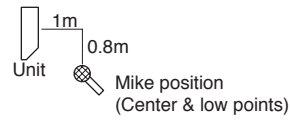

(Indoor unit)

Model	SRK45ZSP-W, 50ZSP-W	
Noise level	Cooling	24 dB(A)
	Heating	30 dB(A)

MODE	Lo
------	----

● Mike position

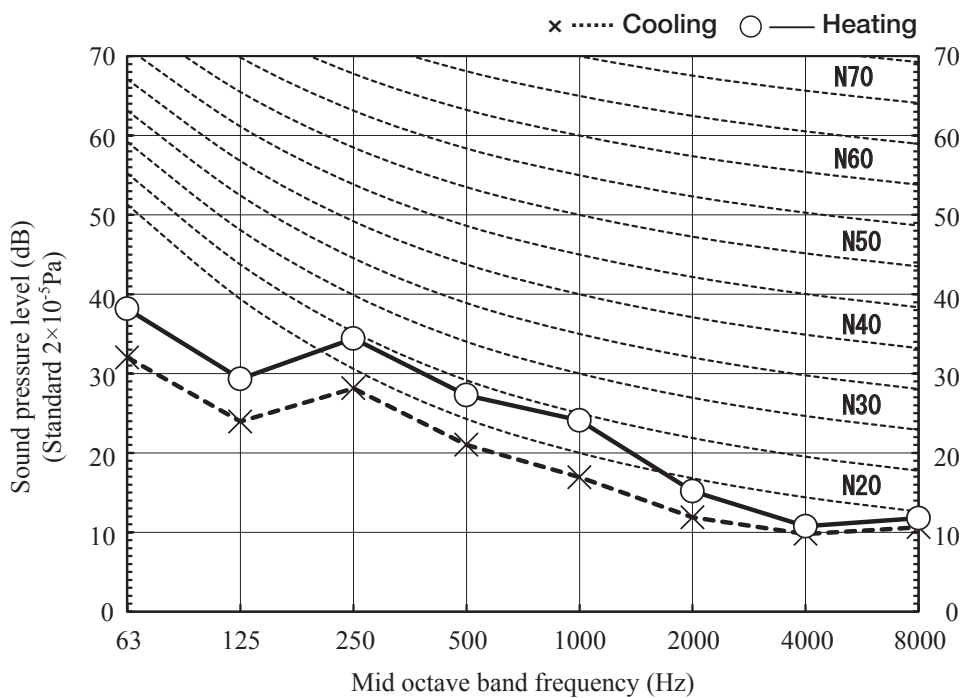

5. PIPING SYSTEM

Models SRK25ZSP-W, 35ZSP-W

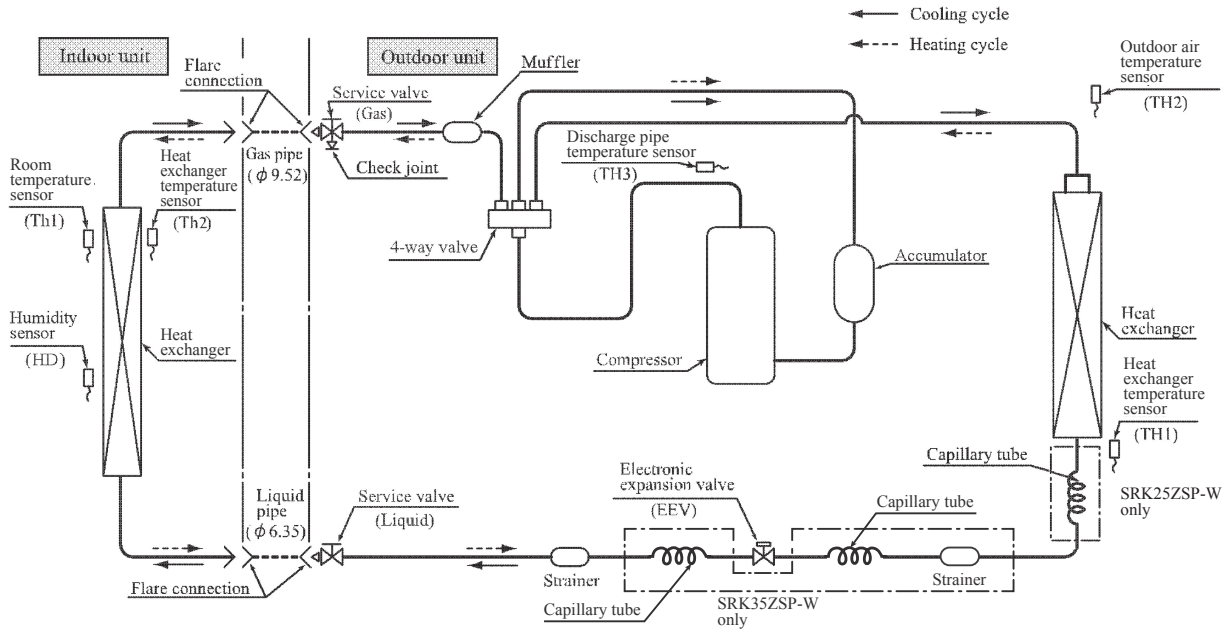

Models SRK45ZSP-W, 50ZSP-W

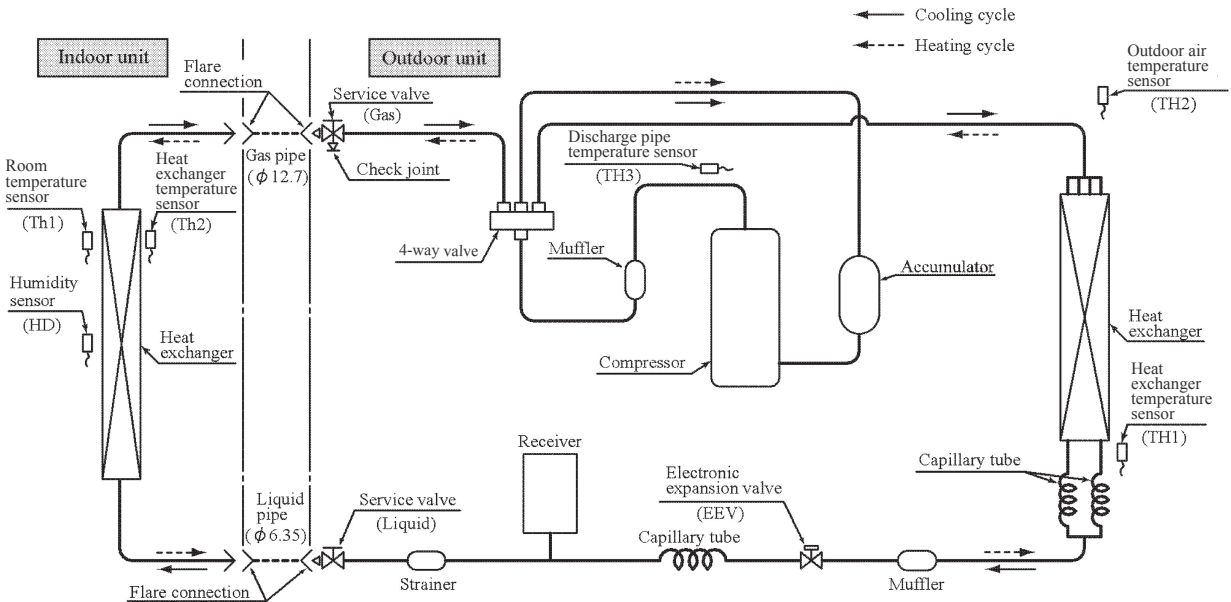

6. RANGE OF USAGE & LIMITATIONS

Item	Model	SRK25ZSP-W, 35ZSP-W	SRK45ZSP-W, 50ZSP-W
Indoor return air temperature (Upper, lower limits)		Cooling operation : Approximately 18 to 32°C DB Heating operation : Approximately 10 to 30°C DB (Refer to the selection chart)	
Outdoor air temperature (Upper, lower limits)		Cooling operation : Approximately -15 to 46°C DB Heating operation : Approximately -15 to 24°C DB (Refer to the selection chart)	
Refrigerant line (one way) length		Max. 15m	Max. 25m
Vertical height difference between outdoor unit and indoor unit		Max. 10m (Outdoor unit is higher) Max. 10m (Outdoor unit is lower)	Max. 15m (Outdoor unit is higher) Max. 15m (Outdoor unit is lower)
Power source voltage		Rating ±10%	
Voltage at starting		Min. 85% of rating	
Frequency of ON-OFF cycle		Max. 4 times/h (Inching prevention 10 minutes)	Max. 7 times/h (Inching prevention 5 minutes)
ON and OFF interval		Min. 3 minutes	

Selection chart

Correct the cooling and heating capacity in accordance with the conditions as follows. The net cooling and heating capacity can be obtained in the following way.

Net capacity = Capacity shown on specification × Correction factors as follows

(1) Coefficient of cooling and heating capacity in relation to temperatures

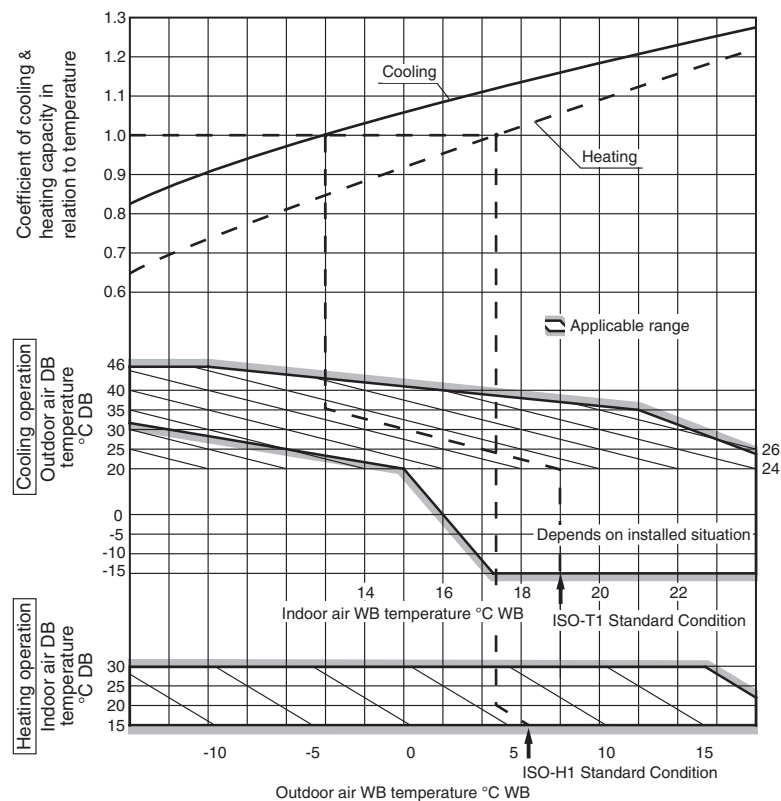

(2) Correction of cooling and heating capacity in relation to one way length of refrigerant piping

It is necessary to correct the cooling and heating capacity in relation to the one way piping length between the indoor and outdoor units.

Piping length [m]	7	10	15	20	25	30
Cooling	1.0	0.99	0.975	0.965	0.95	0.935
Heating	1.0	1.0	1.0	1.0	1.0	1.0

(3) Correction relative to frosting on outdoor heat exchanger during heating

In additions to the foregoing corrections (1), (2) the heating capacity needs to be adjusted also with respect to the frosting on the outdoor heat exchanger.

Air inlet temperature of outdoor unit in °CWB	-15	-10	-9	-7	-5	-3	-1	1	3	5 or more
Adjustment coefficient	0.95	0.95	0.94	0.93	0.91	0.88	0.86	0.87	0.92	1.00

How to obtain the cooling and heating capacity

Example : The net cooling capacity of the model SRK35ZSP-W with the piping length of 15m, indoor wet-bulb temperature at 19.0°C and outdoor dry-bulb temperature 35°C is

$$\text{Net cooling capacity} = \frac{3.2}{\text{SRK35ZSP-W}} \times \frac{0.975}{\text{Length 15m}} \times \frac{1.0}{\text{Factor by air temperatures}} \cong 3.1\text{kW}$$

7. CAPACITY TABLES

Model SRK25ZSP-W

Cooling Mode

(kW)

Air flow	Outdoor air temperature °CDB	Indoor air temperature													
		21 °CDB		23 °CDB		26 °CDB		27 °CDB		28 °CDB		31 °CDB		33 °CDB	
		TC	SHC	TC	SHC	TC	SHC	TC	SHC	TC	SHC	TC	SHC	TC	SHC
Hi 10.1 (m ³ /min)	10	2.82	2.47	2.95	2.43	3.06	2.56	3.11	2.53	3.16	2.50	3.26	2.61	3.34	2.54
	12	2.77	2.45	2.90	2.41	3.01	2.54	3.07	2.52	3.12	2.48	3.22	2.60	3.31	2.53
	14	2.71	2.43	2.85	2.39	2.97	2.52	3.03	2.50	3.08	2.47	3.18	2.59	3.28	2.52
	16	2.66	2.40	2.80	2.37	2.92	2.50	2.98	2.48	3.04	2.45	3.15	2.57	3.24	2.51
	18	2.60	2.38	2.74	2.34	2.88	2.49	2.94	2.46	2.99	2.44	3.11	2.56	3.20	2.50
	20	2.55	2.35	2.68	2.32	2.83	2.47	2.89	2.45	2.95	2.42	3.07	2.54	3.17	2.49
	22	2.49	2.32	2.63	2.30	2.78	2.44	2.84	2.43	2.90	2.40	3.02	2.53	3.13	2.48
	24	2.43	2.29	2.57	2.27	2.72	2.42	2.80	2.41	2.85	2.39	2.98	2.52	3.08	2.46
	26	2.37	2.25	2.51	2.24	2.67	2.40	2.74	2.39	2.80	2.37	2.93	2.50	3.04	2.45
	28	2.31	2.19	2.44	2.22	2.61	2.38	2.69	2.37	2.75	2.35	2.89	2.48	3.00	2.44
	30	2.24	2.13	2.38	2.19	2.56	2.36	2.64	2.35	2.70	2.33	2.84	2.47	2.95	2.40
	32	2.18	2.07	2.31	2.16	2.50	2.34	2.58	2.33	2.64	2.31	2.79	2.45	2.90	2.39
	34	2.11	2.00	2.25	2.13	2.44	2.31	2.53	2.31	2.59	2.29	2.74	2.42	2.85	2.38
	35	2.08	1.97	2.21	2.10	2.41	2.29	2.50	2.30	2.56	2.28	2.71	2.41	2.83	2.37
	36	2.04	1.94	2.18	2.07	2.38	2.26	2.47	2.29	2.53	2.27	2.69	2.40	2.80	2.36
	38	1.97	1.87	2.11	2.00	2.32	2.20	2.41	2.26	2.47	2.24	2.63	2.39	2.75	2.35
	40	1.90	1.81	2.03	1.93	2.25	2.14	2.35	2.23	2.41	2.22	2.58	2.37	2.70	2.33
	43	1.79	1.70	1.92	1.83	2.15	2.04	2.26	2.15	2.32	2.19	2.49	2.34	2.61	2.31
	46	1.68	1.59	1.81	1.72	2.05	1.95	2.16	2.05	2.22	2.11	2.40	2.28	2.53	2.28

Heating Mode (HC)

(kW)

Air flow	Outdoor air temperature °CWB	Indoor air temperature				
		16°C DB	18°C DB	20°C DB	22°C DB	24°C DB
		Hi 10.0 (m ³ /min)	-15	1.72	1.69	1.65
-10	1.95		1.91	1.89	1.84	1.80
-5	2.11		2.08	2.04	2.02	1.98
0	2.21		2.18	2.14	2.12	2.09
5	2.82		2.79	2.77	2.72	2.68
6	2.87		2.83	2.80	2.76	2.73
10	3.04		3.02	3.00	2.96	2.93
15	3.31		3.28	3.26	3.23	3.20
20	3.56		3.53	3.52	3.48	3.45

Model SRK35ZSP-W

Cooling Mode

(kW)

Air flow	Outdoor air temperature °CDB	Indoor air temperature													
		21 °CDB		23 °CDB		26 °CDB		27 °CDB		28 °CDB		31 °CDB		33 °CDB	
		TC	SHC	TC	SHC	TC	SHC	TC	SHC	TC	SHC	TC	SHC	TC	SHC
Hi 9.8 (m ³ /min)	10	3.61	2.86	3.77	2.81	3.91	2.92	3.98	2.88	4.05	2.84	4.17	2.93	4.28	2.85
	12	3.54	2.83	3.71	2.78	3.86	2.90	3.93	2.86	4.00	2.83	4.12	2.92	4.24	2.83
	14	3.47	2.79	3.65	2.75	3.80	2.87	3.87	2.84	3.94	2.80	4.08	2.90	4.19	2.82
	16	3.40	2.76	3.58	2.72	3.74	2.84	3.82	2.81	3.89	2.78	4.03	2.88	4.15	2.80
	18	3.33	2.72	3.51	2.69	3.68	2.82	3.76	2.79	3.83	2.76	3.98	2.86	4.10	2.79
	20	3.26	2.69	3.44	2.65	3.62	2.79	3.70	2.76	3.78	2.73	3.92	2.84	4.05	2.77
	22	3.19	2.65	3.36	2.62	3.55	2.76	3.64	2.74	3.71	2.71	3.87	2.83	4.00	2.75
	24	3.11	2.61	3.29	2.58	3.49	2.74	3.58	2.72	3.65	2.69	3.81	2.81	3.95	2.73
	26	3.03	2.58	3.21	2.55	3.42	2.70	3.51	2.69	3.59	2.66	3.76	2.78	3.89	2.72
	28	2.95	2.54	3.13	2.51	3.35	2.68	3.45	2.66	3.52	2.64	3.70	2.76	3.84	2.70
	30	2.87	2.50	3.05	2.48	3.27	2.64	3.38	2.64	3.45	2.61	3.64	2.74	3.78	2.68
	32	2.79	2.46	2.96	2.44	3.20	2.61	3.31	2.60	3.38	2.58	3.57	2.72	3.72	2.66
	34	2.70	2.42	2.88	2.40	3.12	2.58	3.24	2.58	3.31	2.56	3.51	2.69	3.65	2.64
	35	2.66	2.40	2.83	2.38	3.08	2.57	3.20	2.56	3.28	2.54	3.47	2.68	3.62	2.63
	36	2.61	2.38	2.79	2.36	3.04	2.55	3.16	2.55	3.24	2.53	3.44	2.67	3.59	2.62
	38	2.52	2.34	2.70	2.32	2.96	2.52	3.09	2.52	3.16	2.50	3.37	2.64	3.52	2.59
	40	2.43	2.29	2.60	2.28	2.88	2.49	3.01	2.49	3.08	2.47	3.30	2.62	3.45	2.57
	43	2.29	2.18	2.46	2.22	2.75	2.43	2.89	2.44	2.96	2.42	3.19	2.58	3.35	2.54
	46	2.15	2.04	2.31	2.15	2.62	2.38	2.77	2.39	2.84	2.38	3.08	2.54	3.23	2.50

Heating Mode (HC)

(kW)

Air flow	Outdoor air temperature °CWB	Indoor air temperature				
		16°C DB	18°C DB	20°C DB	22°C DB	24°C DB
		Hi 10.1 (m ³ /min)	-15	2.21	2.17	2.12
-10	2.51		2.46	2.43	2.37	2.32
-5	2.71		2.68	2.62	2.59	2.55
0	2.85		2.80	2.76	2.72	2.68
5	3.63		3.58	3.56	3.49	3.44
6	3.68		3.64	3.60	3.55	3.51
10	3.91		3.88	3.85	3.80	3.76
15	4.26		4.22	4.19	4.15	4.11
20	4.58		4.54	4.52	4.47	4.43

Model SRK45ZSP-W

Cooling Mode

(kW)

Air flow	Outdoor air temperature °CDB	Indoor air temperature													
		21 °CDB		23 °CDB		26 °CDB		27 °CDB		28 °CDB		31 °CDB		33 °CDB	
		TC	SHC	TC	SHC	TC	SHC	TC	SHC	TC	SHC	TC	SHC	TC	SHC
Hi 9.1 (m ³ /min)	10	5.07	3.60	5.31	3.55	5.50	3.61	5.59	3.56	5.69	3.50	5.86	3.53	6.02	3.40
	12	4.98	3.55	5.22	3.50	5.42	3.57	5.52	3.52	5.62	3.46	5.80	3.51	5.96	3.38
	14	4.88	3.50	5.13	3.44	5.34	3.53	5.45	3.48	5.55	3.43	5.73	3.48	5.90	3.36
	16	4.79	3.44	5.03	3.39	5.26	3.49	5.37	3.44	5.47	3.39	5.66	3.45	5.83	3.33
	18	4.69	3.39	4.93	3.34	5.18	3.44	5.29	3.40	5.39	3.35	5.59	3.42	5.77	3.30
	20	4.59	3.32	4.83	3.28	5.09	3.39	5.20	3.36	5.31	3.32	5.52	3.39	5.70	3.28
	22	4.48	3.26	4.73	3.22	5.00	3.35	5.12	3.32	5.22	3.28	5.44	3.35	5.63	3.25
	24	4.37	3.21	4.62	3.17	4.90	3.30	5.03	3.28	5.14	3.24	5.36	3.32	5.55	3.21
	26	4.26	3.14	4.51	3.11	4.80	3.25	4.94	3.23	5.05	3.19	5.28	3.28	5.48	3.18
	28	4.15	3.08	4.40	3.06	4.70	3.21	4.85	3.19	4.95	3.15	5.20	3.24	5.40	3.15
	30	4.04	3.02	4.28	2.99	4.60	3.16	4.75	3.14	4.86	3.11	5.11	3.21	5.31	3.13
	32	3.92	2.95	4.16	2.93	4.50	3.11	4.65	3.10	4.76	3.06	5.02	3.18	5.23	3.09
	34	3.80	2.89	4.04	2.87	4.39	3.06	4.55	3.05	4.66	3.02	4.93	3.14	5.14	3.06
	35	3.74	2.86	3.98	2.84	4.34	3.03	4.50	3.03	4.61	3.00	4.88	3.12	5.09	3.04
	36	3.67	2.82	3.92	2.81	4.28	3.00	4.45	3.00	4.55	2.97	4.84	3.10	5.05	3.02
	38	3.55	2.76	3.79	2.74	4.17	2.95	4.34	2.96	4.45	2.93	4.74	3.06	4.95	2.99
	40	3.42	2.69	3.66	2.68	4.05	2.90	4.23	2.91	4.34	2.88	4.64	3.02	4.85	2.95
	43	3.22	2.59	3.46	2.59	3.87	2.82	4.06	2.83	4.17	2.81	4.49	2.96	4.70	2.90
	46	3.02	2.49	3.25	2.49	3.69	2.73	3.89	2.75	3.99	2.73	4.33	2.90	4.55	2.84

Heating Mode (HC)

(kW)

Air flow	Outdoor air temperature °CWB	Indoor air temperature				
		16°C DB	18°C DB	20°C DB	22°C DB	24°C DB
		Hi 12.1 (m ³ /min)	-15	3.08	3.01	2.94
-10	3.48		3.42	3.37	3.29	3.22
-5	3.77		3.72	3.64	3.60	3.54
0	3.95		3.89	3.83	3.78	3.73
5	5.04		4.98	4.95	4.85	4.78
6	5.12		5.06	5.00	4.94	4.88
10	5.44		5.38	5.35	5.28	5.23
15	5.92		5.87	5.82	5.76	5.71
20	6.36		6.31	6.28	6.21	6.16

Notes(1) These data show average statuses.

Depending on the system control, there may be ranges where the operation is not conducted continuously.

These data show the case where the operation frequency of a compressor is fixed.

(2) Capacities are based on the following conditions.

Corresponding refrigerant piping length :5m

Level difference of Zero.

(3) Symbols are as follows.

TC : Total cooling capacity (kW)

SHC : Sensible heat capacity (kW)

HC : Heating capacity (kW)

Model SRK50ZSP-W

Cooling Mode

(kW)

Air flow	Outdoor air temperature °CDB	Indoor air temperature													
		21 °CDB		23 °CDB		26 °CDB		27 °CDB		28 °CDB		31 °CDB		33 °CDB	
		TC	SHC	TC	SHC	TC	SHC	TC	SHC	TC	SHC	TC	SHC	TC	SHC
Hi 9.9 (m ³ /min)	10	5.63	3.99	5.90	3.93	6.11	3.99	6.22	3.93	6.32	3.87	6.51	3.91	6.69	3.76
	12	5.53	3.93	5.80	3.87	6.03	3.95	6.14	3.89	6.25	3.84	6.44	3.88	6.62	3.73
	14	5.43	3.87	5.70	3.82	5.94	3.90	6.05	3.85	6.16	3.80	6.37	3.84	6.55	3.71
	16	5.32	3.81	5.59	3.75	5.85	3.86	5.96	3.81	6.08	3.75	6.29	3.81	6.48	3.68
	18	5.21	3.75	5.48	3.69	5.75	3.81	5.88	3.76	5.99	3.71	6.21	3.78	6.41	3.65
	20	5.10	3.68	5.37	3.63	5.65	3.76	5.78	3.72	5.90	3.67	6.13	3.74	6.33	3.62
	22	4.98	3.61	5.25	3.57	5.55	3.70	5.69	3.67	5.80	3.62	6.05	3.70	6.25	3.58
	24	4.86	3.55	5.14	3.50	5.45	3.65	5.59	3.62	5.71	3.58	5.96	3.66	6.17	3.55
	26	4.74	3.48	5.01	3.44	5.34	3.60	5.49	3.58	5.61	3.53	5.87	3.62	6.08	3.52
	28	4.61	3.40	4.89	3.38	5.23	3.54	5.39	3.52	5.50	3.48	5.78	3.58	5.99	3.48
	30	4.49	3.34	4.76	3.31	5.11	3.49	5.28	3.47	5.40	3.43	5.68	3.54	5.90	3.44
	32	4.35	3.26	4.63	3.24	5.00	3.43	5.17	3.42	5.29	3.38	5.58	3.50	5.81	3.41
	34	4.22	3.19	4.49	3.18	4.88	3.38	5.06	3.37	5.18	3.33	5.48	3.46	5.71	3.37
	35	4.15	3.16	4.42	3.14	4.82	3.34	5.00	3.34	5.12	3.31	5.43	3.44	5.66	3.36
	36	4.08	3.12	4.35	3.11	4.76	3.31	4.94	3.32	5.06	3.28	5.37	3.42	5.61	3.33
	38	3.94	3.04	4.21	3.03	4.63	3.25	4.82	3.26	4.94	3.23	5.27	3.38	5.50	3.29
	40	3.80	2.97	4.07	2.96	4.50	3.20	4.70	3.21	4.82	3.18	5.16	3.33	5.39	3.26
	43	3.58	2.86	3.84	2.86	4.30	3.11	4.52	3.13	4.63	3.10	4.98	3.26	5.23	3.19
46	3.35	2.74	3.61	2.75	4.10	3.01	4.32	3.04	4.44	3.02	4.81	3.19	5.05	3.13	

Heating Mode (HC)

(kW)

Air flow	Outdoor air temperature °CWB	Indoor air temperature				
		16°C DB	18°C DB	20°C DB	22°C DB	24°C DB
Hi 12.1 (m ³ /min)	-15	3.44	3.37	3.29	3.22	3.15
	-10	3.90	3.83	3.78	3.68	3.61
	-5	4.22	4.16	4.08	4.03	3.97
	0	4.43	4.36	4.29	4.23	4.17
	5	5.64	5.57	5.54	5.43	5.36
	6	5.73	5.66	5.60	5.53	5.46
	10	6.09	6.03	5.99	5.91	5.85
	15	6.63	6.57	6.52	6.45	6.39
	20	7.12	7.06	7.03	6.95	6.89

Notes(1) These data show average statuses.
 Depending on the system control, there may be ranges where the operation is not conducted continuously.
 These data show the case where the operation frequency of a compressor is fixed.
 (2) Capacities are based on the following conditions.
 Corresponding refrigerant piping length :5m
 Level difference of Zero.
 (3) Symbols are as follows.
 TC : Total cooling capacity (kW)
 SHC : Sensible heat capacity (kW)
 HC : Heating capacity (kW)

8. APPLICATION DATA

Models SRK25ZSP-W, 35ZSP-W, 45ZSP-W, 50ZSP-W

RLC012A105A

Model DXK09, 12, 15, 18Z6-W / SRK25, 35, 45, 50ZSP-W / LMK09, 12, 15Z6-W
R32 REFRIGERANT USED

INSTALLATION MANUAL

SAFETY PRECAUTIONS

- Before installation, read the "SAFETY PRECAUTIONS" carefully and strictly follow it during the installation.
- Be sure to confirm no operation problem on the equipment after completing the installation. If unusual noise can be heard during the test run, consult the dealer.
- Be sure to explain the operating methods as well as the maintenance methods of this equipment to the user according to the user's manual.
- Be sure to keep the installation manual together with user's manual at a place where it is easily accessible to the user any time. Moreover, ask the user to hand the manuals to a new user, whenever required.

- Before installation, read the "SAFETY PRECAUTIONS" carefully and strictly follow it during the installation.
- Be sure to confirm no operation problem on the equipment after completing the installation. If unusual noise can be heard during the test run, consult the dealer.
- Be sure to explain the operating methods as well as the maintenance methods of this equipment to the user according to the user's manual.
- Be sure to keep the installation manual together with user's manual at a place where it is easily accessible to the user any time. Moreover, ask the user to hand the manuals to a new user, whenever required.

⚠ WARNING

- **Be sure to use only for residential purpose.**
If this unit is installed in inferior environment such as machine shop, vehicle (like ship), warehouse, etc., it can malfunction.
- **Installation must be carried out by the qualified installer completely in accordance with the installation manual.**
Installation by non qualified person or incorrect installation can cause serious troubles such as water leak, electric shock, fire and personal injury.
- **Be sure to wear protective goggles and gloves while performing installation work.**
Improper safety measures can result in personal injury.
- **Use the original accessories and the specified components for the installation.**
Using parts other than those prescribed may cause water leak, electric shock, fire and personal injury.
- **Do not install the unit near the location where leakage of flammable gases can occur.**
If leaked gases accumulate around the unit, it can cause fire resulting in property damage and personal injury.
- **When installing the unit in small rooms, make sure that refrigerant density does not exceed the limit (Reference: ISO5149) in the event of leakage.**
If refrigerant density exceeds the limit, consult the dealer and install the ventilation system.
Otherwise lack of oxygen can occur resulting in serious accident.
- **Install the unit in a location where unit will remain stable, horizontal and free of any vibration transmission.**
Unsuitable installation location can cause the unit to fall resulting in material damage and personal injury.
- **Do not run the unit with removed panels or protections.**
Touching rotating equipments, hot surfaces or high voltage parts can cause personal injury due to entrapment, burn or electric shock.
- **This unit is designed specifically for R32.**
Using any other refrigerant can cause unit failure and personal injury.
- **Do not vent R32 into atmosphere.**
R32 is a fluorinated greenhouse gas with a Global Warming Potential (GWP) = 675.
- **Make sure that no air enters the refrigerant circuit when the unit is installed and removed.**
If air enters the refrigerant circuit, the pressure in the refrigerant circuit will become too high, which can cause burst and personal injury.
- **Be sure to use the prescribed pipes, flare nuts and tools for R32.**
Using existing parts (for R22 or R407C) can cause refrigerant circuit burst resulting in unit failure and personal injury.
- **Be sure to connect both liquid and gas connecting pipes properly before operating the compressor. Do not open the liquid and gas operation valves before completing piping work, and evacuation.**
If the compressor is operated when connecting pipes are not connected and operation valves are open, air can be sucked into the refrigerant circuit which can cause anomalous high pressure resulting in burst or personal injury.
- **Be sure to tighten the flare nuts to specified torque using the torque wrench.**
Tightening flare nuts with excess torque can cause burst and refrigerant leakage after a long period.
- **During pump down work, be sure to stop the compressor before closing operation valves and removing connecting pipes.**
If the connecting pipes are removed when the compressor is in operation and operation valves are open, air can be sucked into the refrigerant circuit which can cause anomalous high pressure resulting in burst or personal injury.
- **In the event of refrigerant leakage during installation, be sure to ventilate the working area properly.**
If the refrigerant comes into contact with naked flames, poisonous gases will be produced.
- **Electrical work must be carried out by the qualified electrician, strictly in accordance with national or regional electricity regulations.**
Incorrect installation can cause electric shock, fire or personal injury.
- **Make sure that earth leakage breaker and circuit breaker of appropriate capacities are installed.**
Circuit breaker should be able to disconnect all poles under over current. Absence of appropriate breakers can cause electric shock, personal injury or property damage.
- **Be sure to switch off the power source in the event of installation, maintenance or service.**
If the power source is not switched off, there is a risk of electric shock, unit failure or personal injury.
- **Be sure to tighten the cables securely in terminal block and relieve the cables properly to prevent overloading the terminal blocks.**
Loose connections or cable mountings can cause anomalous heat production or fire.
- **Do not process, splice or modify the power cable, or share the socket with other power plugs.**
Improper power cable or power plug can cause fire or electric shock due to poor connection, insufficient insulation or over-current.
- **Do not perform any change in protective device or its setup condition yourself.**
Changing protective device specifications can cause electric shock, fire or burst.
- **Be sure to clamp the cables properly so that they do not touch any internal component of the unit.**
If cables touch any internal component, it can cause overheating and fire.
- **Be sure to install service cover properly.**
Improper installation can cause electric shock or fire due to intrusion of dust or water.
- **Be sure to use the prescribed power and connecting cables for electrical work.**
Using improper cables can cause electric leak or fire.
- **This appliance must be connected to main power source by means of a circuit breaker or switch with a contact separation of at least 3 mm.**
Improper electrical work can cause unit failure or personal injury.
- **Be sure to connect the power source cable with power source properly.**
Improper connection can cause intrusion of dust or water resulting in electric shock or fire.

⚠ CAUTION

It can cause corrosion of heat exchanger and damage to plastic parts.

- **Take care when carrying the unit by hand.** If the unit weight is more than 20 kg, it must be carried by two or more persons.
- Do not carry the unit by the plastic straps. Always use the carry handle.
- **Do not install the outdoor unit in a location where insects and small animals can inhabit.** Insects and small animals can enter the electrical parts and cause damage resulting in fire or personal injury. Instruct the user to keep the surroundings clean.
- **If the outdoor unit is installed at height, make sure that there is enough space for installation, maintenance and service.** Insufficient space can result in personal injury due to falling from the height.
- **Do not install the unit near the location where neighbours are bothered by noise or air generating from the unit.** It can affect surrounding environment and cause a claim.
- **Do not install in the locations where unit is directly exposed to corrosive gases (like sulphide gas, chloride gas), sea breeze or salty atmosphere.**

It can cause performance degradation, corrosion and damage of components, unit malfunction and fire.

- **Dispose of all packing materials properly.** Packing materials contain nails and wood which can cause personal injury.
- Keep the polybag away from children to avoid the risk of suffocation.
- **Do not put anything on the outdoor unit.** Object may fall causing property damage or personal injury.
- **Do not touch the aluminum fin of the outdoor unit.** Aluminium fin temperature is high during heating operation. Touching fin can cause burn.
- **Do not touch any refrigerant pipe with your hands when the system is in operation.** During operation the refrigerant pipes become extremely hot or extremely cold depending on the operating condition. Touching pipes can cause personal injury like burn (hot/cold).
- **Install isolator or disconnect switch on the power source wiring in accordance with the local codes and regulations.** The isolator should be locked in OFF state in accordance with EN60204-1.

It can cause corrosion of heat exchanger and damage to plastic parts.

- **Do not install the unit close to the equipments that generate electromagnetic waves and/or high harmonic waves.** Equipment such as inverters, standby generators, medical high frequency equipments and telecommunication equipments can affect the system, and cause malfunctions and breakdowns. The system can also affect medical equipment and telecommunication equipment, and obstruct its function or cause jamming.
- **Do not install the unit in the locations where:**
 - There are heat sources nearby.
 - Unit is directly exposed to rain or sunlight.
 - There is any obstacle which can prevent smooth air circulation from inlet and outlet side of the unit.
 - Unit is directly exposed to oil mist and steam such as kitchen.
 - Chemical substances like ammonia (organic fertilizer), calcium chloride (snow melting agent) and acid (sulfurous acid etc.), which can harm the unit, will generate or accumulate.
 - Drain water can not be discharged properly.
 - TV set or radio receiver is placed within 1 m.
 - Height above sea level is more than 1000 m.

ACCESSORIES AND TOOLS

Standard accessories (supplied with indoor unit)	
(1) Installation board	1 pc. (6) Batteries [R03 (AAA, Micro) 1.5 V]
(2) Remote control	1 pc. (7) Air-cleaning filters (LWK model only)
(3) Remote control holder	1 pc. (8) Filter holders (LWK model only)
(4) Tapping screws (for installation board ø4 X 25 mm)	5 pcs. (9) Insulation (#486 50 X 100 I3)
(5) Wood screws (for remote control holder ø3.5 X 16 mm)	2 pcs.
Standard accessories (supplied with outdoor unit)	
(1) Drain grommet	1 pc. (2) Drain elbow
	 1 pc.

Locally procured parts	
(a) Sleeve (1 pc.)	
(b) Sealing plate (1 pc.)	
(c) Inclination plate (1 pc.)	
(d) Putty	
(e) Connecting cable	
(f) Drain hose (extension hose)	
(g) Piping cover (for insulation of connection piping)	
(h) Clamp and screw (for finishing work)	
(i) Anchor bolt (M10-M12) x 4 pcs.	
(j) Electrical tape	
(k) Connecting pipe	
(l) Power cable	

Tools for installation work	
Plus headed driver	Hole core drill (65 mm in diameter)
Knife	Wrench key (Hexagon) [4 mm]
Saw	Flaring tool set*
Tape measure	Gas leak detector*
Torque wrench (14.0-62.0 N.m (1.4-6.2 kgf.m))	Pipe bender
Plier	Gauge for projection adjustment (Used when flare is made by using conventional flare tool)
Pipe cutter	
Spanner wrench	
Flare adjustment gauge	Charge hose *
Vacuum pump*	Vacuum pump adapter* (Anti-reverse flow type)
Gauge manifold *	

* Designed specifically for R32 or R410A

SELECTING OF INSTALLATION LOCATION

After getting customer's approval, select installation location according to following guidelines.

1. Indoor unit

- Where there is no obstruction to the airflow and where the cooled and heated air can be evenly distributed.
- A solid place where the unit or the wall will not vibrate.
- A place where there will be enough space for servicing. (Where space mentioned on the right side can be secured.)
- Where it is easy to conduct wiring and piping work.
- A place where unit is not directly exposed to sunlight or street light.
- A place where it can be easily drained.
- A place separated at least 1 m away from the television or the radio. (To prevent interference to images and sounds.)
- A place where this unit is not affected by the high frequency equipment or electric equipment.
- Avoid installing this unit in place where there is much oil mist.
- A place where there is no electric equipment or household.
- Install the indoor unit on the wall where the height from the floor to the bottom of the unit is more than 180 cm.

2. Remote control

- A place where the air-conditioner can receive the signal surely during operating the remote control.
- A place where it is not affected by the TV, radio etc.
- Do not place where it is exposed to direct sunlight or near heat devices such as a stove.

3. Outdoor unit

- Select the suitable installation location where:
- Unit will be stable, horizontal and free of any vibration transmission.
 - There is no obstacle which can prevent smooth air circulation from inlet and outlet side of the unit.
 - There is enough space for service and maintenance of unit.
 - Neighbours are not bothered by noise or air generating from the unit.
 - Outlet air of the unit does not blow directly to animals or plants.
 - Drain water can be discharged properly.
 - There is no risk of flammable gas leakage.
 - There are no other heat sources nearby.
 - Unit is not directly exposed to rain or sunlight.
 - Unit is not directly exposed to oil mist and steam.
 - Chemical substances like ammonia (organic fertilizer), calcium chloride (snow melting agent) and acid (sulfurous acid etc.), which can harm the unit, will not generate or accumulate.
 - Unit is not directly exposed to corrosive gases (like sulphide gas, chloride gas), sea breeze or salty atmosphere.
 - No TV set or radio receiver is placed within 1 m.
 - Unit is not affected by electromagnetic waves and/or high-harmonic waves generated by other equipments.
 - Strong wind does not blow against the unit outlet.
 - Heavy snowfalls do not occur (If installed, provide proper protection to avoid snow accumulation).
 - There must be 1 meter or larger space between the unit and the wall in at least 1 of the 4 sides. Walls surrounding the unit from 4 sides is not acceptable. The wall height on the outlet side should be 1200 mm or less. Refer to the following figure and table for details.

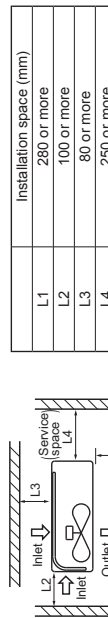

Installation space (mm)	
L1	280 or more
L2	100 or more
L3	80 or more
L4	250 or more

NOTE

When more than one unit are installed side by side, provide a 250 mm or wider interval between them as a service space.

CAUTION

When more than one unit are installed in parallel directions, provide sufficient inlet space so that short-circuiting may not occur.

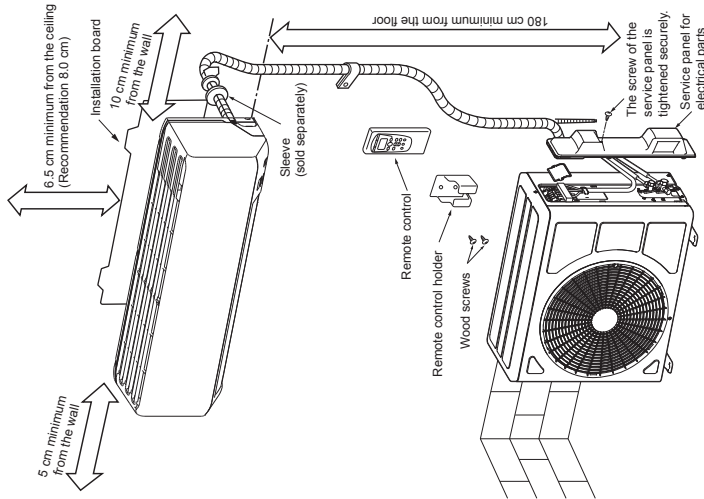

Note as a unit designed for R32

- Do not use any refrigerant other than R32. R32 will rise to pressure about 1.6 times higher than that of a conventional refrigerant. A cylinder containing R32 has a light blue indication mark on the top.
- Do not use a charge cylinder. The use of a charge cylinder will cause the refrigerant composition to change, which results in performance degradation.
- In charging refrigerant, always take it out from a cylinder in the liquid phase.
- All indoor units must be models designed exclusively for R32. Check connectable indoor unit models in a catalog, etc. (A wrong indoor unit, if connected into the system, will impair proper system operation)

Limitation of the piping length

Model	DXK09, SRK25, LMK09	DXK12, SRK35, LMK12	DXK15/18, SRK45/50, LMK15
Total one way length	MAX. 15 m	MAX. 15 m	MAX. 25 m
Vertical height difference	MAX. 10 m	MAX. 10 m	MAX. 15 m
Additional refrigerant	Less than 10 m : Not required More than 10 m : 20 g/m	Not required	Less than 15 m : Not required More than 15 m : 20 g/m

Charging refrigerant

- (1) Charge the R32 refrigerant in liquid phase from service port with both liquid and gas operation valves shut. Since R32 refrigerant must be charged in the liquid phase, make sure that refrigerant is discharged from the cylinder in the liquid phase all the time.
- (2) When it is difficult to charge a required refrigerant amount, fully open both liquid and gas operation valves and charge refrigerant, while running the unit in the cooling mode. When refrigerant is charged with the unit being run, complete the charge operation within 30 minutes.
- (3) Write the additional refrigerant charge calculated from the connecting pipe length on the label attached on the service cover.

CAUTION

- Running the unit with an insufficient quantity of refrigerant for a long time can cause unit malfunction.
- Do not charge more than the maximum refrigerant amount. It can cause unit malfunction.

DRAIN PIPING WORK (if necessary)

Carry out drain piping work by using a drain elbow and a drain grommet supplied separately as accessories if condensed water needs to be drained out.

- (1) Install drain elbow and drain grommet.
- (2) Seal around the drain elbow and drain grommet with putty or adequate caulking material.

Do not put a grommet on this hole.
This is a supplementary drain hole to discharge drain water, when a large amount of it is gathered.

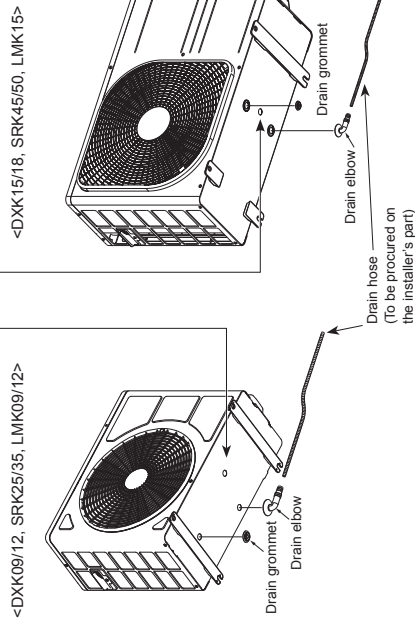

CAUTION

Do not use drain elbow and drain grommet if there is a possibility to have several consecutive days of sub zero temperature. (There is a risk of drain water freezing inside and blocking the drain.)

INSTALLING REMOTE CONTROL

Mount the batteries

- (1) Slide and take out the cover of backside.
- (2) Mount the batteries [R03 (AAA, Micro), x 2 pieces] in the body properly.
(Fit the poles with the indication marks + & -)
- (3) Set the cover again.

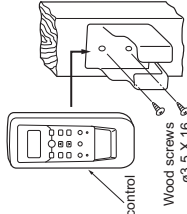

Installing remote control holder

- (1) Select the place where the unit can receive signals.
- (2) Fix the holder to pillar or wall with wood screws.

HOW TO REMOVE AND INSTALL FRONT PANEL

1. Removing

- (1) Remove the air inlet panel and the air filters.
- (2) Remove the 2 screws.
- (3) Remove the 3 upper latches and then front panel can be removed.

2. Installing

- (1) Cover the unit with the front panel and fix 3 upper latches.
- (2) Secure the front panel with the 2 screws.
- (3) Install the air inlet panel and the air filters.

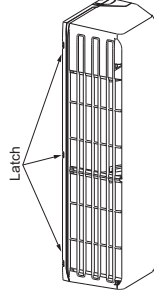

PUMP DOWN WORK

For the environmental protection, be sure to pump down when relocating or disposing of the unit. Pump down is the method of recovering refrigerant from the indoor unit to the outdoor unit before the connecting pipes are removed from the unit. When pump down is carried out, forced cooling operation is needed.

Forced cooling operation

- (1) Turn off the power source and turn it on again after 1 minute.
- (2) Press the ON/OFF button continuously for at least 5 seconds. Then operation will start.

For the detail of pump down, refer to the installation manual of outdoor unit.

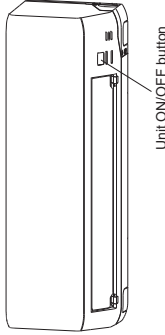

1. INSTALLING INSTALLATION BOARD

- Installation board should be installed on the wall which can support the weight of the indoor unit.
- Adjustment of the installation board in the horizontal direction is to be conducted with five screws in a temporary tightened state.
- With the standard hole as a center, adjust the board and level it.

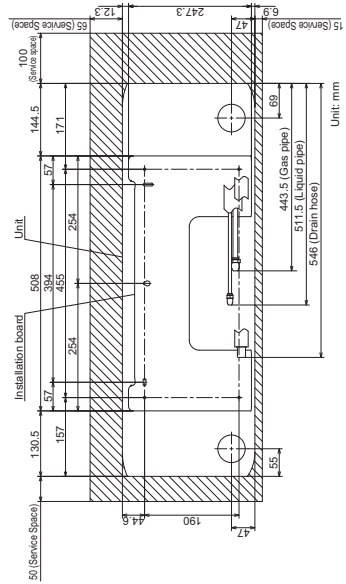
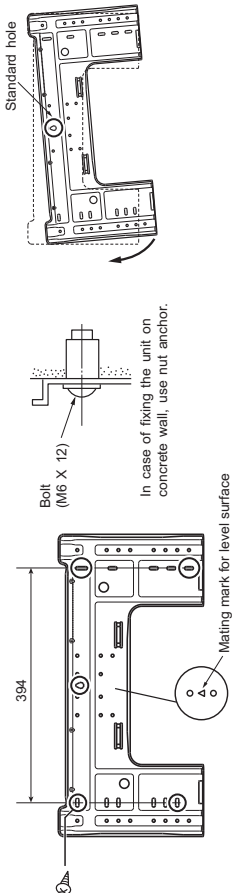

CAUTION

Improper adjustment of the installation board can cause water leakage.

4. FORMING PIPING AND DRAIN HOSE

1. Forming piping

Piping is possible in the right, rear, downward, left, left rear or left downward direction.

NOTE

Sufficient care must be taken not to damage the panels when connecting pipes.

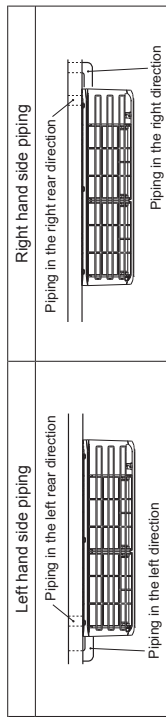
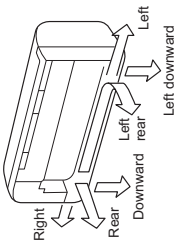

Forming of pipings.

- Hold the bottom of the piping and fix direction before stretching it and shaping it.

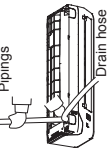

Taping of the exterior

- Tape only the portion that goes through the wall.
- Always tape the wiring with the piping.



2. Drain change procedures

- (1) Remove the screw and drain hose.
- (2) Insert the drain cap which was removed at procedure (2) securely using a hexagonal wrench etc.
- (3) Remove the drain cap by hand or pliers.
- (4) Install the drain hose and screw securely.

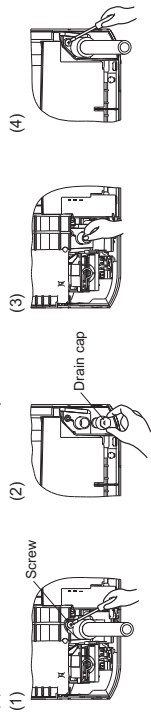

CAUTION

Incorrect installation of drain hose and cap can cause water leakage.

5. DRAINAGE WORK

- Arrange the drain hose in a downward angle.
- Avoid the following drain piping.

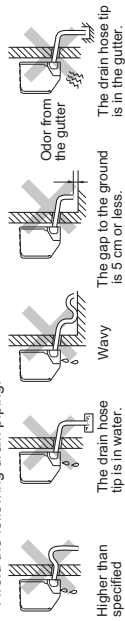

- Pour water to the drain pan located under the heat exchanger, and ensure that the water is discharged outdoor.
- When extended drain hose is present inside the room, insulate it securely with heat insulator available in the market.

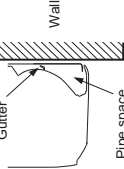

CAUTION

Incorrect drainage work can cause water leakage.

6. INSTALLING INDOOR UNIT

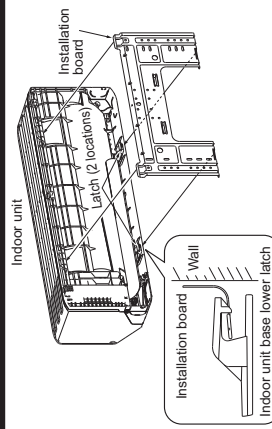

Installation steps

- (1) Pass the pipe through the hole in the wall, and hook the upper part of the indoor unit to the installation board.
- (2) Gently push the lower part to secure the unit.

How to remove the indoor unit from the installation board

- (1) Push up at the marked portion of the indoor unit base lower latch, and slightly pull it toward you. (Both right and left hand sides) (The indoor unit base lower latch can be removed from the installation board.)
- (2) Push up the indoor unit upward so that it can be removed from the installation board.

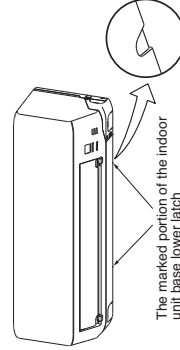

7. CONNECTING PIPING WORK

1. Preparation of connecting pipe

1.1. Selecting connecting pipe
Select connecting pipe according to the following table.

	Model DXK09/12	Model DXK15/18
Gas pipe	SRK25/35	SRK45/60
Liquid pipe	LWK09/12	LWK15
	ø9.52	ø12.7
	ø6.35	ø6.35

- Pipe wall thickness must be greater than or equal to 0.8 mm.
- Pipe material must be O-type (Phosphorus deoxidized seamless copper pipe ICS 23.040.15, ICS 77.150.30).

1.2. Cutting connecting pipe

- (1) Cut the connecting pipe to the required length with pipe cutter.
- (2) Hold the pipe downward and remove the burrs. Make sure that no foreign material enters the pipe.
- (3) Cover the connecting pipe ends with the tape.

2. Piping work

2.1. Flaring pipe

- (1) Take out flare nuts from the operation valves of indoor unit and engage them onto connecting pipes.
- (2) Flare the pipes according to table and figure shown below.
Flare dimensions for R32 are different from those for conventional refrigerant.
Although, it is recommended to use the flaring tools designed specifically for R32 or R410A, conventional flaring tools can also be used by adjusting the dimension B with a flare adjustment gauge.

Copper pipe outer diameter	B [Rigid (clutch) type]	
	R32	Conventional
ø6.35	0-0.5	1.0-1.5
ø9.52		
ø12.7		

2.2 Connecting pipes

- (1) Connect pipes on both liquid and gas sides.
- (2) Tighten nuts to specified torque shown in the table below.

Operation valve size (mm)	Tightening torque (N·m)
ø6.35 (1/4")	14-18
ø9.52 (3/8")	34-42
ø12.7 (1/2")	49-61

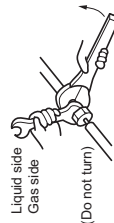

CAUTION

- Do not apply refrigerating machine oil to the flared surface. It can cause refrigerant leakage.
- Do not apply excess torque to the flared nuts. The flared nuts may crack resulting in refrigerant leakage.

3. Heating and condensation prevention

- (1) Dress the connecting pipes (both liquid and gas pipes) with insulation to prevent it from heating and dew condensation.
Use the heat insulating material which can withstand 120 °C or higher temperature. Make sure that insulation is wrapped tightly around the pipes and no gap is left between them.
- (2) Wrap the refrigerant pipings of indoor unit with indoor unit heat insulation using them.
- (3) Cover the flare-connected joints (indoor side) with the indoor unit heat insulation and wrap it with an insulation pad (standard accessory provided with indoor unit).
- (4) Wrap the connecting pipes, connecting cable and drain hose with the tape.

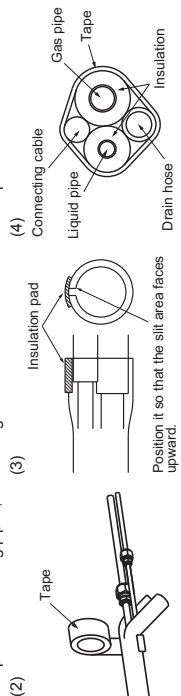

NOTE

Locations where relative humidity exceeds 70 %, both liquid and gas pipes need to be dressed with 20 mm or thicker heat insulation materials.

CAUTION

- Improper insulation can cause condensate (water) formation during cooling operation. Condensate can leak or drip causing damage to household property.
- Poor heat insulating capacity can cause pipe outer surface to reach high temperature during heating operation. It can cause cable deterioration and personal injury.

4. Finishing work

- (1) Make sure that the exterior portion of connecting pipes, connecting cable and drain hose is wrapped properly with tape. Shape the connecting pipes to match with the contours of the pipe assembly route.
- (2) Fix the pipe assembly with the wall using clamps and screws. Pipe assembly should be anchored every 1.5 m or less to isolate the vibration.
- (3) Install the service cover securely. Water may enter the unit if service cover is not installed properly, resulting in unit malfunction and failure.

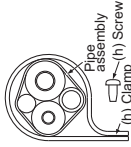

WARNING

- To avoid the risk of fire or explosion, the flared connection must/shall be installed outdoors.
- Reusable mechanical connectors and flared joints are not allowed indoors.

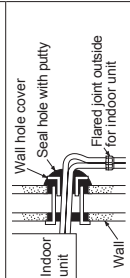

CAUTION

Make sure that the connecting pipes do not touch the components within the unit. If pipes touch the internal components, it may generate abnormal sounds and/or vibrations.

5. Evacuation

- (1) Connect vacuum pump to gauge manifold. Connect charge hose of gauge manifold to service port of outdoor unit.
- (2) Run the vacuum pump for at least one hour after the vacuum gauge shows -0.1 MPa (-76 cm Hg).
- (3) Confirm that the vacuum gauge indicator does not rise even if the system is left for 15 minutes or more. Vacuum gauge indicator will rise if the system has moisture left inside or has a leakage point. Check the system for the leakage point. If leakage point is found, repair it and return to (1) again.
- (4) Close the Handle Lo and stop the vacuum pump.
- (5) Keep this state for a few minutes to make sure that the compound pressure gauge pointer does not swing back.
- (6) Remove valve caps from liquid operation valve and gas operation valve.
Turn the liquid operation valve's rod 90 degree counterclockwise with a hexagonal wrench key to open valve. Close it after 5 seconds, and check for gas leakage.
Using soapy water, check for gas leakage from indoor unit's flare and outdoor unit's flare and valve rods. Wipe off all the water after completing the check.
- (7) Disconnect charging hose from gas operation valve's service port and fully open liquid and gas operation valves. (Do not attempt to turn valve rod beyond its stop.)
- (8) Tighten operation valve caps and service port cap to the specified torque shown in the table below.

Operation valve size (mm)	Operation valve cap tightening torque (N·m)	Service port cap tightening torque (N·m)
ø6.35 (1/4")	20-30	10-12
ø9.52 (3/8")	25-35	
ø12.7 (1/2")		

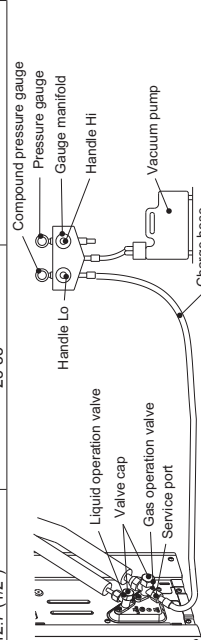

CAUTION

To prevent vacuum pump oil from entering into the refrigerant system, use a counterflow prevention adapter.

8. INSTALLATION CHECK AND TEST RUN

After finishing the installation work, check the following points again before turning on the power. Conduct a test run and ensure that the unit operates properly. At the same time, explain to the customer how to use the unit and how to take care of the unit following the user's manual.

NOTE

During restart or change in operation mode, the unit will not start operating for approximately 3 minutes. This is to protect the unit and it is not malfunction.

Before test run

Before test run, check following points.

Power source voltage complies with the rated voltage of air-conditioner.	
Earth leakage breaker and circuit breaker are installed.	
Power cable and connecting cable are securely fixed to the terminal block.	
Both liquid and gas operation valves are fully open.	
No gas leaks from the joints of the operation valves.	
Indoor and outdoor side pipe joints have been insulated.	
Hole on the wall is completely sealed with putty.	
Drain hose and cap are installed properly.	
Screw of the lid is tightened securely.	

Test run

Check following points during test run.

Indoor unit receives signal of remote control.	
Air-conditioning operation is normal.	
There is no abnormal noise.	
Water drains out smoothly.	
Display of remote control is normal.	

After test run

Explain the operating and maintenance methods to the user according to the user's manual.

Keep this installation manual together with user's manual.

9. OUTLINE OF OPERATION CONTROL BY MICROCOMPUTER

(1) Operation control function by wireless remote control

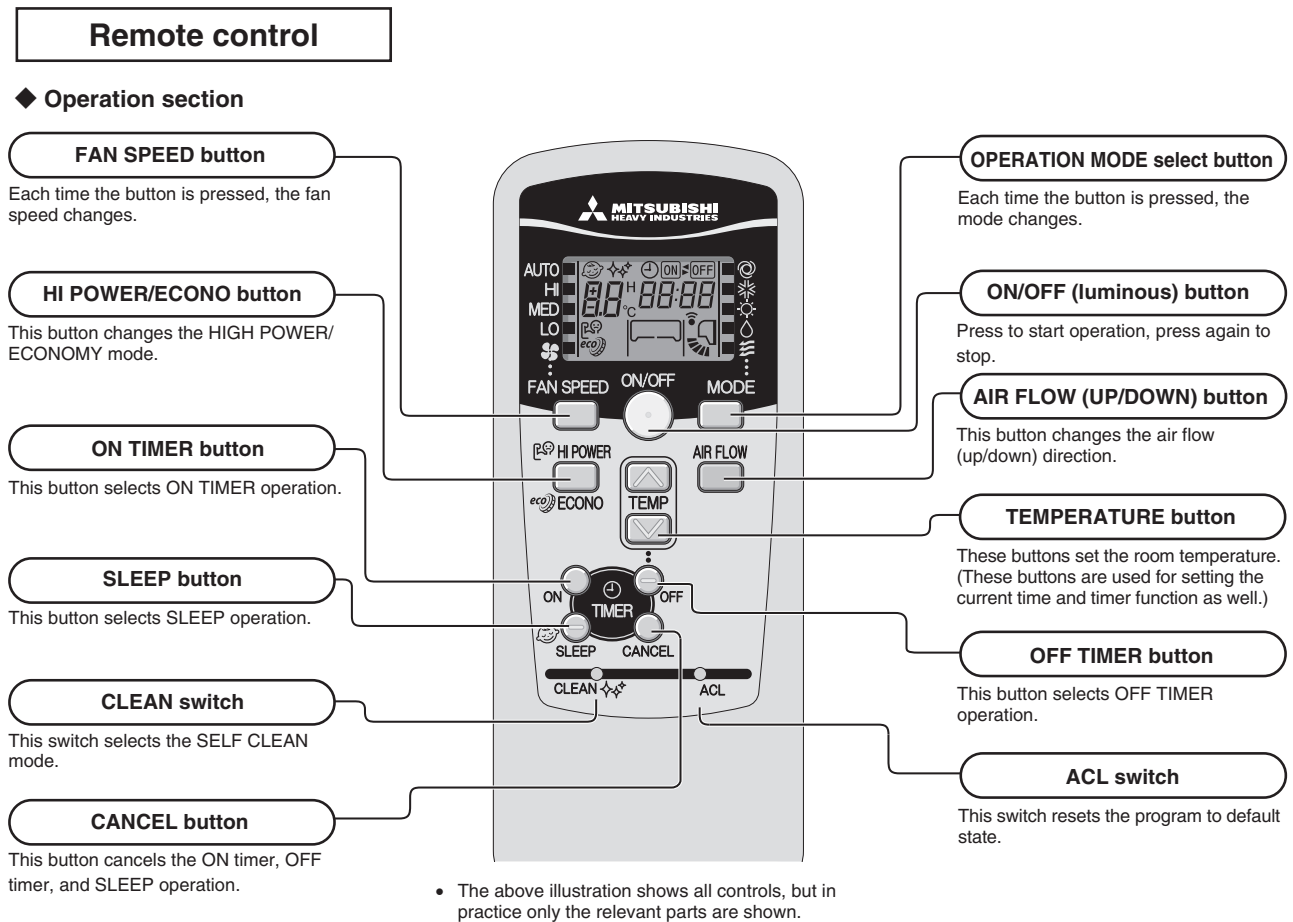

Unit display section

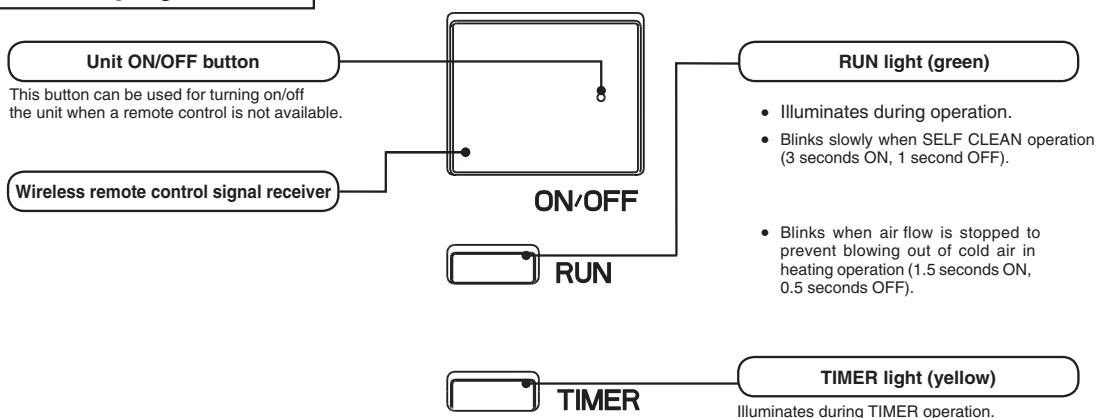

(2) Unit ON/OFF button

When the wireless remote control batteries become weak, or if the wireless remote control is lost or malfunctioning, this button may be used to turn the unit on and off.

(a) Operation

Push the button once to place the unit in the automatic mode. Push it once more to turn the unit off.

(b) Details of operation

The unit will go into the automatic mode in which it automatically determines, from room temperature (as detected by sensor), whether to go into the COOL, DRY or Heat modes.

Function Operation mode	Room temperature setting	Fan speed	Flap	Timer switch
COOL	About 24°C	Auto	Auto	Continuous
DRY	About 24°C			
HEAT	About 26°C			

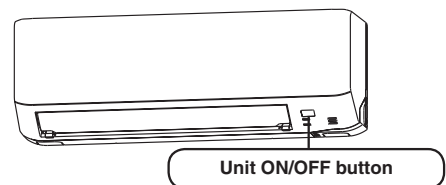

(3) Auto restart function

(a) Auto restart function records the operational status of the air-conditioner immediately prior to be switched off by a power cut, and then automatically resumes operations after the power has been restored.

(b) The following settings will be cancelled:

- (i) Timer settings
- (ii) HIGH POWER operation

- Notes (1) Auto restart function is set at on when the air-conditioner is shipped from the factory. Consult with your dealer if this function needs to be switched off.
 (2) When power failure occurs, the timer setting is cancelled. Once power is resumed, reset the timer.
 (3) If the jumper wire (J1) "AUTO RESTART" is cut, auto restart is disabled. (See the diagram at right.)

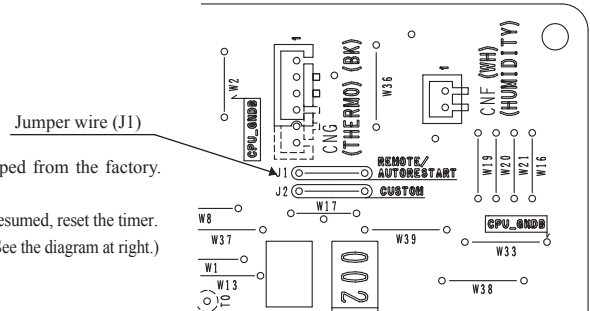

(4) Installing two air-conditioners in the same room

When two air-conditioners are installed in the room, set the wireless remote control and indoor unit as follows to prevent operating air-conditioners with one wireless remote control.

(a) Setting an indoor unit's printed circuit board

- (i) Take out the printed circuit board from the control box.
- (ii) Disconnect jumper wire (J2) with wire cutters.
- (iii) Install a printed circuit board.

(b) Setting a wireless remote control

- (i) Pull out the cover and take out batteries.
- (ii) Disconnect the switching line next to the battery with wire cutters.
- (iii) Insert batteries. Close the cover.

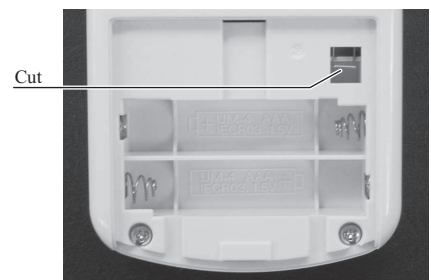
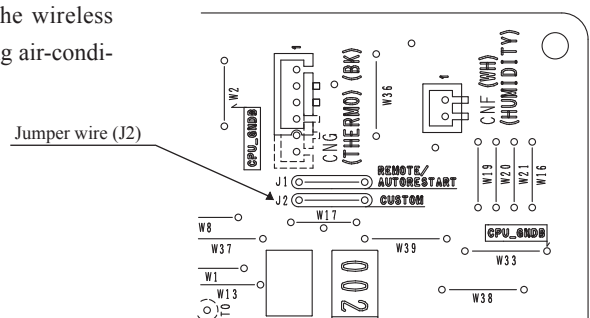

(5) High power operation

Pressing the HI POWER/ECONO button intensifies the operating power and initiates powerful cooling and heating operation for 15 minutes continuously. The wireless remote control displays HIGH POWER mark and the FAN SPEED display disappears.

- (a) During the HIGH POWER operation, the room temperature is not controlled. When it causes an excessive cooling and heating, press the HI POWER/ECONO button again to cancel the HIGH POWER operation.
- (b) HIGH POWER operation is not available during the DRY and the ON timer to OFF timer operations.
- (c) When HIGH POWER operation is set after ON TIMER operation, HIGH POWER operation will start from the set time.
- (d) When the following operation are set, HIGH POWER operation will be canceled.
 - ① When the HI POWER/ECONO button is pressed again.
 - ② When the operation mode is changed.
 - ③ When it has been 15 minutes since HIGH POWER operation has started.
- (e) Not operable while the air-conditioner is OFF.

(6) Economy operation

Pressing the HI POWER/ECONO button initiates a soft operation with the power suppressed in order to avoid an excessive cooling or heating. The unit operates 1.5°C higher than the setting temperature during cooling or 2.5°C lower than that during heating. The wireless remote control displays ECONO mark and the FAN SPEED display disappears.

- (a) It will go into ECONOMY operation at the next time the air-conditioner runs in the following cases.
 - ① When the air-conditioner is stopped by ON/OFF button during ECONOMY operation.
 - ② When the air-conditioner is stopped in SLEEP or OFF TIMER operation during ECONOMY operation.
 - ③ When the operation is retrieved from CLEAN operation.
- (b) When the following operation are set, ECONOMY operation will be canceled.
 - ① When the HI POWER/ECONO button is pressed again.
 - ② When the operation mode is changed DRY to FAN.
- (c) Not operable while the air-conditioner is OFF.
- (d) The setting temperature is adjusted according to the following table.

Item \ Mode	Cooling	Heating
Temperature adjustment	① +0.5	① -1.0
	② +1.0	② -2.0
	③ +1.5	③ -2.5

- ① at the start of operation.
- ② one hour after the start of operation.
- ③ two hours after the start of operation.

(7) Air flow direction adjustment



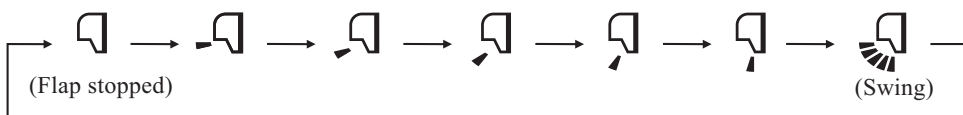

Air flow direction can be adjusted with by AIR FLOW  (UP/DOWN) button on the wireless remote control.

(a) Flap

Each time when you press the AIR FLOW  (UP/DOWN) button the mode changes as follows.



• Angle of flap from horizontal

Remote control display					
COOL, DRY, FAN	Approx. 15°	Approx. 25°	Approx. 35°	Approx. 45°	Approx. 59°
HEAT	Approx. 25°	Approx. 35°	Approx. 50°	Approx. 59°	Approx. 65°

(b) Swing

Flap moves in upward and downward directions continuously.

◆ In HEAT operation

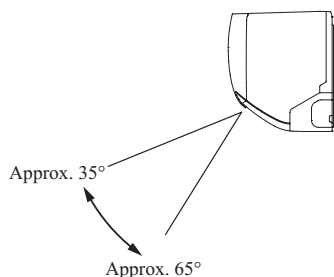

◆ In COOL, DRY, FAN operation

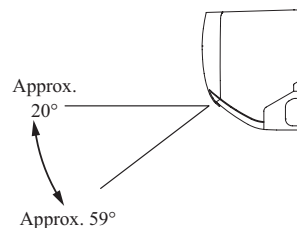

(c) Memory flap

When you press the AIR FLOW (UP/DOWN) button once while the flap is operating, it stops swinging at the position. Since this angle is memorized in the microcomputer, the flap will automatically be set at this angle when the next operation is started.

(d) When not operating

The flap returns to the position of air flow directly below, when operation has stopped.

(8) Timer operation

(a) Comfortable timer setting (ON timer)

If the timer is set at ON when the operation select switch is set at the cooling or heating, or the cooling or heating in auto mode operation is selected, the comfortable timer starts and determines the starting time of next operation based on the initial value of 15 minutes and the relationship between the room temperature at the setting time (temperature of room temperature sensor) and the setting temperature.

(b) Sleep timer operation

Pressing the SLEEP button causes the temperature to be controlled with respect to the set temperature.

(c) OFF timer operation

The Off timer can be set at a specific time (in 10-minute units) within a 24-hour period.

(9) Outline of heating operation

(a) Operation of major functional components in heating mode

	Heating			
	Thermostat ON	Thermostat OFF	Defrost	Failure
Compressor	ON	OFF	OFF	OFF
Indoor fan motor	ON	ON(HOT KEEP)	OFF	OFF
Outdoor fan motor	ON	OFF (few minutes ON)	OFF	OFF
4-way valve	ON	ON	OFF	OFF (3 minutes ON)

(b) Details of control at each operation mode (pattern)

(i) Fuzzy operation

Deviation between the room temperature setting correction temperature and the suction air temperature is calculated in accordance with the fuzzy rule, and used for control of the air capacity and the compressor speed.

Fan speed \ Model	SRK25ZSP-W	SRK35ZSP-W	SRK45, 50ZSP-W
AUTO	20-115rps		20-100rps
HI	20-115rps		20-100rps
MED	20-72rps	20-84rps	20-90rps
LO	20-54rps	20-62rps	20-58rps

When the defrost operation, protection device, etc. is actuated, operation is performed in the corresponding mode.

(ii) Hot keep operation

During the heating operation, the indoor fan speed can be controlled based on the temperature of the indoor heat exchanger (Th2) to prevent blowing of cold air.

(c) Defrost operation

(i) Starting conditions (Defrost operation can be started only when all of the following conditions are satisfied.)

- 1) After start of heating operation
When it elapsed 35 (model SRK35 : 45) minutes. (Total compressor operation time)
- 2) After end of defrost operation
When it elapsed 35 (model SRK35 : 45) minutes. (Total compressor operation time)
- 3) Outdoor heat exchanger temperature sensor (TH1) temperature
When the temperature has been -5°C or less for 3 minutes continuously.
- 4) The difference between the outdoor air temperature sensor temperature and the outdoor heat exchanger temperature sensor temperature is as follows.
 - $0^{\circ}\text{C} \leq \text{TH2}$: $\text{TH2}-\text{TH1} \geq 7^{\circ}\text{C}$, $\text{TH1} \leq \text{TH2}-7^{\circ}\text{C}$
 - $-15^{\circ}\text{C} \leq \text{TH2} < 0^{\circ}\text{C}$: $\text{TH2}-\text{TH1} \geq 2/15 \times \text{TH2} + 7^{\circ}\text{C}$, $\text{TH1} \leq 13/15 \times \text{TH2}-7^{\circ}\text{C}$
 - $\text{TH2} < -15^{\circ}\text{C}$: $\text{TH2}-\text{TH1} \geq -5^{\circ}\text{C}$, $\text{TH1} \leq \text{TH2} + 5^{\circ}\text{C}$

Models SRK25, 35, 45, 50ZSP-W

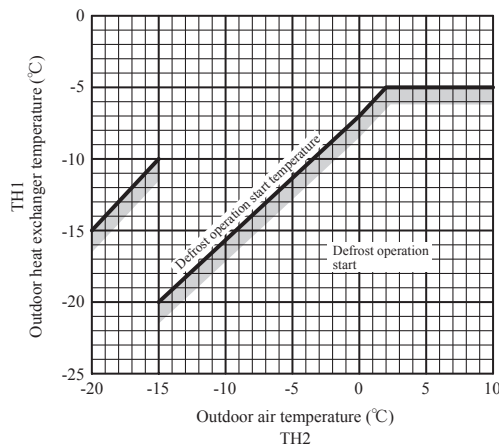

- 5) During continuous compressor operation
In case satisfied all of following conditions.
 - Connect compressor speed 0 rps 10 times or more.
 - Satisfy 1), 2) and 3) conditions above.
 - Outdoor air temperature is 3°C or less.

(ii) Ending conditions (Operation returns to the heating cycle when either one of the following is satisfied.)

- 1) Outdoor heat exchanger temperature sensor (TH1) temperature: 13°C or higher (SRK45, 50 : 10 °C)
- 2) Continued operation time of defrost operation → For more than 16 minutes and 50 seconds (models SRK45, 50 : 17 minutes and 30 seconds).

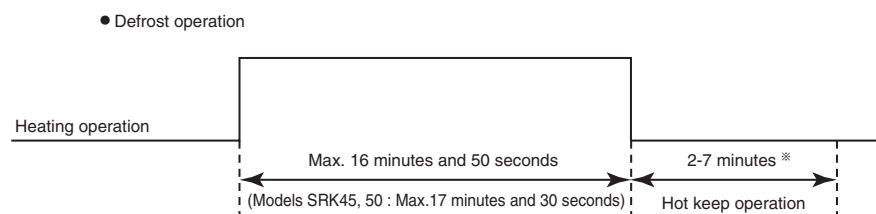

※Depends on an operation condition, the time can be longer than 7 minutes.

(10) Outline of cooling operation**(a) Operation of major functional components in cooling mode**

	Cooling		
	Thermostat ON	Thermostat OFF	Failure
Compressor	ON	OFF	OFF
Indoor fan motor	ON	ON	ON
Outdoor fan motor	ON	OFF (few minutes ON)	OFF (few minutes ON)
4-way valve	OFF	OFF	OFF

(b) Detail of control in each mode (Pattern)**(i) Fuzzy operation**

During the fuzzy operation, the air flow and the compressor speed are controlled by calculating the difference between the room temperature setting correction temperature and the suction air temperature.

Model	SRK25ZSP-W	SRK35ZSP-W	SRK45ZSP-W	SRK50ZSP-W
Fan speed				
AUTO	15-74rps	15-98rps	20-97rps	20-100rps
HI	15-74rps	15-98rps	20-97rps	20-100rps
MED	15-52rps	15-74rps	20-72rps	20-72rps
LO	15-38rps	15-46rps	20-44rps	20-44rps

(11) Outline of automatic operation**(a) Determination of operation mode**

The unit checks the indoor air temperature and the outdoor air temperature, determines the operation mode, and then begins in the automatic operation.

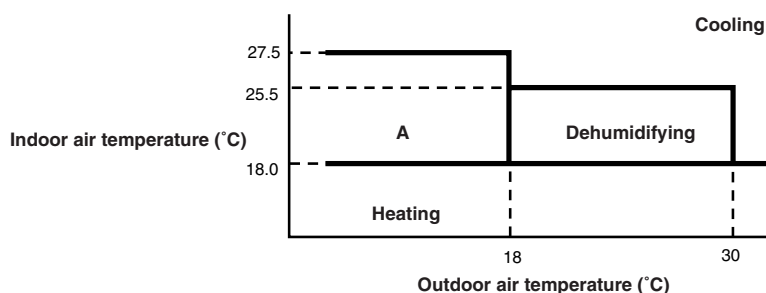

- (b) The unit checks the temperature every hour after the start of operation and, if the result of check is not same as the previous operation mode, changes the operation mode.
- (i) If the setting temperature is changed with the remote control, the operation mode is judged immediately.
- (ii) When both the indoor and the outdoor air temperatures are in the range “A”, cooling or heating is switched depending on the difference between the setting temperature and the indoor air temperature.
- (iii) When the operation mode has been judged following the change of setting temperature with the remote control, the hourly judgment of operation mode is cancelled.
- (c) When the unit is started again within one hour after the stop of automatic operation or when the automatic operation is selected during heating, cooling or dehumidifying operation, the unit is operated in the previous operation mode.
- (d) Setting temperature can be adjusted within the following range. There is the relationship as shown below between the signals of the wireless remote control and the setting temperature.

		Signals of wireless remote control (Display)												
		-6	-5	-4	-3	-2	-1	±0	+1	+2	+3	+4	+5	+6
Setting temperature	Cooling	18	19	20	21	22	23	24	25	26	27	28	29	30
	Dehumidifying	19	20	21	22	23	24	25	26	27	28	29	30	31
	Heating	20	21	22	23	24	25	26	27	28	29	30	31	32

- (e) When the unit is operated automatically with the wired remote control connected, the cooling operation is controlled according to the display temperatures while the setting temperature is compensated by + 1°C during dehumidifying or by + 2°C during heating.

(12) Protection control function

(a) Dew prevention control I [Cooling]

Prevents dewing on the indoor unit.

(i) Operating conditions

When the following conditions have been satisfied

- 1) Humidity is 78% or higher.

(ii) Contents of operation

	Maximum compressor speed
SRK25ZSP-W	68 rps
SRK35ZSP-W	73 rps
SRK45ZSP-W	87 rps
SRK50ZSP-W	87 rps

(iii) Reset condition

When either of the following condition is satisfied

- 1) Humidity is 73% or less.
- 2) Dew prevention control II has been satisfied.

(b) Dew prevention control II [Cooling]

Prevents dewing on the indoor unit.

(i) Operating conditions

When the following conditions have been satisfied for more than 30 minutes after starting operation

- 1) Compressor speed is 32 rps or higher. (SRK25, 35)
- 2) Humidity is 68% or higher. (SRK45, 50 : 60%)

(ii) Contents of operation

- 1) Air capacity control

Item		Model	SRK25, 35ZSP-W	SRK45, 50ZSP-W
LO	Upper limit of compressor speed		RangeA: 41rps, RangeB: 41rps	RangeA: 57rps, RangeB: 39rps
	Indoor fan		4th speed (SRK35 : 5th speed)	
AUTO,HI,MED	Upper limit of compressor speed		RangeA: 41rps, RangeB: 41rps	RangeA: 57rps, RangeB: 39rps
	Indoor fan		Adaptable to compressor speed (Lower limit 4th speed)	

Note (1) Ranges A and B are as shown below.

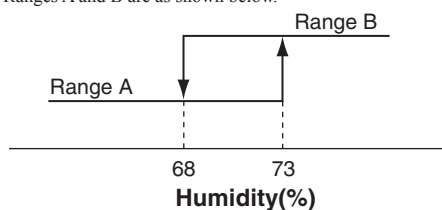

- 2) When this control has continued for more than 30 minutes continuously, the following wind direction control is performed.

- a) When the vertical wind direction is set at other than the vertical swing, the flaps change to the horizontal position.
- b) When the horizontal wind direction is set at other than the horizontal swing, the louver changes to the vertical position.

(iii) Reset condition

When any of followings is satisfied

- Humidity is less than 63%. (SRK45, 50 : 55%)

(c) Frost prevention control (During cooling or dehumidifying)

(i) Operating conditions

- 1) Indoor heat exchanger temperature (Th2) is lower than 5°C.
- 2) 5 minutes after reaching the compressor speed except 0 rps.

(ii) Detail of anti-frost operation

Indoor heat exchanger temperature	5°C or lower	2.5°C or lower
Item		
Lower limit of compressor speed	22rps (SRK45, 50 : 23 rps)	0 rps
Indoor fan	Depends on operation mode	Protects the fan tap just before frost prevention control
Outdoor fan	Depends on compressor speed	Depends on stop mode
4-way valve	OFF	

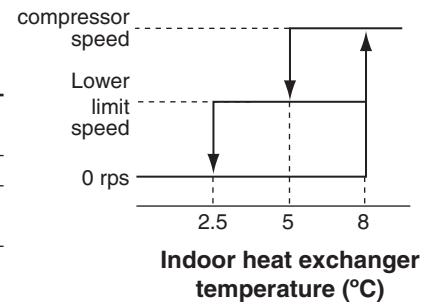

- Notes
- (1) When the indoor heat exchanger temperature is in the range of 2.5-5°C, the speed is reduced by 4 rps at each 20 seconds.
 - (2) When the temperature is lower than 2.5°C, the compressor is stopped.
 - (3) When the indoor heat exchanger temperature is in the range of 5-8°C, the compressor speed is been maintained.

(iii) Reset conditions

When either of the following condition is satisfied

- 1) The indoor heat exchanger temperature (Th2) is 8°C or higher.
- 2) The compressor speed is 0 rps.

(d) Cooling overload protective control

(i) Operating conditions

When the outdoor air temperature (TH2) has become continuously for 30 seconds at 41°C or more, or 47°C or more with the compressor running, the lower limit speed of compressor is brought up.

Item	SRK25, 35ZSP-W		SRK45, 50ZSP-W		
	Model				
Outdoor air temperature		41°C or more	47°C or more	41°C or more	47°C or more
Lower limit speed		30 rps	45 rps	27 rps	35 rps

(ii) Detail of operation

- 1) The outdoor fan is stepped up by 3 speed step. (Upper limit; 8th speed.)
- 2) The lower limit of compressor speed is set to 30 or 45(models SRK45,50 : 27 or 35 rps). However, when the thermo OFF, the speed is reduced to 0 rps.

(iii) Reset conditions

When either of the following condition is satisfied

- 1) The outdoor air temperature is lower than 40°C.
- 2) The compressor speed is 0 rps.

(e) Cooling high pressure control

(i) Purpose

Prevents anomalous high pressure operation during cooling.

(ii) Detector

Outdoor heat exchanger temperature sensor (TH1)

(iii) Detail of operation

(Example) Fuzzy

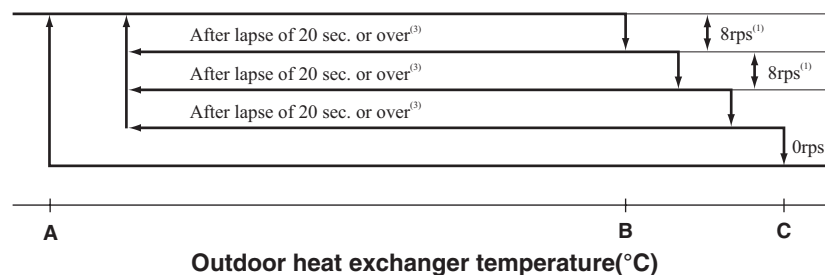

- Notes (1) When the outdoor heat exchanger temperature is in the range of B-C °C, the speed is reduced by 8 rps at each 20 seconds.
 (2) When the temperature is C °C or higher, the compressor is stopped.
 (3) When the outdoor heat exchanger temperature is in the range of A-B °C, if the compressor speed is been maintained and the operation has continued for more than 20 seconds at the same speed, it returns to the normal cooling operation.

● Temperature list

	SRK25, 35			SRK45, 50		
	A	B	C	A	B	C
Outdoor air temperature ≥ 32 °C	53	58	63	48	53	55
Outdoor air temperature < 32 °C	40	43	46	53	58	63

(f) Cooling low outdoor air temperature protective control

(i) Operating conditions

When the outdoor air temperature (TH2) is 22°C or lower continues for 20 seconds while the compressor speed is other than 0 rps.

(ii) Detail of operation

- 1) It controls the upper and lower limit values for the compressor speed according to the following table.
- 2) It checks the outdoor temperature (TH2) once every hour to judge the operation range.

	Compressor speed: Upper/lower limit (rps)						
	Lower 1		Upper 1	Lower 2	Upper 2	Lower 3	Upper 3
	Range B	Range A					
SRK25, 35	30	Release	60	44	50	50	50
SRK45, 50	27	Release	60	44	50	44	50

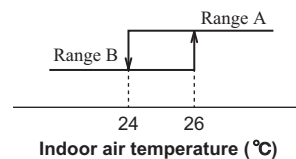
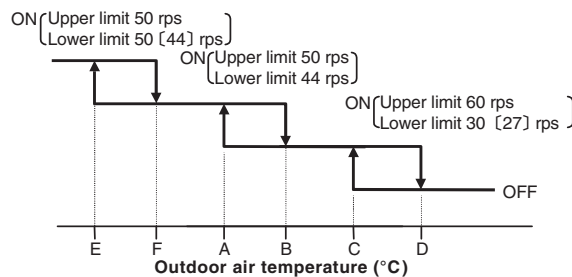

● Values of A, B, C, D, E, F (Models SRK25, 35)

	Outdoor air temperature (°C)					
	E	F	A	B	C	D
First time	-8	-5	0	3	22	25
After the second times	-2	1	5	8	25	28

● Values of A, B, C, D, E, F (Models SRK45, 50)

	Outdoor air temperature (°C)					
	E	F	A	B	C	D
First time	0	2	9	11	22	25
After the second times	5	7	16	19	25	28

(iii) Reset conditions

When either of the following condition is satisfied

- 1) The outdoor air temperature (TH2) is D °C or higher.
- 2) The compressor speed is 0 rps.

(g) Heating high pressure control

(i) Purpose

Prevents anomalous high pressure operation during heating.

(ii) Detector

Indoor heat exchanger sensor (Th2)

(iii) Detail of operation

(Example) Fuzzy

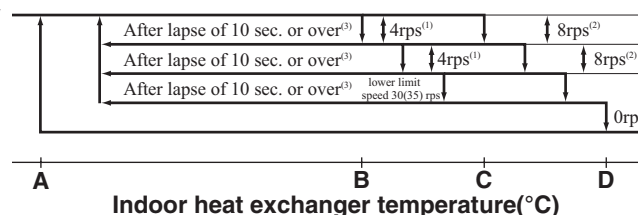

- Notes
- (1) When the indoor heat exchanger temperature is in the range of B-C °C, the speed is reduced by 4 rps at each 10 seconds.
 - (2) When the indoor heat exchanger temperature is in the range of C-D °C, the speed is reduced by 8 rps at each 10 seconds. When the temperature is D °C or higher continues for 1 minute, the compressor is stopped.
 - (3) When the indoor heat exchanger temperature is in the range of A-B °C, if the compressor speed is been maintained and the operation has continued for more than 10 seconds at the same speed, it returns to the normal heating operation.
 - (4) Indoor fan retains the fan speed when it enters in the high pressure control. Outdoor fan is operated in accordance with the speed.

● **Temperature list**

Models SRK25, 35

Unit : °C

	A	B	C	D
RPSmin < 50	47	52	54	55
50 ≤ RPSmin < 92	47.5	55	57	61
92 ≤ RPSmin ≤ 115	47.5-39.0	55.0-40.0	57.0-42.0	61

Models SRK45, 50

Unit : °C

	A	B	C
RPSmin < 30	45	49	50
30 ≤ RPSmin < 40	45-49	49-55	50-57
40 ≤ RPSmin < 80	49	55	57
80 ≤ RPSmin < 90	49-48	55-53	57-55
90 ≤ RPSmin < 100	48-37	53-42	55-44

Unit : °C

	D
RPSmin < 35	55.5
35 ≤ RPSmin < 40	55.5-62
40 ≤ RPSmin < 80	62
80 ≤ RPSmin < 95	62-56
95 ≤ RPSmin < 100	56-50.5

(h) Heating overload protective control

(i) Indoor unit side

1) Operating conditions

When the outdoor air temperature (TH2) is 17°C or higher continues for 30 seconds while the compressor speed other than 0 rps.

2) Detail of operation

The indoor fan speed is stepped up by 1 speed step. (Upper limit 8th speed)

3) Reset conditions

The outdoor air temperature (TH2) is lower than 16°C.

(ii) Outdoor unit side

1) Operating conditions

When the outdoor air temperature (TH2) is 22 (11 or 20)°C or higher continues for 30 seconds while the compressor speed other than 0 rps.

2) Detail of operation

Upper and lower limits of compressor speed and the outdoor unit fan speed are restricted.

Models SRK25, 35

	Compressor command speed (rps)			Outdoor fan speed
	Lower limit		Upper limit	
	Range A	Range B		
ON1	–	–	–	–
ON2	40	Release	60	2nd speed

Models SRK45, 50

	Compressor command speed (rps)			Outdoor fan speed
	Lower limit		Upper limit	
	Range A	Range B		
ON1	35	Release	85	It depends on compressor speed
ON2	35	35	55	2nd speed

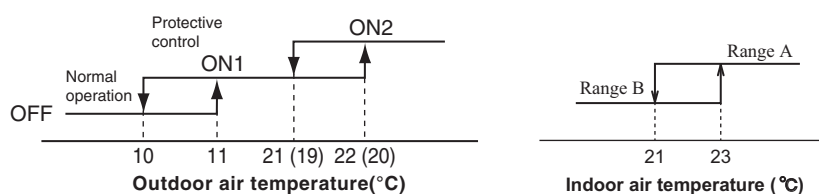

3) Reset conditions

When the outdoor air temperature drops below 19 (13)°C.

Note (1) Values in () are for the model SRK45, 50.

(i) Heating low outdoor temperature protective control

(i) Protective control I

1) Operating conditions

When the outdoor air temperature (TH2) is 2 (-8)°C or lower continues for 30 seconds while the compressor speed is other than 0 rps.

2) Detail of operation

The lower limit compressor speed is changed as shown in the figure below.

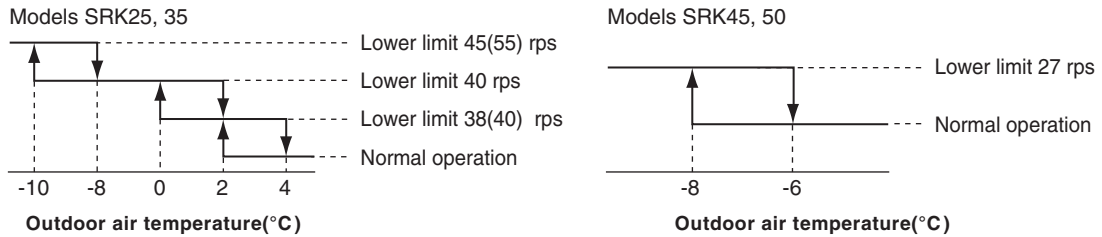

3) Reset conditions

When either of the following condition is satisfied

- a) The outdoor air temperature (TH2) becomes 4 (-6)°C.
- b) The compressor speed is 0 rps.

Note (1) Values in () are for the model SRK35.

(j) Compressor overheat protection

(i) Purpose

It is designed to prevent deterioration of oil, burnout of motor coil and other trouble resulting from the compressor over-heat.

(ii) Detail of operation

1) Speeds are controlled with temperature detected by the sensor mounted on the discharge pipe.

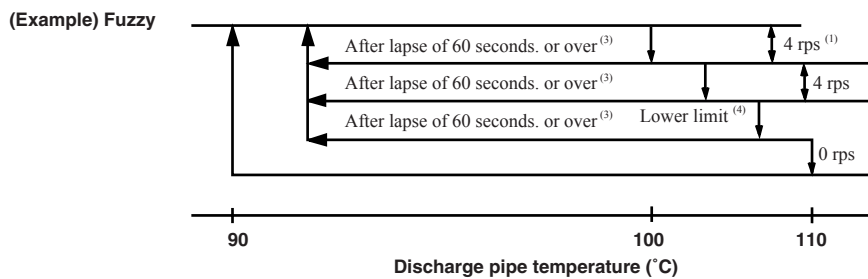

- Notes
- (1) When the discharge pipe temperature is in the range of 100 to 110 °C, the speed is reduced by 4 rps.
 - (2) When the discharge pipe temperature is raised and continues operation for 20 seconds without changing, then the speed is reduced again by 4 rps.
 - (3) If the discharge pipe temperature is in the range of 90-100°C even when the compressor speed is maintained for 60 second when the temperature is in the range of 90-100°C, the speed is raised by 1 rps and kept at that speed for 60 second. This process is repeated until the compressor speed is reached.
 - (4) Lower limit speed

	Cooling	Heating
Models SRK25, 35	15 rps	20 rps
Models SRK45, 50	20 rps	30 rps

- 2) If the temperature of 110°C is detected by the sensor on the discharge pipe, then the compressor will stop immediately. When the discharge pipe temperature drops and 3 minutes has elapsed, the unit starts again within 1 hour but there is no start at the third time.

(k) Current safe**(i) Purpose**

Current is controlled not to exceed the upper limit of the setting operation current.

(ii) Detail of operation

Input current to the converter is monitored with the current sensor fixed on the printed circuit board of the outdoor unit and, if the operation current value reaches the limiting current value, the compressor speed is reduced.

If the mechanism is actuated when the compressor speed is less than 30 rps, the compressor is stopped immediately.

Operation starts again after 3 minutes.

(l) Current cut**(i) Purpose**

Inverter is protected from overcurrent.

(ii) Detail of operation

Output current from the inverter is monitored with a shunt resistor and, if the current exceeds the setting value, the compressor is stopped immediately. Operation starts again after 3 minutes.

(m) Outdoor unit failure

This is a function for determining when there is trouble with the outdoor unit during air-conditioning.

The compressor is stopped if any one of the following in item (i), (ii) is satisfied. Once the unit is stopped by this function, it is not restarted.

- (i) When the input current is measured at 1 A or less for 3 continuous minutes or more.
- (ii) If the outdoor unit sends a 0 rps signal to the indoor unit 3 times or more within 20 minutes of the power being turned on.

(n) Indoor fan motor protection

When the air-conditioner is operating and the indoor fan motor is turned ON, if the indoor fan motor has operated at 300 min⁻¹ or under for more than 30 seconds, the unit enters first in the stop mode and then stops the entire system.

(o) Serial signal transmission error protection**(i) Purpose**

Prevents malfunction resulting from error on the indoor ↔ outdoor signals.

(ii) Detail of operation

If the compressor is operating and a serial signal cannot be received from the indoor control with outdoor control having serial signals continues for 7 minutes and 35 seconds, the compressor is stopped.

After the compressor has been stopped, it will be restarted after the compressor start delay if a serial signal can be received again from the indoor control.

(p) Rotor lock

If the motor for the compressor does not turn after it has been started, it is determined that a compressor lock has occurred and the compressor is stopped.

(q) Outdoor fan motor protection

If the outdoor fan motor has operated at 75 min⁻¹ or under for more than 30 seconds, the compressor and fan motor are stopped.

(r) Outdoor fan control at low outdoor temperature

(i) Cooling

1) Operating conditions

When the outdoor air temperature (TH2) is 22°C or lower continues for 30 seconds while the compressor speed is other than 0 rps.

2) Detail of operation

After the outdoor fan operates at A speed for 60 seconds; the corresponding outdoor heat exchanger temperature shall implement the following controls.

● Value of A

	Outdoor fan
Outdoor temperature > 10°C	2nd speed
Outdoor temperature ≤ 10°C	1st speed

a) Outdoor heat exchanger temperature (TH1) ≤ 21°C

After the outdoor fan speed drops (down) to 1 speed for 60 seconds; if the outdoor heat exchanger temperature is lower than 21°C, gradually reduce the outdoor fan speed by 1 speed. (Lower limit 1st speed)

b) 21°C < Outdoor heat exchanger temperature (TH1) ≤ 38°C

After the outdoor fan speed maintains at A speed for 20 seconds; if the outdoor heat exchanger temperature is 21°C -38°C, maintain outdoor fan speed.

c) Outdoor heat exchanger temperature (TH1) > 38°C

After the outdoor fan speed rises (up) to 1 speed for 60 seconds; if the outdoor heat exchanger temperature is higher than 38°C, gradually increase outdoor fan speed by 1 speed. (Upper limit 3rd speed)

3) Reset conditions

When either of the following conditions is satisfied

- a) The outdoor air temperature (TH2) is 24°C or higher.
- b) The compressor speed is 0 rps.

(ii) Heating

1) Operating conditions

When the outdoor air temperature (TH2) is 4°C (models SRK45, 50:0 °C) or lower continues for 30 seconds while the compressor speed is other than 0 rps.

2) Detail of operation

The outdoor fan is stepped up by 2 speed step at each 20 seconds. (Upper limit; models SRK25, 35 : refer to belows, models SRK45, 50 : 8th speed)

SRK25, 35	Th1<21°C	Th1≥21°C
ON1	8th speed	8th speed
ON2	9th(8th) speed	8th speed

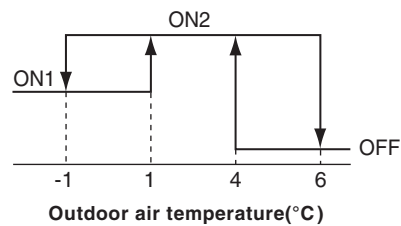

Note (1) Values in () are for the model SRK35.

3) Reset conditions

When either of the following conditions is satisfied

- a) The outdoor air temperature (TH2) is 6°C (models SRK45, 50:2 °C) or higher.
- b) The compressor speed is 0 rps.

(s) Refrigeration cycle system protection**(i) Starting conditions**

- 1) When 5 minutes have elapsed after the compressor ON or the completion of the defrost operation
- 2) Other than the defrost operation
- 3) When, after satisfying the conditions of 1) and 2) above, the compressor speed, indoor air temperature (Th1) and indoor heat exchanger temperature (Th2) have satisfied the conditions in the following table for 10 (SRK45, 50 : 5) minutes:

Operation mode	Compressor speed (N)	Indoor air temperature (Th1)	Room temperature (Th1)/ Indoor heat exchanger temperature (Th2)
Cooling	$50 \leq N$	$10 \leq Th1 \leq 40$	$Th1 - 4 < Th2$
Heating(1)	$50 \leq N$	$0 \leq Th1 \leq 40$	$Th2 < Th1 + 6$

Note (1) Except that the fan speed is HI in heating operation.

(ii) Contents of control

- 1) When the conditions of (i) above are satisfied, the compressor stops.
- 2) Error stop occurs when the compressor has stopped 3 times within 60 minutes.

(iii) Reset condition

When the compressor has been turned OFF.

10. MAINTENANCE DATA

(1) Cautions

- (a) If you are disassembling and checking an air-conditioner, be sure to turn off the power before beginning. When working on indoor units, let the unit sit for about 1 minute after turning off the power before you begin work. When working on an outdoor unit, there may be an electrical charge applied to the main circuit (electrolytic condenser), so begin work only after discharging this electrical charge (to DC 10 V or lower).
- (b) When taking out printed circuit boards, be sure to do so without exerting force on the circuit boards or package components.
- (c) When disconnecting and connecting connectors, take hold of the connector housing and do not pull on the lead wires.

(2) Items to check before troubleshooting

- (a) Have you thoroughly investigated the details of the trouble which the customer is complaining about?
- (b) Is the air-conditioner running? Is it displaying any self-diagnosis information?
- (c) Is a power source with the correct voltage connected?
- (d) Are the control lines connecting the indoor and outdoor units wired correctly and connected securely?
- (e) Is the outdoor unit's service valve open?

(3) Troubleshooting procedure (If the air-conditioner does not run at all)

If the air-conditioner does not run at all, diagnose the trouble using the following troubleshooting procedure. If the air-conditioner is running but breaks down, proceed to troubleshooting step (4).

Important When all the following conditions are satisfied, we say that the air-conditioner will not run at all.

- (a) The RUN light does not light up.
- (b) The flaps do not open.
- (c) The indoor unit fan motors do not run.
- (d) The self-diagnosis display does not function.

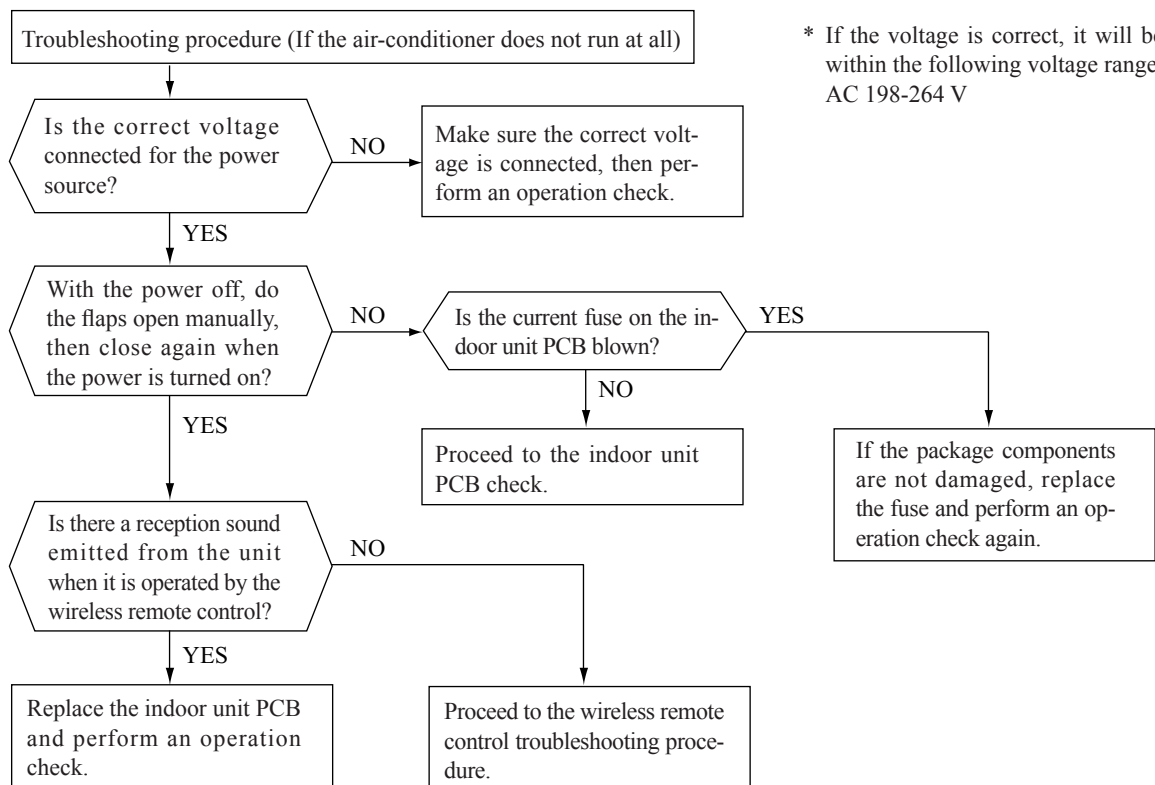

(4) Troubleshooting procedure (If the air-conditioner runs)

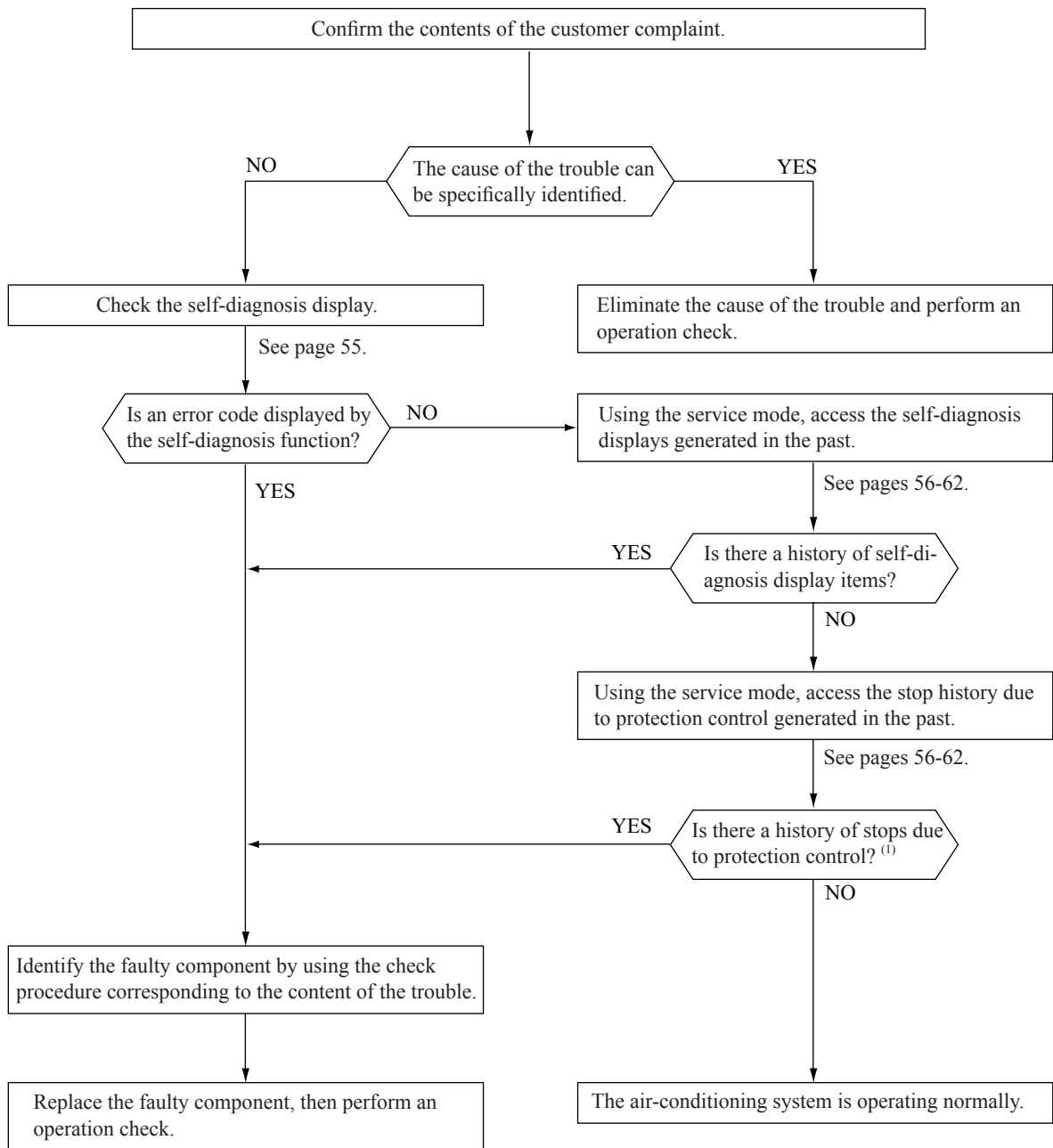

Note (1) Even in cases where only intermittent stop data are generated, the air-conditioning system is normal. However, if the same protective operation recurs repeatedly (3 or more times), it will lead to customer complaints. Judge the conditions in comparison with the contents of the complaints.

(5) Self-diagnosis table

When this air-conditioner performs an emergency stop, the reason why the emergency stop occurred is displayed by the flashing of display lights. If the air-conditioner is operated using the wireless remote control 3 minutes or more after the emergency stop, the trouble display stops and the air-conditioner resumes operation. ⁽¹⁾

Indoor unit display section		Description of trouble	Cause	Display (flashing) condition
RUN light	TIMER light			
1 - time flash	ON	Indoor heat exchanger temperature sensor error	<ul style="list-style-type: none"> Broken heat exchanger temperature sensor wire, poor connector connection Indoor unit PCB is faulty 	When a heat exchanger temperature sensor wire disconnection is detected while operation is stopped. (If a temperature of -28°C or lower is detected for 15 seconds, it is judged that the wire is disconnected.) (Not displayed during operation.)
2 - time flash	ON	Room temperature sensor error	<ul style="list-style-type: none"> Broken room temperature sensor wire, poor connector connection Indoor unit PCB is faulty 	When a room temperature sensor wire disconnection is detected while operation is stopped. (If a temperature of -45°C or lower is detected for 15 seconds, it is judged that the wire is disconnected.) (Not displayed during operation.)
5 - time flash	ON	Active filter voltage error	<ul style="list-style-type: none"> Defective active filter 	When the wrong voltage connected for the power source. When the outdoor unit PCB is faulty.
6 - time flash	ON	Indoor fan motor error	<ul style="list-style-type: none"> Defective fan motor, poor connector connection 	When conditions for turning the indoor unit's fan motor on exist during air-conditioner operation, an indoor unit fan motor speed of 300 min^{-1} or lower is measured for 30 seconds or longer. (The air-conditioner stops.)
7 - time flash	ON	Refrigeration cycle system protective control	<ul style="list-style-type: none"> Service valve is closed. Refrigerant is insufficient 	When refrigeration cycle system protective control operates.
Keeps flashing	1 - time flash	Outdoor air temperature sensor error	<ul style="list-style-type: none"> Broken outdoor air temperature sensor wire, poor connector connection Outdoor unit PCB is faulty 	-55°C or lower is detected for 5 seconds continuously 3 times within 40 minutes after initial detection of this anomalous temperature. Or -55°C or higher is detected for within 20 seconds after power ON. (The compressor is stopped.)
Keeps flashing	2 - time flash	Outdoor heat exchanger temperature sensor error	<ul style="list-style-type: none"> Broken heat exchanger temperature sensor wire, poor connector connection Outdoor unit PCB is faulty 	-55°C or lower is detected for 5 seconds continuously 3 times within 40 minutes after initial detection of this anomalous temperature. Or -55°C or higher is detected for within 20 seconds after power ON. (The compressor is stopped.)
Keeps flashing	4 - time flash	Discharge pipe temperature sensor error	<ul style="list-style-type: none"> Broken discharge pipe temperature sensor wire, poor connector connection Outdoor unit PCB is faulty 	-25°C or lower is detected for 5 seconds continuously 3 times within 40 minutes after initial detection of this anomalous temperature. (The compressor is stopped.)
ON	1 - time flash	Current cut	<ul style="list-style-type: none"> Compressor locking, open phase on compressor output, short-circuit on power transistor, closed service valve 	The compressor output current (compressor motor current) exceeds the set value during compressor start. (The air-conditioner stops.)
ON	2 - time flash	Trouble of outdoor unit	<ul style="list-style-type: none"> Broken compressor wire Compressor blockage 	When there is an emergency stop caused by trouble in the outdoor unit, or the input current value is found to be lower than the set value. (The air-conditioner stops.)
ON	3 - time flash	Current safe stop	<ul style="list-style-type: none"> Overload operation Overcharge Compressor locking 	When the compressor speed is lower than the set value and the current safe has operated. (The compressor is stopped.)
ON	4 - time flash	Power transistor error	<ul style="list-style-type: none"> Broken power transistor 	When there is an emergency stop caused by trouble in the outdoor unit, or the input current value is found to be lower than the set value continuously for 3 minutes or longer. (The compressor is stopped.)
ON	5 - time flash	Over heat of compressor	<ul style="list-style-type: none"> Gas shortage, defective discharge pipe temperature sensor, closed service valve 	When the value of the discharge pipe temperature sensor exceeds the set value. (The air-conditioner stops.)
ON	6 - time flash	Error of signal transmission	<ul style="list-style-type: none"> Defective power source, Broken signal wire, defective indoor/outdoor unit PCB 	When there is no signal between the indoor unit PCB and outdoor unit PCB for 10 seconds or longer (when the power is turned on), or when there is no signal for 7 minutes 35 seconds or longer (during operation) (The compressor is stopped).
ON	7 - time flash	Outdoor fan motor error	<ul style="list-style-type: none"> Defective fan motor, poor connector connection 	When the outdoor unit's fan motor speed continues for 30 seconds or longer at 75 min^{-1} or lower. (3 times) (The air-conditioner stops.)
ON	Keeps flashing	Cooling high pressure protection	<ul style="list-style-type: none"> Overload operation, overcharge Broken outdoor heat exchange temperature sensor wire Service valve is closed. 	When the value of the outdoor heat exchanger temperature sensor exceeds the set value.
2 - time flash	2 - time flash	Rotor lock	<ul style="list-style-type: none"> Defective compressor Open phase on compressor Defective outdoor unit PCB 	If the compressor motor's magnetic pole positions cannot be correctly detected when the compressor starts. (The air-conditioner stops.)

Note (1) The air-conditioner cannot be restarted using the wireless remote control for 3 minutes after operation stops.

(6) Service mode (Trouble mode access function)

This air-conditioner is capable of recording error displays and protective stops (service data) which have occurred in the past. If self-diagnosis displays cannot be confirmed, it is possible to get a grasp of the conditions at the time trouble occurred by checking these service data.

(a) Explanation of terms

Term	Explanation
Service mode	The service mode is the mode where service data are displayed by flashing of the display lights when the operations in item (b) below are performed with the indoor control.
Service data	These are the contents of error displays and protective stops which occurred in the past in the air-conditioner system. Error display contents and protective stop data from past anomalous operations of the air-conditioner system are saved in the indoor unit control's non-volatile memory (memory which is not erased when the power goes off). There are two types of data, self-diagnosis data and stop data, described below.
Self-diagnosis data	These are the data which display the reason why a stop occurred when an error display (self-diagnosis display) occurred in an indoor unit. Data are recorded for up to 5 previous occurrences. Data which are older than the 5th previous occurrence are erased. In addition, data on the temperature of each sensor (room temperature, indoor heat exchanger, outdoor heat exchanger, outdoor air temperature, discharge pipe), wireless remote control information (operation switching, fan speed switching) are recorded when trouble occurs, so more detailed information can be checked.
Stop data	These are the data which display the reason by a stop occurred when the air-conditioning system performed protective stops, etc. in the past. Even if stop data alone are generated, the system restarts automatically. (After executing the stop mode while the display is normal, the system restarts automatically.) Data for up to 10 previous occasions are stored. Data older than the 10th previous occasion are erased. (Important) In cases where transient stop data only are generated, the air-conditioner system may still be normal. However, if the same protective stop occurs frequently (3 or more times), it could lead to customer complaints.

(b) Service mode display procedure

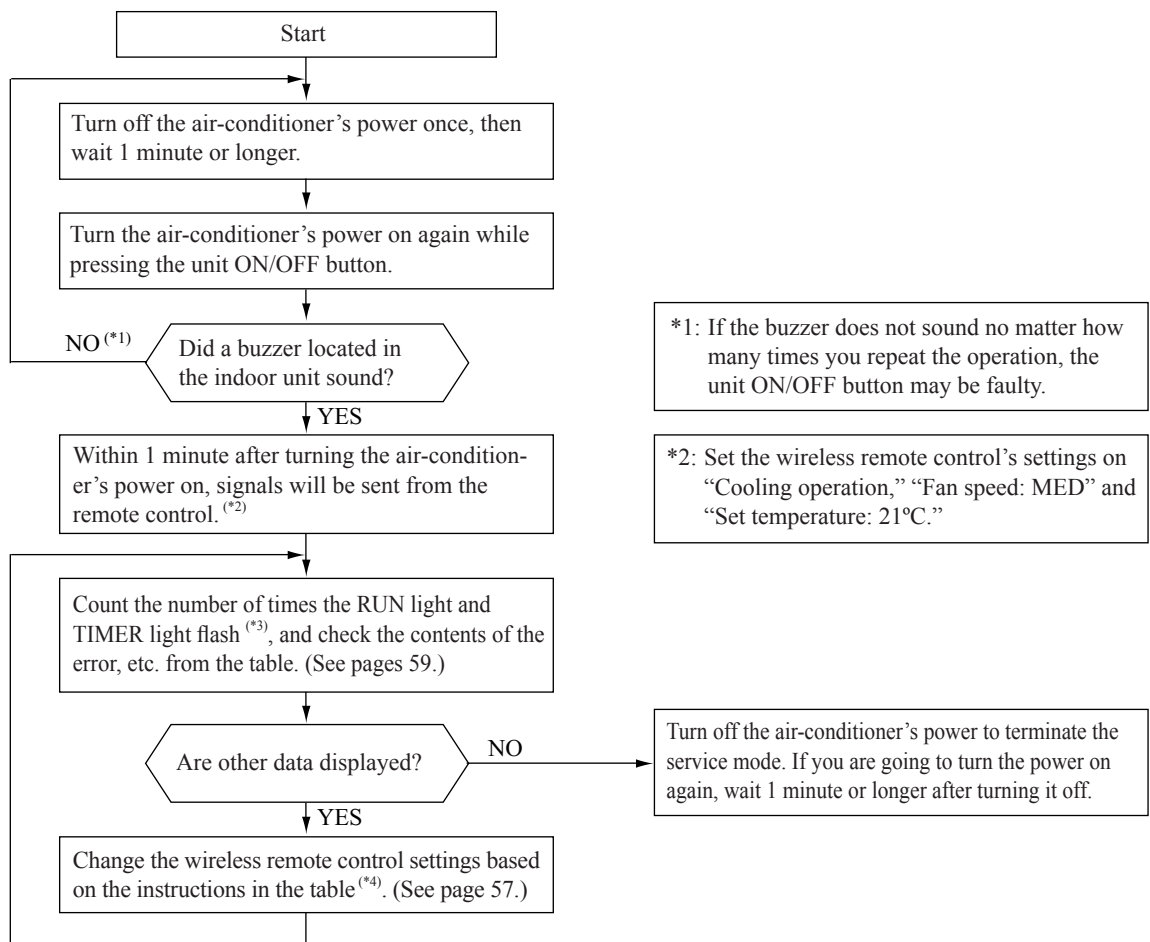

*3: To count the number of flashes in the service mode, count the number of flashes after the light lights up for 1.5 second initially (start signal). (The time that the light lights up for 1.5 second (start signal) is not counted in the number of flashes.)

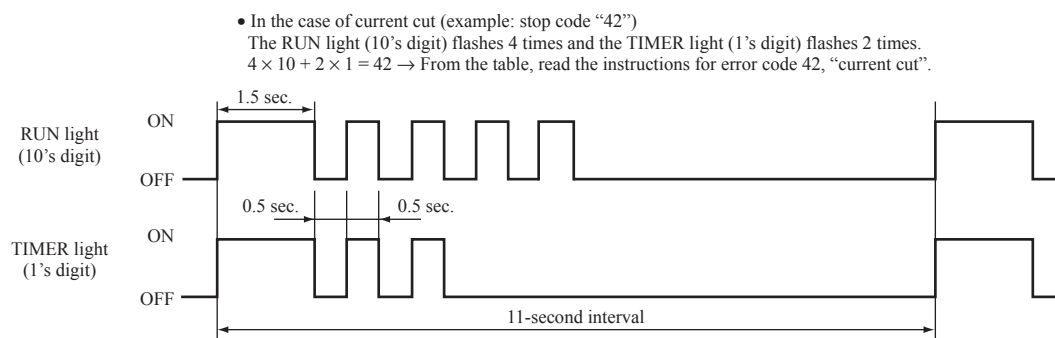

*4: When in the service mode, when the remote control settings (operation switching, fan speed switching, temperature setting) are set as shown in the following table and sent to the air-conditioner unit, the unit switches to display of service data.

① **Self-diagnosis data**

What are Self-diagnosis data?

These are control data (reasons for stops, temperature at each sensor, wireless remote control information) from the time when there were error displays (abnormal stops) in the indoor unit in the past. Data from up to 5 previous occasions are stored in memory. Data older than the 5th previous occasion are erased. The temperature setting indicates how many occasions previous to the present setting the error display data are and the operation switching and fan speed switching data show the type of data.

Remote control setting		Contents of output data
Operation switching	Fan speed switching	
Cooling	MED	Displays the reason for stopping display in the past (error code).
	HI	Displays the room temperature sensor temperature at the time the error code was displayed in the past.
	AUTO	Displays the indoor heat exchanger temperature sensor temperature at the time the error code was displayed in the past.
Heating	LO	Displays the remote control information at the time the error code was displayed in the past.
	MED	Displays the outdoor air temperature sensor temperature at the time the error code was displayed in the past.
	HI	Displays the outdoor heat exchanger temperature sensor temperature at the time the error code was displayed in the past.
	AUTO	Displays the discharge pipe temperature sensor temperature at the time the error code was displayed in the past.

Remote control setting	Indicates the number of occasions previous to the present the error display data are from.
Temperature setting	
21°C	1 time previous (previous time)
22°C	2 times previous
23°C	3 times previous
24°C	4 times previous
25°C	5 times previous

(Example)

Remote control setting			Displayed data
Operation switching	Fan speed switching	Temperature setting	
Cooling	MED	21°C	Displays the reason for the stop (error code) the previous time an error was displayed.
		22°C	Displays the reason for the stop (error code) 2 times previous when an error was displayed.
		23°C	Displays the reason for the stop (error code) 3 times previous when an error was displayed.
		24°C	Displays the reason for the stop (error code) 4 times previous when an error was displayed.
		25°C	Displays the reason for the stop (error code) 5 times previous when an error was displayed.

② Stop data

Remote control setting			Displayed data
Operation switching	Fan speed switching	Temperature setting	
Cooling	LO	21°C	Displays the reason for the stop (stop code) the previous time when the air-conditioner was stopped by protective stop control.
		22°C	Displays the reason for the stop (stop code) 2 times previous when the air-conditioner was stopped by protective stop control.
		23°C	Displays the reason for the stop (stop code) 3 times previous when the air-conditioner was stopped by protective stop control.
		24°C	Displays the reason for the stop (stop code) 4 times previous when the air-conditioner was stopped by protective stop control.
		25°C	Displays the reason for the stop (stop code) 5 times previous when the air-conditioner was stopped by protective stop control.
		26°C	Displays the reason for the stop (stop code) 6 times previous when the air-conditioner was stopped by protective stop control.
		27°C	Displays the reason for the stop (stop code) 7 times previous when the air-conditioner was stopped by protective stop control.
		28°C	Displays the reason for the stop (stop code) 8 times previous when the air-conditioner was stopped by protective stop control.
		29°C	Displays the reason for the stop (stop code) 9 times previous when the air-conditioner was stopped by protective stop control.
		30°C	Displays the reason for the stop (stop code) 10 times previous when the air-conditioner was stopped by protective stop control.

(c) Error code, stop code table (Assignment of error codes and stop codes is done in common for all models.)

Number of flashes when in service mode		Stop code or Error code	Error content	Cause	Occurrence conditions	Error display	Auto recovery
RUN light (10's digit)	TIMER light (1's digit)						
OFF	OFF	0	Normal	—	—	—	—
	5 - time flash	05	Can not receive signals for 35 seconds (if communications have recovered)	Power source is faulty. Power source cables and signal lines are improperly wired. Indoor or outdoor unit PCB are faulty.	When 35 seconds passes without communications signals from either the outdoor unit or the indoor unit being detected correctly.	○	—
3 - time flash	5 - time flash	35	Cooling high pressure control	Cooling overload operation. Outdoor unit fan speed drops. Outdoor heat exchanger temperature sensor is short-circuit.	When the outdoor heat exchanger temperature sensor's value exceeds the set value.	○ (5 times)	○
	6 - time flash	36	Compressor overheat 110°C	Refrigerant is insufficient. Discharge pipe temperature sensor is faulty. Service valve is closed.	When the discharge pipe temperature sensor's value exceeds the set value.	○ (2 times)	○
	7 - time flash	37	Outdoor heat exchanger temperature sensor is abnormal	Outdoor heat exchanger temperature sensor wire is disconnected. Connector connections are poor. Outdoor unit PCB is faulty.	-55°C or lower is detected for 5 seconds continuously 3 times within 40 minutes after initial detection of this anomalous temperature. Or -55°C higher is detected for 5 seconds continuously within 20 seconds after power ON.	○ (3 times)	○
	8 - time flash	38	Outdoor air sensor is abnormal	Outdoor air temperature sensor wire is disconnected. Connector connections are poor. Outdoor PCB is faulty.	-55°C or lower is detected for 5 seconds continuously 3 times within 40 minutes after initial detection of this anomalous temperature. Or -55°C higher is detected for 5 seconds continuously within 20 seconds after power ON.	○ (3 times)	○
	9 - time flash	39	Discharge pipe temperature sensor is abnormal (anomalous stop)	Discharge pipe temperature sensor wire is disconnected. Connector connections are poor. Outdoor unit PCB is faulty.	-25°C or lower is detected for 5 seconds continuously 3 times within 40 minutes after initial detection of this anomalous temperature.	○ (3 times)	○
4 - time flash	2 - time flash	42	Current cut	Compressor lock. Compressor wiring short-circuit. Compressor output is open phase. Outdoor unit PCB is faulty. Service valve is closed. Electronic expansion valve is faulty. Compressor is faulty.	Compressor start fails 42 times in succession and the reason for the final failure is current cut.	○ (2 times)	○
	7 - time flash	47	Active filter voltage error	Defective active filter.	When the wrong voltage connected for the power source. When the outdoor unit PCB is faulty.	○	—
	8 - time flash	48	Outdoor unit's fan motor is abnormal	Outdoor fan motor is faulty. Connector connections are poor. Outdoor unit PCB is faulty.	When a fan speed of 75 min ⁻¹ or lower continues for 30 seconds or longer.	○ (3 times)	○
5 - time flash	1 - time flash	51	Short-circuit in the power transistor (high side) Current cut circuit breakdown	Outdoor unit PCB is faulty. Power transistor is damaged.	When it is judged that the power transistor was damaged at the time the compressor started.	○	—
	7 - time flash	57	Refrigeration cycle system protective control	Service valve is closed. Refrigerant is insufficient.	When refrigeration cycle system protective control operates.	○ (3 times)	○
	8 - time flash	58	Current safe	Refrigerant is overcharge. Compressor lock. Overload operation.	When there is a current safe stop during operation.	—	○
	9 - time flash	59	Compressor wiring is unconnection Voltage drop Low speed protective control	Compressor wiring is disconnected. Power transistor is damaged. Power source construction is defective. Outdoor unit PCB is faulty. Compressor is faulty.	When the current is 1A or less at the time the compressor started. When the power source voltage drops during operation. When the compressor command speed is lower than 32 rps for 60 minutes.	○	○
6 - time flash	OFF	60	Rotor lock	Compressor is faulty. Compressor output is open phase. Electronic expansion valve is faulty. Overload operation. Outdoor unit PCB is faulty.	After the compressor starts, when the compressor stops due to rotor lock.	○ (2 times)	○
	1 - time flash	61	Connection lines between the indoor and outdoor units are faulty	Connection lines are faulty. Indoor or outdoor unit PCB are faulty.	When 10 seconds passes after the power is turned on without communications signals from the indoor or outdoor unit being detected correctly.	○	—
	2 - time flash	62	Serial transmission error	Indoor or outdoor unit PCB are faulty. Noise is causing faulty operation.	When 7 minutes 35 seconds passes without communications signals from either the outdoor unit or the indoor unit being detected correctly.	○	—
8 - time flash	OFF	80	Indoor unit's fan motor is abnormal	Indoor fan motor is faulty. Connector connections are poor. Indoor unit PCB is faulty.	When the indoor unit's fan motor is detected to be running at 300 min ⁻¹ or lower speed with the fan motor in the ON condition while the air-conditioner is running.	○	—
	2 - time flash	82	Indoor heat exchanger temperature sensor is abnormal (anomalous stop)	Indoor heat exchanger temperature sensor wire is disconnected. Connector connections are poor.	When a temperature of -28°C or lower is sensed continuously for 40 minutes during heating operation. (The compressor stops.)	○	—
	4 - time flash	84	Anti-condensation control	High humidity condition. Humidity sensor is faulty.	Anti-condensation prevention control is operating.	—	○
	5 - time flash	85	Anti-frost control	Indoor unit fan speed drops. Indoor heat exchanger temperature sensor is broken wire.	When the anti-frost control operates and the compressor stops during cooling operation.	—	○
	6 - time flash	86	Heating high pressure control	Heating overload operation. Indoor unit fan speed drops. Indoor heat exchanger temperature sensor is short-circuit.	When high pressure control operates during heating operation and the compressor stops.	—	○

Notes (1) The number of flashes when in the service mode do not include the 1.5 second period when the lights light up at first (start signal). (See the example shown below.)

- In the case of current cut (example: stop code “42”)
 - The RUN light (10’s digit) flashes 4 times and the TIMER light (1’s digit) flashes 2 times.
 - $4 \times 10 + 2 \times 1 = 42 \rightarrow$ From the table, read the instructions for error code 42, “Current cut”.

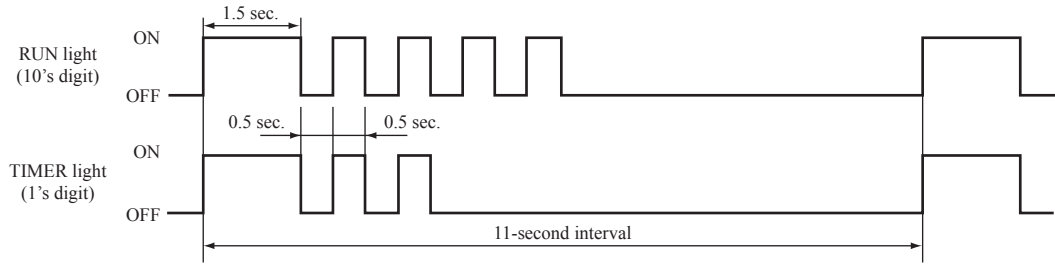

- (2) Abnormal Stop: — Is not displayed. (automatic recovery only)
 ○Displayed.
 If there is a () displayed, the error display shows the number of times that an automatic recovery occurred for the same reason has reached the number of times in ().
 If no () is displayed, the error display shows that the trouble has occurred once.
- (3) Automatic Recovery: — Does not occur.
 ○Automatic recovery occurs.

(d) Wireless remote control information tables

1) Operation switching

Display pattern when in service mode	Operation switching when there is an abnormal stop
RUN light (Operation switching)	
0	AUTO
1	DRY
2	COOL
3	FAN
4	HEAT

2) Fan speed switching

Display pattern when in service mode	Fan speed switching when there is an abnormal stop
TIMER light (Fan speed switching)	
0	AUTO
2	HI
3	MED
4	LO
6	HI POWER
7	ECONO

* If no data are recorded (error code is normal), the information display in the wireless remote control becomes as follows.

Wireless remote control setting	Display when error code is normal
Operation switching	AUTO
Fan speed switching	AUTO

(Example): Operation switching, fan speed switching, cooling HI

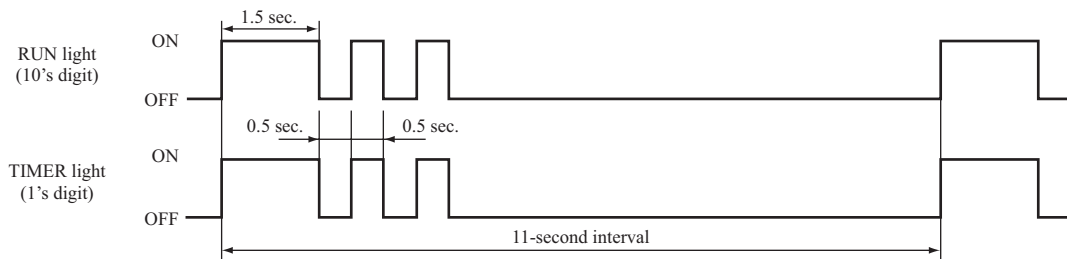

(e) Room temperature sensor, indoor heat exchanger temperature sensor, outdoor air temperature sensor, outdoor heat exchanger temperature sensor table

Unit: °C

Buzzer sound		TIMER light (1's digit)											
		0	1	2	3	4	5	6	7	8	9		
RUN light (10's digit)													
Yes (sounds for 0.1 second)	6	-60	-61	-62	-63	-64							
	5	-50	-51	-52	-53	-54	-55	-56	-57	-58	-59		
	4	-40	-41	-42	-43	-44	-45	-46	-47	-48	-49		
	3	-30	-31	-32	-33	-34	-35	-36	-37	-38	-39		
	2	-20	-21	-22	-23	-24	-25	-26	-27	-28	-29		
	1	-10	-11	-12	-13	-14	-15	-16	-17	-18	-19		
	0	/	-1	-2	-3	-4	-5	-6	-7	-8	-9		
No (does not sound)	0	0	1	2	3	4	5	6	7	8	9		
	1	10	11	12	13	14	15	16	17	18	19		
	2	20	21	22	23	24	25	26	27	28	29		
	3	30	31	32	33	34	35	36	37	38	39		
	4	40	41	42	43	44	45	46	47	48	49		
	5	50	51	52	53	54	55	56	57	58	59		
	6	60	61	62	63	64	65	66	67	68	69		
	7	70	71	72	73	74	75	76	77	78	79		
	8	80	81	82	83	84	85	86	87	88	89		
	9	90	91	92	93	94	95	96	97	98	99		

* If no data are recorded (error code is normal), the display for each sensor becomes as shown below.

Sensor name	Sensor value displayed when the error code is normal
Room temperature sensor	-19°C
Indoor heat exchanger temperature sensor	-64°C
Outdoor air temperature sensor	-64°C
Outdoor heat exchanger temperature sensor	-64°C

(Example) Room temperature, indoor heat exchanger temperature, outdoor air temperature, outdoor heat exchanger temperature: “-9°C”

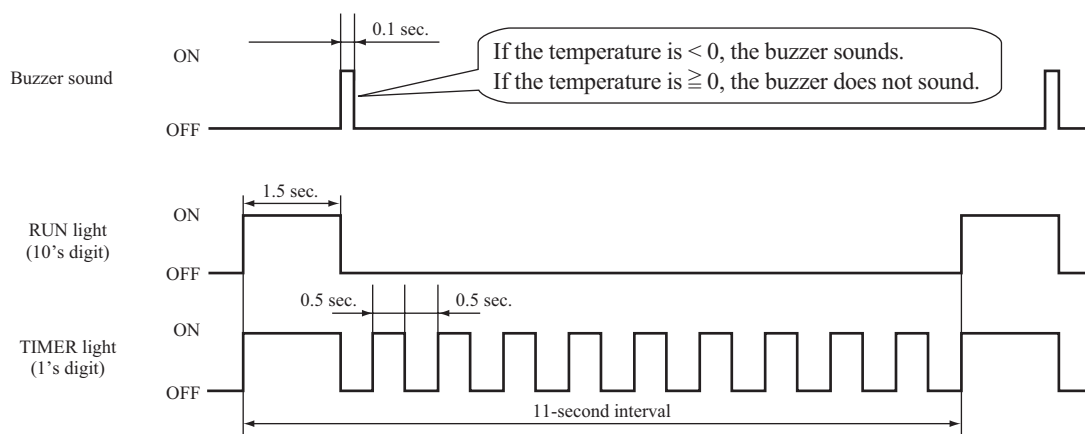

(f) Discharge pipe temperature sensor table

Unit: °C

Buzzer sound		TIMER light (1's digit)		RUN light (10's digit)									
		0	1	2	3	4	5	6	7	8	9		
Yes (sounds for 0.1 second)	3	-60	-62	-64									
	2	-40	-42	-44	-46	-48	-50	-52	-54	-56	-58		
	1	-20	-22	-24	-26	-28	-30	-32	-34	-36	-38		
	0	/	-2	-4	-6	-8	-10	-12	-14	-16	-18		
No (does not sound)	0	0	2	4	6	8	10	12	14	16	18		
	1	20	22	24	26	28	30	32	34	36	38		
	2	40	42	44	46	48	50	52	54	56	58		
	3	60	62	64	66	68	70	72	74	76	78		
	4	80	82	84	86	88	90	92	94	96	98		
	5	100	102	104	106	108	110	112	114	116	118		
	6	120	122	124	126	128	130	132	134	136	138		
	7	140	142	144	146	148	150						

* If no data are recorded (error code is normal), the display for sensor becomes as shown below.

Sensor name	Sensor value displayed when the error code is normal
Discharge pipe temperature sensor	-64°C

(Example) Discharge pipe temperature: "122°C"

* In the case of discharge pipe data, multiply the reading value by 2. (Below, $61 \times 2 = "122°C"$)

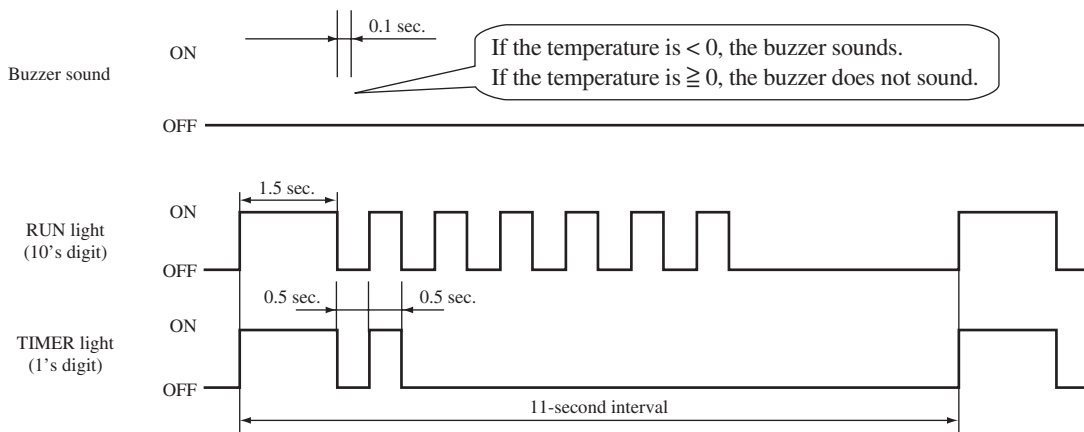

Service data record form

Customer			Model				
Date of investigation							
Machine name							
Content of complaint							
Remote control settings			Content of displayed data	Display results			Display content
Temperature setting	Operation switching	Fan speed switching		Buzzer (Yes/No.)	RUN light (Times)	TIMER light (Times)	
21	Cooling	MED	Error code on previous occasion	/			
		HI	Room temperature sensor temperature on previous occasion				
		AUTO	Indoor heat exchanger temperature sensor temperature on previous occasion				
	Heating	LO	Remote control information on previous occasion	/			
		MED	Outdoor air temperature sensor temperature on previous occasion				
		HI	Outdoor heat exchanger temperature sensor temperature on previous occasion				
22	Cooling	MED	Error code on second previous occasion	/			
		HI	Room temperature sensor temperature on second previous occasion				
		AUTO	Indoor heat exchanger temperature sensor temperature on second previous occasion				
	Heating	LO	Remote control information on second previous occasion	/			
		MED	Outdoor air temperature sensor temperature on second previous occasion				
		HI	Outdoor heat exchanger temperature sensor temperature on second previous occasion				
23	Cooling	MED	Error code on third previous occasion	/			
		HI	Room temperature sensor temperature on third previous occasion				
		AUTO	Indoor heat exchanger temperature sensor temperature on third previous occasion				
	Heating	LO	Remote control information on third previous occasion	/			
		MED	Outdoor air temperature sensor temperature on third previous occasion				
		HI	Outdoor heat exchanger temperature sensor temperature on third previous occasion				
24	Cooling	MED	Error code on fourth previous occasion	/			
		HI	Room temperature sensor temperature on fourth previous occasion				
		AUTO	Indoor heat exchanger temperature sensor temperature on fourth previous occasion				
	Heating	LO	Remote control information on fourth previous occasion	/			
		MED	Outdoor air temperature sensor temperature on fourth previous occasion				
		HI	Outdoor heat exchanger temperature sensor temperature on fourth previous occasion				
25	Cooling	MED	Error code on fifth previous occasion	/			
		HI	Room temperature sensor temperature on fifth previous occasion				
		AUTO	Indoor heat exchanger temperature sensor temperature on fifth previous occasion				
	Heating	LO	Remote control information on fifth previous occasion	/			
		MED	Outdoor air temperature sensor temperature on fifth previous occasion				
		HI	Outdoor heat exchanger temperature sensor temperature on fifth previous occasion				
21	Cooling	LO	Stop code on previous occasion				
22			Stop code on second previous occasion				
23			Stop code on third previous occasion				
24			Stop code on fourth previous occasion				
25			Stop code on fifth previous occasion				
26			Stop code on sixth previous occasion				
27			Stop code on seventh previous occasion				
28			Stop code on eighth previous occasion				
29			Stop code on ninth previous occasion				
30			Stop code on tenth previous occasion				
Judgment						Examiner	
Remarks							

(7) Inspection procedures corresponding to detail of trouble

Sensor error

[Broken sensor wire, connector poor connection]

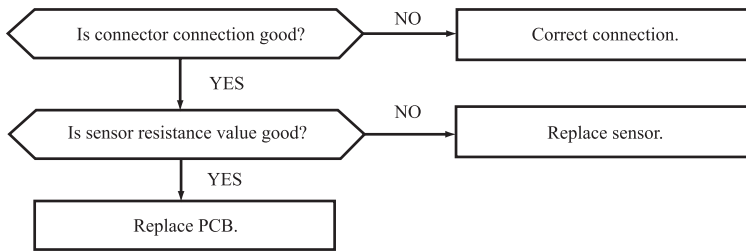

◆ Discharge pipe temperature sensor characteristics

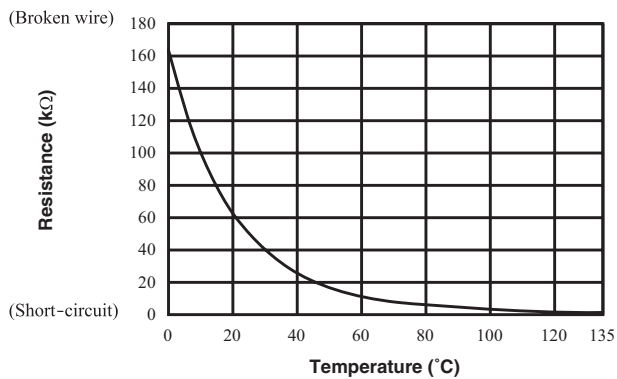

◆ Sensor temperature characteristics (Room temperature, indoor heat exchanger temperature, outdoor heat exchanger temperature, outdoor air temperature)

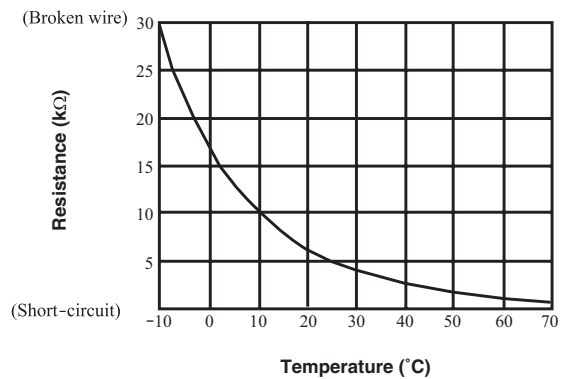

Indoor fan motor error

[Defective fan motor, connector poor connection, defective indoor unit PCB]

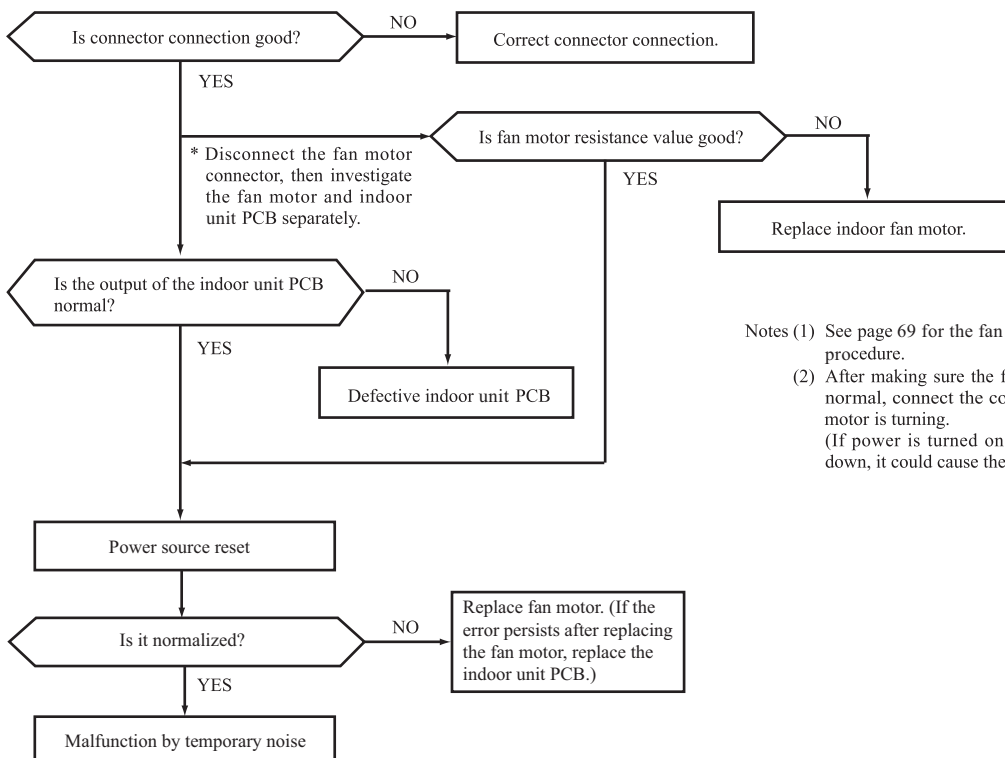

Notes (1) See page 69 for the fan motor and indoor unit PCB check procedure.
 (2) After making sure the fan motor and indoor unit PCB are normal, connect the connectors and confirm that the fan motor is turning.
 (If power is turned on while one or the other is broken down, it could cause the other to break down also.)

Current cut

[Compressor lock, Compressor wiring short-circuit, Compressor output is open phase, Outdoor unit PCB is faulty, Service valve is closed, EEV is faulty, Compressor faulty.]

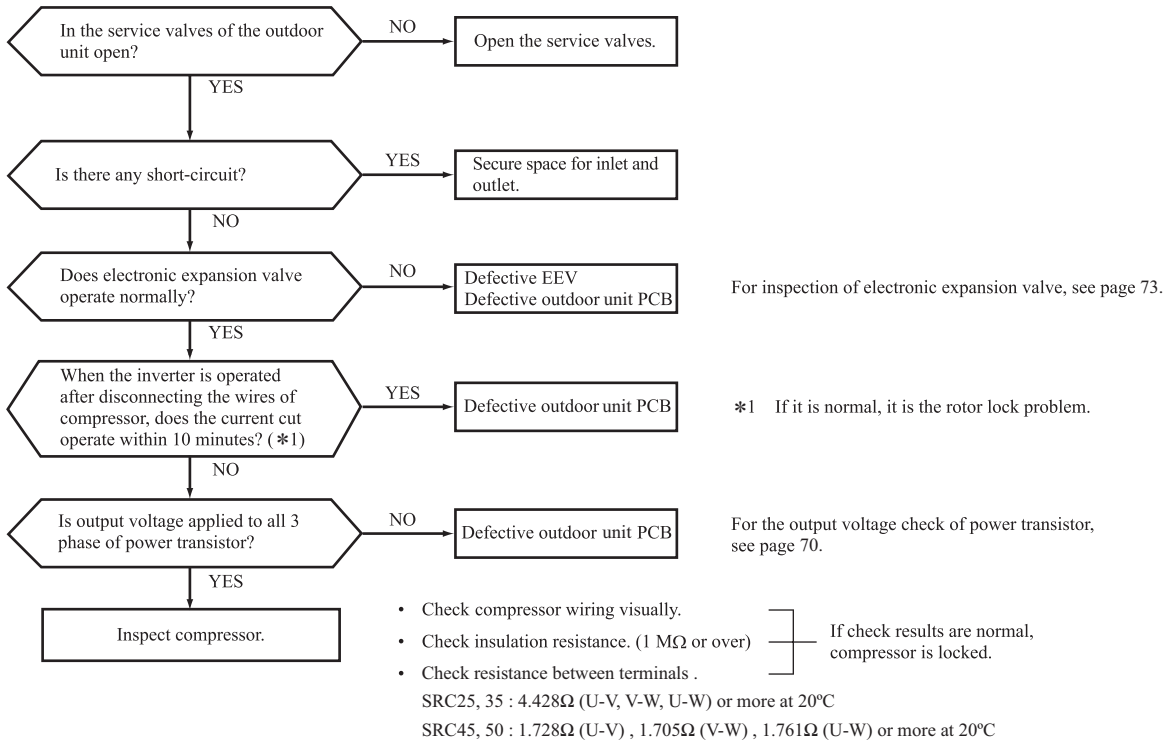

Current safe stop

[Overload operation, compressor lock, overcharge]

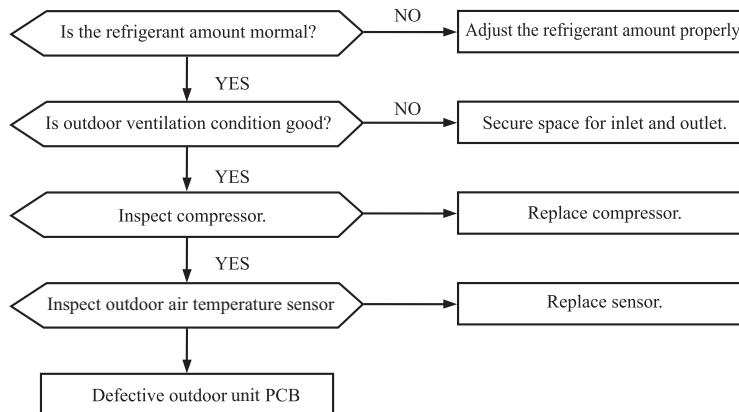

Over heat of compressor

[Gas shortage, defective discharge pipe temperature sensor]

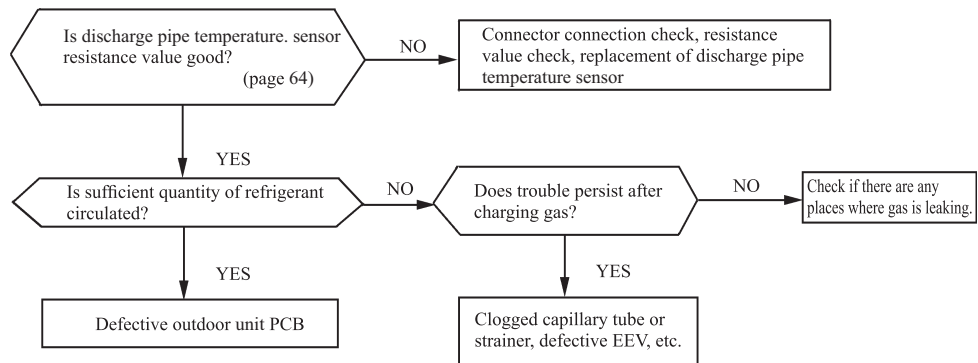

Error of signal transmission

[Wiring error including power cable, defective indoor/outdoor unit PCB]

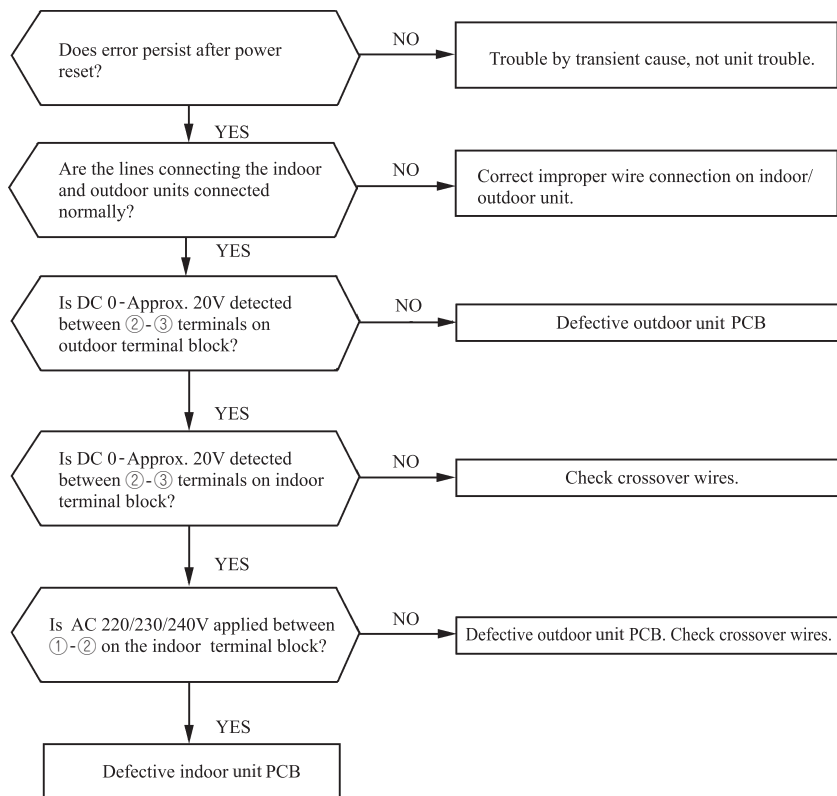

Trouble of outdoor unit

[Insufficient refrigerant amount, Faulty power transistor, Broken compressor wire]
 [Service valve close, Defective EEV, Defective outdoor unit PCB]

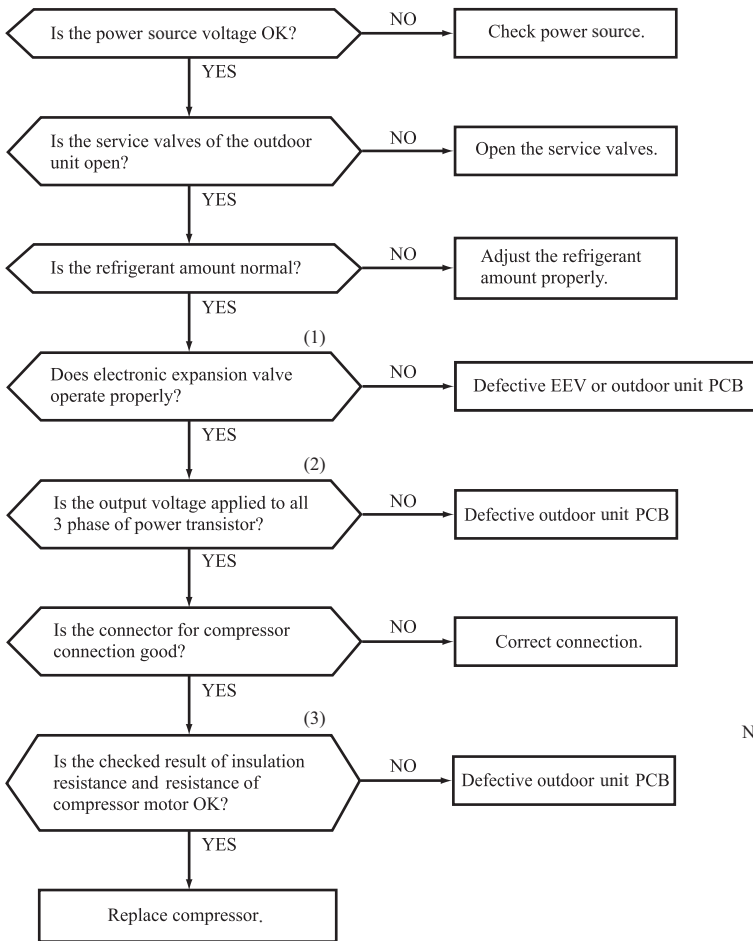

Proper power source voltages are as follows.
 (At the power source outlet)
 AC 220V : AC 198-242V
 AC 230V : AC 207-253V
 AC 240V : AC 216-264V

◆ Judgment of refrigerant quantity

(1) Phenomenon of insufficient refrigerant

- (a) Loss of capacity
- (b) Poor defrost operation
(Frost is not removed completely.)
- (c) Longer time of hot keep
(5 minute or more)
(Normal time: Approx. 1 – 1 minute and 30 seconds)

Notes (1) For inspection of electronic expansion valve, see page 73.

(2) For the output voltage check of power transistor, see page 70.

(3) Check resistance between terminals, see page 65.

Outdoor fan motor error

[Defective fan motor, connector poor connection, defective outdoor unit PCB]

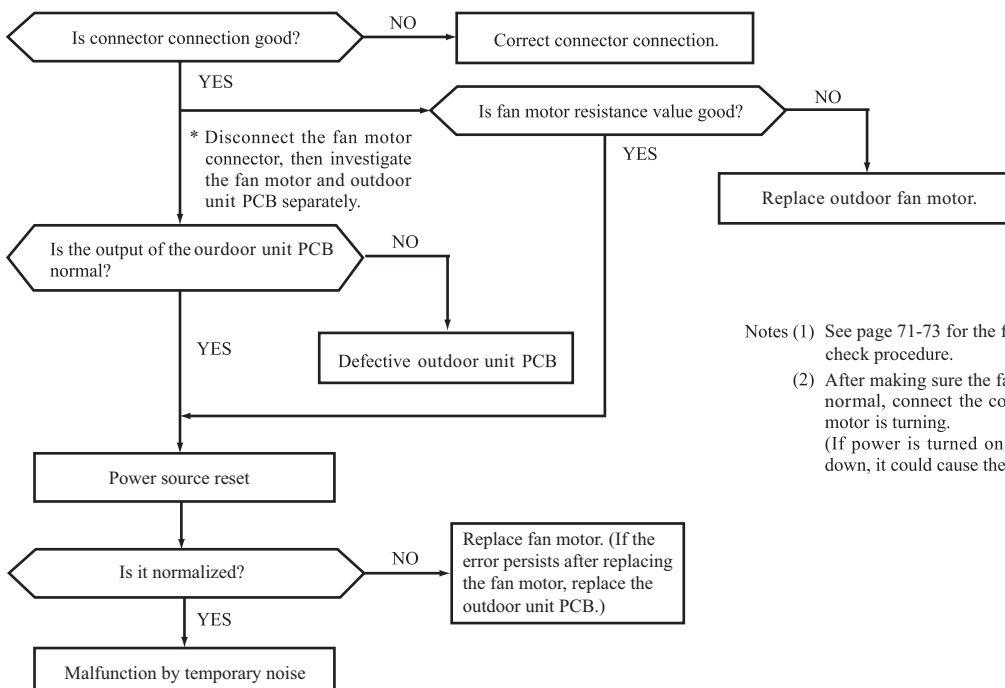

Notes (1) See page 71-73 for the fan motor and outdoor unit PCB check procedure.

(2) After making sure the fan motor and outdoor unit PCB are normal, connect the connectors and confirm that the fan motor is turning.
 (If power is turned on while one or the other is broken down, it could cause the other to break down also.)

Rotor lock

[Defective compressor, defective outdoor unit PCB]

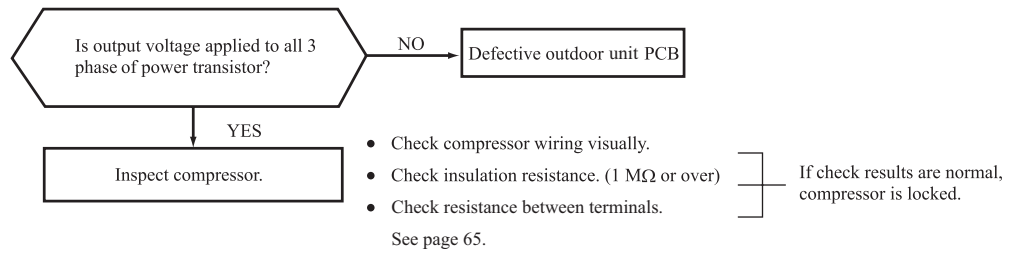

(8) Phenomenon observed after short-circuit, wire breakage on sensor

(a) Indoor unit

Sensor	Operation mode	Phenomenon	
		Short-circuit	Disconnected wire
Room temperature sensor	Cooling	Release of continuous compressor operation command.	Continuous compressor operation command is not released.
	Heating	Continuous compressor operation command is not released.	Release of continuous compressor operation command.
Heat exchanger temperature sensor	Cooling	System can be operated normally.	Continuous compressor operation command is not released. (Anti-frosting)
	Heating	High pressure control mode (Compressor stop command)	Hot keep (Indoor fan stop)
Humidity sensor	Cooling	Refer to the table below.	Refer to the table below.
	Heating	Normal system operation is possible.	

■ Humidity sensor operation

Failure mode	Control input circuit reading	Air conditioning system operation
Disconnected wire	① Disconnected wire	Humidity reading is 0%. Anti-condensation control is not done.
	② Disconnected wire	
	①② Disconnected wire	
Short-Circuit	① and ② are short-circuited.	Humidity reading is 100%. Anti-condensation control keep doing.

Remark: Do not perform a continuity check of the humidity sensor with a tester. If DC current is applied, it could damage the sensor.

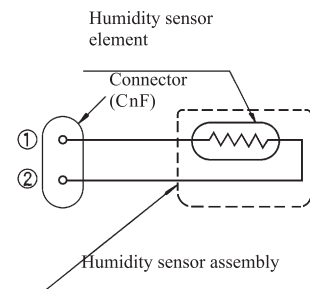

(b) Outdoor unit

Sensor	Operation mode	Phenomenon	
		Shortcircuit	Disconnected wire
Heat exchanger temperature sensor	Cooling	System can be operated normally.	Compressor stop.
	Heating	Defrost operation is not performed.	Defrost operation is performed for 10 minutes at approx. 35 (model LMC12:45) minutes.
Outdoor air temperature sensor	Cooling	System can be operated normally.	Compressor stop.
	Heating	Defrost operation is not operated.	Defrost operation is performed for 10 minutes at approx. 35 (model LMC12:45) minutes.
Discharge pipe temperature sensor	All modes	Compressor overload protection is disabled. (Can be operated.)	Compressor stop.

(9) Checking the indoor electrical equipment

(a) Indoor unit PCB check procedure

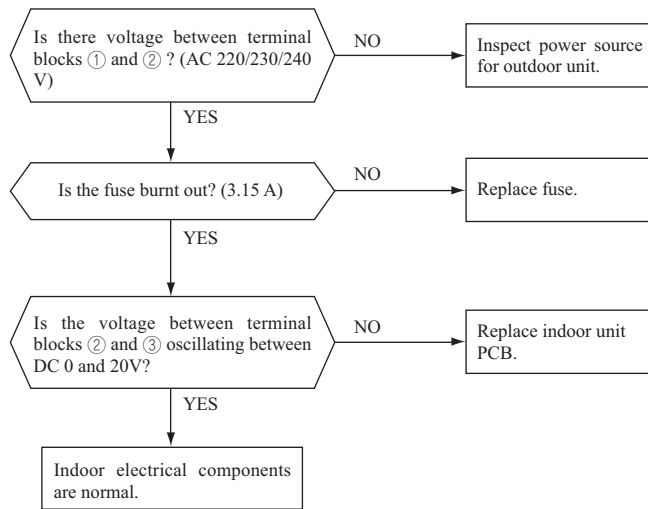

(b) Indoor unit fan motor check procedure

This is a diagnostic procedure for determining if the indoor unit’s fan motor or the indoor unit PCB is broken down.

1) Indoor unit PCB output check

- a) Turn off the power.
- b) Remove the front panel, then disconnect the fan motor lead wire connector.
- c) Turn on the power. If the unit operates when the ON/OFF button is pressed, if trouble is detected after the voltages in the following figure are output for approximately 30 seconds, it means that the indoor unit PCB is normal and the fan motor is broken down.

If the voltages in the following figure are not output at connector pins No. ①, ④ and ⑤, the indoor unit PCB has failed and the fan motor is normal.

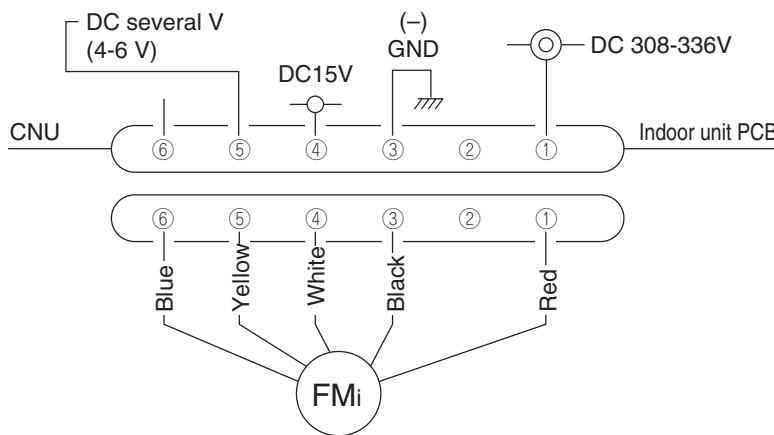

Measuring point	Voltage range when normal
① - ③	DC 308-336V
④ - ③	DC 15V
⑤ - ③	DC several V (4-6V)

2) Fan motor resistance check

Measuring point	Resistance when normal
① - ③ (Red - Black)	20 MΩ or higher
④ - ③ (White - Black)	20 kΩ or higher

- Notes (1) Remove the fan motor and measure it without power connected to it.
 (2) If the measured value is below the value when the motor is normal, it means that the fan motor is faulty.

(c) Power transistor inspection procedure

[Use a tester with a needle indicator for the inspection. (Do not use a digital tester. Check in the AC 300 volt range.)]

(1) If there is a self-diagnosis display, inspect the compressor system (burns, wiring mistakes, etc.) If no problems are found, check the output of the power transistor.

(2) Output inspection procedure

Disconnect the terminals for the compressor.

If an output such as the one shown in the figure on the below can be measured, the power transistor and the circuit board for the outdoor unit are normal.

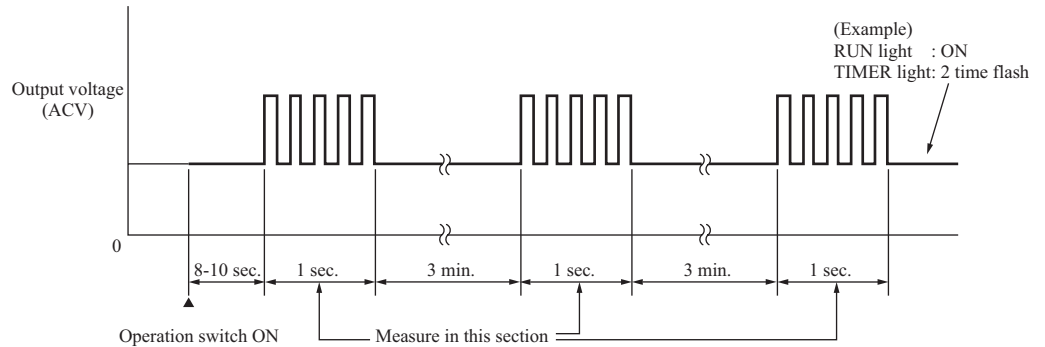

(10) How to make sure of wireless remote control

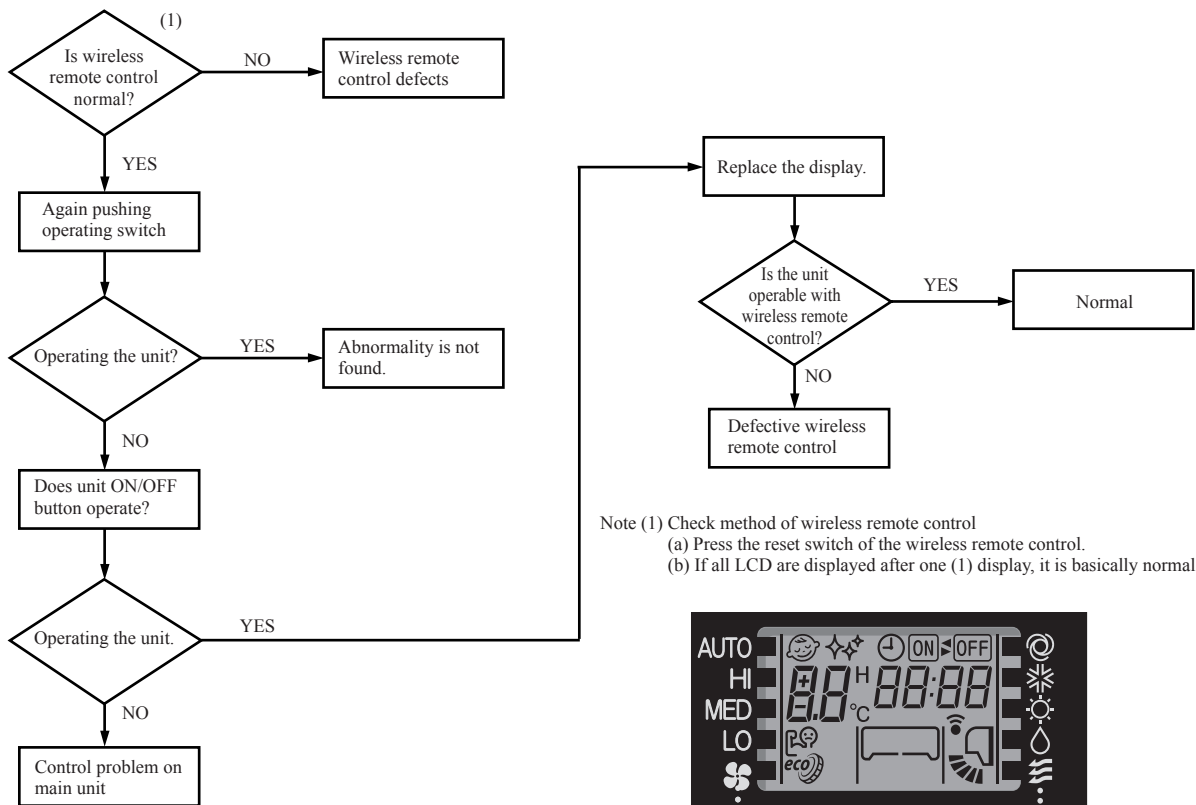

Note (1) Check method of wireless remote control
 (a) Press the reset switch of the wireless remote control.
 (b) If all LCD are displayed after one (1) display, it is basically normal.

(11) Outdoor unit inspection points
Models SRC25ZSP-W, 35ZSP-W

◆ **Check point of outdoor unit**

⚠ CAUTION – HIGH VOLTAGE
 High voltage is produced in the control box. Don't touch electrical parts in the control box for 5 minutes after the unit is stopped.

Power source
 1 Phase
 220-240V 50Hz

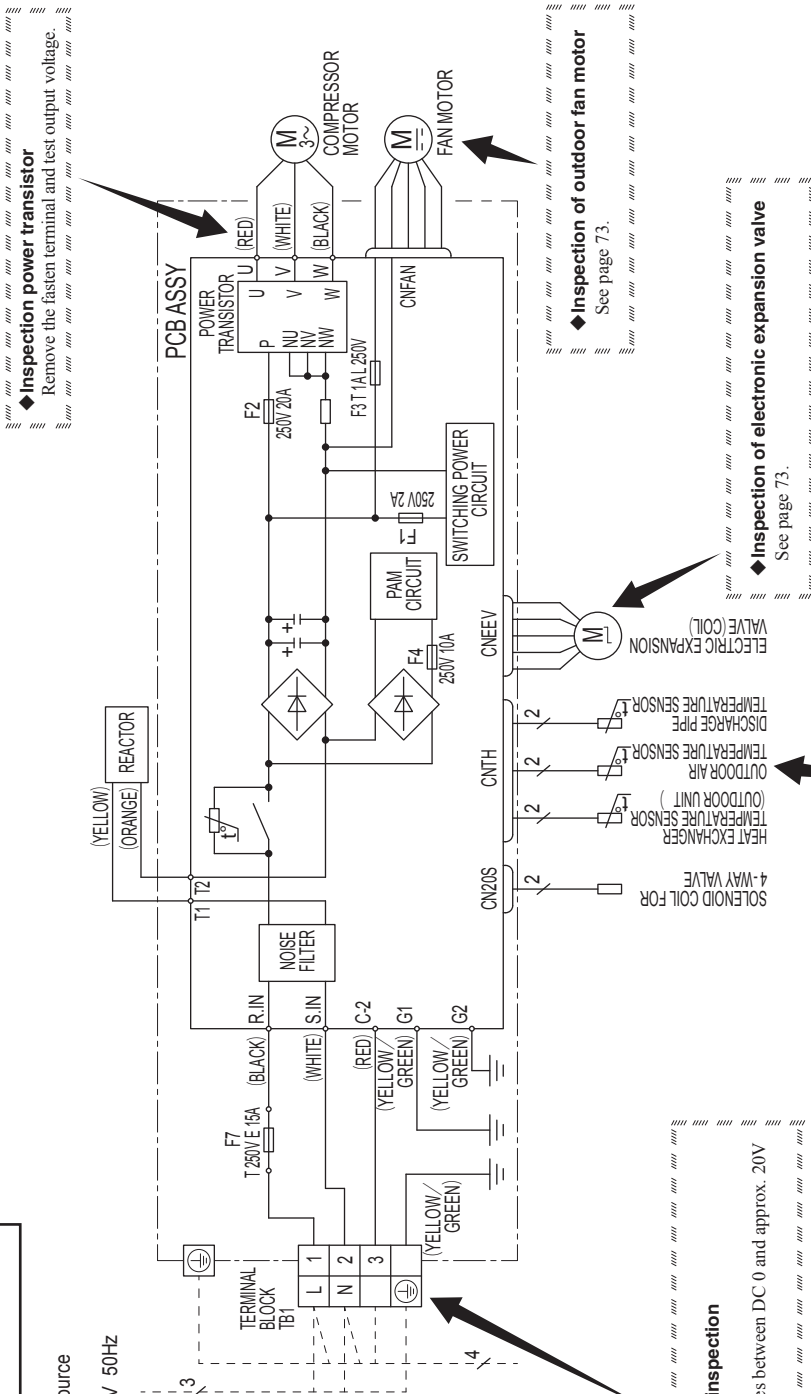

◆ **Inspection power transistor**
 Remove the fasten terminal and test output voltage.

◆ **Inspection of outdoor fan motor**
 See page 73.

◆ **Inspection of electronic expansion valve**
 See page 73.

◆ **Inspection of resistance value of sensor**
 Remove the connector and check the resistance value.
 See the section of sensor characteristics on page 64.

◆ **Power source and serial signal inspection**
 ① to ②: AC 220/230/240V
 ② to ③: Normal if the voltage oscillates between DC 0 and approx. 20V

(a) Inspection of electronic expansion valve

Electronic expansion valve operates for approx. 10 seconds after the power on, in order to determine its aperture. Check the operating sound and voltage during the period of time. (Voltage cannot be checked during operation in which only the aperture change occurs.)

- (i) If it is heard the sound of operating electronic expansion valve, it is almost normal.
- (ii) If the operating sound is not heard, check the output voltage.

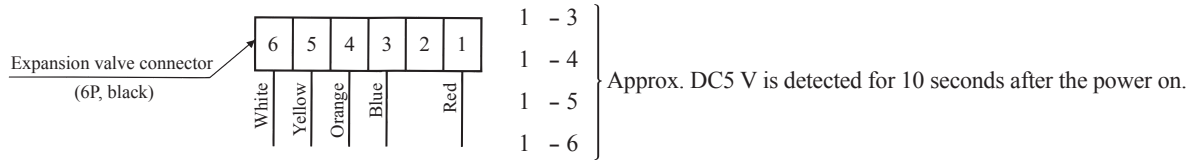

- (iii) If voltage is detected, the outdoor unit PCB is normal.
- (iv) If the expansion valve does not operate (no operating sound) while voltage is detected, the expansion valve is defective.

• Inspection of electronic expansion valve as a separate unit

Measure the resistance between terminals with an analog tester.

Measuring point	Resistance when normal
1-6	46 ± 4Ω (at 20°C)
1-4	
1-3	
1-5	

(b) Outdoor unit fan motor check procedure

- When the outdoor unit fan motor error is detected, diagnose which of the outdoor unit fan motor or outdoor unit PCB is defective.
- Diagnose this only after confirming that the indoor unit is normal.

(i) Outdoor unit PCB output check

- 1) Turn off the power.
- 2) Disconnect the outdoor unit fan motor connector CNFAN.
- 3) When the indoor unit is operated by inserting the power source plug and pressing (ON) the backup switch for more than 5 seconds, if the voltage of pin No. ② in the following figure is output for 30 seconds at 20 seconds after turning “ON” the backup switch, the outdoor unit PCB is normal but the fan motor is defective.

If the voltage is not detected, the outdoor unit PCB is defective but the fan motor is normal.

Note (1) The voltage is output 3 times repeatedly. If it is not detected, the indoor unit displays the error message.

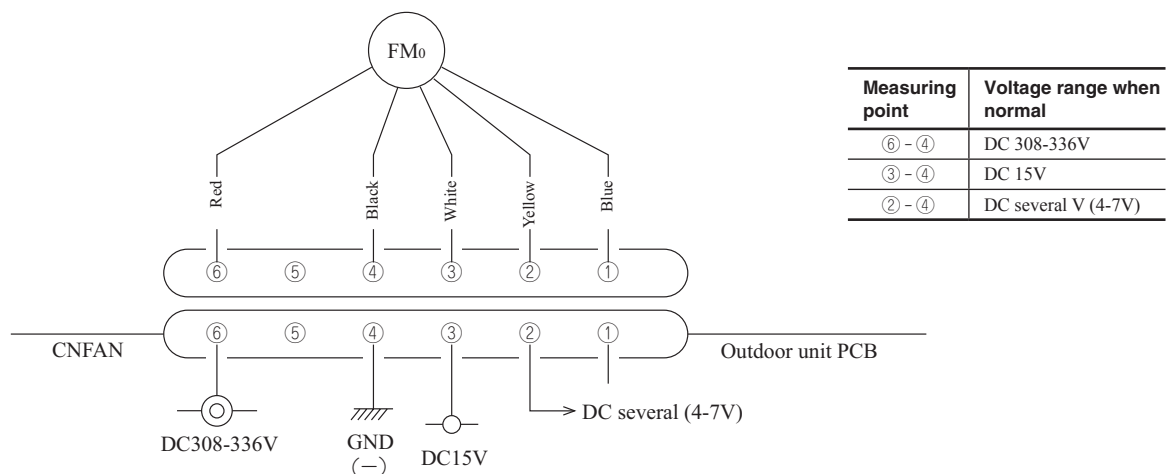

(ii) Fan motor resistance check

Measuring point	Resistance when normal
⑥ - ④ (Red - Black)	20 MΩ or higher
③ - ④ (White - Black)	20 kΩ or higher

- Notes (1) Remove the fan motor and measure it without power connected to it.
- (2) If the measured value is below the value when the motor is normal, it means that the fan motor is faulty.

11. TECHNICAL INFORMATION

Model SRK25ZSP-W

Information to identify the model(s) to which the information relates to:				If function includes heating: Indicate the heating season the information relates to. Indicated values should relate to one heating season at a time. Include at least the heating season 'Average'.					
Indoor unit model name		SRK25ZSP-W		Average(mandatory)		Yes			
Outdoor unit model name		SRC25ZSP-W		Warmer(if designated)		Yes			
Function(indicate if present)				Colder(if designated)				No	
cooling		Yes							
heating		Yes							
Item	symbol	value	unit	Item	symbol	value	class		
Design load				Seasonal efficiency and energy efficiency class					
cooling	Pdesignc	2.50	kW	cooling	SEER	6.80	A++		
heating / Average	Pdesignh	2.80	kW	heating / Average	SCOP/A	4.10	A+		
heating / Warmer	Pdesignh	3.30	kW	heating / Warmer	SCOP/W	5.40	A+++		
heating / Colder	Pdesignh	-	kW	heating / Colder	SCOP/C	-	-		
				unit					
Declared capacity at outdoor temperature Tdesignh				Back up heating capacity at outdoor temperature Tdesignh					
heating / Average (-10°C)	Pdh	2.46	kW	heating / Average (-10°C)	elbu	0.34	kW		
heating / Warmer (2°C)	Pdh	3.30	kW	heating / Warmer (2°C)	elbu	0	kW		
heating / Colder (-22°C)	Pdh	-	kW	heating / Colder (-22°C)	elbu	-	kW		
Declared capacity for cooling, at indoor temperature 27(19)°C and outdoor temperature Tj				Declared energy efficiency ratio, at indoor temperature 27(19)°C and outdoor temperature Tj					
Tj=35°C	Pdc	2.50	kW	Tj=35°C	EERd	3.52	-		
Tj=30°C	Pdc	1.85	kW	Tj=30°C	EERd	5.70	-		
Tj=25°C	Pdc	1.25	kW	Tj=25°C	EERd	9.36	-		
Tj=20°C	Pdc	1.10	kW	Tj=20°C	EERd	12.90	-		
Declared capacity for heating / Average season, at indoor temperature 20°C and outdoor temperature Tj				Declared coefficient of performance / Average season, at indoor temperature 20°C and outdoor temperature Tj					
Tj=-7°C	Pdh	2.50	kW	Tj=-7°C	COPd	2.44	-		
Tj=2°C	Pdh	1.44	kW	Tj=2°C	COPd	3.98	-		
Tj=7°C	Pdh	1.00	kW	Tj=7°C	COPd	5.74	-		
Tj=12°C	Pdh	1.10	kW	Tj=12°C	COPd	7.30	-		
Tj=bivalent temperature	Pdh	2.50	kW	Tj=bivalent temperature	COPd	2.44	-		
Tj=operating limit	Pdh	2.40	kW	Tj=operating limit	COPd	2.06	-		
Declared capacity for heating / Warmer season, at indoor temperature 20°C and outdoor temperature Tj				Declared coefficient of performance / Warmer season, at indoor temperature 20°C and outdoor temperature Tj					
Tj=2°C	Pdh	3.30	kW	Tj=2°C	COPd	2.34	-		
Tj=7°C	Pdh	2.10	kW	Tj=7°C	COPd	4.80	-		
Tj=12°C	Pdh	1.10	kW	Tj=12°C	COPd	7.30	-		
Tj=bivalent temperature	Pdh	3.30	kW	Tj=bivalent temperature	COPd	2.34	-		
Tj=operating limit	Pdh	2.40	kW	Tj=operating limit	COPd	2.06	-		
Declared capacity for heating / Colder season, at indoor temperature 20°C and outdoor temperature Tj				Declared coefficient of performance / Colder season, at indoor temperature 20°C and outdoor temperature Tj					
Tj=-7°C	Pdh	-	kW	Tj=-7°C	COPd	-	-		
Tj=2°C	Pdh	-	kW	Tj=2°C	COPd	-	-		
Tj=7°C	Pdh	-	kW	Tj=7°C	COPd	-	-		
Tj=12°C	Pdh	-	kW	Tj=12°C	COPd	-	-		
Tj=bivalent temperature	Pdh	-	kW	Tj=bivalent temperature	COPd	-	-		
Tj=operating limit	Pdh	-	kW	Tj=operating limit	COPd	-	-		
Tj=-15°C	Pdh	-	kW	Tj=-15°C	COPd	-	-		
Bivalent temperature				Operating limit temperature					
heating / Average	Tbiv	-7	°C	heating / Average	Tol	-15	°C		
heating / Warmer	Tbiv	2	°C	heating / Warmer	Tol	-15	°C		
heating / Colder	Tbiv	-	°C	heating / Colder	Tol	-	°C		
Cycling interval capacity				Cycling interval efficiency					
for cooling	Pcyc	-	kW	for cooling	EERcyc	-	-		
for heating	Pcyc	-	kW	for heating	COPcyc	-	-		
Degradation coefficient cooling				Degradation coefficient heating					
	Cdc	0.25	-		Cdh	0.25	-		
Electric power input in power modes other than 'active mode'				Annual electricity consumption					
off mode	Poff	6	W	cooling	Qce	129	kWh/a		
standby mode	Psb	6	W	heating / Average	Qhe	957	kWh/a		
thermostat-off mode	Pto(cooling)	11	W	heating / Warmer	Qhe	855	kWh/a		
	Pto(heating)	15	W	heating / colder	Qhe	-	kWh/a		
crankcase heater mode	Pck	0	W						
Capacity control(indicate one of three options)				Other items					
fixed		No		Sound power level(indoor)	Lwa	57	dB(A)		
staged		No		Sound power level(outdoor)	Lwa	57	dB(A)		
variable		Yes		Global warming potential	GWP	675	kgCO ₂ eq.		
				Rated air flow(indoor)	-	600	m ³ /h		
				Rated air flow(outdoor)	-	1422	m ³ /h		
Contact details for obtaining more information	Name and address of the manufacturer or of its authorised representative. MHIAE SERVICES B.V. Herikerbergweg 238, Luna ArenA, 1101 CM Amsterdam, Netherlands								

C	RWA000Z275	△
---	------------	---

Model SRK35ZSP-W

Information to identify the model(s) to which the information relates to:				If function includes heating: Indicate the heating season the information relates to. Indicated values should relate to one heating season at a time. Include at least the heating season 'Average'.					
Indoor unit model name		SRK35ZSP-W		Average (mandatory)		Yes			
Outdoor unit model name		SRC35ZSP-W		Warmer (if designated)		Yes			
Function (indicate if present)				Colder (if designated)				No	
cooling		Yes							
heating		Yes							
Item	symbol	value	unit	Item	symbol	value	class		
Design load cooling	Pdesignc	3.20	kW	Seasonal efficiency and energy efficiency class cooling	SEER	7.30	A++		
heating / Average	Pdesignh	3.00	kW	heating / Average	SCOP/A	4.40	A+		
heating / Warmer	Pdesignh	3.60	kW	heating / Warmer	SCOP/W	5.70	A+++		
heating / Colder	Pdesignh	-	kW	heating / Colder	SCOP/C	-	-		
Declared capacity at outdoor temperature Tdesignh				Back up heating capacity at outdoor temperature Tdesignh					
heating / Average (-10°C)	Pdh	2.63	kW	heating / Average (-10°C)	elbu	0.37	kW		
heating / Warmer (2°C)	Pdh	3.60	kW	heating / Warmer (2°C)	elbu	0	kW		
heating / Colder (-22°C)	Pdh	-	kW	heating / Colder (-22°C)	elbu	-	kW		
Declared capacity for cooling, at indoor temperature 27(19)°C and outdoor temperature Tj				Declared energy efficiency ratio, at indoor temperature 27(19)°C and outdoor temperature Tj					
Tj=35°C	Pdc	3.20	kW	Tj=35°C	EERd	3.52	-		
Tj=30°C	Pdc	2.36	kW	Tj=30°C	EERd	5.50	-		
Tj=25°C	Pdc	1.52	kW	Tj=25°C	EERd	9.70	-		
Tj=20°C	Pdc	1.14	kW	Tj=20°C	EERd	16.06	-		
Declared capacity for heating / Average season, at indoor temperature 20°C and outdoor temperature Tj				Declared coefficient of performance / Average season, at indoor temperature 20°C and outdoor temperature Tj					
Tj=-7°C	Pdh	2.66	kW	Tj=-7°C	COPd	2.64	-		
Tj=2°C	Pdh	1.62	kW	Tj=2°C	COPd	4.36	-		
Tj=7°C	Pdh	1.04	kW	Tj=7°C	COPd	5.95	-		
Tj=12°C	Pdh	1.19	kW	Tj=12°C	COPd	7.48	-		
Tj=bivalent temperature	Pdh	2.66	kW	Tj=bivalent temperature	COPd	2.64	-		
Tj=operating limit	Pdh	2.57	kW	Tj=operating limit	COPd	2.21	-		
Declared capacity for heating / Warmer season, at indoor temperature 20°C and outdoor temperature Tj				Declared coefficient of performance / Warmer season, at indoor temperature 20°C and outdoor temperature Tj					
Tj=2°C	Pdh	3.60	kW	Tj=2°C	COPd	2.55	-		
Tj=7°C	Pdh	2.32	kW	Tj=7°C	COPd	5.17	-		
Tj=12°C	Pdh	1.19	kW	Tj=12°C	COPd	7.48	-		
Tj=bivalent temperature	Pdh	3.60	kW	Tj=bivalent temperature	COPd	2.55	-		
Tj=operating limit	Pdh	2.57	kW	Tj=operating limit	COPd	2.21	-		
Declared capacity for heating / Colder season, at indoor temperature 20°C and outdoor temperature Tj				Declared coefficient of performance / Colder season, at indoor temperature 20°C and outdoor temperature Tj					
Tj=-7°C	Pdh	-	kW	Tj=-7°C	COPd	-	-		
Tj=2°C	Pdh	-	kW	Tj=2°C	COPd	-	-		
Tj=7°C	Pdh	-	kW	Tj=7°C	COPd	-	-		
Tj=12°C	Pdh	-	kW	Tj=12°C	COPd	-	-		
Tj=bivalent temperature	Pdh	-	kW	Tj=bivalent temperature	COPd	-	-		
Tj=operating limit	Pdh	-	kW	Tj=operating limit	COPd	-	-		
Tj=-15°C	Pdh	-	kW	Tj=-15°C	COPd	-	-		
Bivalent temperature				Operating limit temperature					
heating / Average	Tbiv	-7	°C	heating / Average	Tol	-15	°C		
heating / Warmer	Tbiv	2	°C	heating / Warmer	Tol	-15	°C		
heating / Colder	Tbiv	-	°C	heating / Colder	Tol	-	°C		
Cycling interval capacity				Cycling interval efficiency					
for cooling	Pcycc	-	kW	for cooling	EERcyc	-	-		
for heating	Pcyh	-	kW	for heating	COPcyc	-	-		
Degradation coefficient cooling				Degradation coefficient heating					
cooling	Cdc	0.25	-	heating	Cdh	0.25	-		
Electric power input in power modes other than 'active mode'				Annual electricity consumption					
off mode	Poff	6	W	cooling	Qce	154	kWh/a		
standby mode	Psb	6	W	heating / Average	Qhe	955	kWh/a		
thermostat-off mode	Pto(cooling)	11	W	heating / Warmer	Qhe	884	kWh/a		
crankcase heater mode	Pto(heating)	15	W	heating / colder	Qhe	-	kWh/a		
crankcase heater mode	Pck	0	W						
Capacity control (indicate one of three options)				Other items					
fixed		No		Sound power level(indoor)	Lwa	58	dB(A)		
staged		No		Sound power level(outdoor)	Lwa	59	dB(A)		
variable		Yes		Global warming potential	GWP	675	kgCO ₂ eq.		
				Rated air flow(indoor)	-	570	m ³ /h		
				Rated air flow(outdoor)	-	1368	m ³ /h		
Contact details for obtaining more information	Name and address of the manufacturer or of its authorised representative. MHIAE SERVICES B.V. Herikerbergweg 238, Luna ArenaA, 1101 CM Amsterdam, Netherlands								

Model SRK45ZSP-W

Information to identify the model(s) to which the information relates to:		If function includes heating: Indicate the heating season the information relates to. Indicated values should relate to one heating season at a time. Include at least the heating season 'Average'.			
Indoor unit model name	SRK45ZSP-W				
Outdoor unit model name	SRC45ZSP-W				
Function(indicate if present)		Average(mandatory)		Yes	
cooling	Yes	Warmer(if designated)		Yes	
heating	Yes	Colder(if designated)		No	
Item	symbol	value	unit	Item	symbol value class
Design load				Seasonal efficiency and energy efficiency class	
cooling	Pdesignc	4.50	kW	cooling	SEER 6.30 A++
heating / Average	Pdesignh	3.80	kW	heating / Average	SCOP/A 4.20 A+
heating / Warmer	Pdesignh	4.30	kW	heating / Warmer	SCOP/W 5.50 A+++
heating / Colder	Pdesignh	-	kW	heating / Colder	SCOP/C - -
Declared capacity at outdoor temperature Tdesignh		Back up heating capacity at outdoor temperature Tdesignh			
heating / Average (-10°C)	Pdh	3.26	kW	heating / Average (-10°C)	elbu 0.54 kW
heating / Warmer (2°C)	Pdh	4.30	kW	heating / Warmer (2°C)	elbu 0 kW
heating / Colder (-22°C)	Pdh	-	kW	heating / Colder (-22°C)	elbu - kW
Declared capacity for cooling, at indoor temperature 27(19)°C and outdoor temperature Tj		Declared energy efficiency ratio, at indoor temperature 27(19)°C and outdoor temperature Tj			
Tj=35°C	Pdc	4.50	kW	Tj=35°C	EERd 3.33 -
Tj=30°C	Pdc	3.32	kW	Tj=30°C	EERd 5.05 -
Tj=25°C	Pdc	2.13	kW	Tj=25°C	EERd 7.75 -
Tj=20°C	Pdc	1.80	kW	Tj=20°C	EERd 12.09 -
Declared capacity for heating / Average season, at indoor temperature 20°C and outdoor temperature Tj		Declared coefficient of performance / Average season, at indoor temperature 20°C and outdoor temperature Tj			
Tj=-7°C	Pdh	3.36	kW	Tj=-7°C	COPd 2.61 -
Tj=2°C	Pdh	2.05	kW	Tj=2°C	COPd 4.10 -
Tj=7°C	Pdh	1.44	kW	Tj=7°C	COPd 5.70 -
Tj=12°C	Pdh	1.62	kW	Tj=12°C	COPd 7.10 -
Tj=bivalent temperature	Pdh	3.36	kW	Tj=bivalent temperature	COPd 2.61 -
Tj=operating limit	Pdh	3.09	kW	Tj=operating limit	COPd 2.34 -
Declared capacity for heating / Warmer season, at indoor temperature 20°C and outdoor temperature Tj		Declared coefficient of performance / Warmer season, at indoor temperature 20°C and outdoor temperature Tj			
Tj=2°C	Pdh	4.30	kW	Tj=2°C	COPd 2.76 -
Tj=7°C	Pdh	2.76	kW	Tj=7°C	COPd 5.12 -
Tj=12°C	Pdh	1.62	kW	Tj=12°C	COPd 7.10 -
Tj=bivalent temperature	Pdh	4.30	kW	Tj=bivalent temperature	COPd 2.76 -
Tj=operating limit	Pdh	3.09	kW	Tj=operating limit	COPd 2.34 -
Declared capacity for heating / Colder season, at indoor temperature 20°C and outdoor temperature Tj		Declared coefficient of performance / Colder season, at indoor temperature 20°C and outdoor temperature Tj			
Tj=-7°C	Pdh	-	kW	Tj=-7°C	COPd - -
Tj=2°C	Pdh	-	kW	Tj=2°C	COPd - -
Tj=7°C	Pdh	-	kW	Tj=7°C	COPd - -
Tj=12°C	Pdh	-	kW	Tj=12°C	COPd - -
Tj=bivalent temperature	Pdh	-	kW	Tj=bivalent temperature	COPd - -
Tj=operating limit	Pdh	-	kW	Tj=operating limit	COPd - -
Tj=-15°C	Pdh	-	kW	Tj=-15°C	COPd - -
Bivalent temperature		Operating limit temperature			
heating / Average	Tbiv	-7	°C	heating / Average	Tol -15 °C
heating / Warmer	Tbiv	2	°C	heating / Warmer	Tol -15 °C
heating / Colder	Tbiv	-	°C	heating / Colder	Tol - °C
Cycling interval capacity		Cycling interval efficiency			
for cooling	Pcycc	-	kW	for cooling	EERcyc - -
for heating	Pcyh	-	kW	for heating	COPcyc - -
Degradation coefficient cooling		Degradation coefficient heating			
cooling	Cdc	0.25	-	heating	Cdh 0.25 -
Electric power input in power modes other than 'active mode'		Annual electricity consumption			
off mode	Poff	7	W	cooling	Qce 251 kWh/a
standby mode	Psb	7	W	heating / Average	Qhe 1269 kWh/a
thermostat-off mode	Pto(cooling)	18	W	heating / Warmer	Qhe 1095 kWh/a
	Pto(heating)	20	W	heating / colder	Qhe - kWh/a
crankcase heater mode	Pck	0	W		
Capacity control(indicate one of three options)		Other items			
fixed		No		Sound power level(indoor)	Lwa 56 dB(A)
staged		No		Sound power level(outdoor)	Lwa 63 dB(A)
variable		Yes		Global warming potential	GWP 675 kgCO ₂ eq.
				Rated air flow(indoor)	- 540 m ³ /h
				Rated air flow(outdoor)	- 2136 m ³ /h
Contact details for obtaining more information	Name and address of the manufacturer or of its authorised representative. MHIAE SERVICES B.V. Herikerbergweg 238, Luna ArenaA, 1101 CM Amsterdam, Netherlands				

C RWA000Z275 

Model SRK50ZSP-W

Information to identify the model(s) to which the information relates to:				If function includes heating: Indicate the heating season the information relates to. Indicated values should relate to one heating season at a time. Include at least the heating season 'Average'.			
Indoor unit model name		SRK50ZSP-W		Average (mandatory)		Yes	
Outdoor unit model name		SRC50ZSP-W		Warmer (if designated)		Yes	
Function (indicate if present)				Colder (if designated)			
cooling		Yes					
heating		Yes					
Item		symbol value unit		Item		symbol value class	
Design load				Seasonal efficiency and energy efficiency class			
cooling		Pdesignc 5.00 kW		cooling		SEER 6.20 A++	
heating / Average		Pdesignh 3.80 kW		heating / Average		SCOP/A 4.20 A+	
heating / Warmer		Pdesignh 4.30 kW		heating / Warmer		SCOP/W 5.50 A+++	
heating / Colder		Pdesignh - kW		heating / Colder		SCOP/C - -	
Declared capacity at outdoor temperature Tdesignh				Back up heating capacity at outdoor temperature Tdesignh			
heating / Average (-10°C)		Pdh 3.26 kW		heating / Average (-10°C)		elbu 0.54 kW	
heating / Warmer (2°C)		Pdh 4.30 kW		heating / Warmer (2°C)		elbu 0 kW	
heating / Colder (-22°C)		Pdh - kW		heating / Colder (-22°C)		elbu - kW	
Declared capacity for cooling, at indoor temperature 27(19)°C and outdoor temperature Tj				Declared energy efficiency ratio, at indoor temperature 27(19)°C and outdoor temperature Tj			
Tj=35°C		Pdc 5.00 kW		Tj=35°C		EERd 2.87 -	
Tj=30°C		Pdc 3.69 kW		Tj=30°C		EERd 4.86 -	
Tj=25°C		Pdc 2.37 kW		Tj=25°C		EERd 7.65 -	
Tj=20°C		Pdc 1.80 kW		Tj=20°C		EERd 12.59 -	
Declared capacity for heating / Average season, at indoor temperature 20°C and outdoor temperature Tj				Declared coefficient of performance / Average season, at indoor temperature 20°C and outdoor temperature Tj			
Tj=-7°C		Pdh 3.36 kW		Tj=-7°C		COPd 2.61 -	
Tj=2°C		Pdh 2.05 kW		Tj=2°C		COPd 4.10 -	
Tj=7°C		Pdh 1.44 kW		Tj=7°C		COPd 5.70 -	
Tj=12°C		Pdh 1.62 kW		Tj=12°C		COPd 7.10 -	
Tj=bivalent temperature		Pdh 3.36 kW		Tj=bivalent temperature		COPd 2.61 -	
Tj=operating limit		Pdh 3.09 kW		Tj=operating limit		COPd 2.34 -	
Declared capacity for heating / Warmer season, at indoor temperature 20°C and outdoor temperature Tj				Declared coefficient of performance / Warmer season, at indoor temperature 20°C and outdoor temperature Tj			
Tj=2°C		Pdh 4.30 kW		Tj=2°C		COPd 2.76 -	
Tj=7°C		Pdh 2.76 kW		Tj=7°C		COPd 5.12 -	
Tj=12°C		Pdh 1.62 kW		Tj=12°C		COPd 7.10 -	
Tj=bivalent temperature		Pdh 4.30 kW		Tj=bivalent temperature		COPd 2.76 -	
Tj=operating limit		Pdh 3.09 kW		Tj=operating limit		COPd 2.34 -	
Declared capacity for heating / Colder season, at indoor temperature 20°C and outdoor temperature Tj				Declared coefficient of performance / Colder season, at indoor temperature 20°C and outdoor temperature Tj			
Tj=-7°C		Pdh - kW		Tj=-7°C		COPd - -	
Tj=2°C		Pdh - kW		Tj=2°C		COPd - -	
Tj=7°C		Pdh - kW		Tj=7°C		COPd - -	
Tj=12°C		Pdh - kW		Tj=12°C		COPd - -	
Tj=bivalent temperature		Pdh - kW		Tj=bivalent temperature		COPd - -	
Tj=operating limit		Pdh - kW		Tj=operating limit		COPd - -	
Tj=-15°C		Pdh - kW		Tj=-15°C		COPd - -	
Bivalent temperature				Operating limit temperature			
heating / Average		Tbiv -7 °C		heating / Average		Tol -15 °C	
heating / Warmer		Tbiv 2 °C		heating / Warmer		Tol -15 °C	
heating / Colder		Tbiv - °C		heating / Colder		Tol - °C	
Cycling interval capacity				Cycling interval efficiency			
for cooling		Pcycc - kW		for cooling		EERcyc - -	
for heating		Pcyh - kW		for heating		COPcyc - -	
Degradation coefficient cooling				Degradation coefficient heating			
cooling		Cdc 0.25 -		heating		Cdh 0.25 -	
Electric power input in power modes other than 'active mode'				Annual electricity consumption			
off mode		Poff 7 W		cooling		Qce 283 kWh/a	
standby mode		Psb 7 W		heating / Average		Qhe 1269 kWh/a	
thermostat-off mode		Pto(cooling) 18 W		heating / Warmer		Qhe 1095 kWh/a	
crankcase heater mode		Pto(heating) 20 W		heating / colder		Qhe - kWh/a	
Pck 0 W							
Capacity control (indicate one of three options)				Other items			
fixed		No		Sound power level (indoor)		Lwa 59 dB(A)	
staged		No		Sound power level (outdoor)		Lwa 65 dB(A)	
variable		Yes		Global warming potential		GWP 675 kgCO ₂ eq.	
				Rated air flow (indoor)		- 594 m ³ /h	
				Rated air flow (outdoor)		- 2262 m ³ /h	
Contact details for obtaining more information		Name and address of the manufacturer or of its authorised representative. MHIAE SERVICES B.V. Herikerbergweg 238, Luna ArenaA, 1101 CM Amsterdam, Netherlands					

C RWA000Z275 

INVERTER WALL MOUNTED TYPE RESIDENTIAL AIR-CONDITIONERS



MITSUBISHI HEAVY INDUSTRIES THERMAL SYSTEMS, LTD.

2-3, Marunouchi 3-chome, Chiyoda-ku, Tokyo, 100-8332, Japan
<http://www.mhi-mth.co.jp/en/>

Because of our policy of continuous improvement, we reserve the right to make changes in all specifications without notice.

© Copyright MITSUBISHI HEAVY INDUSTRIES THERMAL SYSTEMS, LTD.