



TECHNICAL MANUAL

STANDARD INVERTER PACKAGED AIR-CONDITIONERS (Split system, air to air heat pump type)

CEILING CASSETTE-4 WAY TYPE
FDT100VNP1VF2

CEILING SUSPENDED TYPE
FDE100VNP1VG

**DUCT CONNECTED-HIGH STATIC
PRESSURE TYPE**
FDU100VNP1VF2

**DUCT CONNECTED-LOW/MIDDLE
STATIC PRESSURE TYPE**
FDUM100VNP1VF2

FLOOR STANDING TYPE
FDF100VNP1VD2

WALL MOUNTED TYPE
SRK100VNP1ZR

CONTENTS

1. SPECIFICATIONS	6
(1) Ceiling cassette-4way type (FDT)	6
(2) Ceiling suspended type (FDE)	7
(3) Duct connected-High static pressure type (FDU)	8
(4) Duct connected-Low / Middle static pressure type (FDUM)	9
(5) Floor standing type (FDF)	10
(6) Wall mounted type (SRK)	11
2. EXTERIOR DIMENSIONS	12
(1) Indoor units	12
(2) Outdoor unit	18
(3) Remote control	19
3. ELECTRICAL WIRING	22
(1) Indoor units	22
(2) Outdoor unit	28
4. NOISE LEVEL	29
(1) Indoor units	29
(2) Outdoor unit	31
5. CHARACTERISTICS OF FAN	32
(1) Duct connected-High static pressure type (FDU)	32
(2) Duct connected-Low / Middle static pressure type (FDUM)	33
6. TEMPERATURE AND VELOCITY DISTRIBUTION	34
(1) Ceiling cassette-4way type (FDT)	34
(2) Ceiling suspended type (FDE)	35
(3) Floor standing type (FDF)	36
7. PIPING SYSTEM	37
8. RANGE OF USAGE & LIMITATIONS	38
9. SELECTION CHART	41
9.1 Capacity tables	41
9.2 Correction of cooling and heating capacity in relation to air flow rate control (Fan speed)	45
9.3 Correction of cooling and heating capacity in relation to one way length of refrigerant piping	45
9.4 Height difference between the indoor unit and outdoor unit	45
10. APPLICATION DATA	46
10.1 Installation of indoor unit	46
(1) Ceiling cassette-4way type (FDT)	46
(2) Ceiling suspended type (FDE)	53
(3) Duct connected-High static pressure type (FDU)	57
(4) Duct connected-Low / Middle static pressure type (FDUM)	62
(5) Floor standing type (FDF)	67

(6) Wall mounted type (SRK)	71
(7) Effective range of cool/hot wind (Reference)	75
10.2 Electric wiring work installation	76
(1) FDT, FDE, FDU, FDUM series	76
(2) FDF series	80
10.3 Installation of wired remote control (Option)	84
10.4 Installation of outdoor unit	98
11. OUTLINE OF OPERATION CONTROL BY MICROCOMPUTER	105
11.1 Remote control	105
11.2 Operation control function by the wired remote control	108
11.3 Operation control function by the indoor control	111
11.3.1 FDT, FDE, FDU, FDUM, FDF series	111
(1) Auto operation	111
(2) Operations of functional items during cooling/heating	112
(3) Dehumidifying operation	112
(4) Timer operation	113
(5) Remote control display during the operation stop	114
(6) Hot start (Cold draft prevention at heating)	114
(7) Hot keep	114
(8) Auto swing control	115
(9) Thermostat operation	116
(10) Filter sign	117
(11) Compressor inching prevention control	117
(12) Drain pump control	118
(13) Drain pump abnormalities detection	118
(14) Operation check/drain pump test run operation mode	118
(15) Cooling, dehumidifying frost protection	119
(16) Heating overload protection	119
(17) Anomalous fan motor	120
(18) Plural unit control - Control of 16 units group by one remote control	120
(19) High ceiling control	120
(20) Abnormal temperature thermistor (return air/indoor heat exchanger) wire/short-circuit detection	121
(21) External input/output control (CnT or CnTA)	121
(22) Operation permission/prohibition	123
(23) Selection of cooling/heating external input function	124
(24) Fan control at heating startup	125
(25) Room temperature detection temperature compensation during heating	125
(26) Return air temperature compensation	125
(27) High power operation (RC-EX1A only)	125

(28)	Energy-saving operation (RC-EX1A only)	126
(29)	Warm-up control (RC-EX1A only)	126
(30)	Home leave mode (RC-EX1A only)	126
(31)	Auto temperature setting (RC-EX1A only)	126
(32)	Fan circulator operation (RC-EX1A only)	126
(33)	The operation judgment is executed every 5 minutes (RC-EX1A only)	126
(34)	Auto fan speed control (RC-EX1A only)	126
(35)	Indoor unit overload alarm (RC-EX1A only)	126
(36)	Peak-cut time (RC-EX1A only)	127
11.3.2	SRK series	128
(1)	Operation control function by wireless remote control	128
(2)	Unit ON/OFF button	129
(3)	Auto restart function	129
(4)	Installing two air-conditioners in the same room	129
(5)	Selection of the annual cooling function	130
(6)	High power operation	130
(7)	Economy operation	130
(8)	Flap and louver control	131
(9)	3D auto operation	132
(10)	Timer operation	133
(11)	Silent mode	133
(12)	Night setback	133
(13)	Installation location setting	134
(14)	Outline of heating operation	134
(15)	Outline of cooling operation	135
(16)	Outline of dry(dehumidifying) operation	135
(17)	Outline of automatic operation	136
(18)	Protection control function	136
11.4	Operation control function by the outdoor control	138
(1)	Compressor command speed	138
(2)	Compressor protection start	138
(3)	Outdoor unit fan control	138
(4)	Defrost operation	140
(5)	Cooling overload protective control	141
(6)	Cooling high pressure control	141
(7)	Cooling low outdoor temperature protective control	141
(8)	Heating high pressure control	142
(9)	Heating overload protective control I	142
(10)	Heating overload protective control II	142
(11)	Heating low outdoor temperature protective control	143

(12) Compressor overheat protection	143
(13) Current safe	143
(14) Current cut	144
(15) Outdoor unit failure	144
(16) Serial signal transmission error protection	144
(17) Rotor lock	144
(18) Refrigeration cycle system protection	144
(19) Silent mode	144
(20) Broken wire detection on temperature sensor	145
(21) Base heater ON/OFF output control (Option)	145
(22) Reverse operation start for compressor protection	145
12. MAINTENANCE DATA	146
12.1 FDT, FDE, FDU, FDUM, FDF series	146
12.1.1 Diagnosing of microcomputer circuit	146
(1) Selfdiagnosis function	146
(2) Troubleshooting procedure	149
(3) Troubleshooting at the indoor unit	149
(4) Check of anomalous operation data with the remote control	156
(5) Outdoor unit control failure diagnosis circuit diagram	158
12.1.2 Troubleshooting flow	159
(1) List of troubles	159
(2) Troubleshooting	160
12.2 SRK series	201
(1) Cautions	201
(2) Items to check before troubleshooting	201
(3) Troubleshooting procedure (If the air-conditioner does not run at all)	201
(4) Troubleshooting procedure (If the air-conditioner runs)	202
(5) Self-diagnosis table	203
(6) Service mode (Trouble mode access function)	204
(7) Inspection procedures corresponding to detail of trouble	212
(8) Phenomenon observed after shortcircuit, wire breakage on sensor	214
(9) Checking the indoor electrical equipment	214
(10) How to make sure of wireless remote control	216
(11) Inspection procedure for blown fuse on the indoor control PCB	216
13. OPTION PARTS	217
13.1 Wireless kit	217
(1) FDT series (RCN-T-36W-E)	217
(2) FDE series (RCN-E-E)	219
(3) FDU, FDUM, FDF series (RCN-KIT3-E)	223
13.2 Simple wired remote control (RCH-E3)	225
13.3 Filter kit (FDUM series)	231

13.4 Interface kit (SC-BIKN-E)233
13.5 Superlink E board (SC-ADNA-E)237
13.6 Base heater kit (CW-H-E1)239
14. TECHNICAL INFORMATION247
 (1) Ceiling cassette-4way type (FDT)247
 (2) Ceiling suspended type (FDE)248
 (3) Duct connected-High static pressure type (FDU)249
 (4) Duct connected-Low / Middle static pressure type (FDUM)250
 (5) Floor standing type (FDF)251
 (6) Wall mounted type (SRK)252

■ How to read the model name

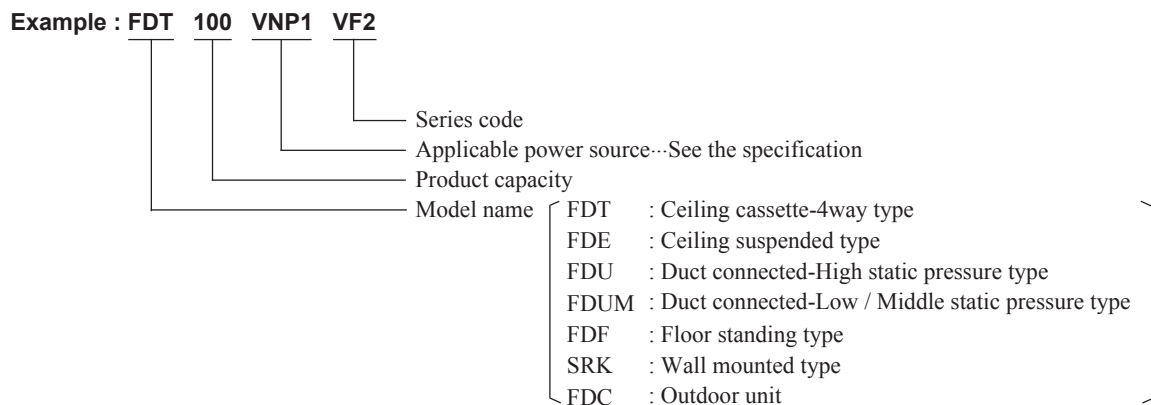

1. SPECIFICATIONS

(1) Ceiling cassette-4way type (FDT)

Item		Model	FDT100VNP1VF2																							
			Indoor unit FDT100VF2	Outdoor unit FDC100VNP																						
Power source			1 Phase 220-240V 50Hz / 220V 60Hz																							
Operation data	Nominal cooling capacity (range)	kW	10.0 [2.8(Min.)— 11.2(Max.)]																							
	Nominal heating capacity (range)	kW	11.2 [2.5(Min.)— 12.5(Max.)]																							
	Power consumption	Cooling	kW	2.76																						
		Heating		2.84																						
	Max power consumption		4.60																							
	Running current	Cooling	A	12.1 / 12.7																						
		Heating		12.5 / 13.0																						
	Inrush current, max current		5, 21																							
	Power factor	Cooling	%	99																						
		Heating		99																						
	EER	Cooling		3.62																						
	COP	Heating		4.52																						
	Sound power level	Cooling	dB(A)	65																						
Heating		70																								
Sound pressure level	Cooling	dB(A)	P-Hi : 51 Hi : 40 Me : 37 Lo : 35																							
	Heating		57																							
Silent mode sound pressure level			61																							
Exterior dimensions (Height × Width × Depth)		mm	Unit 298 × 840 × 840 Panel 35 × 950 × 950																							
Exterior appearance (Munsell color)			Plaster white (6.8Y8.9/0.2)near equivalent Stucco white (4.2Y7.5/1.1)near equivalent																							
Net weight		kg	UNIT 27 PANEL 5.5																							
Compressor type & Q'ty			— RMT5126MCE1 (Twin rotary type)×1																							
Compressor motor (Starting method)		kW	— Direct line start																							
Refrigerant oil (Amount, type)		ℓ	— 0.90 MA68																							
Refrigerant (Type, amount, pre-charge length)		kg	R410A 2.55kg in outdoor unit (incl. the amount for the piping of : 15m)																							
Heat exchanger			Louver fin & inner grooved tubing M shape fin & inner grooved tubing																							
Refrigerant control			Capillary tubes + Electronic expansion valve																							
Fan type & Q'ty			Turbo fan ×1 Propeller fan ×1																							
Fan motor (Starting method)		W	140 < Direct line start > 86 < Direct line start >																							
Air flow	Cooling	m³/min	P-Hi : 37 Hi : 27 Me : 24 Lo : 20																							
	Heating		75																							
Available external static pressure		Pa	0																							
Outside air intake			Possible																							
Air filter, Quality / Quantity			Pocket plastic net ×1(Washable)																							
Shock & vibration absorber			Rubber sleeve(for fan motor)																							
Electric heater		W	—																							
Operation control	Remote control		(option) wired : RC-EX1A , RC-E5 , RCH-E3 wireless : RCN-T-36W-E																							
	Room temperature control		Thermostat by electronics																							
	Operation display		—																							
Safety equipments			Compressor overheat protection, Overcurrent protection, Frost protection, Serial signal error protection, Indoor fan motor error protection, Heating overload protection(High pressure control), Cooling overload protection																							
Installation data	Refrigerant piping size (O.D.)	mm	Liquid line: I/U φ 9.52 (3/8") Pipe φ 9.52(3/8")×0.8 O/U φ 9.52 (3/8") Gas line: I/U φ 15.88 (5/8") Pipe φ 15.88(5/8")×1.0 O/U φ 15.88 (5/8")																							
	Connecting method		Flare piping																							
	Attached length of piping	m	—																							
	Insulation for piping		Necessary (both Liquid & Gas lines)																							
	Refrigerant line (one way) length	m	Max.30m																							
	Vertical height diff. between O.U. and I.U.	m	Max.20m (Outdoor unit is higher) Max.20m (Outdoor unit is lower)																							
Drain hose			Hose connectable VP25 (O.D.32) Holes size φ 20 × 3pcs																							
Drain pump, max lift height		mm	Built-in drain pump , 700																							
Recommended breaker size		A	—																							
L.R.A. (Locked rotor ampere)		A	5.0																							
Interconnecting wires Size × Core number			1.5mm²×4 cores (Including earth cable) / Terminal block (Screw fixing type)																							
IP number			IPX0 IPX4																							
Standard accessories			Mounting kit, Drain hose																							
Option parts			—																							
Note (1) The data are measured at the following conditions.			The pipe length is 7.5m.																							
<table border="1"> <thead> <tr> <th rowspan="2">Item</th> <th colspan="2">Indoor air temperature</th> <th colspan="2">Outdoor air temperature</th> <th rowspan="2">Standards</th> </tr> <tr> <th>DB</th> <th>WB</th> <th>DB</th> <th>WB</th> </tr> </thead> <tbody> <tr> <td>Cooling</td> <td>27°C</td> <td>19°C</td> <td>35°C</td> <td>24°C</td> <td rowspan="2">ISO5151-T1</td> </tr> <tr> <td>Heating</td> <td>20°C</td> <td>—</td> <td>7°C</td> <td>6°C</td> </tr> </tbody> </table>		Item	Indoor air temperature		Outdoor air temperature		Standards	DB	WB	DB	WB	Cooling	27°C	19°C	35°C	24°C	ISO5151-T1	Heating	20°C	—	7°C	6°C				
Item	Indoor air temperature		Outdoor air temperature		Standards																					
	DB	WB	DB	WB																						
Cooling	27°C	19°C	35°C	24°C	ISO5151-T1																					
Heating	20°C	—	7°C	6°C																						
(2) This air-conditioner is manufactured and tested in conformity with the ISO.																										
(3) Sound level indicates the value in an anechoic chamber. During operation these values are somewhat higher due to ambient conditions.																										
(4) Select the breaker size according to the own national standard.																										
(5) When wireless remote control is used, fan is 3 speed setting (Hi-Me-Lo) only.																										
(6) The operation data indicate when the air-conditioner is operated at 230V 50Hz or 220V 60Hz.																										

(2) Ceiling suspended type (FDE)

Item		Model	FDE100VNP1VG																							
			Indoor unit FDE100VG	Outdoor unit FDC100VNP																						
Power source			1 Phase 220-240V 50Hz / 220V 60Hz																							
Operation data	Nominal cooling capacity (range)	kW	10.0 [2.8(Min.)— 11.2(Max.)]																							
	Nominal heating capacity (range)	kW	11.2 [2.5(Min.)— 12.5(Max.)]																							
	Power consumption	Cooling	kW	2.66																						
		Heating		2.94																						
	Max power consumption		4.28																							
	Running current	Cooling	A	11.7 / 12.2																						
		Heating		12.9 / 13.5																						
	Inrush current, max current		5, 21.0																							
	Power factor	Cooling	%	99																						
		Heating		99																						
	EER	Cooling		3.76																						
	COP	Heating		3.81																						
	Sound power level	Cooling	dB(A)	64																						
Heating		70																								
Sound pressure level	Cooling		P-Hi : 48 Hi : 43 Me : 38 Lo : 34																							
	Heating		57																							
Silent mode sound pressure level			61																							
Exterior dimensions (Height × Width × Depth)		mm	250 × 1,620 × 690																							
Exterior appearance (Munsell color)			Plaster white (6.8Y8.9/0.2)near equivalent																							
Net weight		kg	43																							
Compressor type & Q'ty			—																							
Compressor motor (Starting method)		kW	—																							
Refrigerant oil (Amount, type)		ℓ	—																							
Refrigerant (Type, amount, pre-charge length)		kg	R410A 2.55kg in outdoor unit (incl. the amount for the piping of : 15m)																							
Heat exchanger			Louver fin & inner grooved tubing																							
Refrigerant control			M shape fin & inner grooved tubing																							
Fan type & Q'ty			Capillary tubes + Electronic expansion valve																							
Fan motor (Starting method)		W	Centrifugal fan ×4																							
Air flow		m³/min	Propeller fan ×1																							
Available external static pressure		Pa	80 < Direct line start >																							
Outside air intake			86 < Direct line start >																							
Air filter, Quality / Quantity			Cooling 75																							
Shock & vibration absorber			Heating 79																							
Electric heater		W	0																							
Operation control			(option) wired : RC-EX1A , RC-E5 , RCH-E3 wireless : RCN-E-E																							
Safety equipments			Compressor overheat protection, Overcurrent protection, Frost protection, Serial signal error protection, Indoor fan motor error protection, Heating overload protection(High pressure control), Cooling overload protection																							
Installation data			Thermostat by electronics																							
Refrigerant piping size (O.D.)		mm	—																							
Connecting method			Liquid line: I/U φ 9.52 (3/8") Pipe φ 9.52(3/8")×0.8 O/U φ 9.52 (3/8")																							
Attached length of piping		m	Gas line: I/U φ 15.88 (5/8") Pipe φ 15.88(5/8")×1.0 O/U φ 15.88 (5/8")																							
Insulation for piping			Flare piping																							
Refrigerant line (one way) length		m	Flare piping																							
Vertical height diff. between O.U. and I.U.		m	Necessary (both Liquid & Gas lines)																							
Drain hose			Max.30m																							
Drain pump, max lift height		mm	Max.20m (Outdoor unit is higher)																							
Recommended breaker size		A	Max.20m (Outdoor unit is lower)																							
L.R.A. (Locked rotor ampere)		A	5.0																							
Interconnecting wires Size × Core number			1.5mm²×4 cores (Including earth cable) / Terminal block (Screw fixing type)																							
IP number			IPX0																							
Standard accessories			IPX4																							
Option parts			Mounting kit, Drain hose																							
Note (1) The data are measured at the following conditions.			The pipe length is 7.5m.																							
<table border="1"> <thead> <tr> <th rowspan="2">Item</th> <th colspan="2">Indoor air temperature</th> <th colspan="2">Outdoor air temperature</th> <th rowspan="2">Standards</th> </tr> <tr> <th>DB</th> <th>WB</th> <th>DB</th> <th>WB</th> </tr> </thead> <tbody> <tr> <td>Cooling</td> <td>27°C</td> <td>19°C</td> <td>35°C</td> <td>24°C</td> <td rowspan="2">ISO5151-T1</td> </tr> <tr> <td>Heating</td> <td>20°C</td> <td>—</td> <td>7°C</td> <td>6°C</td> </tr> </tbody> </table>		Item	Indoor air temperature		Outdoor air temperature		Standards	DB	WB	DB	WB	Cooling	27°C	19°C	35°C	24°C	ISO5151-T1	Heating	20°C	—	7°C	6°C				
Item	Indoor air temperature		Outdoor air temperature		Standards																					
	DB	WB	DB	WB																						
Cooling	27°C	19°C	35°C	24°C	ISO5151-T1																					
Heating	20°C	—	7°C	6°C																						
(2) This air-conditioner is manufactured and tested in conformity with the ISO.																										
(3) Sound level indicates the value in an anechoic chamber. During operation these values are somewhat higher due to ambient conditions.																										
(4) Select the breaker size according to the own national standard.																										
(5) When wireless remote control is used, fan is 3 speed setting (Hi-Me-Lo) only.																										
(6) The operation data indicate when the air-conditioner is operated at 230V 50Hz or 220V 60Hz.																										

(3) Duct connected-High static pressure type (FDU)

Item		Model	FDU100VNP1VF2		
			Indoor unit FDU100VF2	Outdoor unit FDC100VNP	
Power source			1 Phase 220-240V 50Hz / 220V 60Hz		
Operation data	Nominal cooling capacity (range)	kW	10.0 [2.8(Min.)— 11.2(Max.)]		
	Nominal heating capacity (range)	kW	11.2 [2.5(Min.)— 12.5(Max.)]		
	Power consumption	Cooling	kW	3.00	
		Heating		2.93	
	Max power consumption		4.60		
	Running current	Cooling	A	13.2 / 13.8	
		Heating		12.9 / 13.5	
	Inrush current, max current		5, 22.0		
	Power factor	Cooling	%	99	
		Heating		99	
	EER	Cooling		3.33	
	COP	Heating		3.82	
	Sound power level	Cooling	dB(A)	65	
Heating		70			
Sound pressure level	Cooling	dB(A)	P-Hi : 44 Hi : 38 Me : 36 Lo : 30		
	Heating		57		
Silent mode sound pressure level			Cooling:50 / Heating:49		
Exterior dimensions (Height × Width × Depth)		mm	280 × 1,370 × 740		
Exterior appearance (Munsell color)			Stucco white (4.2Y7.5/1.1)near equivalent		
Net weight		kg	54		
Compressor type & Q'ty			RMT5126MCE1 (Twin rotary type)×1		
Compressor motor (Starting method)		kW	Direct line start		
Refrigerant oil (Amount, type)		ℓ	0.90 MA68		
Refrigerant (Type, amount, pre-charge length)		kg	R410A 2.55kg in outdoor unit (incl. the amount for the piping of : 15m)		
Heat exchanger			Louver fin & inner grooved tubing M shape fin & inner grooved tubing		
Refrigerant control			Capillary tubes + Electronic expansion valve		
Fan type & Q'ty			Centrifugal fan ×3 Propeller fan ×1		
Fan motor (Starting method)		W	100 + 130 < Direct line start > 86 < Direct line start >		
Air flow	Cooling	m³/min	P-Hi : 36 Hi : 28 Me : 25 Lo : 19		
	Heating		75		
Available external static pressure		Pa	Standard : 60 Max : 200		
Outside air intake			Possible		
Air filter, Quality / Quantity			Procure locally		
Shock & vibration absorber			Rubber sleeve(for fan motor) Rubber sleeve (for fan motor & compressor)		
Electric heater		W	—		
Operation control	Remote control		(option) wired : RC-EX1A , RC-E5 , RCH-E3 wireless : RCN-KIT3-E		
	Room temperature control		Thermostat by electronics		
	Operation display		—		
Safety equipments			Compressor overheat protection, Overcurrent protection, Frost protection, Serial signal error protection, Indoor fan motor error protection, Heating overload protection(High pressure control), Cooling overload protection		
Installation data	Refrigerant piping size (O.D.)	mm	Liquid line: I/U φ 9.52 (3/8") Pipe φ 9.52(3/8")×0.8 O/U φ 9.52 (3/8") Gas line: I/U φ 15.88 (5/8") Pipe φ 15.88(5/8")×1.0 O/U φ 15.88 (5/8")		
	Connecting method		Flare piping		
	Attached length of piping	m	—		
	Insulation for piping		Necessary (both Liquid & Gas lines)		
	Refrigerant line (one way) length	m	Max.30m		
	Vertical height diff. between O.U. and I.U.	m	Max.20m (Outdoor unit is higher) Max.20m (Outdoor unit is lower)		
Drain hose			Hose connectable VP25 (I.D.25,O.D.32) Holes size φ 20 × 3pcs		
Drain pump, max lift height		mm	Built-in drain pump , 600		
Recommended breaker size		A	—		
L.R.A. (Locked rotor ampere)		A	5.0		
Interconnecting wires Size × Core number			1.5mm²×4 cores (Including earth cable) / Terminal block (Screw fixing type)		
IP number			IPX0 IPX4		
Standard accessories			Mounting kit, Drain hose		
Option parts			—		
Note (1) The data are measured at the following conditions.			The pipe length is 7.5m.		
Operation	Indoor air temperature	DB	—		
		WB	—		
	Outdoor air temperature	DB	35°C		
Cooling	27°C	WB	19°C		
Heating	20°C	—	7°C		
	—	—	6°C		
			External static pressure of indoor unit	Standards	
			60Pa	ISO5151-T1	

- (2) This air-conditioner is manufactured and tested in conformity with the ISO.
- (3) Sound level indicates the value in an anechoic chamber. During operation these values are somewhat higher due to ambient conditions.
- (4) Select the breaker size according to the own national standard.
- (5) When wireless remote control is used, fan is 3 speed setting (Hi-Me-Lo) only.
- (6) The operation data indicate when the air-conditioner is operated at 230V 50Hz or 220V 60Hz.
- (7) The factory E.S.P. setting is set within the range of 80 - 150 Pa.If SW8-4 is turned to "ON", E.S.P. setting range can be changed to 10 - 200 Pa.(For RC-EX1A and RC-E5 only)

(4) Duct connected-Low / Middle static pressure type (FDUM)

Item		Model	FDUM100VNP1VF2			
			Indoor unit FDUM100VF2	Outdoor unit FDC100VNP		
Power source			1 Phase 220-240V 50Hz / 220V 60Hz			
Operation data	Nominal cooling capacity (range)	kW	10.0 [2.8(Min.)— 11.2(Max.)]			
	Nominal heating capacity (range)	kW	11.2 [2.5(Min.)— 12.5(Max.)]			
	Power consumption	Cooling	kW	3.00		
		Heating		2.93		
	Max power consumption		4.60			
	Running current	Cooling	A	13.2 / 13.8		
		Heating		12.9 / 13.5		
	Inrush current, max current		5, 22.0			
	Power factor	Cooling	%	99		
		Heating		99		
	EER	Cooling		3.33		
	COP	Heating		3.82		
	Sound power level	Cooling	dB(A)	65		
Heating		70				
Sound pressure level	Cooling	dB(A)	P-Hi : 44 Hi : 38 Me : 36 Lo : 30			
	Heating		57			
Silent mode sound pressure level			61			
Exterior dimensions (Height × Width × Depth)		mm	280 × 1,370 × 740			
Exterior appearance (Munsell color)			Stucco white (4.2Y7.5/1.1)near equivalent			
Net weight		kg	54			
Compressor type & Q'ty			RMT5126MCE1 (Twin rotary type)×1			
Compressor motor (Starting method)		kW	—			
Refrigerant oil (Amount, type)		ℓ	—			
Refrigerant (Type, amount, pre-charge length)		kg	R410A 2.55kg in outdoor unit (incl. the amount for the piping of : 15m)			
Heat exchanger			Louver fin & inner grooved tubing M shape fin & inner grooved tubing			
Refrigerant control			Capillary tubes + Electronic expansion valve			
Fan type & Q'ty			Centrifugal fan ×3 Propeller fan ×1			
Fan motor (Starting method)		W	100 + 130 < Direct line start >			
Air flow	Cooling	m³/min	P-Hi : 36 Hi : 28 Me : 25 Lo : 19			
	Heating		75			
Available external static pressure		Pa	Standard : 60 Max : 100			
Outside air intake			Possible			
Air filter, Quality / Quantity			Procure locally			
Shock & vibration absorber			Rubber sleeve(for fan motor)			
Electric heater		W	—			
Operation control	Remote control		(option) wired : RC-EX1A , RC-E5 , RCH-E3 wireless : RCN-KIT3-E			
	Room temperature control		Thermostat by electronics			
	Operation display		—			
Safety equipments			Compressor overheat protection, Overcurrent protection, Frost protection, Serial signal error protection, Indoor fan motor error protection, Heating overload protection(High pressure control), Cooling overload protection			
Installation data	Refrigerant piping size (O.D.)	mm	Liquid line: I/U φ 9.52 (3/8") Pipe φ 9.52(3/8")×0.8 O/U φ 9.52 (3/8") Gas line: I/U φ 15.88 (5/8") Pipe φ 15.88(5/8")×1.0 O/U φ 15.88 (5/8")			
	Connecting method		Flare piping			
	Attached length of piping	m	—			
	Insulation for piping		Necessary (both Liquid & Gas lines)			
	Refrigerant line (one way) length	m	Max.30m			
	Vertical height diff. between O.U. and I.U.	m	Max.20m (Outdoor unit is higher) Max.20m (Outdoor unit is lower)			
Drain hose			Hose connectable VP25 (I.D.25,O.D.32) Holes size φ 20 × 3pcs			
Drain pump, max lift height		mm	Built-in drain pump , 600			
Recommended breaker size		A	—			
L.R.A. (Locked rotor ampere)		A	5.0			
Interconnecting wires Size × Core number			1.5mm²×4 cores (Including earth cable) / Terminal block (Screw fixing type)			
IP number			IPX0 IPX4			
Standard accessories			Mounting kit, Drain hose			
Option parts			UM-FL3EF			
Note (1) The data are measured at the following conditions.			The pipe length is 7.5m.			
Operation	Indoor air temperature	Outdoor air temperature		External static pressure of indoor unit	Standards	
		DB	WB			DB
	27°C	19°C	35°C			24°C
Heating	20°C	—	7°C	6°C		

- (2) This air-conditioner is manufactured and tested in conformity with the ISO.
- (3) Sound level indicates the value in an anechoic chamber. During operation these values are somewhat higher due to ambient conditions.
- (4) Select the breaker size according to the own national standard.
- (5) When wireless remote control is used, fan is 3 speed setting (Hi-Me-Lo) only.
- (6) The operation data indicate when the air-conditioner is operated at 230V 50Hz or 220V 60Hz.
- (7) Static pressure of optional air filter "UM-FL3EF" is 5Pa initially.
- (8) The external static pressure setting can be changed to 10-100Pa. (For RC-EX1A and RC-E5 only)

(5) Floor standing type (FDF)

Item		Model	FDF100VNP1VD2		
			Indoor unit FDF100VD2	Outdoor unit FDC100VNP	
Power source			1 Phase 220-240V 50Hz / 220V 60Hz		
Operation data	Nominal cooling capacity (range)	kW	10.0 [2.8(Min.)— 11.2(Max.)]		
	Nominal heating capacity (range)	kW	11.2 [2.5(Min.)— 12.5(Max.)]		
	Power consumption	Cooling	kW	3.19	
		Heating		3.09	
	Max power consumption		4.60		
	Running current	Cooling	A	14.0 / 14.6	
		Heating		13.6 / 14.2	
	Inrush current, max current		5, 21.0		
	Power factor	Cooling	%	99	
		Heating		99	
	EER	Cooling		3.13	
	COP	Heating		3.62	
	Sound power level	Cooling	dB(A)	65	70
Heating					
Sound pressure level	Cooling	dB(A)	P-Hi : 54 Hi : 50 Me : 48 Lo : 44	57	
	Heating			61	
Silent mode sound pressure level			—	Cooling:50 / Heating:49	
Exterior dimensions (Height × Width × Depth)		mm	1,850 × 600 × 320	845×970×370	
Exterior appearance (Munsell color)			Ceramic white (N8.0)near equivalent	Stucco white (4.2Y7.5/1.1)near equivalent	
Net weight		kg	52	70	
Compressor type & Q'ty			—	RMT5126MCE1 (Twin rotary type)×1	
Compressor motor (Starting method)		kW	—	Direct line start	
Refrigerant oil (Amount, type)		ℓ	—	0.90 MA68	
Refrigerant (Type, amount, pre-charge length)		kg	R410A 2.55kg in outdoor unit (incl. the amount for the piping of : 15m)		
Heat exchanger			Louver fin & inner grooved tubing	M shape fin & inner grooved tubing	
Refrigerant control			Capillary tubes + Electronic expansion valve		
Fan type & Q'ty			Centrifugal fan ×1	Propeller fan ×1	
Fan motor (Starting method)		W	157 < Direct line start >	86 < Direct line start >	
Air flow	Cooling	m³/min	P-Hi : 29 Hi : 26 Me : 23 Lo : 19		
	Heating				
Available external static pressure		Pa	0	0	
Outside air intake			Not possible	—	
Air filter, Quality / Quantity			Plastic net ×1(Washable)	—	
Shock & vibration absorber			Rubber sleeve(for fan motor)	Rubber sleeve (for fan motor & compressor)	
Electric heater		W	—	—	
Operation control	Remote control		RC-E5 (Installed) / wireless : RCN-KIT3-E (option)		
	Room temperature control		Thermostat by electronics		
	Operation display		—		
Safety equipments			Compressor overheat protection, Overcurrent protection, Frost protection, Serial signal error protection, Indoor fan motor error protection, Heating overload protection(High pressure control), Cooling overload protection		
Installation data	Refrigerant piping size (O.D.)	mm	Liquid line: I/U φ 9.52 (3/8") Pipe φ 9.52(3/8")×0.8 O/U φ 9.52 (3/8") Gas line: I/U φ 15.88 (5/8") Pipe φ 15.88(5/8")×1.0 O/U φ 15.88 (5/8")		
	Connecting method		Flare piping	Flare piping	
	Attached length of piping	m	—	—	
	Insulation for piping		Necessary (both Liquid & Gas lines)		
	Refrigerant line (one way) length	m	Max.30m		
	Vertical height diff. between O.U. and I.U.	m	Max.20m (Outdoor unit is higher)	Max.20m (Outdoor unit is lower)	
Drain hose			Hose connectable with VP20	Holes size φ 20 × 3pcs	
Drain pump, max lift height		mm	—	—	
Recommended breaker size		A	—		
L.R.A. (Locked rotor ampere)		A	5.0		
Interconnecting wires Size × Core number			1.5mm²×4 cores (Including earth cable) / Terminal block (Screw fixing type)		
IP number			IPX0	IPX4	
Standard accessories			Mounting kit	Drain elbow, Drain hole grommet	
Option parts			—		
Note (1) The data are measured at the following conditions. The pipe length is 7.5m.					
Operation	Cooling	Indoor air temperature	Outdoor air temperature		Standards
		DB	WB	DB	
	27°C	19°C	35°C	24°C	
Heating	20°C	—	7°C	6°C	
<p>(2) This air-conditioner is manufactured and tested in conformity with the ISO.</p> <p>(3) Sound level indicates the value in an anechoic chamber. During operation these values are somewhat higher due to ambient conditions.</p> <p>(4) Select the breaker size according to the own national standard.</p> <p>(5) When wireless remote control is used, fan is 3 speed setting (Hi-Me-Lo) only.</p> <p>(6) The operation data indicate when the air-conditioner is operated at 230V 50Hz or 220V 60Hz.</p>					

(6) Wall mounted type (SRK)

Item		Model	SRK100VNP1ZR			
			Indoor unit SRK100ZR-S	Outdoor unit FDC100VNP		
Power source			1 Phase 220-240V 50Hz / 220V 60Hz			
Operation data	Nominal cooling capacity (range)	kW	10.0 [2.4(Min.)— 10.5(Max.)]			
	Nominal heating capacity (range)	kW	11.2 [3.2(Min.)— 11.5(Max.)]			
	Heating capacity (H2)	kW	—			
	Power consumption	Cooling	kW	3.09 (0.6 - 3.2)		
		Heating		3.28 (0.6 - 3.6)		
	Max power consumption		4.6			
	Running current	Cooling	A	14.2 / 13.6 / 13.0 (220/ 230/ 240 V)		
		Heating		15.1 / 14.4 / 13.8 (220/ 230/ 240 V)		
	Inrush current, max current		15.1 / 14.4 / 13.8 (220/ 230/ 240 V) Max. 21			
	Power factor	Cooling	%	99		
		Heating		99		
	EER	Cooling		3.24		
	COP	Heating		3.41		
		Heating (H2)		—		
Sound power level	Cooling	dB(A)	63			
	Heating		70			
Sound pressure level	Cooling	dB(A)	63			
	Heating		74			
Sound pressure level	Cooling	dB(A)	Hi : 48 Me : 45 Lo : 40 ULo : 27			
	Heating		Hi : 48 Me : 43 Lo : 38 ULo : 30			
Silent mode sound pressure level			—			
Exterior dimensions (Height × Width × Depth)	mm		339 x 1197 x 262	845×970×370		
Exterior appearance (Munsell color)			Fine snow (8.0Y 9.3/0.1) near equivalent	Stucco white (4.2Y7.5/1.1)near equivalent		
Net weight	kg		16.5	70		
Compressor type & Q'ty			—	RMT5126MCE1 (Twin rotary type)×1		
Compressor motor (Starting method)	kW		—	4.0 (Inverter driven)		
Refrigerant oil (Amount, type)	ℓ		—	0.90 (DIAMOND FREEZE MA68)		
Refrigerant (Type, amount, pre-charge length)	kg		R410A 2.55 in outdoor unit (incl. the amount for the piping of 15m)			
Heat exchanger			Louver fin & inner grooved tubing	M fin & inner grooved tubing		
Refrigerant control			Capillary tubes + Electronic expansion valve			
Fan type & Q'ty			Tangential fan x 1	Propeller fan x1		
Fan motor (Starting method)	W		56 x1 (Direct drive)	86 x1 (Direct drive)		
Air flow	Cooling	m ³ /min	Hi : 24.5 Me : 21.3 Lo : 17.6 ULo : 10.4			
	Heating		Hi : 27.5 Me : 23.2 Lo : 19.1 ULo : 13.6			
Available external static pressure	Pa		0			
Outside air intake			Not possible			
Air filter, Quality / Quantity			Polypropylene net (washable) x 2			
Shock & vibration absorber			Rubber sleeve(for fan motor)	Rubber sleeve (for fan motor & compressor)		
Electric heater			—			
Operation control	Remote control		Wireless-Remote control			
	Room temperature control		Microcomputer thermostat			
	Operation display		RUN: Green, TIMER: Yellow, HI POWER: Green, 3D AUTO: Green			
Safety equipments			Compressor overheat protection, Overcurrent protection, Frost protection, Serial signal error protection, Indoor fan motor error protection, Heating overload protection(High pressure control), Cooling overload protection			
Installation data	Refrigerant piping size (O.D.)	mm	Liquid line: ϕ 9.52 (3/8") Gas line: ϕ 15.88 (5/8")			
	Connecting method		Flare connection			
	Attached length of piping	m	Liquid line : 0.78 / Gas line : 0.72			
	Insulation for piping		Necessary (Both sides), independent			
	Refrigerant line (one way) length	m	Max.30m			
	Vertical height diff. between O.U. and I.U.	m	Max.20 (Outdoor unit is higher) / Max.20 (Outdoor unit is lower)			
Drain hose			Hose connectable (VP 16)			
Drain pump, max lift height	mm		—			
Recommended breaker size	A		30			
L.R.A. (Locked rotor ampere)	A		5 / 5 / 5 (220/ 230/ 240 V)			
Interconnecting wires	Size × Core number		1.5mm ² × 4 cores (Including earth cable) / Terminal block (Screw fixing type)			
IP number			IPX0	IPX4		
Standard accessories			Mounting kit, Clean filter (Allergen clear filter x 1, Photocatalytic washable deodorizing filter x 1)			
Option parts			Interface kit (SC-BIKN-E), Drain Hose			
Note (1) The data are measured at the following conditions. The pipe length is 5m.						
	Item	Indoor air temperature		Outdoor air temperature		Standards
	Operation	DB	WB	DB	WB	
	Cooling	27°C	19°C	35°C	24°C	
	Heating	20°C	—	7°C	6°C	
	Heating (H2)	20°C	—	2°C	1°C	
(2) This air-conditioner is manufactured and tested in conformity with the ISO.						
(3) Sound level indicates the value in an anechoic chamber. During operation these values are somewhat higher due to ambient conditions.						
(4) Select the breaker size according to the own national standard.						

2. EXTERIOR DIMENSIONS

(1) Indoor units

(a) Ceiling cassette-4way type (FDT)

Model FDT100VF2

Symbol	Content	
A	Gas piping	φ 15.88 (5/8") (Flare)
B	Liquid piping	φ 9.52 (3/8") (Flare)
C	Drain piping	VP25 (I.D.25, O.D.32)
D	Hole for wiring	
F	Suspension bolts	(M10 or M8)
G	Outside air opening for ducting	(Knock out)
H	Air outlet opening for ducting	(Knock out)

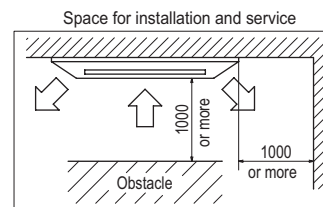

Make a space of 5000 or more between the units when installing more than one.

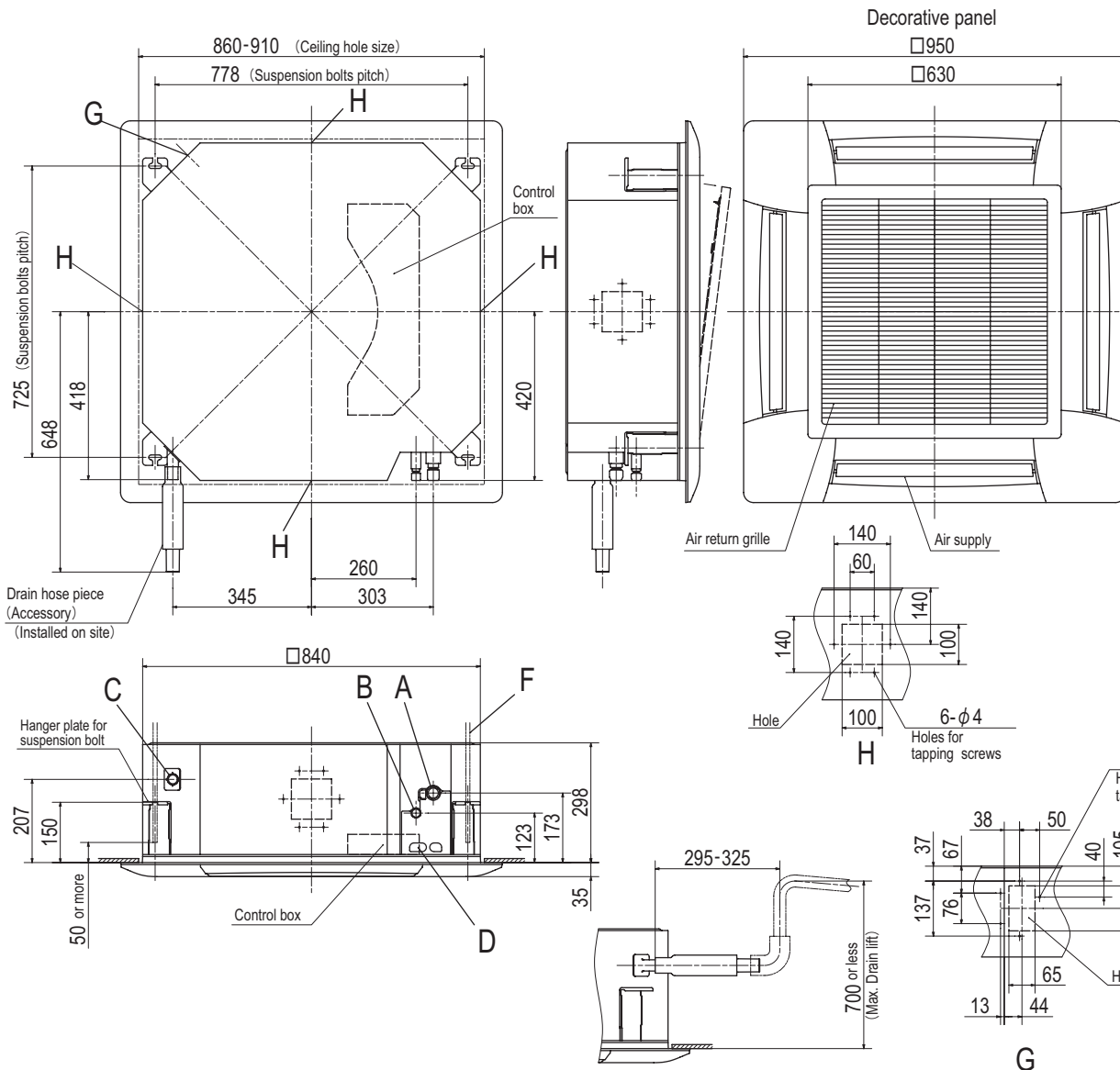

Unit:mm

PJF000Z285

Note (1) The model name label is attached on the fan casing inside the air return grille.

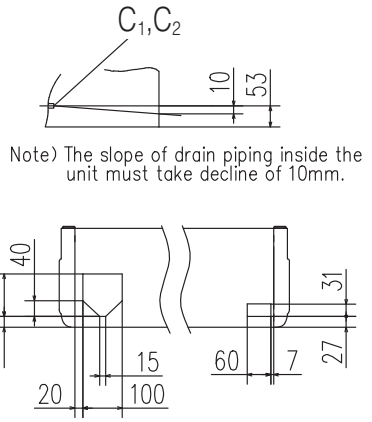
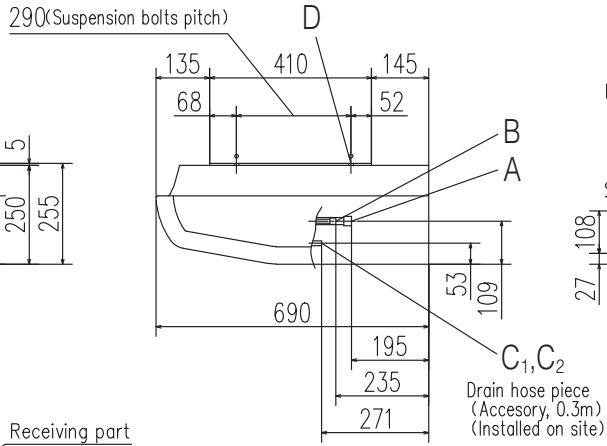
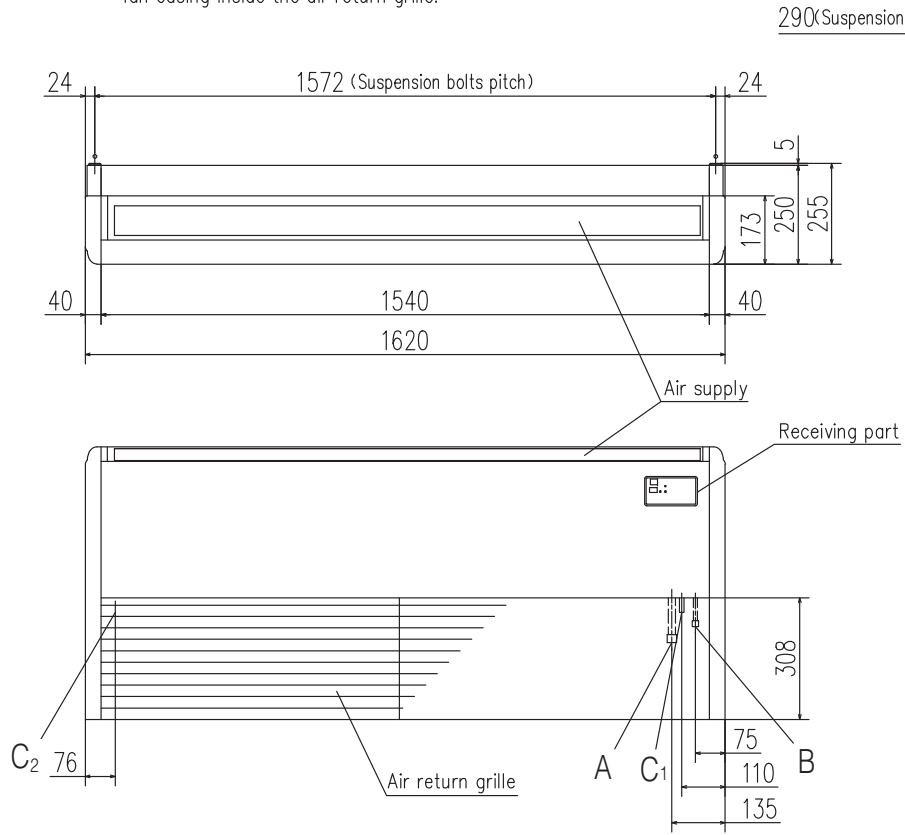

Symbol	Content	
A	Gas piping	φ15.88 (5/8") (Flare)
B	Liquid piping	φ9.52 (3/8") (Flare)
C 1,2	Drain piping	VP20 (I.D. 20, O.D. 26)
D	Hole for suspension bolt	(M10 or M8)
E	Back cutout	PE cover
F	Top cutout	Plate cover
G	Hole for drain piping (for left back)	(Knock out)

Unit: mm

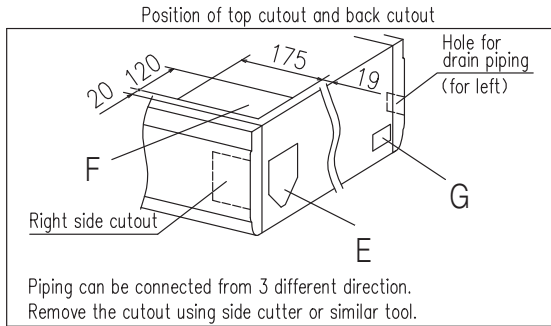
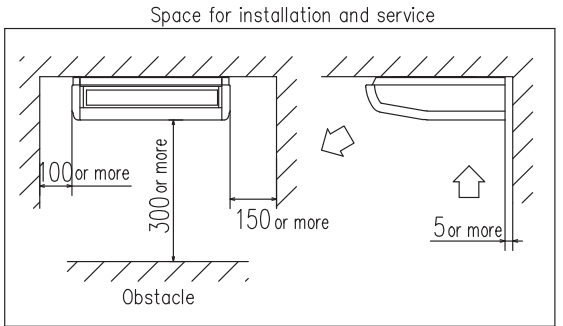

PFA004Z027

Make a space of 5000 or more between the units when installing more than one.

(b) Ceiling suspended type (FDE)
Model FDE100VG

**(c) Duct connected-High static pressure type (FDU)
Model FDU100VF2**

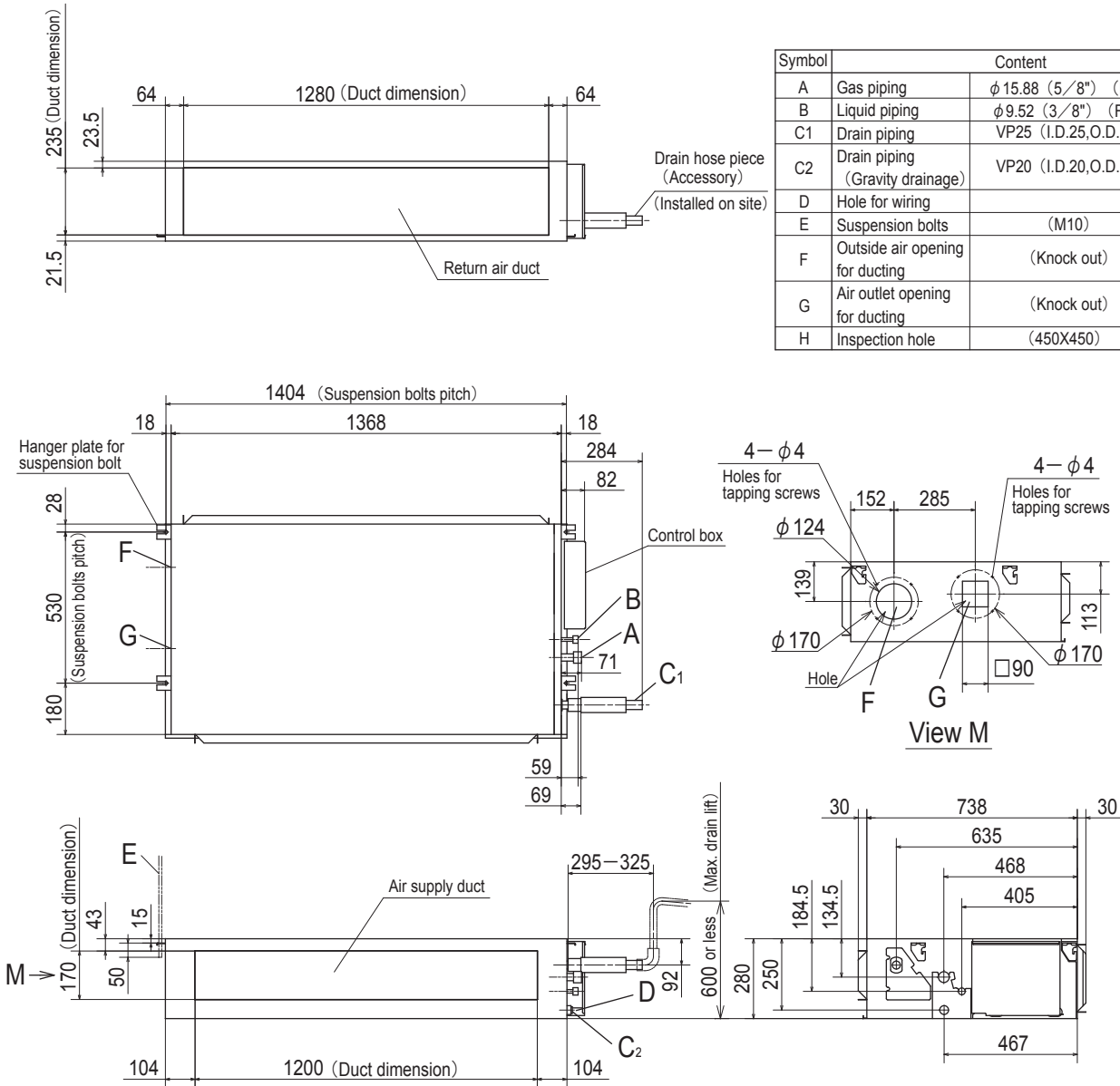

Symbol	Content	
A	Gas piping	φ 15.88 (5/8") (Flare)
B	Liquid piping	φ 9.52 (3/8") (Flare)
C1	Drain piping	VP25 (I.D.25,O.D.32)
C2	Drain piping (Gravity drainage)	VP20 (I.D.20,O.D.26)
D	Hole for wiring	
E	Suspension bolts	(M10)
F	Outside air opening for ducting	(Knock out)
G	Air outlet opening for ducting	(Knock out)
H	Inspection hole	(450X450)

Unit:mm

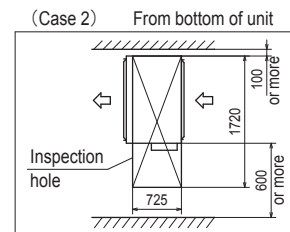
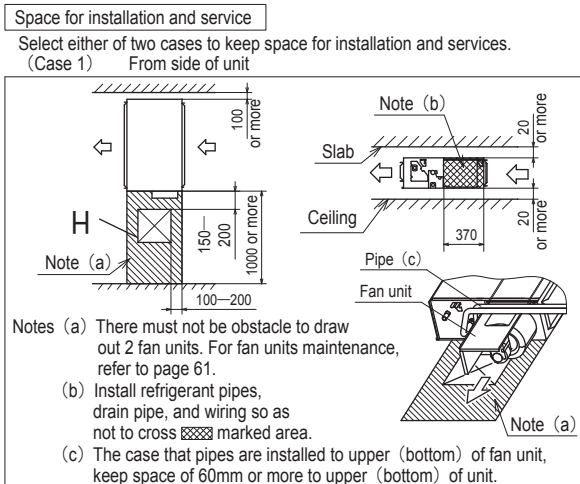

Notes (1) The model name label is attached on the lid of the control box.

PJG000Z048

**(d) Duct connected-Low / Middle static pressure type (FDUM)
Model FDUM100VF2**

Symbol	Content	
A	Gas piping	φ 15.88 (5/8") (Flare)
B	Liquid piping	φ 9.52 (3/8") (Flare)
C1	Drain piping	VP25 (I.D.25,O.D.32)
C2	Drain piping (Gravity drainage)	VP20 (I.D.20,O.D.26)
D	Hole for wiring	
E	Suspension bolts	(M10)
F	Outside air opening for ducting	(φ 150) (Knock out)
G	Air outlet opening for ducting	(φ 125) (Knock out)
H	Inspection hole	(450X450)

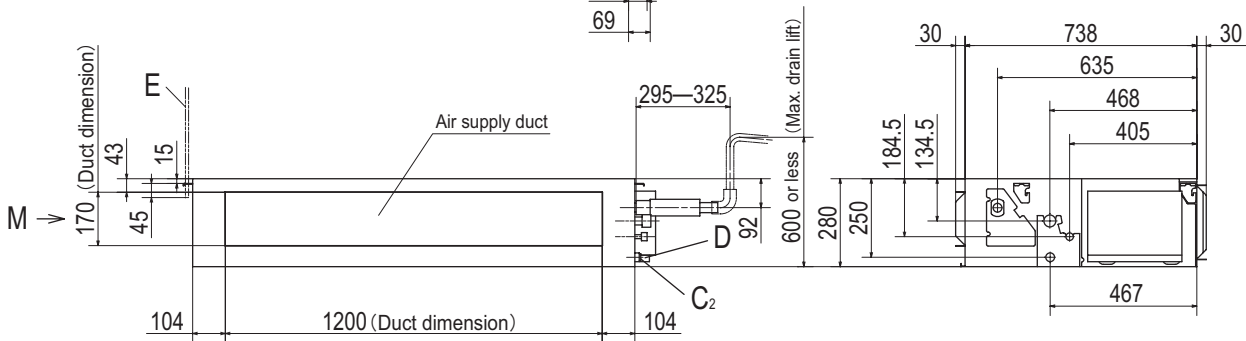
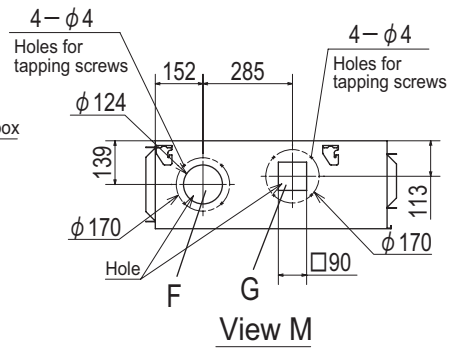
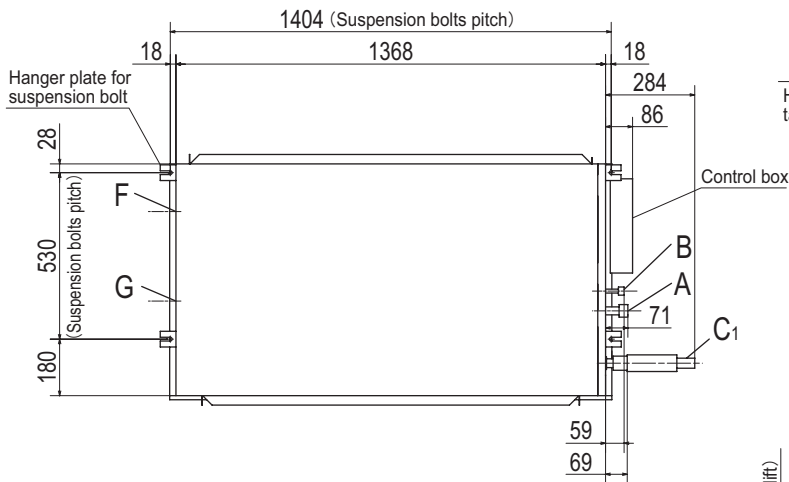
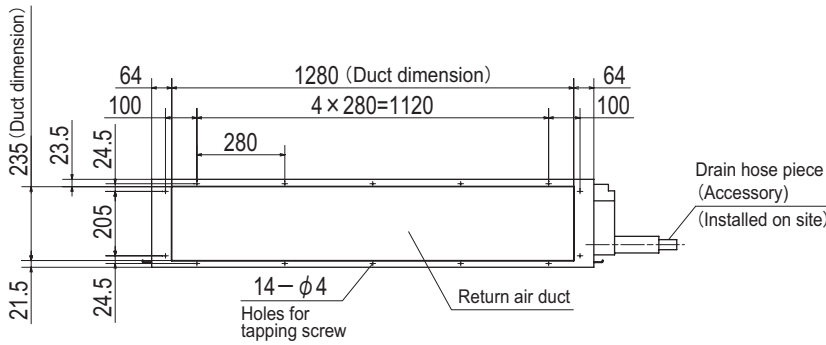

Unit:mm

Space for installation and service

Select either of two cases to keep space for installation and services.

(Case 1) From side of unit

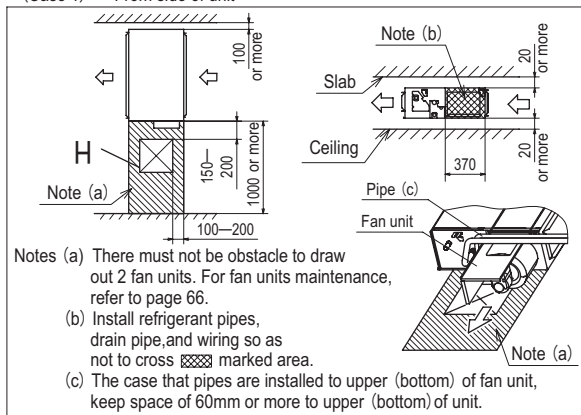

(Case 2) From bottom of unit

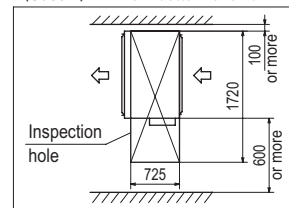

Note (1) The model name label is attached on the lid of the control box.

PJG000Z004

(e) Floor standing type (FDF)
Model FDF100VD2

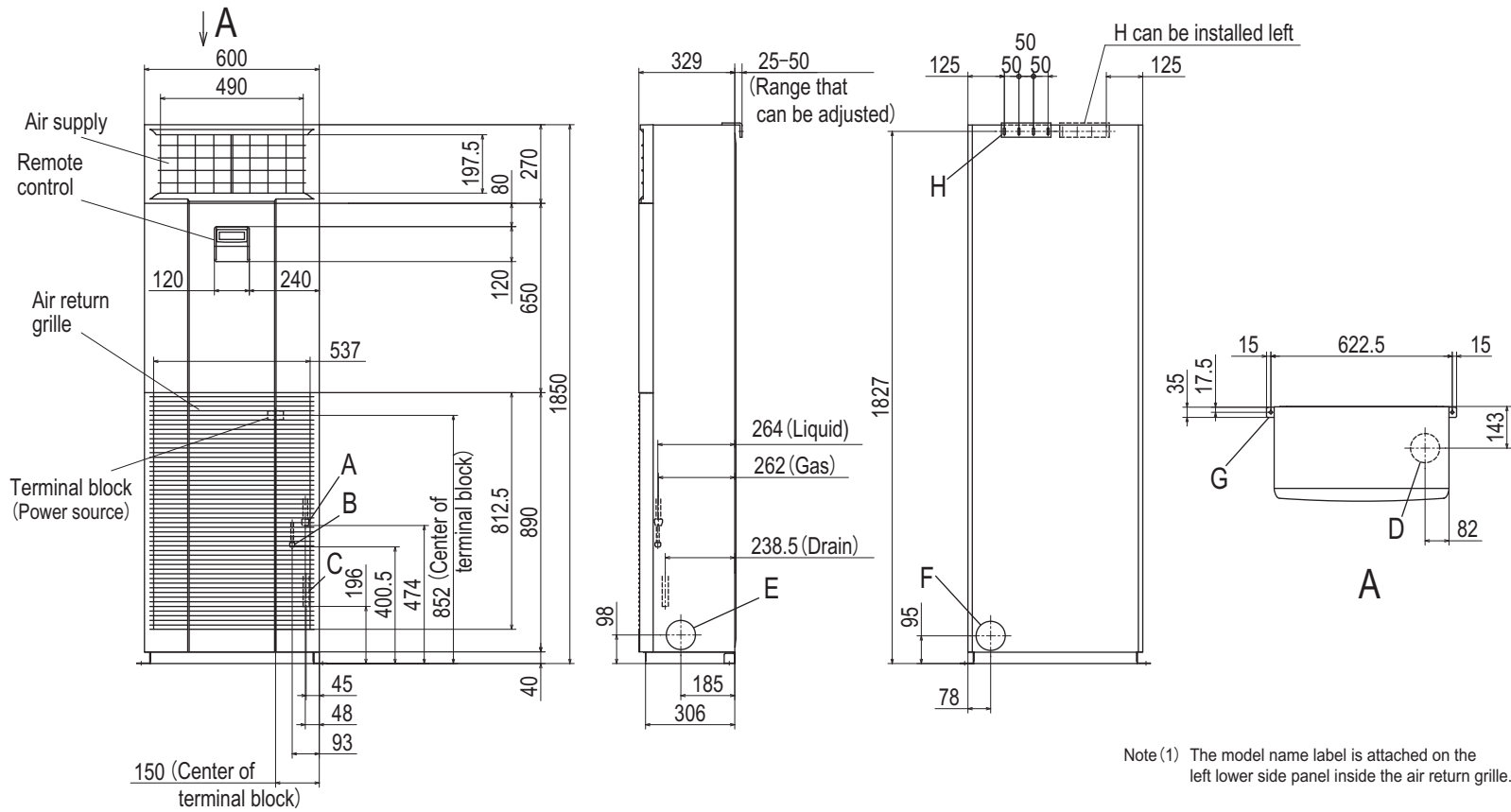

Note (1) The model name label is attached on the left lower side panel inside the air return grille.

Space for installation and service

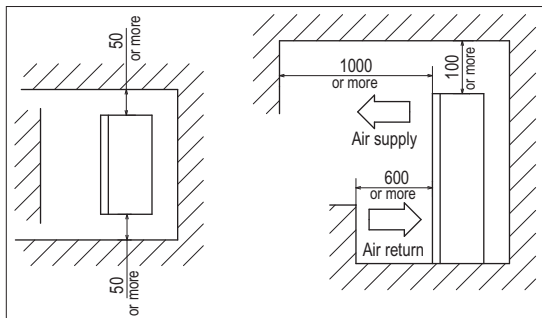

Symbol	Content	
A	Gas piping	φ 15.88 (5/8") (Flare)
B	Liquid piping	φ 9.52 (3/8") (Flare)
C	Drain piping	VP20 (I.D.20,O.D.26)
D	Hole on wall for bottom piping	φ 100 (Resin cap having)
E	Hole on wall for side piping/ Fresh air intake (Both left and right)	φ 100 (Knock out)
F	Hole on wall for rear piping	φ 100 (Knock out)
G	Metal fittings to fix to floor face	M8 (2 places)
H	Fall prevention metal fittings	4-7 × 25 (Slot)

Unit:mm

PGA000Z801 A

(f) Wall mounted type (SRK)
Model SRK100ZR-S

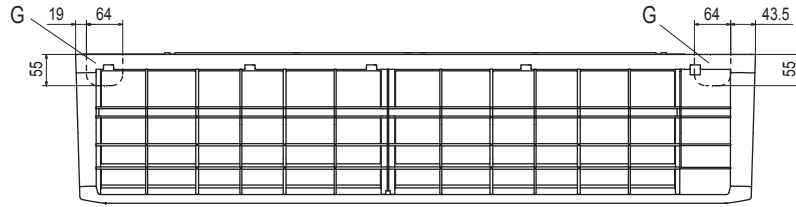

Symbol	Content	
A	Gas piping	φ 15.88 (5/8") (Flare)
B	Liquid piping	φ 9.52 (3/8") (Flare)
C	Hole on wall for right rear piping	(φ 65)
D	Hole on wall for left rear piping	(φ 65)
E	Drain hose	VP16
F	Outlet for wiring (on both side)	
G	Outlet for piping (on both side)	

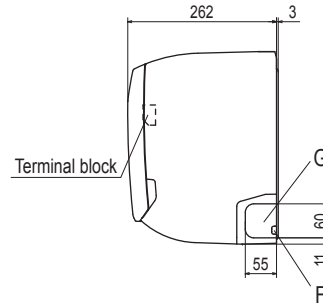
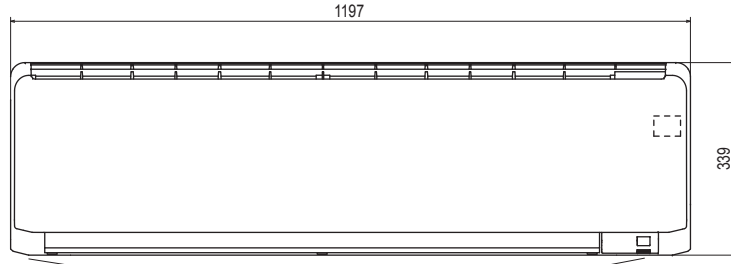

Outlet for down piping
(Refer to the above view)

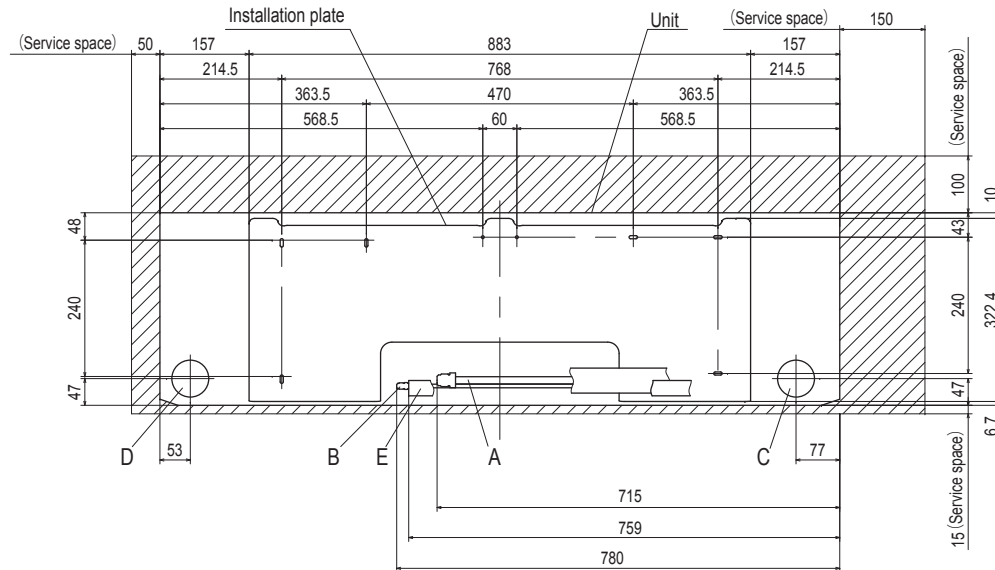

Space for installation and service when viewing from the front

Note (1) The model name label is attached on the underside of the indoor unit.

Unit:mm

RLD000Z002

PCA001Z787

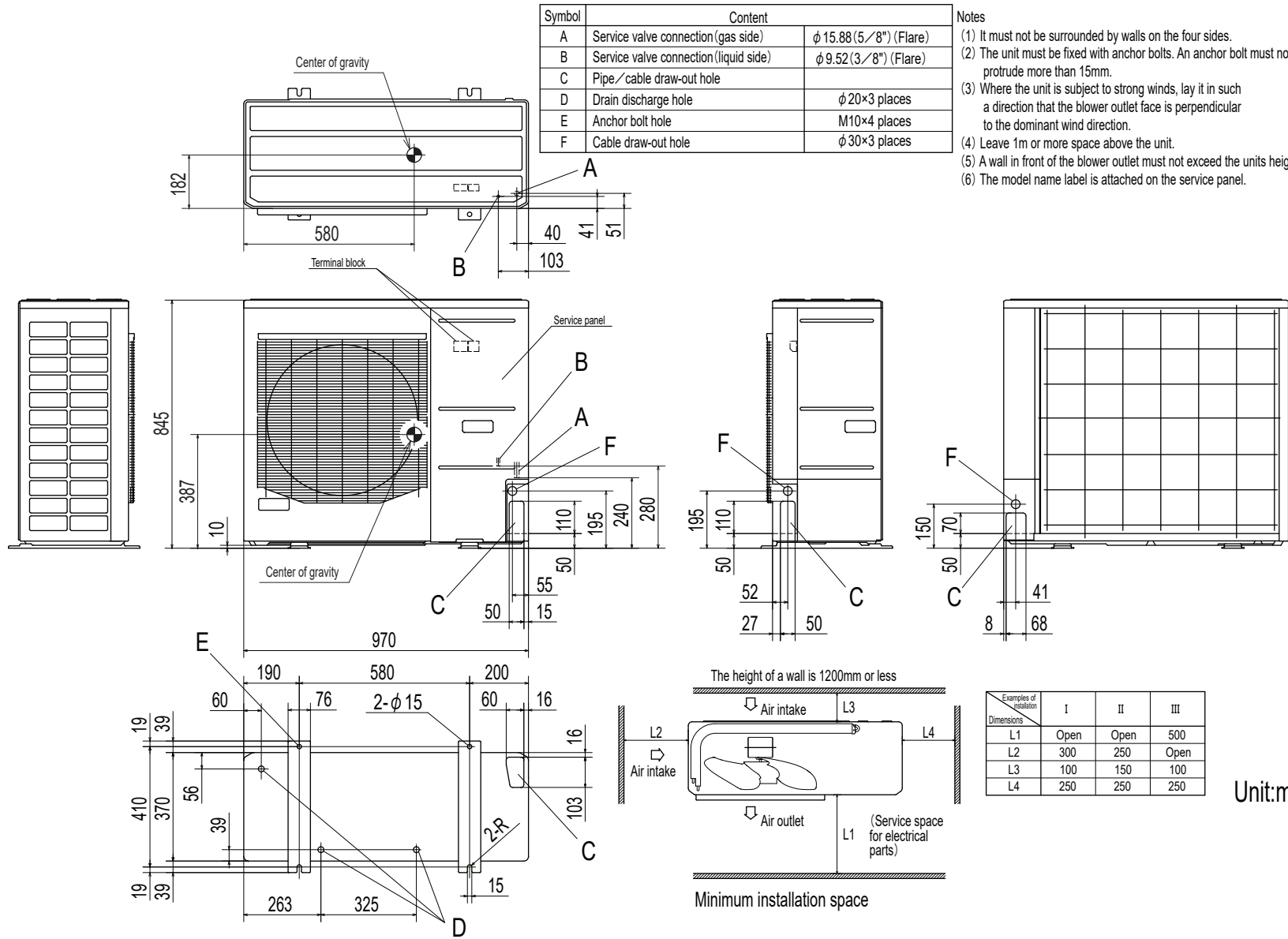

(2) Outdoor unit
Model FDC100VNP

(3) Remote control

(a) Wired remote control (Option parts)

Model:RC-EX1A

Interface kit (SC-BIKN-E) is required to use the wired remote control. (SRK series only)

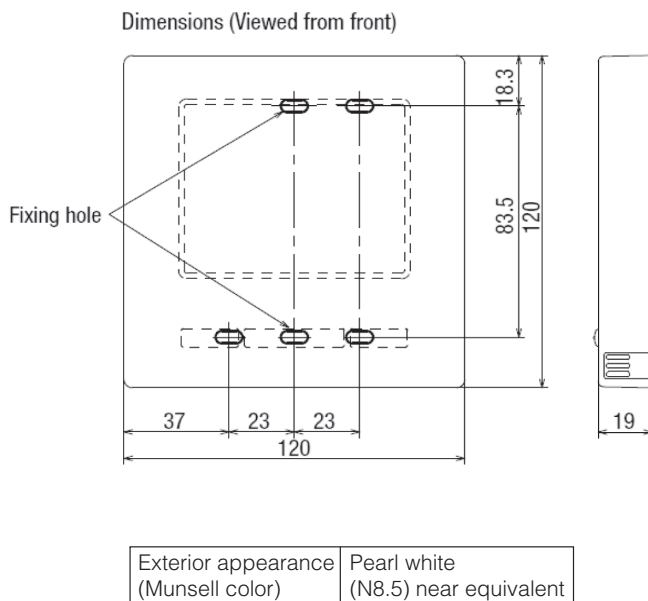

Installation space

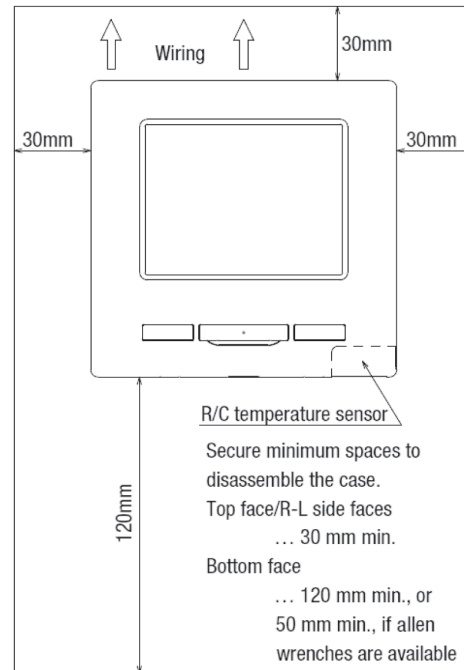

Cautions for selecting installation place

- (1) Installation surface must be flat and sufficiently strong.
R/C case must not be deformed.
- (2) Where the R/C can detect room temperatures accurately
This is a must when detecting room temperatures with the temperature sensor of R/C.
 - Install the R/C where it can detect the average temperature in the room.
 - Install the R/C sufficiently separated from a heat source.
 - Install the R/C where it will not be influenced by the turbulence of air when the door is opened or closed.
 Select a place where the R/C is not exposed to direct sunlight or blown by winds from the air-conditioner or temperatures on the wall surface will not deviate largely from indoor air temperatures.

R/C cable: 0.3mm² × 2-core

When the cable length is longer than 100 m, the max size for wires used in the R/C case is 0.5 mm². Connect them to wires of larger size near the outside of R/C. When wires are connected, take measures to prevent water, etc. from entering inside.

< 200 m	0.5 mm ² x 2-core
< 300 m	0.75 mm ² x 2-core
< 400 m	1.25 mm ² x 2-core
< 600 m	2.0 mm ² x 2-core

Adapted to **RoHS** directive

PJZ000Z297

Model RC-E5

Interface kit (SC-BIKN-E) is required to use the wired remote control. (SRK series only)

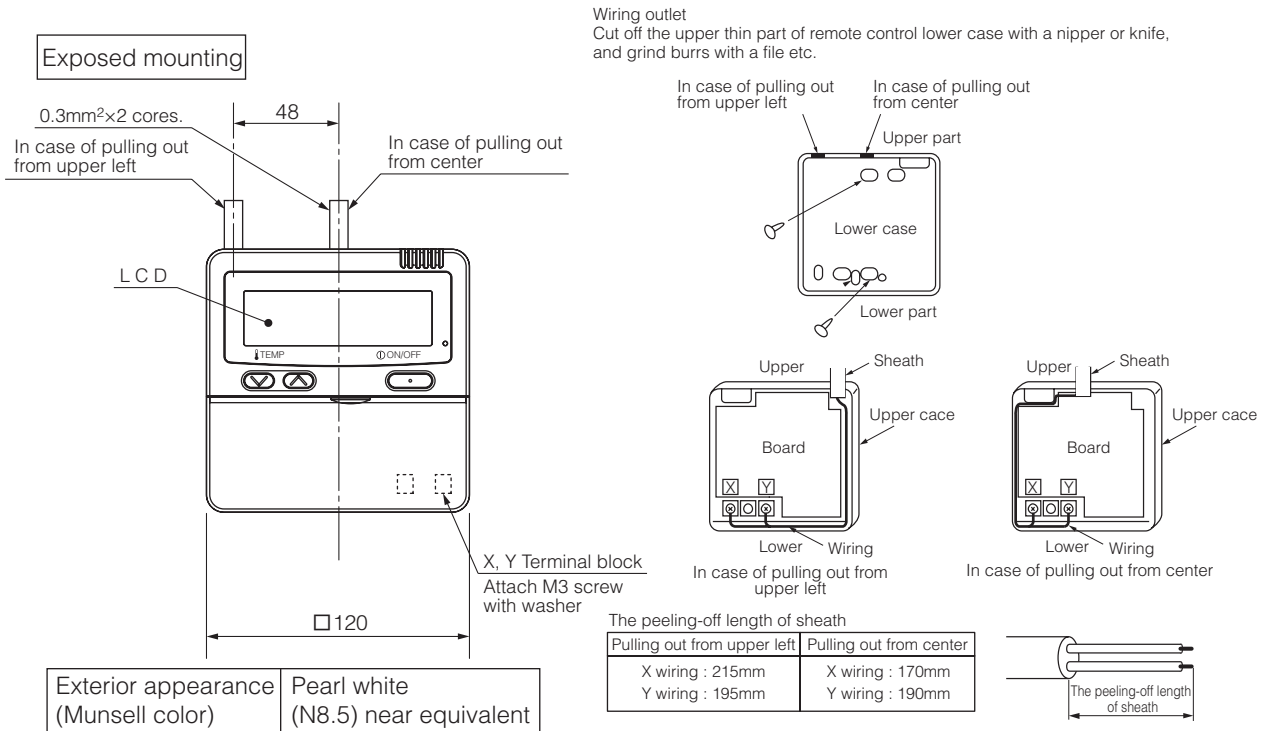

Embedded mounting

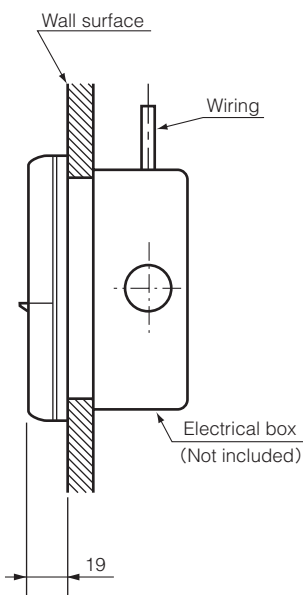

Remote control installation dimensions

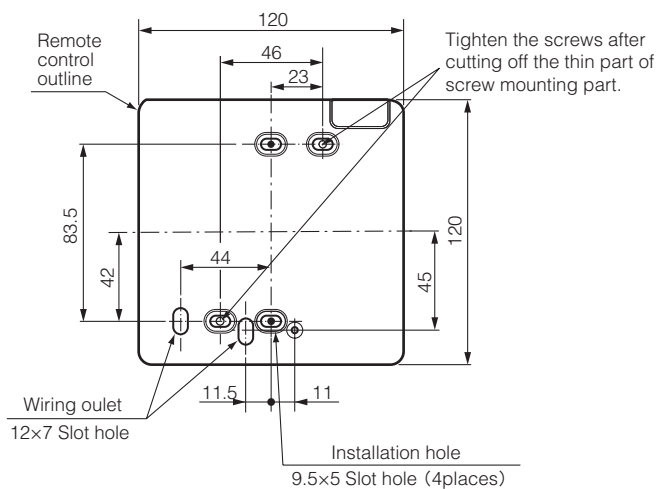

(1) Installation screw for remote control
M4 screw (2 pieces)

Unit:mm

Wiring specifications

(1) If the prolongation is over 100m, change to the size below.
But, wiring in the remote control case should be under 0.5mm². Change the wire size outside of the case according to wire connecting. Waterproof treatment is necessary at the wire connecting section. Be careful about contact failure.

Length	Wiring thickness
100 to 200m	0.5mm ² ×2 cores
Under 300m	0.75mm ² ×2 cores
Under 400m	1.25mm ² ×2 cores
Under 600m	2.0mm ² ×2 cores

PJZ000Z274

(b) Wireless remote control

RCN-E1R (Option parts) (Except SRK series)

Unit: mm

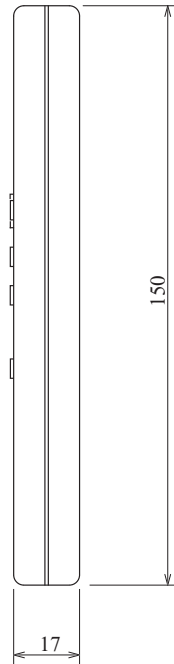
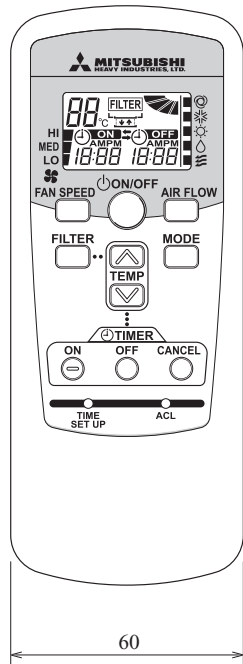

SRK series only (Standard accessory)

Unit: mm

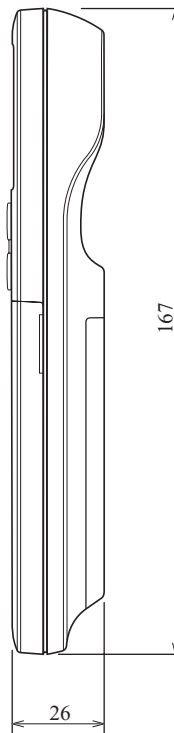
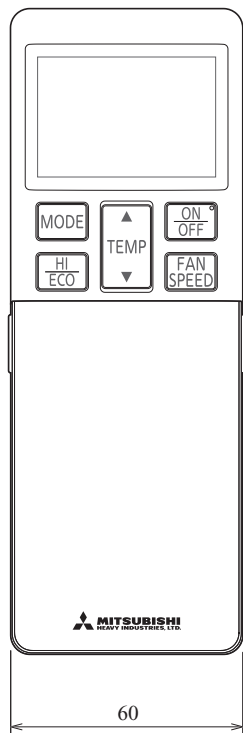

3. ELECTRICAL WIRING

(1) Indoor units

(a) Ceiling cassette-4way type (FDT)

Model FDT100VF2

Meaning of marks

CNB-Z	Connector
DM	Drain motor
F1-3	Fuse
FMI	Fan motor
FS	Float switch
L	Reactor
LED • 2	Indication lamp (Green-Normal operation)
LED • 3	Indication lamp (Red-Inspection)
LM1-4	Louver motor
PS	Panel switch
SW2	Remote control communication address
SW5	Plural units Master / Slave setting
SW6	Model capacity setting
SW7-1	Operation check, Drain motor test run
SW7-3	Powerful mode Valid / Invalid
TB1	Terminal block (Power source) (□mark)
TB2	Terminal block (Signal line) (□mark)
Thc	Thermistor (Remote control)
Thi-A	Thermistor (Return air)
Thi-R1,2,3	Thermistor (Heat exchanger)

Color marks

Mark	Color	Mark	Color
BK	Black	RD	Red
BL	Blue	WH	White
BR	Brown	YE	Yellow
OR	Orange	YE/GN	Yellow / Green

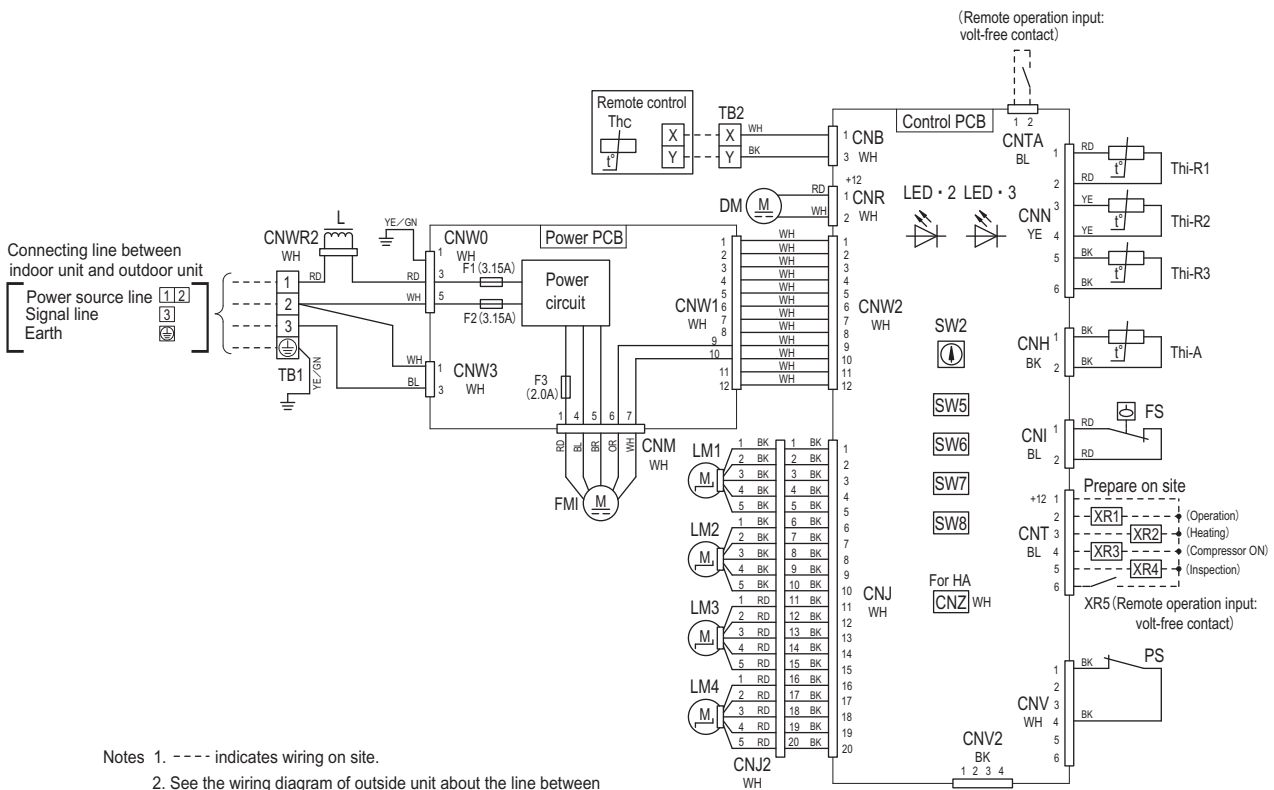

- Notes
1. ---- indicates wiring on site.
 2. See the wiring diagram of outside unit about the line between inside unit and outside unit.
 3. Use twin core cord (0.3mm² × 2) at remote control line.
 4. Do not put remote control line alongside power source line.

PJF000Z286

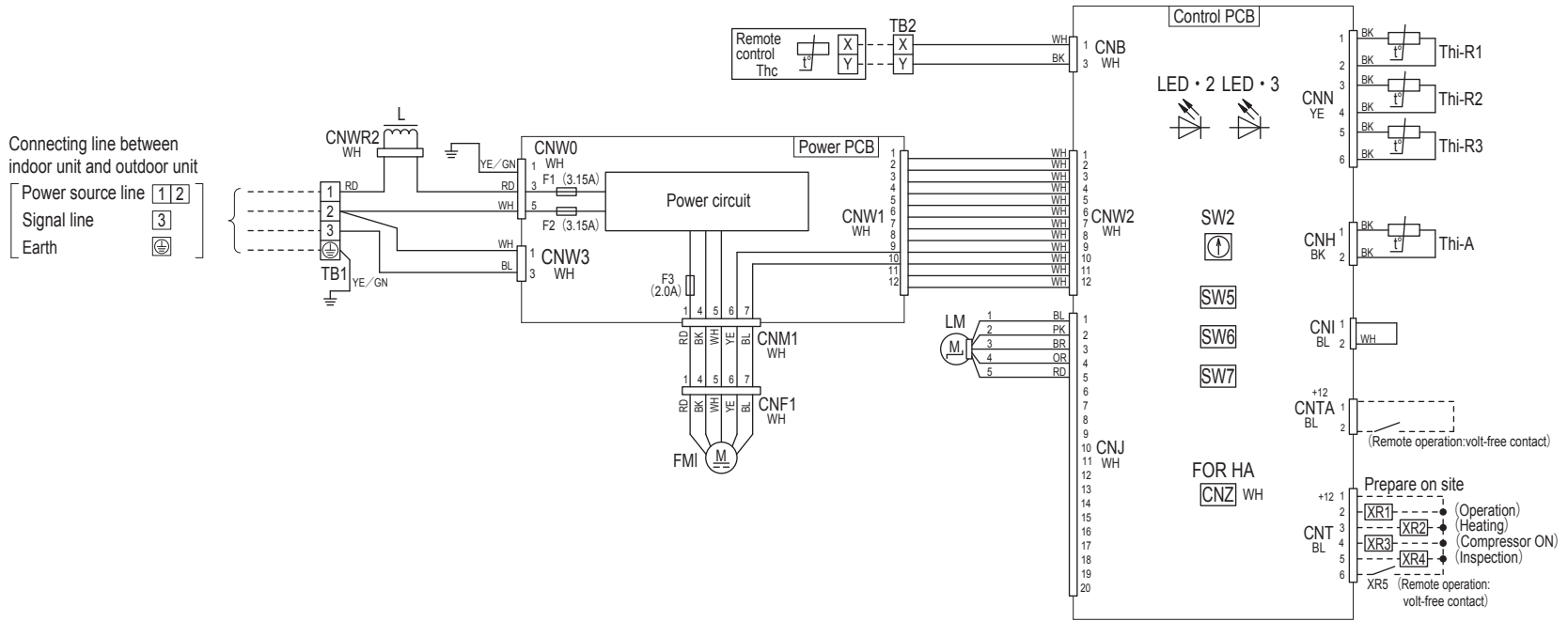

- Notes
1. --- indicates wiring on site.
 2. See the wiring diagram of outside unit about the line between indoor unit and outdoor unit.
 3. Use twin core cable (0.3mm²×2) at remote control line. See spec sheet of remote control in case that the total length is more than 100m.
 4. Do not put remote control line alongside power source line.

PFA004Z028

Meaning of marks

Mark	Parts name
CNB-Z	Connector
F1-3	Fuse (Power PCB)
FMI	Fan motor
LED • 2	Indication lamp (Green-Normal operation)
LED • 3	Indication lamp (Red-Inspection)
LM	Louver motor
SW2	Remote control communication address
SW5	Plural units Master / Slave setting
SW6	Model capacity setting
SW7-1	Operation check, drain motor test run
SW7-3	Powerful mode Valid / Invalid
TB1	Terminal block (Power source)
TB2	Terminal block (Signal line)
Thc	Thermistor (Remote control)
Thi-A	Thermistor (Return air)
Thi-R1,2,3	Thermistor (Heat exchanger)

Color marks

Mark	Color
BK	Black
BL	Blue
BR	Brown
OR	Orange
PK	Pink
RD	Red
WH	White
YE	Yellow
YE/GN	Yellow / Green

(b) Ceiling suspended type (FDE)
Model FDE100VG

(c) Duct connected-High static pressure type (FDU)
Model FDU100VF2

Meaning of marks

CNB-Z	Connector
DM	Drain motor
F1,3,4	Fuse
FM1,2	Fan motor (with thermostat)
FS	Float switch
L	Reactor
LED · 2	Indication lamp (Green-Normal operation)
LED · 3	Indication lamp (Red-Inspection)
SW2	Remote control communication address
SW5	Plural units Master/Slave setting
SW6	Model capacity setting
SW7-1	Operation check, Drain motor test run
SW7-3	Powerful mode Valid/Invalid
TB1	Terminal block (Power source) (□mark)
TB2	Terminal block (Signal line) (□mark)
Thc	Thermistor (Remote control)
Thi-A	Thermistor (Return air)
Thi-R1,2,3	Thermistor (Heat exchanger)

Color marks

Mark	Color	Mark	Color
BK	Black	RD	Red
BL	Blue	WH	White
YE	Yellow	YE/GN	Yellow/Green

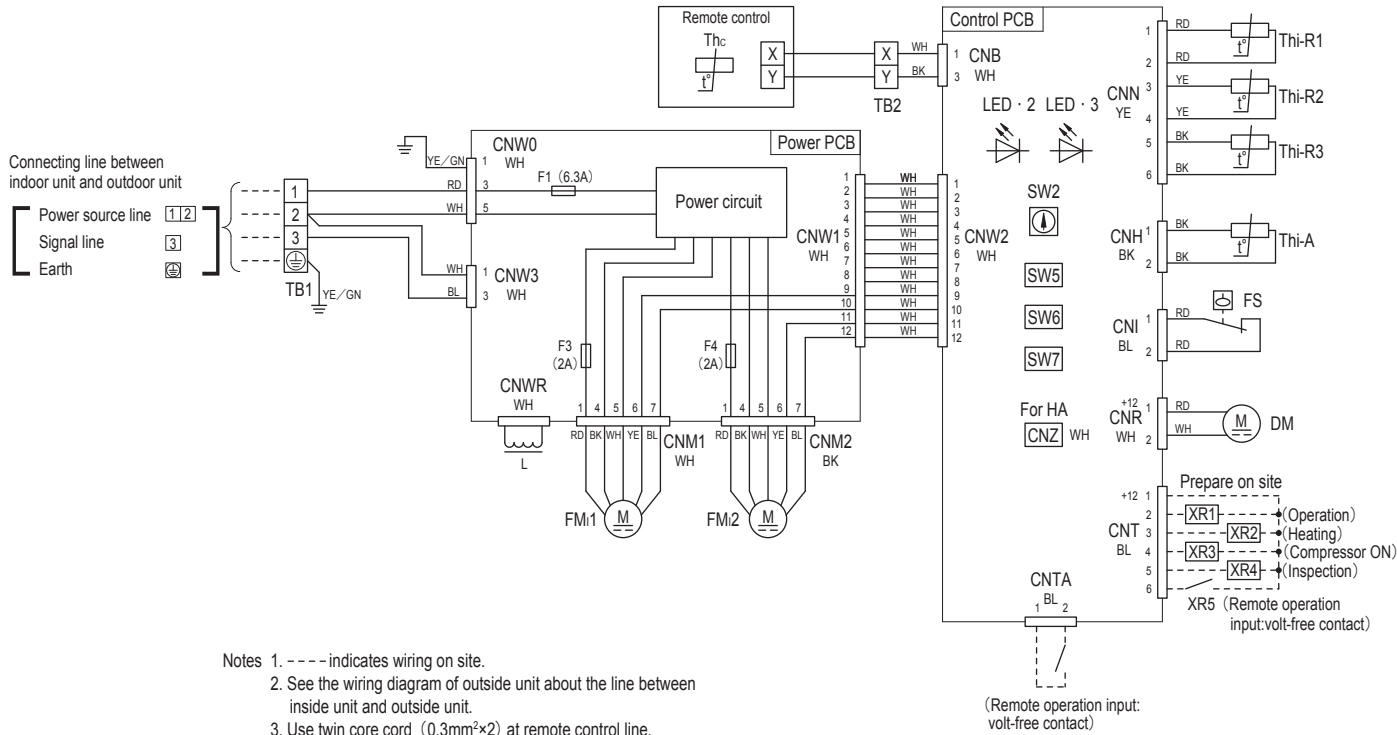

- Notes
1. ---- indicates wiring on site.
 2. See the wiring diagram of outside unit about the line between inside unit and outside unit.
 3. Use twin core cord (0.3mm²×2) at remote control line.
 4. Do not put remote control line alongside power source line.

PJG000Z050

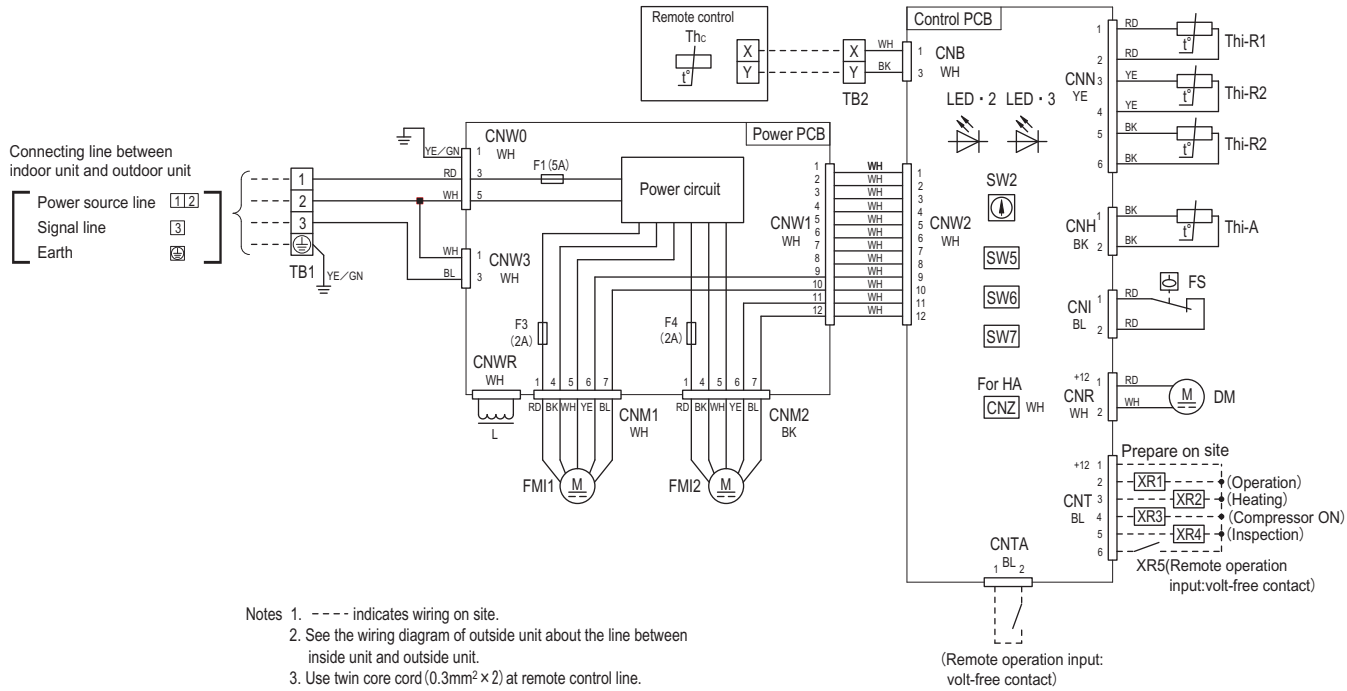

Meaning of marks

CNB-Z	Connector
DM	Drain motor
F1,3,4	Fuse
FM1,2	Fan motor (with thermostat)
FS	Float switch
L	Reactor
LED · 2	Indication lamp (Green-Normal operation)
LED · 3	Indication lamp (Red-Inspection)
SW2	Remote control communication address
SW5	Plural units Master/Slave setting
SW6	Model capacity setting
SW7-1	Operation check, Drain motor test run
SW7-3	Powerful mode Valid/Invalid
TB1	Terminal block (Power source) (□mark)
TB2	Terminal block (Signal line) (□mark)
Thc	Thermistor (Remote control)
Thi-A	Thermistor (Return air)
Thi-R1,2,3	Thermistor (Heat exchanger)
■mark	Closed-end connector

Color marks

Mark	Color	Mark	Color
BK	Black	RD	Red
BL	Blue	WH	White
BR	Brown	YE	Yellow
OR	Orange	YE/GN	Yellow/Green

(d) Duct connected-Low / Middle static pressure type (FDUM)
Model FDUM100VF2

Color marks

Mark	Color	Mark	Color	Mark	Color
BK	Black	GR	Gray	WH	White
BL	Blue	OR	Orange	YE	Yellow
BR	Brown	RD	Red	YE/GN	Yellow/Green

Meaning of marks

CNB-Z	Connector
F200-203	Fuse
FMI	Fan motor
L	Reactor
LED · 2	Indication lamp (Green-Normal operation)
LED · 3	Indication lamp (Red-Inspection)
LM	Louver motor
SW2	Remote control communication address

SW5	Plural units Master/Slave setting
SW6	Model capacity setting
SW7- 1	Operation check, Drain motor test run
TB1	Terminal block (Power source) (□ mark)
TB2	Terminal block (Signal line) (□ mark)
Thc	Thermistor (Remote control)
Thi-A	Thermistor (Return air)
Thi-R1,2,3	Thermistor (Heat exchanger)
X4	Relay for DM

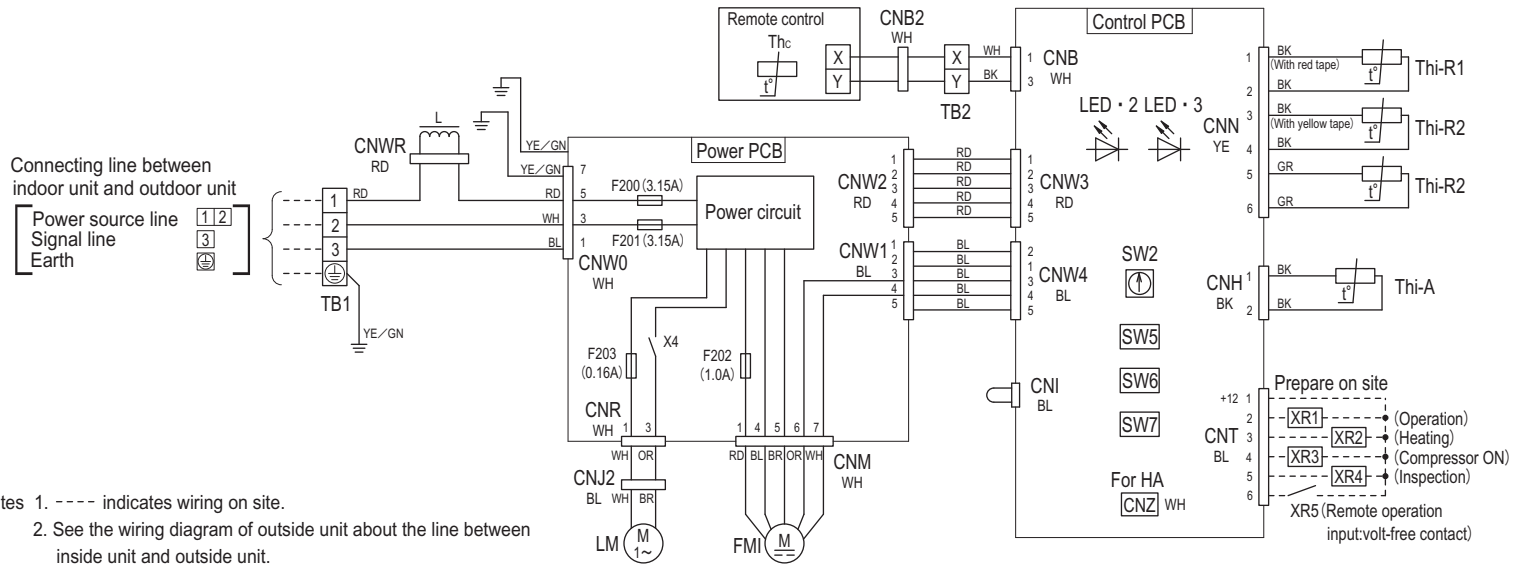

RWA000Z406

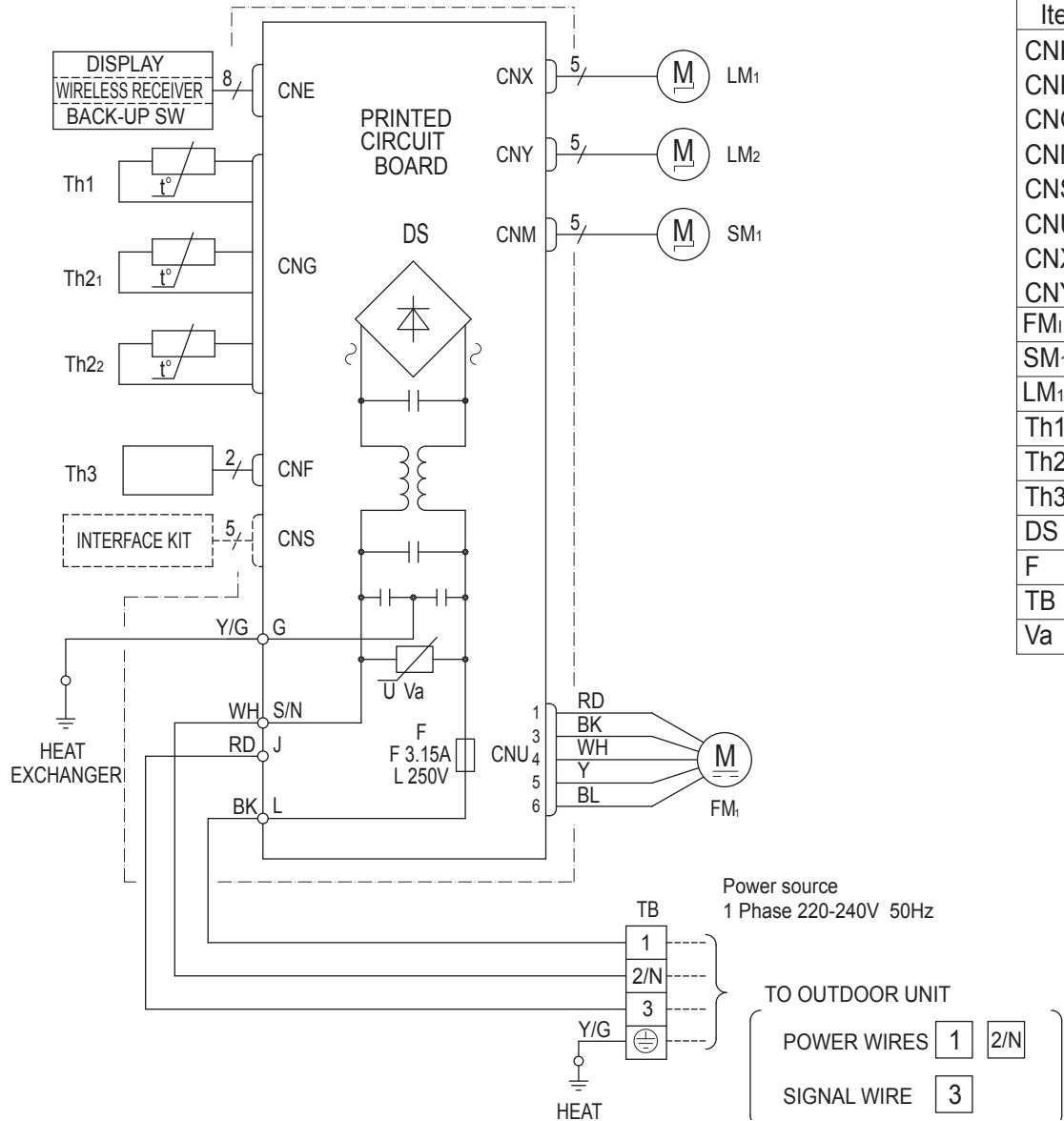

Meaning of marks

Item	Description
CNE	Connector
CNF	
CNG	
CNM	
CNS	
CNU	
CNX	
CNY	
FM _i	Fan motor
SM ₁	Flap motor
LM _{1,2}	Louver motor
Th1	Room temp. sensor
Th2,1,2	Heat exchanger sensor
Th3	Humidity sensor
DS	Diode stack
F	Fuse
TB	Terminal block
Va	Varistor

Color marks

Mark	Color
BK	Black
BL	Blue
RD	Red
WH	White
Y	Yellow
Y/G	Yellow/Green

(f) Wall mounted type (SRK)
Model SRK100ZR-S

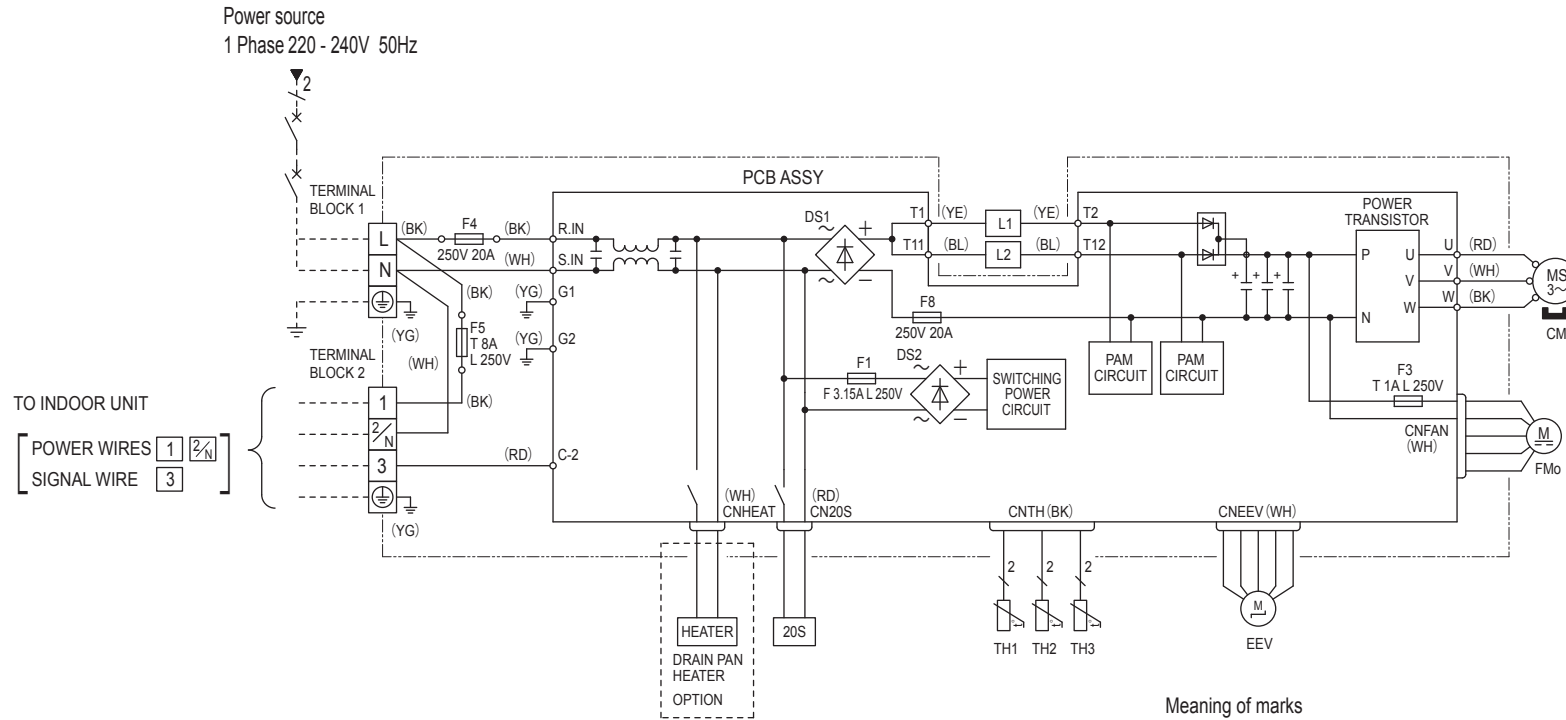

Power cable, indoor-outdoor connecting wires

MODEL NAME	MAX running current (A)	Power cable size (mm ²)	Power cable length (m)	indoor-outdoor wire size x number (mm)	Earth wire size (mm)
FDC100VNP	21	5.5	25	φ 1.6 × 3	φ 1.6

※At the connection with the duct type indoor unit

MODEL NAME	MAX running current (A)	Power cable size (mm ²)	Power cable length (m)	indoor-outdoor wire size x number (mm)	Earth wire size (mm)
FDC100VNP	22	5.5	24	φ 1.6 × 3	φ 1.6

- The specifications shown in the above table are for units without heaters. For units with heaters, refer to the installation instructions or the construction instructions of the indoor unit.
- Switchgear of circuit breaker capacity which is calculated from MAX. over current should be chosen along the regulations in each country.
- The cable specifications are based on the assumption that a metal or plastic conduit is used with no more than three cables contained in a conduit and a voltage drop is 2%. For an installation falling outside of these conditions, please follow the internal cabling regulations. Adapt it to the regulation in effect in each country.

Color marks

Mark	Color
BK	Black
BL	Blue
RD	Red
WH	White
YE	Yellow
YG	Yellow / Green

Meaning of marks

Item	Description
20S	Solenoid coil for 4 way valve
CN20S	Connector
CNEEV	
CNFAN	
CNHEAT	
CNTH	
CM	Compressor motor
DS1,2	Diode stack
EEV	Electric expansion valve (coil)
FMo	Fan motor
L1,2	Reactor
TH1	Heat exchanger sensor
TH2	Outdoor air temp. sensor
TH3	Discharge pipe temp. sensor
J2	Jumper (※)

Note(1) ※ By cutting J2, the operation of cooling start in heating mode is disablement.

4. NOISE LEVEL

Notes (1) The data are based on the following conditions.

Ambient air temperature: Indoor unit 27°CWB. Outdoor unit 35°CDB.

(2) The data in the chart are measured in an anechoic room.

(3) The noise levels measured in the field are usually higher than the data because of reflection.

(1) Indoor units

(a) Ceiling cassette-4way type (FDT)

Model FDT100VF2

Noise level 51 dB (A) at P-Hi
40 dB (A) at Hi
37 dB (A) at Me
35 dB (A) at Lo

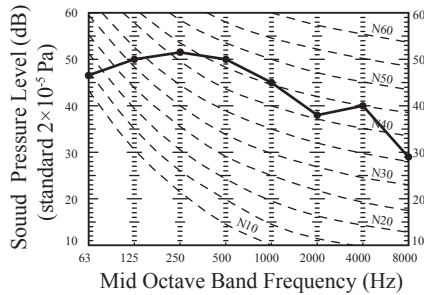

Measured based on JIS B 8616

● Mike position

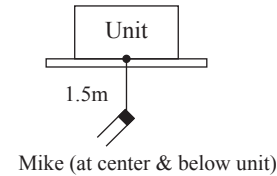

(b) Ceiling suspended type (FDE)

Model FDE100VG

Noise level 48 dB (A) at P-Hi
43 dB (A) at Hi
38 dB (A) at Me
34 dB (A) at Lo

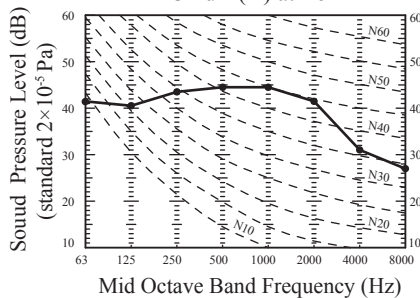

Measured based on JIS B 8616

● Mike position

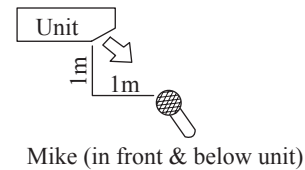

(c) Duct connected-High static pressure-type (FDU)

Model FDU100VF2

Noise level 44 dB (A) at P-Hi
38 dB (A) at Hi
36 dB (A) at Me
30 dB (A) at Lo

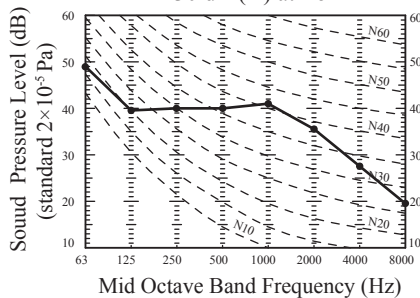

Measured based on JIS B 8616

● Mike position

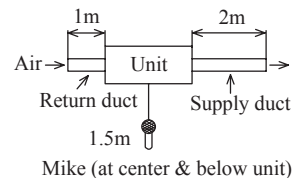

(c) Duct connected-Low / Middle static pressure type (FDUM)

Model FDUM100VF2

Noise level 44 dB (A) at P-Hi
 38 dB (A) at Hi
 36 dB (A) at Me
 30 dB (A) at Lo

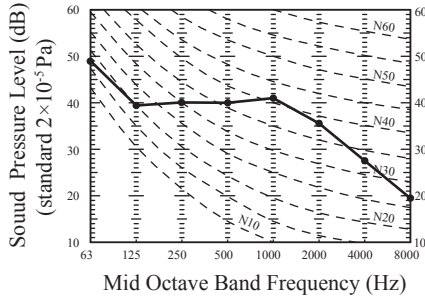

Measured based on JIS B 8616

● Mike position

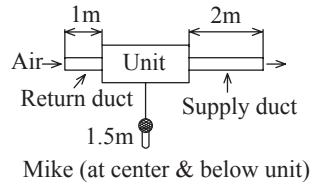

(d) Floor standing type (FDF)

Model FDF100VD2

Noise level 54 dB (A) at P-Hi
 50 dB (A) at Hi
 48 dB (A) at Me
 44 dB (A) at Lo

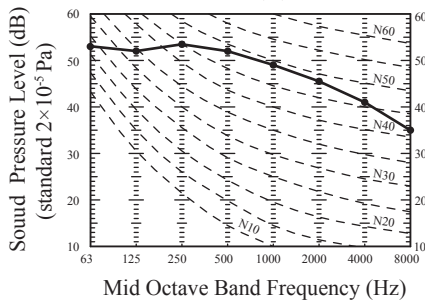

Measured based on JIS B 8616

● Mike position

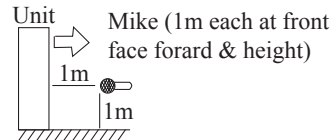

(e) Wall mounted type (SRK)

Model SRK100ZR-S

Cooling noise level 48 dB (A) at Hi
 Heating noise level 48 dB (A) at Hi

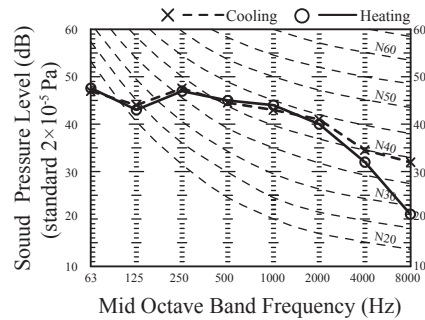

Unit

Measured based on JIS C 9612

● Mike position

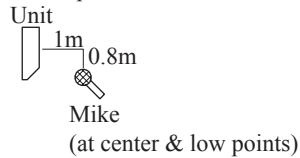

(2) Outdoor unit

Measured based on ISO-T1, JIS B 8616

Mike position: at highest noise level in position as mentined below

Distance from front side 1m

Height 1m

Model FDC100VNP

■ **Sound pressure level**

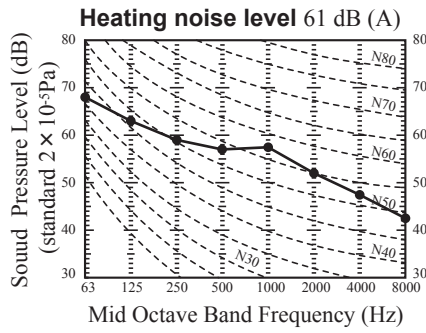
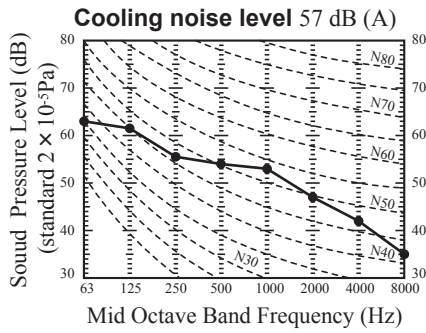

■ **Sound power level**

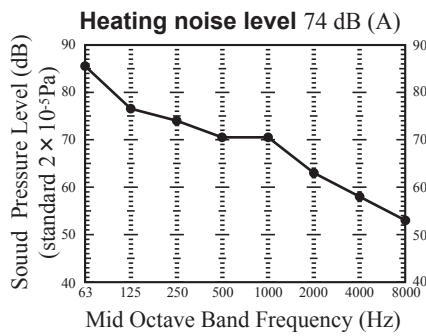
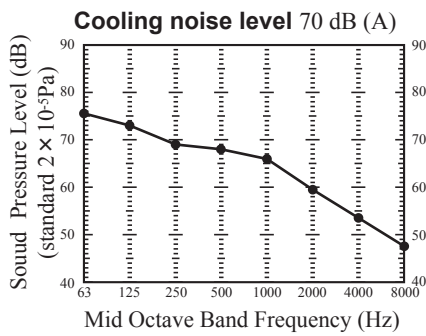

5. CHARACTERISTICS OF FAN

(1) Duct connected-High static pressure type (FDU)

- Characteristic FAN (1) shows air flow vs. External Static Pressure (E.S.P.) range where settings of E.S.P. are maximum E.S.P. (SW8-4 OFF : 150Pa, SW8-4 ON : 200Pa), rated E.S.P., and minimum E.S.P. (SW8-4 OFF : 80Pa, SW8-4 ON : 10Pa)
- Characteristic FAN (2) shows air flow vs.E.S.P. curve when set fan tap is set P-Hi with each setting of E.S.P. by remote control.
- External Static Pressure (E.S.P.) can be set by wired remote control.
- You can set required E.S.P. by wired remote control which calculate it with the set air flow rate and pressure loss of the duct connected.

Model FDU100VF2

■SW8-4 : OFF (Range of use limitation : Setting 80Pa-150Pa)

Characteristic FAN (1)

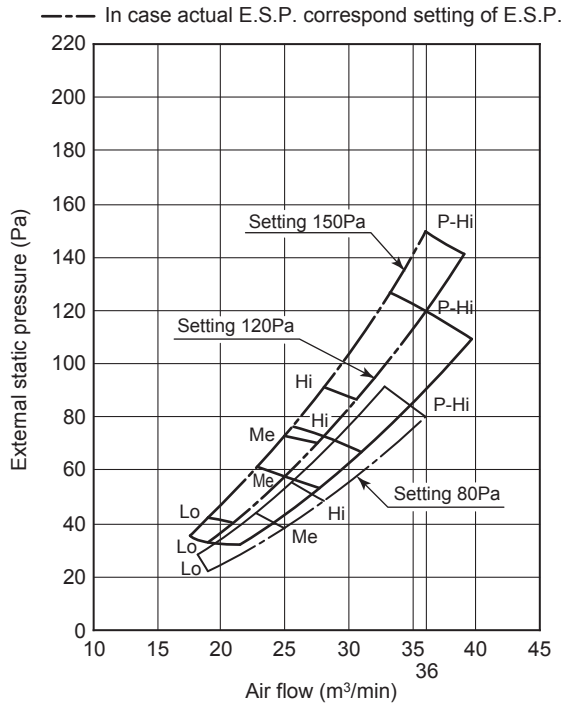

Characteristic FAN (2)

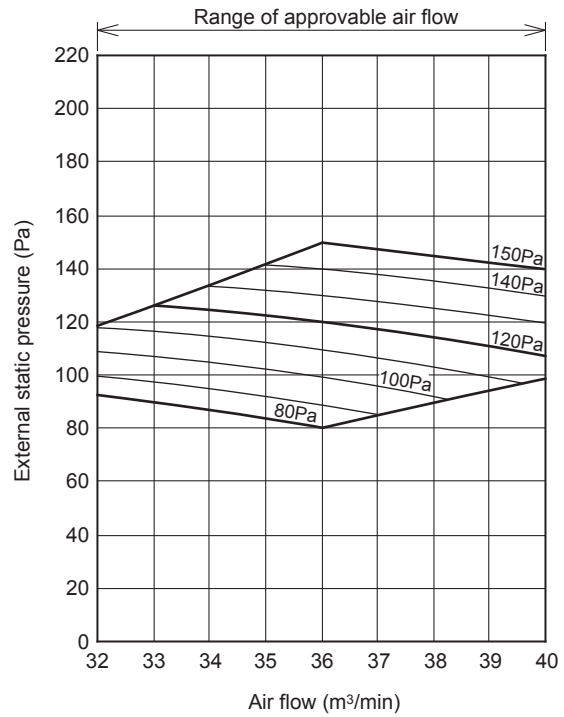

■SW8-4 : ON (Range of use limitation : Setting 10Pa-200Pa)

Characteristic FAN (1)

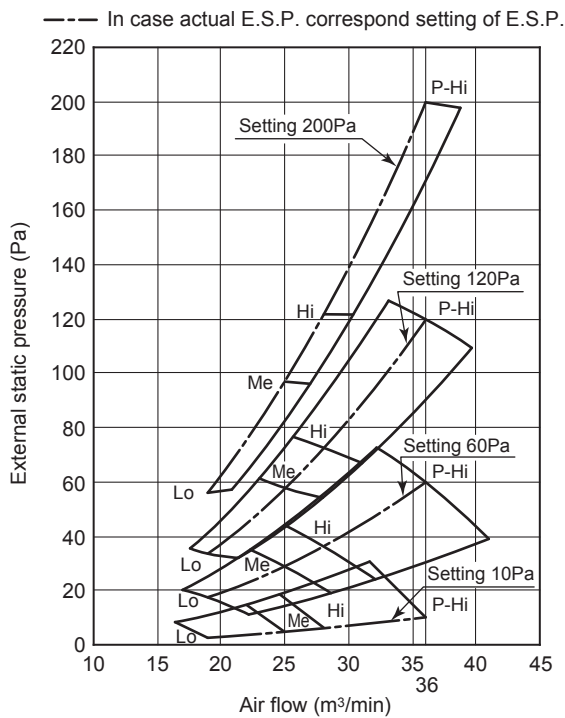

Characteristic FAN (2)

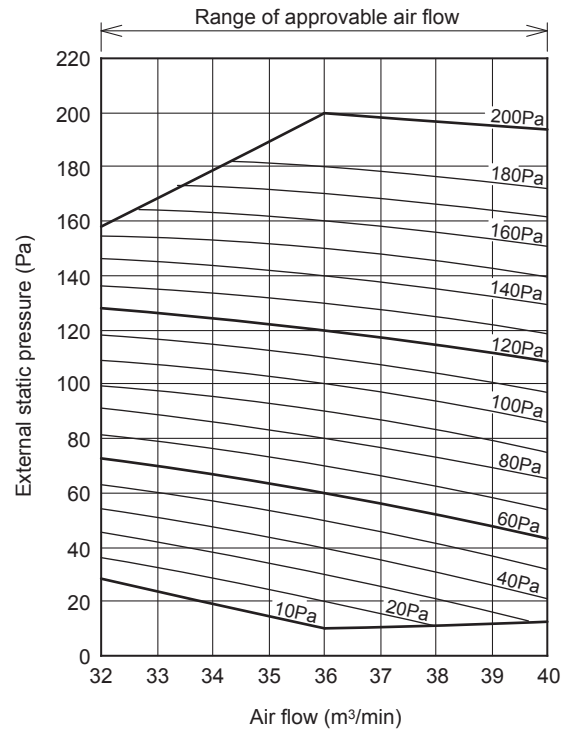

(2) Duct connected-Low / Middle static pressure type (FDUM)

- Characteristic FAN (1) shows air flow vs. External Static Pressure (E.S.P.) range where settings of E.S.P. are maximum E.S.P. (100Pa), rated E.S.P., and minimum E.S.P. (10Pa)
- Characteristic FAN (2) shows air flow vs. E.S.P curve when set fan tap is set P-Hi with each setting of E.S.P. by remote control.
- External Static Pressure (E.S.P.) can be set by wired remote control.
- You can set required E.S.P. by wired remote control which calculate it with the set air flow rate and pressure loss of the duct connected.

Model FDUM100VF2

Characteristic FAN(1)

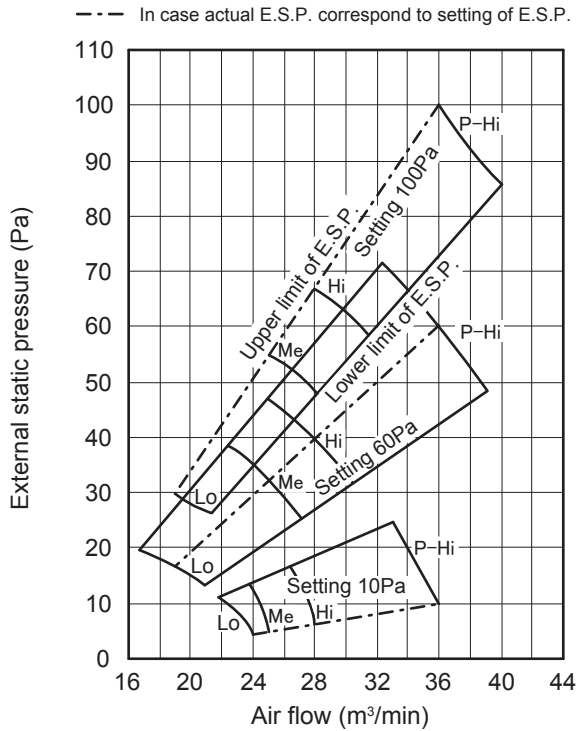

Characteristic FAN(2)

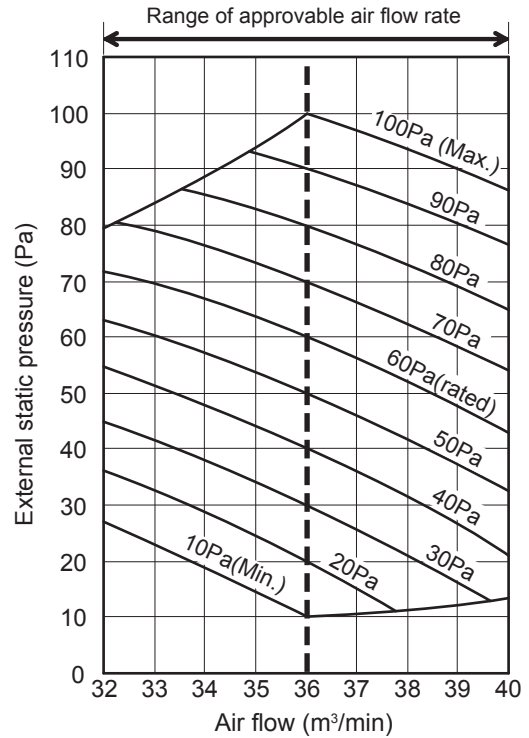

6. TEMPERATURE AND VELOCITY DISTRIBUTION

Indoor temperature

Cooling 27°CDB / 19°CWB

Heating 20°CDB

Note: These figures represent the typical main range of temperature and velocity distribution at the center of air outlet within the published conditions.

In the actual installation, they may differ from the typical figures under the influence of air temperature conditions, ceiling height, operation conditions and obstacles.

(1) Ceiling cassette-4way type (FDT)

Model FDT100VF2

Cooling Air flow : P-Hi

Louver position

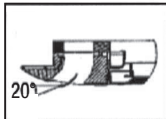

Temperature distribution

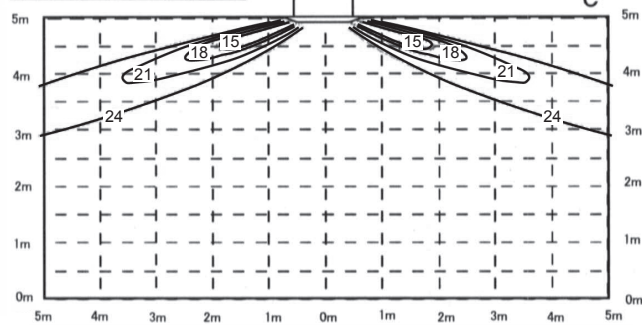

Velocity distribution

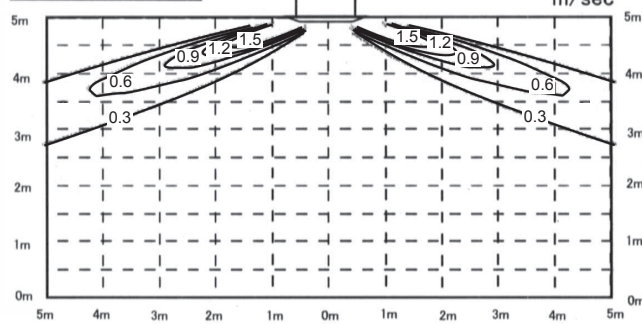

Heating Air flow : P-Hi

Louver position

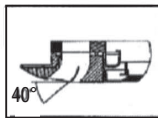

Temperature distribution

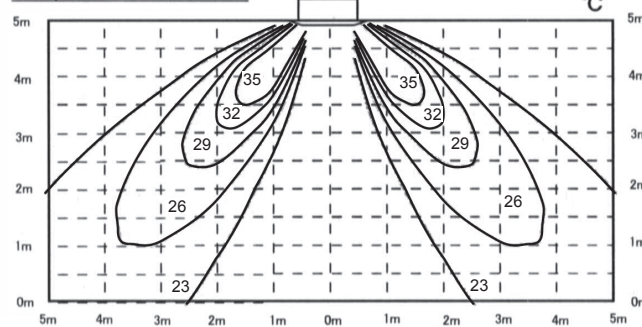

Velocity distribution

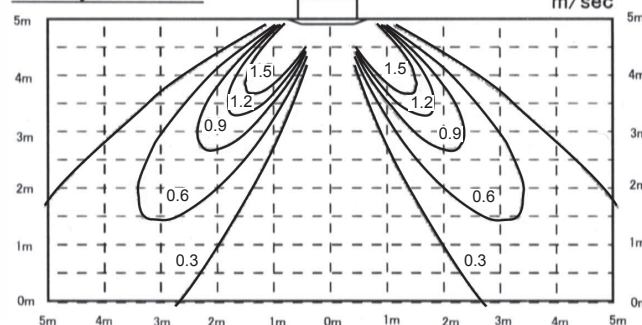

**(2) Ceiling suspended type (FDE)
Model FDE100VG**

Cooling Air flow: P-Hi

Louver position

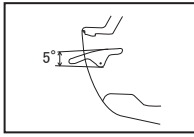

Temperature distribution

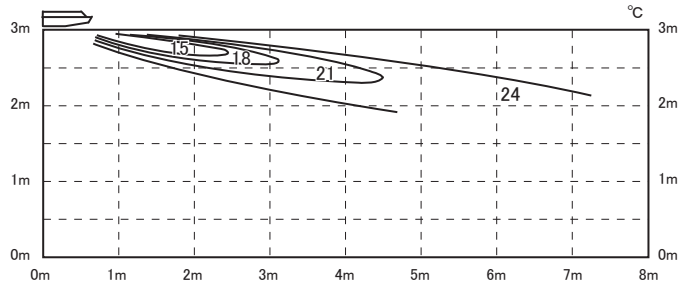

Velocity distribution

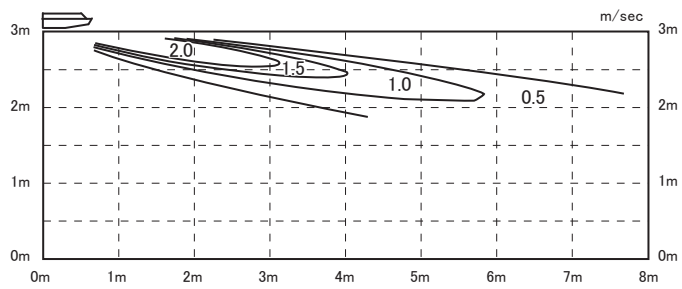

Heating Air flow: P-Hi

Louver position

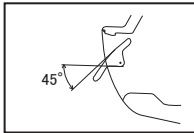

Temperature distribution

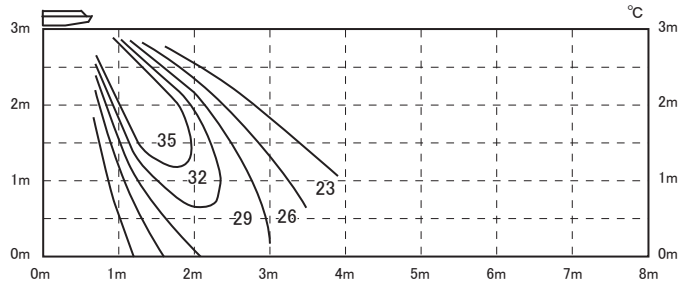

Velocity distribution

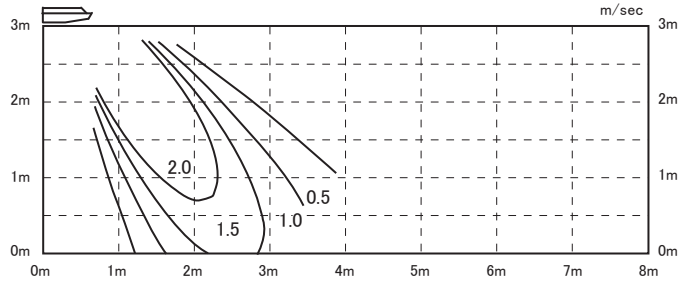

(3) Floor standing type (FDF)
Model FDF100VD2
Cooling Air flow:Hi (Louver position:Horizontal)

Temperature distribution

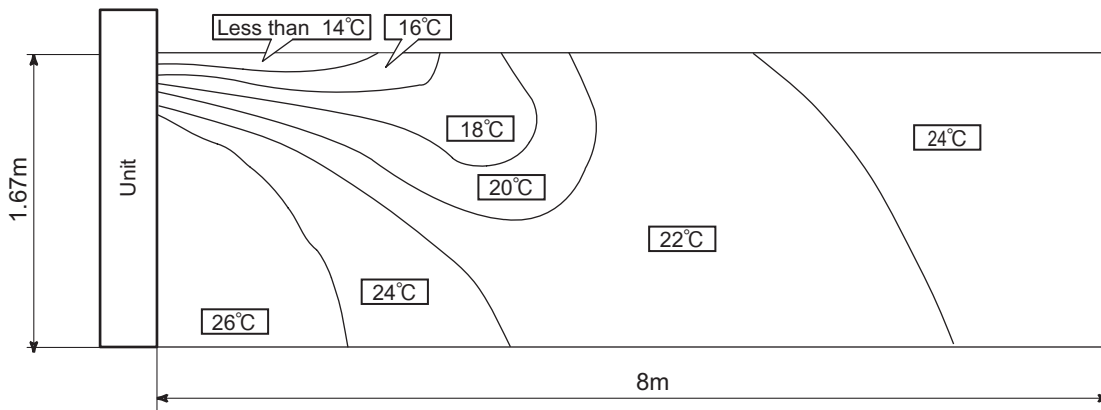

Heating Air flow:Hi (Louver position:Horizontal)

Temperature distribution

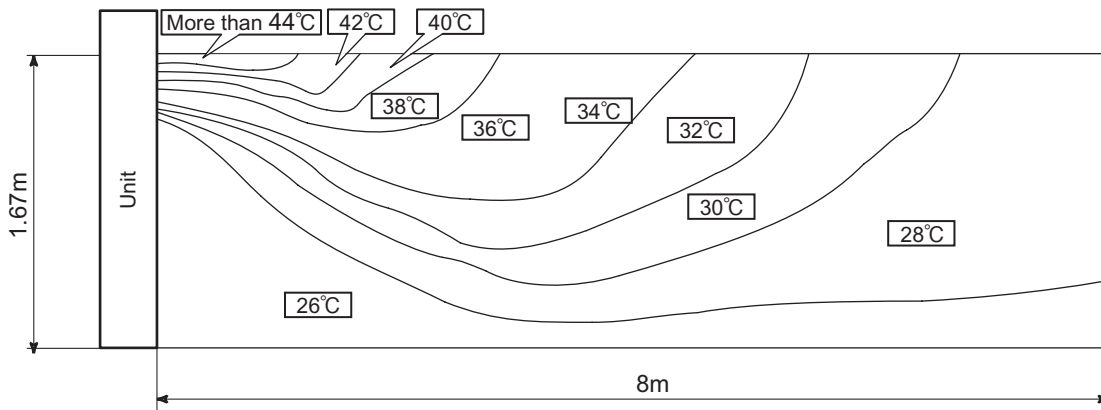

7. PIPING SYSTEM

(1) FDT, FDE, FDU, FDUM, FDF series

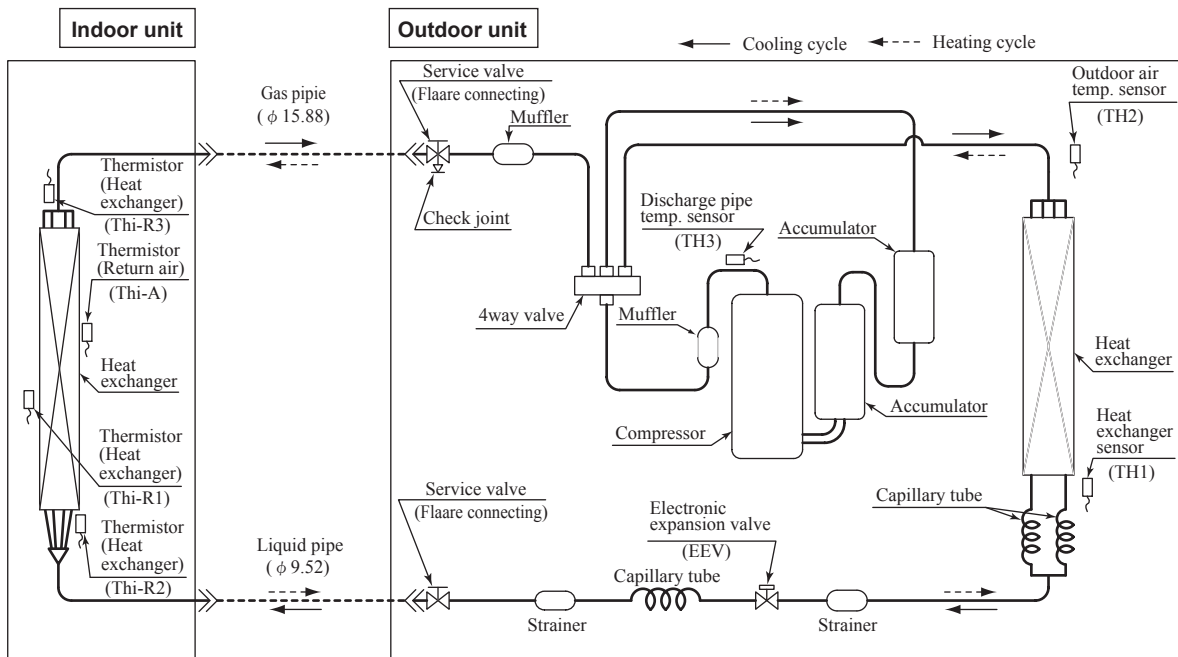

(2) SRK series

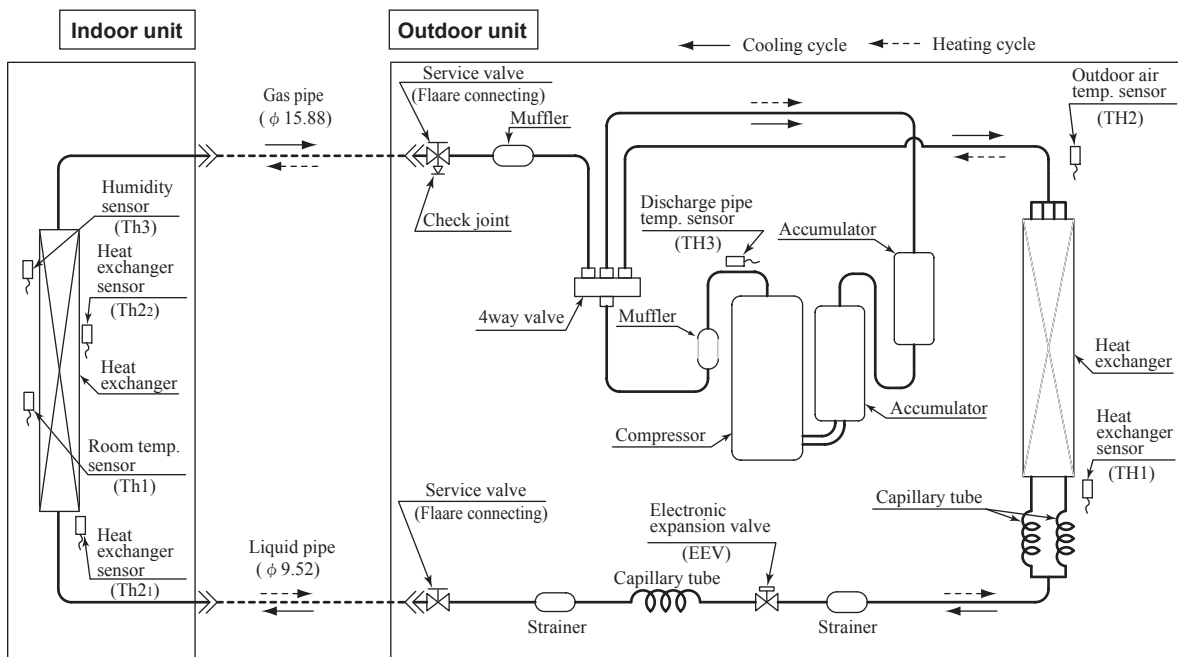

Preset point of the protective devices

Parts name	Mark	Equipped unit	All models
Thermistor (for protection overloading in heating)	Thi-R (Th2)	Indoor unit	OFF 63(17)°C , ON 56(16)°C
Thermistor (for frost prevention)			OFF 1.0(2.5)°C , ON 10(8)°C
Thermistor (for protection high pressure in cooling)	TH1	Outdoor unit	OFF 63°C , ON 53°C
Thermistor (for detecting discharge pipe temperature)	TH3		OFF 115°C , ON 95°C

Note(1) Values in () are for the SRK series.

8. RANGE OF USAGE & LIMITATIONS

Operating temperature range		See next page.
		When used below -5°C, install a snow hood (prepared on site).
Recommendable area to install		Considering to get sufficient heating capacity, the area where the averaged lowest ambient air temperature in day time during winter is above 0°C, and it has no accumulation of snow.
Installation site		The limitations of installation space are shown in the page for exterior dimensions. Install the indoor unit at least 2.5m higher than the floor surface.
Temperature and humidity conditions surrounding the indoor unit (Note 2)		Model FDE, FDF, SRK : Dew point temperature : 23°C or less, relative humidity : 80% or less Other models : Dew point temperature : 28°C or less, relative humidity : 80% or less
Limitations on unit and piping installation		See page 40
Compressor ON-OFF cycling	Cycle time	10 minutes or more (from OFF to OFF) or (from ON to ON)
	Stop time	3 minutes or more
Power source	Voltage range	Rating ±10%
	Voltage drop at start-up	Min.85% of rating
	Phase-to-phase imbalance	3% or less

Note 1. Do not install the unit in places which :

- 1) Flammable gas may leak.
- 2) Carbon fiber, metal particles, powder, etc. are floating.
- 3) Cosmetic or special sprays are used frequently.
- 4) Exposed to oil splashes or steam (e.g. kitchen and machine plant).
- 5) Exposed to sea breeze (e.g. coastal area) or calcium chloride (e.g. snow melting agent).
- 6) Exposed to ammonia substance (e.g. organic fertilizer).
- 7) Matters affecting devices, such as sulfuric gas, chlorine gas, acid, alkali, etc. may generate or accumulate.
- 8) Chimney smoke is hanging.
- 9) Sucking the exhaust gas from heat exchanger.
- 10) Adjacent to equipment generating electromagnetic waves or high frequency waves.
- 11) There is light beams that affect the receiving device of indoor unit in case of the wireless specification.
- 12) Snow falls heavily.
- 13) At an elevation of 1000 meters or higher.
- 14) On mobile machine (e.g. vehicle, ship, etc.)
- 15) Splashed with water to indoor unit (e.g. laundry room).

Note 2. If ambient temperature and humidity exceed the above conditions, add polyurethane foam insulation on the outer plate (10mm or thicker) of indoor unit.

Note 3. Both gas and liquid pipes need to be covered with 20mm or thicker heat insulation materials at the place where relative humidity exceeds 70%.

PJF000Z317

Operating temperature range

■ Cooling

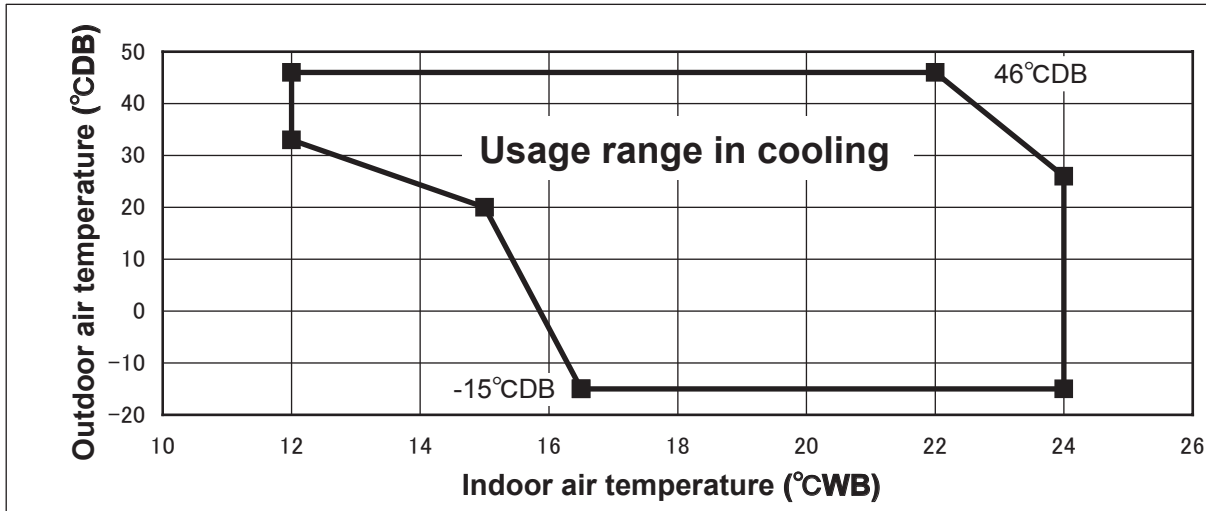

■ Heating

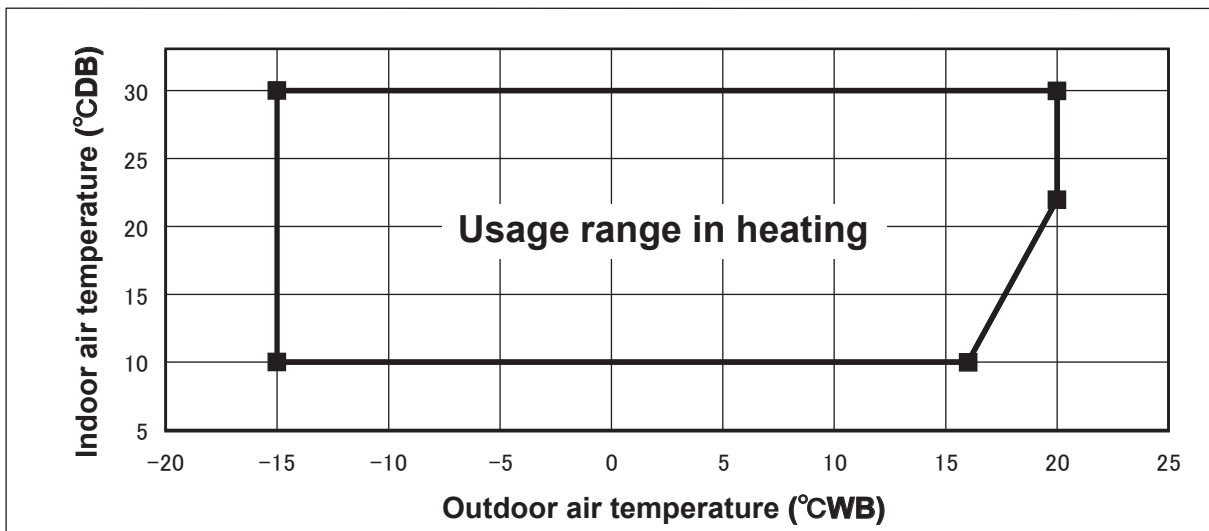

Decline in cooling and heating capacity or operation stop may occur when the outdoor unit is installed in places where natural wind can increase or decrease its design airflow rate.

PJF000Z317

“CAUTION” Cooling operation under low outdoor air temperature conditions

PAC models can be operated in cooling mode at low outdoor air temperature condition within above temperature range. However in case of severely low temperature conditions if the following precaution is not observed, it may not be operated in spite of operable temperature range mentioned above and cooling capacity may not be established under certain conditions.

[Precaution]

In case of severely low temperature condition

- 1) Install the outdoor unit at the place where strong wind cannot blow directly into the outdoor unit.
- 2) If there is no installation place where can prevent strong wind from directly blowing into the outdoor unit, mount the flex flow adapter (prepared as option part) or like such devices onto the outdoor unit in order to divert the strong wind.

[Reason]

Under the low outdoor air temperature conditions of -5°C or lower, the outdoor fan is controlled at lower or lowest speed by outdoor fan control, but if strong wind directly blow into the outdoor unit, the outdoor heat exchanger temperature will drop more. This makes high and low pressures to drop as well. This low pressure drop makes the indoor heat exchanger temperature to drop and will activate anti-frost control at indoor heat exchanger at frequent intervals, that cooling operation may not be established for any given time.

Limitation on unit and piping installation				
Descriptions		Model for outdoor unit	Dimensional limitations	Marks appearing in the drawing
One-way pipe length		FDC100VNP	$\leq 30\text{m}$	L
Elevation difference between indoor and outdoor unit	When the outdoor unit is positioned higher		$\leq 20\text{m}$	H
	When the outdoor unit is positioned lower		$\leq 20\text{m}$	

PJF000Z317

9. SELECTION CHART

Correct the cooling and heating capacity in accordance with the operating conditions. The net cooling and heating capacity can be obtained in the following way.

Net capacity = Capacity shown in the capacity tables (9.1) × Correction factors shown in the table (9.2) (9.3) (9.4).

Caution: In case that the cooling operation during low outdoor air temperature below -5°C is expected, install the outdoor unit where it is not influenced by natural wind. Otherwise protection control by low pressure will be activated much more frequently and it will cause insufficient capacity or breakdown of the compressor in worst case.

9.1 Capacity tables

(1) Ceiling cassette-4way type (FDT)

Model **FDT100VNP1VF2** Indoor unit **FD100VF2** Outdoor unit **FDC100VNP**

Cooling mode

(kW)

Heating mode : HC

(kW)

Outdoor air temperature °CDB	Indoor air temperature															
	18°CDB		21°CDB		23°CDB		26°CDB		27°CDB		28°CDB		31°CDB		33°CDB	
	12°CWB	14°CWB	16°CWB	18°CWB	19°CWB	20°CWB	22°CWB	24°CWB	TC	SHC	TC	SHC	TC	SHC	TC	SHC
11			9.71	8.44	10.21	8.98	10.46	8.88	10.66	8.76	11.06	9.23	11.46	8.97		
13			9.71	8.44	10.21	8.98	10.46	8.88	10.66	8.76	11.06	9.23	11.46	8.97		
15			9.71	8.44	10.21	8.98	10.46	8.88	10.66	8.76	11.06	9.23	11.46	8.97		
17			9.71	8.44	10.21	8.98	10.46	8.88	10.66	8.76	11.06	9.23	11.46	8.97		
19			9.65	8.42	10.18	8.97	10.45	8.88	10.66	8.76	11.08	9.23	11.51	8.98		
21			9.59	8.39	10.16	8.96	10.44	8.88	10.67	8.76	11.11	9.24	11.56	8.99		
23			9.60	8.40	10.17	8.97	10.46	8.88	10.69	8.77	11.14	9.25	11.60	9.00		
25		9.03	8.53	9.60	8.40	10.19	8.97	10.48	8.89	10.71	8.78	11.17	9.26	11.63	9.01	
27		9.02	8.53	9.61	8.40	10.20	8.98	10.51	8.90	10.81	8.80	11.41	9.32			
29		8.92	8.48	9.49	8.36	10.08	8.94	10.38	8.85	10.68	8.77	11.28	9.29			
31		8.81	8.44	9.38	8.32	9.96	8.90	10.25	8.81	10.55	8.73	11.14	9.25			
33	8.24	7.79	8.61	8.36	9.26	8.27	9.83	8.86	10.13	8.77	10.42	8.69	11.01	9.21		
35	8.08	7.72	8.47	8.30	9.14	8.23	9.71	8.81	10.00	8.73	10.29	8.65	10.87	9.17		
37	7.85	7.62	8.23	8.06	8.84	8.12	9.37	8.70	9.67	8.63	9.96	8.55	10.54	9.09		
39	7.62	7.47	7.98	7.82	8.54	8.01	9.03	8.59	9.33	8.52	9.62	8.45	10.21	9.00		
41	7.39	7.25	7.74	7.58	8.24	7.90	8.70	8.48	8.99	8.42	9.29	8.35	9.89	8.91		
43	7.16	7.02	7.10	6.96	7.54	7.39	7.93	7.77	8.66	8.31	8.47	8.11	9.00	8.68		

Outdoor air temperature °CDB	°CWB	Indoor air temperature °CDB				
		16	18	20	22	24
-14.5	-15	6.20	6.18	6.16	6.14	6.11
-13.5	-14	6.26	6.23	6.21	6.19	6.16
-11.5	-12	6.36	6.34	6.31	6.29	6.26
-9.5	-10	6.47	6.44	6.42	6.39	6.36
-7.5	-8	6.58	6.55	6.52	6.49	6.46
-5.5	-6	7.16	7.13	7.10	7.06	7.02
-3.0	-4	7.75	7.71	7.67	7.63	7.59
-1.0	-2	8.33	8.29	8.24	8.20	8.15
1.0	0	8.92	8.87	8.81	8.77	8.72
2.0	1	9.21	9.15	9.10	9.05	9.00
3.0	2	9.63	9.58	9.52	9.47	9.41
5.0	4	10.48	10.42	10.36	10.30	10.24
7.0	6	11.33	11.26	11.20	11.14	11.07
9.0	8	11.49	11.42	11.36	11.29	11.22
11.5	10	11.64	11.58	11.51	11.44	11.36
13.5	12	10.42	10.35	10.29	10.22	10.14
15.5	14	9.20	9.13	9.06	8.99	8.92
16.5	16	8.58	8.52	8.45	8.38	8.31

PJF000Z318

(2) Ceiling suspended type (FDE)

Model **FDE100VNP1VG** Indoor unit **FDE100VG** Outdoor unit **FDC100VNP**

Cooling mode

(kW)

Heating mode : HC

(kW)

Outdoor air temperature °CDB	Indoor air temperature															
	18°CDB		21°CDB		23°CDB		26°CDB		27°CDB		28°CDB		31°CDB		33°CDB	
	12°CWB	14°CWB	16°CWB	18°CWB	19°CWB	20°CWB	22°CWB	24°CWB	TC	SHC	TC	SHC	TC	SHC	TC	SHC
11			9.71	8.14	10.21	8.62	10.46	8.54	10.66	8.44	11.06	8.85	11.46	8.63		
13			9.71	8.14	10.21	8.62	10.46	8.54	10.66	8.44	11.06	8.85	11.46	8.63		
15			9.71	8.14	10.21	8.62	10.46	8.54	10.66	8.44	11.06	8.85	11.46	8.63		
17			9.71	8.14	10.21	8.62	10.46	8.54	10.66	8.44	11.06	8.85	11.46	8.63		
19			9.65	8.11	10.18	8.61	10.45	8.54	10.66	8.44	11.08	8.86	11.51	8.64		
21			9.59	8.09	10.16	8.60	10.44	8.54	10.67	8.44	11.11	8.87	11.56	8.66		
23			9.60	8.09	10.17	8.61	10.46	8.55	10.69	8.45	11.14	8.88	11.60	8.67		
25		9.03	8.18	9.60	8.09	10.19	8.62	10.48	8.55	10.71	8.46	11.17	8.89	11.63	8.68	
27		9.02	8.18	9.61	8.10	10.20	8.62	10.51	8.56	10.81	8.49	11.41	8.96			
29		8.92	8.13	9.49	8.05	10.08	8.57	10.38	8.51	10.68	8.45	11.28	8.92			
31		8.81	8.08	9.38	8.00	9.96	8.53	10.25	8.47	10.55	8.40	11.14	8.88			
33	8.24	7.49	8.61	7.99	9.26	7.95	9.83	8.48	10.13	8.42	10.42	8.36	11.01	8.83		
35	8.08	7.41	8.47	7.93	9.14	7.90	9.71	8.43	10.00	8.38	10.29	8.31	10.87	8.79		
37	7.85	7.31	8.23	7.83	8.84	7.78	9.37	8.31	9.67	8.25	9.96	8.20	10.54	8.68		
39	7.62	7.20	7.98	7.72	8.54	7.66	9.03	8.18	9.33	8.13	9.62	8.08	10.21	8.58		
41	7.39	7.09	7.74	7.58	8.24	7.54	8.70	8.05	8.99	8.01	9.29	7.97	9.89	8.48		
43	7.16	6.98	7.10	6.96	7.54	7.26	7.93	7.77	8.66	7.89	8.47	7.69	9.00	8.20		

Outdoor air temperature °CDB	°CWB	Indoor air temperature °CDB				
		16	18	20	22	24
-14.5	-15	6.20	6.18	6.16	6.14	6.11
-13.5	-14	6.26	6.23	6.21	6.19	6.16
-11.5	-12	6.36	6.34	6.31	6.29	6.26
-9.5	-10	6.47	6.44	6.42	6.39	6.36
-7.5	-8	6.58	6.55	6.52	6.49	6.46
-5.5	-6	7.16	7.13	7.10	7.06	7.02
-3.0	-4	7.75	7.71	7.67	7.63	7.59
-1.0	-2	8.33	8.29	8.24	8.20	8.15
1.0	0	8.92	8.87	8.81	8.77	8.72
2.0	1	9.21	9.15	9.10	9.05	9.00
3.0	2	9.63	9.58	9.52	9.47	9.41
5.0	4	10.48	10.42	10.36	10.30	10.24
7.0	6	11.33	11.26	11.20	11.14	11.07
9.0	8	11.49	11.42	11.36	11.29	11.22
11.5	10	11.64	11.58	11.51	11.44	11.36
13.5	12	10.42	10.35	10.29	10.22	10.14
15.5	14	9.20	9.13	9.06	8.99	8.92
16.5	16	8.58	8.52	8.45	8.38	8.31

PFA004Z049

Note(1) These data show average statuses.

Depending on the system control, there may be ranges where the operation is not conducted continuously.

These data show the case where the operation frequency of a compressor is fixed.

(2) Capacities are based on the following conditions.

Corresponding refrigerant piping length : 7.5m

Level difference of Zero.

(3) Symbols are as follows.

TC : Total cooling capacity (kW)

SHC : Sensible heat capacity (kW)

(3) Duct connected-High static pressure type (FDU)

Model **FDU100VNP1VF2** Indoor unit **FDU100VF2** Outdoor unit **FDC100VNP**

Cooling mode

(kW)

Heating mode : HC

(kW)

Outdoor air temperature °CDB	Indoor air temperature																Outdoor air temperature		Indoor air temperature				
	18°CDB		21°CDB		23°CDB		26°CDB		27°CDB		28°CDB		31°CDB		33°CDB		°CDB	°CWB	°CDB				
	TC	SHC	TC	SHC	TC	SHC	TC	SHC	TC	SHC	TC	SHC	TC	SHC	TC	SHC			16	18	20	22	24
11					9.71	7.49	10.21	7.92	10.46	7.77	10.66	7.61	11.06	7.97	11.46	7.62	-14.5	-15	6.20	6.18	6.16	6.14	6.11
13					9.71	7.49	10.21	7.92	10.46	7.77	10.66	7.61	11.06	7.97	11.46	7.62	-13.5	-14	6.26	6.23	6.21	6.19	6.16
15					9.71	7.49	10.21	7.92	10.46	7.77	10.66	7.61	11.06	7.97	11.46	7.62	-11.5	-12	6.36	6.34	6.31	6.29	6.26
17					9.71	7.49	10.21	7.92	10.46	7.77	10.66	7.61	11.06	7.97	11.46	7.62	-9.5	-10	6.47	6.44	6.42	6.39	6.36
19					9.65	7.47	10.18	7.91	10.45	7.77	10.66	7.61	11.08	7.97	11.51	7.63	-7.5	-8	6.58	6.55	6.52	6.49	6.46
21					9.59	7.45	10.16	7.90	10.44	7.77	10.67	7.61	11.11	7.98	11.56	7.63	-5.5	-6	7.16	7.13	7.10	7.06	7.02
23					9.60	7.45	10.17	7.91	10.46	7.77	10.69	7.61	11.14	7.98	11.60	7.64	-3.0	-4	7.75	7.71	7.67	7.63	7.59
25			9.03	7.67	9.60	7.45	10.19	7.91	10.48	7.78	10.71	7.62	11.17	7.99	11.63	7.65	-1.0	-2	8.33	8.29	8.24	8.20	8.15
27			9.02	7.67	9.61	7.45	10.20	7.92	10.51	7.78	10.81	7.64	11.41	8.03			1.0	0	8.92	8.87	8.81	8.77	8.72
29			8.92	7.63	9.49	7.42	10.08	7.88	10.38	7.75	10.68	7.61	11.28	8.01			2.0	1	9.21	9.15	9.10	9.05	9.00
31			8.81	7.60	9.38	7.38	9.96	7.85	10.25	7.72	10.55	7.58	11.14	7.98			3.0	2	9.63	9.58	9.52	9.47	9.41
33	8.24	7.05	8.61	7.53	9.26	7.35	9.83	7.82	10.13	7.69	10.42	7.55	11.01	7.96			5.0	4	10.48	10.42	10.36	10.30	10.24
35	8.08	6.99	8.47	7.48	9.14	7.31	9.71	7.79	10.00	7.66	10.29	7.52	10.87	7.93			7.0	6	11.33	11.26	11.20	11.14	11.07
37	7.85	6.90	8.23	7.40	8.84	7.23	9.37	7.70	9.67	7.58	9.96	7.45	10.54	7.87			9.0	8	11.49	11.42	11.36	11.29	11.22
39	7.62	6.82	7.98	7.32	8.54	7.14	9.03	7.61	9.33	7.50	9.62	7.38	10.21	7.81			11.5	10	11.64	11.58	11.51	11.44	11.36
41	7.39	6.73	7.74	7.24	8.24	7.05	8.70	7.53	8.99	7.42	9.29	7.31	9.89	7.75			13.5	12	10.42	10.35	10.29	10.22	10.14
43	7.16	6.65	7.10	6.96	7.54	6.85	7.93	6.34	8.66	7.34	8.47	7.13	9.00	7.60			15.5	14	9.20	9.13	9.06	8.99	8.92
																	16.5	16	8.58	8.52	8.45	8.38	8.31

PJG000Z190 

(4) Duct connected-Low / Middle static pressure type (FDUM)

Model **FDUM100VNP1VF2** Indoor unit **FDUM100VF2** Outdoor unit **FDC100VNP**

Cooling mode

(kW)

Heating mode : HC

(kW)

Outdoor air temperature °CDB	Indoor air temperature																Outdoor air temperature		Indoor air temperature				
	18°CDB		21°CDB		23°CDB		26°CDB		27°CDB		28°CDB		31°CDB		33°CDB		°CDB	°CWB	°CDB				
	TC	SHC	TC	SHC	TC	SHC	TC	SHC	TC	SHC	TC	SHC	TC	SHC	TC	SHC			16	18	20	22	24
11					9.71	7.49	10.21	7.92	10.46	7.77	10.66	7.61	11.06	7.97	11.46	7.62	-14.5	-15	6.20	6.18	6.16	6.14	6.11
13					9.71	7.49	10.21	7.92	10.46	7.77	10.66	7.61	11.06	7.97	11.46	7.62	-13.5	-14	6.26	6.23	6.21	6.19	6.16
15					9.71	7.49	10.21	7.92	10.46	7.77	10.66	7.61	11.06	7.97	11.46	7.62	-11.5	-12	6.36	6.34	6.31	6.29	6.26
17					9.71	7.49	10.21	7.92	10.46	7.77	10.66	7.61	11.06	7.97	11.46	7.62	-9.5	-10	6.47	6.44	6.42	6.39	6.36
19					9.65	7.47	10.18	7.91	10.45	7.77	10.66	7.61	11.08	7.97	11.51	7.63	-7.5	-8	6.58	6.55	6.52	6.49	6.46
21					9.59	7.45	10.16	7.90	10.44	7.77	10.67	7.61	11.11	7.98	11.56	7.63	-5.5	-6	7.16	7.13	7.10	7.06	7.02
23					9.60	7.45	10.17	7.91	10.46	7.77	10.69	7.61	11.14	7.98	11.60	7.64	-3.0	-4	7.75	7.71	7.67	7.63	7.59
25			9.03	7.67	9.60	7.45	10.19	7.91	10.48	7.78	10.71	7.62	11.17	7.99	11.63	7.65	-1.0	-2	8.33	8.29	8.24	8.20	8.15
27			9.02	7.67	9.61	7.45	10.20	7.92	10.51	7.78	10.81	7.64	11.41	8.03			1.0	0	8.92	8.87	8.81	8.77	8.72
29			8.92	7.63	9.49	7.42	10.08	7.88	10.38	7.75	10.68	7.61	11.28	8.01			2.0	1	9.21	9.15	9.10	9.05	9.00
31			8.81	7.60	9.38	7.38	9.96	7.85	10.25	7.72	10.55	7.58	11.14	7.98			3.0	2	9.63	9.58	9.52	9.47	9.41
33	8.24	7.05	8.61	7.53	9.26	7.35	9.83	7.82	10.13	7.69	10.42	7.55	11.01	7.96			5.0	4	10.48	10.42	10.36	10.30	10.24
35	8.08	6.99	8.47	7.48	9.14	7.31	9.71	7.79	10.00	7.66	10.29	7.52	10.87	7.93			7.0	6	11.33	11.26	11.20	11.14	11.07
37	7.85	6.90	8.23	7.40	8.84	7.23	9.37	7.70	9.67	7.58	9.96	7.45	10.54	7.87			9.0	8	11.49	11.42	11.36	11.29	11.22
39	7.62	6.82	7.98	7.32	8.54	7.14	9.03	7.61	9.33	7.50	9.62	7.38	10.21	7.81			11.5	10	11.64	11.58	11.51	11.44	11.36
41	7.39	6.73	7.74	7.24	8.24	7.05	8.70	7.53	8.99	7.42	9.29	7.31	9.89	7.75			13.5	12	10.42	10.35	10.29	10.22	10.14
43	7.16	6.65	7.10	6.96	7.54	6.85	7.93	6.34	8.66	7.34	8.47	7.13	9.00	7.60			15.5	14	9.20	9.13	9.06	8.99	8.92
																	16.5	16	8.58	8.52	8.45	8.38	8.31

PJG000Z189 

Note(1) These data show average statuses.

Depending on the system control, there may be ranges where the operation is not conducted continuously.

These data show the case where the operation frequency of a compressor is fixed.(Cooling only)

(2) Capacities are based on the following conditions.

Corresponding refrigerant piping length :7.5m

Level difference of Zero.

(3) Symbols are as follows.

TC : Total cooling capacity (kW)

SHC : Sensible heat capacity (kW)

HC : Heating capacity (kW)

(5) Floor standing type (FDF)

Model **FDF100VNP1VD2** Indoor unit FDF100VD2 Outdoor unit FDC100VNP

Cooling mode

(kW)

Heating mode : HC

(kW)

Outdoor air temperature °CDB	Indoor air temperature															
	18°CDB		21°CDB		23°CDB		26°CDB		27°CDB		28°CDB		31°CDB		33°CDB	
	TC	SHC	TC	SHC	TC	SHC	TC	SHC	TC	SHC	TC	SHC	TC	SHC	TC	SHC
11					9.71	7.81	10.21	8.24	10.46	8.16	10.66	8.06	11.06	8.42	11.46	8.20
13					9.71	7.81	10.21	8.24	10.46	8.16	10.66	8.06	11.06	8.42	11.46	8.20
15					9.71	7.81	10.21	8.24	10.46	8.16	10.66	8.06	11.06	8.42	11.46	8.20
17					9.71	7.81	10.21	8.24	10.46	8.16	10.66	8.06	11.06	8.42	11.46	8.20
19					9.65	7.78	10.18	8.23	10.45	8.16	10.66	8.06	11.08	8.43	11.51	8.22
21					9.59	7.75	10.16	8.22	10.44	8.16	10.67	8.07	11.11	8.44	11.56	8.23
23					9.60	7.76	10.17	8.22	10.46	8.16	10.69	8.07	11.14	8.45	11.60	8.25
25			9.03	7.84	9.60	7.76	10.19	8.23	10.48	8.17	10.71	8.08	11.17	8.46	11.63	8.26
27			9.02	7.84	9.61	7.76	10.20	8.24	10.51	8.18	10.81	8.12	11.41	8.54		
29			8.92	7.79	9.49	7.71	10.08	8.19	10.38	8.13	10.68	8.07	11.28	8.49		
31			8.81	7.74	9.38	7.66	9.96	8.14	10.25	8.08	10.55	8.02	11.14	8.45		
33	8.24	7.19	8.61	7.64	9.26	7.61	9.83	8.09	10.13	8.04	10.42	7.98	11.01	8.40		
35	8.08	7.12	8.47	7.58	9.14	7.56	9.71	8.04	10.00	7.99	10.29	7.93	10.87	8.35		
37	7.85	7.01	8.23	7.47	8.84	7.44	9.37	7.91	9.67	7.86	9.96	7.81	10.54	8.25		
39	7.62	6.89	7.98	7.36	8.54	7.31	9.03	7.78	9.33	7.74	9.62	7.69	10.21	8.14		
41	7.39	6.78	7.74	7.25	8.24	7.18	8.70	7.65	8.99	7.61	9.29	6.57	9.89	8.03		
43	7.16	6.68	7.10	6.96	7.54	6.90	7.93	6.36	8.66	7.49	8.47	6.28	9.00	7.75		

Outdoor air temperature °CDB	°CWB	Indoor air temperature °CDB					
		16	18	20	22	24	
		-14.5	-15	6.20	6.18	6.16	6.14
-13.5	-14	6.26	6.23	6.21	6.19	6.16	
-11.5	-12	6.36	6.34	6.31	6.29	6.26	
-9.5	-10	6.47	6.44	6.42	6.39	6.36	
-7.5	-8	6.58	6.55	6.52	6.49	6.46	
-5.5	-6	7.16	7.13	7.10	7.06	7.02	
-3.0	-4	7.75	7.71	7.67	7.63	7.59	
-1.0	-2	8.33	8.29	8.24	8.20	8.15	
1.0	0	8.92	8.87	8.81	8.77	8.72	
2.0	1	9.21	9.15	9.10	9.05	9.00	
3.0	2	9.63	9.58	9.52	9.47	9.41	
5.0	4	10.48	10.42	10.36	10.30	10.24	
7.0	6	11.33	11.26	11.20	11.14	11.07	
9.0	8	11.49	11.42	11.36	11.29	11.22	
11.5	10	11.64	11.58	11.51	11.44	11.36	
13.5	12	10.42	10.35	10.29	10.22	10.14	
15.5	14	9.20	9.13	9.06	8.99	8.92	
16.5	16	8.58	8.52	8.45	8.38	8.31	

PGA000Z814 

(6) Wall mounted type (SRK)

Model **SRK100VNP1ZR** Indoor unit SRK100ZR-S Outdoor unit FDC100VNP

Cooling mode

(kW)

Heating mode : HC

(kW)

Outdoor air temperature °CDB	Indoor air temperature															
	18°CDB		21°CDB		23°CDB		26°CDB		27°CDB		28°CDB		31°CDB		33°CDB	
	TC	SHC	TC	SHC	TC	SHC	TC	SHC	TC	SHC	TC	SHC	TC	SHC	TC	SHC
11					9.71	7.31	10.21	7.67	10.46	7.59	10.66	7.50	11.06	7.77	11.46	7.56
13					9.71	7.31	10.21	7.67	10.46	7.59	10.66	7.50	11.06	7.77	11.46	7.56
15					9.71	7.31	10.21	7.67	10.46	7.59	10.66	7.50	11.06	7.77	11.46	7.56
17					9.71	7.31	10.21	7.67	10.46	7.59	10.66	7.50	11.06	7.77	11.46	7.56
19					9.65	7.28	10.18	7.65	10.45	7.59	10.66	7.50	11.08	7.78	11.51	7.58
21					9.59	7.26	10.16	7.64	10.44	7.59	10.67	7.50	11.11	7.79	11.56	7.59
23					9.60	7.26	10.17	7.65	10.46	7.59	10.69	7.51	11.14	7.80	11.60	7.60
25			9.03	7.33	9.60	7.26	10.19	7.66	10.48	7.60	10.71	7.52	11.17	7.81	11.63	7.62
27			9.02	7.33	9.61	7.26	10.20	7.66	10.51	7.61	10.81	7.55	11.41	7.90		
29			8.92	7.27	9.49	7.21	10.08	7.61	10.38	7.56	10.68	7.50	11.28	7.85		
31			8.81	7.22	9.38	7.16	9.96	7.56	10.25	7.51	10.55	7.45	11.14	7.80		
33	8.24	6.76	8.61	7.12	9.26	7.11	9.83	7.51	10.13	7.46	10.42	7.40	11.01	7.75		
35	8.08	6.68	8.47	7.06	9.14	7.05	9.71	7.46	10.00	7.41	10.29	7.35	10.87	7.70		
37	7.85	6.56	8.23	6.94	8.84	6.92	9.37	7.31	9.67	7.27	9.96	7.22	10.54	7.59		
39	7.62	6.44	7.98	6.83	8.54	6.79	9.03	7.18	9.33	7.14	9.62	7.10	10.21	7.47		
41	7.39	6.33	7.74	6.71	8.24	6.65	8.70	7.04	8.99	7.01	9.29	6.97	9.89	7.36		
43	7.16	6.21	7.10	6.41	7.54	6.35	7.93	6.73	8.66	6.88	8.47	6.67	9.00	7.05		

Outdoor air temperature °CDB	°CWB	Indoor air temperature °CDB					
		16	18	20	22	24	
		-14.5	-15	6.20	6.18	6.16	6.14
-13.5	-14	6.26	6.23	6.21	6.19	6.16	
-11.5	-12	6.36	6.34	6.31	6.29	6.26	
-9.5	-10	6.47	6.44	6.42	6.39	6.36	
-7.5	-8	6.58	6.55	6.52	6.49	6.46	
-5.5	-6	7.16	7.13	7.10	7.06	7.02	
-3.0	-4	7.75	7.71	7.67	7.63	7.59	
-1.0	-2	8.33	8.29	8.24	8.20	8.15	
1.0	0	8.92	8.87	8.81	8.77	8.72	
2.0	1	9.21	9.15	9.10	9.05	9.00	
3.0	2	9.63	9.58	9.52	9.47	9.41	
5.0	4	10.48	10.42	10.36	10.30	10.24	
7.0	6	11.33	11.26	11.20	11.14	11.07	
9.0	8	11.49	11.42	11.36	11.29	11.22	
11.5	10	11.64	11.58	11.51	11.44	11.36	
13.5	12	10.42	10.35	10.29	10.22	10.14	
15.5	14	9.20	9.13	9.06	8.99	8.92	
16.5	16	8.58	8.52	8.45	8.38	8.31	

PCA001Z764 

Note(1) These data show average statuses.

Depending on the system control, there may be ranges where the operation is not conducted continuously.

These data show the case where the operation frequency of a compressor is fixed.(Cooling only)

(2) Capacities are based on the following conditions.

Corresponding refrigerant piping length :7.5m

Level difference of Zero.

(3) Symbols are as follows.

TC : Total cooling capacity (kW)

SHC : Sensible heat capacity (kW)

HC : Heating capacity (kW)

[References data]

Capacity variation against outdoor and indoor temperature at the maximum compressor speed capacity compensation coefficient shows the ratio to nominal capacity.

① Cooling

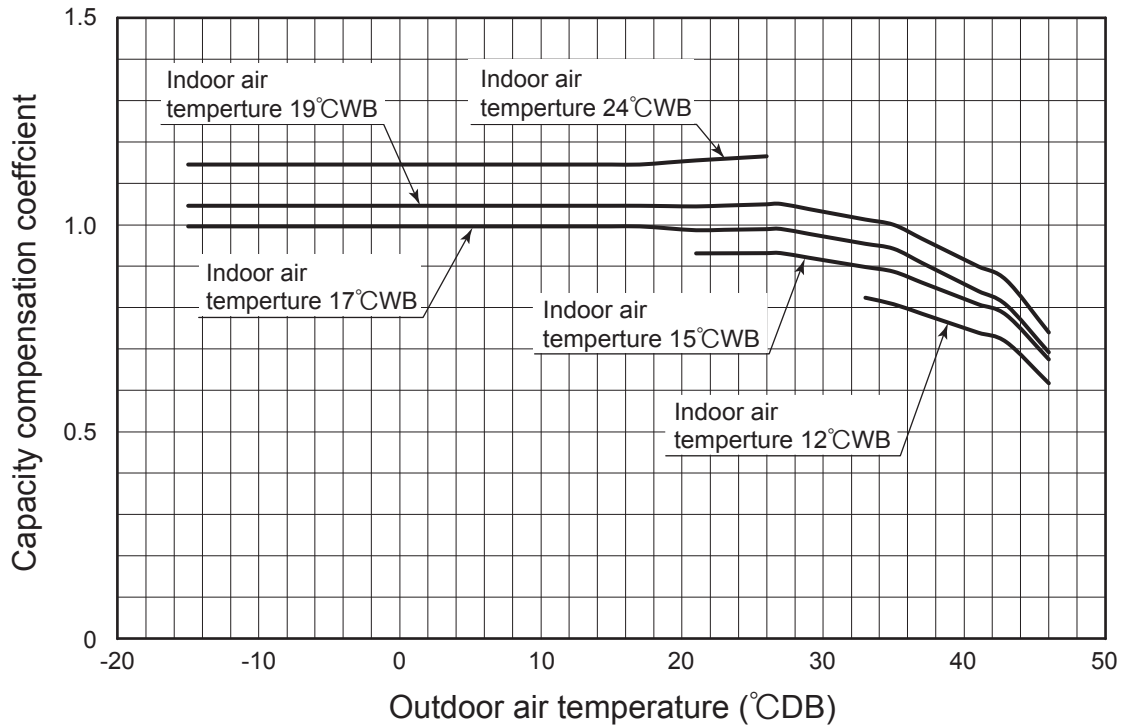

② Heating

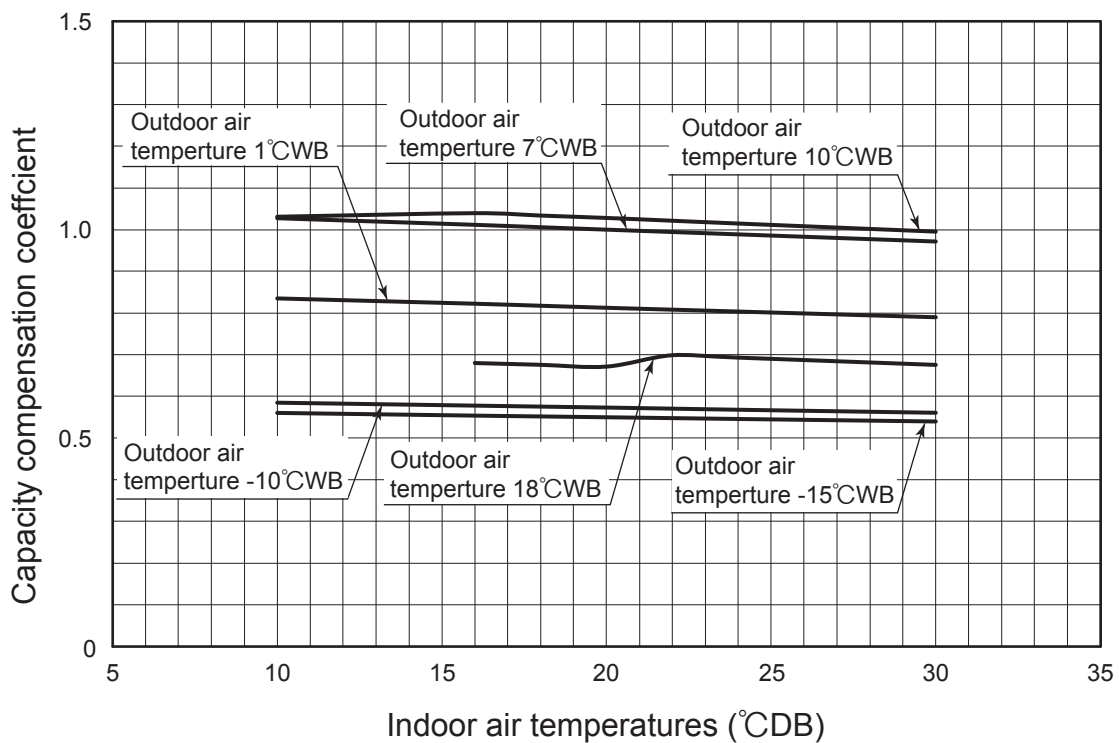

9.2 Correction of cooling and heating capacity in relation to air flow rate control Fan speed (Except SRK series)

Fan speed		P-Hi	Hi	Me	Lo
Coefficient	Cooling	1.00	0.95	0.93	0.90
	Heating	1.00	0.97	0.96	0.94

9.3 Correction of cooling and heating capacity in relation to one way length of refrigerant piping

It is necessary to correct the cooling and heating capacity in relation to the one way equivalent piping length between the indoor and outdoor units.

Equivalent piping length (m)	7.5	10	15	20	25	30
Cooling	1	0.99	0.97	0.96	0.94	0.92
Heating	1	1	1	1	1	1

9.4 Height difference between the indoor unit and outdoor unit

When the outdoor unit is located below indoor units in cooling mode, or when the outdoor unit is located above indoor units in heating mode, the correction coefficient mentioned in the below table should be subtracted from the value in the above table.

Height difference between the indoor unit and outdoor unit in the vertical height difference	5m	10m	15m	20m
Adjustment coefficient	0.99	0.98	0.97	0.96

Piping length limitations

Item	Model	All models
Max. one way piping length		30m
Max. vertical height difference		Outdoor unit is higher 20m Outdoor unit is lower 20m

Note (1) Values in the table indicate the one way piping length between the indoor and outdoor units.

How to obtain the cooling and heating capacity

Example : The net cooling capacity of the model FDT100VNP1VF2 with the air flow “P-Hi”, the piping length of 15m, the outdoor unit located 5m lower than the indoor unit, indoor wet-bulb temperature at 19.0°C and outdoor dry-bulb temperature 35°C is

$$\text{Net cooling capacity} = 10.0 \times 1.00 \times 0.97 \times 0.99 \approx 9.6 \text{ kW}$$

Net cooling total capacity of FDT100VNP1VF2 (Outdoor temp. : 35°CDB Indoor temp. : 19°CWB) shown in table 9.1
 Air flow : P-Hi shown in table 9.2
 Piping length : 15m (Gas pipe size is ϕ 15.88) shown in table 9.3
 Height difference : 5m (Outdoor unit : below) shown in table 9.4



10. APPLICATION DATA

10.1 Installation of indoor unit

(1) Ceiling cassette-4 way type (FDT)

This manual is for the installation of an indoor unit.
 For electrical wiring work (Indoor), refer to the page 76. For remote control installation, refer to the page 84. For wireless kit installation, refer to the page 217. For electrical wiring work (Outdoor) and refrigerant pipe work installation for outdoor unit, refer to the page 98.
 This unit must always be used with the panel.

SAFETY PRECAUTIONS

- Read the "SAFETY PRECAUTIONS" carefully first of all and then strictly follow it during the installation work in order to protect yourself.
- The precautionary items mentioned below are distinguished into two levels, **⚠️ [WARNING]** and **⚠️ [CAUTION]**.
⚠️ [WARNING]: Wrong installation would cause serious consequences such as injuries or death.
⚠️ [CAUTION]: Wrong installation might cause serious consequences depending on circumstances.
 Both mention the important items to protect your health and safety so strictly follow them by any means.
 The meanings of "Marks" used here are as shown on the right:
 ⚠️ Never do it under any circumstances. ⚠️ Always do it according to the instruction.
- After completing the installation, do commissioning to confirm there are no abnormalities, and explain to the customers about "SAFETY PRECAUTIONS", correct operation method and maintenance method (air filter cleaning, operation method and temperature setting method) with user's manual of this unit.
 Ask your customers to keep this installation manual together with the user's manual. Also, ask them to hand over the user's manual to the new user when the owner is changed.

⚠️ WARNING

- **Installation should be performed by the specialist.**
 If you install the unit by yourself, it may lead to serious trouble such as water leakage, electric shock, fire, and injury due to overturn of the unit. ⚠️
- **Install the system correctly according to these installation manuals.**
 Improper installation may cause explosion, injury, water leakage, electric shock, and fire. ⚠️
- **Check the density referred by the formula (accordance with ISO5149).**
 If the density exceeds the limit density, please consult the dealer and installate the ventilation system. ⚠️
- **Use the genuine accessories and the specified parts for installation.**
 If parts unspecified by our company are used it could cause water leakage, electric shock, fire, and injury due to overturn of the unit. ⚠️
- **Ventilate the working area well in case the refrigerant leaks during installation.**
 If the refrigerant contacts the fire, toxic gas is produced. ⚠️
- **Install the unit in a location that can hold heavy weight.**
 Improper installation may cause the unit to fall leading to accidents. ⚠️
- **Install the unit properly in order to be able to withstand strong winds such as typhoons, and earthquakes.**
 Improper installation may cause the unit to fall leading to accidents. ⚠️
- **Do not mix air in to the cooling cycle on installation or removal of the air-conditioner.**
 If air is mixed in, the pressure in the cooling cycle will rise abnormally and may cause explosion and injuries. ⚠️
- **Be sure to have the electrical wiring work done by qualified electrical installer, and use exclusive circuit.**
 Power source with insufficient capacity and improper work can cause electric shock and fire. ⚠️
- **Use specified wire for electrical wiring, fasten the wiring to the terminal securely, and hold the cable securely in order not to apply unexpected stress on the terminal.**
 Loose connections or hold could result in abnormal heat generation or fire. ⚠️
- **Arrange the electrical wires in the control box properly to prevent them from rising. Fit the lid of the services panel properly.**
 Improper fitting may cause abnormal heat and fire. ⚠️
- **Check for refrigerant gas leakage after installation is completed.**
 If the refrigerant gas leaks into the house and comes in contact with a fan heater, a stove, or an oven, toxic gas is produced. ⚠️
- **Use the specified pipe, flare nut, and tools for R410A.**
 Using existing parts (R22) could cause the unit failure and serious accident due to explosion of the cooling cycle. ⚠️
- **Tighten the flare nut according to the specified method by with torque wrench.**
 If the flare nut were tightened with excess torque, it could cause burst and refrigerant leakage after a long period. ⚠️
- **Do not put the drainage pipe directly into drainage channels where poisonous gases such as sulfide gas can occur.**
 Poisonous gases will flow into the room through drainage pipe and seriously affect the user's health and safety. This can also cause the corrosion of the indoor unit and a resultant unit failure or refrigerant leak. ⚠️
- **Connect the pipes for refrigeration circuit securely in installation work before compressor is operated.**
 If the compressor is operated when the service valve is open without connecting the pipe, it could cause explosion and injuries due to abnormal high pressure in the system. ⚠️
- **Stop the compressor before removing the pipe after shutting the service valve on pump down work.**
 If the pipe is removed when the compressor is in operation with the service valve open, air would be mixed in the refrigeration circuit and it could cause explosion and injuries due to abnormal high pressure in the cooling cycle. ⚠️
- **Only use prescribed option parts. The installation must be carried out by the qualified installer.**
 If you install the system by yourself, it can cause serious trouble such as water leaks, electric shocks, fire. ⚠️
- **Do not repair by yourself. And consult with the dealer about repair.**
 Improper repair may cause water leakage, electric shock or fire. ⚠️
- **Consult the dealer or a specialist about removal of the air-conditioner.**
 Improper installation may cause water leakage, electric shock or fire. ⚠️
- **Turn off the power source during servicing or inspection work.**
 If the power is supplied during servicing or inspection work, it could cause electric shock and injury by the operating fan. ⚠️
- **Do not run the unit when the panel or protection guard are taken off.**
 Touching the rotating equipment, hot surface, or high voltage section could cause an injury to be caught in the machine, to get burned, or electric shock. ⚠️
- **Shut off the power before electrical wiring work.**
 It could cause electric shock, unit failure and improper running. ⚠️

⚠️ CAUTION

- **Perform earth wiring surely.**
 Do not connect the earth wiring to the gas pipe, water pipe, lightning rod and telephone earth wiring. Improper earth could cause unit failure and electric shock due to a short circuit. ⚠️
- **Earth leakage breaker must be installed.**
 If the earth leakage breaker is not installed, it can cause electric shocks. ⚠️
- **Use the circuit breaker of correct capacity. Circuit breaker should be the one that disconnect all poles under over current.**
 Using the incorrect one could cause the system failure and fire. ⚠️
- **Do not use any materials other than a fuse of correct capacity where a fuse should be used.**
 Connecting the circuit by wire or copper wire could cause unit failure and fire. ⚠️
- **Do not install the indoor unit near the location where there is possibility of flammable gas leakages.**
 If the gas leaks and gathers around the unit, it could cause fire. ⚠️
- **Do not install and use the unit where corrosive gas (such as sulfurous acid gas etc.) or flammable gas (such as thinner, petroleum etc.) may be generated or accumulated, or volatile flammable substances are handled.**
 It could cause the corrosion of heat exchanger, breakage of plastic parts etc. And inflammable gas could cause fire. ⚠️
- **Secure a space for installation, inspection and maintenance specified in the manual.**
 Insufficient space can result in accident such as personal injury due to falling from the installation place. ⚠️
- **Do not use the indoor unit at the place where water splashes such as laundry.**
 Indoor unit is not waterproof. It could cause electric shock and fire. ⚠️
- **Do not use the indoor unit for a special purpose such as food storage, cooling for precision instrument, preservation of animals, plants, and a work of art.**
 It could cause the damage of the items. ⚠️
- **Do not install nor use the system near equipments which generate electromagnetic wave or high harmonics.**
 Equipments like inverter equipment, private power generator, high-frequency medical equipment, or telecommunication equipment might influence the air-conditioner and cause a malfunction and breakdown. Or the air-conditioner might influence medical equipments or telecommunication equipments, and obstruct their medical activity or cause jamming. ⚠️
- **Do not install the remote control at the direct sunlight.**
 It could cause breakdown or deformation of the remote control. ⚠️
- **Do not install the indoor unit at the place listed below.**
 - Places where flammable gas could leak.
 - Places where carbon fiber, metal powder or any powder is floated.
 - Place where the substances which affect the air-conditioner are generated such as sulfide gas, chlorine gas, acid, alkali or ammoniac atmospheres.
 - Places exposed to oil mist or steam directly.
 - On vehicles and ships
 - Places where machinery which generates high harmonics is used.
 - Places where cosmetics or special sprays are frequently used.
 - Highly salted area such as beach.
 - Heavy snow area
 - Places where the system is affected by smoke from a chimney.
 - Altitude over 1000m
- **Do not install the indoor unit in the locations listed below (Be sure to install the indoor unit according to the installation manual for each model because each indoor unit has each limitation)**
 - Locations with any obstacles which can prevent inlet and outlet air of the unit
 - Locations where vibration can be amplified due to insufficient strength of structure.
 - Locations where the infrared receiver is exposed to the direct sunlight or the strong light beam. (in case of the infrared specification unit)
 - Locations where an equipment affected by high harmonics is placed. (TV set or radio receiver is placed within 5m)
 - Locations where drainage cannot run off safely.
 - It can affect performance or function and etc..
- **Do not put any valuables which will break down by getting wet under the air-conditioner.**
 Condensation could drop when the relative humidity is higher than 80% or drain pipe is clogged, and it damages user's belongings. ⚠️
- **Do not use the base frame for the outdoor unit which is corroded or damaged after a long period of use.**
 It could cause the unit falling down and injury. ⚠️
- **Pay attention not to damage the drain pan by weld sputter when brazing work is done near the unit.**
 If sputter entered into the unit during brazing work, it could cause damage (pinhole) of drain pan and leakage of water. To avoid damaging, keep the indoor unit packed or cover the indoor unit. ⚠️
- **Install the drain pipe to drain the water surely according to the installation manual.**
 Improper connection of the drain pipe may cause dropping water into room and damaging user's belongings. ⚠️
- **Do not share the drain pipe for indoor unit and GHP (Gas Heat Pump system) outdoor unit.**
 Toxic exhaust gas would flow into room and it might cause serious damage (some poisoning or deficiency of oxygen) to user's health and safety. ⚠️
- **Be sure to perform air tightness test by pressurizing with nitrogen gas after completed refrigerant piping work.**
 If the density of refrigerant exceeds the limit in the event of refrigerant leakage in the small room, lack of oxygen can occur, which can cause serious accidents. ⚠️
- **For drain pipe installation, be sure to make descending slope of greater than 1/100, not to make traps, and not to make air-bleeding.**
 Check if the drainage is correctly done during commissioning and ensure the space for inspection and maintenance. ⚠️
- **Ensure the insulation on the pipes for refrigeration circuit so as not to condense water.**
 Incomplete insulation could cause condensation and it would wet ceiling, floor, and any other valuables. ⚠️
- **Do not install the outdoor unit where is likely to be a nest for insects and small animals.**
 Insects and small animals could come into the electronic components and cause breakdown and fire. Instruct the user to keep the surroundings clean. ⚠️
- **Pay extra attention, carrying the unit by hand.**
 Carry the unit with 2 people if it is heavier than 20kg. Do not use the plastic straps but the grabbing place, moving the unit by hand. Use protective gloves in order to avoid injury by the aluminum fin. ⚠️
- **Make sure to dispose of the packaging material.**
 Leaving the materials may cause injury as metals like nail and woods are used in the package. ⚠️
- **Do not operate the system without the air filter.**
 It may cause the breakdown of the system due to clogging of the heat exchanger. ⚠️
- **Do not touch any button with wet hands.**
 It could cause electric shock. ⚠️
- **Do not touch the refrigerant piping with bare hands when in operation.**
 The pipe during operation would become very hot or cold according to the operating condition, and it could cause a burn or frostbite. ⚠️
- **Do not clean up the air-conditioner with water.**
 It could cause electric shock. ⚠️
- **Do not turn off the power source immediately after stopping the operation.**
 Be sure to wait for more than 5 minutes. Otherwise it could cause water leakage or breakdown. ⚠️
- **Do not control the operation with the circuit breaker.**
 It could cause fire or water leakage. In addition, the fan may start operation unexpectedly and it may cause injury. ⚠️

① Before installation

- Install correctly according to the installation manual.
- Confirm the following points:
 - Unit type/Power source specification
 - Pipes/Wires/Small parts
 - Accessory items

Accessory item

For unit hanging		For refrigerant pipe			For drain pipe			
Flat washer (M10)	Level gauge	Pipe cover (big)	Pipe cover (small)	Strap	Pipe cover (big)	Pipe cover (small)	Drain hose	Hose clamp
8	1	1	1	4	1	1	1	1
For unit hanging	For unit hanging and adjustment	For heat insulation of gas pipe	For heat insulation of liquid tube	For pipe cover fixing	For heat insulation of drain socket	For heat insulation of drain socket	For drain pipe connecting	For drain hose mounting

② Selection of installation location for the indoor unit

- Select the suitable areas to install the unit under approval of the user.
 - Areas where the indoor unit can deliver hot and cold wind sufficiently. Suggest to the user to use a circulator if the ceiling height is over 3m to avoid warm air being accumulated on the ceiling.
 - Areas where there is enough space to install and service.
 - Areas where it can be drained properly. Areas where drain pipe descending slope can be taken.
 - Areas where there is no obstruction of airflow on both air return grille and air supply port.
 - Areas where fire alarm will not be accidentally activated by the air-conditioner.
 - Areas where the supply air does not short-circuit.
 - Areas where it is not influenced by draft air.
 - Areas not exposed to direct sunlight.
 - Areas where dew point is lower than around 28°C and relative humidity is lower than 80%.
(This indoor unit is tested under the condition of JIS (Japan Industrial Standard) high humidity condition and confirmed there is no problem. However, there is some risk of condensation drop if the air-conditioner is operated under the severer condition than mentioned above.
If there is a possibility to use it under such a condition, attach additional insulation of 10 to 20mm thick for entire surface of indoor unit, refrigeration pipe and drain pipe.)
 - Areas where TV and radio stays away more than 1m. (It could cause jamming and noise.)
 - Areas where any items which will be damaged by getting wet are not placed such as food, table wares, server, or medical equipment under the unit.
 - Areas where there is no influence by the heat which cookware generates.
 - Areas where not exposed to oil mist, powder and/or steam directly such as above fryer.
 - Areas where lighting device such as fluorescent light or incandescent light doesn't affect the operation.
(A beam from lighting device sometimes affects the infrared receiver for the wireless remote control and the air-conditioner might not work properly.)
- Check if the place where the air-conditioner is installed can hold the weight of the unit. If it is not able to hold, reinforce the structure with boards and beams strong enough to hold it. If the strength is not enough, it could cause injury due to unit falling.
- If there are 2 units of wireless type, keep them away for more than 6m to avoid malfunction due to cross communication.
- When plural indoor units are installed nearby, keep them away for more than 4 to 5m.

Space for installation and service

- When it is not possible to keep enough space between indoor unit and wall or between indoor units, close the air supply port where it is not possible to keep space and confirm there is no short circuit of airflow.
- Install the indoor unit at a height of more than 2.5m above the floor.

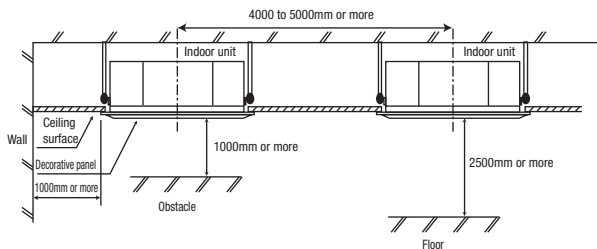

Set blow-out pattern

- Select the most proper number of blow-out air supply port direction from 4 way, 3 way or 2 way according to the shape of the room and installation position. (1 way is not available.)
- If it is necessary to change the number of air supply port, prepare the covering materials. (sold as accessory)
- Instruct the user not to use low fan speed when 2way or 3way air supply is used.
- Do not use 2way air supply port under high temperature and humidity environment. (Otherwise it could cause condensation and leakage of water.)
- It is possible to set the airflow direction port by port independently. Refer to the user's manual for details.

③ Preparation before installation

- If suspension bolt becomes longer, do reinforcement of earthquake resistant.
 - For grid ceiling
 - When suspension bolt length is over 500mm, or the gap between the ceiling and roof is over 700mm, apply earthquake resistant brace to the bolt.
 - In case the unit is hanged directly from the slab and is installed on the ceiling plane which has enough strength.
 - When suspension bolt length is over 1000mm, apply the earthquake resistant brace to the bolt.
- Prepare four (4) sets of suspension bolt, nut and spring washer (M10 or M8) on site.

Ceiling opening, Suspension bolts pitch, Pipe position

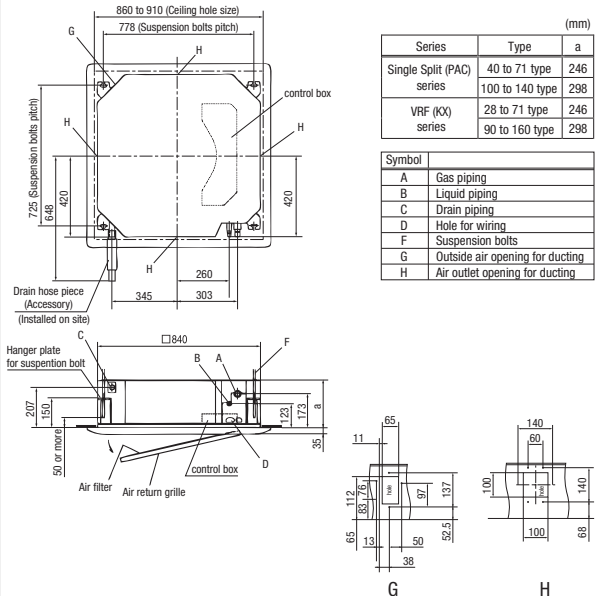

④ Installation of indoor unit

Work procedure

- Prepare a ceiling hole with the size of from 860mm × 860mm to 910mm × 910mm referring to the template attached in the package.
- Arrange the suspension bolt at the right position (725mm × 778mm).
- Make sure to use four suspension bolts and fix them so as to be able to hold 500N load.
- Ensure that the lower end of the suspension bolt should be 50mm above the ceiling plane. Temporarily put the four lower nuts 150mm above the ceiling plane and the upper nuts on distant place from the lower nuts in order not to obstruct hanging the indoor unit or adjust the indoor unit position, and then hang the indoor unit.
- Adjust the indoor unit position after hanging it by inserting the level gauge attached on the package into the air supply port and checking if the gap between the ceiling plane and the indoor unit is appropriate. In order to adjust the indoor unit position, adjust the lower nuts while the upper nuts are put on distant place. Confirm there is no backlash between the hanger plate for suspension bolt and the lower nut and washer.

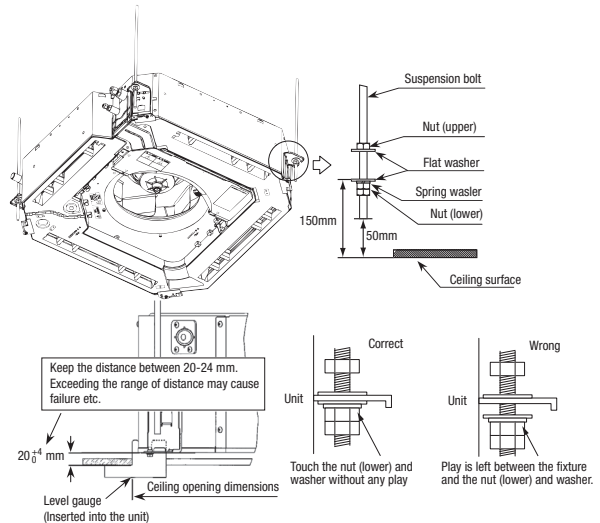

④ Installation of indoor unit (continued)

- Make sure to install the indoor unit horizontally. Confirm the levelness of the indoor unit with a level gauge or transparent hose filled with water. Keep the height difference at both ends of the indoor unit within 3mm.
- Tighten four upper nuts and fix the unit after height and levelness adjustment.

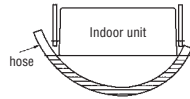

Caution

- Do not adjust the height by adjusting upper nuts. It will cause unexpected stress on the indoor unit and it will lead to deformation of the unit, failure of attaching a panel, and generating noise from the fan.
- Make sure to install the indoor unit horizontally and set the gap between the unit underside and the ceiling plane properly. Improper installation may cause air leakage, dew condensation, water leakage and noise.
- Even after decorative panel attached, still the unit height can be adjusted finely. Refer to the installation manual for decorative panel for details.
- Make sure there is no gap between decoration panel and ceiling surface, and between decoration panel and the indoor unit. The gap may cause air leakage, dew condensation and water leakage.
- In case decorative panel is not installed at the same time, or ceiling material is installed after the unit installed, put the cardboard template for installation attached on the package (packing material of cardboard box) on the bottom of the unit in order to avoid dust coming into the indoor unit.

⑤ Refrigerant pipe

Caution

- Be sure to use new pipes for the refrigerant pipes. Use the flare nut attached to the product or a nut compatible with JIS B 8607, Class 2. Regarding whether existing pipes can be reused or not, and the washing method, refer to the instruction manual of the outdoor unit, catalogue or technical data.

- In case of reuse: Do not use old flare nut, but use the one attached to the unit or compatible with JIS B 8607, Class 2.
- In case of reuse: Flare the end of pipe replaced partially for R410A.

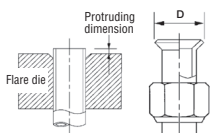

Pipe dia. d mm	Min. pipe wall thickness mm	Protruding dimension for flare, mm		Flare O.D. D mm	Flare nut tightening torque N·m
		Rigid (Clutch type) For R410A	Conventional tool		
6.35	0.8	0 - 0.5	0.7 - 1.3	8.9 - 9.1	14 - 18
9.52	0.8			12.6 - 13.2	34 - 42
12.7	0.8			16.2 - 16.6	49 - 61
15.88	1			19.3 - 19.7	68 - 82
19.05	1.2			23.6 - 24.0	100 - 120

- Use phosphorus deoxidized copper alloy seamless pipe (C1220T specified in JIS H 3300) for refrigeration pipe installation. In addition, make sure there is no damage both inside and outside of the pipe, and no harmful substances such as sulfur, oxide, dust or a contaminant stuck on the pipes.
- Do not use any refrigerant other than R410A. Using other refrigerant except R410A (R22 etc.) may degrade inside refrigeration oil. And air getting into refrigeration circuit may cause over-pressure and resultant it may result in bursting, etc.
- Store the copper pipes indoors and seal the both end of them until they are brazed in order to avoid any dust, dirt or water getting into pipe. Otherwise it will cause degradation of refrigeration oil and compressor breakdown, etc.
- Use special tools for R410A refrigerant.

Work procedure

- Remove the flare nut and blind flanges on the pipe of the indoor unit.
 - Make sure to loosen the flare nut with holding the nut on pipe side with a spanner and giving torque to the nut with another spanner in order to avoid unexpected stress to the copper pipe, and then remove them. (Gas may come out at this time, but it is not abnormal.)
 - Pay attention whether the flare nut pops out. (as the indoor unit is sometimes pressured.)
- Make a flare on liquid pipe and gas pipe, and connect the refrigeration pipes on the indoor unit.
 - Bend radius of pipe must be 4D or larger. Once a pipe is bent, do not readjust the bending. Do not twist a pipe or collapse to 2/3D or smaller.
 - Do a flare connection as follows:
 - Make sure to loosen the flare nut with holding the nut on pipe side with a spanner and giving torque to the nut with another spanner in order to avoid unexpected stress to the copper pipe, and then remove them.
 - When fastening the flare nut, align the refrigeration pipe with the center of flare nut, screw the nut for 3-4 times by hand and then tighten it by spanner with the specified torque mentioned in the table above. Make sure to hold the pipe on the indoor unit securely by a spanner when tightening the nut in order to avoid unexpected stress on the copper pipe.
- Cover the flare connection part of the indoor unit with attached insulation material after a gas leakage inspection, and tighten both ends with attached straps.
 - Make sure to insulate both gas pipes and liquid pipes completely.
 - Incomplete insulation may cause dew condensation or water dropping.
 - Use heat-resistant (120 °C or more) insulations on the gas side pipes.
 - In case of using at high humidity condition, reinforce insulation of refrigerant pipes. Surface of insulation may cause dew condition or water dropping, if insulations are not reinforced.
- Refrigerant is charged in the outdoor unit. As for the additional refrigerant charge for the indoor unit and piping, refer to the installation manual attached to the outdoor unit.

⑤ Refrigerant pipe (continued)

Caution:

Refrigerating machine oil should not be applied to the threads of union or external surface of flare. It is because, even if the same tightening torque is applied, the oil is likely to decrease the slide friction force on the threads and increase, in turn, the axial component force so that it could crack the flare by the stress corrosion. Refrigerating machine oil may be applied to the internal surface of flare only.

<The case of using thickness of insulation is 10mm>

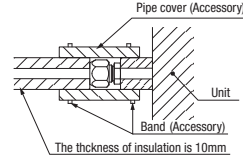

<The case of using reinforced insulation>

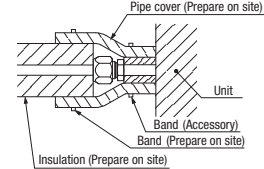

⑥ Drain pipe

Caution

- Install the drain pipe according to the installation manual in order to drain properly. Imperfection in draining may cause flood indoors and wetting the household goods, etc.
- Do not put the drain pipe directly into the ditch where toxic gas such as sulfur, the other harmful and inflammable gas is generated. Toxic gas would flow into the room and it would cause serious damage to user's health and safety (some poisoning or deficiency of oxygen). In addition, it may cause corrosion of heat exchanger and bad smell.
- Connect the pipe securely to avoid water leakage from the joint.
- Insulate the pipe properly to avoid condensation drop.
- Check if the water can flow out properly from both the drain outlet on the indoor unit and the end of the drain pipe after installation.
- Make sure to make descending slope of greater than 1/100 and do not make up-down bend and/or trap in the midway. In addition, do not put air vent on the drain pipe. Check if water is drained out properly from the pipe during commissioning. Also, keep sufficient space for inspection and maintenance.

Work procedure

- Make sure to insert the drain hose (the end mode of soft PVC) to the end of the step part of drain socket. Attach the hose clamp to the drain hose around 10mm from the end, and fasten the screw within 5mm left to the nut.
 - Do not apply adhesives on this end.

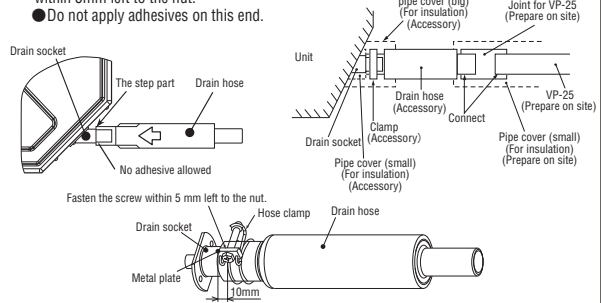

- Prepare a joint for connecting VP-25 pipe, adhere and connect the joint to the drain hose (the end made of rigid PVC), and adhere and connect VP-25 pipe (prepare on site).
 - As for drain pipe, apply VP-25 made of rigid PVC which is on the market.
 - Make sure that the adhesive will not get into the supplied drain hose. It may cause the flexible part broken after the adhesive is dried up and gets rigid.
 - The flexible drain hose is intended to absorb a small difference at installation of the unit or drain pipes. Intentional bending, expanding may cause the flexible hose broken and water leakage.

- As for drain pipe, apply VP25 (OD32). If apply PVC25 (OD25), connect the expanded connector to the drain hose, with adhesive. (Multi unit only)

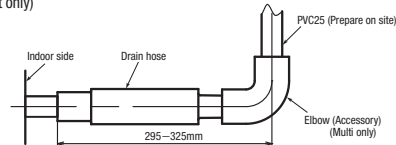

- Make sure to make descending slope of greater than 1/100 and do not make up-down bend and/or trap in the midway.
 - Pay attention not to give stress on the pipe on the indoor unit side, and support and fix the pipe as close place to the unit as possible when connecting the drain pipe.
 - Do not set up air vent.

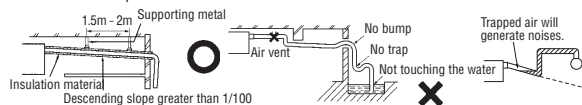

⑥ Drain pipe (continued)

- When sharing a drain pipe for more than one unit, lay the main pipe 100mm below the drain outlet of the unit. In addition, select VP-30 or bigger size for main drain pipe.

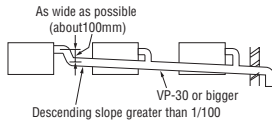

4. Insulate the drain pipe.

- Be sure to insulate the drain socket and rigid PVC pipe installed indoors otherwise it may cause dew condensation and water leakage.
- ※ After drainage test implementation, cover the drain socket part with pipe cover (small size), then use the pipe cover (big size) to cover the pipe cover (small size), clamps and part of the drain hose, and fix and wrap it with tapes to wrap and make joint part gapless.

Drain up

- The position for drain pipe outlet can be raised up to 700mm above the ceiling. Use elbows for installation to avoid obstacles inside ceiling. If the horizontal drain pipe is too long before vertical pipe, the backflow of water will increase when the unit is stopped, and it may cause overflow of water from the drain pan on the indoor unit. In order to avoid overflow, keep the horizontal pipe length and offset of the pipe within the limit shown in the figure below.

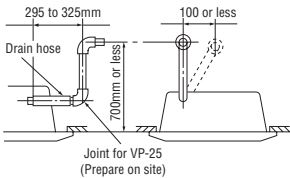

Drain test

- After installation of drain pipe, make sure that drain system work in good condition and no water leakage from joint and drain pan. Check if the motor sound of drain pump is normal or not.
 - Do drain test even if installation of heating season.
 - For new building cases, make sure to complete the test before hanging the ceiling.
1. Fill water of approx. 1,000 cc in the drain pan of the main unit. Take care not to wet electrical equipment such as the drain pump, etc. Inject water through the blow outlet using a feed water pump, or the like, or through the refrigerant pipe joint.

- When injecting water through the blow outlet
- When removing the lid to inject water through the refrigerant joint
 - (1) Remove screws at 2 places.
 - (2) While pressing the lid in the direction ①, pull and remove the lid in the direction ②.
 (Remove the lid by releasing the catches from the hooks in the figure.)

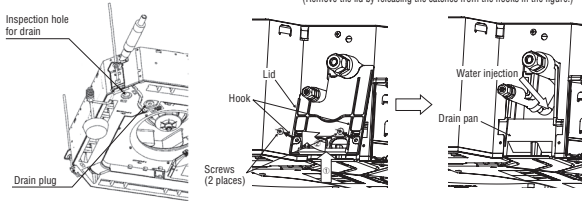

2. Make sure that water is drained out properly and there is no water leakage from any joints of the drain pipe at the test. Confirm that the water is properly drained out while the drain motor is operating. At the drain socket (transparent), it is possible to check if the water is drained out properly.
3. Unplug the drain plug on the indoor unit to remove remaining water on the drain pan after the test, and re-plug it. And insulate the drain pipe properly finally.

Drain pump operation

- In case electrical wiring work finished
Drain pump can be operated by remote control (wired). For the operation method, refer to [Operation for drain pump] in the installation manual for wiring work.
- In case electrical wiring work not finished
Drain pump will run continuously when the dip switch "SW7-1" on the indoor unit PCB is turned ON, the Connector CNB is disconnected, and then the power source (230VAC on the terminal block ① and ②) is turned ON. Make sure to turn OFF "SW7-1" and reconnect the Connector CNB after the test.
- Electrical installation work must be performed according to the installation manual by an electrical installation service provider qualified by a power provider of the country, and be executed according to the technical standards and other regulations applicable to electrical installation in the country.
- Be sure to use an exclusive circuit.
- Use specified cord, fasten the wiring to the terminal securely, and hold the cord securely in order not to apply unexpected stress on the terminal.
- Do not put both power source line and signal line on the same route. It may cause miscommunication and malfunction.
- Be sure to do D type earth work.
- For the details of electrical wiring work, see attached instruction manual for electrical wiring work.

1. Remove a lid of the control box (3 screws) and the wiring cover (2 screws).
2. Hold each wiring inside the unit and fasten them to terminal block securely.
3. Fix the wiring with clamps.
4. Install the removed parts back to original place.

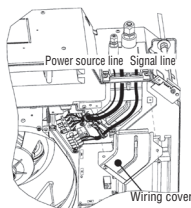

Main fuse specification

Specification	Part No.
T3.15A L250V	SSA564A149AF

⑦ Wiring-out position and wiring connection

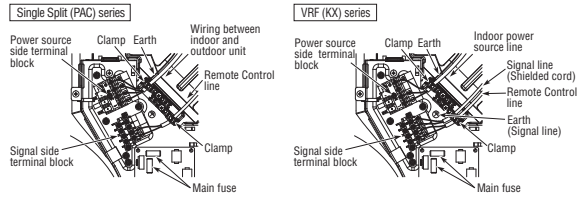

⑧ Panel installation

- Attach the panel on the indoor unit after electrical wiring work.
- Refer to attached manual for panel installation for details.

⑨ Check list after installation

- Check the following items after all installation work completed.

Check if;	Expected trouble	Check
The indoor and outdoor units are fixed securely?	Falling, vibration, noise	
Inspection for leakage is done?	Insufficient capacity	
Insulation work is properly done?	Water leakage	
Water is drained properly?	Water leakage	
Power source voltage is same as mentioned in the model name plate?	PCB burnt out, not working at all	
There is mis-wiring or mis-connection of piping?	PCB burnt out, not working at all	
Earth wiring is connected properly?	Electric shock	
Cable size comply with specified size?	PCB burnt out, not working at all	
Any obstacle blocks airflow on air inlet and outlet?	Insufficient capacity	

⑩ How to check the dirt of drain pan (Maintenance)

The method of checking the dirt of drain pan

- It is possible to check the dirt for inlet of drain pan without detaching the panel. (Inspection is not possible when the high efficient filter and option spacer is installed.)

1. Open the air return grille and remove the panel corner cover on drain pan side.
2. Remove the cover of inspection window. (1screw)
3. Check the drain pan from the inspection window.

If the drain pan is very dirty, remove the drain pan and clean it.

4. After checking of the dirty of drain pan, restore the cover of the inspection window securely. Improper restoration of the cover may cause dew condensation and water leakage.

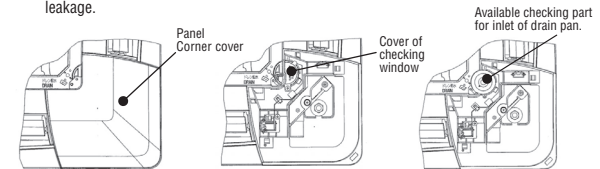

Attention for removing drain pan

- The fixing components have been attached with the drain pan. Pay attention to these components during installation and removing. Take off the hanging hook after removing four screws. During the installation of drain pan, fix the drain pan firmly by using four screws after hanging it up with the fixing hook.

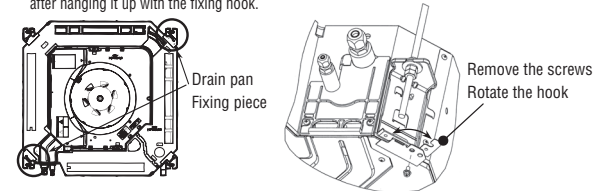

PJF012D003C 

PANEL INSTALLATION MANUAL

Read this manual together with the indoor unit's installation manual.

⚠ WARNING

- Fasten the wiring to the terminal securely and hold the cable securely so as not to apply unexpected stress on the terminal.
Loose connection or hold will cause abnormal heat generation or fire.
- Make sure the power source is turned off when electric wiring work.
Otherwise, electric shock, malfunction and improper running may occur.

① Before installation

- Follow installation manual carefully, and install the panel properly.
- Check the following items.
 - Accessories

Accessories

Bolt		4 pieces	For panel installation
Strap		4 pieces	For avoiding the corner panel from falling
Screw		4 pieces	For fixing the corner panel

Note: Accessories are laid in the position removing the corner panel.

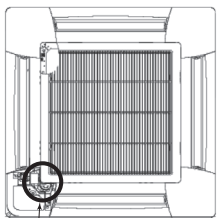

Accessories holding position

② Checking the indoor unit installation position

- Read this manual together with the air-conditioner installation manual carefully.
- Check if the opening size for the indoor unit is correct with the level gauge supplied in the indoor unit.
- Check if the gap between the ceiling plane and the indoor unit is correct by inserting the level gauge into the air outlet port of the indoor unit. (See below drawing)
- Adjust the installation elevation if necessary.

Caution

If there is a height difference beyond the design limit between the installation level of the indoor unit and the ceiling plane, the panel may be subject to excessive stress during installation, it may cause distortion and damage.

- The installation level of the indoor unit can be adjusted finely from the opening provided on the corner, even after panel is attached. (Refer to ⑥ Attaching the panel for details.)

Keep the distance between 20-24mm. Exceeding the range of distance may cause failure etc.

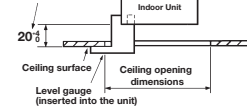

Level gauge (inserted into the unit)

③ Removing the air return grille

1. Hold the stoppers on the air return grille (2 places) toward OPEN direction, open the air return grille.
2. Remove the hooks of the air return grille from the decorative panel while it is in the open position.

<Removal>



Stopper

④ Removing a corner panel

- Pull the corner panel toward the direction indicated by the arrow and remove it. (Same way for all four corner panels)

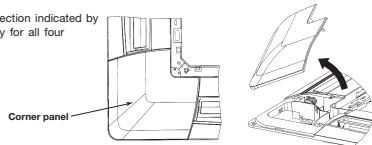

Corner panel

⑤ Orientation of the panel installation

- Take note that there is an orientation to install the panel.
- Attach the panel with the orientation shown on the right.
 - Align the "PIPE SIDE" mark (on the panel) with the refrigerant pipes on the indoor unit.
 - Align the "DRAIN" mark (on the panel) with the drain pipe on the indoor unit.

CAUTION

In case the orientation of the panel is not correct, it will lead to air leakage and also it is not possible to connect the lower motor wiring.

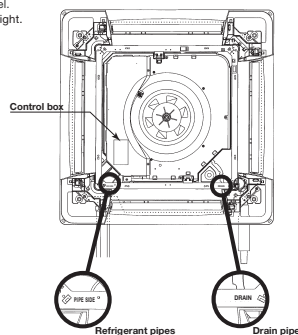

Control box

Refrigerant pipes

Drain pipe

⑥ Attaching the panel

1. Temporary attaching
 - Lift up the hanger (2 places) on the panel for temporary support.
 - Hang the panel on the hook on the indoor unit.

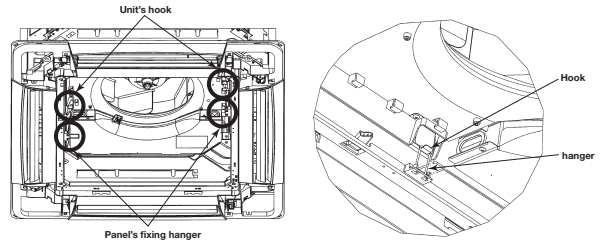

Panel's fixing hanger

2. Fix the panel on the indoor unit
 - Fasten the panel on the indoor unit with the four bolts supplied with the panel.

Caution

Improperly tightened hanging bolts can cause the problems listed below, so make sure that you have tightened them securely.

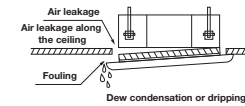

Air leakage
Air leakage along the ceiling
Fouling
Dew condensation or dripping

If there is a gap remaining between the ceiling and the decorative panel even after the hanging bolts are tightened, adjust the installation level of the indoor unit again.



Make sure no gap is left here.

- It is possible to adjust the installation height of the indoor unit with the panel attached as long as there is no influence on the drain pipe inclination and/or the indoor unit levelness.

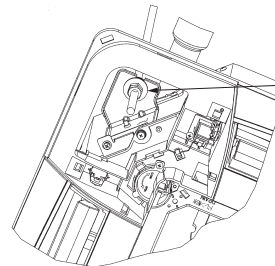

To adjust finely, please turn a nut fastening the indoor unit using a spanner or similar tool from the opening on the corner.

Caution

Make sure there is no stress given on the panel when adjusting the height of the indoor unit to avoid unexpected distortion. It may cause the distortion of panel or failing to close the air return grille.

⑦ Electrical wiring

1. After removing three screws of control box, detach the cover of control box (the hatched part).
2. Connect the connector for lower motor (white 20P).
 - Hold the wiring by using the clamps of the indoor unit.
 - Hold the connector inside the control box.
3. Connect the connector for panel switch.
 - Hold the wiring by using the clamps of the indoor unit.
 - Connect CNV (white) inside the control box.

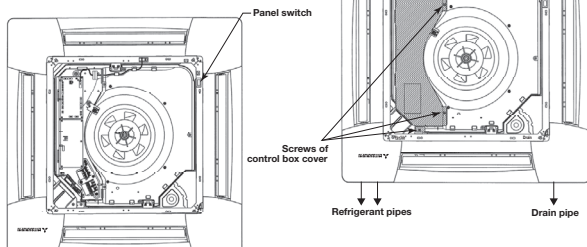

Panel switch

Screws of control box cover

Refrigerant pipes

Drain pipe

Connector for lower motor (white) Clamps of unit main body

To Panel switch

CNV (white)

CAUTION

If the air return grille is opened, the panel switch is turned off so that the air-conditioner cannot be operated any more.
To start the air-conditioner, close the air return grille.

⑧ Attaching a corner panel

1. To avoid unexpected falling of the corner panel, put the strap onto the corner panel's pin with turning the strap up.
2. Then hang the strap of a corner panel onto the decorative panel's pin.
3. First insert the part "a" of a corner panel into the part "A" of the decorative panel, and then engage four hooks.

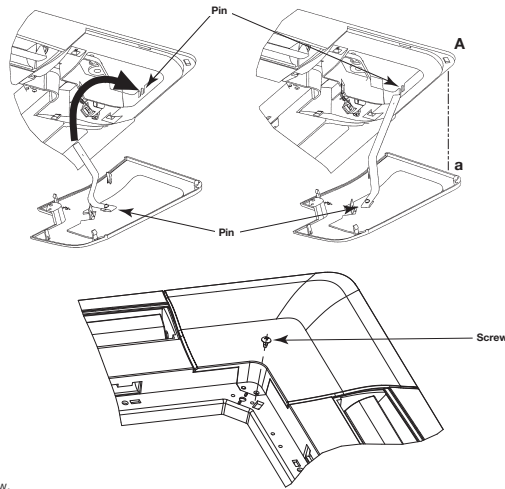

4. Fix with screw.

⑨ How to set the airflow direction

It is possible to change the movable range of the louver on the air outlet from the wired remote control. Once the top and bottom position is set, the louver will swing within the range between the top and the bottom when swing operation is chosen. It is also possible to apply different setting to each louver.

For the setting method of the louver's operating range, refer to the instruction manual of the wired remote control.

If it is necessary to fix the louver position manually, follow the procedure mentioned below.

1. Shut off the main power switch.
2. Unplug the connector of the louver motor which you want to fix the position. Make sure to insulate unplugged connectors electrically with a vinyl tape.
3. Adjust the louver position slowly by hand so as to be within the applicable range mentioned below table.

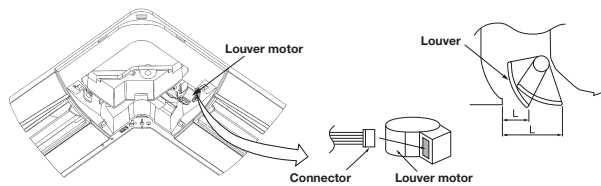

<Range of louver setting>

Vertical airflow direction	Horizontal 0°	Downwards 45°
Dimension L (mm)	43	26

※It can be set between 26-43mm freely.

Caution

- Any automatic control or operation from the remote control will be disabled on the louver whose position is fixed in the above way.
- Do not set a louver beyond the specified range. Failure to observe this instruction may result in dripping, dew condensation, the fouling of the ceiling and the malfunctioning of the unit.

⑩ Attaching the air return grille

To attach the air return grille, follow the procedure described in **⑧ Removing the air return grille** in the reverse order.

1. Hang the hooks of the air return grille in the hole of the panel. (The hooks of the grille can be hung in three side of the panel as following.)
2. After the grille is hanged, close the grille while the stoppers on the grille (2 places) are kept pressed to "OPEN" direction. When the grille comes to the original position, release the stoppers to hold the grille. Make sure to hear the sound of "CLICK" in both stoppers.

<Installation>

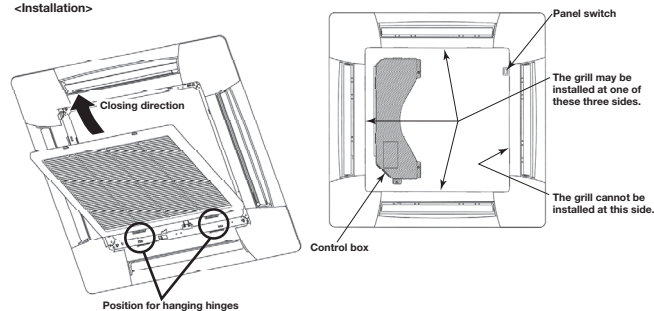

Caution

- Attaching the air return grille from the hinge side.
- Be careful in air return grille attaching, unstable attaching may cause grille falling.
- Repair or replace the distorted, broken stopper at once, or the grille falling may occur.

OUTDOOR AIR (OA) INTAKE FOR FDT

If it is required to intake OA through FDT unit, make sure to check following points carefully in order to conform to the requirement of customer.

If the OA intake volume through FDT unit is not satisfied with the required ventilation air volume, consider to install an independent ventilation system.

- 1) Be sure to calculate cooling/heating load considering the ventilation heat load and to decide the air-conditioning system.
- 2) Be sure the OA intake volume to FDT unit should not exceed 20% of the Supply Air (SA) volume of FDT unit and it should be less than $2\text{m}^3/\text{min}$.
- 3) Be sure to decide the OA intake volume considering the mixed air temperature will be within the usage temperature range of FDT unit.

Especially in following case, please consider to intake OA after processing OA or reducing the OA intake volume.

- 4) Be sure to equip a suitable filter for OA intaken in order to protect the dust.
(Because OA does not pass through the filter equipped on FDT unit)
- 5) Be sure to insulate OA duct.
(If not, it may have dew condensation.)
- 6) Be sure to interlock the booster fan for OA with the fan of FDT unit by using CNT connector.
(If not, the dust trapped on the filter of FDT unit may be blown out to the room by the OA being intaken during the fan of FDT unit stopping)
- 7) Be sure to select a suitable booster fan for OA considering the pressure loss in the OA duct and the pressure loss at the inlet port of FDT with following diagram.
(Please take into consideration the noise level as well)

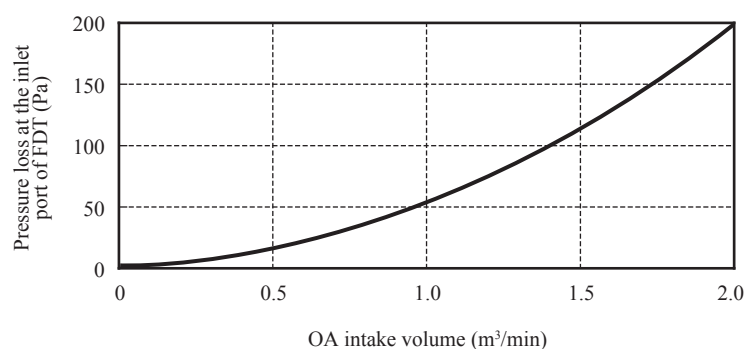
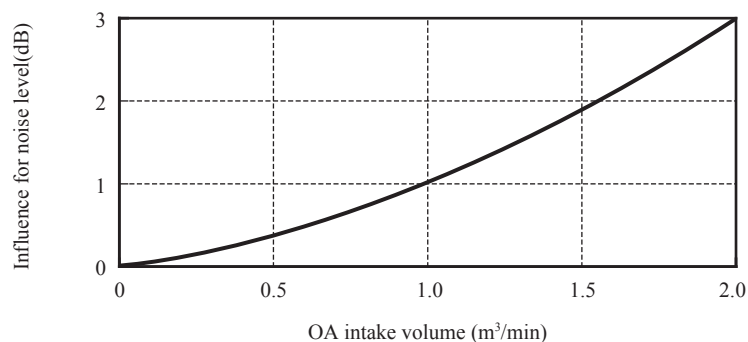

<Selection of booster fan>

Booster fan should have a static pressure calculated with following formula

Static pressure of booster fan

= the pressure loss at the inlet port of FDT (from above diagram)

+ Pressure loss in the OA duct (In case of $\phi 100$ duct, $5\text{Pa}/\text{m}$ is required)

Select the booster fan from the fan characteristic diagram

(2) Ceiling suspended type (FDE)

This manual is for the installation of an indoor unit.
 For electrical wiring work (Indoor), refer to page 76. For remote control installation, refer to page 84. For wireless kit installation, refer to page 219. For electrical wiring work (Outdoor) and refrigerant pipe work installation for outdoor unit, refer to page 98.

SAFETY PRECAUTIONS

- Read the "SAFETY PRECAUTIONS" carefully first of all and then strictly follow it during the installation work in order to protect yourself.
- The precautionary items mentioned below are distinguished into two levels, **⚠️WARNING** and **⚠️CAUTION**.
⚠️WARNING: Wrong installation would cause serious consequences such as injuries or death.
⚠️CAUTION: Wrong installation might cause serious consequences depending on circumstances.
 Both mentions the important items to protect your health and safety so strictly follow them by any means.
- The meanings of "Marks" used here are as shown as follows:
⊘ Never do it under any circumstances. **⚠️** Always do it according to the instruction.
- After completing the installation, do commissioning to confirm there are no abnormalities, and explain to the customers about "SAFETY PRECAUTIONS", correct operation method and maintenance method (air filter cleaning, operation method and temperature setting method) with user's manual of this unit.
 Ask your customers to keep this installation manual together with the user's manual. Also, ask them to hand over the user's manual to the new user when the owner is changed.

⚠️WARNING

- **Installation should be performed by the specialist.** **⚠️**
 If you install the unit by yourself, it may lead to serious trouble such as water leakage, electric shock, fire, and injury due to overturn of the unit.
- **Install the system correctly according to these installation manuals.** **⚠️**
 Improper installation may cause explosion, injury, water leakage, electric shock, and fire.
- **When installing in small rooms, take prevention measures not to exceed the density limit of refrigerant in the event of leakage, referred by the formula (accordance with ISO5149).** **⚠️**
 If the density of refrigerant exceeds the limit, please consult the dealer and install the ventilation system, otherwise lack of oxygen can occur, which can cause serious accidents.
- **Use the genuine accessories and the specified parts for installation.** **⚠️**
 If parts unspecified by our company are used it could cause water leakage, electric shock, fire, and injury due to overturn of the unit.
- **Ventilate the working area well in case the refrigerant leaks during installation.** **⚠️**
 If the refrigerant contacts the fire, toxic gas is produced.
- **Install the unit in a location that can hold heavy weight.** **⚠️**
 Improper installation may cause the unit to fall leading to accidents.
- **Install the unit properly in order to be able to withstand strong winds such as typhoons, and earthquakes.** **⚠️**
 Improper installation may cause the unit to fall leading to accidents.
- **Do not mix air in to the cooling cycle on installation or removal of the air-conditioner.** **⊘**
 If air is mixed in, the pressure in the cooling cycle will rise abnormally and may cause explosion and injuries.
- **Be sure to have the electrical wiring work done by qualified electrical installer, and use exclusive circuit.** **⚠️**
 Power source with insufficient capacity and improper work can cause electric shock and fire.
- **Use specified wire for electrical wiring, fasten the wiring to the terminal securely, and hold the cable securely in order not to apply unexpected stress on the terminal.** **⚠️**
 Loose connections or hold could result in abnormal heat generation or fire.
- **Arrange the electrical wires in the control box properly to prevent them from rising. Fit the lid of the services panel properly.** **⚠️**
 Improper fitting may cause abnormal heat and fire.
- **Check for refrigerant gas leakage after installation is completed.** **⚠️**
 If the refrigerant gas leaks into the house and comes in contact with a fan heater, a stove, or an oven, toxic gas is produced.
- **Use the specified pipe, flare nut, and tools for R410A.** **⚠️**
 Using existing parts (R22) could cause the unit failure and serious accident due to explosion of the cooling cycle.
- **Tighten the flare nut according to the specified method by with torque wrench.** **⚠️**
 If the flare nut were tightened with excess torque, it could cause burst and refrigerant leakage after a long period.
- **Do not put the drainage pipe directly into drainage channels where poisonous gases such as sulfide gas can occur.** **⊘**
 Poisonous gases will flow into the room through drainage pipe and seriously affect the user's health and safety. This can also cause the corrosion of the indoor unit and a resultant unit failure or refrigerant leak.
- **Connect the pipes for refrigeration circuit securely in installation work before compressor is operated.** **⚠️**
 If the compressor is operated when the service valve is open without connecting the pipe, it could cause explosion and injuries due to abnormal high pressure in the system.
- **Stop the compressor before removing the pipe after shutting the service valve on pump down work.** **⚠️**
 If the pipe is removed when the compressor is in operation with the service valve open, air would be mixed in the refrigeration circuit and it could cause explosion and injuries due to abnormal high pressure in the cooling cycle.
- **Only use prescribed option parts. The installation must be carried out by the qualified installer.** **⚠️**
 If you install the system by yourself, it can cause serious trouble such as water leaks, electric shocks, fire.
- **Do not repair by yourself. And consult with the dealer about repair.** **⊘**
 Improper repair may cause water leakage, electric shock or fire.
- **Consult the dealer or a specialist about removal of the air-conditioner.** **⚠️**
 Improper installation may cause water leakage, electric shock or fire.
- **Turn off the power source during servicing or inspection work.** **⚠️**
 If the power is supplied during servicing or inspection work, it could cause electric shock and injury by the operating fan.
- **Do not run the unit when the panel or protection guard are taken off.** **⊘**
 Touching the rotating equipment, hot surface, or high voltage section could cause an injury to be caught in the machine, to get burned, or electric shock.
- **Shut off the power before electrical wiring work.** **⚠️**
 It could cause electric shock, unit failure and improper running.

⚠️CAUTION

- **Perform earth wiring surely.** **⚠️**
 Do not connect the earth wiring to the gas pipe, water pipe, lightning rod and telephone earth wiring. Improper earth could cause unit failure, electric shock and fire due to a short circuit.
- **Earth leakage breaker must be installed.** **⚠️**
 If the earth leakage breaker is not installed, it can cause fire and electric shocks.
- **Use the circuit breaker of correct capacity. Circuit breaker should be the one that disconnect all poles under over current.** **⚠️**
 Using the incorrect one could cause the system failure and fire.
- **Do not use any materials other than a fuse of correct capacity where a fuse should be used.** **⊘**
 Connecting the circuit by wire or copper wire could cause unit failure and fire.
- **Do not install the indoor unit near the location where there is possibility of flammable gas leakages.** **⊘**
 If the gas leaks and gathers around the unit, it could cause fire.
- **Do not install and use the unit where corrosive gas (such as sulfurous acid gas etc.) or flammable gas (such as thinner, petroleum etc.) may be generated or accumulated, or volatile flammable substances are handled.** **⊘**
 It could cause the corrosion of heat exchanger, breakage of plastic parts etc. And inflammable gas could cause fire.
- **Secure a space for installation, inspection and maintenance specified in the manual.** **⚠️**
 Insufficient space can result in accident such as personal injury due to falling from the installation place.
- **Do not use the indoor unit at the place where water splashes such as laundry.** **⊘**
 Indoor unit is not waterproof. It could cause electric shock and fire.
- **Do not use the indoor unit for a special purpose such as food storage, cooling for precision instrument, preservation of animals, plants, and a work of art.** **⊘**
 It could cause the damage of the items.
- **Do not install nor use the system near equipments which generate electromagnetic wave or high harmonics.** **⊘**
 Equipments like inverter equipment, private power generator, high-frequency medical equipment, or telecommunication equipment might influence the air-conditioner and cause a malfunction and breakdown. Or the air-conditioner might influence medical equipments or telecommunication equipments, and obstruct their medical activity or cause jamming.
- **Do not install the remote control at the direct sunlight.** **⊘**
 It could cause breakdown or deformation of the remote control.
- **Do not install the indoor unit at the place listed below.** **⊘**
 - Places where flammable gas could leak.
 - Places where carbon fiber, metal powder or any powder is floated.
 - Places where cosmetics or special sprays are frequently used.
 - Place where the substances which affect the air-conditioner are generated such as sulfide gas, chloride gas, acid, alkali or ammonia atmospheres.
 - Places where the system is affected by smoke from a chimney.
 - Places exposed to oil mist or steam directly.
 - On vehicles and ships.
 - Places where machinery which generates high harmonics is used.
 - Highly salted area such as beach.
 - Heavy snow area.
 - Altitude over 1000m
- **Do not install the indoor unit in the locations listed below (Be sure to install the indoor unit according to the installation manual for each model because each indoor unit has each limitation)** **⊘**
 - Locations with any obstacles which can prevent inlet and outlet air of the unit
 - Locations where vibration can be amplified due to insufficient strength of structure.
 - Locations where the infrared receiver is exposed to the direct sunlight or the strong light beam. (in case of the infrared specification unit)
 - Locations where an equipment affected by high harmonics is placed. (TV set or radio receiver is placed within 5m)
 - Locations where drainage cannot run off safely.
 - It can affect performance or function and etc..
- **Do not put any valuables which will break down by getting wet under the air-conditioner.** **⊘**
 Condensation could drop when the relative humidity is higher than 80% or drain pipe is clogged, and it damages user's belongings.
- **Do not use the base frame for the outdoor unit which is corroded or damaged after a long period of use.** **⊘**
 It could cause the unit falling down and injury.
- **Pay attention not to damage the drain pan by weld sputter when brazing work is done near the unit.** **⚠️**
 If sputter entered into the unit during brazing work, it could cause damage (pinhole) of drain pan and leakage of water. To avoid damaging, keep the indoor unit packed or cover the indoor unit.
- **Install the drain pipe to drain the water surely according to the installation manual.** **⚠️**
 Improper connection of the drain pipe may cause dropping water into room and damaging user's belongings.
- **Do not share the drain pipe for indoor unit and GHP (Gas Heat Pump system) outdoor unit.** **⊘**
 Toxic exhaust gas would flow into room and it might cause serious damage (some poisoning or deficiency of oxygen) to user's health and safety.
- **Be sure to perform air tightness test by pressurizing with nitrogen gas after completed refrigerant piping work.** **⚠️**
 If the density of refrigerant exceeds the limit in the event of refrigerant leakage in the small room, lack of oxygen can occur, which can cause serious accidents.
- **For drain pipe installation, be sure to make descending slope of greater than 1/100, not to make traps, and not to make air-bleeding.** **⊘**
 Check if the drainage is correctly done during commissioning and ensure the space for inspection and maintenance.
- **Ensure the insulation on the pipes for refrigeration circuit so as not to condense water.** **⚠️**
 Incomplete insulation could cause condensation and it would wet ceiling, floor, and any other valuables.
- **Do not install the outdoor unit where is likely to be a nest for insects and small animals.** **⊘**
 Insects and small animals could come into the electronic components and cause breakdown and fire. Instruct the user to keep the surroundings clean.
- **Pay extra attention, carrying the unit by hand.** **⚠️**
 Carry the unit with 2 people if it is heavier than 20kg. Do not use the plastic straps but the grabbing place, moving the unit by hand. Use protective gloves in order to avoid injury by the aluminum fin.
- **Make sure to dispose of the packaging material.** **⚠️**
 Leaving the materials may cause injury as metals like nail and woods are used in the package.
- **Do not operate the system without the air filter.** **⊘**
 It may cause the breakdown of the system due to clogging of the heat exchanger.
- **Do not touch any button with wet hands.** **⊘**
 It could cause electric shock.
- **Do not touch the refrigerant piping with bare hands when in operation.** **⊘**
 The pipe during operation would become very hot or cold according to the operating condition, and it could cause a burn or frostbite.
- **Do not clean up the air-conditioner with water.** **⊘**
 It could cause electric shock.
- **Do not turn off the power source immediately after stopping the operation.** **⊘**
 Be sure to wait for more than 5 minutes. Otherwise it could cause water leakage or breakdown.
- **Do not control the operation with the circuit breaker.** **⊘**
 It could cause fire or water leakage. In addition, the fan may start operation unexpectedly and it may cause injury.

① Before installation

- Install correctly according to the installation manual.
- Confirm the following points:
 - Unit type/Power source specification
 - Pipes/Wires/Small parts
 - Accessory items

Accessory item

For unit hanging		For refrigerant pipe				For drain pipe					For return pipe
Flat washer (M10)	Paper pattern	Pipe cover (large)	Pipe cover (small)	Strap	Drain hose (with clamp)	Hose clamp	Fixing bracket	Screw	Heat insulation	Screw	
8	1	1	1	4	1	1	1	2	1	4	
For unit hanging and adjustment	For heat insulation of gas pipe	For heat insulation of liquid pipe	For fixing of pipe cover	For drain pipe connection	For drain hose mounting	For fixing of drain hose	For installing of fixing bracket	For drain hose	For fixing air return grille		

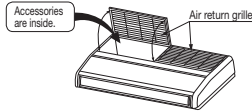

② Selection of installation location for the indoor unit

- Select the suitable areas to install the unit under approval of the user.
 - Areas where the indoor unit can deliver hot and cold wind sufficiently. Suggest to the user to use a circulator if the ceiling height is over 3m to avoid warm air being accumulated on the ceiling.
 - Areas where there is enough space to install and service.
 - Areas where it can be drained properly. Areas where drain pipe descending slope can be taken.
 - Areas where there is no obstruction of airflow on both air return grille and air supply port.
 - Areas where fire alarm will not be accidentally activated by the air-conditioner.
 - Areas where the supply air does not short-circuit.
 - Areas where it is not influenced by draft air.
 - Areas not exposed to direct sunlight.
 - Areas where dew point is lower than around 23°C and relative humidity is lower than 80%. This indoor unit is tested under the condition of JIS (Japan Industrial Standard) high humidity condition and confirmed there is no problem. However, there is some risk of condensation drop if the air-conditioner is operated under the severer condition than mentioned above.
 - Areas where TV and radio stays away more than 1m. (It could cause jamming and noise.)
 - Areas where any items which will be damaged by getting wet are not placed such as food, table wares, server, or medical equipment under the unit.
 - Areas where there is no influence by the heat which cookware generates.
 - Areas where not exposed to oil mist, powder and/or steam directly such as above fryer.
- Check if the place where the air-conditioner is installed can hold the weight of the unit. If it is not able to hold, reinforce the structure with boards and beams strong enough to hold it. If the strength is not enough, it could cause injury due to unit falling.
- When plural indoor units are installed nearby, keep them away for more than 4 to 5m.

Space for installation and service

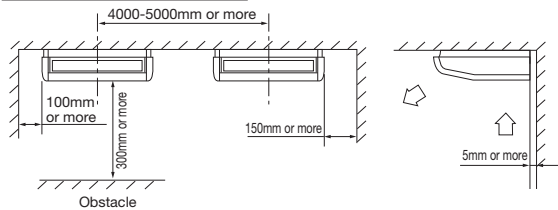

③ Preparation before installation

- If suspension bolt becomes longer, do reinforcement of earthquake resistant.
 - For grid ceiling
 - When suspension bolt length is over 500mm, or the gap between the ceiling and roof is over 700mm, apply earthquake resistant brace to the bolt.
 - In case the unit is hanged directly from the slab and is installed on the ceiling plane which has enough strength.
 - When suspension bolt length is over 1000mm, apply the earthquake resistant brace to the bolt.
- Prepare four (4) sets of suspension bolt, nut and spring washer (M10) on site.

Pitch of suspension bolts and pipe position

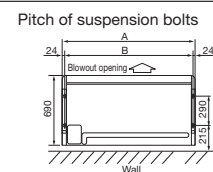

Location of pipe outlets

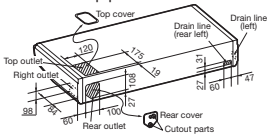

③ Preparation before installation (continued)

Series	type	(mm)	
		A	B
Single Split (PAC) series	40 to 50type	1070	1022
	60 to 71type	1320	1272
	100 to 140type	1620	1572
VRF (KX) series	36 to 56type	1070	1022
	71type	1320	1272
	112 to 140type	1620	1572

Pipe position

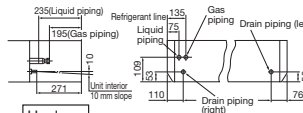

Haulage

- Move the box as close to the installation area as possible packed.
- If it must be unpacked, wrap the unit with a nylon sling, and be careful not to damage the unit.
 - ※ Do not hold fragile plastic parts, such as the side panel, blow louver, etc.
- If you need to lay the unit on a floor after unpacking, always put it with the intake grille facing upward.



Preparation before installation

- Remove the air return grille.**
 - Slide stoppers (4 places) of the catches, then pull out the pins (4 or 6 places).
- Remove the side panel.**
 - Remove the screw and detach the side panel by sliding it toward the direction indicated by the arrow mark.
- Remove the hanging plate.**
 - Remove the screw, and then loosen the fixing bolts.

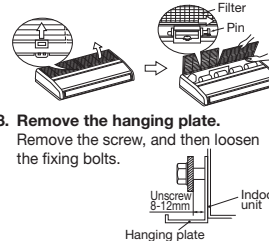

④ Installation of indoor unit

Work procedure

- Select the suspension bolt locations and the pipe hole location.
 - Use enclosed paper pattern as a reference, and drill the holes for the suspension bolts and pipe.
 - ※ Decide the locations based on direct measurements.
 - Once the locations are properly placed, the paper pattern can be removed.
- Install the suspension bolts in place.
- Fix with 4 suspension bolts, which can endure load of 500N.
- Check the measurements given at the right figure for the length of the suspension bolts.
- Fasten the hanging plate onto the suspension bolts.

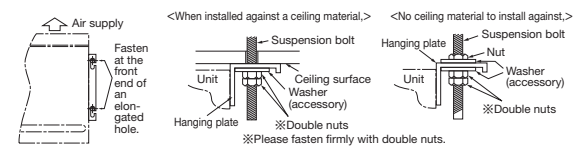

- Install the unit to the hanging plate. (See the figure at right.)

- Slide the unit in from front side to get it hanged on the hanging plate with the bolts.
- Fasten the four fixing bolts (M8: 2 each on the left and right sides) firmly.
- Fasten the two screws (M4: 1 each on the left and right sides).

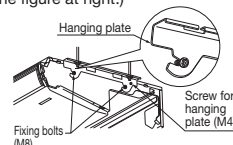

⚠ WARNING : Hang a side panel on from the panel side to the rear side and then fasten it securely onto the indoor unit with screws.

※ To ensure smooth drain flow, install the unit with a descending slope toward the drain outlet.

⚠ CAUTION : Do not give the reversed slope, which may cause water leaks.

⑤ Refrigerant pipe

Caution

- Be sure to use new pipes for the refrigerant pipes. Use the flare nut attached to the product or a nut compatible with JIS B 8607, Class 2.
Regarding whether existing pipes can be reused or not, and the washing method, refer to the instruction manual of the outdoor unit, catalogue or technical data.
- 1) In case of reuse: Do not use old flare nut, but use the one attached to the unit or compatible with JIS B 8607, Class 2.
- 2) In case of reuse: Flare the end of pipe replaced partially for R410A.

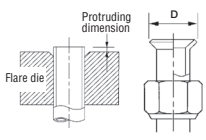

Pipe dia. d mm	Min. pipe wall thickness mm	Protruding dimension for flare, mm		Flare O.D. D mm	Flare nut tightening torque N·m
		Rigid (Clutch type) For R410A	Conventional tool		
6.35	0.8	0 - 0.5	0.7 - 1.3	8.9 - 9.1	14 - 18
9.52	0.8			12.8 - 13.2	24 - 42
12.7	0.8			16.2 - 16.6	49 - 61
15.88	1			19.3 - 19.7	68 - 82
19.05	1.2			23.6 - 24.0	100 - 120

- Use phosphorus deoxidized copper alloy seamless pipe (C1220T specified in JIS H 3300) for refrigeration pipe installation. In addition, make sure there is no damage both inside and outside of the pipe, and no harmful substances such as sulfur, oxide, dust or a contaminant stuck on the pipes.
- Do not use any refrigerant other than R410A.
- Using other refrigerant except R410A (R22 etc.) may degrade inside refrigeration oil. And air getting into refrigeration circuit may cause over-pressure and resultant it may result in bursting, etc.
- Store the copper pipes indoors and seal the both end of them until they are brazed in order to avoid any dust, dirt or water getting into pipe. Otherwise it will cause degradation of refrigeration oil and compressor breakdown, etc.
- Use special tools for R410A refrigerant.

Work procedure

- Remove the flare nut and blind flanges on the pipe of the indoor unit.
 - ※ Make sure to loosen the flare nut with holding the nut on pipe side with a spanner and giving torque to the nut with another spanner in order to avoid unexpected stress to the copper pipe, and then remove them. (Gas may come out at this time, but it is not abnormal.)
 - Pay attention whether the flare nut pops out. (as the indoor unit is sometimes pressurized.)
- Make a flare on liquid pipe and gas pipe, and connect the refrigeration pipes on the indoor unit.
 - When pulling out pipes backward or upward, install them passing through the attached cover together with the electrical cabling.
 - Seal the gap with putty, or other, to protect from dust, etc.
 - ※ Bend radius of pipe must be 4D or larger. Once a pipe is bent, do not readjust the bending. Do not twist a pipe or collapse to 2/3D or smaller.
 - ※ Do a flare connection as follows:
 - Make sure to loosen the flare nut with holding the nut on pipe side with a spanner and giving torque to the nut with another spanner in order to avoid unexpected stress to the copper pipe, and then remove them.
 - When fastening the flare nut, align the refrigeration pipe with the center of flare nut, screw the nut for 3-4 times by hand and then tighten it by spanner with the specified torque mentioned in the table above. Make sure to hold the pipe on the indoor unit securely by a spanner when tightening the nut in order to avoid unexpected stress on the copper pipe.
- Cover the flare connection part of the indoor unit with attached insulation material after a gas leakage inspection, and tighten both ends with attached straps.
 - Make sure to insulate both gas pipes and liquid pipes completely.
 - ※ Incomplete insulation may cause dew condensation or water drooping.
 - Use heat-resistant (120 °C or more) insulations on the gas side pipes.
 - In case of using at high humidity condition, reinforce insulation of refrigerant pipes. Surface of insulation may cause dew condition or water drooping, if insulations are not reinforced.
- Refrigerant is charged in the outdoor unit.
As for the additional refrigerant charge for the indoor unit and piping, refer to the installation manual attached to the outdoor unit.

Caution:
Refrigerating machine oil should not be applied to the threads of union or external surface of flare. It is because, even if the same tightening torque is applied, the oil is likely to decrease the slide friction force on the threads and increase, in turn, the axial component force so that it could crack the flare by the stress corrosion.
Refrigerating machine oil may be applied to the internal surface of flare only.

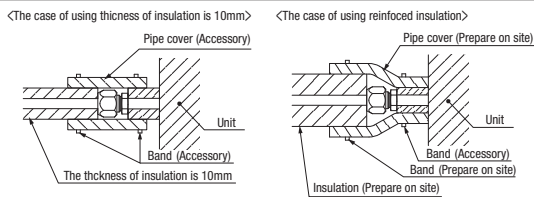

The pipe can be connected from three different directions. (back, right, top)

- When the pipe is routed through the back.
If the bracket is removed, piping work will become easy.
※ After piping, reinstall the removed bracket.

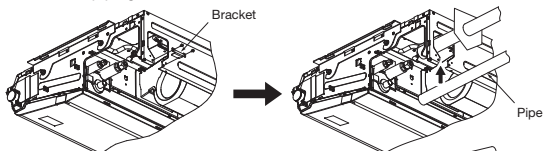

- When the pipe is routed through the top.
Cut the removed top cover, and install to the rear panel instead of rear cover.

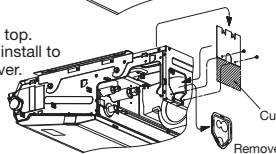

⑥ Drain pipe

Caution

- The drain pipes may pull out either from back, right or left side.
- Install the drain pipe according to the installation manual in order to drain properly. Imperfection in draining may cause flood indoors and wetting the household goods, etc.
- Do not put the drain pipe directly into the ditch where toxic gas such as sulfur, the other harmful and inflammable gas is generated. Toxic gas would flow into the room and it would cause serious damage to user's health and safety (some poisoning or deficiency of oxygen). In addition, it may cause corrosion of heat exchanger and bad smell.
- Connect the pipe securely to avoid water leakage from the joint.
- Insulate the pipe properly to avoid condensation drop.
- Check if the water can flow out properly from both the drain outlet on the indoor unit and the end of the drain pipe after installation.
- Make sure to make descending slope of greater than 1/100 and do not make up-down bend and/or trap in the midway. In addition, do not put air vent on the drain pipe. Check if water is drained out properly from the pipe during commissioning. Also, keep sufficient space for inspection and maintenance.

Work procedure

- Insert drain hose completely to the base, and tighten the drain hose clamp securely. (adhesive must not be used.)
 - ※ When plumbing on the left side, move the rubber plug and the cylindrical insulating materials by the pipe connecting hole on the left side of the unit to the right side.
 - ⚠ Beware of a possible outflow of water that may occur upon removal of a drain plug.
- Fix the drain hose at the lowest point with a hose clamp supplied as an accessory.
 - ※ Give a drain hose a gradient of 10mm as illustrated in the right drawing by laying it without leaving a slack.
 - Take head of electrical cables so that they may not run beneath the drain hose.
 - ⚠ A drain hose must be clamped down with a hose clamp. There is a possibility that drain water overflows.
- Connect VP-20 (prepare on site) to drain hose. (adhesive must not be used.)
 - ※ Use commercially available rigid PVC general pipe VP-20 for drain pipe.
- Do not to make the up-down bending and trap in the mid-way while assuming that the drain pipes is downhill. (more than 1/100)
 - Never set up air vent.
- Insulate the drain pipe.
 - Insulate the drain hose clamp with the heat insulation supplied as accessories.
 - When the unit is installed in a humid place, consider precautions against dew condensation such as heat insulation for the drain pipe.

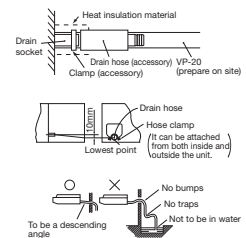

Drain test

- After installation of drain pipe, make sure that drain system work in good condition and no water leakage from joint and drain pan.
- Do drain test even if installation of heating season.

⑦ Wiring-out position and wiring connection

- Electrical installation work must be performed according to the installation manual by an electrical installation service provider qualified by a power provider of the country, and be executed according to the technical standards and other regulations applicable to electrical installation in the country. Be sure to use an exclusive circuit.
- Use specified cord, fasten the wiring to the terminal securely, and hold the cord securely in order not to apply unexpected stress on the terminal.
- Be sure to do D type earth work.
- For the details of electrical wiring work, see attached instruction manual for electrical wiring work.

- Remove wiring from clips.
- Remove the control box (Screw ①, ② pcs).
- Pull out the control box by sliding along the groove on the bracket (Direction A → B).
- Remove the lid of control box (Screw ②, ② pcs).
- Hold each wiring inside the unit and connect to the terminal block surely.
- Fix the wiring by clamp.
- Install the lid of control box (Screw ②, ② pcs).
- Return the control box to the original place by sliding along the groove on the bracket (Direction B → A).
- Install the removed parts at their original places.

- ※ 1 Wiring for the signal receiving section of wireless kit (Option) are connected to the X and Y terminals on the terminal block (the site connection side), when the indoor unit is shipped from the factory. It is not necessary to disconnect these wiring when wired remote control is connected. When the wired/wireless kits are used together, it becomes necessary to set the slaves and remote control.

⑦ Wiring-out position and wiring connection (continued)

-
- Control box Sliding Method

※Disconnect each wiring from clips before pulling out the control box.
- Control box hook

※Install it as to fit the form of control box.
- Lid of control box
- Single split (PAC) Series

VRF (KX) Series
- Indoor power source line

⑧ Control mode switching

• The control content of indoor units can be switched in following way. (is the default setting)

Switch No.	Control Content
SW8-4	ON Indoor unit silent mode
	OFF Normal operation

⑨ Attaching the air return grille

• The air return grille must be attached when electrical cabling work is completed.

- Fix the chains tied to the air return grille onto the indoor unit with screws supplied as accessories (4 pieces).
- Close the air return grille. This completes the unit installation work.

Fix with screws

Chain

Fixed section of chain

⑩ Check list after installation

• Check the following items after all installation work completed.

Check if	Expected trouble	Check
The indoor and outdoor units are fixed securely?	Falling, vibration, noise	
Inspection for leakage is done?	Insufficient capacity	
Insulation work is properly done?	Water leakage	
Water is drained properly?	Water leakage	
Power source voltage is same as mentioned in the model name plate?	PCB burnt out, not working at all	
There is mis-wiring or mis-connection of piping?	PCB burnt out, not working at all	
Earth wiring is connected properly?	Electric shock	
Cable size comply with specified size?	PCB burnt out, not working at all	
Any obstacle blocks airflow on air inlet and outlet?	Insufficient capacity	

⑪ How to set the airflow direction

It is possible to change the movable range of the louver on the air outlet from the wired remote control. Once the top and bottom position is set, the louver will swing within the range between the top and the bottom when swing operation is chosen. It is also possible to apply different setting to each louver.

- Stop the air-conditioner and press **SET** button and **LOUVER** button simultaneously for three seconds or more.

 - The following is displayed if the number of the indoor units connected to the remote control is one. Go to step 4.
 - The following is displayed if the number of the indoor units connected to the remote control are more than one.

2•4•6•8 1

3•5•7•9
- Press **▲** or **▼** button. (selection of indoor unit) • Select the indoor unit of which the louver is set.

[EXAMPLE] 1/0001 ▲ 1/0001 ▼ 1/0002 ◀ ▶
- Press **○** SET button. (determination of indoor unit) • Selected indoor unit is fixed.

[EXAMPLE] 1/0001 (displayed for two seconds)

"DATA LOADING"

"No.1"
- Press **▲** or **▼** button. (selection of louver No.) • Select the louver No. to be set according to the right figure.

[EXAMPLE] No.1 ▲ No.2 ▼ No.3 ◀ ▶ No.4
- Press **○** SET button. (Determination of louver No.)

 - The louver No. to be set is confirmed and the display shows the upper limit of the movable range.

[EXAMPLE] If No.1 louver is selected, No.1 UPPER ◀ (current upper limit position)
- Press **▲** or **▼** button. (selection of upper limit position)

 - Select the upper limit of louver movable range. "position 1" is the most horizontal, and "position 6" is the most downward. "position --" is to return to the factory setting. If you need to change the setting to the default setting, use "position --".

(horizontal) ①

②

③

④

⑤

⑥ (downwards)

the position of the louver
- Press **○** SET button. (Fixing of the upper limit position)

 - The upper limit position is fixed and the setting position is displayed for two seconds. Then proceed to lower limit position selection display.

[EXAMPLE] No.1 UPPER (displayed for two seconds)

No.1 LOUVER ◀ (shows current setting)
- Press **▲** or **▼** button. (Selection of lower limit position)

 - Select the lower limit position of louver. "position 1" is the most horizontal, and "position 6" is the most downwards. "position --" is to return to the factory setting. If you need to change the setting to the default setting, use "position --".

No.1 LOUVER 1 (the most horizontal)

No.1 LOUVER 2

No.1 LOUVER 3

No.1 LOUVER 4

No.1 LOUVER 5

No.1 LOUVER 6 (the most downwards)

No.1 LOUVER -- (return to the default setting)
- Press **○** SET button. (Fixing of the lower limit position)

 - Upper limit position and lower limit position are fixed, and the set positions are displayed for two seconds, then setting is completed.
 - After the setting is completed, the louver which was set moves from the original position to the lower limit position, and goes back to the original position again. (This operation is not performed if the indoor unit and/or indoor unit fan is in operation.)

[Example] No.1 U2 L6 (displayed for two seconds)

SET COMPLETE

No.1 ▲

Upper position ①

Movable range ② ③ ④ ⑤ ⑥

Lower position
- Press **○ON/OFF** button.

 - Louver adjusting mode ends and returns to the original display.

Caution

If the upper limit position number and the lower limit position number are set to the same position, the louver is fixed at that position auto swing does not function.

ATTENTION

If you press **○RESET** button during settings, the display will return to previous display. If you press **○ON/OFF** button during settings, the mode will be ended and return to original display, and the settings that have not been completed will become invalid.

When plural remote controls are connected, louver setting operation cannot be set by slave remote control.

(3) Duct connected-High static pressure type (FDU)

- This manual is for installation of an indoor unit and an outdoor air processing unit (FDU-F).
- This manual is for the installation of an indoor unit.
- For electrical wiring work (Indoor), refer to page 84. For remote control installation, refer to page 76.
- For wireless kit installation, refer to page 223. For electrical wiring work (Outdoor) and refrigerant pipe work installation for outdoor unit, refer to page 98.

The case of FDU-F

- The total connection capacity of the other air-conditioning units and the outdoor air processing units must be from 50% to 100% (the total includes the outdoor air processing unit). The connection capacity of the outdoor air processing unit must not exceed 30% of the capacity of the outdoor unit.
- Single outdoor air processing unit can be used alone. The connection capacity of the outdoor air processing unit must be from 50% to 100% of the total capacity of the outdoor unit. Maximum number of outdoor air processing units that can be connected to the outdoor unit is 2units.
- Capacities of the suction air processing units can be calculated with the following formulas.
FDU850FKXEZ1 = 90, FDU1100FKXEZ1 = 140

SAFETY PRECAUTIONS

- Read the "SAFETY PRECAUTIONS" carefully first of all and then strictly follow it during the installation work in order to protect yourself.
- The precautionary items mentioned below are distinguished into two levels, [WARNING] and [CAUTION].
[WARNING]: Wrong installation would cause serious consequences such as injuries or death.
[CAUTION]: Wrong installation might cause serious consequences depending on circumstances.
Both mention the important items to protect your health and safety so strictly follow them by any means.
- The meanings of "Marks" used here are as shown on the right:
[S] Never do it under any circumstances. [I] [E] Always do it according to the instruction.
- After completing the installation, do commissioning to confirm there are no abnormalities, and explain to the customers about "SAFETY PRECAUTIONS", correct operation method and maintenance method (air filter cleaning, operation method and temperature setting method) with user's manual of this unit. Ask your customers to keep this installation manual together with the user's manual. Also, ask them to hand over the user's manual to the new user when the owner is changed.

WARNING

- **Installation should be performed by the specialist.**
If you install the unit by yourself, it may lead to serious trouble such as water leakage, electric shock, fire, and injury due to overturn of the unit. [I]
- **Install the system correctly according to these installation manuals.**
Improper installation may cause explosion, injury, water leakage, electric shock, and fire. [I]
- **Check the density referred by the formula (accordance with ISO5149).**
If the density exceeds the limit density, please consult the dealer and installate the ventilation system. [I]
- **Use the genuine accessories and the specified parts for installation.**
If parts unspecified by our company are used it could cause water leakage, electric shock, fire, and injury due to overturn of the unit. [I]
- **Ventilate the working area well in case the refrigerant leaks during installation.**
If the refrigerant contacts the fire, toxic gas is produced. [I]
- **Install the unit in a location that can hold heavy weight.**
Improper installation may cause the unit to fall leading to accidents. [I]
- **Install the unit properly in order to be able to withstand strong winds such as typhoons, and earthquakes.**
Improper installation may cause the unit to fall leading to accidents. [I]
- **Do not mix air in to the cooling cycle on installation or removal of the air-conditioner.**
If air is mixed in, the pressure in the cooling cycle will rise abnormally and may cause explosion and injuries. [I]
- **Be sure to have the electrical wiring work done by qualified electrical installer, and use exclusive circuit.**
Power source with insufficient capacity and improper work can cause electric shock and fire. [I]
- **Use specified wire for electrical wiring, fasten the wiring to the terminal securely, and hold the cable securely in order not to apply unexpected stress on the terminal.**
Loose connections or hold could result in abnormal heat generation or fire. [I]
- **Arrange the electrical wires in the control box properly to prevent them from rising. Fit the lid of the services panel properly.**
Improper fitting may cause abnormal heat and fire. [I]
- **Check for refrigerant gas leakage after installation is completed.**
If the refrigerant gas leaks into the house and comes in contact with a fan heater, a stove, or an oven, toxic gas is produced. [I]
- **Use the specified pipe, flare nut, and tools for R410A.**
Using existing parts (R22) could cause the unit failure and serious accident due to explosion of the cooling cycle. [I]
- **Tighten the flare nut according to the specified method by with torque wrench.**
If the flare nut were tightened with excess torque, it could cause burst and refrigerant leakage after a long period. [I]
- **Do not put the drainage pipe directly into drainage channels where poisonous gases such as sulfide gas can occur.**
Poisonous gases will flow into the room through drainage pipe and seriously affect the user's health and safety. This can also cause the corrosion of the indoor unit and a resultant unit failure or refrigerant leak. [I]
- **Connect the pipes for refrigeration circuit securely in installation work before compressor is operated.**
If the compressor is operated when the service valve is open without connecting the pipe, it could cause explosion and injuries due to abnormal high pressure in the system. [I]
- **Stop the compressor before removing the pipe after shutting the service valve on pump down work.**
If the pipe is removed when the compressor is in operation with the service valve open, air would be mixed in the refrigeration circuit and it could cause explosion and injuries due to abnormal high pressure in the cooling cycle. [I]
- **Only use prescribed option parts. The installation must be carried out by the qualified installer.**
If you install the system by yourself, it can cause serious trouble such as water leaks, electric shocks, fire. [I]
- **Do not repair by yourself. And consult with the dealer about repair.**
Improper repair may cause water leakage, electric shock or fire. [I]
- **Consult the dealer or a specialist about removal of the air-conditioner.**
Improper installation may cause water leakage, electric shock or fire. [I]
- **Turn off the power source during servicing or inspection work.**
If the power is supplied during servicing or inspection work, it could cause electric shock and injury by the operating fan. [I]
- **Do not run the unit when the panel or protection guard are taken off.**
Touching the rotating equipment, hot surface, or high voltage section could cause an injury to be caught in the machine, to get burned, or electric shock. [I]
- **Shut off the power before electrical wiring work.**
It could cause electric shock, unit failure and improper running. [I]

CAUTION

- **Perform earth wiring surely.**
Do not connect the earth wiring to the gas pipe, water pipe, lightning rod and telephone earth wiring. Improper earth could cause unit failure and electric shock or fire due to a short circuit. [I]
- **Earth leakage breaker must be installed.**
If the earth leakage breaker is not installed, it could cause electric shocks or fire. [I]
- **Use the circuit breaker of correct capacity. Circuit breaker should be the one that disconnect all poles under over current.**
Using the incorrect one could cause the system failure and fire. [I]
- **Do not use any materials other than a fuse of correct capacity where a fuse should be used.**
Connecting the circuit by wire or copper wire could cause unit failure and fire. [I]
- **Do not install the indoor unit near the location where there is possibility of flammable gas leakages.**
If the gas leaks and gathers around the unit, it could cause fire. [I]
- **Do not install and use the unit where corrosive gas (such as sulfuric acid gas etc.) or flammable gas (such as thinner, petroleum etc.) may be generated or accumulated, or volatile flammable substances are handled.**
It could cause the corrosion of heat exchanger, breakage of plastic parts etc. And inflammable gas could cause fire. [I]
- **Secure a space for installation, inspection and maintenance specified in the manual.**
Insufficient space can result in accident such as personal injury due to falling from the installation place. [I]
- **Do not use the indoor unit at the place where water splashes such as laundry.**
Indoor unit is not waterproof. It could cause electric shock and fire. [I]
- **Do not use the indoor unit for a special purpose such as food storage, cooling for precision instrument, preservation of animals, plants, and a work of art.**
It could cause the damage of the items. [I]
- **Do not install nor use the system near equipments which generate electromagnetic wave or high harmonics.**
Equipments like inverter equipment, private power generator, high-frequency medical equipment, or telecommunication equipment might influence the air-conditioner and cause a malfunction and breakdown. Or the air-conditioner might influence medical equipments or telecommunication equipments, and obstruct their medical activity or cause jamming. [I]
- **Do not install the remote control at the direct sunlight.**
It could cause breakdown or deformation of the remote control. [I]
- **Do not install the indoor unit at the place listed below.**
- Places where flammable gas could leak.
- Places where carbon fiber, metal powder or any powder is floated.
- Place where the substances which affect the air-conditioner are generated such as sulfide gas, chloride gas, acid, alkali or ammoniac atmospheres.
- Places exposed to oil mist or steam directly.
- On vehicles and ships
- Places where machinery which generates high harmonics is used.
- Places where cosmetics or special sprays are frequently used.
- Highly salted area such as beach.
- Heavy snow area
- Places where the system is affected by smoke from a chimney.
- Altitude over 1000m [I]
- **Do not install the indoor unit in the locations listed below (Be sure to install the indoor unit according to the installation manual for each model because each indoor unit has each limitation)**
- Locations with any obstacles which can prevent inlet and outlet air of the unit
- Locations where vibration can be amplified due to insufficient strength of structure.
- Locations where the infrared receiver is exposed to the direct sunlight or the strong light beam. (in case of the infrared specification unit)
- Locations where an equipment affected by high harmonics is placed. (TV set or radio receiver is placed within 5m)
- Locations where drainage cannot run off safely.
It can affect performance or function and etc.. [I]
- **Do not put any valuables which will break down by getting wet under the air-conditioner.**
Condensation could drop when the relative humidity is higher than 80% or drain pipe is clogged, and it damages user's belongings. [I]
- **Do not use the base frame for the outdoor unit which is corroded or damaged after a long period of use.**
It could cause the unit falling down and injury. [I]
- **Pay attention not to damage the drain pan by weld sputter when brazing work is done near the unit.**
If sputter entered into the unit during brazing work, it could cause damage (pinhole) of drain pan and leakage of water. To avoid damaging, keep the indoor unit packed or cover the indoor unit. [I]
- **Install the drain pipe to drain the water surely according to the installation manual.**
Improper connection of the drain pipe may cause dropping water into room and damaging user's belongings. [I]
- **Do not share the drain pipe for indoor unit and GHP (Gas Heat Pump system) outdoor unit.**
Toxic exhaust gas would flow into room and it might cause serious damage (some poisoning or deficiency of oxygen) to user's health and safety. [I]
- **Be sure to perform air tightness test by pressurizing with nitrogen gas after completed refrigerant piping work.**
If the density of refrigerant exceeds the limit in the event of refrigerant leakage in the small room, lack of oxygen can occur, which can cause serious accidents. [I]
- **For drain pipe installation, be sure to make descending slope of greater than 1/100, not to make traps, and not to make air-bleeding.**
Check if the drainage is correctly done during commissioning and ensure the space for inspection and maintenance. [I]
- **Ensure the insulation on the pipes for refrigeration circuit so as not to condense water.**
Incomplete insulation could cause condensation and it would wet ceiling, floor, and any other valuables. [I]
- **Do not install the outdoor unit where is likely to be a nest for insects and small animals.**
Insects and small animals could come into the electronic components and cause breakdown and fire. Instruct the user to keep the surroundings clean. [I]
- **Pay extra attention, carrying the unit by hand.**
Carry the unit with 2 people if it is heavier than 20kg. Do not use the plastic straps but the grabbing place, moving the unit by hand. Use protective gloves in order to avoid injury by the aluminum fin. [I]
- **Make sure to dispose of the packaging material.**
Leaving the materials may cause injury as metals like nail and woods are used in the package. [I]
- **Do not operate the system without the air filter.**
It may cause the breakdown of the system due to clogging of the heat exchanger. [I]
- **Do not touch any button with wet hands.**
It could cause electric shock. [I]
- **Do not touch the refrigerant piping with bare hands when in operation.**
The pipe during operation would become very hot or cold according to the operating condition, and it could cause a burn or frostbite. [I]
- **Do not clean up the air-conditioner with water.**
It could cause electric shock. [I]
- **Do not turn off the power source immediately after stopping the operation.**
Be sure to wait for more than 5 minutes. Otherwise it could cause water leakage or breakdown. [I]
- **Do not control the operation with the circuit breaker.**
It could cause fire or water leakage. In addition, the fan may start operation unexpectedly and it may cause injury. [I]

○ This model is high static ducted type air-conditioning unit. Therefore, do not use this model for direct blow type air-conditioning unit.

1 Before installation

- Install correctly according to the installation manual.
- Confirm the following points:
 - Unit type/Power source specification
 - Pipes/Wires/Small parts
 - Accessory items

Accessory item

For hanging		For refrigerant pipe				For drain pipe			
Flat washer (M10)	Pipe cover (big)	Pipe cover (small)	Strap	Pipe cover (big)	Pipe cover (small)	Drain hose	Hose clamp	Elbow (Multi only)	
8	1	1	4	1	1	1	1	1	1
For unit hanging	For heat insulation of gas pipe	For heat insulation of liquid tube	For pipe cover fixing	For heat insulation of drain socket	For heat insulation of drain socket	For drain pipe connecting	For drain hose mounting	For drain pipe connecting	Accessory parts are stored inside this suction side.

2 Selection of installation location for the indoor unit

- Select the suitable areas to install the unit under approval of the user.
 - Areas where the indoor unit can deliver hot and cold wind sufficiently. Suggest to the user to use a circulator if the ceiling height is over 3m to avoid warm air being accumulated on the ceiling.
 - Areas where there is enough space to install and service.
 - Areas where it can be drained properly. Areas where drain pipe descending slope can be taken.
 - Areas where there is no obstruction of airflow on both air return grille and air supply port.
 - Areas where fire alarm will not be accidentally activated by the air-conditioner.
 - Areas where the supply air does not short-circuit.
 - Areas where it is not influenced by draft air.
 - Areas not exposed to direct sunlight.
 - Areas where dew point is lower than around 28°C and relative humidity is lower than 80%.
 (This indoor unit is tested under the condition of JIS (Japan Industrial Standard) high humidity condition and confirmed there is no problem. However, there is some risk of condensation drop if the air-conditioner is operated under the severer condition than mentioned above. If there is a possibility to use it under such a condition, attach additional insulation of 10 to 20mm thick for entire surface of indoor unit, refrigeration pipe and drain pipe.)
 - Areas where TV and radio stays away more than 1m. (It could cause jamming and noise.)
 - Areas where any items which will be damaged by getting wet are not placed such as food, table wares, server, or medical equipment under the unit.
 - Areas where there is no influence by the heat which cookware generates.
 - Areas where not exposed to oil mist, powder and/or steam directly such as above fryer.
 - Areas where lighting device such as fluorescent light or incandescent light doesn't affect the operation.
 (A beam from lighting device sometimes affects the infrared receiver for the wireless remote control and the air-conditioner might not work properly.)
 - When operating the suction air processing unit independently, it operates in the outdoor air processing mode.
 Blowout temperatures are not same at the standard unit operation and the outdoor air processing mode operations. Since the temperatures become higher during cooling or lower during heating, take care of the direction of blowout outlet.
 - Avoid directing the blowout outlet to the space where people are present.
- Check if the place where the air-conditioner is installed can hold the weight of the unit. If it is not able to hold, reinforce the structure with boards and beams strong enough to hold it. If the strength is not enough, it could cause injury due to unit falling.

Space for installation and service

- Make installation altitude over 2.5m. (Indoor Unit)

Select either of two cases to keep space for installation and services.

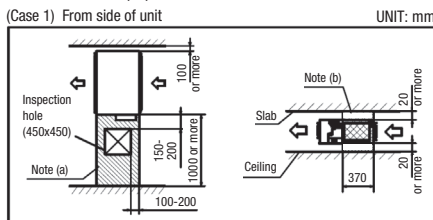

- Notes (a) There must not be obstacle to draw out fan motor. (▨ marked area)
 (b) Install refrigerant pipe, drain pipe, and wiring so as not to cross ▨ marked area.

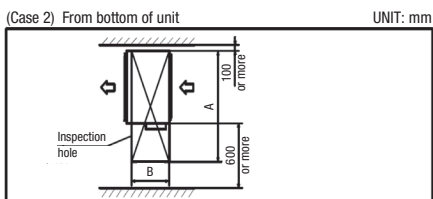

(Size of inspection hole)		UNIT: mm		
Single type	—	71	100-140	
Multi type	45, 56	71, 90	112-160	
FDU-F	—	650	1100	
A	1100	1300	1720	
B	620	725		

3 Cautions for the handling and installation place of outdoor air processing unit

- This unit monitors the outdoor air temperature at the position of sensor A in the figure, and controls the start and stop with the thermostat based on the value of sensor A and the setting temperature by the remote control.

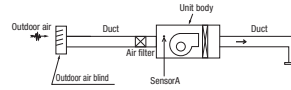

Remote control's setting temperature indicates the outdoor air temperature that controls the start and stop of operation by the thermostat.

When the thermostat is turned off, the operation is changed to the fan mode so that the outdoor air is blown out directly into the room. For example if the remote control is set to 22°C in cooling operation, and if the outdoor air temperature is 22°C or lower at that time, the unit will go into fan operation.

- When there is a difference between the air-conditioning temperature in the room during cooling operation and the temperature of air blown out from the outdoor air processing unit, dewing water may drip from the unit. To prevent the dewing, provide a sufficient heat insulation means at the air blow outlet.
 - Since the air blow outlet on the outdoor air processing unit may blow out the outdoor air directly, orient the outlet in such a way that it will not blow air directly to persons in the room.
 - Since the unit controls the thermostat start and stop by monitoring the outdoor air temperature, it is prohibited to monitor the room temperature by means of the room temperature monitoring by changing the thermostat setting at the remote control side and the optional remote thermostat. Otherwise, dewing water may drip from the unit at lower outdoor air temperatures during cooling operation.
 - Install the remote control of the outdoor air processing unit at a place closer to the administrator to avoid the end user from using the remote control.
- When handing over the unit to the end user, make sure to explain sufficiently about the foregoing cautions, the installation place of the remote control for the outdoor air processing unit and the position of air blow outlet.

4 Preparation before installation

- If suspension bolt becomes longer, do reinforcement of earthquake resistant.
 - For grid ceiling
 When the suspension bolt length is over 500mm, or the gap between the ceiling and roof is over 700mm, apply earthquake resistant brace to the bolt.
 - In case the unit is hanged directly from the slab and is installed on the ceiling plane which has enough strength.
 When suspension bolt length is over 1000mm, apply the earthquake resistant brace to the bolt.
- Prepare four (4) sets of suspension bolt, nut and spring washer (M10) on site.

Suspension Bolt Location

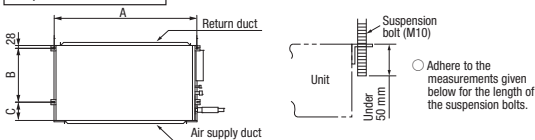

	UNIT: mm		
Single type	—	71	100-140
Multi type	45, 56	71, 90	112-160
FDU-F	—	650	1100
A	786	986	1720
B	472	472	725
C	135	135	180

Pipe locations UNIT: mm

Single type	71
Multi type	45-90
FDU-F	650

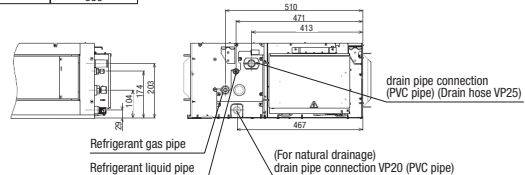

Single type	100-140
Multi type	112-160
FDU-F	1100

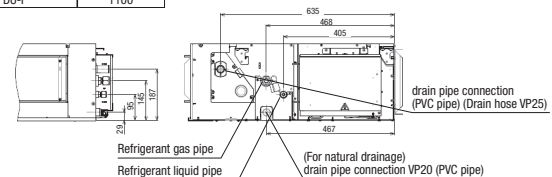

⑤ Installation of indoor unit

Installation

[Hanging]

Hang the unit up.

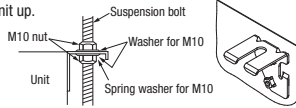

If the measurements between the unit and the ceiling hole do not match upon installation, it may be adjusted with the long holed installation tool.

Adjustment for horizontality

Either use a level vial, or adjust the level according to the method below.

- Adjust so the bottom side of the unit will be leveled with the water surface as illustrated below.

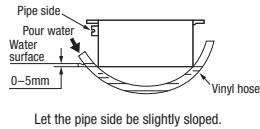

If the unit is not leveled, it may cause malfunctions or inoperation of the float switch.

⑥ Duct Work

① A corrugated board (for preventing sputtering) is attached to the main body of the air-conditioner (on the outlet port). Do not remove it until connecting the duct.

- An air filter can be provided on the main body of the air-conditioner (on the inlet port). Remove it when connecting the duct on the inlet port.

② Blowout duct

- Use rectangular duct to connect with unit.
- Duct size for each unit is as shown below.

		UNIT: mm		
Single type	—	71	100-140	
Multi type	45, 56	71, 90	112-160	
FDU-F	—	650	1100	
A	682	882	1202	
B	172	172	172	

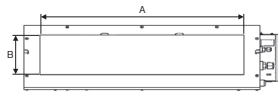

- Duct should be at their minimum length.
- We recommend to use sound and heat insulated duct to prevent it from condensation.
- Connect duct to unit before ceiling attachment.

③ Inlet port

- When connecting the duct to the inlet port, remove the air filter if it is fitted to the inlet port.
- Inlet port size for each unit is as shown below.

		UNIT: mm		
Single type	—	71	100-140	
Multi Type	45, 56	71, 90	112-160	
FDU-F	—	650	1100	
A	582	742	1282	
B	202	202	237	



- Make sure to insulate the duct to prevent dewing on it.
- Install the specific blowout duct in a location where the air will circulate to the entire room.
- Conduct the installation of the specific blowout hole and the connection of the duct before attaching them to the ceiling.
- Insulate the area where the duct is secured by a band for dew condensation prevention.
- Make sure provide an inspection hole on the ceiling. It is indispensable to service electric equipment, motor, functional components and cleaning of heat exchanger.

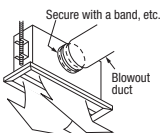

⑥ Duct Work (continued)

FDU

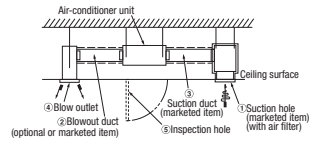

FDU-F

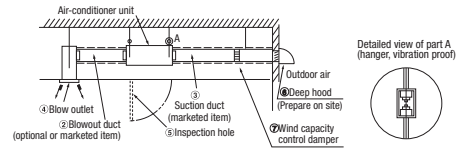

Bad example of duct work

- If a duct is not provided at the suction side but it is substituted with the space over the ceiling, humidity in the space will increase by the influence of capacity of ventilation fan, strength of wind blowing against the outdoor air louver, weather (rainy day) and others.
 - Moisture in air is likely to condense over the external plates of the unit and to drip on the ceiling. Unit should be operated under the conditions as listed in the above table and within the limitation of wind volume. When the building is a concrete structure, especially immediately after the construction, humidity tends to rise even if the space over the ceiling is not substituted in place of a duct. In such occasion, it is necessary to insulate the entire unit with glass wool (25mm). (Use a wire net or equivalent to hold the glass wool in place.)
 - It may run out the allowable limit of unit operation (Example, the case of FDU: When outdoor air temperature is 35°CDB, suction air temperature is 27°CWB) and it could result in such troubles as compressor overload, etc..
 - There is a possibility that the blow air volume may exceed the allowable range of operation due to the capacity of ventilation fan or strength of wind blowing against external air louver so that drainage from the heat exchanger may fall to reach the drain pan but leak outside (Example: drip on to the ceiling) with consequential water leakage in the room.
- If vibration damping is not conducted between the unit and the duct, and between the unit and the slab, vibration will be transmitted to the duct and vibration noise may occur. Also, vibration may be transmitted from the unit to the slab. Vibration damping must be performed.

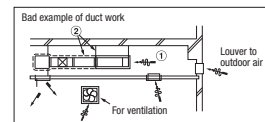

Connecting the air intake/vent ducts the case of FDU

- Fresh Air Intake [for air intake duct only]
 - Use the side fresh air intake hole, or supply through a part of the suction duct.

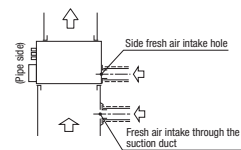

[for simultaneous air intake/vent]

- Intake air through the suction duct. (the side cannot be used)

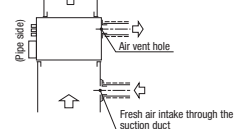

- Air Vent
 - Use the side air vent hole. (always use together with the air intake)

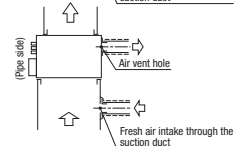

- Insulate the duct to protect it from dew condensation.

⑦ Refrigerant pipe

Caution

- Be sure to use new pipes for the refrigerant pipes. Use the flare nut attached to the product or a nut compatible with JIS B 8607, Class 2.
Regarding whether existing pipes can be reused or not, and the washing method, refer to the instruction manual of the outdoor unit, catalogue or technical data.
- 1) In case of reuse: Do not use old flare nut, but use the one attached to the unit or compatible with JIS B 8607, Class 2.
- 2) In case of reuse: Flare the end of pipe replaced partially for R410A.

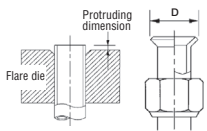

Pipe dia. d mm	Min. pipe wall thickness mm	Protruding dimension for flare, mm		Flare O.D. D mm	Flare nut tightening torque N·m
		Rigid (Clutch type) For R410A	Conventional tool		
6.35	0.8	0 - 0.5	0.7 - 1.3	8.9 - 9.1	14 - 18
9.52	0.8			12.8 - 13.2	34 - 42
12.7	0.8			16.2 - 16.6	49 - 61
15.88	1			19.3 - 19.7	68 - 82
19.05	1.2			23.6 - 24.0	100 - 120

- Use phosphorus deoxidized copper alloy seamless pipe (C1220T specified in JIS H 3300) for refrigeration pipe installation. In addition, make sure there is no damage both inside and outside of the pipe, and no harmful substances such as sulfur, oxide, dust or a contaminant stuck on the pipes.
- Do not use any refrigerant other than R410A.
Using other refrigerant except R410A (R22 etc.) may degrade inside refrigeration oil. And air getting into refrigeration circuit may cause over-pressure and resultant it may result in bursting, etc.
- Store the copper pipes indoors and seal the both end of them until they are brazed in order to avoid any dust, dirt or water getting into pipe. Otherwise it will cause degradation of refrigeration oil and compressor breakdown, etc.
- Use special tools for R410A refrigerant.

Piping work

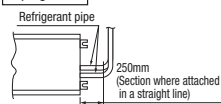

When conducting piping work, make sure to allow the pipes to be aligned in a straight line for at least 250 mm, as shown in the left illustration. (This is necessary for the drain pump to function)

Work procedure

- Remove the flare nut and blind flanges on the pipe of the indoor unit.
 - ※ Make sure to loosen the flare nut with holding the nut on pipe side with a spanner and giving torque to the nut with another spanner in order to avoid unexpected stress to the copper pipe, and then remove them. (Gas may come out at this time, but it is not abnormal.)
 - Pay attention whether the flare nut pops out. (as the indoor unit is sometimes pressured.)
- Make a flare on liquid pipe and gas pipe, and connect the refrigeration pipes on the indoor unit.
 - ※ Bend radius of pipe must be 4D or larger. Once a pipe is bent, do not readjust the bending. Do not twist a pipe or collapse to 2/3D or smaller.
 - ※ Do a flare connection as follows:
 - Make sure to loosen the flare nut with holding the nut on pipe side with a spanner and giving torque to the nut with another spanner in order to avoid unexpected stress to the copper pipe, and then remove them.
 - When fastening the flare nut, align the refrigeration pipe with the center of flare nut, screw the nut for 3-4 times by hand and then tighten it by spanner with the specified torque mentioned in the table above. Make sure to hold the pipe on the indoor unit securely by a spanner when tightening the nut in order to avoid unexpected stress on the copper pipe.
- Cover the flare connection part of the indoor unit with attached insulation material after a gas leakage inspection, and tighten both ends with attached straps.
 - Make sure to insulate both gas pipes and liquid pipes completely.
 - ※ Incomplete insulation may cause dew condensation or water dropping.
 - Use heat-resistant (120 °C or more) insulations on the gas side pipes.
 - In case of using at high humidity condition, reinforce insulation of refrigerant pipes. Surface of insulation may cause dew condition or water dropping, if insulations are not reinforced.
- Refrigerant is charged in the outdoor unit.
As for the additional refrigerant charge for the indoor unit and piping, refer to the installation manual attached to the outdoor unit.

Caution:

Refrigerating machine oil should not be applied to the threads of union or external surface of flare. It is because, even if the same tightening torque is applied, the oil is likely to decrease the slide friction force on the threads and increase, in turn, the axial component force so that it could crack the flare by the stress corrosion.
Refrigerating machine oil may be applied to the internal surface of flare only.

<The case of using thickness of insulation is 10mm>

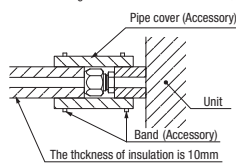

<The case of using reinforced insulation>

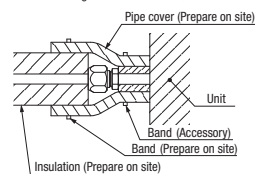

⑧ Drain pipe

Caution

- Install the drain pipe according to the installation manual in order to drain properly. Imperfection in draining may cause flood indoors and wetting the household goods, etc.
- Do not put the drain pipe directly into the ditch where toxic gas such as sulfur, the other harmful and inflammable gas is generated. Toxic gas would flow into the room and it would cause serious damage to user's health and safety (some poisoning or deficiency of oxygen). In addition, it may cause corrosion of heat exchanger and bad smell.
- Connect the pipe securely to avoid water leakage from the joint.
- Insulate the pipe properly to avoid condensation drop.
- Check if the water can flow out properly from both the drain outlet on the indoor unit and the end of the drain pipe after installation.
- Make sure to make descending slope of greater than 1/100 and do not make up-down bend and/or trap in the midway. In addition, do not put air vent on the drain pipe. Check if water is drained out properly from the pipe during commissioning. Also, keep sufficient space for inspection and maintenance.

Work procedure

- Make sure to insert the drain hose (the end mode of soft PVC) to the end of the step part of drain socket.
Attach the hose clamp to the drain hose around 10mm from the end, and fasten the screw within 5mm left to the nut.
 - Do not apply adhesives on this end.
 - Do not use acetone-based adhesives to connect to the drain socket.

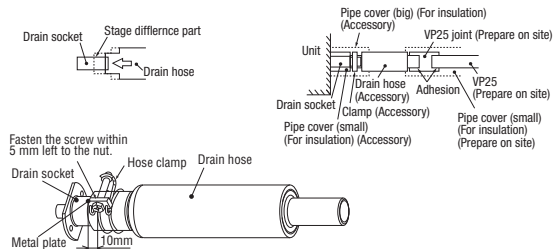

- Prepare a joint for connecting VP-25 pipe, adhere and connect the joint to the drain hose (the end made of rigid PVC), and adhere and connect VP-25 pipe (prepare on site).
 - ※ As for drain pipe, apply VP-25 made of rigid PVC which is on the market.
 - Make sure that the adhesive will not get into the supplied drain hose. It may cause the flexible part broken after the adhesive is dried up and gets rigid.
 - The flexible drain hose is intended to absorb a small difference at installation of the unit or drain pipes. Intentional bending, expanding may cause the flexible hose broken and water leakage.

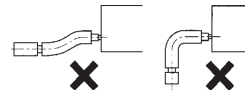

- As for drain pipe, apply VP25 (OD32).
If apply PVC25 (OD25), connect the expanded connector to the drain hose, with adhesive. (Multi unit only)

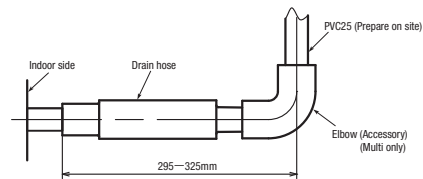

- Make sure to make descending slope of greater than 1/100 and do not make up-down bend and/or trap in the midway.
 - Pay attention not to give stress on the pipe on the indoor unit side, and support and fix the pipe as close place to the unit as possible when connecting the drain pipe.
 - Do not set up air vent.

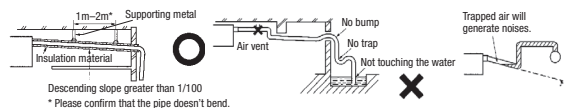

- When sharing a drain pipe for more than one unit, lay the main pipe 100mm below the drain outlet of the unit. In addition, select VP-30 or bigger size for main drain pipe.

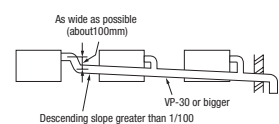

(b) Replacement procedure of the fan unit

Notes(1) The unit is a heavy item. It must be supported securely and handled with care not to drop when it is necessary to replace.
(2) For the maintenance space, refer to page 58.

- (i) Remove the control box and the side panel, and remove the screws marked in the circles (2 places) from the unit located at the near side.

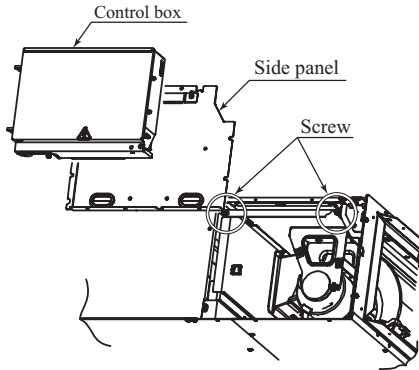

- (ii) Take out the fan unit located at the near side in the arrow direction.

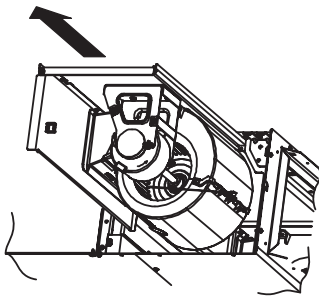

- (iii) Remove the screws marked in the circles (2 places) from the fan unit located at the far side.

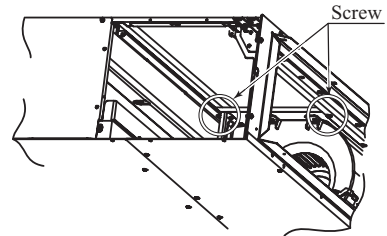

- (iv) Take out the fan unit in the arrow direction.

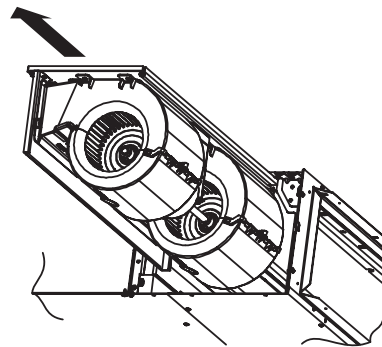

(4) Duct connected-Low / Middle static pressure type (FDUM)



This manual is for the installation of an indoor unit.
 For electrical wiring work (Indoor), refer to the page 76. For remote control installation, refer to the page 84. For wireless kit installation, refer to the page 223. For electrical wiring work (Outdoor) and refrigerant pipe work installation for outdoor unit, refer to the page 98.

SAFETY PRECAUTIONS

- Read the "SAFETY PRECAUTIONS" carefully first of all and then strictly follow it during the installation work in order to protect yourself.
- The precautionary items mentioned below are distinguished into two levels, [⚠️WARNING] and [⚠️CAUTION].
 [⚠️WARNING]: Wrong installation would cause serious consequences such as injuries or death.
 [⚠️CAUTION]: Wrong installation might cause serious consequences depending on circumstances.
 Both mentions the important items to protect your health and safety so strictly follow them by any means.
- The meanings of "Marks" used here are as shown on the right:
 [⊘] Never do it under any circumstances. [⚠️] Always do it according to the instruction.
- After completing the installation, do commissioning to confirm there are no abnormalities, and explain to the customers about "SAFETY PRECAUTIONS", correct operation method and maintenance method (air filter cleaning, operation method and temperature setting method) with user's manual of this unit.
 Ask your customers to keep this installation manual together with the user's manual. Also, ask them to hand over the user's manual to the new user when the owner is changed.

⚠️ WARNING

- **Installation should be performed by the specialist.**
 If you install the unit by yourself, it may lead to serious trouble such as water leakage, electric shock, fire, and injury due to overturn of the unit. [⚠️]
- **Install the system correctly according to these installation manuals.**
 Improper installation may cause explosion, injury, water leakage, electric shock, and fire. [⚠️]
- **Check the density referred by the formula (accordance with ISO5149).**
 If the density exceeds the limit density, please consult the dealer and installate the ventilation system. [⚠️]
- **Use the genuine accessories and the specified parts for installation.**
 If parts unspecified by our company are used it could cause water leakage, electric shock, fire, and injury due to overturn of the unit. [⚠️]
- **Ventilate the working area well in case the refrigerant leaks during installation.**
 If the refrigerant contacts the fire, toxic gas is produced. [⚠️]
- **Install the unit in a location that can hold heavy weight.**
 Improper installation may cause the unit to fall leading to accidents. [⚠️]
- **Install the unit properly in order to be able to withstand strong winds such as typhoons, and earthquakes.**
 Improper installation may cause the unit to fall leading to accidents. [⚠️]
- **Do not mix air in to the cooling cycle on installation or removal of the air-conditioner.**
 If air is mixed in, the pressure in the cooling cycle will rise abnormally and may cause explosion and injuries. [⊘]
- **Be sure to have the electrical wiring work done by qualified electrical installer, and use exclusive circuit.**
 Power source with insufficient capacity and improper work can cause electric shock and fire. [⚠️]
- **Use specified wire for electrical wiring, fasten the wiring to the terminal securely, and hold the cable securely in order not to apply unexpected stress on the terminal.**
 Loose connections or hold could result in abnormal heat generation or fire. [⚠️]
- **Arrange the electrical wires in the control box properly to prevent them from rising. Fit the lid of the services panel properly.**
 Improper fitting may cause abnormal heat and fire. [⚠️]
- **Check for refrigerant gas leakage after installation is completed.**
 If the refrigerant gas leaks into the house and comes in contact with a fan heater, a stove, or an oven, toxic gas is produced. [⚠️]
- **Use the specified pipe, flare nut, and tools for R410A.**
 Using existing parts (R22) could cause the unit failure and serious accident due to explosion of the cooling cycle. [⚠️]
- **Tighten the flare nut according to the specified method by with torque wrench.**
 If the flare nut were tightened with excess torque, it could cause burst and refrigerant leakage after a long period. [⚠️]
- **Do not put the drainage pipe directly into drainage channels where poisonous gases such as sulfide gas can occur.**
 Poisonous gases will flow into the room through drainage pipe and seriously affect the user's health and safety. This can also cause the corrosion of the indoor unit and a resultant unit failure or refrigerant leak. [⊘]
- **Connect the pipes for refrigeration circuit securely in installation work before compressor is operated.**
 If the compressor is operated when the service valve is open without connecting the pipe, it could cause explosion and injuries due to abnormal high pressure in the system. [⚠️]
- **Stop the compressor before removing the pipe after shutting the service valve on pump down work.**
 If the pipe is removed when the compressor is in operation with the service valve open, air would be mixed in the refrigeration circuit and it could cause explosion and injuries due to abnormal high pressure in the cooling cycle. [⚠️]
- **Only use prescribed option parts. The installation must be carried out by the qualified installer.**
 If you install the system by yourself, it can cause serious trouble such as water leaks, electric shocks, fire. [⚠️]
- **Do not repair by yourself. And consult with the dealer about repair.**
 Improper repair may cause water leakage, electric shock or fire. [⊘]
- **Consult the dealer or a specialist about removal of the air-conditioner.**
 Improper installation may cause water leakage, electric shock or fire. [⚠️]
- **Turn off the power source during servicing or inspection work.**
 If the power is supplied during servicing or inspection work, it could cause electric shock and injury by the operating fan. [⚠️]
- **Do not run the unit when the panel or protection guard are taken off.**
 Touching the rotating equipment, hot surface, or high voltage section could cause an injury to be caught in the machine, to get burned, or electric shock. [⊘]
- **Shut off the power before electrical wiring work.**
 It could cause electric shock, unit failure and improper running. [⚠️]

⚠️ CAUTION

- **Perform earth wiring surely.**
 Do not connect the earth wiring to the gas pipe, water pipe, lightning rod and telephone earth wiring. Improper earth could cause unit failure and electric shock or fire due to a short circuit. [⚠️]
- **Earth leakage breaker must be installed.**
 If the earth leakage breaker is not installed, it could cause electric shocks or fire. [⚠️]
- **Use the circuit breaker of correct capacity. Circuit breaker should be the one that disconnect all poles under over current.**
 Using the incorrect one could cause the system failure and fire. [⚠️]
- **Do not use any materials other than a fuse of correct capacity where a fuse should be used.**
 Connecting the circuit by wire or copper wire could cause unit failure and fire. [⊘]
- **Do not install the indoor unit near the location where there is possibility of flammable gas leakages.**
 If the gas leaks and gathers around the unit, it could cause fire. [⊘]
- **Do not install and use the unit where corrosive gas (such as sulfurous acid gas etc.) or flammable gas (such as thinner, petroleum etc.) may be generated or accumulated, or volatile flammable substances are handled.**
 It could cause the corrosion of heat exchanger, breakage of plastic parts etc. And inflammable gas could cause fire. [⊘]
- **Secure a space for installation, inspection and maintenance specified in the manual.**
 Insufficient space can result in accident such as personal injury due to falling from the installation place. [⚠️]
- **Do not use the indoor unit at the place where water splashes such as laundry.**
 Indoor unit is not waterproof. It could cause electric shock and fire. [⊘]
- **Do not use the indoor unit for a special purpose such as food storage, cooling for precision instrument, preservation of animals, plants, and a work of art.**
 It could cause the damage of the items. [⊘]
- **Do not install nor use the system near equipments which generate electromagnetic wave or high harmonics.**
 Equipments like inverter equipment, private power generator, high-frequency medical equipment, or telecommunication equipment might influence the air-conditioner and cause a malfunction and breakdown. Or the air-conditioner might influence medical equipments or telecommunication equipments, and obstruct their medical activity or cause jamming. [⊘]
- **Do not install the remote control at the direct sunlight.**
 It could cause breakdown or deformation of the remote control. [⊘]
- **Do not install the indoor unit at the place listed below.**
 - Places where flammable gas could leak.
 - Places where carbon fiber, metal powder or any powder is floated.
 - Place where the substances which affect the air-conditioner are generated such as sulfide gas, chlorine gas, acid, alkali or ammoniac atmospheres.
 - Places exposed to oil mist or steam directly.
 - On vehicles and ships
 - Places where machinery which generates high harmonics is used.
 - Places where cosmetics or special sprays are frequently used.
 - Highly salted area such as beach.
 - Heavy snow area
 - Places where the system is affected by smoke from a chimney.
 - Altitude over 1000m [⊘]
- **Do not install the indoor unit in the locations listed below (Be sure to install the indoor unit according to the installation manual for each model because each indoor unit has each limitation)**
 - Locations with any obstacles which can prevent inlet and outlet air of the unit
 - Locations where vibration can be amplified due to insufficient strength of structure.
 - Locations where the infrared receiver is exposed to the direct sunlight or the strong light beam. (in case of the infrared specification unit)
 - Locations where an equipment affected by high harmonics is placed. (TV set or radio receiver is placed within 5m)
 - Locations where drainage cannot run off safely.
 It can affect performance or function and etc. [⊘]
- **Do not put any valuables which will break down by getting wet under the air-conditioner.**
 Condensation could drop when the relative humidity is higher than 80% or drain pipe is clogged, and it damages user's belongings. [⊘]
- **Do not use the base frame for the outdoor unit which is corroded or damaged after a long period of use.**
 It could cause the unit falling down and injury. [⊘]
- **Pay attention not to damage the drain pan by weld sputter when brazing work is done near the unit.**
 If sputter entered into the unit during brazing work, it could cause damage (pinhole) of drain pan and leakage of water. To avoid damaging, keep the indoor unit packed or cover the indoor unit. [⚠️]
- **Install the drain pipe to drain the water surely according to the installation manual.**
 Improper connection of the drain pipe may cause dropping water into room and damaging user's belongings. [⚠️]
- **Do not share the drain pipe for indoor unit and GHP (Gas Heat Pump system) outdoor unit.**
 Toxic exhaust gas would flow into room and it might cause serious damage (some poisoning or deficiency of oxygen) to user's health and safety. [⊘]
- **Be sure to perform air tightness test by pressurizing with nitrogen gas after completed refrigerant piping work.**
 If the density of refrigerant exceeds the limit in the event of refrigerant leakage in the small room, lack of oxygen can occur, which can cause serious accidents. [⚠️]
- **For drain pipe installation, be sure to make descending slope of greater than 1/100, not to make traps, and not to make air-bleeding.**
 Check if the drainage is correctly done during commissioning and ensure the space for inspection and maintenance. [⚠️]
- **Ensure the insulation on the pipes for refrigeration circuit so as not to condense water.**
 Incomplete insulation could cause condensation and it would wet ceiling, floor, and any other valuables. [⚠️]
- **Do not install the outdoor unit where is likely to be a nest for insects and small animals.**
 Insects and small animals could come into the electronic components and cause breakdown and fire. Instruct the user to keep the surroundings clean. [⊘]
- **Pay extra attention, carrying the unit by hand.**
 Carry the unit with 2 people if it is heavier than 20kg. Do not use the plastic straps but the grabbing place, moving the unit by hand. Use protective gloves in order to avoid injury by the aluminum fin. [⚠️]
- **Make sure to dispose of the packaging material.**
 Leaving the materials may cause injury as metals like nail and woods are used in the package. [⚠️]
- **Do not operate the system without the air filter.**
 It may cause the breakdown of the system due to clogging of the heat exchanger. [⊘]
- **Do not touch any button with wet hands.**
 It could cause electric shock. [⊘]
- **Do not touch the refrigerant piping with bare hands when in operation.**
 The pipe during operation would become very hot or cold according to the operating condition, and it could cause a burn or frostbite. [⊘]
- **Do not clean up the air-conditioner with water.**
 It could cause electric shock. [⊘]
- **Do not turn off the power source immediately after stopping the operation.**
 Be sure to wait for more than 5 minutes. Otherwise it could cause water leakage or breakdown. [⊘]
- **Do not control the operation with the circuit breaker.**
 It could cause fire or water leakage. In addition, the fan may start operation unexpectedly and it may cause injury. [⊘]

○ This model is middle static ducted type air-conditioning unit. Therefore, do not use this model for direct blow type air-conditioning unit.

1 Before installation

- Install correctly according to the installation manual.
- Confirm the following points:
 - Unit type/Power source specification
 - Pipes/Wires/Small parts
 - Accessory items

Accessory item							
For hanging		For refrigerant pipe			For drain pipe		
Flat washer (M10)	Pipe cover (big)	Pipe cover (small)	Strap	Pipe cover (big)	Pipe cover (small)	Drain hose	Hose clamp
8	1	1	4	1	1	1	1
For unit hanging	For heat insulation of gas pipe	For heat insulation of liquid tube	For pipe cover fixing	For heat insulation of drain socket	For heat insulation of drain socket	For drain pipe connecting	For drain hose mounting

Accessory parts are stored inside this suction side.

2 Selection of installation location for the indoor unit

- Select the suitable areas to install the unit under approval of the user.
 - Areas where the indoor unit can deliver hot and cold wind sufficiently. Suggest to the user to use a circulator if the ceiling height is over 3m to avoid warm air being accumulated on the ceiling.
 - Areas where there is enough space to install and service.
 - Areas where it can be drained properly. Areas where drain pipe descending slope can be taken.
 - Areas where there is no obstruction of airflow on both air return grille and air supply port.
 - Areas where fire alarm will not be accidentally activated by the air-conditioner.
 - Areas where the supply air does not short-circuit.
 - Areas where it is not influenced by draft air.
 - Areas not exposed to direct sunlight.
 - Areas where dew point is lower than around 28°C and relative humidity is lower than 80%.
 This indoor unit is tested under the condition of JIS (Japan Industrial Standard) high humidity condition and confirmed there is no problem. However, there is some risk of condensation drop if the air-conditioner is operated under the severer condition than mentioned above. If there is a possibility to use it under such a condition, attach additional insulation of 10 to 20mm thick for entire surface of indoor unit, refrigeration pipe and drain pipe.
 - Areas where TV and radio stays away more than 1m. (It could cause jamming and noise.)
 - Areas where any items which will be damaged by getting wet are not placed such as food, table wares, server, or medical equipment under the unit.
 - Areas where there is no influence by the heat which cookware generates.
 - Areas where not exposed to oil mist, powder and/or steam directly such as above fryer.
 - Areas where lighting device such as fluorescent light or incandescent light doesn't affect the operation.
 (A beam from lighting device sometimes affects the infrared receiver for the wireless remote control and the air-conditioner might not work properly.)

- Check if the place where the air-conditioner is installed can hold the weight of the unit. If it is not able to hold, reinforce the structure with boards and beams strong enough to hold it. If the strength is not enough, it could cause injury due to unit falling.

Space for installation and service

- Make installation altitude over 2.5m. (Indoor Unit)

Select either of two cases to keep space for installation and services.

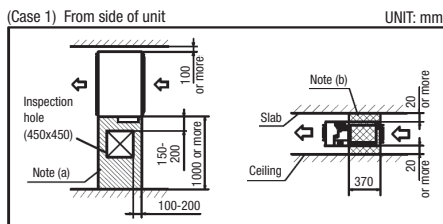

Notes (a) There must not be obstacle to draw out fan motor. (Hatched area)
 (b) Install refrigerant pipe, drain pipe, and wiring so as not to cross (Cross-hatched area).

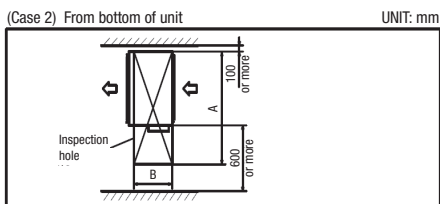

(Size of inspection hole)	UNIT: mm		
Single type	40-50	60-71	100-140
Multi type	22-56	71-90	112-160
A	1100	1300	1720
B	620	725	

3 Preparation before installation

- If suspension bolt becomes longer, do reinforcement of earthquake resistant.
 - For grid ceiling
 When the suspension bolt length is over 500mm, or the gap between the ceiling and roof is over 700mm, apply earthquake resistant brace to the bolt.
 - In case the unit is hung directly from the slab and is installed on the ceiling plane which has enough strength.
 When suspension bolt length is over 1000mm, apply the earthquake resistant brace to the bolt.
- Prepare four (4) sets of suspension bolt, nut and spring washer (M10) on site.

Suspension Bolt Location

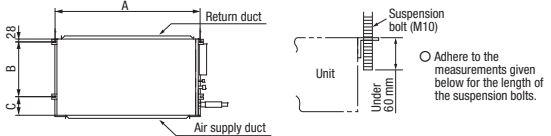

	UNIT: mm		
Multi type	22-56	71, 90	112-160
Single type	40-50	60, 71	100-140
A	786	986	1404
B	472	472	530
C	135	135	180

Pipe locations

	UNIT: mm
Multi type	22-90
Single type	40-71

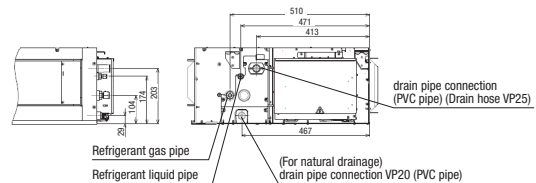

	UNIT: mm
Multi type	112-160
Single type	100-140

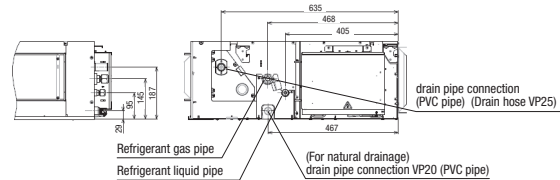

4 Installation of indoor unit

Installation

[Hanging]

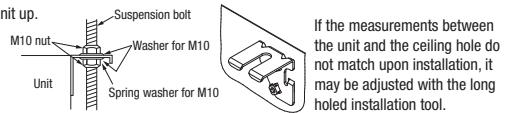

Adjustment for horizontality

- Either use a level vial, or adjust the level according to the method below.

- Adjust so the bottom side of the unit will be leveled with the water surface as illustrated below.

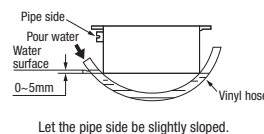

○ If the unit is not leveled, it may cause malfunctions or inoperation of the float switch.

⑤ Duct Work

① A corrugated board (for preventing sputtering) is attached to the main body of the air-conditioner (on the outlet port). Do not remove it until connecting the duct.

● An air filter can be provided on the main body of the air-conditioner (on the inlet port). Remove it when connecting the duct on the inlet port.

② Blowout duct

● Use rectangular duct to connect with unit.
Duct size for each unit is as shown below.

	UNIT: mm		
Single type	40-50	60-71	100-140
Multi type	22-56	71-90	112-140
A	682	882	1202
B	172	172	172

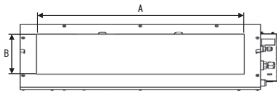

- Duct should be at their minimum length.
- We recommend to use sound and heat insulated duct to prevent it from condensation.
- Connect duct to unit before ceiling attachment.

③ Inlet port

- When shipped the inlet port lies on the back.
- When connecting the duct to the inlet port, remove the air filter if it is fitted to the inlet port.
- When placing the inlet port to carry out suction from the bottom side, use the following procedure to replace the suction duct joint and the bottom plate.

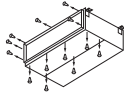

● Remove the screws which fasten the bottom plate and the duct joint on the inlet port side of the unit.

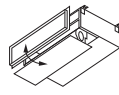

● Replace the removed bottom plate and duct joint.

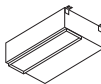

● Fit the duct joint with a screw; fit the bottom plate.

● Make sure to insulate the duct to prevent dewing on it.

④ Install the specific blowout duct in a location where the air will circulate to the entire room.

- Conduct the installation of the specific blowout hole and the connection of the duct before attaching them to the ceiling.
- Insulate the area where the duct is secured by a band for dew condensation prevention.

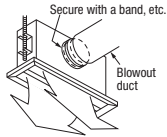

⑤ Make sure provide an inspection hole on the ceiling. It is indispensable to service electric equipment, motor, functional components and cleaning of heat exchanger.

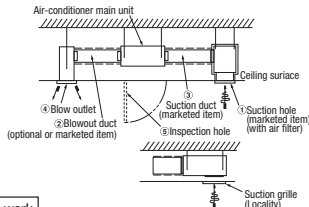

Bad example of duct work

① If a duct is not provided at the suction side but it is substituted with the space over the ceiling, humidity in the space will increase by the influence of capacity of ventilation fan, strength of wind blowing against the out door air louver, weather (rainy day) and others.

a) Moisture in air is likely to condense over the external plates of the unit and to drip on the ceiling. Unit should be operated under the conditions as listed in the above table and within the limitation of wind volume. When the building is a concrete structure, especially immediately after the construction, humidity tends to rise even if the space over the ceiling is not substituted in place of a duct. In such occasion, it is necessary to insulate the entire unit with glass wool (25mm). (Use a wire net or equivalent to hold the glass wool in place.)

b) It may run out the allowable limit of unit operation (Example: When outdoor air temperature is 35°C DB, suction air temperature is 27°C WB) and it could result in such troubles as compressor overload, etc..

c) There is a possibility that the blow air volume may exceed the allowable range of operation due to the capacity of ventilation fan or strength of wind blowing against external air louver so that drainage from be heat exchanger may fall to reach the drain pan but leak outside (Example: drip on to the ceiling) with consequential water leakage in the room.

② If vibration damping is not conducted between the unit and the duct, and between the unit and the slab, vibration will be transmitted to the duct and vibration noise may occur. Also, vibration may be transmitted from the unit to the slab. Vibration damping must be performed.

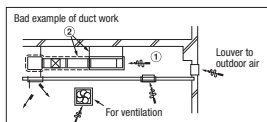

⑤ Duct Work (continued)

Connecting the air intake/vent ducts

① Fresh Air Intake

[for air intake duct only]

○ Use the side fresh air intake hole, or supply through a part of the suction duct.

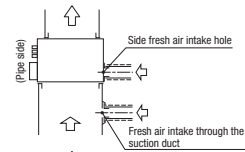

[for simultaneous air intake/vent]

○ Intake air through the suction duct. (the side cannot be used)

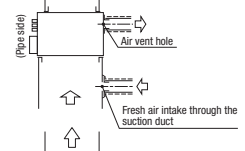

② Air Vent

○ Use the side air vent hole.

(always use together with the air intake)

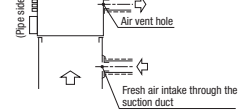

○ Insulate the duct to protect it from dew condensation.

⑥ Refrigerant pipe

Caution

● Be sure to use new pipes for the refrigerant pipes. Use the flare nut attached to the product or a nut compatible with JIS B 8607, Class 2.

Regarding whether existing pipes can be reused or not, and the washing method, refer to the instruction manual of the outdoor unit, catalogue or technical data.

- 1) In case of reuse: Do not use old flare nut, but use the one attached to the unit or compatible with JIS B 8607, Class 2.
- 2) In case of reuse: Flare the end of pipe replaced partially for R410A.

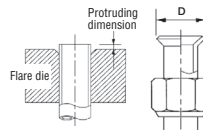

Pipe dia. d mm	Min. pipe wall thickness mm	Protruding dimension for flare, mm		Flare O.D. D mm	Flare nut tightening torque N·m
		Rigid (Clutch type) For R410A	Conventional tool		
6.35	0.8	0	0.7 - 1.3	8.9 - 9.1	14 - 18
9.52	0.8			12.8 - 13.2	24 - 42
12.7	0.8			16.2 - 16.6	49 - 61
15.88	1			19.3 - 19.7	68 - 82
19.05	1.2			23.6 - 24.0	100 - 120

● Use phosphorus deoxidized copper alloy seamless pipe (C1220T specified in JIS H3300) for refrigeration pipe installation.

In addition, make sure there is no damage both inside and outside of the pipe, and no harmful substances such as sulfur, oxide, dust or a contaminant stuck on the pipes.

● Do not use any refrigerant other than R410A.

Using other refrigerant except R410A (R22 etc.) may degrade inside refrigeration oil. And air getting into refrigeration circuit may cause over-pressure and resultant it may result in bursting, etc.

● Store the copper pipes indoors and seal the both end of them until they are brazed in order to avoid any dust, dirt or water getting into pipe. Otherwise it will cause degradation of refrigeration oil and compressor breakdown, etc.

● Use special tools for R410A refrigerant.

Piping work

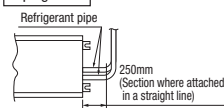

When conducting piping work, make sure to allow the pipes to be aligned in a straight line for at least 250 mm, as shown in the left illustration. (This is necessary for the drain pump to function)

Work procedure

1. Remove the flare nut and blind flanges on the pipe of the indoor unit.
 - ※ Make sure to loosen the flare nut with holding the nut on pipe side with a spanner and giving torque to the nut with another spanner in order to avoid unexpected stress to the copper pipe, and then remove them. (Gas may come out at this time, but it is not abnormal.)
 - Pay attention whether the flare nut pops out. (as the indoor unit is sometimes pressured.)
2. Make a flare on liquid pipe and gas pipe, and connect the refrigeration pipes on the indoor unit.
 - ※ Bend radius of pipe must be 4D or larger. Once a pipe is bent, do not readjust the bending. Do not twist a pipe or collapse to 2/3D or smaller.
 - ※ Do a flare connection as follows:
 - Make sure to loosen the flare nut with holding the nut on pipe side with a spanner and giving torque to the nut with another spanner in order to avoid unexpected stress to the copper pipe, and then remove them.
 - When fastening the flare nut, align the refrigeration pipe with the center of flare nut, screw the nut for 3-4 times by hand and then tighten it by spanner with the specified torque mentioned in the table above. Make sure to hold the pipe on the indoor unit securely by a spanner when tightening the nut in order to avoid unexpected stress on the copper pipe.
3. Cover the flare connection part of the indoor unit with attached insulation material after a gas leakage inspection, and tighten both ends with attached straps.
 - Make sure to insulate both gas pipes and liquid pipes completely.
 - ※ Incomplete insulation may cause dew condensation or water dropping.
 - Use heat-resistant (120 °C or more) insulations on the gas side pipes.
 - In case of using at high humidity condition, reinforce insulation of refrigerant pipes. Surface of insulation may cause dew condition or water dropping, if insulations are not reinforced.

⑥ Refrigerant pipe (continued)

- Refrigerant is charged in the outdoor unit.
As for the additional refrigerant charge for the indoor unit and piping, refer to the installation manual attached to the outdoor unit.

Caution:
Refrigerating machine oil should not be applied to the threads of union or external surface of flare. It is because, even if the same tightening torque is applied, the oil is likely to decrease the slide friction force on the threads and increase, in turn, the axial component force so that it could crack the flare by the stress corrosion.
Refrigerating machine oil may be applied to the internal surface of flare only.

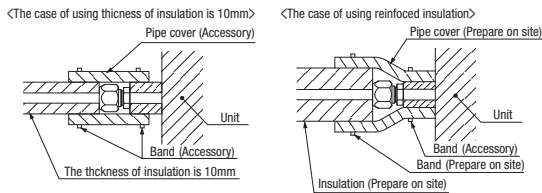

⑦ Drain pipe

Caution

- Install the drain pipe according to the installation manual in order to drain properly. Imperfection in draining may cause flood indoors and wetting the household goods, etc.
- Do not put the drain pipe directly into the ditch where toxic gas such as sulfur, the other harmful and inflammable gas is generated. Toxic gas would flow into the room and it would cause serious damage to user's health and safety (some poisoning or deficiency of oxygen). In addition, it may cause corrosion of heat exchanger and bad smell.
- Connect the pipe securely to avoid water leakage from the joint.
- Insulate the pipe properly to avoid condensation drop.
- Check if the water can flow out properly from both the drain outlet on the indoor unit and the end of the drain pipe after installation.
- Make sure to make descending slope of greater than 1/100 and do not make up-down bend and/or trap in the midway. In addition, do not put air vent on the drain pipe. Check if water is drained out properly from the pipe during commissioning. Also, keep sufficient space for inspection and maintenance.

Work procedure

- Make sure to insert the drain hose (the end made of soft PVC) to the end of the step part of drain socket.
Attach the hose clamp to the drain hose around 10mm from the end, and fasten the screw within 5mm left to the nut.
 - Do not apply adhesives on this end.
 - Do not use acetone-based adhesives to connect to the drain socket.

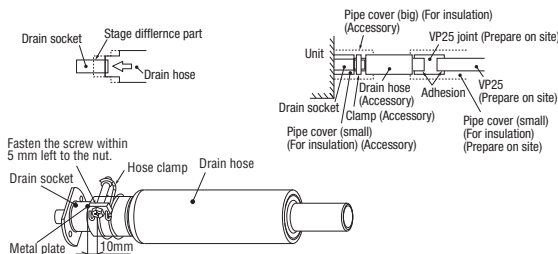

- Prepare a joint for connecting VP-25 pipe, adhere and connect the joint to the drain hose (the end made of rigid PVC), and adhere and connect VP-25 pipe (prepare on site).
 ※As for drain pipe, apply VP-25 made of rigid PVC which is on the market.
 - Make sure that the adhesive will not get into the supplied drain hose. It may cause the flexible part broken after the adhesive is dried up and gets rigid.
 - The flexible drain hose is intended to absorb a small difference at installation of the unit or drain pipes. Intentional bending, expanding may cause the flexible hose broken and water leakage.

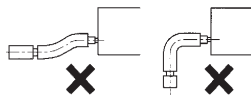

- As for drain pipe, apply VP25 (OD32).
If apply PVC25 (OD25), connect the expanded connector to the drain hose, with adhesive. (Multi unit only)

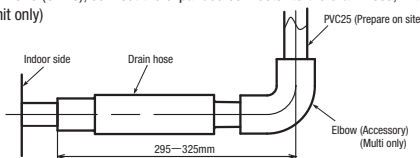

⑦ Drain pipe (continued)

- Make sure to make descending slope of greater than 1/100 and do not make up-down bend and/or trap in the midway.
 - Pay attention not to give stress on the pipe on the indoor unit side, and support and fix the pipe as close place to the unit as possible when connecting the drain pipe.
 - Do not set up air vent.

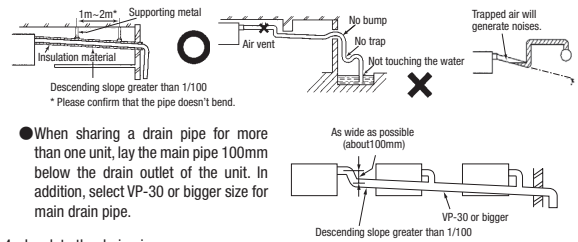

- When sharing a drain pipe for more than one unit, lay the main pipe 100mm below the drain outlet of the unit. In addition, select VP-30 or bigger size for main drain pipe.
- Insulate the drain pipe.
 - Be sure to insulate the drain socket and rigid PVC pipe installed indoors otherwise it may cause dew condensation and water leakage.
 - After drainage test implementation, cover the drain socket part with pipe cover (small size), then use the pipe cover (big size) to cover the pipe cover (small size), clamps and part of the drain hose, and fix and wrap it with tapes to wrap and make joint part gapless.

Drain up

- The position for drain pipe outlet can be raised up to 600mm above the ceiling. Use elbows for installation to avoid obstacles inside ceiling. If the horizontal drain pipe is too long before vertical pipe, the backflow of water will increase when the unit is stopped, and it may cause overflow of water from the drain pan on the indoor unit. In order to avoid overflow, keep the horizontal pipe length and offset of the pipe within the limit shown in the figure below.

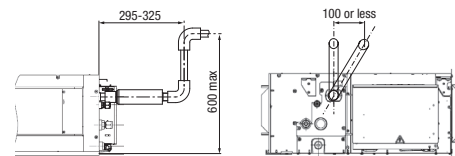

Otherwise, the construction point makes it same as drain pipe construction.

Drain test

- Conduct a drain test after completion of the electrical work.
- During the trial, make sure that drain flows properly through the piping and that no water leaks from connections.
- In case of a new building, conduct the test before it is furnished with the ceiling.
- Be sure to conduct this test even when the unit is installed in the heating season.

Procedures

- Supply about 1000 cc of water to the unit through the air outlet by using a feed water pump.
- Check the drain while cooling operation.

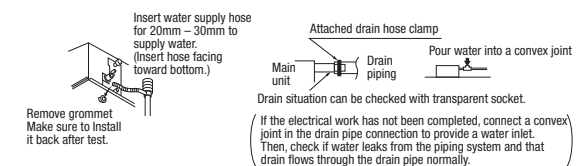

Outline of bottom drain piping work

- If the bottom drain piping can be done with a descending gradient (1/50-1/100), it is possible to connect the pipes as shown in the drawing below.

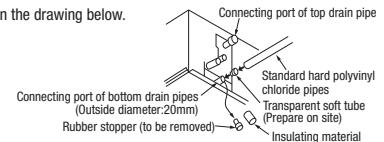

Uncoupling the drain motor connector

- Uncouple the connector CNR for the drain motor as illustrated in the drawing on the right.

(Note: If the unit is run with the connector coupled, drain water will be discharged from the upper drain pipe joint, causing a water leak.)

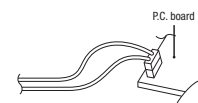

(b) Replacement procedure of the fan unit

Notes(1) The unit is a heavy item. It must be supported securely and handled with care not to drop when it is necessary to replace.

(2) For the maintenance space, refer to page 63.

- (i) Remove the control box and the side panel, and remove the screws marked in the circles (2 places) from the unit located at the near side.

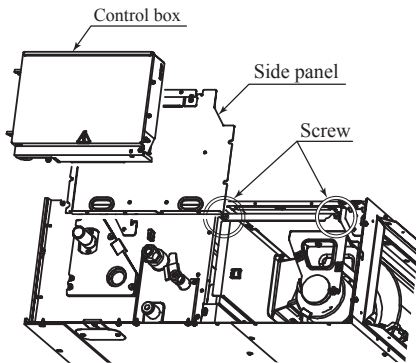

- (ii) Take out the fan unit located at the near side in the arrow direction.

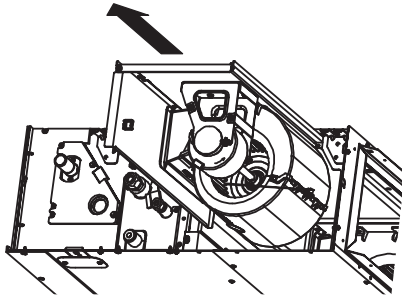

- (iii) Remove the screws marked in the circles (2 places) from the fan unit located at the far side.

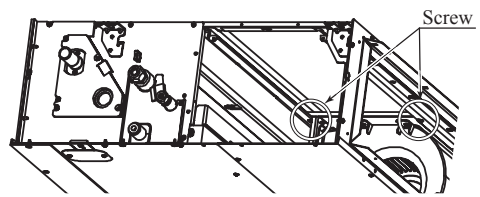

- (iv) Take out the fan unit in the arrow direction.

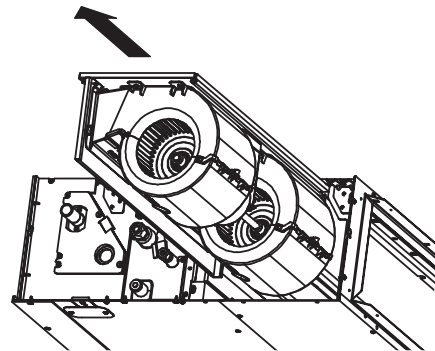







(5) Floor standing type (FDF)





PGA012D404A 

This manual is for the installation of an indoor unit.
For electrical wiring work (Indoor), refer to the page 80. For remote control installation, refer to the page 84. For wireless kit installation, refer to the page 223. For electrical wiring work (Outdoor) and refrigerant pipe work installation for outdoor unit, refer to the page 98.































SAFETY PRECAUTIONS

- Read the "SAFETY PRECAUTIONS" carefully first of all and then strictly follow it during the installation work in order to protect yourself.
- The precautionary items mentioned below are distinguished into two levels,  **WARNING** and  **CAUTION**.
 **WARNING**: Wrong installation would cause serious consequences such as injuries or death.
 **CAUTION**: Wrong installation might cause serious consequences depending on circumstances.
Both mentions the important items to protect your health and safety so strictly follow them by any means.
- The meanings of "Marks" used here are as shown on the right:
 Never do it under any circumstances.  Always do it according to the instruction.
- After completing the installation, do commissioning to confirm there are no abnormalities, and explain to the customers about "SAFETY PRECAUTIONS", correct operation method and maintenance method (air filter cleaning, operation method and temperature setting method) with user's manual of this unit.
Ask your customers to keep this installation manual together with the user's manual. Also, ask them to hand over the user's manual to the new user when the owner is changed.

 **WARNING**

- **Installation should be performed by the specialist.** 
If you install the unit by yourself, it may lead to serious trouble such as water leakage, electric shock, fire, and injury due to overturn of the unit.
- **Install the system correctly according to these installation manuals.** 
Improper installation may cause explosion, injury, water leakage, electric shock, and fire.
- **Check the density referred by the formula (accordance with ISO5149).** 
If the density exceeds the limit density, please consult the dealer and installate the ventilation system.
- **Use the genuine accessories and the specified parts for installation.** 
If parts unspecified by our company are used it could cause water leakage, electric shock, fire, and injury due to overturn of the unit.
- **Ventilate the working area well in case the refrigerant leaks during installation.** 
If the refrigerant contacts the fire, toxic gas is produced.
- **Install the unit in a location that can hold heavy weight.** 
Improper installation may cause the unit to fall leading to accidents.
- **Install the unit properly in order to be able to withstand strong winds such as typhoons, and earthquakes.** 
Improper installation may cause the unit to fall leading to accidents.
- **Do not mix air in to the cooling cycle on installation or removal of the air-conditioner.** 
If air is mixed in, the pressure in the cooling cycle will rise abnormally and may cause explosion and injuries.
- **Be sure to have the electrical wiring work done by qualified electrical installer, and use exclusive circuit.** 
Power source with insufficient capacity and improper work can cause electric shock and fire.
- **Use specified wire for electrical wiring, fasten the wiring to the terminal securely, and hold the cable securely in order not to apply unexpected stress on the terminal.** 
Loose connections or hold could result in abnormal heat generation or fire.
- **Arrange the electrical wires in the control box properly to prevent them from rising. Fit the lid of the services panel properly.** 
Improper fitting may cause abnormal heat and fire.
- **Check for refrigerant gas leakage after installation is completed.** 
If the refrigerant gas leaks into the house and comes in contact with a fan heater, a stove, or an oven, toxic gas is produced.
- **Use the specified pipe, flare nut, and tools for R410A.** 
Using existing parts (R22) could cause the unit failure and serious accident due to explosion of the cooling cycle.
- **Tighten the flare nut according to the specified method by with torque wrench.** 
If the flare nut were tightened with excess torque, it could cause burst and refrigerant leakage after a long period.
- **Do not put the drainage pipe directly into drainage channels where poisonous gases such as sulfide gas can occur.** 
Poisonous gases will flow into the room through drainage pipe and seriously affect the user's health and safety. This can also cause the corrosion of the indoor unit and a resultant unit failure or refrigerant leak.
- **Connect the pipes for refrigeration circuit securely in installation work before compressor is operated.** 
If the compressor is operated when the service valve is open without connecting the pipe, it could cause explosion and injuries due to abnormal high pressure in the system.
- **Stop the compressor before removing the pipe after shutting the service valve on pump down work.** 
If the pipe is removed when the compressor is in operation with the service valve open, air would be mixed in the refrigeration circuit and it could cause explosion and injuries due to abnormal high pressure in the cooling cycle.
- **Only use prescribed option parts. The installation must be carried out by the qualified installer.** 
If you install the system by yourself, it can cause serious trouble such as water leaks, electric shocks, fire.
- **Do not repair by yourself. And consult with the dealer about repair.** 
Improper repair may cause water leakage, electric shock or fire.
- **Consult the dealer or a specialist about removal of the air-conditioner.** 
Improper installation may cause water leakage, electric shock or fire.
- **Turn off the power source during servicing or inspection work.** 
If the power is supplied during servicing or inspection work, it could cause electric shock and injury by the operating fan.
- **Do not run the unit when the panel or protection guard are taken off.** 
Touching the rotating equipment, hot surface, or high voltage section could cause an injury to be caught in the machine, to get burned, or electric shock.
- **Shut off the power before electrical wiring work.** 
It could cause electric shock, unit failure and improper running.

 **CAUTION**

- **Perform earth wiring surely.** 
Do not connect the earth wiring to the gas pipe, water pipe, lightning rod and telephone earth wiring. Imperfect earth work (grounding) could cause an electric shock or fire if some trouble or earth leakage occurs.
- **Earth leakage breaker must be installed.** 
Unless the earth leakage circuit breaker is provided, it could cause a fire or electric shock.
- **Use the circuit breaker of correct capacity. Circuit breaker should be the one that disconnect all poles under over current.** 
Using the incorrect one could cause the system failure and fire.
- **Do not use any materials other than a fuse of correct capacity where a fuse should be used.** 
Connecting the circuit by wire or copper wire could cause unit failure and fire.
- **Do not install the indoor unit near the location where there is possibility of flammable gas leakages.** 
If the gas leaks and gathers around the unit, it could cause fire.
- **Do not install and use the unit where corrosive gas (such as sulfurous acid gas etc.) or flammable gas (such as thinner, petroleum etc.) may be generated or accumulated, or volatile flammable substances are handled.** 
It could cause the corrosion of heat exchanger, breakage of plastic parts etc. And inflammable gas could cause fire.
- **Secure a space for installation, inspection and maintenance specified in the manual.** 
Insufficient space can result in accident such as personal injury due to falling from the installation place.
- **Do not use the indoor unit at the place where water splashes such as laundry.** 
Indoor unit is not waterproof. It could cause electric shock and fire.
- **Do not use the indoor unit for a special purpose such as food storage, cooling for precision instrument, preservation of animals, plants, and a work of art.** 
It could cause the damage of the items.
- **Do not install nor use the system near equipments which generate electromagnetic wave or high harmonics.** 
Equipments like inverter equipment, private power generator, high-frequency medical equipment, or telecommunication equipment might influence the air-conditioner and cause a malfunction and breakdown. Or the air-conditioner might influence medical equipments or telecommunication equipments, and obstruct their medical activity or cause jamming.
- **Do not install the remote control at the direct sunlight.** 
It could cause breakdown or deformation of the remote control.
- **Do not install the indoor unit at the place listed below.** 
 - Places where flammable gas could leak.
 - Places where carbon fiber, metal powder or any powder is floated.
 - Place where the substances which affect the air-conditioner are generated such as sulfide gas, chlorine gas, acid, alkali or ammoniac atmospheres.
 - Places exposed to oil mist or steam directly.
 - On vehicles and ships
 - Places where machinery which generates high harmonics is used.
 - Places where cosmetics or special sprays are frequently used.
 - Highly salted area such as beach.
 - Heavy snow area
 - Places where the system is affected by smoke from a chimney.
 - Altitude over 1000m
- **Do not install the indoor unit in the locations listed below (Be sure to install the indoor unit according to the installation manual for each model because each indoor unit has each limitation)** 
 - Locations with any obstacles which can prevent inlet and outlet air of the unit
 - Locations where vibration can be amplified due to insufficient strength of structure.
 - Locations where the infrared receiver is exposed to the direct sunlight or the strong light beam. (in case of the infrared specification unit)
 - Locations where an equipment affected by high harmonics is placed. (TV set or radio receiver is placed within 5m)
 - Locations where drainage cannot run off safely.
 - It can affect performance or function and etc.
- **Do not put any valuables which will break down by getting wet under the air-conditioner.** 
Condensation could drop when the relative humidity is higher than 80% or drain pipe is clogged, and it damages user's belongings.
- **Do not use the base frame for the outdoor unit which is corroded or damaged after a long period of use.** 
It could cause the unit falling down and injury.
- **Pay attention not to damage the drain pan by weld sputter when brazing work is done near the unit.** 
If sputter entered into the unit during brazing work, it could cause damage (pinhole) of drain pan and leakage of water. To avoid damaging, keep the indoor unit packed or cover the indoor unit.
- **Install the drain pipe to drain the water surely according to the installation manual.** 
Improper connection of the drain pipe may cause drooping water into room and damaging user's belongings.
- **Do not share the drain pipe for indoor unit and GHP (Gas Heat Pump system) outdoor unit.** 
Toxic exhaust gas would flow into room and it might cause serious damage (some poisoning or deficiency of oxygen) to user's health and safety.
- **Be sure to perform air tightness test by pressurizing with nitrogen gas after completed refrigerant piping work.** 
If the density of refrigerant exceeds the limit in the event of refrigerant leakage in the small room, lack of oxygen can occur, which can cause serious accidents.
- **For drain pipe installation, be sure to make descending slope of greater than 1/100, not to make traps, and not to make air-bleeding.** 
Check if the drainage is correctly done during commissioning and ensure the space for inspection and maintenance.
- **Ensure the insulation on the pipes for refrigeration circuit so as not to condense water.** 
Incomplete insulation could cause condensation and it would wet ceiling, floor, and any other valuables.
- **Do not install the outdoor unit where is likely to be a nest for insects and small animals.** 
Insects and small animals could come into the electronic components and cause breakdown and fire. Instruct the user to keep the surroundings clean.
- **Pay extra attention, carrying the unit by hand.** 
Carry the unit with 2 people if it is heavier than 20kg. Do not use the plastic straps but the grabbing place, moving the unit by hand. Use protective gloves in order to avoid injury by the aluminum fin.
- **Make sure to dispose of the packaging material.** 
Leaving the materials may cause injury as metals like nail and woods are used in the package.
- **Do not operate the system without the air filter.** 
It may cause the breakdown of the system due to clogging of the heat exchanger.
- **Do not touch any button with wet hands.** 
It could cause electric shock.
- **Do not touch the refrigerant piping with bare hands when in operation.** 
The pipe during operation would become very hot or cold according to the operating condition, and it could cause a burn or frostbite.
- **Do not clean up the air-conditioner with water.** 
It could cause electric shock.
- **Do not turn off the power source immediately after stopping the operation.** 
Be sure to wait for more than 5 minutes. Otherwise it could cause water leakage or breakdown.
- **Do not control the operation with the circuit breaker.** 
It could cause fire or water leakage. In addition, the fan may start operation unexpectedly and it may cause injury.

① Before installation

- Install the unit properly according to this instruction manual.
- Is it in accordance with the construction plan?

Model and power supply specification

Check.

Pipes, wires and small parts

Accessory

(1) For heat insulation of flare nut *1

1	Pipe cover		1 pc	For gas side
2	Pipe cover		1 pc	For liquid side
3	Strap		4 pcs	

(2) For installation Note) Nos. 1 and 5 are used also as hardware for packing.

1	Fall-prevention fitting		1 pc	*3
2	Wood screw		2 pcs	For No. 1
3	Washer		2 pcs	For No. 2 wood screw
4	Rubber bushing		1 pc	For refrigerant and drain pipes
5	L fitting		2 pcs	*4

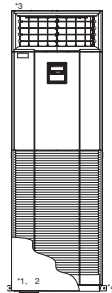

Where the accessories are put in

- *1. Open the air inlet grill and Nos. (1) will be found in the unit.
- *2. Nos. (2)-2-4 will be found at the same place as 1.
- *3. Fall-prevention fitting is mounting on the top panel of the unit.
- *4. L-fittings are mounted on the bottom part of the unit.

② Selection of installation place for the indoor unit

- Select the suitable areas to install the unit under approval of the user.
 - Areas where the indoor unit can deliver hot and cold wind sufficiently. Suggest to the user to use a circulator if the ceiling height is over 3m to avoid warm air being accumulated on the ceiling.
 - Areas where there is enough space to install and service.
 - Areas where it can be drained properly. Areas where drain pipe descending slope can be taken.
 - Areas where there is no obstruction of airflow on both air return grille and air supply port.
 - Areas where the fire alarm will not be accidentally activated by the air-conditioner.
 - Areas where the supply air does not short-circuit.
 - Areas where it is not influenced by draft air.
 - Areas not exposed to direct sunlight.
 - Areas where dew point is lower than around 23°C and relative humidity is lower than 80%.
- This indoor unit is tested under the condition of JIS (Japan Industrial Standard) high humidity condition and confirmed there is no problem. However, there is some risk of condensation drop if the air-conditioner is operated under the severer condition than mentioned above.
If there is a possibility to use it under such a condition, attach additional insulation of 10 to 20mm thick for entire surface of indoor unit, refrigeration pipe and drain pipe.
- Areas where TV and radio stays away more than 1m. (It could cause jamming and noise.)
 - Areas where any items which will be damaged by getting wet are not placed such as food, table wares, server, or medical equipment under the unit.
 - Areas where there is no influence by the heat which cookware generates.
 - Areas where not exposed to oil mist, powder and/or steam directly such as above fryer.
 - Areas where lighting device such as fluorescent light or incandescent light doesn't affect the operation. (A beam from lighting device sometimes affects the infrared receiver for the wireless remote control and the air-conditioner might not work properly.)
 - When operating the suction air processing unit independently, it operates in the outdoor air processing mode.
- Blowout temperatures are not same at the standard unit operation and the outdoor air processing mode operations.
Since the temperatures become higher during cooling or lower during heating, take care of the direction of blowout outlet.
- Check if the place where the air conditioner is installed can hold the weight of the unit. If it is not able to hold, reinforce the structure with boards and beams strong enough to hold it. If the strength is not enough, it could cause injury due to unit falling.

Space for installation and service

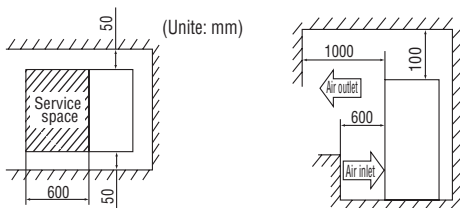

- Secure sufficient spaces for inspection and maintenance.

WARNING

- Install the unit securely on a floor that can endure its weight sufficiently. Insufficient strength or incorrect installation could result in injuries if the unit falls.

ATTENTION: Select a place for installation where the following conditions are fulfilled with customer's consent.

- Where cool or hot air can be blown sufficiently and widely.
 - Where the piping and wiring work to outdoor unit can be done easily.
 - Where drainage water can run off completely.
 - Where the installation floor is strong enough.
 - Where the unit is protected from direct exposure to sunlight.
 - Where there is no obstacle at the air inlet and air outlet.
 - Where the fire alarm apparatus will not be activated by malfunction.
- Where There is no risk for short-circuit of air.

③ Carrying-in and installation of the unit

Carrying-in

Carry with the front face at top.

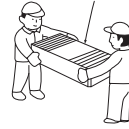

ATTENTION:

- Carry in the unit kept in a package as near as possible to the installation place.
- When it is necessary to unpack the unit before carrying in, sufficient care must be taken not to damage it by using nylon slings or the like. **Note)** Do not hold on the air inlet grill, air outlet louver or other sections made of plastics.
- When placing the unit on the floor after unpacking, be sure to have its front face at the top.

ATTENTION:

- Be sure to fix the unit with L-fittings and the fall-prevention fitting.
- Since the unit is tall, secure the unit no sooner than setting it in place.

Procedure for preventing the unit from falling

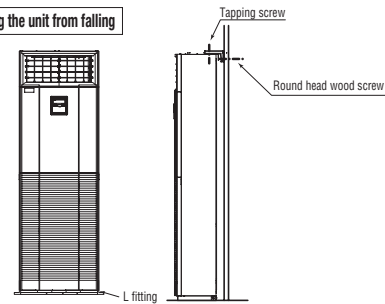

Fall-prevention fitting

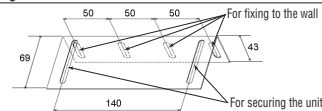

Top panel

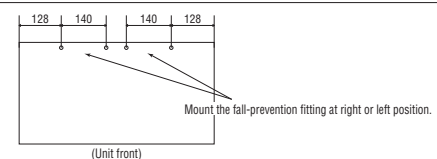

(1) Fixing the unit with the fall-prevention fitting

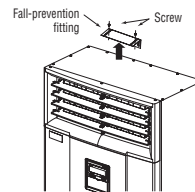

- Loosen screws (2 pcs) and remove the fall-prevention fitting.
- Select a position to fix the fall-prevention fitting as illustrated and fix it to the top of unit and the wall.
 - The fixing position of the fall-prevention fitting is as illustrated below.

Fixing position (Fall-prevention fitting)

Fitting facing upward

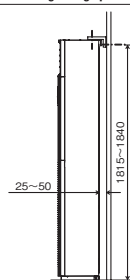

Fitting facing downward

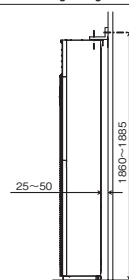

- Dimensions indicate the allowance for adjustment between the unit and the wall or floor.
- Fix the longer side of fitting to the unit.
- When the fitting is faced downward, fix it to the wall first.

③ Carrying-in and installation of the unit (Continued)

(2) Fixing the unit with the L-fittings

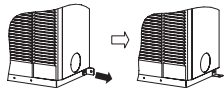

- ① Remove the L-fittings mounted on the unit with screws.
 - ② Turn over the L-fitting and fix it to the unit and either the floor or the wall as illustrated.
- Fixing position of the L-fittings are as illustrated below.

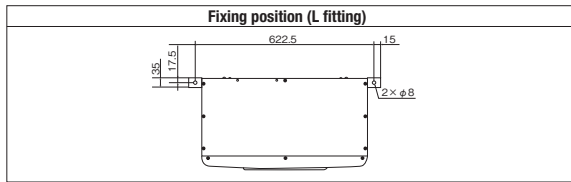

ATTENTION:

- Install the unit on the level.
- Inclination must be less than 1° in fore-aft and right-left directions.

④ Refrigerant piping

Caution

- Be sure to use new pipes for the refrigerant pipes. Use the flare nut attached to the product or a nut compatible with JIS B 8607, Class 2.

Regarding whether existing pipes can be reused or not, and the washing method, refer to the instruction manual of the outdoor unit, catalogue or technical data.

- 1) In case of reuse: Do not use old flare nut, but use the one attached to the unit or compatible with JIS B 8607, Class 2.
- 2) In case of reuse: Flare the end of pipe replaced partially for R410A.

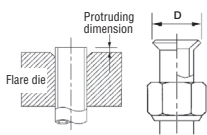

Pipe dia. d mm	Min. pipe wall thickness mm	Protruding dimension for flare, mm		Flare O.D. D mm	Flare nut tightening torque N·m
		For R410A	Conventional tool		
6.35	0.8	0 - 0.5	0.7 - 1.3	8.9 - 9.1	14 - 18
9.52	0.8			12.8 - 13.2	34 - 42
12.7	0.8			16.2 - 16.6	49 - 61
15.88	1			19.3 - 19.7	68 - 82
19.05	1.2			23.6 - 24.0	100 - 120

- Use phosphorus deoxidized copper alloy seamless pipe (C1220T specified in JIS H 3300) for refrigeration pipe installation. In addition, make sure there is no damage both inside and outside of the pipe, and no harmful substances such as sulfur, oxide, dust or a contaminant stuck on the pipes.
- Do not use any refrigerant other than R410A. Using other refrigerant except R410A (R22 etc.) may degrade inside refrigeration oil. And air getting into refrigeration circuit may cause over-pressure and resultant it may result in bursting, etc.
- Store the copper pipes indoors and seal the both end of them until they are brazed in order to avoid any dust, dirt or water getting into pipe. Otherwise it will cause degradation of refrigeration oil and compressor breakdown, etc.
- Use special tools for R410A refrigerant.

Work procedure

1. Remove the flare nut and blind flanges on the pipe of the indoor unit.
 - ※ Make sure to loosen the flare nut with holding the nut on pipe side with a spanner and giving torque to the nut with another spanner in order to avoid unexpected stress to the copper pipe, and then remove them. (Gas may come out at this time, but it is not abnormal.)
 - Pay attention whether the flare nut pops out. (as the indoor unit is sometimes pressured.)
2. Make a flare on liquid pipe and gas pipe, and connect the refrigeration pipes on the indoor unit.
 - ※ Bend radius of pipe must be 4D or larger. Once a pipe is bent, do not readjust the bending. Do not twist a pipe or collapse to 2/3D or smaller.
 - ※ Do a flare connection as follows:
 - Make sure to loosen the flare nut with holding the nut on pipe side with a spanner and giving torque to the nut with another spanner in order to avoid unexpected stress to the copper pipe, and then remove them.
 - When fastening the flare nut, align the refrigeration pipe with the center of flare nut, screw the nut for 3-4 times by hand and then tighten it by spanner with the specified torque mentioned in the table above. Make sure to hold the pipe on the indoor unit securely by a spanner when tightening the nut in order to avoid unexpected stress on the copper pipe.
3. Cover the flare connection part of the indoor unit with attached insulation material after a gas leakage inspection, and tighten both ends with attached straps.
 - Make sure to insulate both gas pipes and liquid pipes completely.
 - ※ Incomplete insulation may cause dew condensation or water dropping.
 - Use heat-resistant (120 °C or more) insulations on the gas side pipes.
 - In case of using at high humidity condition, reinforce insulation of refrigerant pipes. Surface of insulation may cause dew condensation or water dropping, if insulations are not reinforced.
4. Refrigerant is charged in the outdoor unit. As for the additional refrigerant charge for the indoor unit and piping, refer to the installation manual attached to the outdoor unit.

Caution:

Refrigerating machine oil should not be applied to the threads of union or external surface of flare. It is because, even if the same tightening torque is applied, the oil is likely to decrease the slide friction force on the threads and increase, in turn, the axial component force so that it could crack the flare by the stress corrosion.

Refrigerating machine oil may be applied to the internal surface of flare only.

<The case of using thickness of insulation is 10mm>

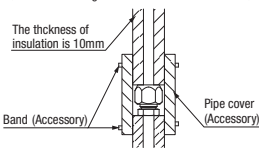

<The case of using reinforced insulation>

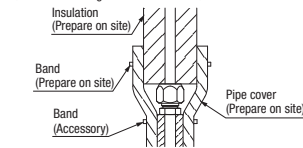

④ Refrigerant piping (Continued)

◆ Pipe and wire extracting position

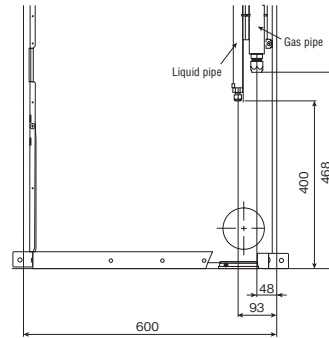

ATTENTION:

- Do not cut off the flange at the hole on the base plate for the downward extraction.



Downward extraction

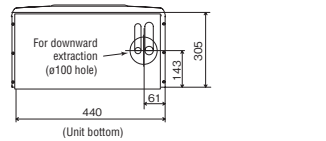
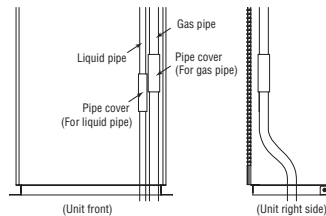

Backward extraction

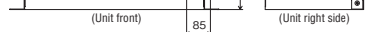
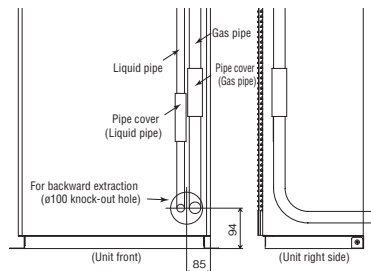

Sideward extraction

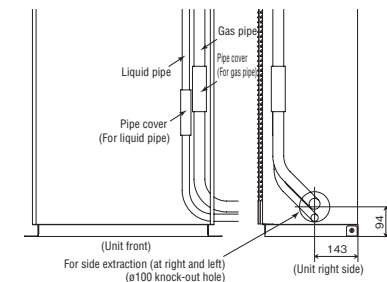

⑤ Drain pipe

⚠ WARNING

- Do not insert the drain pipe directly in the drain ditch where toxic gases such as sulfuric gas are produced. Toxic gas may flow into the room.

⚠ CAUTION

- Install the drain pipe properly according to the installation manual and insulate it to prevent from dew condensation. Improper installation of drain pipe may cause damage of furniture drainage water leaked or dew condensation.

Procedure

- Connect the drain socket to the drain pipe (VP-20) provided at site and fix the joint with adhesive tape, or the like.
- When the pipe provided at site runs through a room, insulate the pipe with a commercial insulator (Polyethylene foam: Specific gravity 0.03, thickness 15 mm or more) to prevent dewing.

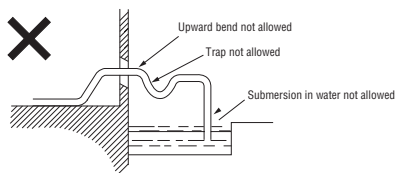
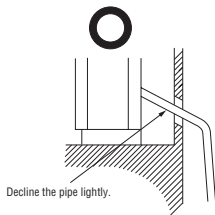
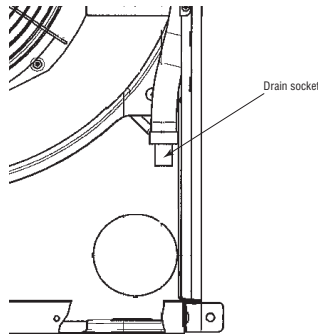

ATTENTION:

- Insulate the drain pipe to prevent dewing. (Especially in room and unit)
- Incline the drain pipe downward to the outlet (1/50 – 1/100). Upward bend or trap is not allowed on the way.
- Use a commercial hard polyvinyl chloride pipe, PV-20, for the drain pipe. <Use of adhesive agent is prohibited.>

⑥ Wire extracting position and wire connect

Control box position and power cable connection

- Electric work must be made by qualified electricians according to the "Engineering standards concerning electric equipment", "Extension wiring regulations" and the electric wiring work manual. Be sure to use dedicated electric circuits.
- Make sure to use specified wires for wiring, and connect them securely. Clamp the wires to protect the terminal connection from external force.
- Make sure to protect the unit with the D-type grounding work.
- For details of wiring work, refer to the attached electric wiring work manual.

⑥ Wire extracting position and wire connect (Continued)

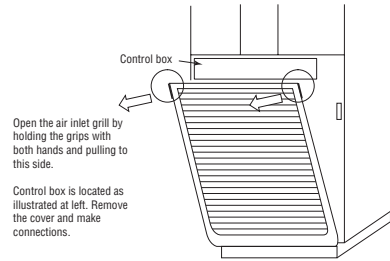

Procedure

- Remove the control box cover (fixed with a screw).
- Introduce wires in the unit and connect securely on the terminals.
- Fix each wire with a clamp (for fixing).
- Install removed parts as they were.

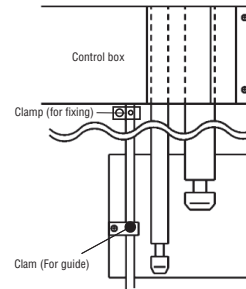

- Make sure to pass the power cable through the clamp (for guide).

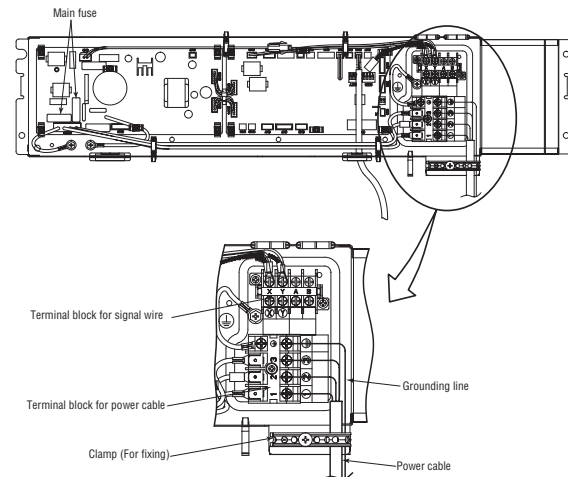

Main fuse specification

Specification	Part No.
T3.15A L250V	SSA564A149AF

⑦ Check list after installation

- Check the following items after all installation work completed.

Check if;	Expected trouble	Check
The indoor and outdoor units are fixed securely?	Falling, vibration, noise	
Inspection for gas leakage is done?	Insufficient capacity	
Insulation work is properly done?	Water leakage	
Water is drained properly?	Water leakage	
Power source voltage is same as mentioned in the model name plate?	PCB burnt out, not working at all	
There is mis-wiring or mis-connection of piping?	PCB burnt out, not working at all	
Earth wiring is connected properly?	Electric shock	
Cable size comply with specified size?	PCB burnt out, not working at all	
Any obstacle blocks airflow on air inlet and outlet?	Insufficient capacity	

(6) Wall mounted type (SRK)

RLD012A001

- This installation manual illustrates the method of installing an indoor unit.
- For electrical wiring work, see instructions set out on the backside.
- For outdoor unit installation and refrigerant piping, refer to page 98.

- A wired remote control unit is supplied separately as an option part.
- While installing the unit, be sure to check the selection of installation place, power source specifications, usage limitation (piping length, height differences between indoor and outdoor units, power source voltage etc.) and installation spaces.

SAFETY PRECAUTIONS

- Before installation, read the "SAFETY PRECAUTIONS" carefully and strictly follow it during the installation work in order to protect yourself.
 - The precautionary items mentioned below are distinguished into two levels, **⚠ WARNING** and **⚡ CAUTION**.
 - **⚠ WARNING**: Wrong installation would cause serious consequences such as injuries or death.
 - **⚡ CAUTION**: Wrong installation might cause serious consequences depending on circumstances.
- Both mention the important items to protect your health and safety so strictly follow them by any means.
- Be sure to confirm no anomaly on the equipment by commissioning after completed installation and explain the operating methods as well as the maintenance methods of this equipment to the user according to the owner's manual.

- Keep the installation manual together with owner's manual at a place where any user can read at any time. Moreover if necessary, ask to hand them to a new user.
- Before starting the installation work, proper precautions (using suitable protective clothing, groves etc.) should be taken by qualified installer.
- Pay attention not to fall down the tools, etc. when installing the unit at the high position.
- If unusual noise can be heard during operation, consult the dealer.
- The meanings of "Marks" used here are shown as follows:

 Never do it under any circumstances.

 Always do it according to the instruction.

⚠ WARNING

- **Installation must be carried out by the qualified installer.**
If you install the system by yourself, it may cause serious trouble such as water leaks, electric shocks, fire and personal injury, as a result of a system malfunction. Do not carry out the installation and maintenance work except the by qualified installer.
 - **Install the system in full accordance with the installation manual.**
Incorrect installation may cause bursts, personal injury, water leaks, electric shocks and fire.
 - **Be sure to use only for household and residence.**
If this appliance is installed in inferior environment such as machine shop and etc., it can cause malfunction.
 - **Use the original accessories and the specified components for installation.**
If parts other than those prescribed by us are used, it may cause water leaks, electric shocks, fire and personal injury.
 - **Install the unit in a location with good support.**
Unsuitable installation locations can cause the unit to fall resulting in material damage and personal injury.
 - **Ventilate the working area well in the event of refrigerant leakage during installation.**
If the refrigerant comes into contact with naked flames, poisonous gas is produced.
 - **When installing in small rooms, take prevention measures not to exceed the density limit of refrigerant in the event of leakage, referred by the formula (accordance with ISO5149).**
If the density of refrigerant exceeds the limit, consult the dealer and install the ventilation system, otherwise lack of oxygen can occur, which can cause serious accident.
 - **After completing installation, check that no refrigerant leaks from the system.**
If refrigerant leaks into the room and comes into contact with an oven or other hot surface, poisonous gas is produced.
 - **Use the prescribed pipes, flare nuts and tools for R410A.**
Using existing parts (for R22 or R407C) can cause the unit failure and serious accidents due to burst of the refrigerant circuit.
- **Tighten the flare nut by torque wrench with specified method.**
If the flare nuts were tightened with excess torque, this may cause burst and refrigerant leakage after a long period.
 - **The electrical installation must be carried out by the qualified electrician in accordance with "the norm for electrical work" and "national wiring regulation", and the system must be connected to the dedicated circuit.**
Power source with insufficient capacity and incorrect function done by improper work can cause electric shocks and fire.
 - **Be sure to shut off the power before starting electrical work.**
Failure to shut off the power can cause electric shocks, unit failure or incorrect function of equipment.
 - **Be sure to use the cables conformed to safety standard and cable ampacity for power distribution work.**
Unconformable cables can cause electric leak, anomalous heat production or fire.
 - **This appliance must be connected to main power source by means of a circuit breaker or switch [fuse Model 63(21):16A, Model 71(24), 80(28), 92, 100:20A] with a contact separation of at least 3mm.**
 - **When plugging this appliance, a plug conforming to the norm IEC60884-1 must be used.**
 - **Use the prescribed cables for electrical connection, tighten the cables securely in terminal block and relieve the cables correctly to prevent overloading the terminal blocks.**
Loose connections or cable mountings can cause anomalous heat production or fire.
 - **Arrange the wiring in the control box so that it cannot be pushed up further into the box. Install the service panel correctly.**
Incorrect installation may result in overheating and fire.
 - **Be sure to switch off the power source in the event of installation, inspection or servicing.**
If the power source is not shut off, there is a risk of electric shocks, unit failure or personal injury due to the unexpected start of fan.
 - **Be sure to wear protective goggles and gloves while at work.**
 - **Earth leakage breaker must be installed.**
If the earth leakage breaker is not installed, it can cause electric shocks.
- **Do not bundle or wind or process the power cord. Do not deform the power cord by treading it.**
This may cause fire or heating.
 - **Do not vent R410A into the atmosphere: R410A is a fluorinated greenhouse gas, covered by the Kyoto Protocol with Global Warming Potential (GWP)=1975.**
 - **Do not run the unit with removed panels or protections.**
Touching rotating equipments, hot surfaces or high voltage parts can cause personal injury due to entrapment, burn or electric shocks.
 - **Do not perform any change of protective device itself or its setup condition.**
The forced operation by short-circuiting protective device of pressure switch and temperature controller or the use of non specified component can cause fire or burst.
- **Do not put the drainage pipe directly into drainage channels where poisonous gases such as sulphide gas can occur.**
Poisonous gases will flow into the room through drainage pipe and seriously affect the user's health and safety. This can also cause the corrosion of the indoor unit and a resultant unit failure or refrigerant leak.
 - **Ensure that no air enters in the refrigerant circuit when the unit is installed and removed.**
If air enters in the refrigerant circuit, the pressure in the refrigerant circuit becomes too high, which can cause burst and personal injury.
 - **Do not process or splice the power cord, or share the socket with other power plugs.**
This may cause fire or electric shock due to defecting contact, defecting insulation and over-current etc.

⚡ CAUTION

- **Carry out the electrical work for ground lead with care.**
Do not connect the ground lead to the gas line, water line, lightning conductor or telephone line's ground lead. Incorrect grounding can cause unit faults such as electric shocks due to short-circuiting.
 - **Use the circuit breaker of correct capacity. Circuit breaker should be able to disconnect all poles under over current.**
Using the incorrect one could cause the system failure and fire.
 - **Install isolator or disconnect switch on the power source wiring in accordance with the local codes and regulations.**
The isolator should be locked in OFF state in accordance with EN60204-1.
 - **Be sure to install indoor unit properly according to instruction manual so that drainage can run off smoothly.**
Improper installation of indoor unit can cause dropping water into the room and damaging personal property.
 - **Install the drainage pipe to run off drainage securely according to the installation manual.**
Incorrect installation of the drainage pipe can cause dropping water into the room and damaging personal property.
 - **Be sure to install the drainage pipe with descending slope of 1/100 or more, and not to make traps and air-bleedings.**
Check if the drainage runs off securely during commissioning and ensure the space for inspection and maintenance.
 - **After maintenance, all wiring, wiring ties and the like, should be returned to their original state and wiring route, and the necessary clearance from all metal parts should be secured.**
 - **Secure a space for installation, inspection and maintenance specified in the manual.**
Insufficient space can result in accident such as personal injury due to falling from the installation place.
 - **Take care when carrying the unit by hand.**
- If the unit weights more than 20kg, it must be carried by two or more persons. Do not carry by the plastic straps, always use the carry handle when carrying the unit by hand. Use gloves to minimize the risk of cuts by the aluminum fins.
- **Dispose of any packing materials correctly.**
Any remaining packing materials can cause personal injury as it contains nails and wood. And to avoid danger of suffocation, be sure to keep the plastic wrapper away from children and to dispose after tear it up.
 - **For installation work, be careful not to get injured with the heat exchanger, piping flare portion or screws etc.**
 - **Be sure to insulate the refrigerant pipes so as not to condense the ambient air moisture on them.**
Insufficient insulation can cause condensation, which can lead to moisture damage on the ceiling, floor, furniture and any other valuables.
 - **When perform the air-conditioner operation (cooling or dehumidifying operation) in which ventilator is installed in the room. In this case, using the air-conditioner in parallel with the ventilator, there is the possibility that drain water may backflow in accordance with the room lapse into the negative pressure status. Therefore, set up the opening port such as incorporate the air into the room that may appropriate to ventilation (For example; Open the door a little). In addition, just as above, so set up the opening port if the room lapse into negative pressure status due to register of the wind for the high rise apartment etc.**
 - **Be sure to perform air tightness test by pressurizing with nitrogen gas after completed refrigerant piping work.**
If the density of refrigerant exceeds the limit in the event of refrigerant leakage in the small room, lack of oxygen can occur, which can cause serious accidents.
- **Do not install the unit in the locations listed below.**
 - Locations where carbon fiber, metal powder or any powder is floating.
 - Locations where any substances that can affect the unit such as sulphide gas, chloride gas, acid and alkaline can occur.
 - Vehicles and ships.
 - Locations where cosmetic or special sprays are often used.
 - Locations with direct exposure of oil mist and steam such as kitchen and machine plant.
 - Locations where any machines which generate high frequency harmonics are used.
 - Locations with salty atmospheres such as coastlines.
 - Locations with heavy snow (If installed, be sure to provide base flame and snow hood mentioned in the manual).
 - Locations where the unit is exposed to chimney smoke.
 - Locations at high altitude (more than 1000m high).
 - Locations with ammoniac atmospheres (e.g. organic fertilizer).
 - Locations with calcium chloride (e.g. snow melting agent).
 - Locations where heat radiation from other heat source can affect the unit.
 - Locations without good air circulation.
 - Locations with any obstacles which can prevent inlet and outlet air of the unit.
 - Locations where short circuit of air can occur (in case of multiple units installation).
 - Locations where strong air blows against the air outlet of outdoor unit.
 - Locations where something located above the unit could fall.
It can cause remarkable decrease in performance, corrosion and damage of components, malfunction and fire.
 - **Do not install the indoor unit in the locations listed below (Be sure to install the indoor unit according to the installation manual for each model because each indoor unit has each limitation).**
 - Locations with any obstacles which can prevent inlet and outlet air of the unit.
 - Locations where vibration can be amplified due to insufficient strength of structure.
 - Locations where the infrared receiver is exposed to the direct sunlight or the strong light beam (in case of the infrared specification unit).
 - Locations where an equipment affected by high harmonics is placed (TV set or radio receiver is placed within 1m).
 - Locations where drainage cannot run off safely.
It can affect performance or function and etc.
 - **Do not install the unit near the location where leakage of combustible gases can occur.**
- If leaked gases accumulate around the unit, it can cause fire.
- **Do not install the unit where corrosive gas (such as sulfurous acid gas etc.) or combustible gas (such as thinner and petroleum gases) can accumulate or collect, or where volatile combustible substances are handled.**
Corrosive gas can cause corrosion of heat exchanger, breakage of plastic parts and etc. And combustible gas can cause fire.
 - **Do not use the indoor unit at the place where water splashes may occur such as in laundries.**
Since the indoor unit is not waterproof, it can cause electric shocks and fire.
 - **Do not install nor use the system close to the equipment that generates electromagnetic fields or high frequency harmonics.**
Equipment such as inverters, standby generators, medical high frequency equipments and telecommunication equipments can affect the system, and cause malfunctions and breakdowns. The system can also affect medical equipment and telecommunication equipment, and obstruct its function or cause jamming.
 - **Do not place any variables which will be damaged by getting wet under the indoor unit.**
When the relative humidity is higher than 80% or drainage pipe is clogged, condensation or drainage water can drop and it can cause the damage of valuables.
 - **Do not install the remote control at the direct sunlight.**
It can cause malfunction or deformation of the remote control.
 - **Do not use the unit for special purposes such as storing foods, cooling precision instruments and preservation of animals, plants or art.**
It can cause the damage of the items.
 - **Do not use any materials other than a fuse with the correct rating in the location where fuses are to be used.**
Connecting the circuit with copper wire or other metal thread can cause unit failure and fire.
 - **Do not touch any buttons with wet hands.**
It can cause electric shocks.
 - **Do not touch any refrigerant pipes with your hands when the system is in operation.**
During operation the refrigerant pipes become extremely hot or extremely cold depending the operating condition, and it can cause burn injury or frost injury.
 - **Do not wash the inside of the air-conditioner.**
Water leakage and permanent damage may result.
Electrical hazard exists.

BEFORE INSTALLATION

- Before installation check that the power source matches the air-conditioner.

Standard accessories (Installation kit)		Q'ty
Accessories for indoor unit		
①	Installation board (Attached to the rear of the indoor unit)	1
②	Wireless remote control	1
③	Remote control holder	1
④	Tapping screws (for installation board ø4 X 25mm)	10
⑤	Wood screws (for remote control holder ø3.5 X 16mm)	2
⑥	Battery [R03 (AAA, Micro) 1.5V]	2
⑦	Air-cleaning filters	2
⑧	Filter holders	2
⑨	Insulation (#486 50 x 100 t3)	1

Locally procured parts		Q'ty
a	Sealing plate	
b	Sleeve	1
c	Inclination plate	1
d	Putty	1
e	Drain hose (extension hose)	1
f	Piping cover (for insulation of connection piping)	1

Necessary tools for the installation work	
1	Plus headed driver
2	Knife
3	Saw
4	Tape measure
5	Hammer
6	Spanner wrench
7	Torque wrench (14.0 ~ 82.0N·m (1.4 ~ 8.2kgf·m))
8	Hole core drill (65mm in diameter)
9	Wrench key (Hexagon) [4m/m]
10	Flaring tool set (Designed specifically for R410A)
11	Gas leak detector (Designed specifically for R410A)
12	Gauge for projection adjustment (Used when flare is made by using conventional flare tool)
13	Pipe bender

SELECTION OF INSTALLATION LOCATION

(Install at location that meets the following conditions, after getting approval from the customer)

Indoor unit

- Where there is no obstructions to the air flow and where the cooled and heated air can be evenly distributed.
- A solid place where the unit or the wall will not vibrate.
- A place where there will be enough space for servicing. (Where space mentioned below can be secured)
- Where wiring and the piping work will be easy to conduct.
- The place where receiving part is not exposed to the direct rays of the sun or the strong rays of the street lighting.
- A place where it can be easily drained.
- A place separated at least 1m away from the television or the radio. (To prevent interference to images and sounds.)
- Places where this unit is not affected by the high frequency equipment or electric equipment.
- Avoid installing this unit in place where there is much oil mist.
- Places where there is no electric equipment or household under the installing unit.
- Install the indoor unit on the wall where the height from the floor to the bottom of the unit is more than 1.8m.

Wireless remote control

- A place where the air-conditioner can be received the signal surely during operating the wireless remote control.
- Places where there is not affected by the TV and radio etc.
- Do not place where exposed to direct sunlight or near heat devices such as a stove.

INSTALLATION OF INDOOR UNIT

Installation of Installation board

Look for the inside wall structures (Intermediate support or pillar and firmly install the unit after level surface has been checked.)

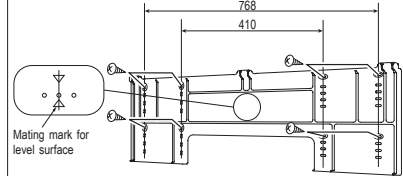

- Adjustment of the installation board in the horizontal direction is to be conducted with eight screws in a temporary tightened state.
- Adjust so the board will be level by turning the board with the standard hole as the center.

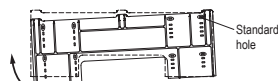
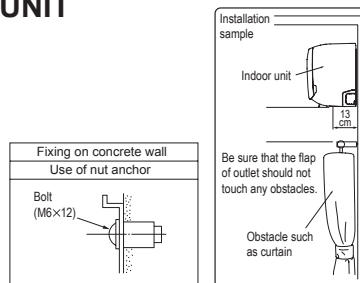

Drilling of hole and fixture of sleeve (Locally procured parts)

When drilling the wall that contains a metal lath, wire lath or metal plate, be sure to use pipe hole sleeve sold separately.

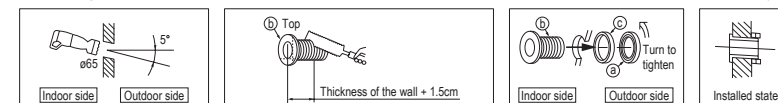

- Drill a hole with whole core drill.
- In case of rear piping draw out, cut off the lower and the right side portions of the sleeve collar.

Installing the support of piping

In case of piping in the right rear direction

Shaping of pipings

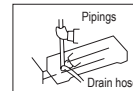

- Hold the bottom of the piping and fix direction before stretching it and shaping it.
- Tape only the portion that goes through the wall.
- Always tape the wiring with the piping.

Sufficient care must be taken not to damage the panel when connecting pipes.

Matters of special notice when piping from left or central/rear of the unit.

[Top view]

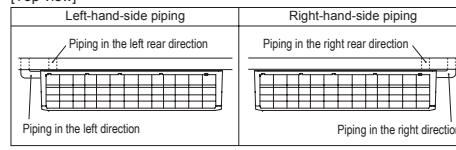

Piping is possible in the rear, left, left rear, left downward, right or downward direction.

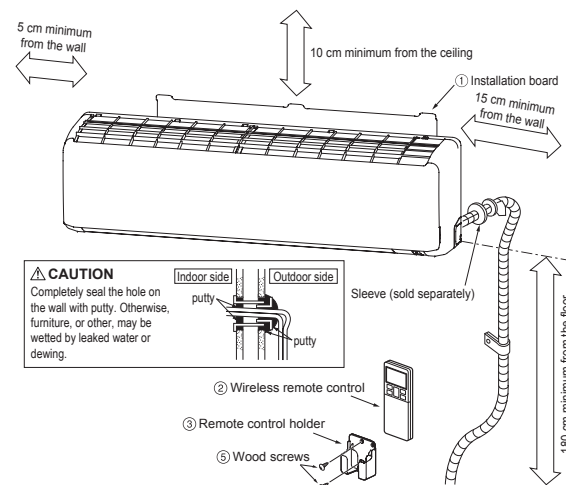
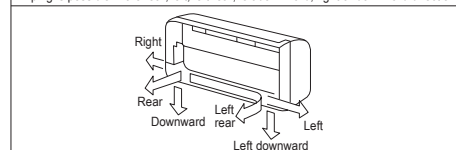

Relation between setting plate and indoor unit

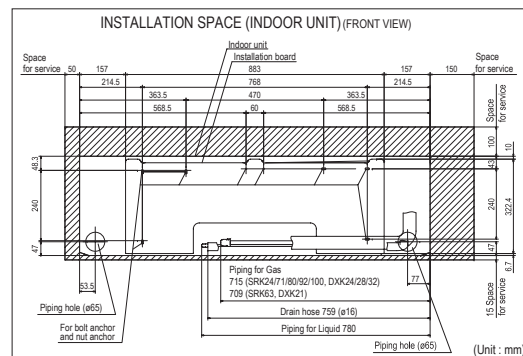

[Drain hose changing procedures]

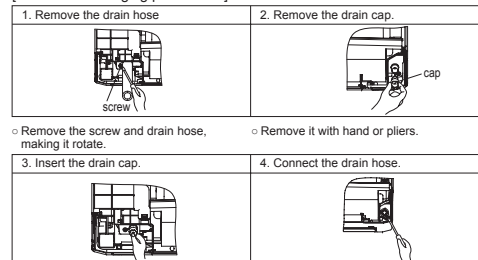

- Remove the screw and drain hose, making it rotate.
- Remove it with hand or pliers.
- Insert the drain cap.
- Insert the drain cap which was removed at procedure "2" securely using a hexagonal wrench etc. Note: Be careful that if it is not inserted securely, water leakage may occur.
- Remove the drain cap.
- Connect the drain hose. Note: Be careful that if it is not inserted securely, water leakage may occur.

Fixing of indoor unit

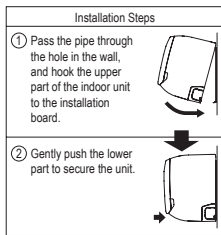
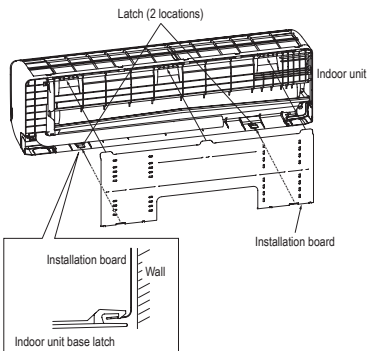

• How to remove the indoor unit from the installation board

- 1 Push up at the marked portion of the indoor unit base lower latch, and slightly pull it toward you. (both right and left hand sides) (The indoor unit base lower latch can be removed from the installation board)
- 2 Push up the indoor unit upward so that it can be removed from installation board.

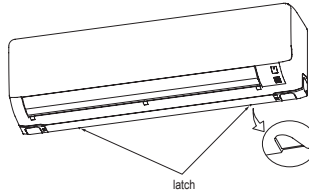

Since this air-conditioner has been designed to collect dew drops on the rear surface to the drain pan, do not attach the power cord above the gutter.

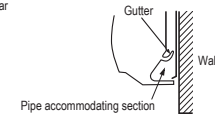

Drainage

- o Arrange the drain hose in a downward angle.
 - o Avoid the following drain piping.
- CAUTION** Go through all installation steps and check if the drainage is all right. Otherwise water leak may occur.

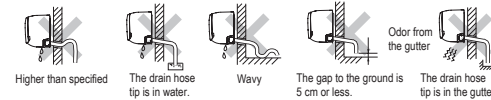

- o Pour water to the drain pan located under the heat exchanger, and ensure that the water is discharged outdoor.
- o When extended drain hose is present inside the room, insulate it securely with heat insulator available in the market.

CONNECTION OF REFRIGERANT PIPINGS

Preparation Keep the openings of the pipes covered with tapes etc. to prevent dust, sand, etc. from entering them.

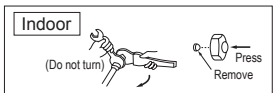

- o Remove the flared nuts. (on both liquid and gas sides)

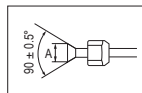

- o Install the removed flared nuts to the pipes to be connected, then flared the pipes.

Dimension A
Liquid side $\phi 6.35 : 9.1$ (mm)
 $\phi 9.52 : 13.2$ (mm)
Gas side $\phi 9.52 : 13.2$ (mm)
 $\phi 12.7 : 16.6$ (mm)
 $\phi 15.88 : 19.7$ (mm)

CAUTION

Do not apply refrigerating machine oil to the flared surface.

• Flaring work

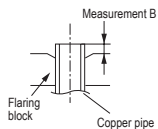

Copper pipe diameter	Measurement B (mm)		
	Clutch type flare tool for R410A	Conventional (R22) flare tool	
		Clutch type	Wing nut type
$\phi 6.35$	0.0 - 0.5	1.0 - 1.5	1.5 - 2.0
$\phi 9.52$	0.0 - 0.5	1.0 - 1.5	1.5 - 2.0
$\phi 12.7$	0.0 - 0.5	1.0 - 1.5	2.0 - 2.5
$\phi 15.88$	0.0 - 0.5	1.0 - 1.5	2.0 - 2.5

Use a flare tool designed for R410A or a conventional flare tool.
Note that measurement B (protrusion from the flaring block) will vary depending on the type of a flare tool in use.
If a conventional flare tool is used, use a copper pipe gauge or a similar instrument to check protrusion so that you can keep measurement B to a correct value.

Connection

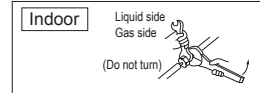

- o Connect the pipes on both liquid and gas sides.
 - o Tighten the nuts to the following torque.
- Liquid side ($\phi 6.35$) : 14.0 - 18.0 N·m (1.4 - 1.8 kgf·m)
($\phi 9.52$) : 34.0 - 42.0 N·m (3.4 - 4.2 kgf·m)
Gas side ($\phi 9.52$) : 34.0 - 42.0 N·m (3.4 - 4.2 kgf·m)
($\phi 12.7$) : 49.0 - 61.0 N·m (4.9 - 6.1 kgf·m)
($\phi 15.88$) : 68.0 - 82.0 N·m (6.8 - 8.2 kgf·m)

CAUTION

Do not apply excess torque to the flared nuts. Otherwise, the flared nuts may crack.

If FDC71VNP is connected, use reducer at gas side of indoor unit to change the pipe size from $\phi 15.88$ to $\phi 12.7$. (Reducer is attached in the outdoor unit accessory)

Insulation of the connection portion

Cover the coupling with insulator and then cover it with tapes.

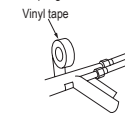

Use an attached insulation pad for heat insulation.

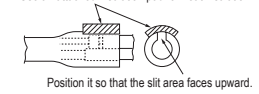

- Cover the indoor unit's flare-connected joints, after they are checked for a gas leak, with an indoor unit heat insulating material and then wrap them with a tape with an attached insulation pad placed over the heat insulating material's slit area.

Finishing work and fixing

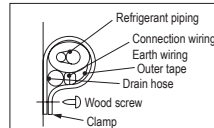

Cover the exterior portion with outer tape and shape the piping to match with the contours of the route that piping will take. Also fix the wiring and pipings to the wall with clamps.

Open/close and detachment/attachment of the air inlet panel

- o To open, pull the panel at both ends of lower part and release latches, then pull up the panel until you feel resistance. (The panel stops at approx. 60° open position)
- o To close, hold the panel at both ends of lower part to lower downward and push it slightly until the latch works.
- o To remove, pull up the panel to the position shown in right illustration and pull it toward you.
- o To install, insert the panel arm into the slot on the front panel from the position shown in right illustration, hold the panel at both ends of lower part, lower it downward slowly, then push it slightly until the latch works.

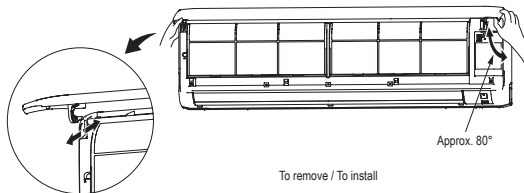

How to remove and install the front panel

- o Removing
 - 1 Remove the air inlet panel.
 - 2 Remove the 8 screws fixing to the front panel.
 - 3 Remove the 5 latches in the upper section of the front panel and then remove the front panel from the unit.
- o Installing
 - 1 Remove the air filter.
 - 2 Cover the unit with the front panel.
 - 3 Tighten the 8 screws to fix the front panel.
 - 4 Install the air filter.
 - 5 Install the air inlet panel.

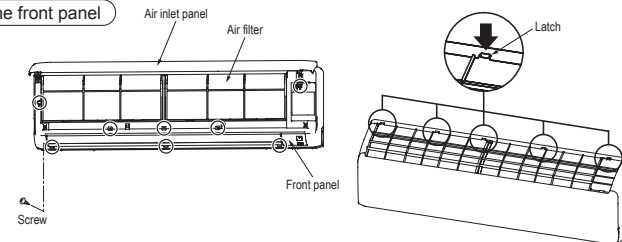

ELECTRICAL WIRING WORK

Preparation of indoor unit

Mounting of connecting wires

- ① Open the air inlet panel.
- ② Remove the lid.
- ③ Remove the wiring clamp.
- ④ Connect the connecting wire securely to the terminal block.
 - 1) Connect the connection wire securely to the terminal block. If the wire is not affixed completely, contact will be poor, and it is dangerous as the terminal block may heat up and catch fire.
 - 2) Take care not to confuse the terminal numbers for indoor and outdoor connections.
- ⑤ Fix the connecting wire by wiring clamp.
- ⑥ Attach the lid.
- ⑦ Close the air inlet panel.

○ In case of faulty wiring connection, indoor unit does not operate. Then, run lamp turns on and timer lamp blinks.

Use cables for interconnection wiring to avoid loosening of the wires.
CENELEC code for cables Required field cables.

H05RN4G1.5 (example) or 245IEC57
 H Harmonized cable type
 05 300/500 volts
 R Natural-and/or synth, rubber wire insulation
 N Polychloroprene rubber conductors insulation
 R Stranded core
 4or5 Number of conductors
 G One conductor of the cable is the earth conductor (yellow/green)
 1.5 Section of copper wire (mm²)

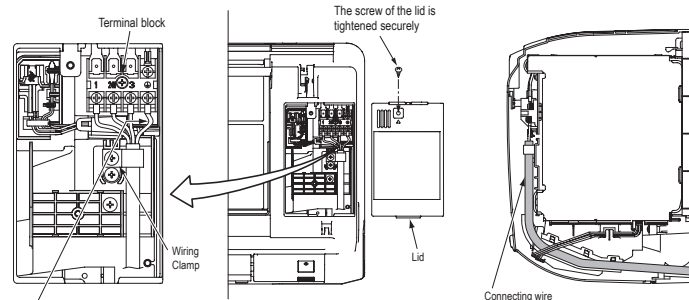

• Earth wire shall be Yellow/Green (Y/G) in color and longer than other AC wires for safety reason.

• Pass the connecting wire through the path from the bottom of the control box to the front part as shown in the illustration.

Installing the air-cleaning filters

- ① Open the air inlet panel and remove the air filters.
- ② Install the air-cleaning filter in the filter holders, and then install the filter holders in the air-conditioner.
 - Each air-cleaning filter can be installed in the left or right filter holder.
- ③ Install the air filters and close the inlet panel.

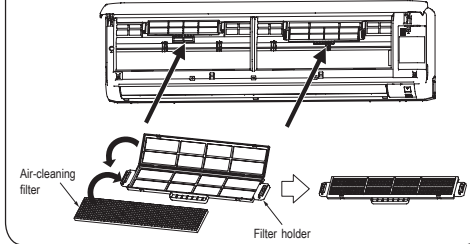

INSTALLATION OF WIRELESS REMOTE CONTROL

Mounting method of battery

- Uncover the wireless remote control, and mount the batteries [R03 (AAA, Micro), ×2 pieces] in the body regularly. (Fit the poles with the indication marks, ⊕ & ⊖ without fail)
- Do not use new and old batteries together.

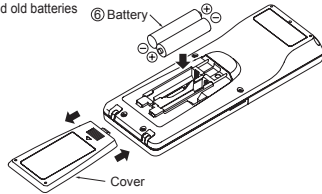

Fixing to pillar or wall

- Conventionally, operate the wireless remote control by holding in your hand.
- Avoid installing it on a clay wall etc.

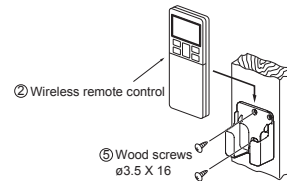

INSTALLING TWO AIR-CONDITIONERS IN THE SAME ROOM

When two air-conditioners are installed in the same room, use this setting when the two air-conditioners are not operated with one wireless remote control. Set the wireless remote control and indoor unit.

Setting the wireless remote control

- ① Pull out the cover and take out batteries.
- ② Disconnect the switching line next to the battery with wire cutters.
- ③ Insert batteries. Close the cover.

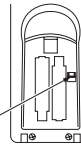

Setting an indoor unit

- ① Turn off the power source, and turn it on after 1 minute.
- ② Point the wireless remote control that was set according to the procedure described on the left side at the indoor unit and send a signal by pressing the ACL switch on the wireless remote control. Since the signal is sent in about 6 seconds after the ACL switch is pressed, point the wireless remote control at the indoor unit for some time.
- ③ Check that the reception buzzer sound "pip" is emitted from the indoor unit. At completion of the setting, the indoor unit emits a buzzer sound "pip". (If no reception tone is emitted, start the setting from the beginning again.)

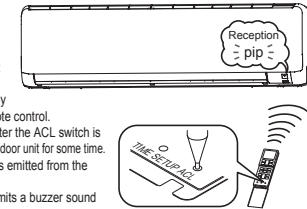

HOW TO RELOCATE OR DISPOSE OF THE UNIT

- In order to protect the environment, be sure to pump down (recovery of refrigerant).
- Pump down is the method of recovering refrigerant from the indoor unit to the outdoor unit when the pipes are removed from the unit.

<How to pump down>

- ① Connect charge hose to check joint of outdoor unit.
- ② Liquid side : Close the liquid valve with hexagon wrench key.
Gas side : Fully open the gas valve.
Carry out cooling operation. (If indoor temperature is low, operate forced cooling operation.)
- ③ After low pressure gauge become 0.01MPa, stop cooling operation and close the gas valve.

- Forced cooling operation
Turn off power source. Turn on power source again after a while. Then, press the ON/OFF button continuously for at least 5 seconds. (The operation will start.)

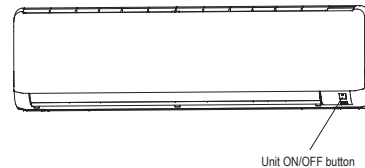

TERMINAL CONNECTION FOR AN INTERFACE

- ① Remove the air inlet panel, lid and front panel.
- ② Remove the control cover. (Remove the screw.)
- ③ There is a terminal (respectively marked with CNS) for the indoor control board. In connecting an interface, connect to the respective terminal securely with the connection harness supplied with an option "Interface connection kit SC-BIKN-E" and fasten the connection harness onto the indoor control box with the clamp supplied with the kit. For more details, refer to the user's manual of your "Interface connection kit SC-BIKN-E".

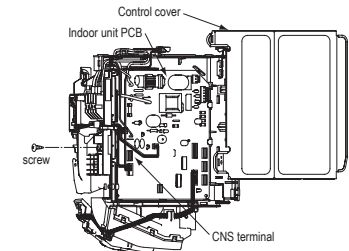

INSTALLATION TEST CHECK POINTS

Check the following points again after completion of the installation, and before turning on the power. Conduct a test run again and ensure that the unit operates properly. At the same time, explain to the customer how to use the unit and how to take care of the unit following the user's manual.

After installation

- | | |
|---|--|
| <input type="checkbox"/> The power source voltage is correct as the rating. | <input type="checkbox"/> The screw of the lid is tightened securely. |
| <input type="checkbox"/> No gas leaks from the joints of the service valve. | <input type="checkbox"/> Service valve is fully open. |
| <input type="checkbox"/> Power cables and crossover wires are securely fixed to the terminal board. | <input type="checkbox"/> The pipe joints for indoor and outdoor pipes have been insulated. |

Test run

- | | |
|--|--|
| <input type="checkbox"/> Air-conditioning operation is normal. | <input type="checkbox"/> The wireless remote control is normal. |
| <input type="checkbox"/> No abnormal noise. | <input type="checkbox"/> Operation of the unit has been explained to the customer. (Three-minutes restart preventive timer) |
| <input type="checkbox"/> Water drains smoothly. | <input type="checkbox"/> When the air-conditioner is restarted or when changing the operation, the unit will not start operating for approximately 3 minutes. This is to protect the unit and it is not a malfunction. |
| <input type="checkbox"/> Protective functions are not working. | |

(7) Effective range of cool/hot wind (Reference)

(a) FDT series

Guideline for ceiling height

Fan speed setting	Model
	FDT100VF2
Hi	3.2m
P-Hi	4.3m

Notes (1) If the ceiling height is over 3m, please consider to add circulators.

This table shows reference values in case of four outlet.

If you shut some outlets, they are different.

Fan speed setting can be changed by using a wired remote control.

(b) FDE series

Model	Effective range
FDE100VG	9.0m

- [Conditions]
1. Height of unit: 2.4 – 3.0 (m) above floor level
 2. Fan speed : Hi
 3. Location: Free space without obstacles
 4. The effective range means the horizontal distance for wind to reach the floor.
 5. Wind speed at the effective range: 0.5 m/s

(c) FDF series

Model	Effective range
FDF100VD2	8m

- [Conditions]
1. Fan speed : Hi
 2. Location: Free space without obstacles
 3. The effective range means the horizontal distance for the wind to reach the floor.
 4. Wind speed at the effective range: 0.5 m/s

10.2 Electric wiring work installation

(1) FDT, FDE, FDU, FDUM series

PSB012D999

Electrical wiring work must be performed by an electrician qualified by a local power provider according to the electrical installation technical standards and interior wiring regulations applicable to the installation site.

Security instructions

- Read the "SAFETY PRECAUTIONS" carefully first of all and then strictly follow it during the installation work in order to protect yourself.
- The precautionary items mentioned below are distinguished into two levels, **⚠WARNING** and **⚠CAUTION**.
 - ⚠WARNING : Wrong installation would cause serious consequences such as injuries or death.
 - ⚠CAUTION : Wrong installation might cause serious consequences depending on circumstances.
- Both mentions the important items to protect your health and safety so strictly follow them by any means.
- The meanings of "Marks" used here are as shown on the right:
 - ⊘ Never do it under any circumstances.
 - Ⓜ Always do it according to the instruction.
- Accord with following items. Otherwise, there will be the risks of electric shock and fire caused by overheating or short circuit.

⚠WARNING

- Be sure to have the electrical wiring work done by qualified electrical installer, and use exclusive circuit. Ⓜ
Power source with insufficient capacity and improper work can cause electric shock and fire.
- Use specified wire for electrical wiring, fasten the wiring to the terminal securely, and hold the cable securely in order not to apply unexpected stress on the terminal. Ⓜ
Loose connections or hold could result in abnormal heat generation or fire.
- Arrange the electrical wires in the control box properly to prevent them from rising. Fit the lid of the services panel properly. Ⓜ
Improper fitting may cause abnormal heat and fire.
- Use the genuine option parts. And installation should be performed by a specialist. Ⓜ
If you install the unit by yourself, it could cause water leakage, electric shock and fire.
- Do not repair by yourself. And consult with the dealer about repair. ⊘
Improper repair may cause water leakage, electric shock or fire.
- Consult the dealer or a specialist about removal of the air-conditioner. Ⓜ
Improper installation may cause water leakage, electric shock or fire.
- Turn off the power source during servicing or inspection work. Ⓜ
If the power is supplied during servicing or inspection work, it could cause electric shock and injury by the operating fan.
- Shut off the power before electrical wiring work. Ⓜ
It could cause electric shock, unit failure and improper running.

⚠CAUTION

- Perform earth wiring surely. Ⓜ
Do not connect the earth wiring to the gas pipe, water pipe, lightning rod and telephone earth wiring. Improper earth could cause unit failure and electric shock due to a short circuit.
- Earth leakage breaker must be installed. Ⓜ
If the earth leakage breaker is not installed, it can cause electric shocks.
- Make sure to install earth leakage breaker on power source line. (countermeasure thing to high harmonics.) Ⓜ
Absence of breaker could cause electric shock.
- Use the circuit breaker of correct capacity. Circuit breaker should be the one that disconnect all poles under over current. Ⓜ
Using the incorrect one could cause the system failure and fire.
- Do not use any materials other than a fuse of correct capacity where a fuse should be used. ⊘
Connecting the circuit by wire or copper wire could cause unit failure and fire.
- Use power source line of correct capacity. Ⓜ
Using incorrect capacity one could cause electric leak, abnormal heat generation and fire.
- Do not mingle solid cord and stranded cord on power source and signal side terminal block. ⊘
In addition, do not mingle difference capacity solid or stranded cord. Inappropriate cord setting could cause losing screw on terminal block, bad electrical contact, smoke and fire.
- Do not turn off the power source immediately after stopping the operation. ⊘
Be sure to wait for more than 5 minutes. Otherwise it could cause water leakage or breakdown.
- Do not control the operation with the circuit breaker. ⊘
It could cause fire or water leakage. In addition, the fan may start operation unexpectedly and it may cause injury.

Control mode switching

- The control content of indoor units can be switched in following way. (is the default setting)

Switch No.	Control Content	
SW2	Indoor unit address (0-Fh)	
SW5-1	Master/Slave Switching (plural /Slave unit Setting)	
SW5-2		
SW6-1-4	Model capacity setting	
SW7-1	ON	Operation check, Drain motor test run
	OFF	Normal operation

① Electrical Wiring Connection

- Electrical wiring work must be performed by an electrician an qualified by a local power provider. These wiring specifications are determined on the assumption that the following instructions are observed:
 - Do not use cords other than copper ones.
 - Do not use any supply line lighter than one specified in parentheses for each type below.
 - braided cord (code designation 60245 IEC 51), if allowed in the relevant part 2;
 - ordinary tough rubber sheathed cord (code designation 60245 IEC 53);
 - flat twin tinsel cord (code designation 60227 IEC 41);
 - ordinary polyvinyl chloride sheathed cord (code designation 60227 IEC 53);
 - Connect the power source to the outdoor unit.
 - Pay extra attention so as not to confuse signal line and power source line connection, because an error in their connection can be burn all the boards at once.
- Screw the line to terminal block without any looseness, certainly.
- Do not turn on the switch of power source, before all of line work is done.
- Provide a dedicated branching circuit and never share a branching circuit with other equipment. If shared, disconnection at the circuit breaker may occur, which can cause secondary damage.
- Use three-core cable as wiring between indoor and outdoor unit. As for detail, refer to "INSTALLATION MANUAL" of outdoor Unit.
- Set earth of D-type.
- Do not add cord in the middle of line (of indoor power source, remote control and signal) route on outside of unit. If connecting point is flooded, it could cause problem as for electric or communication.
 - (In the case that it is necessary to set connecting point on the signal line way, perform through waterproof measurement.)
- Run the lines (power source, remote control and "between indoor and outdoor unit") upper ceiling through iron pipe or other tube protection to avoid the damage by mouse and so on.
- Keep "remote control line" and "power source line" away from each other on constructing of unit outside.
- Do not connect the power source line [220V/240V/380V/415V] to signal side terminal block. Otherwise, it could cause failure.
- Connection of the line ("Between indoor and outdoor unit", Earth and Remote control)
 - Remove lid of control box before connect the above lines, and connect the lines to terminal block according to number pointed on label of terminal block.
 - In addition, pay enough attention to confirm the number to lines, because there is electrical polarity except earth line.
 - Furthermore, connect earth line to earth position of terminal block of power source.
 - Install earth leakage breaker on power source line. In addition, select the type of breaker for inverter circuit as earth leakage breaker.
 - If the function of selected earth leakage breaker is only for earth-fault protection, hand switch (switch itself and type "B" fuse) or circuit breaker is required in series with the earth leakage breaker.
 - Install isolator or disconnect switch on the power source wiring in accordance with the local codes and regulations. The isolator should be set in the box with key to prevent touching by another person when servicing.

Cable connection for single unit installation

- ① As for connecting method of power source, select from following connecting patterns. In principle, do not directly connect power source line to inside unit.
- ※ As for exceptional connecting method of power source, discuss with the power provider of the country with referring to technical documents, and follow its instruction.
- ② For cable size and circuit breaker selection, refer to the outdoor unit installation manual.

Single-phase model

Three-phase model

Cable connection for a V multi configuration installation

- ① Connect the same pairs number of terminal block "①, ②, and ③" and "ⓧ and Ⓨ" between master and slave indoor units.
- ② Do the same address setting of all inside units belong to same refrigerant system by rotary switch SW2 on indoor unit's PCB (Printed circuit board).
- ③ Set slave indoor unit as "slave 1" through "slave 3" by address switch SW5-1, 5-2 on PCB.
- ④ When the [AIR CON NO.] button on the remote control unit is pressed after turning on the power, an indoor unit's address number will be displayed. Do not fail to confirm that the connected indoor unit's numbers are displayed on the remote control unit by pressing the **▲** or **▼** button.

Method of setting Master/Slave of indoor unit

(Factory setting: "Master")

Indoor Unit	Master	Slave 1	Slave 2	Slave 3	
PCB SW	SW5-1	OFF	OFF	ON	ON
	SW5-2	OFF	ON	OFF	ON

- 76 -

② Remote Control, Wiring and functions

● DO NOT install it on the following places

- ① Places exposed to direct sunlight
- ② Places near heat devices
- ③ High humidity places
- ④ Hot surface or cold surface enough to generate condensation
- ⑤ Places exposed to oil mist or steam directly.
- ⑥ Uneven surface

Installation and wiring of remote control

- ① Install remote control referring to the attached installation manual.
- ② Wiring of remote control should use 0.3mm² × 2 core wires or cables.
The insulation thickness is 1mm or more. (on-site configuration)
- ③ Maximum prolongation of remote control wiring is 600 m.

If the prolongation is over 100m, change to the size below.

But, wiring in the remote control case should be under 0.5mm². Change the wire size outside of the case according to wire connecting. Waterproof treatment is necessary at the wire connecting section. Be careful about contact failure.

- 100 - 200m 0.5mm² × 2 cores
- Under 300m 0.75mm² × 2 cores
- Under 400m 1.25mm² × 2 cores
- Under 600m 2.0mm² × 2 cores

- ④ Avoid using multi-core cables to prevent malfunction.
- ⑤ Keep remote control line away from earth (frame or any metal of building).
- ⑥ Make sure to connect remote control line to the remote control and terminal block of indoor unit. (No polarity)

Control plural indoor units by a single remote control.

- ① A remote control can control plural indoor units (Up to 16).
In above setting, all plural indoor units will operate under same mode and temperature setting.
- ② Connect all indoor units with 2 core remote control line.
- ③ Set unique remote control communication address from "0" to "F" to each inside unit by the rotary switch SW2 on the indoor unit's PCB.

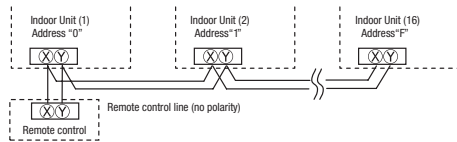

Master/ slave setting when more than one remote control unit are used

A maximum of two remote control units can be connected to one indoor unit (or one group of indoor units.)

The air-conditioner operation follows the last operation of the remote control regardless of the master/slave setting of it.

Acceptable combination is "two (2) wired remote controls", "one (1) wired remote control and one (1) wireless kit" or "two (2) wireless kits".

Set one to "Master" and the other to "Slave".

Note: The setting "Remote control unit sensor enabled" is only selectable with the master remote control unit in the position where you want to check room temperature.

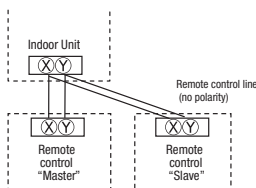

③ Operation and confirmation from remote control

Operation from RC-EX1A
1 Check the number of units connected in the remote control system.
It checks sub units of twin, triple or W-twin connection.

"Menu" ⇒ "Next" ⇒ "Service & Maintenance" ⇒
"Input password" ⇒ "IU address"

Operation from RC-E5
Press [AIR CON NO] button to display the IU address. Press the [▼] or [▲] button and check addresses of connected indoor units one by one.

2 Check if each unit is connected properly in the remote control system.
It cannot check main and sub units of twin, triple or W-twin connection.

When the operation is stopped, "Menu" ⇒
"Next" ⇒ "Service & Maintenance" ⇒
"Input password" ⇒ "IU address" ⇒ "check run mode"

If AIR CON NO. button is pressed when the operation is stopped, the indoor unit address is displayed. If you select one of addresses for connected indoor units by pressing the [▼] or [▲] button and press the [MODE] button, the unit starts to blow air.

3 Setting main/slave remote controls
"Menu" ⇒ "Next" ⇒ "R/C function settings" ⇒
"Input password" ⇒ "Main/Sub of R/C"
Set SW1 to "Slave" for the slave remote control unit.

4 Checking operation data
"Menu" ⇒ "Next" ⇒ "Service & Maintenance" ⇒
"Input password" ⇒ "Operation data"
Press the [CHECK] button. ⇒ "PRR (DATA)" is displayed. ⇒ Press the [SET] button. ⇒ "DATA (LOADING)" is displayed. ⇒ Press the [←] or [→] button. ⇒ Select one of addresses for connected indoor units by pressing the [▲] or [▼] button. ⇒ Press the [SET] button. ⇒ "DATA (LOADING)" is displayed. ⇒ Select data by pressing the [▲] or [▼] button.

5 Checking inspection display
"Menu" ⇒ "Next" ⇒ "Service & Maintenance" ⇒
"Input password" ⇒ "Inspection display"
Press the [CHECK] button. ⇒ [▼] button. ⇒ ERR DATA. ⇒ Press the [SET] button. ⇒ "DATA (LOADING)" is displayed. ⇒ Data.

6 Cooling test run from remote control
"Menu" ⇒ "Next" ⇒ "Installation settings" ⇒
"Input password" ⇒ "Test run" ⇒
"Cooling test run" ⇒ "Start"
① Start the system by pressing the [ON/OFF] button.
② Select "Cool" with the [MODE] button.
③ Press the [TEST] button for 3 seconds or longer.
The screen display will switch to TEST RUN. *
④ When the [SET] button is pressed while "TEST RUN" is indicated, a cooling test run will start.
The screen display will switch to TEST RUN.

7 Trial operation of drain pump from remote control
"Menu" ⇒ "Next" ⇒ "Installation settings" ⇒
"Input password" ⇒ "Test run" ⇒
"Drain pump test run" ⇒ "Run"
① Press the [TEST] button for three seconds or longer.
The display will change to TEST RUN. *
② Press the [▼] button once and cause "DRAIN PUMP" to be displayed.
③ When the [SET] button is pressed, a drain pump operation will start. Display: "TEST STOP".

④ Function of CNT connector of indoor printed circuit board

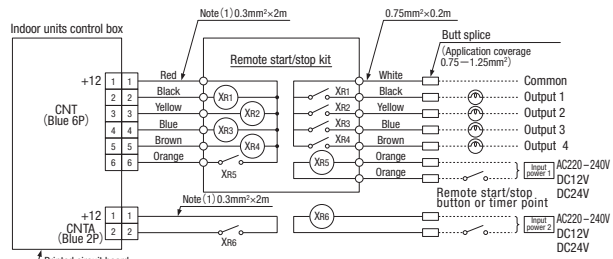

Note (1): Do not use the length over 2 meter

● CNT connector (local) vendor model
Connector : Made by molex 5264-06
Terminals : Made by molex 5263 T

● Function

Output 1	Air-conditioner operation output (When the air-conditioner ON: XR1 = ON)
Output 2	Heating output
Output 3	Thermostat ON output (When the thermostat ON: XR3 = ON)
Output 4	Air-conditioner check ON (When checking air-conditioner: XR4 = ON)
Input	At shipping XR5 OFF ⇒ ON: Air-conditioner operates. XR5 ON ⇒ OFF: Air-conditioner stops.
	*Functions and controls may vary depending on the switching at site.
Input 2 (FDT etc.)	At shipping XR6 OFF ⇒ ON: Air-conditioner operates. XR6 ON ⇒ OFF: Air-conditioner stops.
	*Functions and controls may vary depending on the switching at site.

* Refer to I/U settings.

● CNTA connector is installed on FDT, etc. Refer to the spec. drawings.
CNTA connector (local) vendor model
Connector : Made by JST XAP02V-1-E
Terminals : Made by JST SXA-01T-P0.6

⑥ Operation and setting from remote control

A: Refer to the instruction manual for RC-EX series.
 B: Refer to the installation manual for RC-EX series.
 C: Loading a utility software via Internet
 ○: Nearly same function setting and operations are possible.
 △: Similar function setting and operations are possible.

Setting & display item	Description	RC-EX series	RC-E5
1. Remote Control network			
1	Control plural indoor units by a single remote control	○	○
2	Master/slave setting of remote controls	B	○
2. TOP screen, Switch manipulation			
1	Menu	A	A
2	Operation mode	A	○
3	Set temp.	A	○
4	Air flow direction	A	○
5	Fan speed	A	○
6	Timer setting	A	○
7	ON/OFF	A	○
8	High power SW	A	
9	Energy-saving SW	A	
3. Energy-saving setting			
1	Auto OFF timer [Administrator password]	A	△
2	Peak-cut timer [Administrator password]	A	
3	Automatic temp. set back [Administrator password]	A	△
4. Individual flap control setting			
	Individual flap control setting	A	○
5. Ventilation			
1	External ventilation (in combination with ventilator)	A	○
6. Filter sign reset			
1	Filter sign reset	B	
2	Setting next cleaning date	A	
7. Initial settings			
1	Clock setting	A	△
2	Date and time display	A	
3	Summer time	A	
4	Contrast	A	
5	Backlight	A	
6	Controller sound	A	
8. Timer settings			
1	Set On timer by hour	A	△
2	Set Off timer by hour	A	△
3	Set On timer by clock	A	△
4	Set Off timer by clock	A	△
5	Confirmation of timer settings	A	
9. Weekly timer			
1	Weekly timer [Administrator password]	A	△
10. Home leave mode			
1	Home leave mode [Administrator password]	A	

⑥ Operation and setting from remote control (continued)

Setting & display item	Description	RC-EX series	RC-E5
11. Administrator settings	[Administrator password]	A	
1 Enable/Disable setting	•Enable/Disable setting of operation can be set. [On/Off] [Change set temp.] [Change operation mode] [Change air flow direction] [Individual flap control setting][Fan speed] [High power operation] [Energy-saving operation] [Timer settings] [Weekly timer setting] •Request for administrator password can be set. [Individual flap control setting][Weekly timer][Energy-saving setting][Home leave mode][Administrator settings]	A	△
2 Silent mode timer	The period of time to operate the outdoor unit by prioritizing the quietness can be set. •The [Start time] and the [End time] for operating outdoor unit in silent mode can be set. •The period of the operation time can be set once a day by 5 minutes interval.	A	△
3 Setting temp. range	The upper/lower limit of indoor temp. setting range can be set. •The limitation of indoor temp. setting range can be set for each operation mode in cooling and heating.	A	△
4 Temp. increment setting	The temp increment setting can be changed by 0.5°C or 1.0°C.	A	
5 RC display setting	Register [Room name] [Name of I/U] Display [indoor temp.] or not. Display [inspection code] or not. Display [Heating stand-by] [Defrost operation] [Auto cooling/heating] or not	A	○ △ ○
6 Change administrator password	The administrator password can be changed. (Default setting is "0000") The administrator password can be reset.	A B	
12. Installer settings	[Service password]	B	
1 Installation date	The [Installation date] can be registered. •When registering the [Installation date], the [Next service date] is displayed automatically. (For changing the [Next service date], please refer the item of [Service & Maintenance].)	B	
2 Service contact	The [Service contact] can be registered and can be displayed on the RC. •The [Contact company] can be registered within 10 characters. •The [Contact phone] can be registered within 13 digits.	B	
3 Test run	On/Off operation of the test run can be done.		
Cooling test run	The [Cooling test run] can be done at 5°C of set temp. for 30 minutes.	B	○
Drain pump test run	Only the drain pump can be operated.		○
Compressor Hz fixed operation	The [Test run] operation can be done with fixed compressor Hz set by installer.		○
4 Static pressure adjustment	In case of combination with only the ducted indoor unit which has a function of static pressure adjustment, the static pressure is adjustable.	B	
5 Change auto-address	The set address of each indoor unit decided by auto-address setting method can be changed to any other address. (For multiple KX units only)	B	△
6 Address setting of Main IU	Main indoor unit address can be set. •Only the Main indoor unit can change operation mode and the Sub indoor units dominated by the Main indoor unit shall follow. •The Main indoor unit can domain 10 indoor units at a maximum.	B	△
13. RC function settings	[Service password]	B	
1 Main/Sub RC setting	The setting of [Main/Sub RC] can be changed.	B	○
2 RC sensor	The offset value of [RC sensor] sensing temp. can be set respectively in heating and cooling.	B	○
3 9 RC sensor adjustment	The offset value of [RC sensor] sensing temp. can be set respectively in heating and cooling. •The setting range of offset value is ±3°C both in cooling and heating.	B	△
4 12 Operation mode	The [Valid/Invalid] setting of [Auto][Cooling][Heating] and [Dry] can be done respectively.	B	○
5 13 Fan speed	The setting of [Fan speed] can be done from following patterns. •1-speed, 2-speeds (Hi-Me), 2-speeds (Hi-Lo), 3-speeds, 4-speeds.	B	○
14 External input	The applicable range ([Individual] or [All units]) of CnT input to the multiple indoor units connected in one control system. •[Individual] : Only the unit received CnT input signal. •[All units] : All the units connected to one control system received CnT input signal.	B	○
7 15 Ventilation setting	The setting of [Invalid] operation of ventilator, [Interlock] with AC or [Independent] of ventilator can be selected. •When setting [Interlock], the operation of external ventilator is interlocked with the operation of AC •When setting [Independent], only the operation of external ventilator is available.	B	○
8 16 Flap control	The [Flap control] method can be switched to[Stop at fixed position] or [Stop at any position]: [Stop at fixed position] : Stop the flap at a certain position among the designated 4 positions. •[Stop at any position] : Stop the flap at any arbitrary position just after the stopping command from RC was sent.	B	○
9 17 Auto-restart	The operation control method after recovery of power blackout happened during operation can be set.	B	○
10 18 Auto temp. setting	[Valid] or [Invalid] of [Auto temp. setting] can be selected.	B	
11 19 Auto fan speed setting	[Valid] or [Invalid] of [Auto fan speed setting] can be selected.	B	
14. I/U settings	[Service password]	B	
1 High ceiling	The fan tap of indoor fan can be changed. •[Standard] [High ceiling 1] [High ceiling 2] can be selected.	B	○
2 Filter sign	The setting of filter sign display timer can be done from following patterns.	B	○
3 External input 1	The content of control by external input can be changed. •The selectable contents of control are [On/Off] [Permission/Prohibition] [Cooling/heating] [Emergency stop]	B	○
4 External input 1 signal	The type of external input signal ((Level input)/[Pulse input]) can be changed.	B	○
5 External input 2	•The selectable contents of control are [On/Off] [Permission/Prohibition] [Cooling/heating] [Emergency stop]	B	
6 External input 2 signal	The type of external input signal ((Level input)/[Pulse input]) can be changed.	B	
7 Heating thermo-off temp. adjust	The judgment temp. of heating thermo-off can be adjusted within the range from 0 to +3°C (1°C interval)	B	△
8 Return air sensor adjust	The sensing temp. of return air temp. sensor built in the indoor unit can be adjusted within the range of ±2°C.	B	△
9 Fan control in heating thermo OFF	The fan control method at heating thermo-off can be changed. •The selectable fan control methods are [Low] [Set fan speed] [Intermittent] [Stop].	B	○
10 Anti-frost temp.	The judgment temp. of anti-frost control for the indoor unit in cooling can be changed to [Temp. High] or [Temp. Low].	B	○
11 Anti-frost control	When the anti-frost control of indoor unit in cooling is activated, the fan speed can be changed.	B	○
12 Drain pump operation	In any operation mode in addition to cooling and dry mode, the setting of drain pump operation can be done.	B	○
13 Residual fan operation in cooling	The time period of residual fan operation after stopping or thermo-off in cooling mode can be set.	B	○
14 Residual fan operation in heating	The time period of residual fan operation after stopping or thermo-off in heating mode can be set.	B	○
15 Intermittent fan operation in heating	The fan operation rule following the residual fan operation after stopping or thermo-off in heating mode can be set.	B	○
16 Fan circulator operation	In case that the fan is operated as the circulator, the fan control rule can be set.	B	
17 Control pressure adjust. (For OA processing unit only)	When only the OA processing units are operated, control pressure value can be changed.	B	○
18 Auto operation mode	The [Auto rule selection] for switching the operation mode automatically can be selected from 3 patterns.	B	
19 Thermo. rule setting	When selecting [Outdoor air temp. control], the judgment temp can be offset by outdoor temp..	B	
20 Auto fan speed control	Under the [Auto fan speed control] mode, the switching range of fan speed can be selected from following 2 patterns [Auto 1] [Auto 2]. •[Auto 1] : Hi ⇔Me⇔Lo •[Auto 2] : P-hi⇔Hi⇔Me⇔Lo	B	
15. Service & Maintenance	[Service password]	B	
1 IU address No.	Max. 16 indoor units can be connected to one remote control, and all address No. of the connected indoor units can be displayed. •The indoor unit conforming to the address No. can be identified by selecting the address No. and tapping [Check] to operate the indoor fan.	B	○
2 Next service date	The [Next service date] can be registered. •The [Next service date] and [Service contact] is displayed on the [Periodical check] message screen.	AB	
3 Operation data	Total 39 items of [Operation data] for indoor unit and outdoor unit can be displayed.	B	○
4 Error history	[Date and time of error occurred] [IU address] [Error code] for Max. 16 latest cases of error history can be displayed.	B	△
Display anomaly data	The operation data just before the latest error stop can be displayed.	B	
Reset periodical check	The timer for the periodical check can be reset.	B	○
5 Saving I/U settings	The I/U settings memorized in the indoor PCB connected to the remote control can be saved in the memory of the remote control.	B	
6 Special settings	[Erase I/U address] [CPU reset] [Initializing] [Touch panel calibration]	B	△
16. Inspection		A	△
Confirmation of Inspection	The address No. of anomalous indoor/outdoor unit and error code are displayed.		
17. PC connection		C	
USB connection	Weekly timer setting and etc., can be set from PC.		

(2) FDF series









PGA012D405

Electrical wiring work must be performed by an electrician qualified by a local power provider according to the electrical installation technical standards and interior wiring regulations applicable to the installation site.









Security instructions

- Read the "SAFETY PRECAUTIONS" carefully first of all and then strictly follow it during the installation work in order to protect yourself.
- The precautionary items mentioned below are distinguished into two levels, **WARNING** and **CAUTION**.
 - WARNING**: Wrong installation would cause serious consequences such as injuries or death.
 - CAUTION**: Wrong installation might cause serious consequences depending on circumstances.
 Both mentions the important items to protect your health and safety so strictly follow them by any means.
- The meanings of "Marks" used here are as shown on the right:
 - ⊘ Never do it under any circumstances.
 - ⊙ Always do it according to the instruction.
- Accord with following items. Otherwise, there will be the risks of electric shock and fire caused by overheating or short circuit.

WARNING

- Be sure to have the electrical wiring work done by qualified electrical installer, and use exclusive circuit.  Power source with insufficient capacity and improper work can cause electric shock and fire.
- Use specified wire for electrical wiring, fasten the wiring to the terminal securely, and hold the cable securely in order not to apply unexpected stress on the terminal. Loose connections or hold could result in abnormal heat generation or fire. 
- Arrange the electrical wires in the control box properly to prevent them from rising. Fit the lid of the services panel properly. Improper fitting may cause abnormal heat and fire. 
- Use the genuine option parts. And installation should be performed by a specialist. Improper fitting may cause water leakage, electric shock and fire. 
- Do not repair by yourself. And consult with the dealer about repair. Improper repair may cause water leakage, electric shock or fire. 
- Consult the dealer or a specialist about removal of the air-conditioner. Improper installation may cause water leakage, electric shock or fire. 
- Turn off the power source during servicing or inspection work. If the power is supplied during servicing or inspection work, it could cause electric shock and injury by the operating fan. 
- Shut off the power before electrical wiring work. It could cause electric shock, unit failure and improper running. 

CAUTION

- Perform earth wiring surely. Do not connect the earth wiring to the gas pipe, water pipe, lightning rod and telephone earth wiring. Improper earth could cause unit failure and electric shock due to a short circuit. 
- Earth leakage breaker must be installed. If the earth leakage breaker is not installed, it can cause electric shocks. 
- Make sure to install earth leakage breaker on power source line. (countermeasure thing to high harmonics.) Absence of breaker could cause electric shock. 
- Use the circuit breaker of correct capacity. Circuit breaker should be the one that disconnect all poles under over current. Using the incorrect one could cause the system failure and fire. 
- Do not use any materials other than a fuse of correct capacity where a fuse should be used. Connecting the circuit by wire or copper wire could cause unit failure and fire. 
- Use power source line of correct capacity. Using incorrect capacity one could cause electric leak, abnormal heat generation and fire. 
- Do not mingle solid cord and stranded cord on power source and signal side terminal block. In addition, do not mingle difference capacity solid or stranded cord. Inappropriate cord setting could cause losing screw on terminal block, bad electrical contact, smoke and fire. 
- Do not turn off the power source immediately after stopping the operation. Be sure to wait for more than 5 minutes. Otherwise it could cause water leakage or breakdown. 
- Do not control the operation with the circuit breaker. It could cause fire or water leakage. In addition, the fan may start operation unexpectedly and it may cause injury. 

① Electrical Wiring Connection



- Use three-core cable as wiring between indoor and outdoor unit. As for detail, refer to "INSTALLATION MANUAL" of outdoor unit.
- Set earth of D-type.
- Keep "remote control line" and "power source line" away from each other on constructing of unit outside.
- Run the lines (power source, remote control and "between indoor and outdoor unit") upper ceiling through iron pipe or other tube protection to avoid the damage by mouse and so on.
- Do not add cord in the middle of line route (of power source, remote control and "between indoor and outdoor unit") on outside of unit. If connecting point is flooded, it could cause problem as for electric or communication. (In the case that it is necessary to set connecting point on the way, perform through waterproof measurement.)
- Do not connect the power source line [220V/240V/380V/415V] to signal side terminal block. Otherwise, it could cause failure.
- Screw the line to terminal block without any looseness, certainly.
- Do not turn on the switch of power source, before all of line work is done.
- Connection of the line ("Between indoor and outdoor unit", Earth and Remote control)
- ① Remove lid of control box before connect the above lines, and connect the lines to terminal block according to number pointed on label of terminal block.
- In addition, pay enough attention to confirm the number to lines, because there is electrical polarity except earth line. Furthermore, connect earth line to earth position of terminal block of power source.
- ② Install earth leakage breaker on power source line. In addition, select the type of breaker for inverter circuit as earth leakage breaker.
- ③ If the function of selected earth leakage breaker is only for earth-fault protection, hand switch (switch itself and type "B" fuse) or circuit breaker is required in series with the earth leakage breaker.
- ④ Install the local switch near the unit.

Cable connection for single unit installation

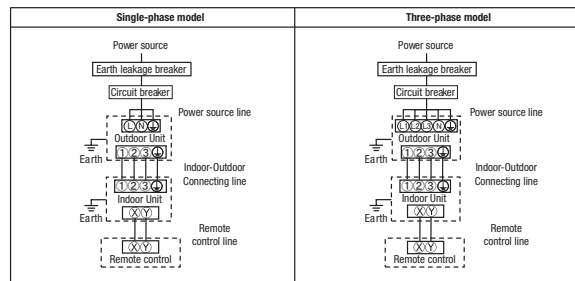
- ① As for connecting method of power source, select from following connecting patterns. In principle, do not directly connect power source line to inside unit.
 - ※ As for exceptional connecting method of power source, discuss with the power provider of the country with referring to technical documents, and follow its instruction.
- ② For cable size and circuit breaker selection, refer to the outdoor unit installation manual.



Cable connection for a V multi configuration installation

- ① Connect the same pairs number of terminal block "①, ②, and ③" and "④ and ⑤" between master and slave indoor units.
- ② Do the same address setting of all inside units belong to same refrigerant system by rotary switch SW2 on indoor unit's PCB (Printed circuit board).
- ③ Set slave indoor unit as "slave 1" through "slave 3" by address switch SW5-1, 5-2 on PCB.
- ④ When the [AIR CON NO.] button on the remote control unit is pressed after turning on the power, an indoor unit's address number will be displayed. Do not fail to confirm that the connected indoor unit's numbers are displayed on the remote control unit by pressing the  or  button.

Method of setting Master/Slave of indoor unit

(Factory setting: "Master")

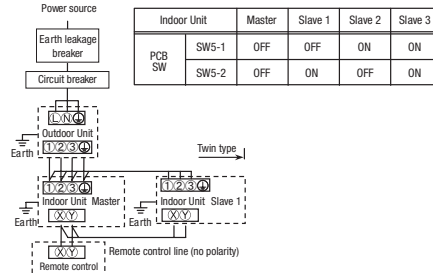

Switch and wiring specification

Refer to the installation manual attached to the outdoor unit.

② Wiring for the remote control

- For each indoor unit, one more remote control can be connected in addition to the one which is built in the main unit.

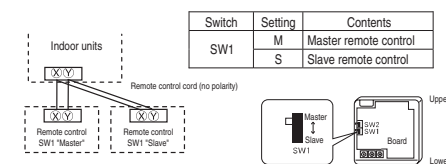

Set SW1 to "Slave" for the slave remote control. It was factory set to "Master" for shipment. Note: The setting "Remote control thermostat enabled" is only selectable with the master remote control in the position where you want to check room temperature. The air-conditioner operation follows the last operation of the remote control regardless of the master/ slave setting of it.

- * When setting the remote control built in the main unit to the "Slave": Remove the cover and change the setting of switch as follows.

② Wiring for the remote control (Continued)

- Open the remote control cover and remove the screw without fail.

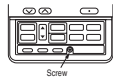

- Remove the upper case of remote control. Attach a flat head screwdriver at the upper part of remote control and pry lightly. It will come off easily. Use some cushion to protect the center panel.

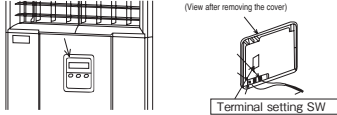

③ Function Setting by Remote Control

Installation and wiring of remote control

- Wiring of remote control should use 0.3mm² × 2 core wires or cables. (on-site configuration)
- Maximum prolongation of remote control wiring is 600 m. If the prolongation is over 100m, change to the size below. But, wiring in the remote control case should be under 0.5mm². Change the wire size outside of the case according to wire connecting. Waterproof treatment is necessary at the wire connecting section. Be careful about contact failure.

100 - 200m	0.5mm ² × 2 cores
Under 300m	0.75mm ² × 2 cores
Under 400m	1.25mm ² × 2 cores
Under 600m	2.0mm ² × 2 cores

The indication when power source is supplied

When power source is turned on, the following is displayed on the remote control until the communication between the remote control and indoor unit settled.

Master remote control : * @WAIT@ *
Slave remote control : * @WAIT@ *

At the same time, a mark or a number will be displayed for two seconds first. This is the software's administration number of the remote control, not an error cord.

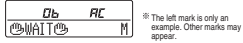

When remote control cannot communicate with the indoor unit for half an hour, the below indication will appear. Check wiring of the indoor unit and the outdoor unit etc.



How to set function

- Stop air-conditioner and press () (SET) () (MODE) buttons at the same time for over three seconds, and the "FUNCTION SET" will be displayed.
- Press () (SET) button.
- Make sure which do you want to set, "FUNCTION" (remote control function) or "I/U FUNCTION" (indoor unit function).
- Press () or () button. Select "FUNCTION" (remote control function) or "I/U FUNCTION" (indoor unit function).
- On the occasion of remote control function selection
 - "DATA LOADING" (Indication with blinking) → Display is changed to "01 GRILLE ↑ ↓ SET".
 - Press () or () button. "No. and function" are indicated by turns on the remote control function table, then you can select from them. (For example)

Function No.	Function
02	AUTO RUN SET
 - Press () (SET) button. The current setting of selected function is indicated. (for example) "AUTO RUN ON" ← If "02 AUTO RUN SET" is selected

Setting	Function No.
AUTO RUN ON	02
 - Press () or () button. Select the setting.

Function No.	Function
02	AUTO RUN ON
02	UTO RUN OFF
 - Press () (SET) button. "SET COMPLETE" will be indicated, and the setting will be completed. Then after "No. and function" indication returns, set as the same procedure if you want to set continuously, and if to finish, go to 7.

Function No.	Function
02	SET COMPLETE

On the occasion of indoor unit function selection

- "DATA LOADING" (Blinking for 2 to 23 seconds to read the data) → Indication is changed to "02 FAN SPEED SET". Go to ②.

[Note]

(1) If plural indoor units are connected to a remote control, the indication is "IU 000" (blinking) ← The lowest number of the indoor unit connected is indicated.

Function No.	Function
02	IU 0000
- Press () or () button. Select the number of the indoor unit you are to set. If you select "ALL UNIT", you can set the same setting with all units.
- Press () (SET) button.
- Press () or () button. "No. and function" are indicated by turns on the indoor unit function table, then you can select from them. (For example)

Function No.	Function
02	FAN SPEED SET

③ Function Setting by Remote Control (Continued)

- Press () (SET) button. The current setting of selected function is indicated. (For example) "STANDARD" ← If "02 FAN SPEED SET" is selected.

Function No.	Function
02	STANDARD
 - Press () or () button. Select the setting.
 - Press () (SET) button. "SET COMPLETE" will be indicated, and the setting will be completed. Then after "No. and function" indication returns, set as the same procedure if you want to set continuously, and if to finish, go to 7.

Function No.	Function
02	SET COMPLETE
- ※ When plural indoor units are connected to a remote control, press the (AIRCON NO.) button, which allows you to go back to the indoor unit selection screen. (example "IU 000") ▲
7. Press (ON/OFF) button. Setting is finished.

- It is possible to finish by pressing (ON/OFF) button on the way, but unfinished change of setting is unavailable.
- During setting, if you press () (RESET) button, you return to the previous screen.
- Setting is memorized in the control and it is saved independently of power failure.

How to check the current setting

When you select from "No. and function" and press set button by the previous operation, the "Setting" displayed first is the current setting. (But, if you select "ALL UNIT", the setting of the lowest number indoor unit is displayed.)

The functional setting

The initial function setting for typical usage is performed automatically by the indoor unit connected, when remote control and indoor unit are connected. As long as they are used in a typical manner, there will be no need to change the initial settings. If you would like to change the initial setting marked "○", set your desired setting as for the selected item. The procedure of functional setting is shown as the following diagram. Sequence of the function setting is as follows.

The range of temperature setting

When shipped, the range of set temperature differs depending on the operation mode as below.
Heating : 16-30°C (55-86°F)
Except heating (cooling, fan, dry, automatic) : 18-30°C (62-86°F)

Upper limit and lower limit of set temperature can be changed with remote control.

Upper limit setting: valid during heating operation. Possible to set in the range of 20 to 30°C (68 to 86°F).
Lower limit setting: valid except heating (automatic, cooling, fan, dry) Possible to set in the range of 18 to 26°C (62 to 79°F).
When you set upper and lower limit by this function, control as below.

- When () TEMP RANGE SET, remote control function of function setting mode is "INDN CHANGE" (factory setting). [If upper limit value is set] During heating, you cannot set the value exceeding the upper limit. [If lower limit value is set] During operation mode except heating, you cannot set the value below the lower limit.
- When () TEMP RANGE SET, remote control function of function setting mode is "NO INDN CHANGE" [If upper limit value is set] During heating, even if the value exceeding the upper limit is set, upper limit value will be sent to the indoor unit. But, the indication is the same as the temperature set. [If lower limit value is set] During except heating, even if the value lower than the lower limit is set, lower limit value will be sent to the indoor unit. But, the indication is the same as the temperature set.

How to set upper and lower limit value

- Stop the air-conditioner, and press () (SET) and () (MODE) button at the same time for over three seconds. The indication changes to "FUNCTION SET".
- Press () button once, and change to the "TEMP RANGE" indication.
- Press () (SET) button, and enter the temperature range setting mode.
- Select "UPPER LIMIT" or "LOWER LIMIT" by using () () button.
- Press () (SET) button to fix.
- When "UPPER LIMIT" is selected (valid during heating)
 - Indication: "∨ ∨ SET UP" → "UPPER 30°C ∨"
 - Select the upper limit value with temperature setting button () (). Indication example: "UPPER 26°C ∨" (blinking)
 - Press () (SET) button to fix. Indication example: "UPPER 26°C" (Displayed for two seconds) After the fixed upper limit value displayed for two seconds, the indication will return to "UPPER LIMIT".
- When "LOWER LIMIT" is selected (valid during cooling, dry, fan, automatic)
 - Indication: "∧ ∨ SET UP" → "LOWER 18°C ∧"
 - Select the lower limit value with temperature setting button () (). Indication example: "LOWER 24°C ∧" (blinking)
 - Press () (SET) button to fix. Indication for example: "LOWER 24°C" (Displayed for two seconds) After the fixed lower limit value displayed for two seconds, the indication will return to "LOWER LIMIT".
- Press (ON/OFF) button to finish.

- It is possible to finish by pressing (ON/OFF) button on the way, but unfinished change of setting is unavailable.
- During setting, if you press () (RESET) button, you return to the previous screen.

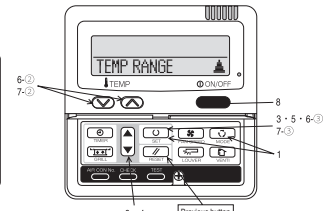

Note 1: Fan setting of "HIGH SPEED"

FAN SPEED SET	STANDARD	Indoor unit air flow setting					
		20~23	24~26	27~29	30~32	33~35	36~38
		UH - HI - Me - Lo	HI - Me - Lo	HI - Lo	HI - Me	UH - HI	
	HIGH SPEED1, 2	UH - UH - HI - Me	UH - HI - Me	UH - Me	UH - HI		

Initial function setting of some indoor unit is "HIGH SPEED"

Note 2: As for plural indoor unit, set indoor functions to each master and slave indoor unit. But only master indoor unit is received the setting change of indoor unit function "05 EXTERNAL INPUT" and "06 PERMISSION / PROHIBITION".

③ Function Setting by Remote Control (Continued)

[Flow of function setting]

- Start : While indoor unit do not operate, press " (SET) " and " (MODE) " button for 3 seconds at the same time.
- Finalize : Press " (SET) " button.
- Reset : Press " (RESET) " button.
- Select : Press " (UP) " button.
- End : Press " (ON/OFF) " button.

It is possible to finish above setting on the way, and unfinished change of setting is unavailable.
 * ○ : Initial settings
 * ※ : Automatic criterion
 As for detail, refer to the installation manual of remote control.

During air-conditioner stopping push (SET) + (MODE) button simultaneously for 3 seconds

Consult the technical data etc for each control details

Record and save the setting

Function	Setting	Function	Setting	
01 SCHEDULE T4 SET	setting T4 INVALD ○ 50Hz ZONE ONLY ○ 60Hz ZONE ONLY ○ When you use at 50Hz area When you use at 60Hz area	L/000 A L/001 4 L/002 4 L/003 4 L/004 4	02 FAN SPEED SET	setting STANDARD ○ HIGH SPEED 1 ※ HIGH SPEED 2 (Note2) ※
02 AUTO RUN SET	AUTO RUN ON ★ AUTO RUN OFF ○ Automatic operation is impossible		03 FILTER SIGN SET	INDICATION OFF ○ TYPE 1 ○ TYPE 2 ○ TYPE 3 ○ TYPE 4 ○ The filter sign is indicated after running for 180 hours. The filter sign is indicated after running for 1000 hours. The filter sign is indicated after running for 1000 hours, then it will be stopped by compulsion after 24 hours.
03 COOL TEMP SW	COOL VALID ○ COOL INVALD ○ Temperature setting button is not working		04 FAN POSITION	POSITION STOP ★ FREE STOP ○ The louver can stop at any position.
04 TEST MODE SW	TEST VALID ○ TEST INVALD ○ Mode button is not working		05 EXTERNAL INPUT	LEVEL INPUT ○ PULSE INPUT ○
05 ON/OFF SW	ON/OFF VALID ○ ON/OFF INVALD ○ On/Off button is not working		06 FAN CONTROL	INVALID ○ VALID ○ Make permission/prohibition control of function be in effect.
06 FAN SPEED SW	FAN VALID ○ FAN INVALD ○ Fan speed button is not working		07 EMERGENCY STOP	INVALID ○ VALID ○ With the VRF series, it is used to stop all indoor units connected with the same outdoor unit immediately. When stop signal is inputted from remote on-off terminal "CNT-6", all indoor units are stopped immediately.
07 LOUVER SW	LOUVER VALID ○ LOUVER INVALD ★ Louver button is not working		08 SP OFFSET	OFFSET +3.0C ○ OFFSET +2.0C ○ OFFSET +1.0C ○ NO OFFSET ○ To be reset for producing +3.0°C increase in temperature during heating. To be reset for producing +2.0°C increase in temperature during heating. To be reset for producing +1.0°C increase in temperature during heating.
08 TIMER SW	TIMER VALID ○ TIMER INVALD ○ Timer button is not working		09 RETURN AIR TEMP	OFFSET +2.0C ○ OFFSET +1.5C ○ OFFSET +1.0C ○ NO OFFSET ○ To be reset producing +2.0°C increase in return air temperature of indoor unit. To be reset producing +1.5°C increase in return air temperature of indoor unit. To be reset producing +1.0°C increase in return air temperature of indoor unit.
09 THERMISTOR SET	THERMISTOR OFF ○ THERMISTOR ON ○ THERMISTOR +3.0C ○ THERMISTOR +2.0C ○ THERMISTOR +1.0C ○ THERMISTOR -1.0C ○ THERMISTOR -2.0C ○ THERMISTOR -3.0C ○ Remote thermistor is not working. Remote thermistor is working. Remote thermistor is working, and to be set for producing +3.0°C increase in temperature. Remote thermistor is working, and to be set for producing +2.0°C increase in temperature. Remote thermistor is working, and to be set for producing +1.0°C increase in temperature. Remote thermistor is working, and to be set for producing -1.0°C increase in temperature. Remote thermistor is working, and to be set for producing -2.0°C increase in temperature. Remote thermistor is working, and to be set for producing -3.0°C increase in temperature.		10 FAN CONTROL	LOW FAN SPEED ○ SET FAN SPEED ○ INTERMITTENCE ○ FAN OFF ○ When heating thermostat is off, to be operated with low fan speed. (or with ultra low fan speed in case of some models) When heating thermostat is off, to be operated with set fan speed. When heating thermostat is off, the fan stops. When the remote thermistor is working, "FAN OFF" is set automatically. Do not set when the indoor unit's thermistor is working.
10 AUTO RESTART	INVALID ○ VALID ○		11 FROST PREVENTION TEMP	TEMP HIGH ○ TEMP LOW ○ Change of indoor heat exchanger temperature to start frost prevention control.
11 VENT LINK SET	NO VENT ○ VENT LINK ○ NO VENT LINK ○ Connect the Single split series and the VRF series to the indoor board CNT and indoor board CND respectively. If a ventilation device is connected, been geared with the motion of indoor device, the ventilation device is operated/stopped. By connecting the ventilation device with the Single split series device to indoor board CNT, the VRF series device to CND, you can operate/stop the ventilation device independently by the handling of ventilation button.		12 FROST PREVENTION CONTROL	FAN CONTROL ON ○ FAN CONTROL OFF ○ Working only with the single split series. To control frost prevention, the indoor fan tap is raised.
12 TOP RANGE SET	TEMP CHANGE ○ NO TEMP CHANGE ○ If you change the range of set temperature, the indication of set temperature will vary following the control. If you change the range of set temperature, the indication of set temperature will not vary following the control, and keep the set temperature.		13 DRAIN PUMP LINK	ON ○ AND ○ AND ○ AND ○ Drain pump is on during cooling and dry. Drain pump is on during cooling, dry and heating. Drain pump is on during cooling, dry, heating and fan. Drain pump is on during cooling, dry and fan.
13 FAN	HI-MID-LO ○ HI-LO ★ HI-MID ★ FAN SPEED ★ Airflow of fan becomes the three speed of $R_{set} - R_{set} - R_{set}$ or $R_{set} - R_{set} - R_{set}$.		14 FAN REMAINING	NO REMAINING ○ 0.5 HOUR ○ 1 HOUR ○ 6 HOUR ○ After cooling is stopped or cooling thermostat is off, the fan does not perform extra operation. After cooling is stopped or cooling thermostat is off, the fan perform extra operation for half an hour. After cooling is stopped or cooling thermostat is off, the fan perform extra operation for an hour. After cooling is stopped or cooling thermostat is off, the fan perform extra operation for six hours.
14 FAN POSITION	POSITION STOP ★ FREE STOP ○ The louver can stop at any position.		15 FAN REMAINING	NO REMAINING ○ 0.5 HOUR ○ 2 HOUR ○ 6 HOUR ○ After heating is stopped or heating thermostat is off, the fan does not perform extra operation. After heating is stopped or heating thermostat is off, the fan perform extra operation for half an hour. After heating is stopped or heating thermostat is off, the fan perform extra operation for two hours. After heating is stopped or heating thermostat is off, the fan perform extra operation for six hours.
15 MODEL TYPE	HEAT PUMP ※ COOLING ONLY ※		16 FAN INTERMITTENCE	NO REMAINING ○ 20min OFF 5min ON ○ 5min OFF 5min ON ○ During heating is stopped or heating thermostat is off, the fan perform intermittent operation for five minutes after twenty minutes' off with low airflow. During heating is stopped or heating thermostat is off, the fan perform intermittent operation for five minutes after five minutes' off with low airflow.
16 EXTERNAL CONTROL SET	INDIVIDUAL ○ FOR ALL UNITS ○ If you input into the indoor printed circuit board CNT from outside, the indoor device will be operated independently following the input from outside. If you input into indoor printed circuit board CNT from outside, All units which share the same one remote control network work following the input from outside.			
17 ROOM TEMP INDICATION SET	INDICATION OFF ○ INDICATION ON ○ In normal working indication, indoor unit temperature is indicated instead of airflow. (Only the master remote control can be indicated.)			
18 ROOM INDICATION	INDICATION ON ○ INDICATION OFF ○ Heating preparation indication should not be indicated.			
19 UNIT SET	C ○ F ○ Temperature indication is by degree C Temperature indication is by degree F			

ON/OFF button (finished) Items marked with * are not available on the floor standing FDF. Do not change the initial setting

④ Trial operation

The method of trial cooling operation

Operate the remote control unit as follows.

1. Starting a cooling test run.

- Start the system by pressing the (ON/OFF) button.
- Select " (Cool) " with the (MODE) button.
- Press the (TEST) button for 3 seconds or longer.
The screen display will switch to TEST RUN

④When the (SET) button is pressed while " TEST RUN " is indicated, a cooling test run will start.

The screen display will switch to TEST RUN

2. Ending a cooling test run.

- Pressing the (ON/OFF) button, the (TEMP) button or (MODE) button will end a cooling test run. (Cooling test run will end after 30 minutes pass.)
 " TEST RUN " shown on the screen will go off.

④ Trial operation (Continued)

Checking operation data

Operation data can be checked with remote control unit operation.

1. Press the [CHECK] button.

The display change "OPER DATA ▼"

2. Press the (SET) button while "OPER DATA ▼" is displayed.

3. When only one indoor unit is connected to remote control, "DATA LOADING" is displayed (blinking indication during data loading).

Next, operation data of the indoor unit will be displayed. Skip to step 7.

4. When plural indoor units is connected, the smallest address number of indoor unit among all connected indoor unit is displayed.

[Example]:

SELECT I/U (blinking 1 seconds)
I/U000 ▲ (blinking)

5. Select the indoor unit number you would like to have data displayed with the (▲) (▼) button.

6. Determine the indoor unit number with the (SET) button.

(The indoor unit number changes from blinking indication to continuous indication)

I/U000 (The address of selected indoor unit is blinking for 2 seconds.)



"DATA LOADING" (A blinking indication appears while data loaded.)

Next, the operation data of the indoor unit is indicated.

7. Upon operation of the (▲) (▼) button, the current operation data is displayed in order from data number 01.

The items displayed are in the above table.

※Depending on models, the items that do not have corresponding data are not displayed.

8. To display the data of a different indoor unit, press the [AIR CON NO.] button, which allows you to go back to the indoor unit selection screen.

9. Pressing the [ON/OFF] button will stop displaying data.

Pressing the (RESET) button during remote control unit operation will undo your last operation and allow you to go back to the previous screen.

◎If two (2) remote control are connected to one (1) inside unit, only the master controller is available for trial operation and confirmation of operation data. (The slave remote control is not available.)

Number	Data Item
01	⊗ (Operation Mode)
02	SET TEMP (Set Temperature)
03	RETURN AIR (Return Air Temperature)
04	SENSOR (Remote Control Thermistor Temperature)
05	THI-R1 (Indoor Unit Heat Exchanger Thermistor / U Bene)
06	THI-R2 (Indoor Unit Heat Exchanger Thermistor / Capillary)
07	THI-R3 (Indoor Unit Heat Exchanger Thermistor / Gas Header)
08	I/U FANSPEED (Indoor Unit Fan Speed)
09	DEMAND (Frequency Requirements)
10	ANSWER (Response Frequency)
11	I/U EEV (Pulse of Indoor Unit Expansion Valve)
12	TOTAL I/U RUN (Total Running Hours of The Indoor Unit)
21	OUTDOOR (Outdoor Air Temperature)
22	THO-R1 (Outdoor Unit Heat Exchanger Thermistor)
23	THO-R2 (Outdoor Unit Heat Exchanger Thermistor)
24	COMP (Compressor Frequency)
25	HP (High Pressure)
26	LP (Low Pressure)
27	Td (Discharge Pipe Temperature)
28	COMP BOTTOM (Comp Bottom Temperature)
29	CT (Current)
30	TARGET SH (Target Super Heat)
31	SH (Super Heat)
32	TDSH (Discharge Pipe Super Heat)
33	PROTECTION No. (Protection State No. of The Compressor)
34	O/U FANSPEED (Outdoor Unit Fan Speed)
35	CSH1 (CSH1 On/Off)
36	DEFROST (Defrost Control On/Off)
37	TOTAL COMP RUN (Total Running Hours of The Compressor)
38	O/U EEV2 (Pulse of The Outdoor Unit Expansion Valve EHV)
39	O/U EEV2 (Pulse of The Outdoor Unit Expansion Valve EHV)

※Depending on outdoor unit model, there are data not shown.

⑤ Control mode switching

●The control content of indoor units can be switched in following way. () is the default setting

Switch No.	Control Content
SW2	Indoor unit address (0-Fh)
SW5-1	Master/Slave Switching (plural /Slave unit Setting)
SW5-2	
SW6-1~4	Model capacity setting
SW7-1	ON Operation check, Drain motor test run
	OFF Normal operation

⑥ Function of CNT connector of indoor printed circuit board

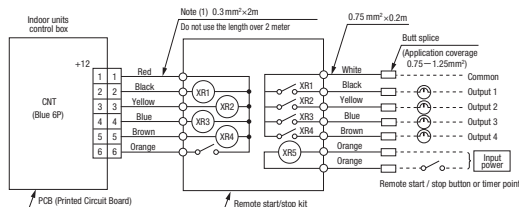

●CNT connector (local) vendor model
Connector : Made by molex 5264 - 06
Terminals : Made by molex 5263T

●Function

Output 1	Operation output (there is output when unit is in operation.)
Output 2	Heating output (there is output when operation MODE is HEATING.)
Output 3	Compressor ON output (there is output when compressor is in operation.)
Output 4	Inspection output (there is output when unit is stopped by error.)
Input 5	Remote operation input (Volt-free contact) (Inputted to operate unit)

⑦ Troubleshooting

The operation data is saved when the situation of abnormal operation happen, and the data can be confirmed by remote control.

Error Code of indoor unit

Display on remote control	LED on indoor circuit board		Content
	red (checking)	green (normal)	
Off	Off	Continuous blinking	Normal
Off	Off	Off	Fault on power, indoor power off or lack phase
E1	Off	Continuous blinking	Fault on the transmission between indoor circuit board and remote control
E5	Blinking twice	Continuous blinking	Indoor computer abnormal
E6	Blinking once	Continuous blinking	Fault on outdoor-indoor transmission
E7	Blinking once	Continuous blinking	Indoor heat exchange sensor interrupted or short-circuit
E8	Blinking once	Continuous blinking	Indoor air inhaling sensor broken or short-circuit
E8	Blinking once	Continuous blinking	The temperature of heat exchange abnormal
E9	Blinking once	Continuous blinking	Float SW actions (only with FS)
E10	Off	Continuous blinking	Excess number of remote control connections
E14	Blinking for three times	Continuous blinking	The communication fault for master/slave indoor units
E16	Blinking once	Continuous blinking	Fan motor abnormal
E19	Blinking once	Continuous blinking	Configuration fault on running checking model
E28	Off	Continuous blinking	Remote control sensor interrupted
Over E30	Off	Continuous blinking	Outdoor unit checking (outdoor circuit board LED checking)

(Operating procedure)

1. Press the [CHECK] button.

The display change "OPER DATA ▼"

2. Once, press the (▼) button, and the display change "ERROR DATA ▲"

3. Press the (SET) button and abnormal operation data mode is started.

4. When only one indoor unit is connected to remote control, following is displayed.

①The case that there is history of abnormal operation.

→ Error code and "DATA LOADING" is displayed.

[Example]: [E8] (ERROR CODE)

"DATA LOADING" is displayed (blinking indication during data loading).

Next, the abnormal operation data of the indoor unit will be displayed. Skip to step 8.

②The case that there is not history of abnormal operation.

→ "NO ERROR" is displayed for 3 seconds and this mode is closed.

5. When plural indoor units is connected, following is displayed.

①The case that there is history of abnormal operation.

→ Error code and the smallest address number of indoor unit among all connected indoor unit is displayed.

[Example]: [E8] (ERROR CODE)

"I/U000 ▲" blinking

②The case that there is not history of abnormal operation.

→ Only address number is displayed.

6. Select the indoor unit number you would like to have data displayed with the (▲) (▼) button.

7. Determine the indoor unit number with the (SET) button.

[Example]: [E8] (ERROR CODE)

"I/U000 ▲" (The address of selected indoor unit is blinking for 2 seconds.)



[E8] "DATA LOADING" (A blinking indication appears while data loaded.)

Next, the abnormal operation data is indicated.

If the indoor unit doing normal operation is selected, "NO ERROR" is displayed for 3 seconds and address of indoor unit is displayed.

8. By the (▲) (▼) button, the abnormal operation data is displayed.

Displayed data item is based on ③ Trial operation

※Depending on models, the items that do not have corresponding data are not displayed.

9. To display the data of a different indoor unit, press the [AIR CON NO.] button, which allows you to go back to the indoor unit selection screen.

10. Pressing the [ON/OFF] button will stop displaying data.

Pressing the (RESET) button during remote control unit operation will undo your last operation and allow you to go back to the previous screen.

◎If two (2) remote control are connected to one (1) indoor unit, only the master controller is available for trial operation and confirmation of operation data. (The slave remote control is not available.)

10.3 Installation of wired remote control (Option)

(1) Model RC-EX1A

PJZ012D077 

eco touch REMOTE CONTROL RC-EX1A INSTALLATION MANUAL

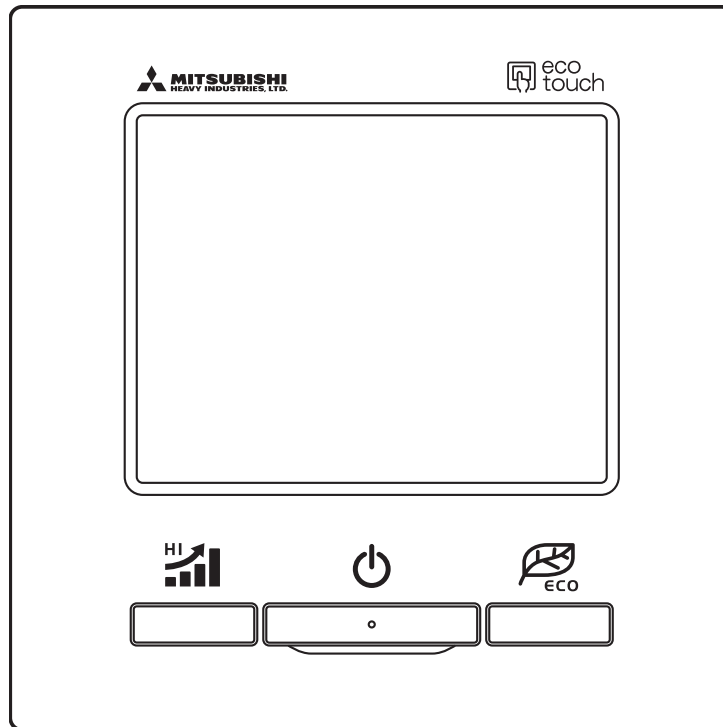



1 . Safety precautions

This installation manual describes the installation methods and precautions related to the remote control. Use this manual together with the user's manuals for the indoor unit, outdoor unit and other option equipment. Please read this manual carefully before starting the installation work to install the unit properly.

Safety precautions

- Please read this manual carefully before starting installation work to install the unit properly. Every one of the followings is important information to be observed strictly.

 WARNING	Failure to follow these instructions properly may result in serious consequences such as death, severe injury, etc..
 CAUTION	Failure to follow these instructions properly may cause injury or property damage.

It could have serious consequences depending on the circumstances.

- The following pictograms are used in the text.

 Never do.	 Always follow the instructions given.
---	---

- Keep this manual at a safe place where you can consult with whenever necessary. Show this manual to installers when moving or repairing the unit. When the ownership of the unit is transferred, the “Installation Manual” should be given to a new owner.

WARNING

Ask a professional contractor to carry out installation work according to the installation manual. 
 Improper installation work may result in electric shocks, fire or break-down.

Shut OFF the main power source before starting electrical work. 
 Otherwise, it could result in electric shocks, break-down or malfunction.

Do not install the unit in appropriate environment or where inflammable gas could generate, flow in, accumulate or leak. 
 If the unit is used at places where air contains dense oil mist, steam, organic solvent vapor, corrosive gas (ammonium, sulfuric compound, acid, etc) or where acidic or alkaline solution, special spray, etc. are used, it could cause electric shocks, break-down, smoke or fire as a result of significant deterioration of its performance or corrosion.

Do not install the unit where water vapor is generated excessively or condensation occurs. 
 It could cause electric shocks, fire or break-down.

Use the specified cables for wiring, and connect them securely with care to protect electronic parts from external forces. 
 Improper connections or fixing could cause heat generation, fire, etc.

Seal the inlet hole for remote control cable with putty. 
 If dew, water, insect, etc. enters through the hole, it could cause electric shocks, fire or break-down.

When installing the unit at a hospital, telecommunication facility, etc., take measures to suppress electric noises.

It could cause malfunction or break-down due to hazardous effects on the inverter, private power generator, high frequency medical equipment, radio communication equipment, etc.

The influences transmitted from the remote control to medical or communication equipment could disrupt medical activities, video broadcasting or cause noise interference.



 CAUTION

Do not install the remote control at following places.

It could cause break-down or deformation of remote control.

- (1) Where it is exposed to direct sunlight
- (2) Near the equipment to generate heat
- (3) Where the surface is not flat



Do not leave the remote control with its upper case removed.

When the upper case is removed, put it in a packing box or packing bag to protect internal PCBs or other parts from dust, moisture, etc.



2 . Accessories & prepare on site

Accessories	R/C main unit, wood screw (ø3.5 x 16) 2 pcs User's Manual, Installation Manual
-------------	---

Parts procured at site

Item name	Q'ty	Remark
Switch box For 1 piece or 2 pieces (JIS C 8340 or equivalent)	1	These are not required when installing directly on a wall.
Thin wall steel pipe for electric appliance (JIS C 8305 or equivalent)	As required	
Lock nut, bushing (JIS C 8330 or equivalent)	As required	
Lacing (JIS C 8425 or equivalent)	As required	Necessary to run R/C cable on the wall.
Putty	Suitably	For sealing gaps
Molly anchor	As required	
R/C cable (0.3 mm ² x 2 pcs)	As required	See right table when longer than 100 m

When the cable length is longer than 100 m, the max size for wires used in the R/C case is 0.5 mm². Connect them to wires of larger size near the outside of R/C. When wires are connected, take measures to prevent water, etc. from entering inside.

< 200 m	0.5 mm ² x 2-core
< 300 m	0.75 mm ² x 2-core
< 400 m	1.25 mm ² x 2-core
< 600 m	2.0 mm ² x 2-core

3. Remote control installation procedure

Determine where to install the remote control

Installation	“Using a switch box” “Installed directly on a wall”
Wiring direction	“Backward” “Upper center”, “Upper left”

Cautions for selecting installation place

- (1) Installation surface must be flat and sufficiently strong.
R/C case must not be deformed.
- (2) Where the R/C can detect room temperatures accurately.
This is a must when detecting room temperatures with the temperature sensor of R/C.
 - Install the R/C where it can detect the average temperature in the room.
 - Install the R/C separated from a heat source sufficiently.
 - Install the R/C where it will not be influenced by the turbulence of air when the door is opened or closed.
 Select a place where the R/C is not exposed to direct sunlight or blown by winds from the air-conditioner or temperatures on the wall surface will not deviate largely from actual room temperature.

Installation space

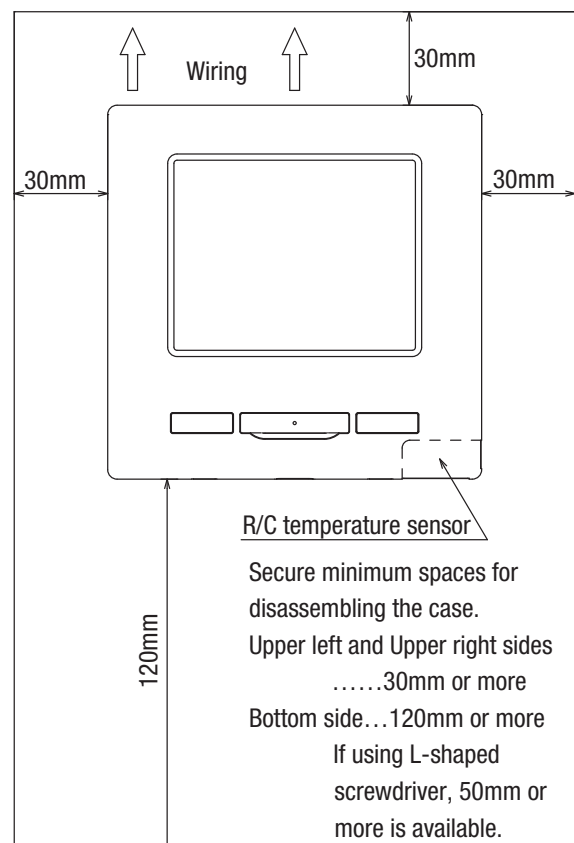

Request

Be sure not to install R/C at a place where temperatures around the installation surface of R/C may differ largely from actual room temperature.
 Difference between detected temperature and actual room temperature could cause troubles.
 The correction for detected temperature by the R/C cannot offset such temperature difference because it corrects the detected temperatures itself.



Request

Do not install the R/C at a place where it is exposed to direct sunlight or where surrounding air temperature exceeds 40°C or drops below 0°C.
 It could cause discoloration, deformation, malfunction or breakdown.



Installation procedure

Dimensions (Viewed from front)

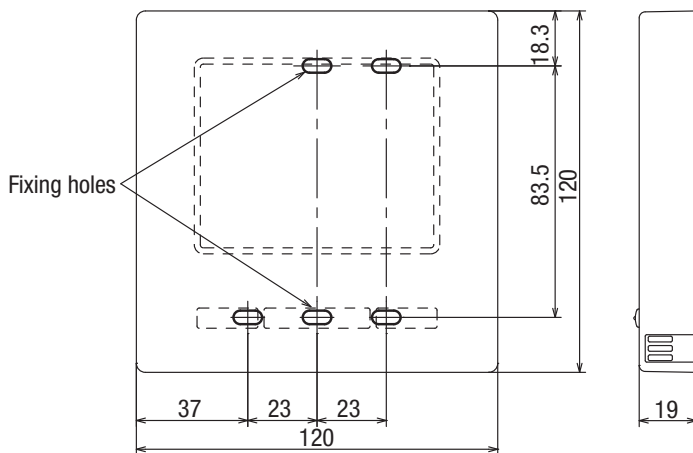

PCB side (Viewed from rear)

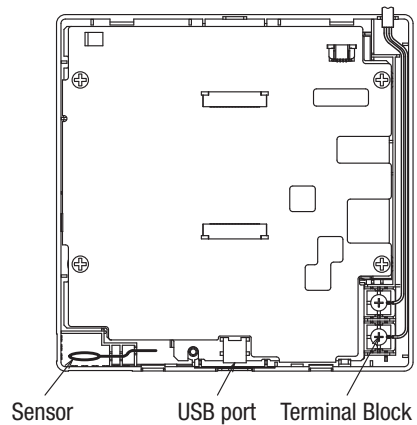

- ① To remove the upper case from the bottom cases of R/C
 - Insert the tip of flat head screwdriver or the like in the recess at the lower part of R/C and twist it lightly to remove.

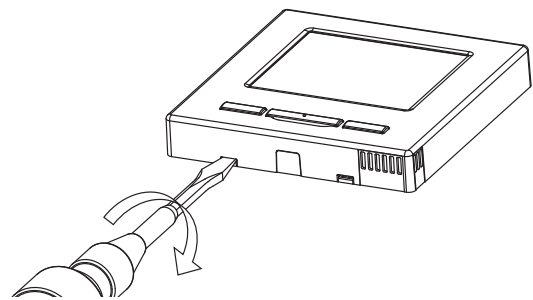

Take care to protect the removed upper case from moisture or dust.

- ② Connect wires from X and Y terminals of R/C to X and Y terminals of indoor unit.
 R/C wires (X, Y) have no polarity.

In case of embedding wiring (When the wiring is retrieved "Backward")

- ③ Embed the switch box and the R/C wires beforehand.

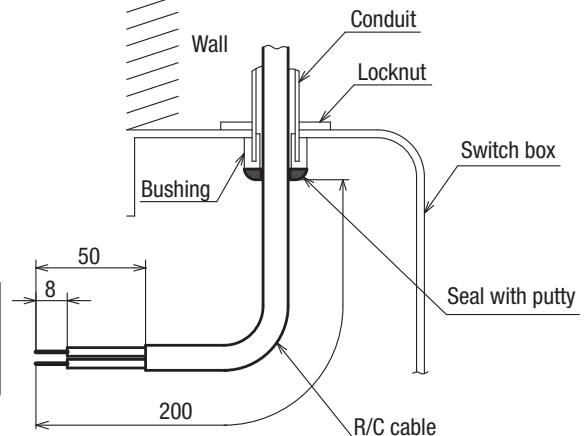

Seal the inlet hole for the R/C wiring with putty.
 ● If dust or insect enters, it could cause electric shocks, fire or breakdown.

- ④ When wires are passed through the bottom case, fix the bottom case at 2 places on the switch box.

Switch box for 1 pc

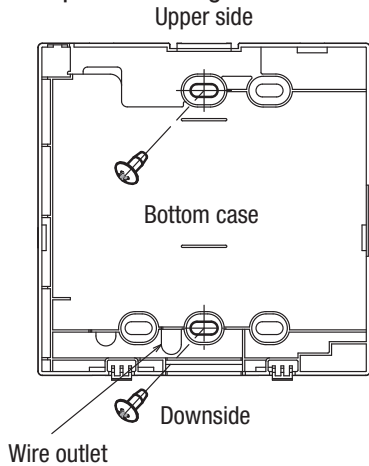

Switch box for 2 pcs

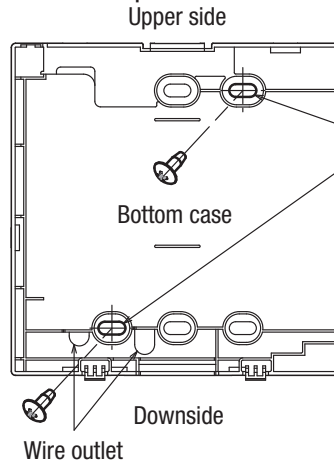

- ⑤ When fixing the bottom case diagonally at 2 places, cut out the thin wall section on the case.
 ⑥ Fix wires such that the wires will run around the terminal screws on the top case of R/C.

Cautions for wire connection

Use wires of no larger than 0.5 mm² for wiring running through the remote control case. Take care not to pinch the sheath.

Tighten by hand (0.7 N·m or less) the wire connection. If the wire is connected using an electric driver, it may cause failure or deformation.

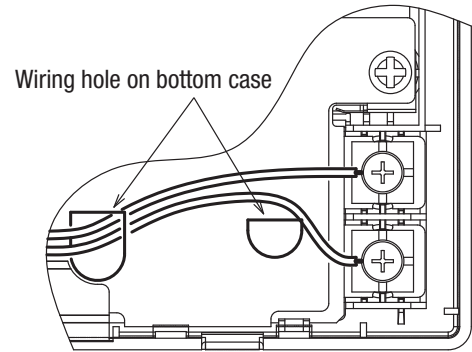
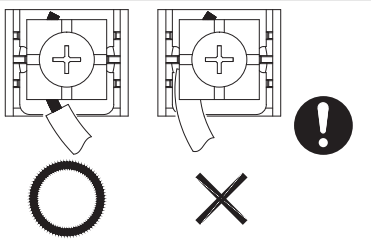

- ⑦ Install the upper case with care not to pinch wires of R/C.

In case of exposing wiring (When the wiring is taken out from the “upper center” or “upper left” of R/C)

- ③ Cut out the thin wall sections on the cases for the size of wire.

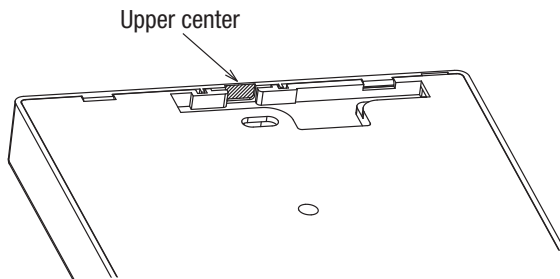

When taking the wiring out from the upper center, open a hole before separating the upper and bottom cases. This will reduce risk of damaging the PCB and facilitate subsequent work.

When taking the wiring out from the upper left, take care not to damage the PCB and not to leave any chips of cut thin wall inside.

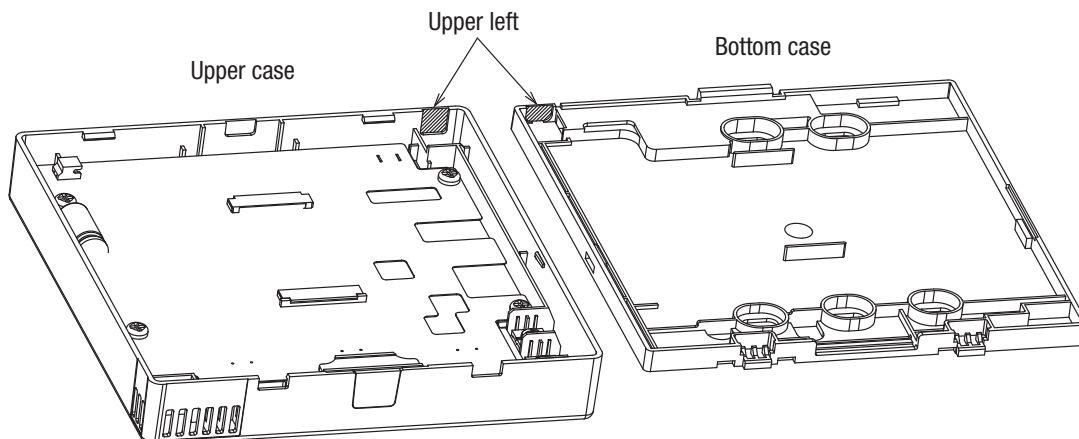

If the hole is cut too large, moisture, dust or insects may enter.
Seal gaps with putty or the like.



- ④ Fix the bottom R/C case on a flat surface with wood screws.
- ⑤ In case of the upper center, pass the wiring behind the bottom case. (Hatched section)
- ⑥ Fix wires such that the wires will run around the terminal screw of the top case of R/C.
- ⑦ Install the top case with care not to pinch wires of R/C.

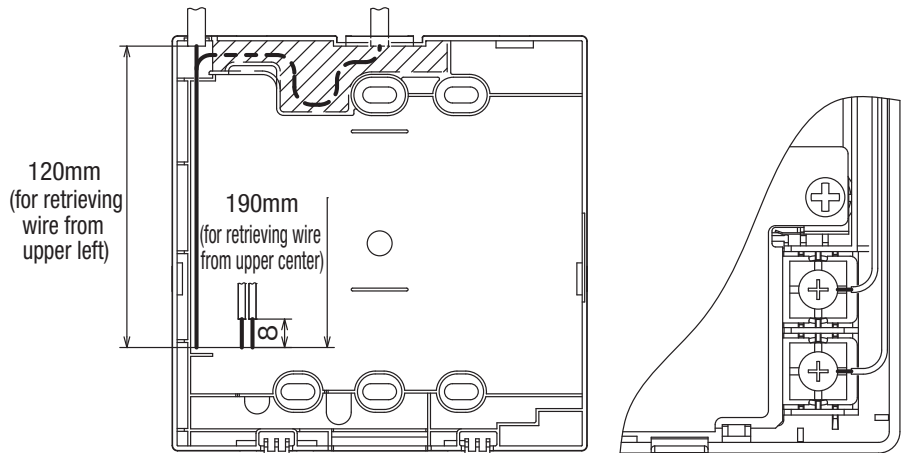

Main/Sub setting when more than one remote control are used

Main-Sub setting for use of two or more R/C

Up to two units of R/C can be used at the maximum for 1 indoor unit or 1 group.

One is main R/C and the other is sub R/C.

Operating range is different depending on the main or sub R/C.

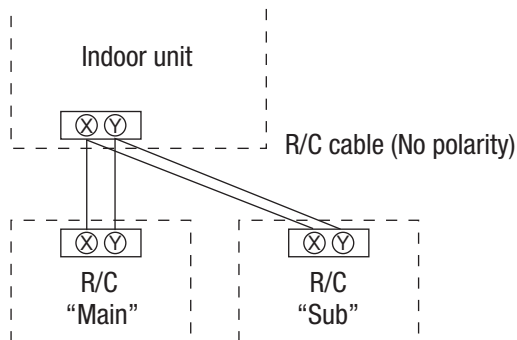

Set the "Main" and "Sub" as described at Section 7 of installation manual attached to the remote control.

R/C function	Main	Sub
Run/Stop, setting temperature, fan speed and flap direction operations	<input type="radio"/>	<input type="radio"/>
High power and energy-saving operations	<input type="radio"/>	<input type="radio"/>
Energy-saving setting	<input type="radio"/>	—
R/C sensor	<input type="radio"/>	—
Test run menu operation	<input type="radio"/>	—
Room temperature range setting	<input type="radio"/>	—
Indoor unit settings	<input type="radio"/>	—
Individual flap control	<input type="radio"/>	—
Operation data display	<input type="radio"/>	—
Error history display	<input type="radio"/>	<input type="radio"/>

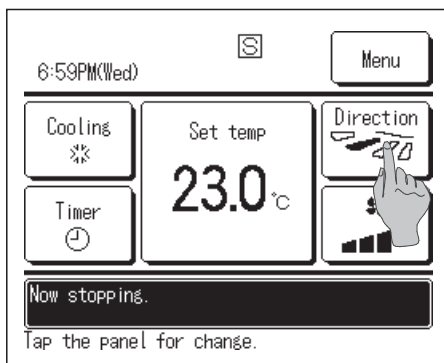

Note: Connection to personal computer

It can be set from a personal computer via the USB port (mini-B).
Connect after removing the cover for USB port of upper case.

Replace the cover after use.

If dust, insect, etc. enters, it could cause electric shocks or breakdown.



Special software is necessary for the connection.
For details, view the web site or refer to the engineering data.

Do not connect to a personal computer without using the special software.

Do not connect the personal computer to the USB simultaneously with other USB devices.
It could cause malfunction or breakdown of R/C or personal computer.

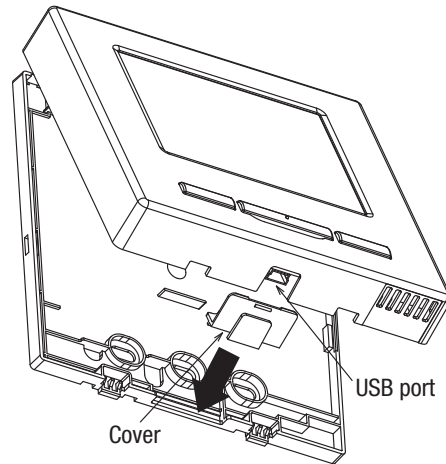

Note: Initializing of password

Administrator password (for daily setting items) and service password (for installation, test run and maintenance) are used.

- The administrator password at factory default is “0000”. This setting can be changed (Refer to User's Manual). When the administrator password is forgotten, it can be initialized, if the [High power] and the [Energy-saving] buttons are pushed simultaneously for 5 seconds on the administrator password input screen.
- Service password is “9999”, which cannot be changed.
When the administrator password is input, the service password is also accepted.

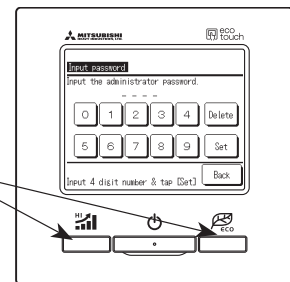

(2) Model RC-E5

PJA012D730

Read together with indoor unit's installation manual.

⚠ WARNING

- Fasten the wiring to the terminal securely and hold the cable securely so as not to apply unexpected stress on the terminal.
Loose connection or hold will cause abnormal heat generation or fire. !
- Make sure the power source is turned off when electric wiring work.
Otherwise, electric shock, malfunction and improper running may occur. !

⚠ CAUTION

- DO NOT install the remote control at the following places in order to avoid malfunction.

(1) Places exposed to direct sunlight	(4) Hot surface or cold surface enough to generate condensation
(2) Places near heat devices	(5) Places exposed to oil mist or steam directly
(3) High humidity places	(6) Uneven surface

⊘
- DO NOT leave the remote control without the upper case.
In case the upper case needs to be detached, protect the remote control with a packaging box or bag in order to keep it away from water and dust. ⊘

Accessories	Remote control, wood screw (ø3.5×16) 2 pieces
Prepare on site	Remote control cord (2 cores) the insulation thickness in 1mm or more. [In case of embedding cord] Electrical box, M4 screw (2 pieces) [In case of exposing cord] Cord clamp (if needed)

Installation procedure

- ① Open the cover of remote control, and remove the screw under the buttons without fail.
- ② Remove the upper case of remote control.
Insert a flat-blade screwdriver into the dented part of the upper part of the remote control, and wrench slightly.

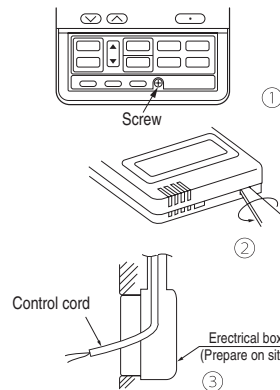

[In case of embedding cord]

- ③ Embed the electrical box and remote control cord beforehand.

- ④ Prepare two M4 screws (recommended length is 12-16mm) on site, and install the lower case to electrical box. Choose either of the following two positions in fixing it with screws.

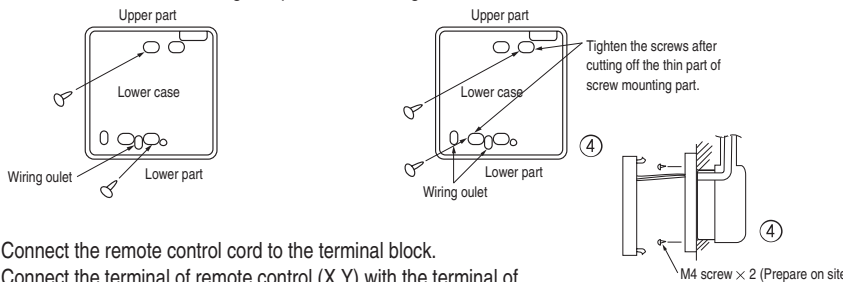

- ⑤ Connect the remote control cord to the terminal block.
Connect the terminal of remote control (X,Y) with the terminal of indoor unit (X,Y). (X and Y are no polarity)

- ⑥ Install the upper case as before so as not to catch up the remote control cord, and tighten with the screws.

[In case of exposing cord]

- ③ You can pull out the remote control cord from left upper part or center upper part.
Cut off the upper thin part of remote control lower case with a nipper or knife, and grind burrs with a file etc.
- ④ Install the lower case to the flat wall with attached two wooden screws.

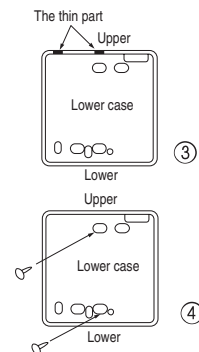

- ⑤ Connect the remote control cord to the terminal block.
 Connect the terminal of remote control (X,Y) with the terminal of indoor unit (X,Y).
 (X and Y are no polarity)
 Wiring route is as shown in the right diagram depending on the pulling out direction.

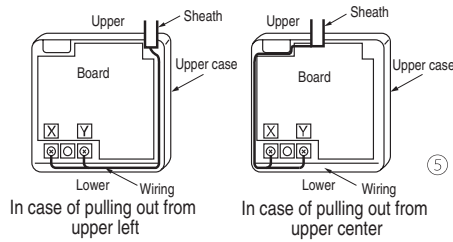

The wiring inside the remote control case should be within 0.3mm² (recommended) to 0.5mm².
 The sheath should be peeled off inside the remote control case.
 The peeling-off length of each wire is as below.

Pulling out from upper left	Pulling out from upper center
X wiring : 215mm	X wiring : 170mm
Y wiring : 195mm	Y wiring : 190mm

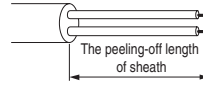

- ⑥ Install the upper case as before so as not to catch up the remote control cord, and tighten with the screws.
 ⑦ In case of exposing cord, fix the cord on the wall with cord clamp so as not to slack.

Installation and wiring of remote control

- ① Wiring of remote control should use 0.3mm² × 2 core wires or cables. (on-site configuration)
 ② Maximum prolongation of remote control wiring is 600 m.
 If the prolongation is over 100m, change to the size below.
 But, wiring in the remote control case should be under 0.5mm². Change the wire size outside of the case according to wire connecting. Waterproof treatment is necessary at the wire connecting section. Be careful about contact failure.
 100 - 200m.....0.5mm² × 2 cores
 Under 300m.....0.75mm² × 2 cores
 Under 400m.....1.25mm² × 2 cores
 Under 600m.....2.0mm² × 2 cores

Master/ slave setting when more than one remote controls are used

A maximum of two remote controls can be connected to one indoor unit (or one group of indoor units.)

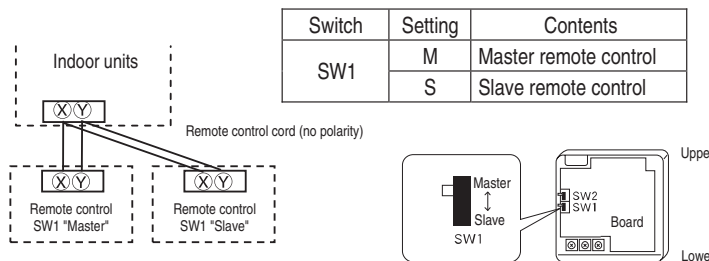

Set SW1 to "Slave" for the slave remote control. It was factory set to "Master" for shipment.
 Note: The setting "Remote control thermistor enabled" is only selectable with the master remote control in the position where you want to check room temperature.
 The air-conditioner operation follows the last operation of the remote control regardless of the master/ slave setting of it.

The indication when power source is supplied

When power source is turned on, the following is displayed on the remote control until the communication between the remote control and indoor unit settled.

Master remote control : " WAIT M"
 Slave remote control : " WAIT S"

At the same time, a mark or a number will be displayed for two seconds first.
 This is the software's administration number of the remote control, not an error cord.

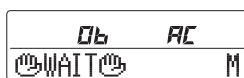

※ The left mark is only an example. Other marks may appear.

When remote control cannot communicate with the indoor unit for half an hour, the below indication will appear.
 Check wiring of the indoor unit and the outdoor unit etc.

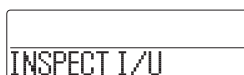

The range of temperature setting

When shipped, the range of set temperature differs depending on the operation mode as below.

Heating : 16-30°C (55-86°F)

Except heating (cooling, fan, dry, automatic) : 18-30°C (62-86°F)

●Upper limit and lower limit of set temperature can be changed with remote control.

Upper limit setting: valid during heating operation. Possible to set in the range of 20 to 30°C (68 to 86°F).

Lower limit setting: valid except heating (automatic, cooling, fan, dry) Possible to set in the range of 18 to 26°C (62 to 79°F).

When you set upper and lower limit by this function, control as below.

- When ② TEMP RANGE SET, remote control function of function setting mode is "INDN CHANGE" (factory setting),
 【 If upper limit value is set 】
 During heating, you cannot set the value exceeding the upper limit.
 【 If lower limit value is set 】
 During operation mode except heating, you cannot set the value below the lower limit.
- When ② TEMP RANGE SET, remote control function of function setting mode is "NO INDN CHANGE"
 【 If upper limit value is set 】
 During heating, even if the value exceeding the upper limit is set, upper limit value will be sent to the indoor unit.
 But, the indication is the same as the temperature set.
 【 If lower limit value is set 】
 During except heating, even if the value lower than the lower limit is set, lower limit value will be sent to the indoor unit.
 But, the indication is the same as the temperature set.

●How to set upper and lower limit value

- Stop the air-conditioner, and press (SET) and (MODE) button at the same time for over three seconds.
 The indication changes to "FUNCTION SET ▼".
- Press button once, and change to the "TEMP RANGE ▲" indication.
- Press (SET) button, and enter the temperature range setting mode.
- Select "UPPER LIMIT ▼" or "LOWER LIMIT ▲" by using button.
- Press (SET) button to fix.
- When "UPPER LIMIT ▼" is selected (valid during heating)
 - ① Indication: " ▼ ^ SET UP" → "UPPER 30°C ▼"
 - ② Select the upper limit value with temperature setting button . Indication example: "UPPER 26°C ▼ ^" (blinking)
 - ③ Press (SET) button to fix. Indication example: "UPPER 26°C" (Displayed for two seconds)
 After the fixed upper limit value displayed for two seconds, the indication will return to "UPPER LIMIT ▼".
- When "LOWER LIMIT ▲" is selected (valid during cooling, dry, fan, automatic)
 - ① Indication: " ▼ ^ SET UP" → "LOWER 18°C ^"
 - ② Select the lower limit value with temperature setting button . Indication example: "LOWER 24°C ▼ ^" (blinking)
 - ③ Press (SET) button to fix. Indication for example: "LOWER 24°C" (Displayed for two seconds)
 After the fixed lower limit value displayed for two seconds, the indication will return to "LOWER LIMIT ▼".
- Press button to finish.

• It is possible to finish by pressing button on the way, but unfinished change of setting is unavailable.

• During setting, if you press (RESET) button, you return to the previous screen.

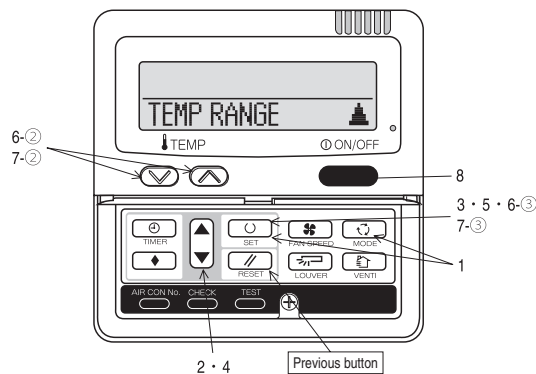

The functional setting

- The initial function setting for typical using is performed automatically by the indoor unit connected, when remote control and indoor unit are connected.
- As long as they are used in a typical manner, there will be no need to change the initial settings.
- If you would like to change the initial setting marked "○", set your desired setting as for the selected item.
- The procedure of functional setting is shown as the following diagram.

[Flow of function setting]

Start : Stop air-conditioner and press "○" (SET) and "MODE" (MODE) buttons at the same time for over three seconds.
 Finalize : Press "○" (SET) button.
 Reset : Press "RESET" (RESET) button.
 Select : Press "▲" (UP) button.
 End : Press [ON/OFF] button.

It is possible to finish above setting on the way, and unfinished change of setting is unavailable.
 "○": Initial settings
 "※": Automatic criterion

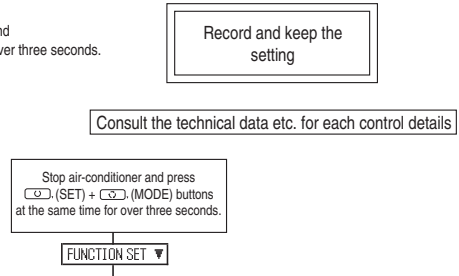

To next page

FUNCTION (Remote control function)

Function	setting	
01 ESP SET	ESP VALID	○ Validate setting of ESP: External Static Pressure
	ESP INVALID	○ Invalidate setting of ESP
02 AUTO RUN SET	AUTO RUN ON	※ Automatic operation is impossible
	AUTO RUN OFF	※ Automatic operation is impossible
03 TEMP SW	VALID	○ Temperature setting button is not working
	INVALID	○ Temperature setting button is not working
04 MODE SW	VALID	○ Mode button is not working
	INVALID	○ Mode button is not working
05 ON/OFF SW	VALID	○ On/Off button is not working
	INVALID	○ On/Off button is not working
06 FAN SPEED SW	VALID	※ Fan speed button is not working
	INVALID	※ Fan speed button is not working
07 LOUVER SW	VALID	※ Louver button is not working
	INVALID	※ Louver button is not working
08 TIMER SW	VALID	○ Timer button is not working
	INVALID	○ Timer button is not working
09 SENSOR SET	SENSOR OFF	○ Remote thermistor is not working.
	SENSOR ON	○ Remote thermistor is working.
	SENSOR +3.0℃	○ Remote thermistor is working, and to be set for producing +3.0℃ increase in temperature.
	SENSOR +2.0℃	○ Remote thermistor is working, and to be set for producing +2.0℃ increase in temperature.
	SENSOR +1.0℃	○ Remote thermistor is working, and to be set for producing +1.0℃ increase in temperature.
	SENSOR -1.0℃	○ Remote thermistor is working, and to be set for producing -1.0℃ increase in temperature.
	SENSOR -2.0℃	○ Remote thermistor is working, and to be set for producing -2.0℃ increase in temperature.
10 AUTO RESTART	INVALID	○
	VALID	○
11 VENT LINK SET	NO VENT	○ In case of Single split series, by connecting ventilation device to CNT of the indoor printed circuit board (in case of VRF series, by connecting it to CND of the indoor printed circuit board), the operation of ventilation device is linked with the operation of indoor unit.
	VENT LINK	○ In case of Single split series, by connecting ventilation device to CNT of the indoor printed circuit board (in case of VRF series, by connecting it to CND of the indoor printed circuit board), you can operate /stop the ventilation device independently by (VENT) button.
	NO VENT LINK	○ In case of Single split series, by connecting ventilation device to CNT of the indoor printed circuit board (in case of VRF series, by connecting it to CND of the indoor printed circuit board), you can operate /stop the ventilation device independently by (VENT) button.
12 TEMP RANGE SET	INDN CHANGE	○ If you change the range of set temperature, the indication of set temperature will vary following the control.
	NO INDN CHANGE	○ If you change the range of set temperature, the indication of set temperature will not vary following the control, and keep the set temperature.
13 I/U FAN	HI-MID-LO	※ Airflow of fan becomes of HI-MID-LO or the four speed of HI-MID-LO.
	HI-LO	※ Airflow of fan becomes of HI-LO.
	HI-MID	※ Airflow of fan becomes of HI-MID.
	1 FAN SPEED	※ Airflow of fan is fixed at one speed.
14 POSITION	POSITION STOP	○ If you change the remote control function "14 POSITION", you must change the indoor function "04 POSITION" accordingly. You can select the louver stop position in the four.
	FREE STOP	○ The louver can stop at any position.
15 MODEL TYPE	HEAT PUMP	※
	COOLING ONLY	※
16 EXTERNAL CONTROL SET	INDIVIDUAL	○ If you input signal into CNT of the indoor printed circuit board from external, the indoor unit will be operated independently according to the input from external.
	FOR ALL UNITS	○ If you input into CNT of the indoor printed circuit board from external, all units which connect to the same remote control are operated according to the input from external.
17 ROON TEMP INDICATION SET	INDICATION OFF	○ In normal working indication, indoor unit temperature is indicated instead of airflow.
	INDICATION ON	○ (Only the master remote control can be indicated.)
18 INDICATION	INDICATION ON	○ Heating preparation indication should not be indicated.
	INDICATION OFF	○ Heating preparation indication should not be indicated.
19 °C/°F SET	°C/°F	○ Temperature indication is by degree C
	°C/°F	○ Temperature indication is by degree F

To next page

[ON/OFF] button (finished)

Note 1: The initial setting marked "※" is decided by connected indoor and outdoor unit, and is automatically defined as following table.

Function No.	Item	Default	Model
Remote control function02	AUTO RUN SET	AUTO RUN ON	"Auto-RUN" mode selectable indoor unit.
		AUTO RUN OFF	Indoor unit without "Auto-RUN" mode
Remote control function06	FAN SPEED SW	VALID	Indoor unit with two or three step of air flow setting
		INVALID	Indoor unit with only one of air flow setting
Remote control function07	LOUVER SW	VALID	Indoor unit with automatically swing louver
		INVALID	Indoor unit without automatically swing louver
Remote control function13	I/U FAN	HI-MID-LO	Indoor unit with three step of air flow setting
		HI-LO	Indoor unit with two step of air flow setting
		HI-MID	
		1 FAN SPEED	Indoor unit with only one of air flow setting
Remote control function15	MODEL TYPE	HEAT PUMP	Heat pump unit
		COOLING ONLY	Exclusive cooling unit

Note 3: As for plural indoor unit, set indoor functions to each master and slave indoor unit.
But only master indoor unit is received the setting change of indoor unit function "05 EXTERNAL INPUT" and "06 PERMISSION / PROHIBITION".

From previous page

(Indoor unit function) I/U FUNCTION ▲ Indoor unit No. are indicated only when plural indoor units are connected.

- I/U000 ▲
- I/U001 ▼
- I/U002 ▼
- I/U003 ▼
- I/U004 ▼

To set other indoor unit, press [AIRCON NO.] button, which allows you to go back to the indoor unit selection screen (for example: I/U 000 ▲).

Function	setting
02 FAN SPEED SET	STANDARD ※ HIGH SPEED 1 ※ HIGH SPEED 2
03 FILTER SIGN SET	INDICATION OFF TYPE 1 ○ TYPE 2 TYPE 3 TYPE 4
04 POSITION	4 POSITION STOP ○ FREE STOP
05 EXTERNAL INPUT	LEVEL INPUT ○ PULSE INPUT
06 OPERATION PERMISSION/PROHIBITION	INVALID ○ VALID
07 EMERGENCY STOP	INVALID ○ VALID
08 ※ SP OFFSET	OFFSET +3.0℃ OFFSET +2.0℃ OFFSET +1.0℃ NO OFFSET ○
09 RETURN AIR TEMP	OFFSET +2.0℃ OFFSET +1.5℃ OFFSET +1.0℃ NO OFFSET ○ OFFSET -1.0℃ OFFSET -1.5℃ OFFSET -2.0℃
10 ※ FAN CONTROL	LOW FAN SPEED ○ SET FAN SPEED INTERMITTENCE FAN OFF
11 FROST PREVENTION TEMP	TEMP HIGH TEMP LOW ○
12 FROST PREVENTION CONTROL	FAN CONTROL ON ○ FAN CONTROL OFF
13 DRAIN PUMP LINK	○ AND ○ ○ AND ○ AND ○ ○ AND ○ AND ○
14 ※ FAN REMAINING	NO REMAINING ○ 0.5 HOUR 1 HOUR 6 HOUR
15 ※ FAN REMAINING	NO REMAINING ○ 0.5 HOUR 2 HOUR 6 HOUR
16 ※ FAN INTERMITTENCE	NO REMAINING ○ 20min OFF 5min ON 5min OFF 5min ON
17 PRESSURE CONTROL	STANDARD ※ TYPE1 ※

Fan tap		Indoor unit air flow setting			
FAN SPEED SET	STANDARD	UH - Hi - Me - Lo	Hi - Me - Lo	Hi - Lo	Hi - Me
	HIGH SPEED1, 2	UH - UH - Hi - Me	UH - Hi - Me	UH - Me	UH - Hi

Initial function setting of some indoor unit is "HIGH SPEED".
4 speed is not able to be set with wireless remote control.

The filter sign is indicated after running for 180 hours.
The filter sign is indicated after running for 600 hours.
The filter sign is indicated after running for 1000 hours.
The filter sign is indicated after running for 1000 hours, then the indoor unit will be stopped by compulsion after 24 hours.
If you change the indoor function "04 POSITION", you must change the remote control function "14 POSITION" accordingly.
You can select the lower stop position in the four.
The louver can stop at any position.

Permission/prohibition control of operation will be valid.

With the VRF series, it is used to stop all indoor units connected with the same outdoor unit immediately.
When stop signal is inputted from remote on-off terminal "CNT-6", all indoor units are stopped immediately.

To be reset for producing +3.0℃ increase in temperature during heating.
To be reset for producing +2.0℃ increase in temperature during heating.
To be reset for producing +1.0℃ increase in temperature during heating.

To be reset producing +2.0℃ increase in return air temperature of indoor unit.
To be reset producing +1.5℃ increase in return air temperature of indoor unit.
To be reset producing +1.0℃ increase in return air temperature of indoor unit.

To be reset producing -1.0℃ increase in return air temperature of indoor unit.
To be reset producing -1.5℃ increase in return air temperature of indoor unit.
To be reset producing -2.0℃ increase in return air temperature of indoor unit.

When heating thermostat is OFF, fan speed is low speed.
When heating thermostat is OFF, fan speed is set speed.
When heating thermostat is OFF, fan speed is operated intermittently.
When heating thermostat is OFF, the fan is stopped.
When the remote thermostat is working, "FAN OFF" is set automatically.
Do not set "FAN OFF" when the indoor unit's thermostat is working.

Change of indoor heat exchanger temperature to start frost prevention control.

Working only with the Single split series.
To control frost prevention, the indoor fan tap is raised.

Drain pump is run during cooling and dry.
Drain pump is run during cooling, dry and heating.
Drain pump is run during cooling, dry, heating and fan.
Drain pump is run during cooling, dry and fan.

After cooling is stopped, the fan does not perform extra operation.
After cooling is stopped, the fan perform extra operation for half an hour.
After cooling is stopped, the fan perform extra operation for an hour.
After cooling is stopped, the fan perform extra operation for six hours.

After heating is stopped or heating thermostat is OFF, the fan does not perform extra operation.
After heating is stopped or heating thermostat is OFF, the fan perform extra operation for half an hour.
After heating is stopped or heating thermostat is OFF, the fan perform extra operation for two hours.
After heating is stopped or heating thermostat is OFF, the fan perform extra operation for six hours.

During heating is stopped or heating thermostat is OFF, the fan perform intermittent operation for five minutes with low fan speed after twenty minutes' OFF.
During heating is stopped or heating thermostat is OFF, the fan perform intermittent operation for five minutes with low fan speed after five minutes' OFF.

Connected "OA Processing" type indoor unit, and is automatically defined.

From previous page

How to set function

1. Stop air-conditioner and press (SET) (MODE) buttons at the same time for over three seconds, and the "FUNCTION SET ▼" will be displayed.



2. Press (SET) button.
3. Make sure which do you want to set, "FUNCTION ▼" (remote control function) or "I/U FUNCTION ▲" (indoor unit function).
4. Press (▲) or (▼) button.
Select "FUNCTION ▼" (remote control function) or "I/U FUNCTION ▲" (indoor unit function).

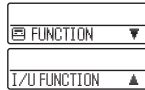

5. Press (SET) button.

6. [On the occasion of remote control function selection]

- ① "DATA LOADING" (Indication with blinking)
↓
Display is changed to "01 ESP SET".
- ② Press (▲) or (▼) button.
"No. and function" are indicated by turns on the remote control function table, then you can select from them.
(For example)

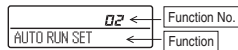

- ③ Press (SET) button.
The current setting of selected function is indicated.
(for example) "AUTO RUN ON" ← If "02 AUTO RUN SET" is selected

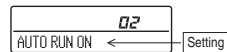

- ④ Press (▲) or (▼) button.
Select the setting.

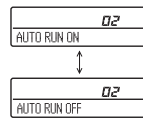

- ⑤ Press (SET) button.
"SET COMPLETE" will be indicated, and the setting will be completed.
Then after "No. and function" indication returns, set as the same procedure if you want to set continuously, and if to finish, go to 7.



7. Press (ON/OFF) button.
Setting is finished.

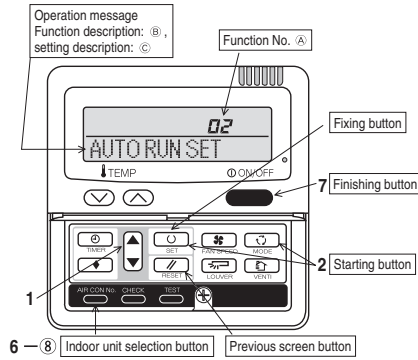

[On the occasion of indoor unit function selection]

- ① "DATA LOADING" (Blinking for 2 to 23 seconds to read the data)
↓
Indication is changed to "02 FAN SPEED SET".
Go to ②.

[Note]

- (1) If plural indoor units are connected to a remote control, the indication is "I/U 000" (blinking) ← The lowest number of the indoor unit connected is indicated.

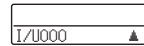

- (2) Press (▲) or (▼) button.
Select the number of the indoor unit you are to set
If you select "ALL UNIT ▼", you can set the same setting with all units.

- (3) Press (SET) button.

- ② Press (▲) or (▼) button.
"No. and function" are indicated by turns on the indoor unit function table, then you can select from them.
(For example)

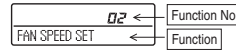

- ③ Press (SET) button.
The current setting of selected function is indicated.
(For example) "STANDARD" ← If "02 FAN SPEED SET" is selected.

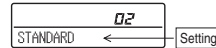

- ④ Press (▲) or (▼) button.
Select the setting.

- ⑤ Press (SET) button.
"SET COMPLETE" will be indicated, and the setting will be completed.
Then after "No. and function" indication returns, set as the same procedure if you want to set continuously, and if to finish, go to 7.



※ When plural indoor units are connected to a remote control, press the (AIRCON No.) button, which allows you to go back to the indoor unit selection screen. (example "I/U 000 ▲")

- It is possible to finish by pressing (ON/OFF) button on the way, but unfinished change of setting is unavailable.
- During setting, if you press (RESET) button, you return to the previous screen.
- Setting is memorized in the control and it is saved independently of power failure.

[How to check the current setting]

When you select from "No. and function" and press set button by the previous operation, the "Setting" displayed first is the current setting.
(But, if you select "ALL UNIT ▼", the setting of the lowest number indoor unit is displayed.)

10.4 Installation of outdoor unit

- This installation manual deals with outdoor units and general installation specifications only. For indoor units, refer to page 46.
- While install the unit, be sure to check the selection of installation place, power source specifications, usage limitation (piping length, height differences between indoor and outdoor units, power source voltage etc.) and installation spaces.

SAFETY PRECAUTIONS

- Before installation, read the "SAFETY PRECAUTIONS" carefully and strictly follow it during the installation work in order to protect yourself.
- The precautionary items mentioned below are distinguished into two levels, **⚠ WARNING** and **⚠ CAUTION**.
 - ⚠ WARNING** : Wrong installation would cause serious consequences such as injuries or death.
 - ⚠ CAUTION** : Wrong installation might cause serious consequences depending on circumstances.
- Both mention the important items to protect your health and safety so strictly follow them by any means.
- Be sure to confirm no anomaly on the equipment by commissioning after completing installation and explain the operating methods as well as the maintenance methods of this equipment to the user according to the owner's manual.
- Keep the installation manual together with owner's manual at a place where any user can read at any time. Moreover if necessary, ask to hand them to a new user.
- Before starting the installation work, proper precautions (using suitable protective clothing, groves etc.) should be taken by qualified installer.
- Pay attention not to fall down the tools, etc. when installing the unit at the high position.
- If unusual noise can be heard during operation, consult the dealer.
- The meanings of "Marks" used here are shown as follows:



⚠ WARNING

	<ul style="list-style-type: none"> • Installation must be carried out by the qualified installer. If you install the system by yourself, it may cause serious trouble such as water leaks, electric shocks, fire and personal injury, as a result of a system malfunction. Do not carry out the installation and maintenance work except the by qualified installer. • Install the system in full accordance with the installation manual. Incorrect installation may cause bursts, personal injury, water leaks, electric shocks and fire. • When installing in small rooms, take prevention measures not to exceed the density limit of refrigerant in the event of leakage, referred by the formula (accordance with ISO5149). If the density of refrigerant exceeds the limit, consult the dealer and install the ventilation system, otherwise lack of oxygen can occur, which can cause serious accident. • Use the original accessories and the specified components for installation. If parts other than those prescribed by us are used, it may cause water leaks, electric shocks, fire and personal injury. • Install the unit in a location with good support. Unsuitable installation locations can cause the unit to fall resulting in material damage and personal injury. • Ensure the unit is stable when installed, so that it can withstand earthquakes and strong winds. Unsuitable installation locations can cause the unit to fall and cause material damage and personal injury. • Ventilate the working area well in the event of refrigerant leakage during installation. If the refrigerant comes into contact with naked flames, poisonous gas is produced. • Use the prescribed pipes, flare nuts and tools for R410A. Using existing parts (for R22 or R407C) can cause the unit failure and serious accidents due to burst of the refrigerant circuit. • Do not open the operation valves for liquid line and gas line until completed refrigerant piping work, air tightness test and evacuation. If the compressor is operated in state of opening service valves before completing 	<ul style="list-style-type: none"> • connection of refrigerant piping work, air can be sucked into refrigerant circuit, which can cause burst or personal injury due to anomalously high pressure in the refrigerant. • The electrical installation must be carried out by the qualified electrician in accordance with "the norm for electrical work" and "national wiring regulation", and the system must be connected to the dedicated circuit. Power source with insufficient capacity and incorrect function done by improper work can cause electric shocks and fire. • Be sure to shut off the power before starting electrical work. Failure to shut off the power can cause electric shocks, unit failure or incorrect function of equipment. • Be sure to use the cables conformed to safety standard and cable ampacity for power distribution work. Unconformable cables can cause electric leak, anomalous heat production or fire. • This appliance must be connected to main power source by means of a circuit breaker or switch (fuse:30A) with a contact separation of at least 3mm. • Arrange the wiring in the control box so that it cannot be pushed up further into the box. Install the service panel correctly. Incorrect installation may result in overheating and fire. • Use the prescribed cables for electrical connection, tighten the cables securely in terminal block and relieve the cables correctly to prevent overloading the terminal blocks. Loose connections or cable mountings can cause anomalous heat production or fire. • Be sure to fix up the service panels. Incorrect fixing can cause electric shocks or fire due to intrusion of dust or water. • Be sure to switch off the power source in the event of installation, inspection or servicing. If the power source is not shut off, there is a risk of electric shocks, unit failure or personal injury due to the unexpected start of fan. • Stop the compressor before removing the pipe after shutting the service valve on pump down work. 	<ul style="list-style-type: none"> • If the pipe is removed when the compressor is in operation with the service valve open, air would be mixed in the refrigeration circuit and it could cause explosion and injuries due to abnormal high pressure in the cooling cycle. • Only use prescribed option parts. The installation must be carried out by the qualified installer. If you install the system by yourself, it can cause serious trouble such as water leaks, electric shocks, fire. • Be sure to wear protective goggles and gloves while at work. • Earth leakage breaker must be installed. If the earth leakage breaker is not installed, it can cause electric shocks. • Do not perform any change of protective device itself or its setup condition. The forced operation by short-circuiting protective device of pressure switch and temperature controller or the use of non specified component can cause fire or burst. • After completed installation, check that no refrigerant leaks from the system. If refrigerant leaks into the room and comes into contact with an oven or other hot surface, poisonous gas is produced. • Hang up the unit at the specified points with ropes which can support the weight in lifting for portage. And to avoid jolting out of alignment, be sure to hang up the unit at 4-point support. An improper manner of portage such as 3-point support can cause death or serious personal injury due to falling of the unit. • Do not perform brazing work in the airtight room It can cause lack of oxygen. • Tighten the flare nut by using double spanners and torque wrench according to prescribed method. Be sure not to tighten the flare nut too much. Loose flare connection or damage on the flare part by tightening with excess torque can cause burst or refrigerant leaks which may result in lack of oxygen. • Consult the dealer or an expert regarding removal of the unit. Incorrect installation can cause water leaks, electric shocks or fire.
	<ul style="list-style-type: none"> • Ensure that no air enters in the refrigerant circuit when the unit is installed and removed. If air enters in the refrigerant circuit, the pressure in the refrigerant circuit becomes too high, which can cause burst and personal injury. • Do not process or splice the power cord, or share the socket with other power plugs. This may cause fire or electric shock due to defecting contact, defecting insulation and over-current etc. 	<ul style="list-style-type: none"> • Do not bundle or wind or process the power cord. Do not deform the power cord by treading it. This may cause fire or heating. • Do not run the unit with removed panels or protections. Touching rotating equipments, hot surfaces or high voltage parts can cause personal injury due to entrapment, burn or electric shocks. 	<ul style="list-style-type: none"> • Do not perform any repairs or modifications by yourself. Consult the dealer if the unit requires repair. If you repair or modify the unit, it can cause water leaks, electric shocks or fire.

⚠ CAUTION

⚡	<ul style="list-style-type: none"> • Carry out the electrical work for ground lead with care. Do not connect the ground lead to the gas line, water line, lightning conductor or telephone line's ground lead. Incorrect grounding can cause unit faults such as electric shocks due to short-circuiting. Never connect the grounding wire to a gas pipe because if gas leaks, it could cause explosion or ignition. 		
!	<ul style="list-style-type: none"> • Use the circuit breaker for all pole correct capacity. Circuit breaker should be able to disconnect all poles under over current. Using the incorrect circuit breaker, it can cause the unit malfunction and fire. • Install isolator or disconnect switch on the power source wiring in accordance with the local codes and regulations. The isolator should be locked in OFF state in accordance with EN60204-1. • After maintenance, all wiring, wiring ties and the like, should be returned to their original state and wiring route, and the necessary clearance from all metal parts should be secured. • Secure a space for installation, inspection and maintenance specified in the manual. Insufficient space can result in accident such as personal injury due to falling from the installation place. 	<ul style="list-style-type: none"> • Take care when carrying the unit by hand. If the unit weights more than 20kg, it must be carried by two or more persons. Do not carry by the plastic straps, always use the carry handle when carrying the unit by hand. Use gloves to minimize the risk of cuts by the aluminum fins. • Dispose of any packing materials correctly. Any remaining packing materials can cause personal injury as it contains nails and wood. And to avoid danger of suffocation, be sure to keep the plastic wrapper away from children and to dispose after tear it up. • Be sure to insulate the refrigerant pipes so as not to condense the ambient air moisture on them. Insufficient insulation can cause condensation, which can lead to moisture damage on the ceiling, floor, furniture and any other valuables. 	<ul style="list-style-type: none"> • Pay attention not to damage the drain pan by weld spatter when welding work is done near the indoor unit. If weld spatter entered into the indoor unit during welding work, it can cause pin-hole in drain pan and result in water leakage. To prevent such damage, keep the indoor unit in its packing or cover it. • Be sure to perform air tightness test by pressurizing with nitrogen gas after completed refrigerant piping work. If the density of refrigerant exceeds the limit in the event of refrigerant leakage in the small room, lack of oxygen can occur, which can cause serious accidents. • Perform installation work properly according to this installation manual. Improper installation can cause abnormal vibrations or increased noise generation.
⊘	<ul style="list-style-type: none"> • Do not install the unit in the locations listed below. <ul style="list-style-type: none"> • Locations where carbon fiber, metal powder or any powder is floating. • Locations where any substances that can affect the unit such as sulphide gas, chloride gas, acid and alkaline can occur. • Vehicles and ships. • Locations where cosmetic or special sprays are often used. • Locations with direct exposure of oil mist and steam such as kitchen and machine plant. • Locations where any machines which generate high frequency harmonics are used. • Locations with salty atmospheres such as coastlines. • Locations with heavy snow (If installed, be sure to provide base flame and snow hood mentioned in the manual). • Locations where the unit is exposed to chimney smoke. • Locations at high altitude (more than 1000m high). • Locations with ammoniac atmospheres (e.g. organic fertilizer). • Locations with calcium chloride (e.g. snow melting agent). • Locations where heat radiation from other heat source can affect the unit. • Locations without good air circulation. • Locations with any obstacles which can prevent inlet and outlet air of the unit. • Locations where short circuit of air can occur (in case of multiple units installation). • Locations where strong air blows against the air outlet of outdoor unit. • Locations where something located above the unit could fall. • It can cause remarkable decrease in performance, corrosion and damage of components, malfunction and fire. • Do not install the outdoor unit in the locations listed below. <ul style="list-style-type: none"> • Locations where discharged hot air or operating sound of the outdoor unit can bother neighborhood. • Locations where outlet air of the outdoor unit blows directly to an animal or plants. 	<ul style="list-style-type: none"> • The outlet air can affect adversely to the plant etc. • Locations where vibration can be amplified and transmitted due to insufficient strength of structure. • Locations where vibration and operation sound generated by the outdoor unit can affect seriously (on the wall or at the place near bed room). • Locations where an equipment affected by high harmonics is placed (TV set or radio receiver is placed within 5m). • Locations where drainage cannot run off safely. It can affect surrounding environment and cause a claim. • Do not install the unit near the location where leakage of combustible gases can occur. If leaked gases accumulate around the unit, it can cause fire. • Do not install the unit where corrosive gas (such as sulfuric acid gas etc.) or combustible gas (such as thinner and petroleum gases) can accumulate or collect, or where volatile combustible substances are handled. Corrosive gas can cause corrosion of heat exchanger, breakage of plastic parts and etc. And combustible gas can cause fire. • Do not install nor use the system close to the equipment that generates electromagnetic fields or high frequency harmonics. Equipment such as inverters, standby generators, medical high frequency equipments and telecommunication equipments can affect the system, and cause malfunctions and breakdowns. The system can also affect medical equipment and telecommunication equipment, and obstruct its function or cause jamming. • Do not install the outdoor unit in a location where insects and small animals can inhabit. Insects and small animals can enter the electric parts and cause damage or fire. Instruct the user to keep the surroundings clean. • Do not use the base flame for outdoor unit which is corroded or damaged 	<ul style="list-style-type: none"> • due to long periods of operation. Using an old and damage base flame can cause the unit falling down and cause personal injury. • Do not use any materials other than a fuse with the correct rating in the location where fuses are to be used. Connecting the circuit with copper wire or other metal thread can cause unit failure and fire. • Do not touch any buttons with wet hands. It can cause electric shocks. • Do not touch any refrigerant pipes with your hands when the system is in operation. During operation the refrigerant pipes become extremely hot or extremely cold depending the operating condition, and it can cause burn injury or frost injury. • Do not touch the suction or aluminum fin on the outdoor unit. This may cause injury. • Do not put anything on the outdoor unit and operating unit. This may cause damage the objects or injury due to falling to the object. • Do not use the unit for special purposes such as storing foods, cooling precision instruments and preservation of animals, plants or art. • Do not clean up the unit with water. • When the outdoor unit is installed on a roof or a high place, provide permanent ladders and handrails along the access route and fences and handrails around the outdoor unit. If safety facilities are not provided, it can cause personal injury due to falling from the installation place. • Do not step onto the outdoor unit. You may incur injury from a drop or fall.

Check before installation work

- Model name and power source
- Refrigerant piping length
- Piping, wiring and miscellaneous small parts
- Indoor unit installation manual

Accessories for outdoor unit	Q'ty
① Edging	1

Locally procured parts	Q'ty
Ⓐ Sealing plate	1
Ⓛ Sleeve	1
Ⓒ Inclination plate	1
Ⓓ Putty	1
Ⓧ Drain hose (extension hose)	1
Ⓣ Piping cover(for insulation of connection piping)	1
Ⓢ Drain elbow	1
Ⓜ Grommet	2

Necessary tools for the installation work	
9 Wrench key (Hexagon) [4m/m]	
10 Vacuum pump	
11 Vacuum pump adapter (Anti-reverse flow type) (Designed specifically for R410A)	
12 Gauge manifold (Designed specifically for R410A)	
13 Charge hose (Designed specifically for R410A)	
14 Flaring tool set (Designed specifically for R410A)	
15 Gas leak detector (Designed specifically for R410A)	
16 Gauge for projection adjustment (Used when flare is made by using conventional flare tool)	
1 Plus headed driver	
2 Knife	
3 Saw	
4 Tape measure	
5 Hammer	
6 Spanner wrench	
7 Torque wrench [14.0—82.0N·m (1.4—8.2kgf·m)]	
8 Hole core drill (65mm in diameter)	

Note as a unit designed for R410A

- Do not use any refrigerant other than R410A. R410A will rise to pressure about 1.6 times higher than that of a conventional refrigerant. A cylinder containing R410A has a pink indication mark on the top.
- A unit designed for R410A has adopted a different size indoor unit service valve charge port and a different size check joint provided in the unit to prevent the charging of a wrong refrigerant by mistake. The processed dimension of the flared part of a refrigerant pipe and a flare nut's parallel side measurement have also been altered to raise strength against pressure. Accordingly, you are required to arrange dedicated R410A tools listed in the table on the left before installing or servicing this unit.
- Do not use a charge cylinder. The use of a charge cylinder will cause the refrigerant composition to change, which results in performance degradation.
- In charging refrigerant, always take it out from a cylinder in the liquid phase.
- All indoor units must be models designed exclusively for R410A. Check connectable indoor unit models in a catalog, etc. (A wrong indoor unit, if connected into the system, will impair proper system operation)

Head the following the heating operation

- In the case when this unit has stopped for a long time, heating operation may start and operate in cooling mode by 7 minutes, after that, heating operation is started. This operation keep oil quality in compressor by preventing liquid refrigerant come into compressor. If that is the case, do not suspect a unit failure. (In this case, remote control displays 'DEFROST' or 'In operation for defrosting'.)

1. HAULAGE AND INSTALLATION (Take particular care in carrying in or moving the unit, and always perform such an operation with two or more persons.)

CAUTION When a unit is hoisted with slings for haulage, take into consideration the offset of its gravity center position. If not properly balanced, the unit can be thrown off-balance and fall.

1) Delivery

- Deliver the unit as close as possible to the installation site before removing it from the packaging.
- When you have to unpack the unit for a compelling reason before you haul it to the installation point, hoist the unit with nylon slings or ropes and protection pads so that you may not damage the unit.

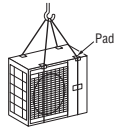

2) Portage

- The right hand side of the unit as viewed from the front (Fan side) is heavier. A person carrying the right hand side must take heed of this fact. A person carrying the left hand side must hold with his right hand the handle provided on the front panel of the unit and with his left hand the corner column section.

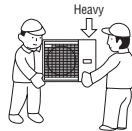

3) Selecting the installation location

Be sure to select a suitable installation place in consideration of following conditions.

- A place where it is horizontal, stable and can endure the unit weight and will not allow vibration transmittance of the unit.
- A place where it can be free from possibility of bothering neighbors due to noise or exhaust air from the unit.
- A place where the unit is not exposed to oil splashes.
- A place where it can be free from danger of flammable gas leakage.
- A place where drain water can be disposed without any trouble.
- A place where the unit will not be affected by heat radiation from other heat source.
- A place where snow will not accumulate.
- A place where the unit can be kept away 5m or more from TV set and/or radio receiver in order to avoid any TV set or radio receiver interference.
- A place where good air circulation can be secured, and enough service space can be secured for maintenance and service of the unit safely.
- A place where the unit will not be affected by electromagnetic waves and/or high-harmonic waves generated by other equipment.
- A place where chemical substances like sulfuric gas, chloric gas, acid and alkali (including ammonia), which can harm the unit, will not be generated and not remain.
- If a operation is conducted when the outdoor air temperature is -5 or lower, the outdoor unit should be installed at a place where it is not influenced by natural wind.
- A place where strong wind will not blow against the outlet air blow of the unit.
- A place where stringent regulation of electric noises is not applicable.

Do not install the unit in places which exposed to sea breeze (e.g. coastal area) or calcium chloride (e.g. snow melting agent), exposed to ammonia substance (e.g. organic fertilizer).

4) Caution about selection of installation location

- (1) If the unit is installed in the area where the snow will accumulate, following measures are required. The bottom plate of unit and intake, outlet may be blocked by snow.

1. Install the unit on the base so that the bottom is higher than snow cover surface.

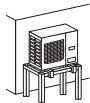

2. Provide a snow hood to the outdoor unit on site. Regarding outline of a snow hood, refer to our technical manual.



3. Install the unit under eaves or provide the roof on site.

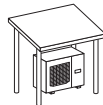

Since drain water generated by defrost control may freeze, following measures are required.

- Don't execute drain piping work by using a drain elbow and drain grommets (optional parts). [Refer to Drain piping work.]

- Attach heater on a base plate on site, if there is possibility to freeze drain water. In case that the product has a corrective drainage system, the drainage paths should have suitable measure against freezing but be sure not to melt the material of drainage paths with heat.

- (2) If the unit can be affected by strong wind, following measures are required. Strong wind can cause damage of fan (fan motor), or can cause performance degradation, or can trigger anomalous stop of the unit due to rising of high pressure.

1. Install the outlet air blow side of the unit to face a wall of building, or provide a fence or a windbreak screen.
2. Install the outlet air blow side of the unit in a position perpendicular to the direction of wind.
3. The unit should be installed on the stable and level foundation. If the foundation is not level, tie down the unit with wires.

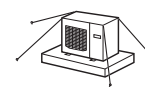
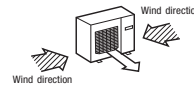
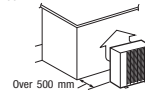

5) Installation space

- Walls surrounding the unit in the four sides are not acceptable.
- There must be a 1-meter or larger space in the above.
- When more than one unit are installed side by side, provide a 250mm or wider interval between them as a service space. In order to facilitate servicing of controllers, provide a sufficient space between units so that their top plates can be removed easily.
- Where a danger of short-circuiting exists, install guide louvers.
- When more than one unit are installed, provide sufficient intake space consciously so that short-circuiting may not occur.
- Where piling snow can bury the outdoor unit, provide proper snow guards.

Example installation Size	I	II	III
L1	Open	Open	500
L2	300	250	Open
L3	100	150	100
L4	250	250	250

The height of a wall is 1200mm or less.

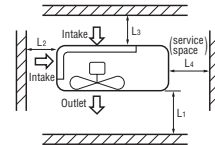

6) Installation

① Anchor bolt fixed position

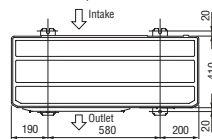

② Notes for installation

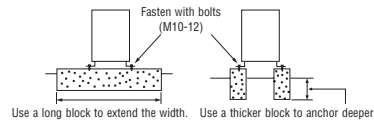

- In installing the unit, fix the unit's legs with bolts specified on the above.
- The protrusion of an anchor bolt on the front side must be kept within 15mm.
- Securely install the unit so that it does not fall over during earthquakes or strong winds, etc.
- Refer to the above illustrations for information regarding concrete foundations.
- Install the unit in a level area. (With a gradient of 5mm or less.) Improper installation can result in a compressor failure, broken piping within the unit and abnormal noise generation.

7) To run the unit for a cooling operation, when the outdoor temperature is -5°C or lower.

- When the outdoor air temperature is -5°C or lower, provide a snow hood to the outdoor unit on site. So that strong wind will not blow against the outdoor heat exchanger directly. Regarding outline of a snow hood, refer to our technical manual.

2. REFRIGERANT PIPING WORK

1) Restrictions on unit installation and use

- Check the following points in light of the indoor unit specifications and the installation site.
- Observe the following restrictions on unit installation and use. Improper installation can result in a compressor failure or performance degradation.

Restrictions		Dimensional restrictions	Marks appearing in the drawing on the right
Main pipe length		30m or less	L
Elevation difference between indoor and outdoor units	When the outdoor unit is positioned higher,	20m or less	H
	When the outdoor unit is positioned lower,	20m or less	H

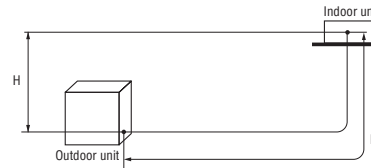

CAUTION

- The use restrictions appearing in the table above are applicable to the standard pipe size combinations shown in the table below. Where an existing pipe system is utilized, different one-way pipe length restrictions should apply depending on its pipe size. For more information, see "5. UTILIZATION OF EXISTING PIPING."

2) Determination of pipe size

Determine refrigerant pipe size according to the following guidelines based on the indoor unit specifications.

	Gas pipe	Liquid pipe
Outdoor unit connected	φ15.8 Flare	φ9.52 Flare
Refrigerant piping (branch pipe L)	φ15.8	φ9.52
Indoor unit connected	φ15.8	φ9.52

Pipe brazing

Brazing must be performed under a nitrogen gas flow.

Without nitrogen gas, a large quantity of foreign matters (oxidized film) are created, causing a critical failure from capillary tube or expansion valve clogging.

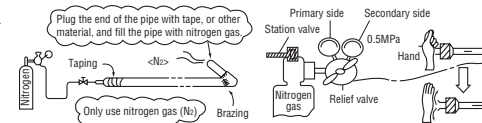

3) Refrigerant pipe wall thickness and material

- Select refrigerant pipes of the table shown on the right wall thickness and material as specified for each pipe size.

NOTE Select pipes having a wall thickness larger than the specified minimum pipe thickness.

Pipe diameter [mm]	φ9.52	φ15.88
Minimum pipe wall thickness [mm]	0.8	1.0
Pipe material*	O-type pipe	O-type pipe

*Phosphorus deoxidized seamless copper pipe ICS 23.040.15, ICS 77.150.30

4) On-site piping work

IMPORTANT

Take care so that installed pipes may not touch components within a unit. If pipes touch internal components, abnormal sounds and/or vibrations.

How to remove the side cover

First remove the five screws (x mark) of the service panel and push it down into the direction of the arrow mark and then remove it by pulling it toward you.

- The pipe can be laid in any of the following directions: side right, front, rear and downward.
- Remove a knock-out plate provided on the pipe penetration to open a minimum necessary area and attach an edging material supplied as an accessory by cutting it to an appropriate length before laying a pipe.
- Carry out the on site piping work with the service valve fully closed.
- Give sufficient protection to a pipe end (compressed and blazed, or with an adhesive tape) so that water or foreign matters may not enter the piping.
- Bend a pipe to a radius as large as practical (R100-R150). Do not bend a pipe repeatedly to correct its form.
- Flare connection is used between the unit and refrigerant pipe. Flare a pipe after engaging a flare nut onto it. Flare dimensions for R410A are different from those for conventional R407C. Although we recommend the use of flaring tools designed specifically for R410A, conventional flaring tools can also be used by adjusting the measurement of protrusion B with a protrusion control gauge.
- The pipe should be anchored every 1.5m or less to isolate the vibration.
- Tighten the flare joint securely with a double spanner.

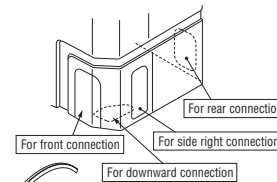
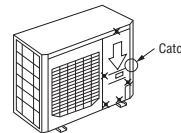

Flared pipe end : A (mm)	
Copper pipe outer diameter	A -0 -04
φ9.52	013.2
φ15.88	19.7

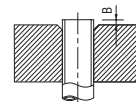

Copper pipe protrusion for flaring : B (mm)		
Copper pipe outer diameter	In the case of a rigid (clutch) type	
	With an R410A tool	With a conventional tool
φ9.52	0-0.5	1.0-1.5
φ15.88		

CAUTION

Do not apply force beyond proper fastening torque in tightening the flare nut.

Fix both liquid and gas service valves at the valve main bodies as illustrated on the right, and then fasten them, applying appropriate fastening torque.

Service valve size (mm)	Tightening torque (N·m)	Tightening angle (°)	Recommended length of a tool handle (mm)
φ9.52 (3/8")	34-42	30-45	200
φ15.88 (5/8")	68-82	15-20	300

Do not hold the valve cap area with a spanner.

Use a torque wrench. If a torque wrench is not available, fasten the flare nut manually first and then tighten it further, using the left table as a guide.

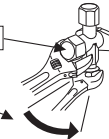

5) Air tightness test

- Although outdoor and indoor units themselves have been tested for air tightness at the factory, check the connecting pipes after the installation work for air tightness from the service valve's check joint equipped on the outdoor unit side. While conducting a test, keep the service valve shut all the time.
 - Raise the pressure to 0.5MPa, and then stop. Leave it for five minutes to see if the pressure drops.
 - Then raise the pressure to 1.5MPa, and stop. Leave it for five more minutes to see if the pressure drops.
 - Then raise the pressure to the specified level (4.15MPa), and record the ambient temperature and the pressure.
 - If no pressure drop is observed with an installation pressurized to the specified level and left for about one day, it is acceptable. When the ambient temperature fall 1C, the pressure also fall approximately 0.01MPa. The pressure, if changed, should be compensated for.
 - If a pressure drop is observed in checking e) and a) - d), a leak exists somewhere. Find a leak by applying bubble test liquid to welded parts and flare joints and repair it. After repair, conduct an air tightness test again.
- In conducting an air tightness test, use nitrogen gas and pressurize the system with nitrogen gas from the gas side. Do not use a medium other than nitrogen gas under any circumstances.

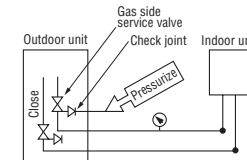

6) Evacuation

When the system has remaining moisture inside or a leaky point, the vacuum gauge indicator will rise. Check the system for a leaky point and then draw air to create a vacuum again.

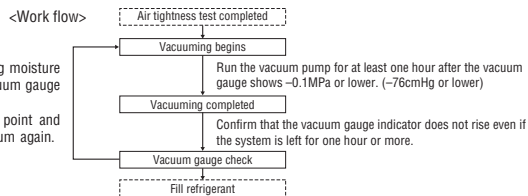

Pay attention to the following points in addition to the above for the R410A and compatible machines.

- To prevent a different oil from entering, use dedicated tools, etc. to each refrigerant type. Under no circumstances must a gauge manifold and a charge hose in particular be shared with other refrigerant types (R22, R407C, etc.).
- Use a counterflow prevention adapter to prevent vacuum pump oil from entering the refrigerant system.

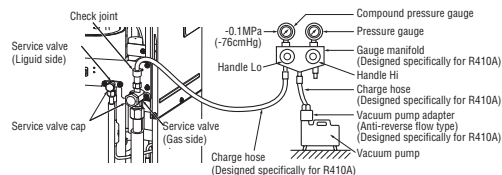

Securely tighten the service valve cap and the check joint blind nut after adjustment.

Service valve size (mm)	Service valve cap tightening torque (N·m)	Check joint blind nut tightening torque (N·m)
ø9.52 (3/8")	20 - 30	10 - 12
ø15.88 (5/8")	30 - 40	

7) Additional refrigerant charge

(1) Calculate a required refrigerant charge volume from the following table.

Additional charge volume (g) per meter of refrigerant piping (liquid pipe ø9.52)	Refrigerant volume charged for shipment at the factory (kg)	Installation's pipe length (m) covered without additional refrigerant charge
60	2.55	15

- This unit contains factory charged refrigerant covering 15m of refrigerant piping and additional refrigerant charge on the installation site is not required for an installation with up to 15m refrigerant piping. When refrigerant piping exceeds 15m, additionally charge an amount calculated from the pipe length and the above table for the portion in excess of 15m.
- If an existing pipe system is used, required refrigerant charge volume will vary depending on the liquid pipe size. For further information, see "5. UTILIZATION OF EXISTING PIPING."

Formula to calculate the volume of additional refrigerant required

$$\text{Additional charge volume (g)} = \{ \text{Main length (m)} - \text{Factory charged volume 15 (m)} \} \times 60 \text{ (g/m)}$$

- * When an additional charge volume calculation result is negative, it is not necessary to charge refrigerant additionally.
- For an installation measuring 15m or shorter in pipe length, charge the refrigerant volume charged for shipment at the factory, when you recharge refrigerant after servicing etc.

(2) Charging refrigerant

- Since R410A refrigerant must be charged in the liquid phase, you should charge it keeping the container cylinder upside down or using a refrigerant cylinder equipped with a siphon tube.
- Charge refrigerant always from the liquid side service port with the service valve shut. When you find it difficult to charge a required amount, fully open the outdoor unit valves on both liquid and gas sides and charge refrigerant from the gas (suction) side service port, while running the unit in the cooling mode. In doing so, care must be taken so that refrigerant may be discharged from the cylinder in the liquid phase all the time. When the cylinder valve is throttled down or a dedicated conversion tool to change liquid phase refrigerant into mist is used to protect the compressor, however, adjust charge conditions so that refrigerant will gasify upon entering the unit.
- In charging refrigerant, always charge a calculated volume by using a scale to measure the charge volume.
- When refrigerant is charged with the unit being run, complete a charge operation within 30minutes. Running the unit with an insufficient quantity of refrigerant for a long time can cause a compressor failure.

NOTE Put down the refrigerant volume calculated from the pipe length onto the caution label attached on the service panel.

8) Heating and condensation prevention

- Dress refrigerant pipes (both gas and liquid pipes) for heat insulation and prevention of dew condensation.
 - Improper heat insulation/anti-dew dressing can result in a water leak or dripping causing damage to household effects, etc.
- Use a heat insulating material that can withstand 120°C or a higher temperature. Poor heat insulating capacity can cause heat insulation problems or cable deterioration.
 - All gas pipes must be securely heat insulated in order to prevent damage from dripping water that comes from the condensation formed on them during a cooling operation or personal injury from burns because their surface can reach quite a high temperature due to discharged gas flowing inside during a heating operation.
 - Wrap indoor units' flare joints with heat insulating parts (pipe cover) for heat insulation (both gas and liquid pipes).
 - Give heat insulation to both gas and liquid side pipes. Bundle a heat insulating material and a pipe tightly together so that no gaps may be left between them and wrap them together with a connecting cable by a dressing tape.
 - Both gas and liquid pipes need to be dressed with 20mm or thicker heat insulation materials above the ceiling where relative humidity exceeds 70%.**

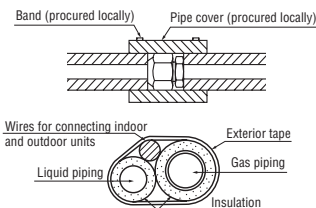

3. DRAIN PIPING WORK

- Execute drain piping by using a drain elbow and drain grommets supplied separately as accessories, where water drained from the outdoor unit is a problem.
- Water may drip where there is a larger amount of drain water. Seal around the drain elbow and drain grommets with putty or adequate caulking material.
- Condensed water may flow out from vicinity of service valve or connected pipes.
- Where you are likely to have several days of sub-zero temperatures in a row, do not use a drain elbow and drain grommets. (There is a risk of drain water freezing inside and blocking the drain.)
- Do not use drain elbow and grommet made of plastic for drain piping when base heater for outdoor unit is used. Plastic grommet and elbow will be damaged and burnt in worst case.
- Prepare another drain tray made of metallic material for collecting drain when base heater is used.

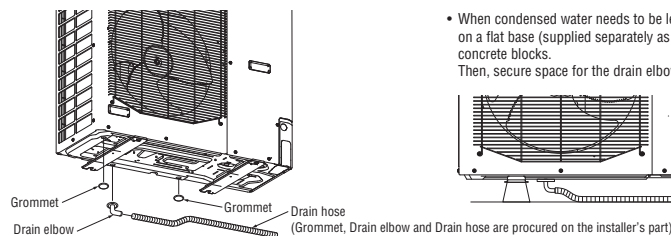

- When condensed water needs to be led to a drain, etc., install the unit on a flat base (supplied separately as a locally procured part) or concrete blocks. Then, secure space for the drain elbow and the drain hose.

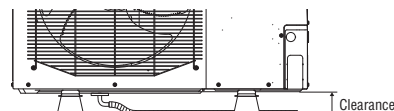

4. ELECTRICAL WIRING WORK For details of electrical cabling, refer to the indoor unit installation manual.

Electrical installation work must be performed by an electrical installation service provider qualified by a power provider of the country. Electrical installation work must be executed according to the technical standards and other regulations applicable to electrical installations in the country.

- Do not use any power cable lighter than one specified in parentheses for each type below.
 - braided cord (code designation 60245 IEC 51)
 - ordinary tough rubber sheathed cord (code designation 60245 IEC 53)
 - flat twin tinsel cord (code designation 60227 IEC 41)
- Use polychloroprene sheathed flexible cord (code designation 60245 IEC57) for power cables of parts of appliances for outdoor use.
- Ground the unit. Do not connect the grounding wire to a gas pipe, water pipe, lightning rod or telephone grounding wire.
 - If improperly grounded, an electric shock or malfunction may result.
 - A grounding wire must be connected before connecting the power cable. Provide a grounding wire longer than the power cable.
 - The installation of an impulse withstanding type earth leakage breaker is necessary. A failure to install an earth leakage breaker can result in an accident such as an electric shock or a fire.
 - Do not turn on the power until the electrical work is completed.
 - Do not use a condensive capacitor for power factor improvement under any circumstances. (It dose not improve power factor, while it can cause an abnormal overheat accident)
- For power cables, use conduits.
- Do not lay electronic control cables (remote control and signaling wires) and other cables together outside the unit. Laying them together can result in the malfunctioning or a failure of the unit due to electric noises.
- Fasten the cables so that those may not touch the piping, etc.
- When cables are connected, make sure that all electrical components within the electrical component box are free of loose connector coupling or terminal connection and then attach the cover securely. (Improper cover attachment can result in malfunctioning or a failure of the unit, if water penetrates into the box.)
- Never use a shield cable.
- Always use a three-core cable for an indoor-outdoor connecting cable. Never use a shield cable.
- Connect a pair bearing a common terminal number with an indoor-outdoor connecting wire.
- In cabling, fasten cables securely with cable clamps so that no external force may work on terminal connections.

In case of faulty wiring connection, indoor unit dose not operate. Then, run lamp turns on and timer lamp blinks.

Use cables for interconnection wiring to avoid loosening of the wires. CENELEC code for cables Required field cables.

H05RN4G1.5 (Example) or 245IEC57

H	Harmonized cable type
05	300/500 volts
R	Natural-and/or synth. rubber wire insulation
N	Polychloroprene rubber conductors insulation
R	Stranded core
4or5	Number of conductors
G	One conductor of the cable is the earth conductor (yellow/green)
1.5	Section of copper wire (mm ²)

Main fuse specification

Specification	Part No.
250V 20A	SSA564A136A

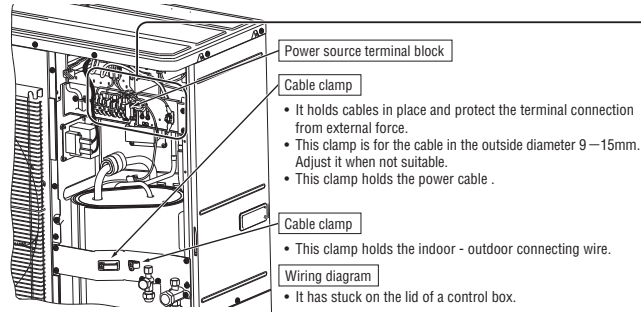

Power cable, indoor - outdoor connecting wire circuit diagram

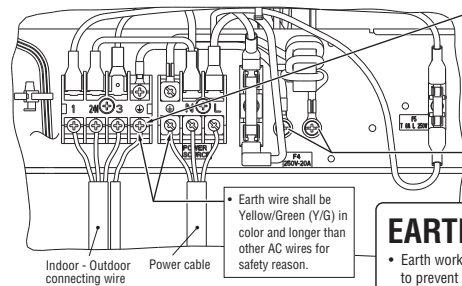

EARTHING WORK

- Earth work shall be carried out without fail in order to prevent electric shock and noise generation.
- The connection of the earth cable to the following substances causes dangerous failures, therefore it shall never be done. (City water pipe, Town gas pipe, TV antenna, lightning conductor, telephonenumber, etc.)

Power cable, indoor-outdoor connecting wires

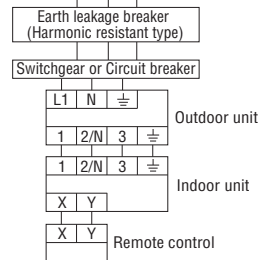

When change the Printed circuit board, take off the top panel.

How to remove the top panel

Remove the screws of the top panel.

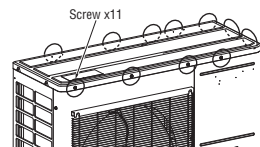

- Use Polychloroprene sheathed flexible cord (code designation 60245 IEC57, IEC60335-2-40) with cross-sectional area of 5.5 mm² for power cable of outdoor unit.

(POWER CABLE)
CENELEC code for cables requiring fields cables.
H05RN4G1.5

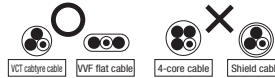

CAUTION

Always use an earth leakage circuit breaker designed for inverter circuits to prevent a faulty operation.

Power source	Power cable thickness (mm ²)	MAX. over current (A)	Cable length (m)	Grounding wire thickness	Indoor - outdoor wire thickness × number
Single phase 3 wire 220-240V 50Hz 220V 60Hz	5.5	21	25	φ 1.6	φ 1.6x3

※At the connection with the duct type indoor unit.

Power source	Power cable thickness (mm ²)	MAX. over current (A)	Cable length (m)	Grounding wire thickness	Indoor - outdoor wire thickness × number
Single phase 3 wire 220-240V 50Hz 220V 60Hz	5.5	22	24	φ 1.6	φ 1.6x3

- Always perform grounding system installation work with the power cable unplugged.
- Connect a pair bearing a common terminal number with an indoor-outdoor connecting wire.
- In cabling, fasten cables securely with cable clamps so that no external force may work on terminal connections.
- Grounding terminals are provided in the terminal block.

- The specifications shown in the above table are for units without heaters. For units with heaters, refer to the installation instructions or the construction instructions of the indoor unit.
- Switchgear or Circuit breaker capacity which is calculated from maximum over current should be chosen along the regulations in each country.
- The cable specifications are based on the assumption that a metal or plastic conduit is used with no more than three cables contained in a conduit and a voltage drop is 2%. For an installation falling outside of these conditions, follow the internal cabling regulations. Adapt it to the regulation in effect in each country.

5. UTILIZATION OF EXISTING PIPING

Check whether an existing pipe system is reusable or not by using the following flow chart.

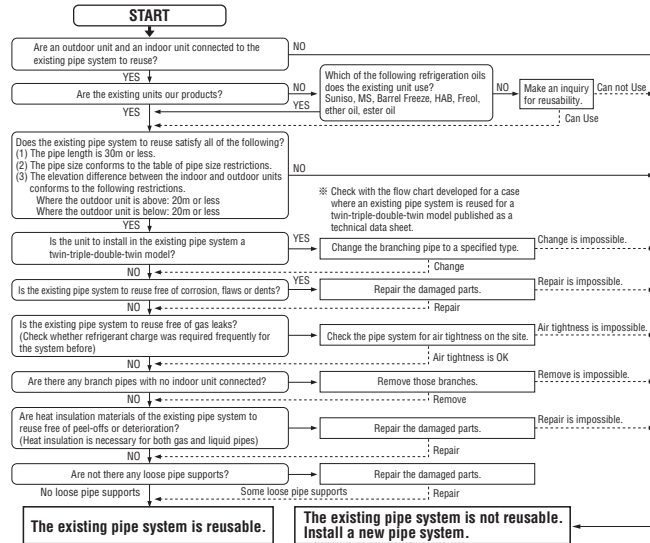

<Table of pipe size restrictions>

⊙: Standard pipe size ○: Usable △: Restricted to shorter pipe length limits

Additional charge volume per meter of pipe	60g/m	80g/m
Liquid pipe	φ9.52	φ12.7
Gas pipe	φ15.88	φ15.88
Usability	⊙	△
Maximum one-way pipe length	30	15
Length covered without additional charge	15	7

- **Consult with our distributor in the area, if you need to recover refrigerant and charge it again.**
- Any combinations of pipe sizes not listed in the table are not usable.

Formula to calculate additional charge volume

Additional charge volume (g) =
 (Main pipe length (m) - Length covered without additional charge shown in the table (m)) X Additional charge volume per meter of pipe shown in the table (g/m)

※ If you obtain a negative figure as a result of calculation, no additional refrigerant needs to be charged.
Example When an FDC100 is installed in a 10m long existing pipe system (liquid φ12.7, gas φ15.88), the quantity of refrigerant to charge additionally should be (10m-7m) x 80g/m = 240g.



WARNING

<Where the existing unit can be run for a cooling operation.>

Carry out the following steps with the excising unit (in the order of (1), (2), (3) and (4))

- (1) Run the unit for 30 minutes for a cooling operation.
- (2) Stop the indoor fan and run the unit for 3 minutes for a cooling operation (returning liquid)
- (3) Close the liquid side service valve of the outdoor unit and pump down (refrigerant recovery)
- (4) Blow with nitrogen gas. ※ If discolored refrigeration oil or any foreign matters is discharged by the blow, wash the pipe system or install a new pipe system.
 - For the flare nut, do not use the old one, but use the one supplied with the outdoor unit. Process a flare to the dimensions specified for R410A.

<Where the existing unit cannot be run for a cooling operation.>

Wash the pipe system or install a new pipe system.

- If you choose to wash the pipe system, contact our distributor in the area.

INSTALLATION TEST CHECK POINTS

Check the following points again after completion of the installation, and before turning on the power. Conduct a test run again and ensure that the unit operates properly. Explain to the customer how to use the unit and how to take care of the unit following the instruction manual.

After installation

- | | |
|--|--|
| <input type="checkbox"/> Power cables and connecting wires are securely fixed to the terminal block. | <input type="checkbox"/> No gas leaks from the joints of the service valve. |
| <input type="checkbox"/> The power source voltage is correct as the rating. | <input type="checkbox"/> The pipe joints for indoor and outdoor pipes have been insulated. |
| <input type="checkbox"/> The drain hose is fixed securely. | <input type="checkbox"/> The screw of the side cover is tightened securely. |
| <input type="checkbox"/> Service valve is fully open. | |

11. OUTLINE OF OPERATION CONTROL BY MICROCOMPUTER

11.1 Remote control

(1) Wired remote control Model RC-EX1A

All icons are shown for the sake of explanation.

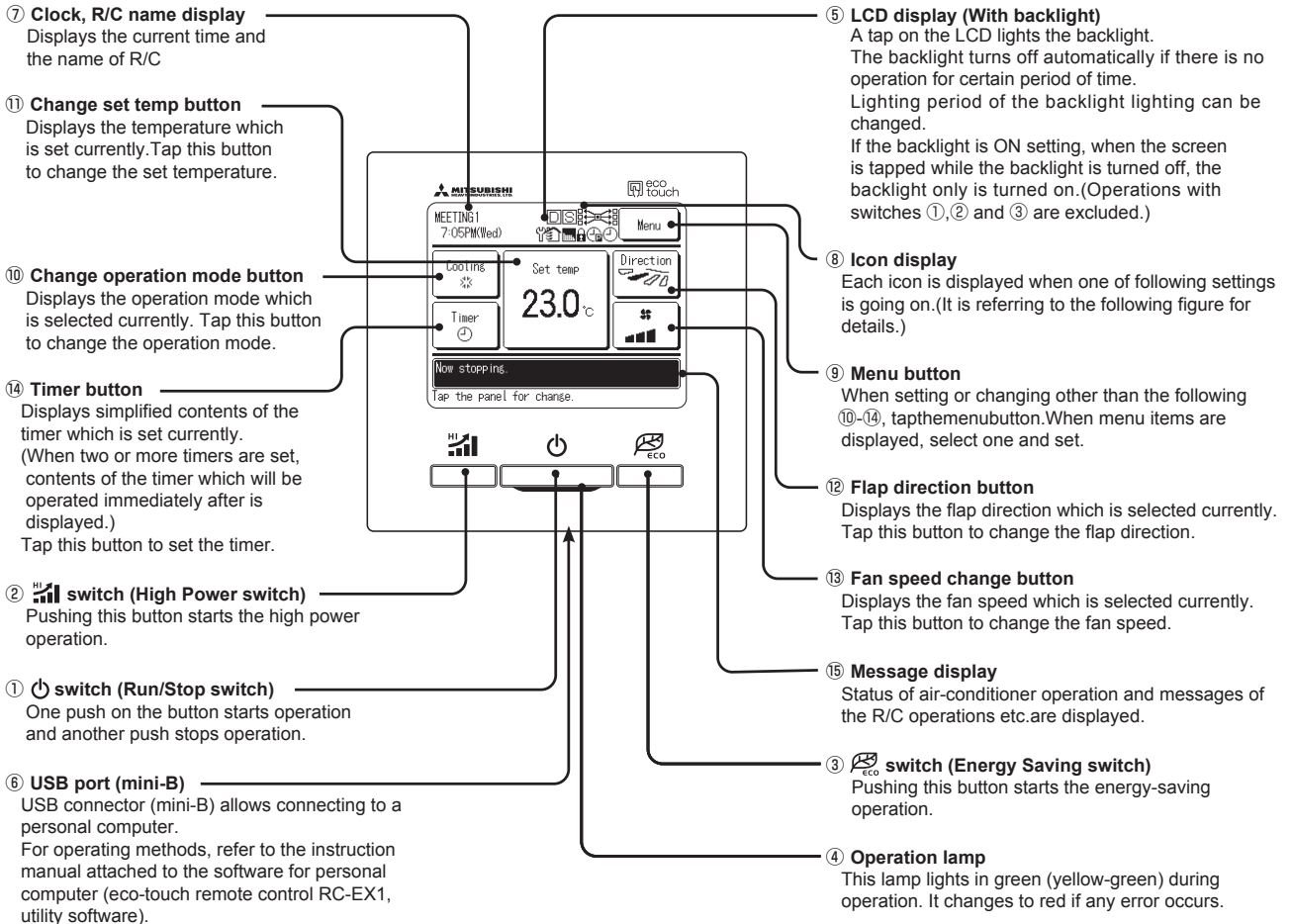

Touch panel system, which is operated by tapping the LCD screen with a finger, is employed for any operations other than the ① Run/Stop, ② High power and ③ Energy-saving switches.

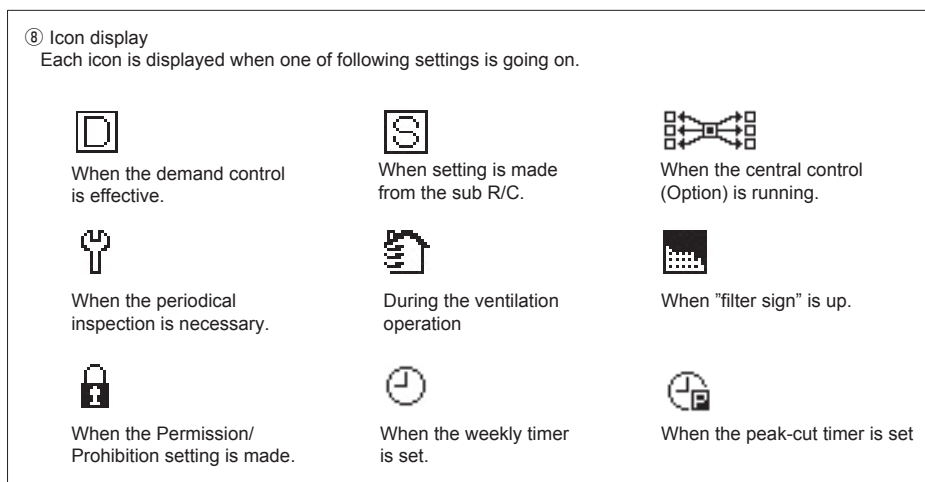

Model RC-E5

The figure below shows the remote control with the cover opened. Note that all the items that may be displayed in the liquid crystal display area are shown in the figure for the sake of explanation
 Characters displayed with dots in the liquid crystal display area are abbreviated.

The figure below shows the remote control with the cover opened.

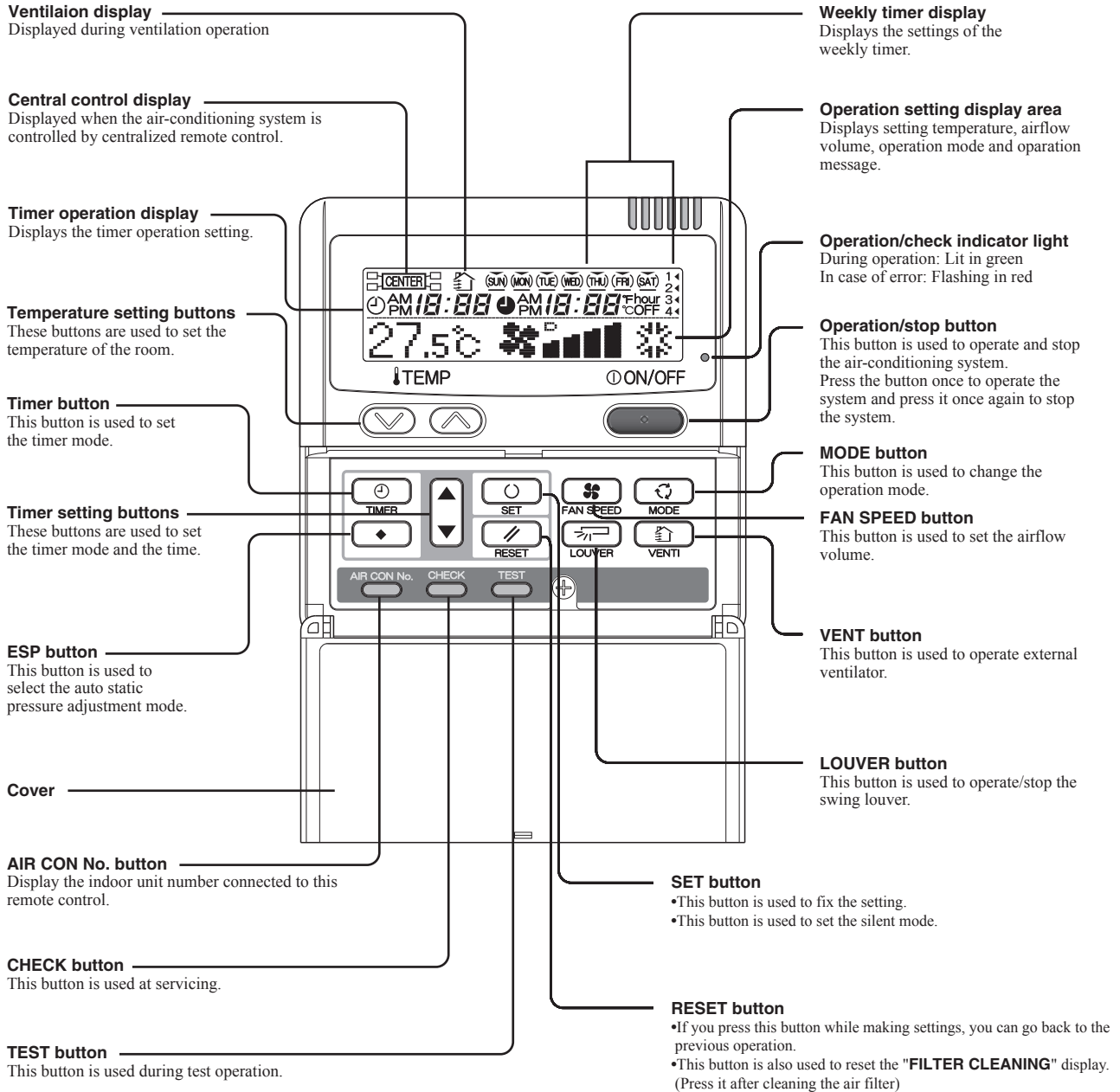

* All displays are described in the liquid crystal display for explanation.

(2) Wireless remote control (FDT, FDE, FDU, FDUM, FDF series)
(SRK series : Refer to the page 128)

Indication section

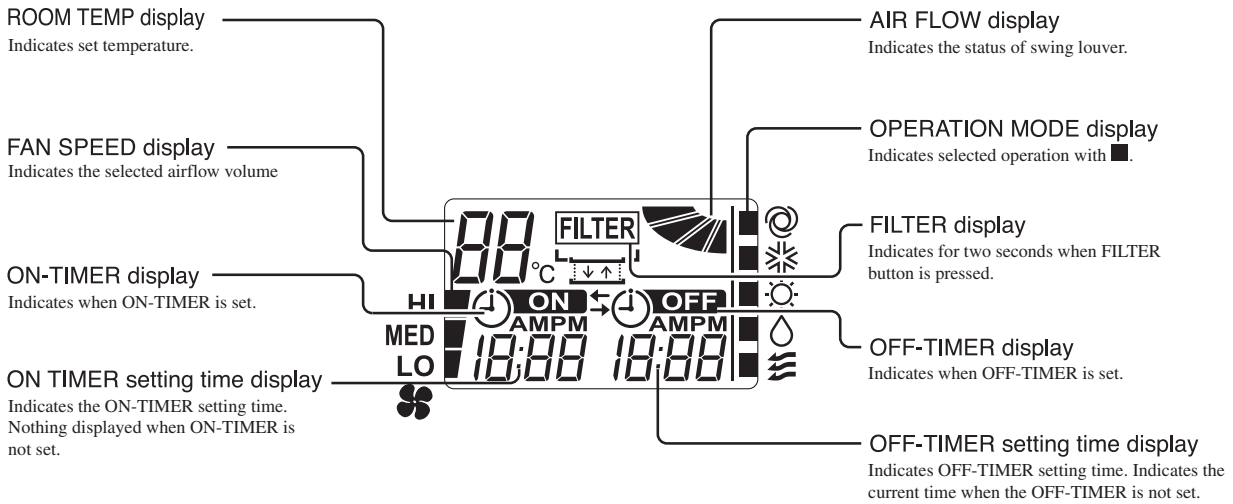

Operation section

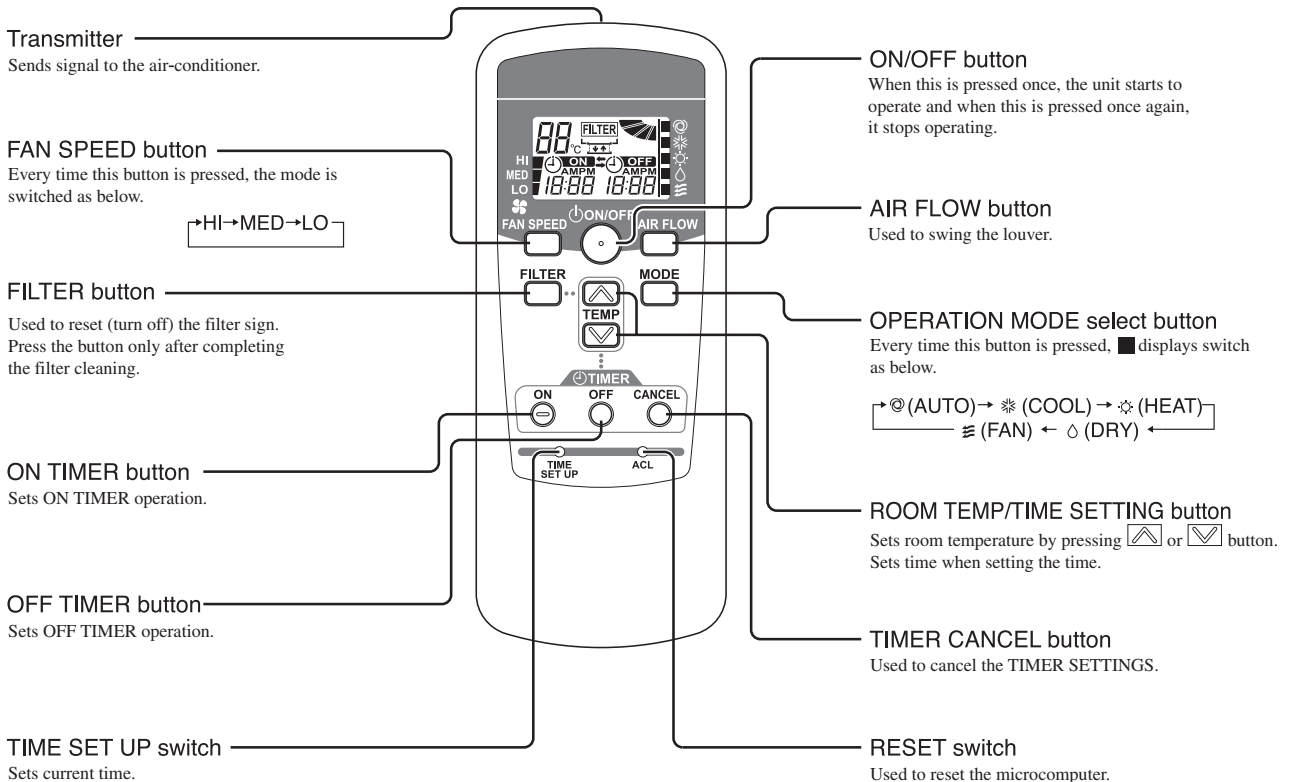

* All displays are described in the liquid crystal display for explanation

11.2 Operation control function by the wired remote control

Model RC-EX1A

(1) Switching sequence of the operation mode switches of remote control

- Tap the change operation mode button on the TOP screen.
 - When the change operation mode screen is displayed, tap the button of desired mode.
 - When the operation mode is selected, the display returns to the TOP screen.
- Icons displayed have the following meanings.

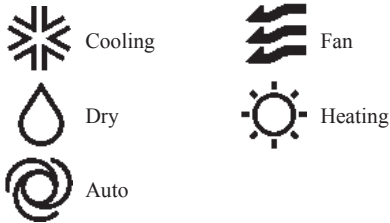

- Notes(1) Operation modes which cannot be selected depending on combinations of IU and OU are not displayed.
- (2) When the Auto is selected, the cooling and heating switching operation is performed automatically according to indoor and outdoor temperatures.

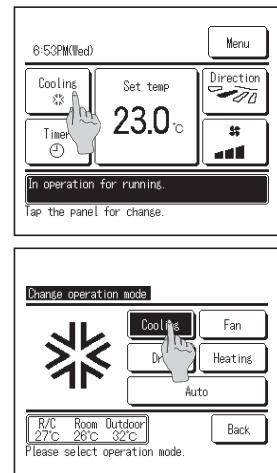

(2) CPU reset

Reset CPU from the remote control as follows.

- Tap the **Menu** button on the TOP screen.
- Main menu screen is displayed.** Tap the "Service & Maintenance" on the menu screen.
- Service & maintenance menus are displayed.**
- Service password input screen.** Enter the service password (4-digit number).
- Service & maintenance menu 1.**
- Service & maintenance menu 2.**
- Special settings.** CPU reset : Microcomputers of IU and OU connected are reset (State of restoration after power failure).
- CPU reset.** All microcomputers on the R/C operated, other R/Cs, IUs and OUs are reset (State of restoration after power failure). Tap [Yes] to reset CPU

(3) Power failure compensation function (Electric power source failure)

Enable the Auto-restart function from the remote control as follows.

- Tap the **Menu** button on the TOP screen.
- Main menu screen is displayed.** Tap the "Service & Maintenance" on the menu screen.
- Service & maintenance menus are displayed.**
- Service password input screen.** Enter the service password (4-digit number).
- R/C setting menu 1.**
- R/C setting menu 2.**
- R/C setting menu 3.**
- Auto-restart.** Enable : It returns to the state before the power source failure as soon as the power is restored (After the end of the primary control at the power on). Disable : It stops after the restoration of power source, regardless of the state of operation before the power failure.

Auto-restart
Set the state of operation to be started when the power source is restored after a power failure.

- Since it memorizes always the condition of remote control, it starts operation according to the contents of memory no sooner than normal state is recovered after the power failure. Although the auto swing stop position and the timer mode are cancelled, the weekly timer setting is restored with the holiday setting for all weekdays. After recovering from the power failure, it readjusts the clock and resets the holiday setting for each weekday so that the setting of weekly timer becomes effective.

- Content memorized with the power failure compensation are as follows.

Note (1) Items (f), (g) and (h) are memorized regardless whether the power failure compensation is effective or not while the setting of silent mode is cancelled regardless whether the power failure compensation is effective or not.

- (a) At power failure – Operating/stopped

If it had been operating under the off timer mode, sleep timer mode, the state of stop is memorized. (Although the timer mode is cancelled at the recovery from power failure, the setting of weekly timer is changed to the holiday setting for all weekdays.)

- (b) Operation mode
- (c) Airflow volume mode
- (d) Room temperature setting
- (e) Louver auto swing/stop

However, the stop position (4-position) is cancelled so that it returns to Position (1).

- (f) “Remote control function items” which have been set with the remote control function setting (“Indoor function items” are saved in the memory of indoor unit.)
- (g) Upper limit value and lower limit value which have been set with the temperature setting control
- (h) Sleep timer and weekly timer settings (Other timer settings are not memorized.)

Model RC-E5

(1) Switching sequence of the operation mode switches of remote control

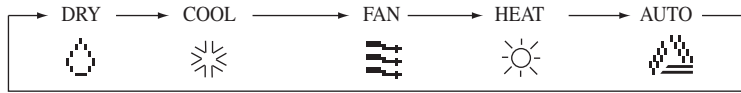

(2) CPU reset

This functions when “CHECK” and “ESP” buttons on the remote control are pressed simultaneously. Operation is same as that of the power source reset.

(3) Power failure compensation function (Electric power source failure)

- This becomes effective if “Power failure compensation effective” is selected with the setting of remote control function.
- Since it memorizes always the condition of remote control, it starts operation according to the contents of memory no sooner than normal state is recovered after the power failure. Although the auto swing stop position and the timer mode are cancelled, the weekly timer setting is restored with the holiday setting for all weekdays. After recovering from the power failure, it readjusts the clock and resets the holiday setting for each weekday so that the setting of weekly timer becomes effective.
- Content memorized with the power failure compensation are as follows.

Note (1) Items (f), (g) and (h) are memorized regardless whether the power failure compensation is effective or not while the setting of silent mode is cancelled regardless whether the power failure compensation is effective or not.

- (a) At power failure – Operating/stopped
If it had been operating under the off timer mode, sleep timer mode, the state of stop is memorized. (Although the timer mode is cancelled at the recovery from power failure, the setting of weekly timer is changed to the holiday setting for all weekdays.)
- (b) Operation mode
- (c) Airflow volume mode
- (d) Room temperature setting
- (e) Louver auto swing/stop
However, the stop position (4-position) is cancelled so that it returns to Position (1).
- (f) “Remote control function items” which have been set with the remote control function setting (“Indoor function items” are saved in the memory of indoor unit.)
- (g) Upper limit value and lower limit value which have been set with the temperature setting control
- (h) Sleep timer and weekly timer settings (Other timer settings are not memorized.)

[Parts layout on remote control PCB]

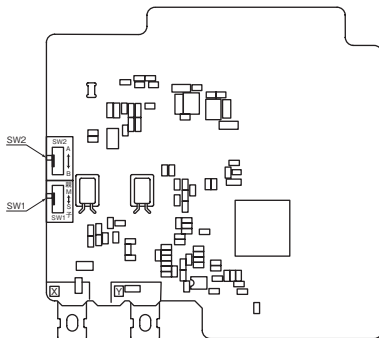

Master/ slave setting when more than one remote controls are used

A maximum of two remote controls can be connected to one indoor unit (or one group of indoor units.)

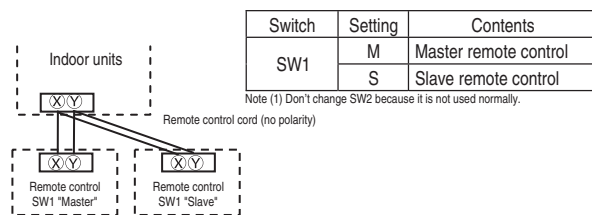

Caution

When using multiple remote controls, the following displays or settings cannot be done with the slave remote control. It is available only with the master remote control.

- ① Louver position setting (set upper or lower limit of swinging range)
- ② Setting indoor unit functions
- ③ Setting temperature range
- ④ Operation data display
- ⑤ Error data display
- ⑥ Silent mode setting
- ⑦ Test operation of drain pump
- ⑧ Remote control sensor setting

11.3 Operation control function by the indoor control

11.3.1 FDT,FDE,FDU,FDUM,FDL series

(1) Auto operation

(a) If "Auto" mode is selected by the remote control, the heating and the cooling are automatically switched according to the difference between outdoor air temperature and setting temperature and the difference between setting temperature and return air temperature. (When the switching of cooling mode ↔ heating mode takes place within 3 minutes, the compressor does not operate for 3 minutes by the control of 3-minute timer.) This will facilitate the cooling/heating switching operation in intermediate seasons and the adaptation to unmanned operation at stores, etc (ATM corner of bank).

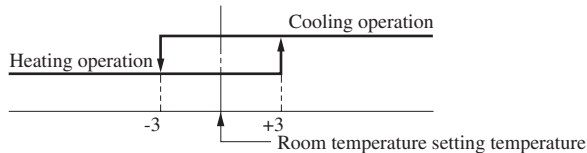

Room temperature (detected with Thi-A) [deg]

Notes (1) Temperature range of switching cooling/heating mode can be changed by RC-EX1A from ±1.0 — ±4.0.

(2) Room temperature control during auto cooling/auto heating is performed according to the room temperature setting temperature. (DIFF: ±1 deg)

(3) If the indoor heat exchanger temperature rises to 59°C or higher during heating operation, it is switched automatically to cooling operation. In addition, for 1 hour after this switching, the heating operation is not performed, regardless of the temperature shown at right.

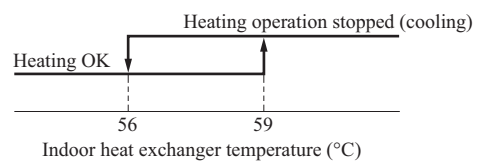

(b) The following automatic controls are performed other than (a) above.

(i) Cooling or heating operation mode is judged according to the conditions of the "Judgment based on Setting temperature + Cooling select temperature and Indoor return air temperature" and the "Judgment based on Outdoor temperature".

- 1) In "Setting temperature - Cooling select temperature < Indoor return air temperature" and "Outdoor temperature/Cooling < Outdoor return air temperature" ⇒ Operation mode: Cooling
- 2) "Setting temperature + Heating select temperature > Indoor return air temperature" and "Outdoor temperature/Heating > Outdoor air temperature" ⇒ Operation mode: Heating
- 3) The outdoor air temperature of the above judgment conditions is sampled at every 10 minutes.
- 4) In the range where the above cooling and heating zones are overlapped ⇒ Forced thermostat OFF

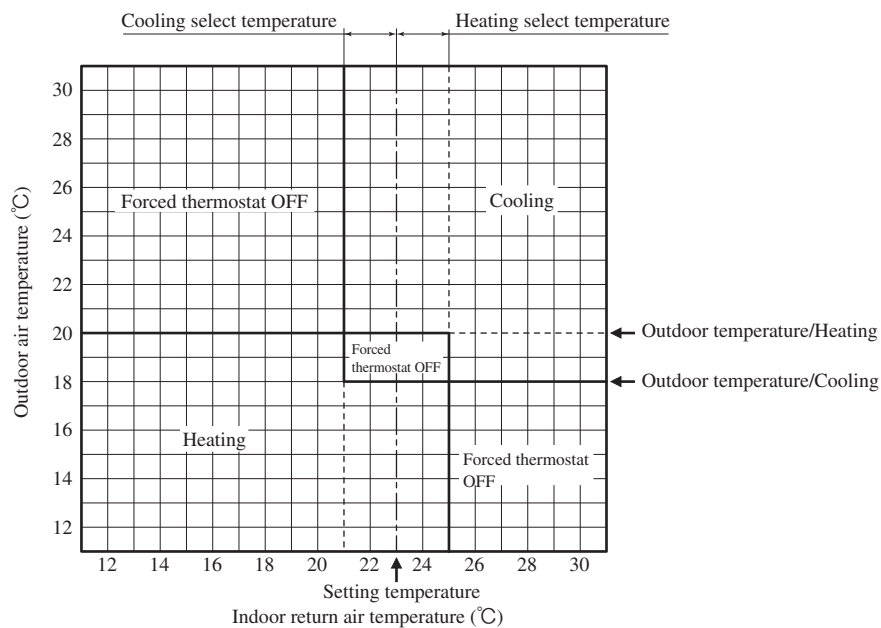

(ii) Regardless of the setting temperature, the cooling or heating operation mode is judged according to the "Judgment based on Room temperature/Cooling or Heating and Outdoor temperature/Cooling or Heating".

- 1) In case of "Room temperature/Cooling < Indoor return air temperature" and "Outdoor temperature/Cooling < Outdoor air temperature" ⇒ Operation mode: Cooling
- 2) In case of "Room temperature/Heating > Indoor return air temperature" and "Outdoor temperature /Heating > Outdoor air temperature" ⇒ Operation mode: Heating
- 3) The outdoor air temperature of the above judgment conditions is sampled at every 10 minutes.
- 4) In the range where the above cooling and heating zones are overlapped ⇒ Forced thermostat OFF

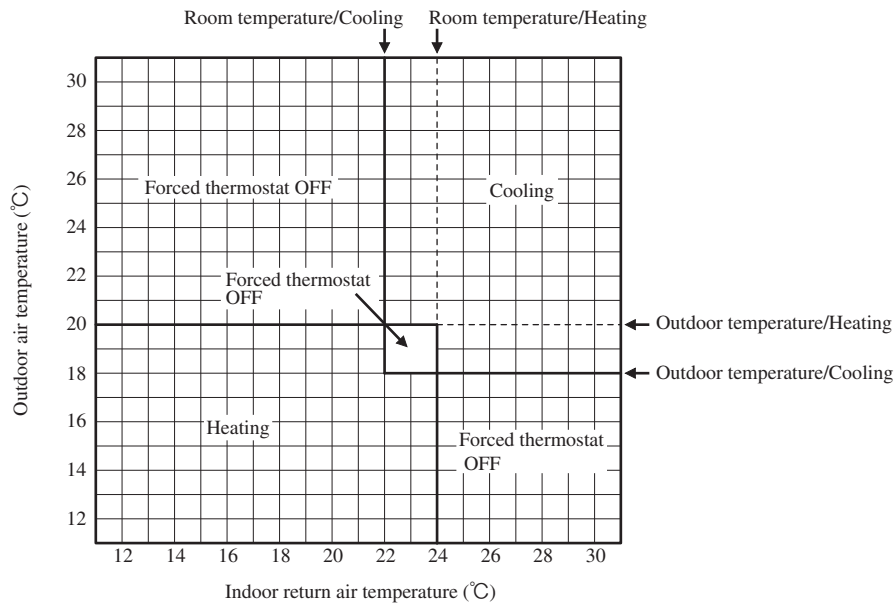

(2) Operations of functional items during cooling/heating

Operation / Functional item	Cooling		Fan	Heating			Dehumidifying
	Thermostat ON	Thermostat OFF		Thermostat ON	Thermostat OFF	Hot start (Defrost)	
Compressor	○	×	×	○	×	○	○/×
4-way valve	×	×	×	○	○	○(×)	×
Outdoor unit fan	○	×	×	○	×	○(×)	○/×
Indoor unit fan	○	○	○	○/×	○/×	○/×	○/×
Drain pump ⁽³⁾	○	× ⁽²⁾	× ⁽²⁾	○/× ⁽²⁾			Thermostat ON: ○ Thermostat OFF: × ⁽²⁾

Note (1) ○: Operation ×: Stop ○/×: Turned ON/OFF by the control other than the room temperature control.
 (2) ON during the drain motor delay control.
 (3) Drain pump ON setting may be selected with the indoor unit function setting of the wired remote control.

(3) Dehumidifying operation

Return air temperature thermistor [Thi-A (by the remote control when the remote control thermistor is enabled)] controls the indoor temperature environment simultaneously.

- (a) Operation is started in the cooling mode. When the difference between the return air temperature and the setting temperature is 2°C or less, the indoor unit fan tap is brought down by one tap. That tap is retained for 3 minutes after changing the indoor unit fan tap.
- (b) If the return air temperature exceeds the setting temperature by 3°C during dehumidifying operation, the indoor unit fan tap is raised. That tap is retained for 3 minutes after changing the indoor unit fan tap.
- (c) If the thermostat OFF is established during the above control, the indoor unit fan tap at the thermostat ON is retained so far as the thermostat is turned OFF.

(4) Timer operation

(a) RC-EX1A

- (i) Sleep timer
Set the time from the start to stop of operation. The time can be selected in the range from 30 to 240 minutes (in the unit of 10-minute).
Note (1) Enable the "Sleep timer" setting from the remote control. If the setting is enabled, the timer operates at every time.
- (ii) Set OFF timer by hour
Set the time to stop the unit after operation, in the range from 1 to 12 hours (in the unit of hour).
- (iii) Set ON timer by hour
Set the time to start the unit after the stop of operation, in the range from 1 to 12 hours (in the unit of hour). It is allowed also to set simultaneously the indoor temperature, operation mode, air flow rate and warm-up enabled/disabled.
- (iv) Set ON timer by clock
Set the time to start operation. The time can be set in the unit of 5-minute. This setting can be activated only once or at every time. It is allowed also to set simultaneously the indoor temperature, operation mode, air flow rate and warm-up enabled/disabled.
Note (1) It is necessary to set the clock to use this timer.
- (v) Set OFF timer by clock
Set the time to stop operation. The time can be set in the unit of 5-minute. This setting can be activated only once or at every time.
Note (1) It is necessary to set the clock to use this timer.
- (vi) Weekly timer
Set the ON or OFF timer for a week. Up to 8 patterns can be set for a day. The day-off setting is provided for holidays and non-business days.
Note (1) It is necessary to set the clock to use the weekly timer.

(vii) Combination of patterns which can be set for the timer operations

	Sleep time	Set OFF timer by hour	Set ON timer by hour	Set OFF timer by clock	Set ON timer by clock	Weekly timer
Sleep time		×	×	○	○	○
Set OFF timer by hour	×		×	×	×	×
Set ON timer by hour	×	×		×	×	×
Set OFF timer by clock	○	×	×		○	×
Set ON timer by clock	○	×	×	○		×
Weekly timer	○	×	×	×	×	

Note (1) ○: Allowed ×: Not

(b) RC-E5

- (i) Sleep timer
Set the duration of time from the present to the time to turn off the air-conditioner.
It can be selected from 10 steps in the range from "OFF 1 hour later" to "OFF 10 hours later". After the sleep timer setting, the remaining time is displayed with progress of time in the unit of hour.
- (ii) OFF timer
Time to turn OFF the air-conditioner can be set in the unit of 10 minutes.
- (iii) ON timer
Time to turn ON the air-conditioner can be set. Indoor temperature can be set simultaneously.
- (iv) Weekly timer
Timer operation (ON timer, OFF timer) can be set up to 4 times a day for each weekday.
- (v) Timer operations which can be set in combination

Item	Item	Timer	OFF timer	ON timer	Weekly timer
Timer			×	○	×
OFF timer	×			○	×
ON timer	○		○		×
Weekly timer	×	×	×	×	

Note (1) ○: Allowed ×: Not

(2) Since the ON timer, sleep timer and OFF timer are set in parallel, when the times to turn ON and OFF the air-conditioner are duplicated, the setting of the OFF timer has priority.

(5) Remote control display during the operation stop

When the operation is stopped (the power source is turned ON), it displays preferentially the “Room temperature”, “Center/Remote”, “Filter sign”, “Inspection” and “Timer operation”.

(6) Hot start (Cold draft prevention at heating)**(a) Operating conditions**

When either one of following conditions is met, the hot start control is performed.

- (i) From stop to heating operation
- (ii) From cooling to heating operation
- (iii) From heating thermostat OFF to ON
- (iv) After completing the defrost control (only on units with thermostat ON)

(b) Contents of operation

- (i) Indoor fan motor control at hot start
 - 1) Within 7 minutes after starting heating operation, the fan mode is determined depending on the condition of thermostat (fan control with heating thermostat OFF).
 - a) Thermostat OFF
 - i) Operates according to the fan control setting at heating thermostat OFF.
 - ii) Even if it changes from thermostat OFF to ON, the fan continues to operate with the fan control at thermostat OFF till the heat exchanger thermistor (Thi-R1 or R2, whichever higher) detects 35°C or higher.
 - iii) When the heat exchanger thermistor (Thi-R1 or R2, whichever higher) detects 35°C or higher, the fan operates with the set airflow volume.
 - b) Thermostat ON
 - i) When the heat exchanger thermistor (Thi-R1 or R2, whichever higher) detects 25°C or lower, the fan is turned OFF and does not operate.
 - ii) When the heat exchanger thermistor (Thi-R1 or R2, whichever higher) detects 25°C or higher, the fan operates with the fan control at heating thermostat OFF.
 - iii) When the heat exchanger thermistor (Thi-R1 or R2, whichever higher) detects 35°C or higher, the fan operates with the set airflow volume.
 - c) If the fan control at heating thermostat OFF is set at the “Set airflow volume” (from the remote control), the fan operates with the set airflow volume regardless of the thermostat ON/OFF.
 - 2) Once the fan motor is changed from OFF to ON during the thermostat ON, the indoor fan motor is not turned OFF even if the heat exchanger thermistor detects lower than 25°C.

Note (1) When the defrost control signal is received, it complies with the fan control during defrosting.
 - 3) Once the hot start is completed, it will not restart even if the temperature on the heat exchanger thermistor drops.
- (ii) During the hot start, the louver is kept at the horizontal position.
- (iii) When the fan motor is turned OFF for 7 minutes continuously after defrosting, the fan motor is turned ON regardless of the temperatures detected with the indoor heat exchanger thermistors (Thi-R1, R2).

(c) Ending condition

- (i) If one of following conditions is met during the hot start control, this control is terminated, and the fan is operated with the set airflow volume.
 - 1) Heat exchanger thermistor (Thi-R1 or R2, whichever higher) detects 35°C or higher.
 - 2) It has elapsed 7 minutes after starting the hot start control.

(7) Hot keep

Hot keep control is performed at the start of the defrost control.

(a) Control

- (i) When the indoor heat exchanger temperature (detected with Thi-R1 or R2) drops to 35°C or lower, the speed of indoor fan is changed to the lower tap at each setting.
- (ii) During the hot keep, the louver is kept at the horizontal position.

(b) Ending condition

When the indoor fan is at the lower tap at each setting, it returns to the set airflow volume as the indoor heat exchanger temperature rises to 45°C or higher.

(8) Auto swing control (Only with auto swing)**(a) RC-EX1A****(i) Louver control**

- 1) To operate the swing louver when the air-conditioner is operating, press the “Direction” button on the TOP screen of remote control. The wind direction select screen will be displayed.
- 2) To swing the louver, touch the “Auto swing” button. The lover will move up and down. To fix the swing louver at a position, touch one of [1] - [4] buttons. The swing lover will stop at the selected position.
- 3) Louver operation at the power on with a unit having the louver 4-position control function
The louver swings one time automatically (without operating the remote control) at the power on.
This allows the microcomputer recognizing and inputting the louver motor (LM) position.

(ii) Automatic louver level setting during heating

At the hot start and the heating thermostat OFF, regardless whether the auto swing switch is operated or not (auto swing or louver stop), the louver takes the level position (in order to prevent blowing of cool wind). The louver position display LCD continues to show the display which has been shown before entering this control.

(iii) Louver free stop control

If you touch the “Menu” → “Next” → “R/C settings” buttons one after another on the TOP screen of remote control, the “Flap control” screen is displayed. If the free stop is selected on this screen, the louver motor stops upon receipt of the stop signal from the remote control. If the auto swing signal is received from the remote control, the auto swing will start from the position before the stop.

(b) RC-E5**(i) Louver control**

- 1) Press the “LOUVER” button to operate the swing louver when the air-conditioner is operating.
“SWING ㊦” is displayed for 3 seconds and then the swing louver moves up and down continuously.
- 2) To fix the swing louver at a position, press one time the “LOUVER” button while the swing louver is moving so that four stop positions are displayed one after another per second.
When a desired stop position is displayed, press the “LOUVER” button again. The display stops, changes to show the “STOP 1 ㊦” for 5 seconds and then the swing louver stops.
- 3) Louver operation at the power on with a unit having the louver 4-position control function
The louver swings one time automatically (without operating the remote control) at the power on.
This allows inputting the louver motor (LM) position, which is necessary for the microcomputer to recognize the louver position.

Note (1) If you press the “LOUVER” button, the swing motion is displayed on the louver position LCD for 10 second. The display changes to the “SWING ㊦” display 3 seconds later.

(ii) Automatic louver level setting during heating

At the hot start with the heating thermostat OFF, regardless whether the auto swing switch is operated or not (auto swing or louver stop), the louver takes the level position (In order to prevent the cold start). The louver position display LCD continues to show the display which has been shown before entering this control.

(iii) Louver-free stop control

When the louver-free stop has been selected with the indoor function of wired remote control “㊦ POSITION”, the louver motor stops when it receives the stop signal from the remote control. If the auto swing signal is received from the remote control, the auto swing will start from the position where it was before the stop.

Note (1) When the indoor function of wired remote control “㊦ POSITION” has been switched, switch also the remote control function “㊦ POSITION” in the same way.

(9) Thermostat operation**(a) Cooling**

- (i) Thermostat is operated with the room temperature control.
- (ii) Thermostat is turned ON or OFF relative to the set room temperature as shown below.

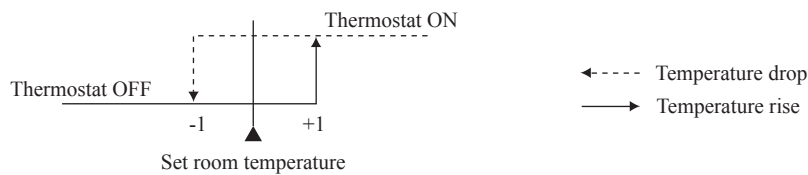

- (iii) Thermostat is turned ON when the room temperature is in the range of $-1 < \text{Set temperature} < +1$ at the start of cooling operation (including from heating to cooling).

(b) Heating

- (i) Thermostat is operated with the room temperature control.
- (ii) Thermostat is turned ON or OFF relative to the set room temperature as shown below.

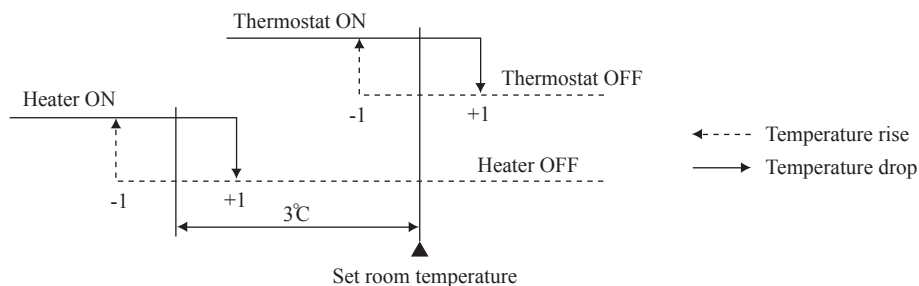

- (iii) Thermostat is turned ON when the room temperature is in the range of $-1 < \text{Set point} < +1$ at the start of cooling operation (including from cooling to heating).

(c) Fan control during heating thermostat OFF

- (i) Following fan controls during the heating thermostat OFF can be selected with the indoor function setting of the wired remote control.
 - ① Low fan speed (Factory default), ② Set fan speed, ③ Intermittence, ④ Fan OFF
- (ii) When the “Low fan speed (Factory default)” is selected, the following taps are used for the indoor fans.
 - For DC motor : ULo tap
- (iii) When the “Set fan speed” is selected, it is operated with the set fan speed also in the thermostat OFF condition.
- (iv) If the “Intermittence” is selected, following controls are performed:
 - 1) If the thermostat is turned OFF during the heating operation, the indoor unit fan motor stops.
 - 2) Indoor fan OFF is fixed for 5 minutes. After the 5 minutes, the indoor fan is operated at ULo for 2 minutes. In the meantime the louver is controlled at level.
 - 3) After operating at ULo for 2 minutes, the indoor fan moves to the state of 1) above.
 - 4) If the thermostat is turned ON, it moves to the hot start control.
 - 5) When the heating thermostat is turned OFF, the remote control displays the temperature detected at the fan stop and revises the temperature later when the indoor fan changes from ULo to stop. The remote control uses the operation data display function to display temperatures and updates values of temperature even when the indoor fan is turned OFF.
 - 6) When the defrosting starts while the heating thermostat is turned OFF or the thermostat is turned OFF during defrosting, the indoor fan is turned OFF. (Hot keep or hot start control takes priority.) However, the suction temperature is updated at every 7-minute.
 - 7) When the heating thermostat is turned ON or the operation is changed to another mode (including stop), this control is stopped immediately, and the operating condition is restored.
- (v) When the “Fan OFF” is selected, the fan on the indoor unit of which the thermostat has been turned OFF, is turned OFF. The same occurs also when the remote control sensor is effective.

(d) Fan control during cooling thermostat OFF

- (i) Following fan controls during the cooling thermostat OFF can be selected with the indoor function setting of the wired remote control.
 - ① Low fan speed, ② Set fan speed (Factory default), ③ Intermittence, ④ Fan OFF
- (ii) When the “Low fan speed” is selected, the following taps are used for the indoor fans.
 - For DC motor : ULo tap
- (iii) When the “Set fan speed” is selected, it is operated with the set fan speed also in the thermostat OFF condition.
- (iv) If the “Intermittence” is selected, following controls are performed:
 - 1) If the thermostat is turned OFF during the cooling operation, the indoor unit fan motor stops.
 - 2) Indoor fan OFF is fixed for 5 minutes. After the 5 minutes, the indoor fan is operated at ULo for 2 minutes.
 - 3) After operating at ULo for 2 minutes, the indoor fan moves to the state of 1) above.
 - 4) If the thermostat is turned ON, the fan starts operation at set fan speed.
 - 5) When the cooling thermostat is turned OFF, the remote control displays the temperature detected at the fan stop and revises the temperature later when the indoor fan changes from ULo to stop.
By using operation data display function at wireless remote control, the temperature as displayad and the value is updated including the fan stops.
 - 6) When the cooling thermostat is turned ON or the operation is changed to another mode (including stop), this control is stopped immediately, and the operating condition is restored.
- (v) When the “Fan OFF” is selected, the fan on the indoor unit of which the thermostat has been turned OFF, is turned OFF. The same occurs also when the remote control sensor is effective.

(10) Filter sign

As the operation time (Total ON time of ON/OFF switch) accumulates to 180 hours (1), “FILTER CLEANING” is displayed on the remote control. (This is displayed when the unit is in trouble and under the central control, regardless of ON/OFF)

Note (1) Time setting for the filter sign can be made as shown below using the indoor function of wired remote control “FILTER SIGN SET”. (It is set at TYPE 1 at the shipping from factory.)

Filter sign setting	Function
TYPE 1	Setting time: 180 hr (Factory default)
TYPE 2	Setting time: 600 hr
TYPE 3	Setting time: 1,000 hr
TYPE 4	Setting time: 1,000 hr (Unit stop) ⁽²⁾

(2) After the setting time has elapsed, the “FILTER CLEANING” is displayed and, after operating for 24 hours further (counted also during the stop), the unit stops.

(11) Compressor inching prevention control

- (a) 3-minute timer

When the compressor has been stopped by the thermostat, remote control operation switch or anomalous condition, its restart will be inhibited for 3 minutes. However, the 3-minute timer is invalidated at the power on the electric power source for the unit.
- (b) 3-minute forced operation timer
 - (i) Compressor will not stop for 3 minutes after the compressor ON. However, it stops immediately when the unit is stopped by means of the ON/OFF switch or by when the thermister turned OFF the change of operation mode.
 - (ii) If the thermostat is turned OFF during the forced operation control of heating compressor, the louver position (with the auto swing) is returned to the level position.

Note (1) The compressor stops when it has entered the protective control.

(12) Drain pump control

- (a) This control is operated when the inverter frequency is other than 0 Hz during the cooling operation and automatic cooling and dehumidifying operations.
- (b) Drain pump ON condition continues for 5 minutes even when it enters the OFF range according to (i) above after turning the drain pump ON, and then stops. The 5-minute delay continues also in the event of anomalous stop.
- (c) The drain pump is operated with the 5-minute delay operation when the compressor is changed from ON to OFF.
- (d) Even in conditions other than the above (such as heating, fan, stop, cooling thermostat OFF), the drain pump control is performed by the drain detection.
- (e) Following settings can be made using the indoor function setting of the wired remote control.
 - (i) 标准 [Standard (in cooling & dehumidifying)] : Drain pump is run during cooling and dehumidifying.
 - (ii) 标准AND采暖 [Operate in standard & heating] : Drain pump is run during cooling, dehumidifying and heating.
 - (iii) 标准AND采暖AND送风 [Operate in heating & fan] : Drain pump is run during cooling, dehumidifying, heating and fan.
 - (iv) 标准AND送风 [Operate in standard & fan] : Drain pump is run during cooling, dehumidifying and fan.

Note (1) Values in [] are for the RC-EX1A model.

(13) Drain pump abnormalities detection

- (a) Drain detection switch is turned ON or OFF with the float switch (FS) and the timer.

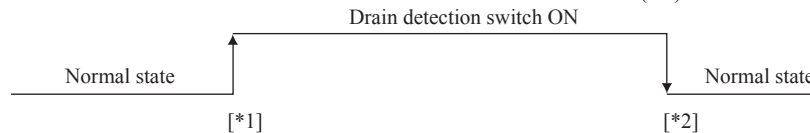

[*1] Drain detection switch is turned “ON” when the float switch “Open” is detected for 3 seconds continuously in the drain detectable space.

[*2] Drain detection switch is turned “OFF” when the float switch “Close” is detected for 10 seconds continuously.

- (i) It detects always from 30 seconds after turning the power ON.
 - 1) There is no detection of anomalous draining for 10 seconds after turning the drain pump OFF.
 - 2) Turning the drain detection switch “ON” causes to turn ON the drain pump forcibly.
 - 3) Turning the drain detection switch “OFF” releases the forced drain pump ON condition.
- (b) Indoor unit performs the control A or B depending on each operating condition.

	Indoor unit operation mode				
	Stop ⁽¹⁾	Cooling	Dehumidifying	Fan ⁽²⁾	Heating
Compressor ON		Control A			
Compressor OFF		Control B			

Note (1) Including the stop from the cooling, dehumidifying, fan and heating, and the anomalous stop
 (2) Including the “Fan” operation according to the mismatch of operation modes

- (i) Control A
 - 1) If the float switch detects any anomalous draining condition, the unit stops with the anomalous stop (displays E9) and the drain pump starts. After detecting the anomalous condition, the drain motor continues to be ON.
 - 2) It keeps operating while the float switch is detecting the anomalous condition.
- (ii) Control B

If the float switch detects any anomalous drain condition, the drain motor is turned ON for 5 minutes, and at 10 seconds after the drain motor OFF it checks the float switch. If it is normal, the unit is stopped under the normal mode or, if there is any anomalous condition, E9 is displayed and the drain motor is turned ON. (The ON condition is maintained during the drain detection.)

(14) Operation check/drain pump test run operation mode

- (a) If the power is turned on by the dip switch (SW7-1) on the indoor PCB when electric power source is supplied, it enters the mode of operation check/drain pump test run. It is ineffective (prohibited) to change the switch after turning power on.
- (b) When the communication with the remote control has been established within 60 seconds after turning power on by the dip switch (SW7-1) ON, it enters the operation check mode. Unless the remote control communication is established, it enters the drain pump test run mode.

Note (1) To select the drain pump test run mode, disconnect the remote control connector (CNB) on the indoor PCB to shut down the remote control communication.

(c) Operation check mode

There is no communication with the outdoor unit but it allows performing operation in respective modes by operating the remote control.

(d) Drain pump test run mode

As the drain pump test run is established, the drain pump only operates and during the operation protective functions by the microcomputer of indoor unit become ineffective.

(15) Cooling, dehumidifying frost protection

- (a) To prevent frosting during cooling mode or dehumidifying mode operation, the of compressor speed is reduced if the indoor heat exchanger temperature (detected with Thi-R) drops to 1.0 °C or lower at 4 minutes after the start of compressor operation. If the indoor unit heat exchanger temperature is 1.0 °C or lower after 1 minutes, the compressor speed is reduced further. If it becomes 2.5 °C or higher, the control terminates. When the indoor heat exchanger temperature has become as show below after reducing the compressor speed, it is switched to the fan operation. For the selection of indoor fan speed, refer to item 2).

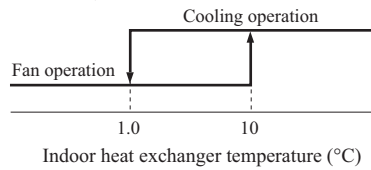

(b) Selection of indoor fan speed

If it enters the frost prevention control during cooling operation (excluding dehumidifying), the indoor unit fan speed is switched.

- (i) When the indoor return air detection temperature (detected with Thi-A) is 23°C or higher and the indoor heat exchanger temperature (detected with Thi-R) detects the compressor frequency drop start temperature A°C+1°C, of indoor unit fan speed is increased by 20min⁻¹.
- (ii) If the phenomenon of 1) above is detected again after the acceleration of indoor unit fan, indoor unit fan speed is increased further by 20min⁻¹.

Note (1) Indoor unit fan speed can be increased by up to 2 taps.

• Compressor frequency drop start temperature

Item	Symbol	A
Temperature - Low (Factory default)(2)		1.0
Temperature - High		2.5

Notes (1) Frost prevention temperature setting can be selected with the indoor unit function setting of the wired remote control.

(2) Limited to FDE series only, it is set at the high temperature (2.5°C) at the time of shipping from the factory.

(16) Heating overload protection

- (a) If the indoor heat exchanger temperature (detected with Thi-R) at 63°C or higher is detected for 2 seconds continuously, the compressor stops. When the compressor is restarted after a 3-minute delay, if a temperature at 63°C or higher is detected for 2 seconds continuously within 60 minutes after initial detection and if this is detected 5 times consecutively, the compressor stops with the anomalous stop (E8). Anomalous stop occurs also when the indoor heat exchanger temperature at 63°C or higher is detected for 6 minutes continuously.

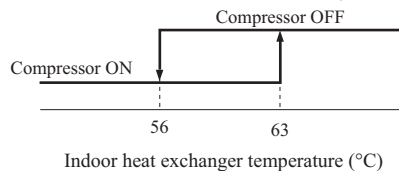

(b) Indoor unit fan speed selection

If, after second detection of heating overload protection up to fourth, the indoor fan is set at Me and Lo taps when the compressor is turned ON, the indoor fan speed is increased by 1 tap.

(17) Anomalous fan motor

- (a) After starting the fan motor, if the fan motor speed is 200min⁻¹ or less is detected for 30 seconds continuously and 4 times within 60 minutes, then fan motor stops with the anomalous stop (E16).
- (b) If the fan motor fails to reach at -50(FDU: -500) min⁻¹ less than the required speed, it stops with the anomalous stop (E20).

(18) Plural unit control – Control of 16 units group by one remote control

(a) Function

One remote control switch can control a group of multiple number of unit (Max. 16 indoor units). “Operation mode” which is set by the remote control switch can operate or stop all units in the group one after another in the order of unit No.⁽¹⁾. Thermostat and protective function of each unit function independently.

Notes (1) Unit No. is set by SW2 on the indoor unit control PCB. Unit No. setting by SW2 is necessary for the indoor unit only.

SW2: For setting of 0 – 9, A – F

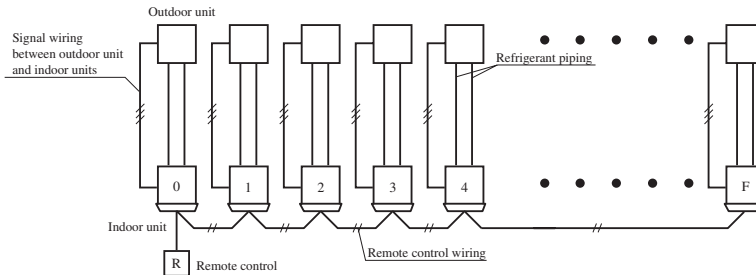

(2) Unit No. may be set at random unless duplicated, it should be better to set orderly like 0, 1, 2..., F to avoid mistake.

(b) Display to the remote control

- (i) Central or each remote control basis, heating preparation: the youngest unit No. among the operating units in the remote mode (or the central mode unless the remote mode is available) is displayed.
- (ii) Inspection display, filter sign: Any of unit that starts initially is displayed.
- (iii) Confirmation of connected units
 - 1) In case of RC-EX1A remote control
If you touch the buttons in the order of “Menu” → “Next” → “Service & Maintenance” → “IU address” on the TOP screen of remote control, the indoor units which are connected are displayed.
 - 2) In case of RC-E5 remote control
Pressing “AIR CON No.” button on the remote control displays the indoor unit address. If “▲” “▼” button is pressed at the next, it is displayed orderly starting from the unit of youngest No.
- (iv) In case of anomaly
 - 1) If any anomaly occurs on a unit in a group (a protective function operates), that unit stops with the anomalous stop but any other normal units continue to run as they are.
 - 2) Signal wiring procedure
Signal wiring between indoor and outdoor units should be made on each unit same as the normal wiring. For the group control, lay connect with sires wiring between rooms using terminal blocks (X, Y) of remote control. Connect the remote control communication wire separately from the power source wire or wires of other electric devices (AC220V or higher).

(19) High ceiling control

When sufficient air flow rate cannot be obtained from the indoor unit which is installed at a room with high ceiling, the air flow rate can be increased by changing the fan tap. To change the fan tap, use the indoor unit function “FAN SPEED SET” on the wired remote control.

Fan tap		Indoor unit airflow setting				Series
FAN SPEED SET	STANDARD	PHi1 - Hi - Me- Lo	Hi - Me - Lo	Hi - Lo	Hi - Me	Except FDT, FDE
		PHi2 - Hi - Me- Lo	Hi - Me - Lo	Hi - Lo	Hi - Me	Only FDT, FDE
	HIGH SPEED1	PHi1 - PHi1 - Hi - Me	PHi1 - Hi - Me	PHi1 - Me	PHi1 - Hi	Except FDT, FDE
		PHi2 - PHi1 - Hi - Me	PHi1 - Hi - Me	PHi1 - Me	PHi1 - Hi	Only FDT
	HIGH SPEED2	PHi1 - Hi - Me- Lo	Hi - Me - Lo	Hi - Lo	Hi - Me	Only FDE
		PHi2 - Hi - Me- Lo	Hi - Me - Lo	Hi - Lo	Hi - Me	Only FDT, FDE

Notes (1) Factory default is STANDARD.

(2) At the hot-start and heating thermostat OFF, or other, the indoor unit fan is operated at the low speed tap of each setting.

(3) This function is not able to be set with wireless remote controls or simple remote control (RCH-E3)

(20) Abnormal temperature thermistor (return air/indoor heat exchanger) wire/short-circuit detection

- (a) Broken wire detection
When the return air temperature thermistor detects -50°C or lower or the heat exchanger temperature thermistor detect -50°C or lower for 5 seconds continuously, the compressor stops. After a 3-minute delay, the compressor restarts but, if it is detected again within 60 minutes after the initial detection for 6 minutes continuously, stops again (the return air temperature thermistor: E7, the heat exchanger temperature thermistor: E6).
- (b) Short-circuit detection
If the heat exchanger temperature thermistor detects 70°C or higher for 5 seconds continuously at 2 minutes and 20 seconds after the compressor ON during cooling operation, the compressor stops (E6).

(21) External input/output control (CnT or CnTA)

Be sure to connect the wired remote control to the indoor unit. Without wired remote control remote operation by CnT is not possible to perform.

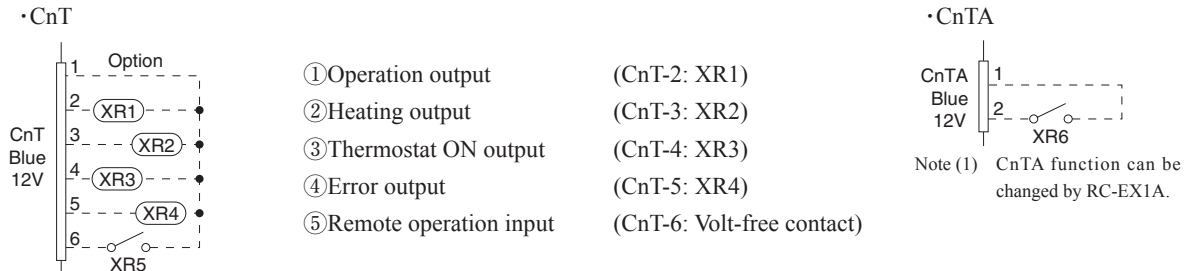

Priority order for combinations of CnT and CnTA input.

		CnTA					
		① Operation stop level	② Operation stop pulse	③ Operation permission/prohibition	④ Operation permission/prohibition pulse	⑤ Cooling/heating selection level	⑥ Cooling/heating selection pulse
CnT	① Operation stop level	CnT ①	CnT ①	CnT ① + CnTA ②	CnT ①	CnT ① / CnTA ⑤	CnT ① / CnTA ⑥
	② Operation stop pulse	CnT ②	CnT ②	CnT ② + CnTA ③	CnT ②	CnT ② / CnTA ⑤	CnT ② / CnTA ⑥
	③ Operation permission/prohibition level	CnT ③ > CnTA ①	CnT ③ > CnTA ②	CnT ③ + CnTA ③	CnT ③	CnT ③ / CnTA ⑤	CnT ③ / CnTA ⑥
	④ Operation permission/prohibition pulse	CnT ④	CnT ④	CnT ④ + CnTA ③※	CnT ④	CnT ④ / CnTA ⑤	CnT ④ / CnTA ⑥
	⑤ Cooling/heating selection level	CnT ⑤ / CnTA ①	CnT ⑤ / CnTA ②	CnT ⑤ / CnTA ③※	CnT ⑤ / CnTA ④	CnT ⑤	CnT ⑤
	⑥ Cooling/heating selection pulse	CnT ⑥ / CnTA ①	CnT ⑥ / CnTA ②	CnT ⑥ / CnTA ③	CnT ⑥ / CnTA ④	CnT ⑥	CnT ⑥

Note (1) Following operation commands are accepted when the operation prohibition is set with CnTA as indicated with *.

Individual operation command from remote control, test run command from outdoor unit and operation command from optional device, CNT input.

Reference: Explanation on the codes and the combinations of codes in the table above

1. In case of CnT “Number”, the CnT “Number” is adopted and CnTA is invalidated.
 2. In case of CnTA “Number”, the CnTA “Number” is adopted and CnT is invalidated.
 3. In case of CnT “Number”/CnTA “Number”, the CnT “Number” and the CnTA “Number” become independent functions each other.
 4. In case of CnT “Number” + CnTA “Number”, the CnT “Number” and the CnTA “Number” become competing functions each other.
 5. In case of CnT “Number” > CnTA “Number”, the function of CnT “Number” supersedes that of CnTA “Number”.
 6. In case of CnT “Number” < CnTA “Number”, the function of CnTA “Number” supersedes that of CnT “Number”.
- (The “Number” above means ① - ⑥ in the table.)

(a) Output for external control (remote display)

Following output connectors (CnT) are provided on the indoor control PCB for monitoring operation status.

- ① **Operation output:** Outputs DC12V signal for driving relay during operation
- ② **Heating output:** Outputs DC12V signal for driving relay during heating operation
- ③ **Thermostat ON output:** Outputs DC12V signal for driving relay when compressor is operating.
- ④ **Error output:** Outputs DC12V signal for driving relay when anomalous condition occurs.

(b) Remote operation input

Remote operation input connector (CnT-6 or CnTA) is provided on the indoor control PCB.

However remote operation by CnT-6 or CnTA is not effective, when “Center mode” is selected by central control.

Only the “LEVEL INPUT” is acceptable for external input, however when the indoor function setting of “Level input (Factory default)” or “Pulse input” is selected by the function for “External input” of the wired remote control, operation status will be changed as follows.

(i) In case of “Level input” setting (Factory default)

Input signal to CnT-6 or CnTA is OFF→ON unit ON
 Input signal to CnT-6 or CnTA is ON→OFF unit OFF
 Operation is not inverted.

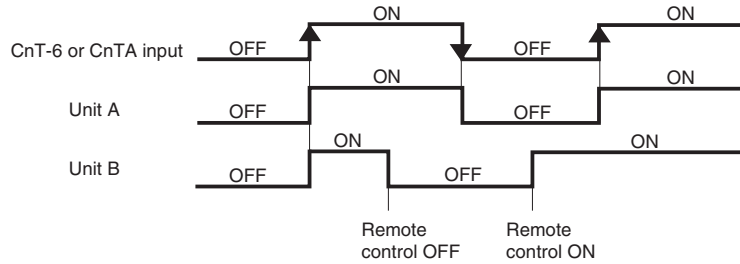

Note: The latest operation has priority
 It is available to operate/stop by remote control or center control

(ii) In case of “Pulse input” setting (Local setting)

It is effective only when the input signal to CnT-6 or CnTA is changed OFF→ON, and at that time unit operation [ON/OFF] is inverted.

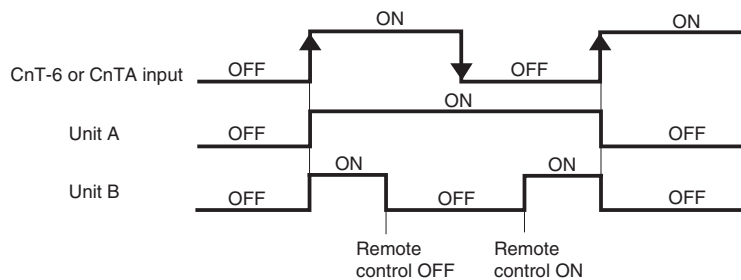

(c) Remote operation

(i) In case of multiple units (Max. 16 indoor units group) are connected to one wired remote control

When the indoor function setting of wired remote control for “External control set” is changed from “Individual (Factory default)” to “For all units”, all units connected in one wired remote control system can be controlled by external operation input.

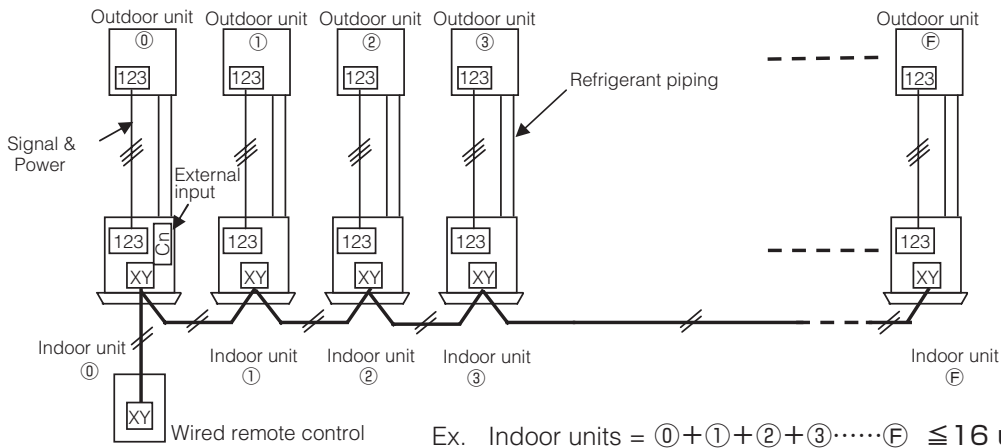

CnT-6 or CnTA	Individual operation (Factory default)		All units operation (Local setting)	
	ON	OFF	ON	OFF
	Only the unit directly connected to the remote control can be operated.	Only the unit directly connected to the remote control can be stopped operation.	All units in one remote control system can be operated.	All units in one remote control system can be stopped operation.
	Unit ① only	Unit ① only	Units ① - ⑥	Units ① - ⑥

When more than one indoor unit (Max. 16 indoor units) are connected in one wired remote control system:

- (1) With the factory default, external input to CnT-6 or CnTA is effective for only the unit ①.
- (2) When setting “For all unit” (Local setting), all units in one remote control system can be controlled by external input to CnT-6 or CnTA on the indoor unit ①.
- (3) External input to CnT-6 or CnTA on the other indoor unit than the unit ① is not effective.

(22) Operation permission/prohibition

(In case of adopting card key switches or commercially available timers)

When the indoor function setting of wired remote control for “Operation permission/prohibition” is changed from “Invalid (Factory default)” to “Valid”, following control becomes effective.

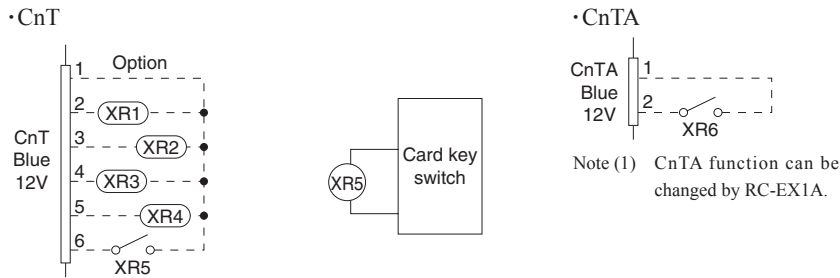

	Normal operation (Factory default)		Operation permission/prohibition mode “Valid” (Local setting)	
	ON	OFF	ON	OFF
CnT-6 or CnTA	Operation	Stop	Operation permission*1	Operation prohibition (Unit stops)

*1 **Only the “LEVEL INPUT” is acceptable for external input**, however when the indoor function setting of “Level input (Factory default)” or “Pulse input” is selected by the function for “External input” of the wired remote control, operation status will be changed as follows.

In case of “Level input” setting	In case of “Pulse input” setting
Unit operation from the wired remote control becomes available*(1)	Unit starts operation *(2)

- * (1) In case that “Operation permission/prohibition mode” setting is “Valid” and “External input” setting is “Level input (Factory default)”;
 - ① When card key switch is ON (CnT-6 or CnTA ON: Operation permission), start/stop operation of the unit from the wired remote control becomes available.
 - ② When card key switch is OFF (CnT-6 or CnTA OFF: Operation prohibition), the unit stops operation in conjunction with OFF signal, and start/stop operation of the unit from the wired remote control becomes not available.
- * (2) In case that “Operation permission/prohibition mode” setting is “Valid” and “External input” setting is “Pulse input (Local setting)”;
 - ① When card key switch is ON (Operation permission), the unit starts operation in conjunction with ON signal, and also start/stop operation of the unit from the wired remote control becomes available.
 - ② When card key switch is OFF (Operation prohibition), the unit stops operation in conjunction with OFF signal, and start/stop operation of the unit from the wired remote control becomes not available.
- (3) This function is invalid only at “Center mode” setting done by central control.

(a) In case of CnT ① Operation stop level > CnTA ③ Operation permission/prohibition level

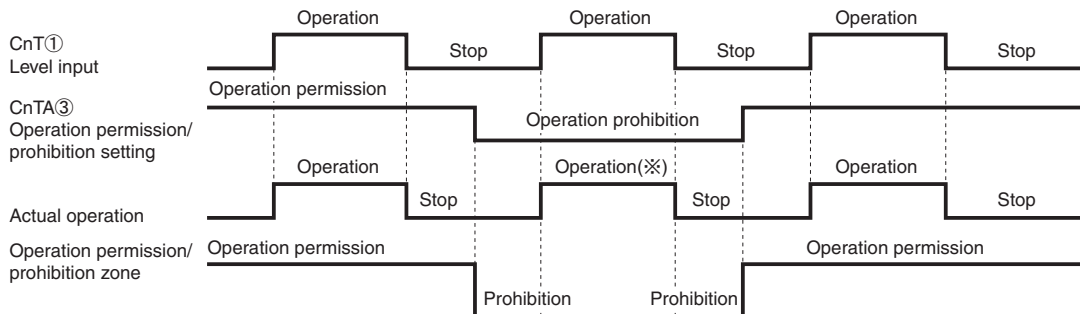

(※) CnT level input supersedes CnTA operation prohibition.

(b) In case of CnT ③ Operation permission/prohibition level + CnTA ③ Operation permission/prohibition level

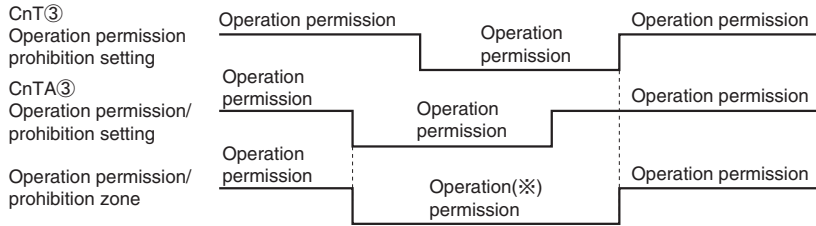

(c) In case of CnT ③ Operation permission/prohibition level > CnTA ② Operation/stop pulse

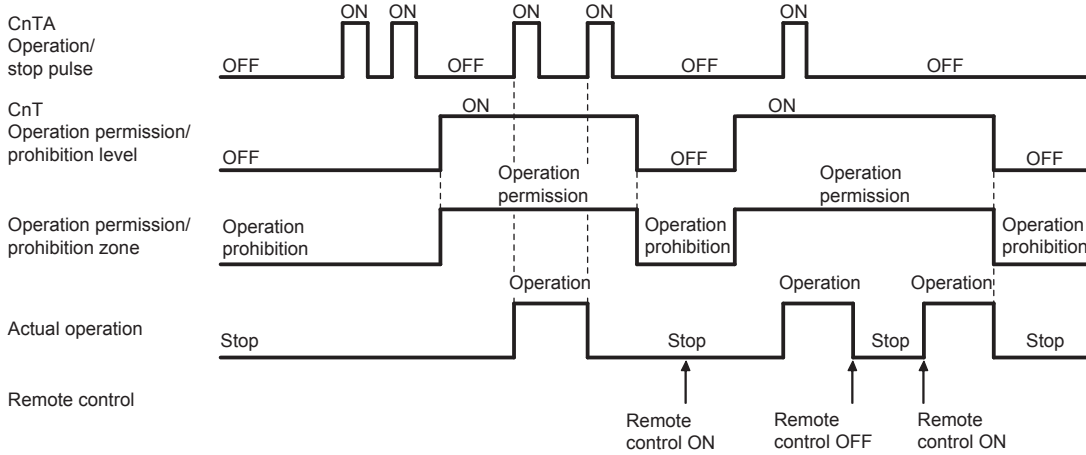

(d) In case of CnT ② Operation/stop pulse + CnTA ③ Operation permission/prohibition level

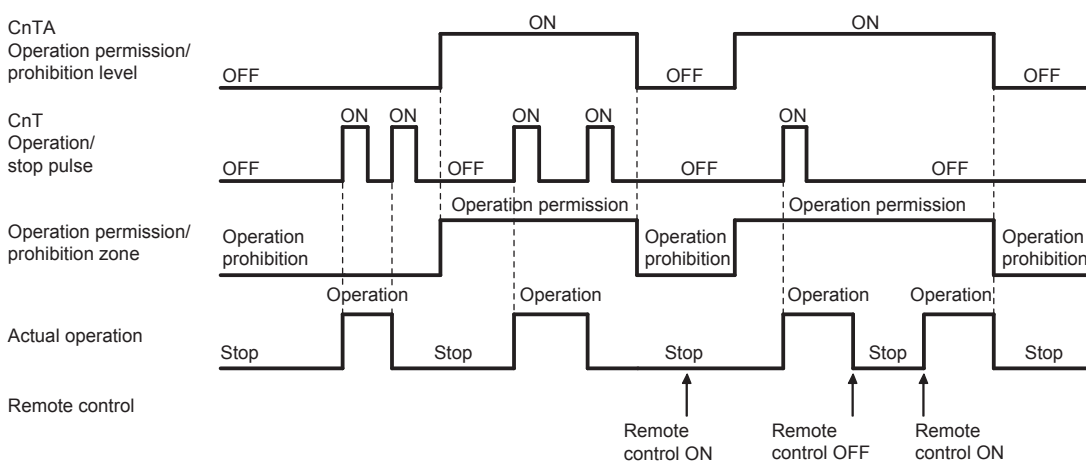

(23) Selection of cooling/heating external input function

- (a) When "External input 1 setting: Cooling/heating" is set for the indoor unit function from remote control, the cooling or heating is selected with CnT-6 or CnTA.
- (b) When the External input 1 method selection: Level input is set for the indoor unit function:
 - CnT-6 or CnTA: OPEN → Cooling operation mode
 - CnT-6 or CnTA: CLOSE → Heating operation mode
- (c) When the External input 1 method selection: Pulse input is set for the indoor unit function:

If the external input is changed OPEN → CLOSE, operation modes are inverted (Cooling → Heating or Heating → Cooling).

- (d) If the cooling/heating selection signal is given by the external input, the operation mode is transmitted to the remote control.

■ Selection of cooling/heating external input function

External input selection	External input method	Operation	
External input selection Cooling/heating selection	⑤ Level	External terminal input (CnT or CnTA)	
		Cooling/heating	
		Cooling/heating (Competitive)	
	⑥ Pulse	External terminal input (CnT or CnTA)	
		Cooling/heating	
		Cooling/heating (Competitive)	

Notes (1) Regarding the priority order for combinations of CnT and CnTA, refer to Page 121.

(24) Fan control at heating startup

- (a) Starting conditions

At the start of heating operation, if the difference of setting temperature and return air temperature is 5°C or higher after the end of hot start control, this control is performed.

- (b) Contents of control

- (i) Sampling is made at each minute and, when the indoor unit heat exchanger temperature (detected with Thi-R) is 37°C or higher, present number of revolutions of indoor unit fan speed is increased by 10min⁻¹.
- (ii) If the indoor unit heat exchanger temperature drops below 37°C at next sampling, present number of revolutions of indoor unit fan speed is reduced by 10min⁻¹.

- (c) Ending conditions

Indoor fan speed is reduced to the setting airflow volume when the compressor OFF is established and at 30 minutes after the start of heating operation.

(25) Room temperature detection temperature compensation during heating

With the standard specification, the compressor is turned ON/OFF with the thermostat setting temperature. When the thermostat is likely to turn OFF earlier because the unit is installed at the ceiling where warm air tends to accumulate, the setting can be changed with the wired remote control indoor unit function “※ SP OFFSET”. The compressor and the heater are turned ON/OFF at one of the setting temperature +3, +2 or +1°C in order to improve the feeling of heating. The setting temperature, however, has the upper limit of 30°C.

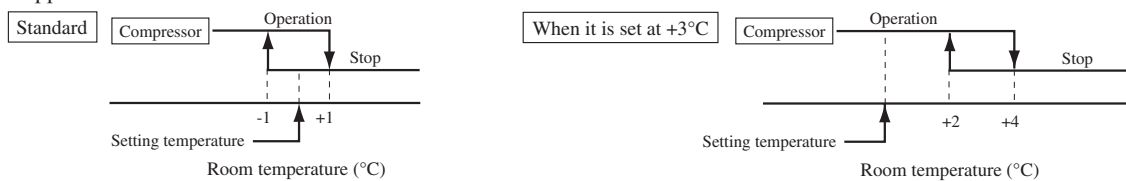

(26) Return air temperature compensation

This is the function to compensate the deviation between the detection temperature by the return air temperature thermistor and the measured temperature after installing the unit.

- (a) It is adjustable in the unit of 0.5°C with the wired remote control indoor unit function “RETURN AIR TEMP”.

- +1.0°C, +1.5°C, +2.0°C
- -1.0°C, -1.5°C, -2.0°C

- (b) Compensated temperature is transmitted to the remote control and the compressor to control them.

Note (1) The detection temperature compensation is effective on the indoor unit thermistor only.

(27) High power operation (RC-EX1A only)

It operates at with the set temp. fixed at 16°C for cooling, 30°C for heating and maximum indoor fan speed for 15 minutes maximum.

(28) Energy-saving operation (RC-EX1A only)

It operates with the setting temperature fixed at 28°C for cooling, 22°C for heating or 25°C for auto. (Maximum capacity is restricted at 80%.)

(29) Warm-up control (RC-EX1A only)

Operation will be started 5 to 60 minutes before use according to the forecast made by the microcomputer which calculates when the operation should be started in order to warm up the indoor temperature near the setting temperature at the setting time of operation start.

(30) Home leave mode (RC-EX1A only)

When the unit is not used for a long period of time, the room temperature is maintained at a moderate level, avoiding extremely hot or cool temperature.

- (a) Cooling or heating is operated according to the outdoor temperature (factory setting 35°C for cooling, 0°C for heating) and the set temperature. (factory setting 33°C for cooling, 10°C for heating)
- (b) Set temp and indoor fan speed can be set by RC-EX1A.

(31) Auto temperature setting (RC-EX1A only)

Setting temperature is adjusted automatically at the adequate temperature the center set temp. is 24°C by correcting the outdoor air temperature.

(32) Fan circulator operation (RC-EX1A only)

When the fan is used for circulation, the unit is operated as follows depending on the setting with the remote control.

- (a) If the invalid is selected with the remote control, the fan is operated continuously during the fan operation. (normal fan mode)
- (b) If the valid is selected with the remote control, the fan is operated or stopped when on the difference of the remote control temperature sensor and the indoor unit return air temperature sensor becomes bigger than 3°C.

(33) The operation judgment is executed every 5 minutes (RC-EX1A only)

Setting temperature T_s is changed according to outdoor temperature
This control is valid with cooling and heating mode. (NOT auto mode)

- (a) Operate 5 minutes forcedly.
- (b) Setting temperature is adjusted every 10 minutes.
 - (i) Cooling mode.
 $T_s = \text{outdoor temperature} - \text{offset value}$
 - (ii) Heating mode.
 $T_s = \text{outdoor temperature} + \text{offset value}$
- (c) If the return air temperature lower than 18°C or return air temperature becomes lower than 25°C, unit goes thermo OFF.

(34) Auto fan speed control (RC-EX1A only)

In order to reach the room temperature to the set temperature as quickly as possible, the airflow rate is increased when the set temperature of thermostat differs largely from the return air temperature. According to temperature difference between set temperature and return air temperature, indoor fan tap are controlled automatically.

- Auto 1: Changes the indoor unit fan tap within the range of Hi ↔ Me ↔ Lo.
- Auto 2: Changes the indoor unit fan tap within the range of PHi ↔ Hi ↔ Me ↔ Lo.

(35) Indoor unit overload alarm (RC-EX1A only)

If the following condition is satisfied at 30 minutes after starting operation, RC-EX1A shows maintenance code "M07" and the signal is transmitted to the external output (CnT-5).

- (a) Receipt of the signal by the external output is indicated by lighting an LED or other prepared on site.
 - Cooling, Dehumidifying, Auto(Cooling) : Indoor air temperature = Set room temperature by remote control + Alarm temperature difference
 - Heating, Auto(Heating) : Indoor air temperature = Set room temperature by remote control - Alarm temperature difference

Alarm temperature difference is selectable between 5 to 10°C.

- (b) If the following condition is satisfied or unit is stopped, the signal is disappeared.
 - Cooling, Dehumidifying, Auto(Cooling) : Indoor air temperature = Set room temperature + Alarm temperature difference - 2°C
 - Heating, Auto(Heating) : Indoor air temperature = Set room temperature - Alarm temperature difference + 2°C

(36) Peak-cut time (RC-EX1A only)

Power consumption can be reduced by restricting the maximum capacity.

Set the [Start time], the [End time] and the capacity limit % (Peak-cut %).

- 4-operation patterns per day can be set at maximum.
- The setting time can be changed by 5-minutes interval.
- The selectable range of capacity limit % (Peak-cut %) is from 0% to 40-80% (20% interval).
- Holiday setting is available.

11.3.2 SRK series

(1) Operation control function by wireless remote control

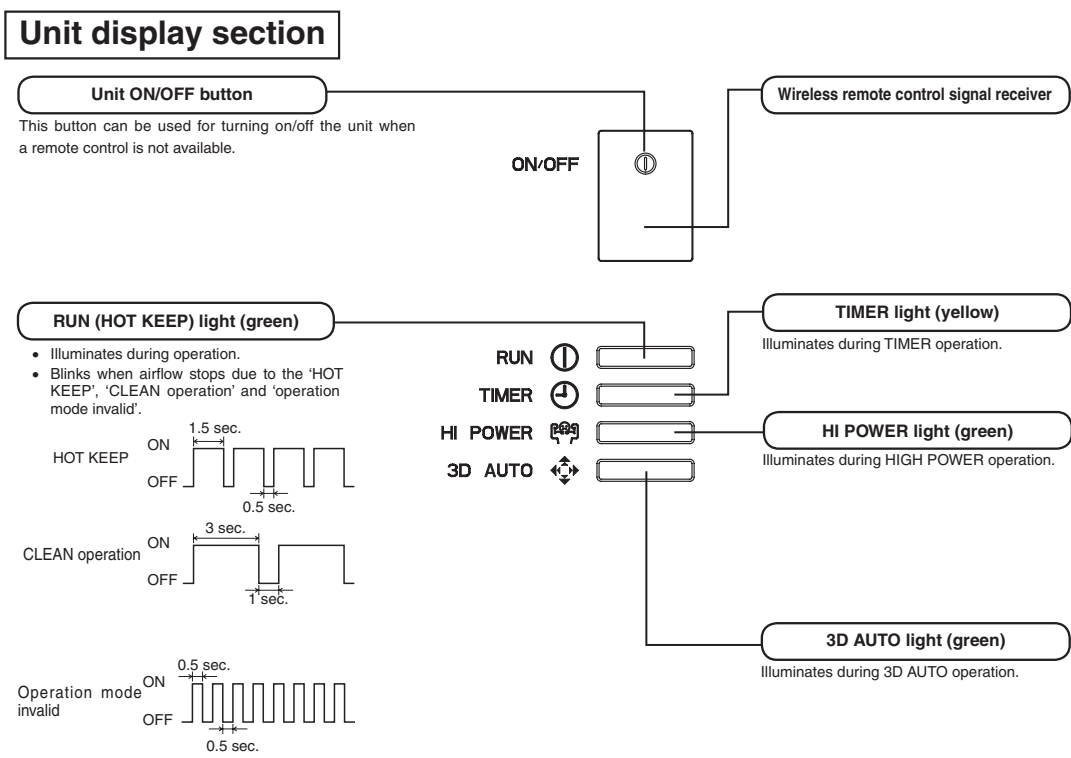
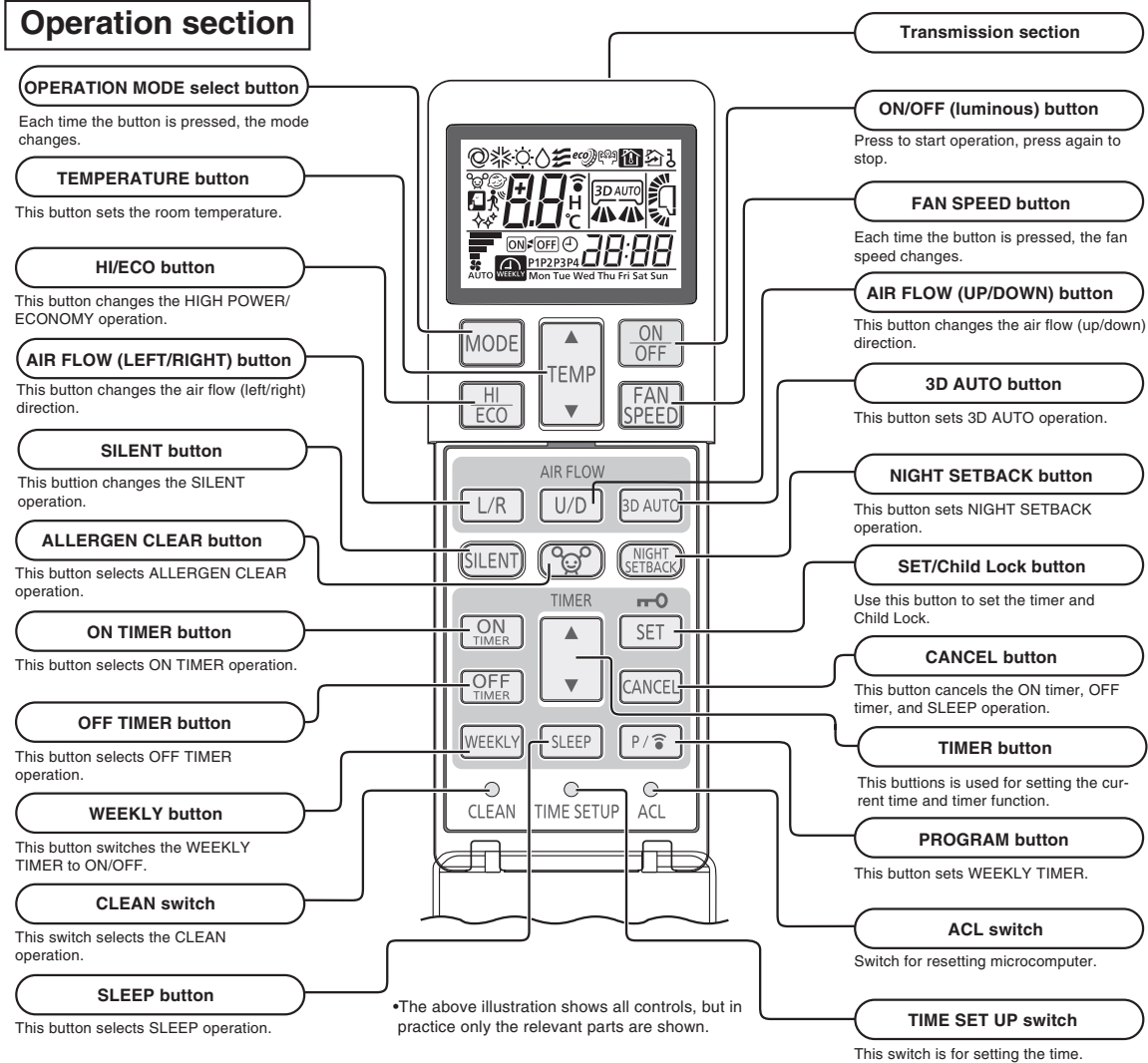

(2) Unit ON/OFF button

When the wireless remote control batteries become weak, or if the wireless remote control is lost or malfunctioning, this button may be used to turn the unit on and off.

(a) Operation

Push the button once to place the unit in the automatic mode. Push it once more to turn the unit off.

(b) Details of operation

The unit will go into the automatic mode in which it automatically determines, from indoor temperature (as detected by sensor), whether to go into COOL, DRY or HEAT modes.

Function	Indoor temperature setting	Fan speed	Flap/Louver	Timer switch
Operation mode				
COOL	About 24°C	Auto	Auto	Continuous
DRY				
HEAT				

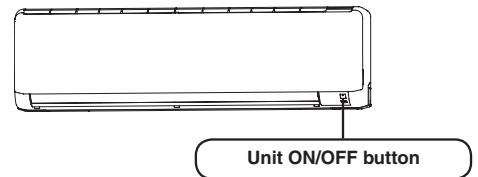

(3) Auto restart function

(a) Auto restart function records the operational status of the air-conditioner immediately prior to be switched off by a power cut, and then automatically resumes operations after the power has been restored.

(b) The following settings will be cancelled:

- (i) Timer settings
- (ii) HIGH POWER operations

- Notes
- (1) Auto restart function is set at on when the air-conditioner is shipped from the factory. Consult with your dealer if this function needs to be switched off.
 - (2) When power failure occurs, the timer setting is cancelled. Once power is resumed, reset the timer.
 - (3) If the jumper wire (JA1) "AUTO RESTART" is cut, auto restart is disabled. (See the diagram at right)

Jumper wire (JA1)

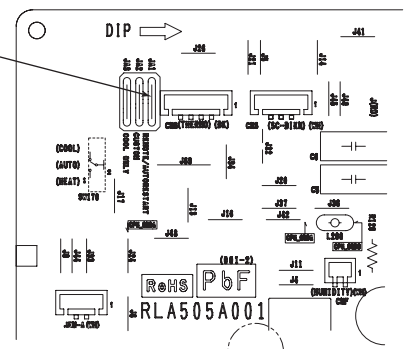

(4) Installing two air-conditioners in the same room

When two air-conditioners are installed in the room, use setting when the two air-conditioners are not operated with one wireless remote control. Set the wireless remote control and indoor unit.

(a) Setting the wireless remote control

- (i) Pull out the cover and take out batteries.
- (ii) Disconnect the switching line next to the battery with wire cutters.
- (iii) Insert batteries, Close the cover.

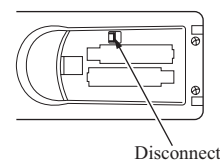

(b) Setting an indoor unit

- (i) Turn off the power source, and turn it on after 1 minute.
- (ii) Point the wireless remote control that was set according to the procedure described on the left side at the indoor unit and send a signal by pressing the ACL switch on the wireless remote control.
Since the signal is sent in about 6 seconds after the ACL switch is pressed, point the wireless remote control at the indoor unit for some time.
- (iii) Check that the reception buzzer sound "pip" is emitted from the indoor unit. At completion of the setting, the indoor unit emits a buzzer sound "pip". (If no reception tone is emitted, start the setting from the beginning again.)

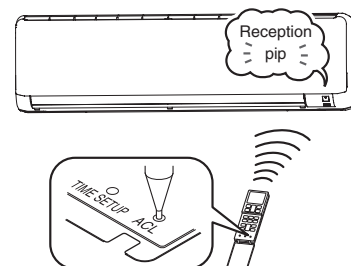

(5) Selection of the annual cooling function

- (a) The annual cooling function can be enabled or disabled by means of the jumper wire (JA3) on the indoor unit PCB and the dip switch (SW2-4) on the interface kit (option) PCB.

Jumper wire (JA3)	Interface kit (SC-BIKN-E) SW2-4	Function
Shorted	ON	Enabled
Shorted	OFF	Disabled
Open	ON	Disabled
Open	OFF	Disabled

Note: (1) Default states of the jumper wire (JA3) and the interface kit at the shipping from factory – On the PCB, the dip switch (SW2-4) is set to enable the annual cooling function.

(2) To cancel the annual cooling setting, consult your dealer.

(b) Content of control

- (i) If the outdoor air temperature sensor (TH2) detects below 5°C, the indoor fan speed is switched to 8th step. (It is not possible to change.)
- (ii) If the outdoor air temperature sensor (TH2) detects higher than 7°C, the indoor fan speed is changed to the normal control speed.

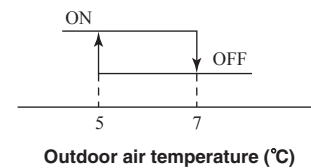
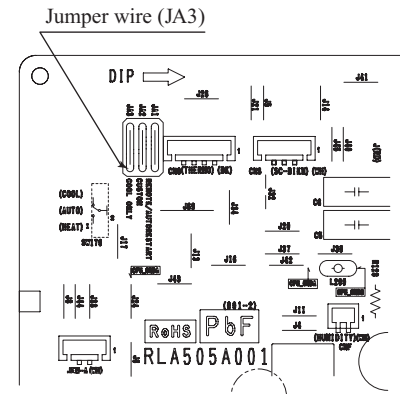
**(6) High power operation**

Pressing the HI POWER/ECONO button intensifies the operating power and initiates powerful cooling and heating operation for 15 minutes continuously. The wireless remote control displays and the FAN SPEED display disappears.

- (a) During the HIGH POWER operation, the room temperature is not controlled. When it causes an excessive cooling and heating, press the HI POWER/ECONO button again to cancel the HIGH POWER operation.
- (b) HIGH POWER operation is not available during dehumidifying and the program timer operations.
- (c) When HIGH POWER operation is set after ON TIMER operation, HIGH POWER operation will start from the set time.
- (d) When the following operation are set, HIGH POWER operation will be cancelled.
 - ① When the HI POWER/ECONO button is pressed again.
 - ② When the operation mode is changed.
 - ③ When it has been 15 minutes since HIGH POWER operation has started.
 - ④ When the 3D AUTO button is pressed.
 - ⑤ When the SILENT button is pressed.
 - ⑥ When the NIGHT SETBACK button is pressed.
- (e) Not operable while the air-conditioner is OFF.
- (f) After HIGH POWER operation, the sound of refrigerant flowing may be heard.

(7) Economy operation

Pressing the HI POWER/ECONO button initiate a soft operation with the power suppressed in order to avoid an excessive cooling or heating. The unit operate 1.0°C higher than the setting temperature during cooling or 2.0°C lower than that during heating. The wireless remote control displays ECONO mark and the FAN SPEED display disappears.

- (a) It will go into ECONOMY operation at the next time the air-conditioner runs in the following cases.
 - ① When the air-conditioner is stopped by ON/OFF button during ECONOMY operation.
 - ② When the air-conditioner is stopped in SLEEP or OFF TIMER operation during ECONOMY operation.
 - ③ When the operation is retrieved from CLEAN or ALLERGEN CLEAR operation.
- (b) When the following operation are set, ECONOMY operation will be cancelled.
 - ① When the HI POWER/ECONO button is pressed again.
 - ② When the operation mode is changed DRY to FAN.
 - ③ When the NIGHT SETBACK button is pressed.
- (c) Not operable while the air-conditioner is OFF.

(d) The setting temperature is adjusted according to the following table.

Item \ Mode	Cooling	Heating
Temperature adjustment	① +0.5	① -1.0
	② +1.0	② -2.0
	③	③

- ① at the start of operation.
- ② one hour after the start of operation.
- ③ two hours after the start of operation.

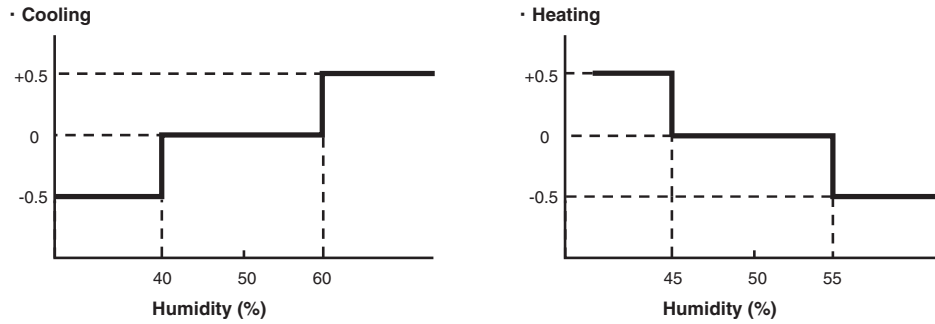

(8) Flap and louver control

Control the flap and louver by AIR FLOW U/D (UP/DOWN) and L/R (LEFT/RIGHT) button on the wireless remote control.

(a) Flap

Each time when you press the AIR FLOW U/D (UP/DOWN) button the mode changes as follows.

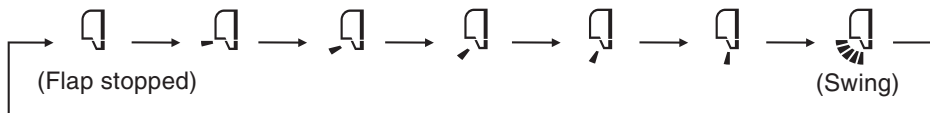

• Angle of Flap from Horizontal

Remote control display					
COOL , DRY, FAN	Approx. 5°	Approx. 20°	Approx. 35°	Approx. 50°	Approx. 70°
HEAT	Approx. 20°	Approx. 35°	Approx. 45°	Approx. 60°	Approx. 70°

(b) Louver

Each time when you press the AIR FLOW L/R (LEFT/RIGHT) button the mode changes as follows.

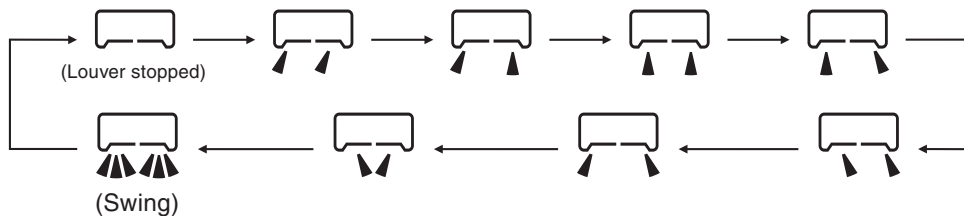

• Angle of louver

Remote control display					
Center installation	Left approx. 50°	Left approx. 20°	Center	Right approx. 20°	Right approx. 50°

(c) Swing

(i) Swing flap

Flap moves in upward and downward directions continuously.

(ii) Swing louver

Louver moves in left and right directions continuously.

◆ In HEAT operation

◆ In COOL, DRY, FAN operation

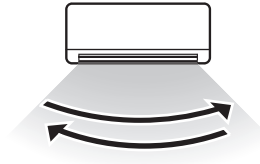
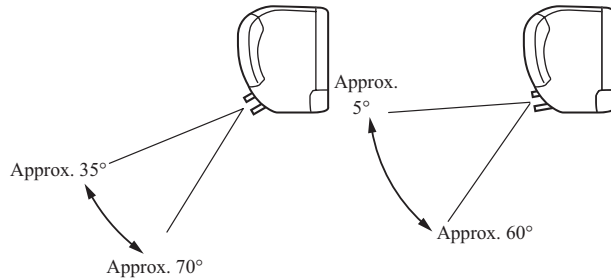

(d) Memory flap (Flap or Louver stopped)

When you press the AIR FLOW (UP/DOWN or LEFT/RIGHT) button once while the flap or louver is operating, it stops swinging at the position. Since this angle is memorized in the microcomputer, the flap or louver will automatically be set at this angle when the next operation is started.

(e) When not operating

The flap returns to the position of air flow directly below, when operation has stopped.

(9) 3D auto operation

Control the flap and louver by 3D AUTO button on the wireless remote control.

Air flow selection and air flow direction are automatically controlled, allowing the entire indoor to efficiently conditioned.

(a) During cooling and heating (Including auto cooling and heating)

(i) Air flow selection is determined according to indoor temperature and setting temperature.

Operation mode	Air flow selection					
	AUTO		HI	MED	LO	ULO
Cooling	Indoor temp. – Setting temp. >5°C	Indoor temp. – Setting temp. ≤ 5°C	HI	MED	LO	ULO
	HIGH POWER	AUTO				
Heating	Setting temp. – Indoor temp. >5°C	Setting temp. – Indoor temp. ≤ 5°C	HI	MED	LO	ULO
	HIGH POWER	AUTO				

(ii) Air flow direction is controlled according to the indoor temperature and setting temperature.

1) When 3D auto operation starts

	Cooling	Heating
Flap	Up/down swing	
Louver	Wide (Fixed)	Center (Fixed)

2) When Indoor temp. – Setting temp. is ≤ 5°C during cooling and when Setting temp. – Indoor temp. is ≤ 5°C during heating, the system switches to the following air flow direction control. After the louver swings left and right symmetrically for 3 cycles, control is switched to the control in 3).

	Cooling	Heating
Flap	Horizontal blowing (Fixed)	Slant forwardl blowing (Fixed)
Louver	Left/right swing	

3) After the flap swings for 5 cycles, control is switched to the control in 4).

	Cooling	Heating
Flap	Up/down swing	
Louver	Center (Fixed)	

4) For 5 minutes, the following air flow direction control is carried out.

	Cooling	Heating
Flap	Horizontal blowing (Fixed)	Slant forwardl blowing (Fixed)
Louver	Wide (Fixed)	

5) After 5 minutes have passed, the air flow direction is determined according to the indoor temperature and setting temperature.

Operation mode	Air flow direction control		
Cooling	Indoor temp. – Setting temp. $\leq 2^{\circ}\text{C}$	$2^{\circ}\text{C} < \text{Indoor temp.} - \text{Setting temp.} \leq 5^{\circ}\text{C}$	Indoor temp. – Setting temp. $> 5^{\circ}\text{C}$
	The control in 4) continues.	Control returns to the control in 2).	Control returns to the control in 1).
Heating	Setting temp. – Indoor temp. $\leq 2^{\circ}\text{C}$	$2^{\circ}\text{C} < \text{Setting temp.} - \text{Indoor temp.} \leq 5^{\circ}\text{C}$	Setting temp. – Indoor temp. $> 5^{\circ}\text{C}$
	The control in 4) continues.	Control returns to the control in 2).	Control returns to the control in 1).

(b) During dehumidifying operation (including auto dehumidifying operation)

Flap	Horizontal blowing (Fixed)
Louver	Wide (Fixed)

(10) Timer operation

(a) Comfortable timer setting (ON timer)

If the timer is set at ON when the operation select switch is set at the cooling or heating, or the cooling or heating in auto mode operation is selected, the comfortable timer starts and determines the starting time of next operation based on the initial value of 15 minutes and the relationship between the indoor temperature at the setting time (temperature of room temperature sensor) and the setting temperature.

(b) Sleep timer operation

Pressing the SLEEP button causes the temperature to be controlled with respect to the set temperature.

(c) OFF timer operation

The Off timer can be set at a specific time (in 10-minute units) within a 24-hour period.

(d) Weekly timer operation

Timer operation (ON timer, OFF timer) can be set up to 4 times a day for each weekday.

(11) Silent mode

As “Silent mode start” signal is received from the wireless remote control, it operates by dropping the outdoor fan tap. (Upper limit is 3rd speed)

(12) Night setback

As “Night setback” signal is received from the wireless remote control, the heating operation starts with the setting temperature at 10°C .

(13) Installation location setting

When the indoor unit is installed at the end of a room, control the air flow direction so that it is not toward the side walls. If you set the wireless remote control installation position, keep it so that the air flow is within the range shown in the following figure.

(a) Setting

(i) If the air-conditioning unit is running, press the ON/OFF button to stop.
The installation location setting cannot be made while the unit is running.

(ii) Press the AIR FLOW U/D (UP/DOWN) button and the AIR FLOW L/R (LEFT/RIGHT) button together for 5 seconds or more.

The installation location display illuminates.

(iii) Setting the air-conditioning installation location.

Press the AIR FLOW L/R (LEFT/RIGHT) button and adjust to the desired location.

Each time the AIR FLOW L/R (LEFT/RIGHT) button is pressed, the indicator is switched in the order of:

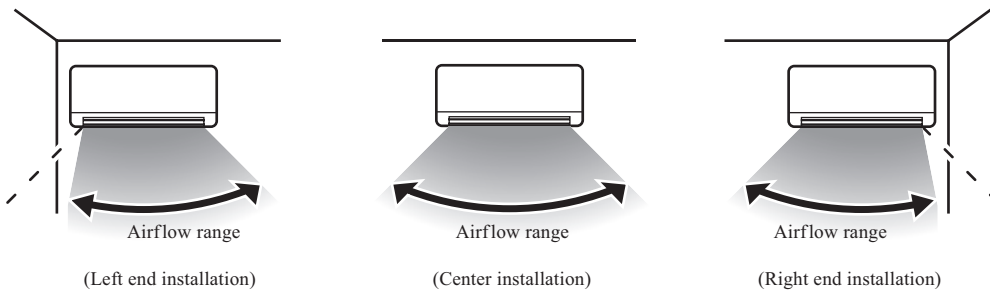

(iv) Press the ON/OFF button.

The air-conditioner's installation location is set.

Press within 60 seconds of setting the installation location (while the installation location setting display illuminates).

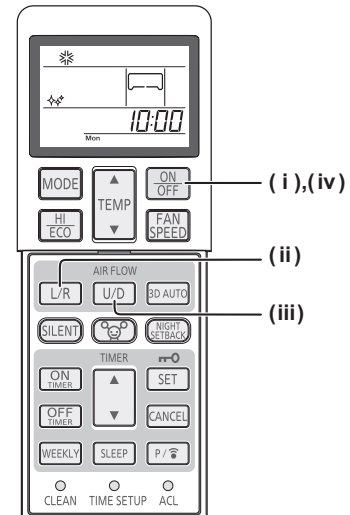

(14) Outline of heating operation

(a) Operation of major functional components in heating mode

	Heating		
	Thermostat ON	Thermostat OFF	Failure
Compressor	ON	OFF	OFF
Indoor fan motor	ON	ON(HOT KEEP)	OFF
Outdoor fan motor	ON	OFF (few minutes ON)	OFF
4-way valve	ON	ON	OFF (3 minutes ON)

(b) Details of control at each operation mode (pattern)

(i) Fuzzy operation

Deviation between the indoor temperature setting correction temperature and the return air temperature is calculated in accordance with the fuzzy rule, and used for control of the air capacity and the compressor speed.

Fan speed	Model
	SRK100ZR-S
AUTO	20-82rps
HI	20-82rps
MED	20-82rps
LO	20-74rps
ULO	20-50rps

When the defrosting, protection device, etc. is actuated, operation is performed in the corresponding mode.

(ii) Hot keep operation

If the hot keep operation is selected during the heating operation, the indoor fan speed is controlled based on the temperature of the indoor heat exchanger (Th2) to prevent blowing of cool wind.

However, if the fan speed setting is HI and room temperature is 19°C or higher, this control is not executed.

(15) Outline of cooling operation

(a) Operation of major functional components in cooling mode

	Cooling		
	Thermostat ON	Thermostat OFF	Failure
Compressor	ON	OFF	OFF
Indoor fan motor	ON	ON	OFF
Outdoor fan motor	ON	OFF (few minutes ON)	OFF (few minutes ON)
4-way valve	OFF	OFF	OFF

(b) Detail of control in each mode (Pattern)

1) Fuzzy operation

During the fuzzy operation, the air flow and the compressor speed are controlled by calculating the difference between the indoor temperature setting correction temperature and the return air temperature.

Fan speed	Model	SRK100ZR-S
AUTO		15-77rps
HI		15-77rps
MED		15-62rps
LO		15-50rps
ULO		15-30rps

(16) Outline of dry(dehumidifying) operation

(a) Purpose of DRY mode

The purpose is "Dehumidification", and not to control the humidity to the target condition.

Indoor/outdoor unit control the operation condition to reduce the humidity, and also prevent over cooling.

(b) Outline of control

(i) Indoor unit fan speed and compressor are controlled by the area which is selected by the temperature difference.

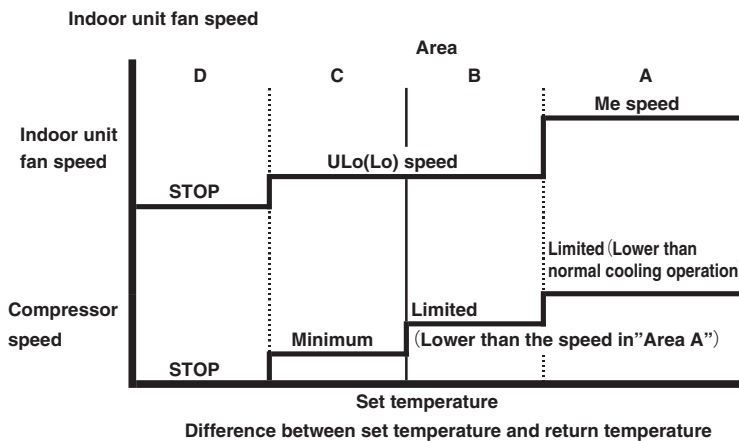

(ii) The indoor unit check the current area by every 5 minutes, and operate by the next checking.

(c) Other

When the outside temperature. and room temperature. is low for cooling operation, indoor unit can not operate in cooling, and dehumidifying. In this case, the units operate in heating to rise the room temperature and after that start dehumidifying operation.

(17) Outline of automatic operation

(a) Determination of operation mode

The unit checks the indoor air temperature and setting temperature and the outdoor air temperature, determines the operation mode, and then begins in the automatic operation.

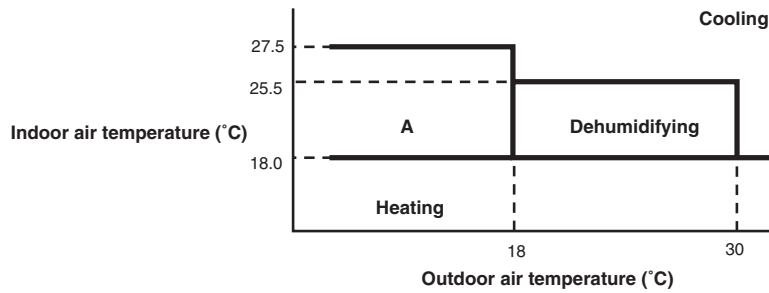

- (b) The unit checks the temperature every hour after the start of operation and, if the result of check is not same as the previous operation mode, changes the operation mode.
 - (i) If the setting temperature is changed with the remote control, the operation mode is judged immediately.
 - (ii) When both the indoor and the outdoor air temperatures are in the range “A”, cooling or heating is switched depending on the difference between the setting temperature and the indoor air temperature.
 - (iii) When the operation mode has been judged following the change of setting temperature with the remote control, the hourly judgment of operation mode is cancelled.
- (c) When the unit is started again within one hour after the stop of automatic operation or when the automatic operation is selected during heating, cooling or dehumidifying operation, the unit is operated in the previous operation mode.
- (d) Setting temperature can be adjusted within the following range. There is the relationship as shown below between the signals of the wireless remote control and the setting temperature.

Unit : °C

		Signals of wireless remote control (Display)												
		-6	-5	-4	-3	-2	-1	±0	+1	+2	+3	+4	+5	+6
Setting temperature	Cooling													
	Dehumidifying	18	19	20	21	22	23	24	25	26	27	28	29	30
	Heating													

(18) Protection control function

(a) Dew prevention control [Cooling]: Prevents dewing on the indoor unit.

- (i) **Operating conditions:** When the following conditions have been satisfied for more than 30 minutes after starting operation.
 - 1) Compressor’s command speed is 30 rps or higher.
 - 2) Detected value of humidity is 68% or higher.

(ii) Contents of operation

1) Air capacity control

Item	Model
Upper limit of compressor's command speed ⁽¹⁾	SRK100ZR-S
	Range A: As per following table, Range B: 40 rps

Note (1) Ranges A and B are as shown below.

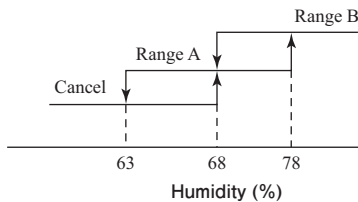

● Condition for range A

Compressor's command speed is controlled according to the indoor unit heat exchanger temperature (Th2) and the indoor unit room temperature (Th1).

Condition	Compressor's command speed
$Th2 \leq Th1 - 10$	<ul style="list-style-type: none"> Decreases the compressor's target max speed by 4 rps. If the condition is met still 20 seconds later, the speed is decreased further by 4 rps. This process is repeated further so far as the condition is met. [Lower limit is 20 rps]
$Th1 - 10 < Th2 \leq Th1 - 6$	Compressor's target max. speed or changed value of the same is maintained.
$Th2 - 6 < Th1$	Changed compressor's target max. speed is increased at a rate of 1 rps/20 seconds.

2) When this control has continued for more than 30 minutes continuously, the following wind direction control is performed.

- a) When the vertical wind direction is set at other than the vertical swing, the flaps change to the horizontal position.
- b) When the horizontal wind direction is set at other than the horizontal swing, the louver changes to the vertical position.

(iii) Reset conditions: When either of the following conditions is satisfied.

- 1) Compressor's command speed is less than 20 rps.
- 2) Detected value of humidity is less than 63%.

(b) Frost prevention control (During cooling or dehumidifying)

(i) Operating conditions

- 1) Indoor heat exchanger temperature (Th2) is lower than 5°C.
- 2) 8 minutes after reaching the compressor command speed except 0 rps.

(ii) Detail of anti-frost operation

Item	Indoor heat exchanger temperature	
	5°C or lower	2.5°C or lower
Lower limit of compressor command speed	16rps	0 rps
Indoor fan	Depends on operation mode	Protects the fan tap just before frost prevention control
Outdoor fan	Depends on command speed	Depends on stop mode
4-way valve	OFF	

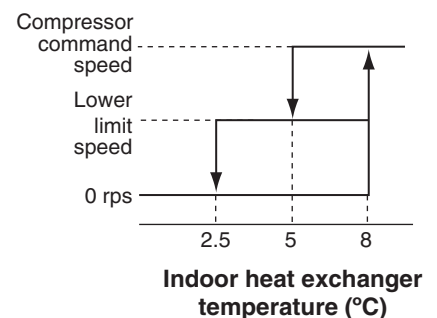

- Notes
- (1) When the indoor heat exchanger temperature is in the range of 2.5-5°C, the speed is reduced by 4 rps at each 20 seconds.
 - (2) When the temperature is lower than 2.5°C, the compressor is stopped.
 - (3) When the indoor heat exchanger temperature is in the range of 5-8°C, the compressor command speed is been maintained.

(iii) Reset conditions: When either of the following conditions is satisfied.

- 1) The indoor heat exchanger temperature (Th2) is 8°C or higher.
- 2) The compressor command speed is 0 rps.

(c) Indoor fan motor protection

When the air-conditioner is operating and the indoor fan motor is turned ON, if the indoor fan motor has operated at 300 min⁻¹ or under for more than 30 seconds, the unit enters first in the stop mode and then stops the entire system.

11.4 Operation control function by the outdoor control

(1) Compressor command speed

Unit: rps

	Cooling	Heating
Upper limit	90	90
Lower limit	15	15

(2) Compressor protection start

(a) **Operating conditions:** When the compressor is turned ON from the state of OFF.

(b) **Detail of operation:** During the protection start control, the upper limit of compressor speed is restricted to the speeds as shown in the following table.

Unit: rps

			Time after establishment of operating conditions (Including acceleration time)				
			Less than 1 min and 45 sec	Less than 3 min	Less than 5 min	Less than 9 min	9 min or more
Cooling			90	90	90	90	End of control
Heating	TH2 < 0°C	Thi-A ≥ 25°C	30	30	55	90	
		Thi-A < 25°C	55	55	55	90	
	TH2 ≥ 0°C		90	90	90	90	

(3) Outdoor unit fan control

(a) Outdoor unit fan speed and fan motor speed

Unit: min⁻¹

Fan tap	1st speed	2nd speed	3rd speed	4th speed	5th speed	6th speed	7th speed	8th speed
Fan speed	150	300	550	650	740	820	870	950

(b) Outdoor unit fan control at start (Cooling operation only)

When the outdoor air temperature (TH2) is lower than 22°C at the start of compressor, the outdoor unit fan is operated at a fixed speed.

- (i) When the outdoor air temperature is higher than 11°C, the compressor runs at 2nd speed for 30 seconds after the compressor ON.
- (ii) When the outdoor air temperature is lower than 11°C, the compressor runs at 1st speed for 30 seconds after the compressor ON.

(c) Relationship between compressor speed and outdoor unit fan speed

Outdoor unit fan speed is controlled according to the operation mode (Heating/cooling) and the compressor speed.

Unit: rps

	1st speed	2nd speed	3rd speed	4th speed	5th speed	6th speed	7th speed	8th speed
Cooling	–	–	0-21	21-32	32-44	44-49	49-70	70-
Heating	–	–	0-21	21-30	30-48	48-60	60-67	67-

(d) Outdoor fan control at low outdoor temperature

(i) Cooling

1) Operating conditions: When the outdoor air temperature (TH2) is 22°C or lower continues for 30 seconds while the compressor command speed is other than 0 rps.

2) Detail of operation: After the outdoor fan operates at A speed for 60 seconds; the corresponding outdoor heat exchanger temperature shall implement the following controls.

- Value of A

	Outdoor fan
Outdoor air temperature > 10°C	2nd speed
Outdoor air temperature ≤ 10°C	1st speed

- a) Outdoor heat exchanger temperature ≤ 22°C
After the outdoor fan speed drops (down) to 1 speed for 60 seconds; if the outdoor heat exchanger temperature is lower than 22°C, gradually reduce the outdoor fan speed by 1 speed. (Lower limit 1st speed)
- b) 22°C < Outdoor heat exchanger temperature ≤ 40°C
After the outdoor fan speed maintains for 20 seconds; if the outdoor heat exchanger temperature is 22°C-40°C, maintain outdoor fan speed again.
- c) Outdoor heat exchanger temperature > 40°C
After the outdoor fan speed rises (up) to 1 speed for 60 seconds; if the outdoor heat exchanger temperature is higher than 40°C, gradually increase outdoor fan speed by 1 speed. (Upper limit 3rd speed)

3) Reset conditions: When either of the following conditions is satisfied

- a) The outdoor air temperature (TH2) is 24°C or higher and fan speed is 3rd speed.
 - b) The compressor command speed is 0 rps.
- 4) Outdoor unit fan speed and fan motor speed

(ii) Heating

1) Operating conditions: When the outdoor air temperature (TH2) is 3°C or lower continues for 30 seconds while the compressor command speed is other than 0 rps.

2) Detail of operation: The outdoor fan is stepped up by 2 speed step at each 20 seconds. (Upper limit 8th speed)

3) Reset conditions: When either of the following conditions is satisfied

- a) The outdoor air temperature (TH2) is 5°C or higher.
- b) The compressor command speed is 0 rps.

(e) Outdoor fan control at overload

(i) Cooling

1) Operating conditions: When the outdoor air temperature (TH2) is 41°C or higher continues for 30 seconds while the compressor command speed is other than 0 rps.

2) Detail of operation: The outdoor fan is stepped up by 3 speed. (Upper limit 8th speed)

3) Reset conditions: When either of the following conditions is satisfied

- a) The outdoor air temperature (TH2) is 40°C or lower.
- b) The compressor command speed is 0 rps.

(ii) Heating

- 1) **Operating conditions:** When the outdoor air temperature (TH2) is 13°C or higher continues for 30 seconds while the compressor command speed is other than 0 rps.
- 2) **Detail of operation:** The outdoor fan stepped down to 3 speed.(Lower limit 2nd speed)
- 3) **Reset conditions:** When either of the following conditions is satisfied
 - a) The outdoor air temperature (TH2) is 11°C or lower.
 - b) The compressor command speed is 0 rps.

(f) Outdoor fan motor protection

If the outdoor fan motor has operated at 75 rpm or lower for more than 30 seconds, the compressor and fan motor are stopped.

(4) Defrost operation

- (a) Starting conditions (Defrost operation can be started only when all of the following conditions are satisfied.)
 - (i) After start of heating operation
When it elapsed 35 minutes. (Accumulated compressor operation time)
 - (ii) After end of defrost operation
When it elapsed 35 minutes. (Accumulated compressor operation time)
 - (iii) Outdoor heat exchanger sensor (TH1) temperature
When the temperature has been below -5°C for 3 minutes continuously.
 - (iv) The difference between the outdoor air sensor temperature and the outdoor heat exchanger sensor temperature (TH2-TH1)
 - The outdoor air temperature $\geq -2^\circ\text{C} : 7^\circ\text{C}$ or higher
 - $-15^\circ\text{C} < \text{The outdoor air temperature} < -2^\circ\text{C} : 4/15 \times \text{The outdoor air temperature} + 7^\circ\text{C}$ or higher
 - The outdoor air temperature $\leq -15^\circ\text{C} : -5^\circ\text{C}$ or higher

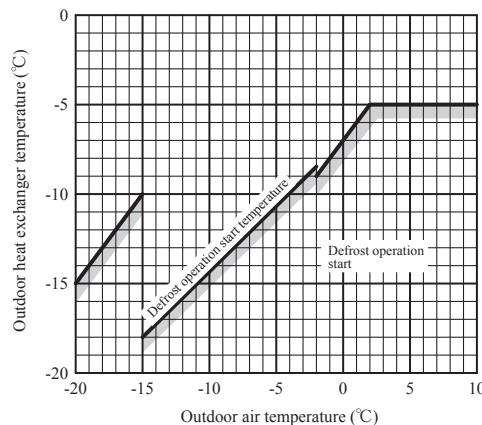

(v) During continuous compressor operation

In addition, when the speed command from the indoor control of the indoor unit during heating operation has counted 0 rps 10 times or more and all conditions of (i), (ii) above and the outdoor air temperature is 3°C or less and the temperature for outdoor heat exchanger sensor (TH1) is -5°C or less: 62 rps or more, -4°C or less: less than 62 rps are satisfied, defrost operation is started.

(b) Ending condition (Operation returns to the heating cycle when either one of the following is satisfied.)

- (i) Outdoor heat exchanger sensor (TH1) temperature: 13°C or higher
- (ii) Continued operation time of defrost operation → For more than 18 minutes.

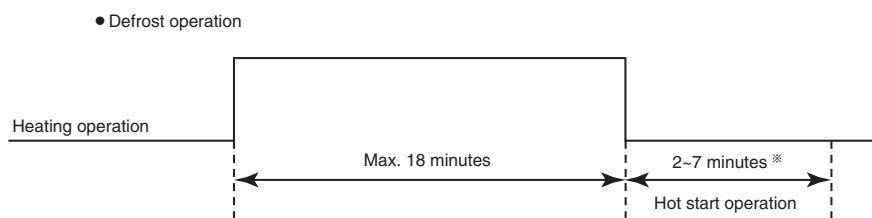

※Depends on an operation condition, the time can be longer than 7 minutes.

(5) Cooling overload protective control

(a) Operating conditions: When the outdoor air temperature (TH2) has become continuously for 30 seconds at 36°C or more, or 47°C or more with the compressor running, the lower limit speed of compressor is brought up.

Item	Model FDC100VNP	
Outdoor air temperature	36°C or more	47°C or more
Lower limit speed	20 rps	25 rps

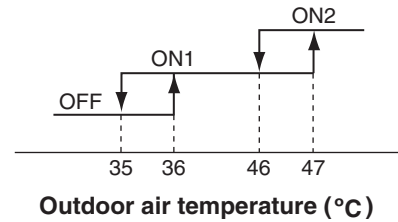

(b) Detail of operation

The lower limit of compressor command speed is set to 20 or 25 rps and even if the calculated result becomes lower than that after fuzzy calculation, the speed is kept to 20 or 25 rps. However, when the thermo OFF, the speed is reduced to 0 rps.

(c) Reset condition: When either of the following condition is satisfied.

- 1) The outdoor air temperature is lower than 35°C.
- 2) The compressor command speed is 0 rps.

(6) Cooling high pressure control

(a) Purpose: Prevents anomalous high pressure operation during cooling.

(b) Detector: Outdoor heat exchanger sensor (TH1)

(c) Detail of operation:

(Example) Fuzzy

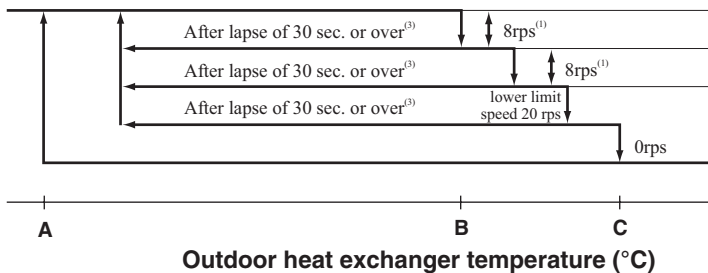

Outdoor air temperature(TH2)	A	B	C
TH2 ≥ 32°C	53	58	60
TH2 < 31°C	51	53	56

- Notes
- (1) When the outdoor heat exchanger temperature is in the range of B – C°C, the compressor command speed is reduced by 8 rps at each 20 seconds.
 - (2) When the temperature is C °C or higher, the compressor is stopped.
 - (3) When the outdoor heat exchanger temperature is in the range of A – B°C, if the compressor command speed is been maintained and the operation has continued for more than 30 seconds at the same speed, it returns to the normal cooling operation.

(7) Cooling low outdoor temperature protective control

(a) Operating condition: When the outdoor air temperature (TH2) is C°C or lower continues for 20 seconds while the compressor command speed is other than 0 rps.

(b) Detail of operation:

- (i) The lower limit of the compressor command speed is set to 40 (A) rps and even if the speed becomes lower than 40 (A) rps, the speed is kept to 40 (A) rps. However, when the thermo OFF, the speed is reduced to 0 rps.
- (ii) The upper limit of the compressor command speed is set to 50 (65) rps and even if the calculated result becomes higher than that after fuzzy calculation, the speed is kept to 50 (65) rps.

Note (1) Values in () are for outdoor air temperature is C or D

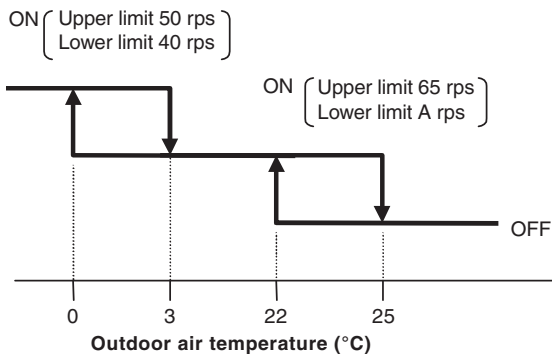

● Value of A	
	A
Outdoor air temperature ≥ 26°C	Release
Outdoor air temperature < 24°C	25

(iii) Reset condition: When either of the following condition is satisfied

- 1) The outdoor air temperature (TH2) is 25 °C or higher.
- 2) The compressor command speed is 0 rps.

(8) Heating high pressure control

- (a) **Starting condition:** When the indoor heat exchanger temperature (Thi-R1, R2) has risen to a specified temperature while the compressor is turned on.
- (b) Compressor command speed is controlled according to the zones of indoor heat exchanger temperature as shown by the following table.

	Thi-R < P1	P1 ≤ Thi-R < P2	P2 ≤ Thi-R < P3	P3 ≤ Thi-R
Protection control speed (NP)	Normal	Retention	NP-4rps	NP-8rps
Sampling time (s)	Normal	20	20	20

Unit: °C

NP	Thi-R	P1	P2	P3
10 ≤ NP < 90		45	52	57
90 ≤ NP < 120		45 - 43	52 - 45	57 - 48
120 ≤ NP		43	45	48

(9) Heating overload protective control I

- (a) **Operating conditions :** When the outdoor air temperature (TH2) is 13°C or higher continues for 30 seconds while the compressor command speed is other than 0 rps.
- (b) **Detail of operation**
 - (i) Taking the upper limit of compressor command speed range at 65(35)rps, if the output speed obtained with the fuzzy calculation exceeds the upper limit, the upper limit value is maintained.
 - (ii) The lower limit of compressor command speed is set to 25(30)rps and even if the calculated result becomes lower than that after fuzzy calculation, the speed is kept to 25(30)rps. However, when the thermo OFF, the speed is reduced to 0 prs

Note (1) Values in () are for outdoor air temperature at 17°C.

- (c) **Reset condition:** The outdoor air temperature (TH2) is lower than 11°C

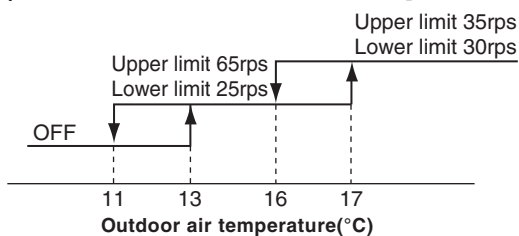

(10) Heating overload protective control II

- (a) **Starting condition :** When the indoor heat exchanger temperature (Thi-R) has risen to a specified temperature while the compressor is turned on.
- (b) **Detail of operation :** The lower limit of compressor command speed is set to 20rps.

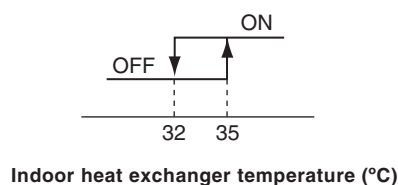

(11) Heating low outdoor temperature protective control

(a) Operating conditions : When the outdoor air temperature (TH2) is 4°C or lower continues for 30 seconds while the compressor command speed is other than 0 rps.

(b) Detail of operation : The lower limit compressor command speed is change as shown in the figure below.

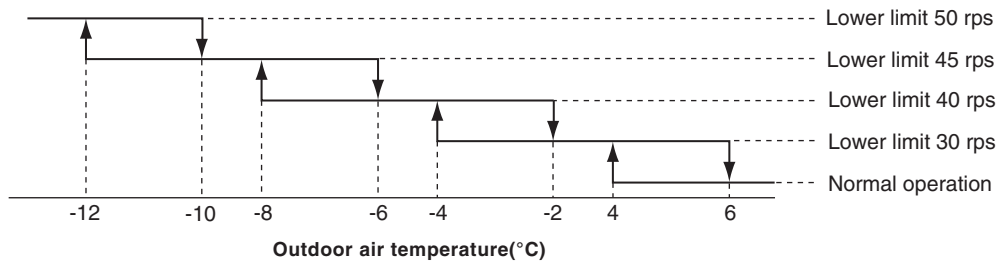

(c) Reset condition: When either of the following condition is satisfied.

- (i) The outdoor air temperature (TH2) is higher than 6°C
- (ii) The compressor command speed is 0 rps.

(12) Compressor overheat protection

(a) Purpose: It is designed to prevent deterioration of oil, burnout of motor coil and other trouble resulting from the compressor overheat.

(b) Detail of operation

- (i) Speeds are controlled with temperature detected by the sensor mounted on the discharge pipe.

(Example) Fuzzy

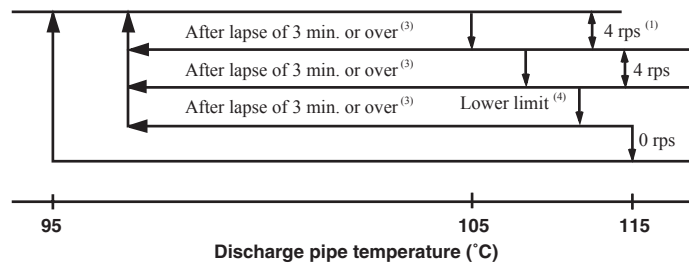

- Notes
- (1) When the discharge pipe temperature is in the range of 105-115°C, the speed is reduced by 4 rps.
 - (2) When the discharge pipe temperature is raised and continues operation for 20 seconds without changing, then the speed is reduced again by 4 rps.
 - (3) If the discharge pipe temperature is in the range of 95-105°C even when the compressor command speed is maintained for 3 minutes when the temperature is in the range of 95-105°C, the speed is raised by 1 rps and kept at that speed for 3 minutes. This process is repeated until the command speed is reached.
 - (4) Lower limit speed

	Cooling	Heating
Lower limit speed	20 rps	25 rps

- (ii) If the temperature of 115°C is detected by the sensor on the discharge pipe, then the compressor will stop immediately. When the discharge pipe temperature drops and the time delay of 3 minutes is over, the unit starts again within 1 hour but there is no start at the third time.

(13) Current safe

(a) Purpose: Current is controlled not to exceed the upper limit of the setting operation current.

(b) Detail of operation: Input current to the converter is monitored with the current sensor fixed on the printed circuit board of the outdoor unit and, if the operation current value reaches the limiting current value, the compressor command speed is reduced.

If the mechanism is actuated when the compressor command speed is less than 20 rps, the compressor is stopped immediately. Operation starts again after a delay time of 3 minutes.

(14) Current cut

(a) **Purpose:** Inverter is protected from overcurrent.

(b) **Detail of operation:** Output current from the inverter is monitored with a shunt resistor and, if the current exceeds the setting value, the compressor is stopped immediately. Operation starts again after a delay time of 3 minutes.

(15) Outdoor unit failure

This is a function for determining when there is trouble with the outdoor unit during air conditioning.

The compressor is stopped if any one of the following in item (a), (b) is satisfied. Once the unit is stopped by this function, it is not restarted.

(a) When the input current is measured at 1 A or less for 3 continuous minutes or more.

(b) If the outdoor unit sends a 0 rps signal to the indoor unit 3 times or more within 20 minutes of the power being turned on.

(16) Serial signal transmission error protection

(a) **Purpose:** Prevents malfunction resulting from error on the indoor ↔ outdoor signals.

(b) **Detail of operation:** If the compressor is operating and a serial signal cannot be received from the indoor control with outdoor control having serial signals continues for 7 minute and 35 seconds, the compressor is stopped.

After the compressor has been stopped, it will be restarted after the compressor start delay if a serial signal can be received again from the indoor control.

(17) Rotor lock

If the motor for the compressor does not turn after it has been started, it is determined that a compressor lock has occurred and the compressor is stopped.

(18) Refrigeration cycle system protection**(a) Starting conditions**

(i) When S minutes have elapsed after the compressor ON or the completion of the defrost control

(ii) Other than the defrost control

(iii) When, after meeting the conditions of (i) and (ii) above, the compressor speed, indoor air temperature (Thi-A) and indoor heat exchanger temperature (Thi-R) have met the conditions in the following table for 5 minutes:

Operation mode	S (min)	Compressor speed (N)	Indoor air temperature (Thi-A)	Indoor air temperature (Thi-A)/ Indoor heat exchanger temperature (Thi-R)
Cooling	5	$30 \leq N$	$10 \leq \text{Thi-A} \leq 40$	$\text{Thi-A} - 4 < \text{Thi-R}$
Heating	5	$30 \leq N$	$0 \leq \text{Thi-A} \leq 40$	$\text{Thi-A} + 6 > \text{Thi-R}$

(b) Contents of control

(i) When the conditions of (a) above are met, the compressor stops.

(ii) Error stop occurs when the compressor has stopped 3 times within 60 minutes.

(c) Resetting condition

When the compressor has been turned OFF

(19) Silent mode

As “Silent mode start” signal is received from the remote control, it operates by dropping the outdoor fan tap.

	Outdoor fan tap (Upper limit)
Cooling	3rd speed
Heating	3rd speed

(20) Broken wire detection on temperature sensor**(a) Outdoor unit heat exchanger sensor, outdoor air sensor**

If the following is detected for 5 second continuously within 2 minutes to 2 minutes and 20 seconds after the compressor ON, the compressor stops. After a delay of 3 minutes, it restarts but, if the same is detected repeatedly 3 times within 40 minutes, the compressor stops with the anomalous stop. Or with in 20 seconds after power ON.

Note (1) During defrosting and for 3 minutes after the end of defrosting, it is not detected.

- Outdoor unit heat exchanger sensor: -55°C or lower
- Outdoor air temperature sensor: -55 or lower

(b) Discharge pipe temperature sensor

If the following is detected for 5 second continuously within 10 minutes to 10 minutes and 20 seconds after the compressor ON, the compressor stops. After a delay of 3 minutes, it restarts but, if the same is detected repeatedly 3 times within 40 minutes, the compressor stops with the anomalous stop.

Note (1) During defrosting and for 3 minutes after the end of defrosting, it is not detected.

- Discharge pipe temperature sensor: -25°C or lower

(21) Base heater ON/OFF output control (Option)**(a) Base heater ON conditions**

When all of following conditions are met, the base heater is turned ON.

- (i) Outdoor air temperature (detected with Tho-A) is 3°C or lower.
- (ii) In the heating mode
- (iii) When the compressor is turned ON

(b) Base heater OFF conditions

When either one of following conditions is met, the base heater is turned OFF.

- (i) Outdoor air temperature (detected with Tho-A) is 5°C or higher.
- (ii) When the compressor stop has been detected for 30 minutes continuously
- (iii) In the cooling or dehumidifying mode

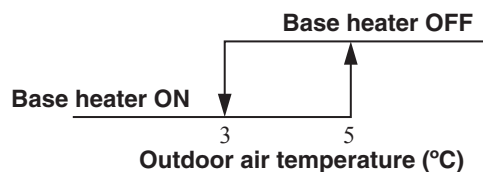
**(22) Reverse operation start for compressor protection**

(a) Purpose : It is designed to prevent compressor failure at heating mode.

(b) Detail of operation

When the outdoor air temperature (TH2) is 10°C or lower and compressor is not operated for long time, the unit start cooling mode up to 7 minutes at heating mode.

(c) Method for disabling this operation.

When outdoor unit is installed higher than indoor unit, you can disable this control by cutting jumper (J2) of PCB of outdoor unit.

Notes(1) Unit may failure if you disable this control without above installation condition.

12. MAINTENANCE DATA

12.1 FDT, FDE, FDU, FDUM, FDF series

12.1.1 Diagnosing of microcomputer circuit

(1) Selfdiagnosis function

(a) Check indicator table

Whether a failure exists or not on the indoor unit can be know by the contents of remote control error code, indoor unit green LED (power pilot lamp and microcomputer normality pilot lamp) or red LED (check pilot lamp).

(i) Indoor unit

In case of these indoor unit errors, the outdoor control PCB Red LED stays OFF.

Remote control		Indoor control PCB		Location of trouble	Description of trouble	Repair method	Reference page
Error code	Red LED	Red LED	Green LED (1)				
No-indication	Stays OFF	Stays OFF	Keeps flashing	—	• Normal operation	—	—
		Stays OFF	Stays OFF	Indoor unit power source	• Power OFF, broken wire/blown fuse, broken transformer wire	Repair	167
		* 3-time flash	Keeps flashing	Remote control wires	• Poor connection, breakage of remote control wire * For wire breaking at power ON, the LED is OFF.	Repair	168
		Remote control	• Defective remote control PCB	Replacement of remote control			
WAIT or INSPECT I/U		Stays OFF	Keeps flashing	Indoor-outdoor units connection wire	• Poor connection, breakage of indoor-outdoor units connection wire	Repair	169-173
				Remote control	• Improper setting of master and slave by remote control		
E1	Stays OFF	* Keeps flashing	Keeps flashing	Remote control wires (Noise)	• Poor connection of remote control signal wire (White) * For wire breaking at power ON, the LED is OFF	Repair	174
				Remote control indoor control PCB	* Defective remote control or indoor control PCB (defective communication circuit)?	Replacement of remote control or PCB	
E5	2-time flash	Keeps flashing	Keeps flashing	Indoor-outdoor units connection wire	• Poor connection of wire between indoor-outdoor units during operation (disconnection, loose connection) • Anomalous communication between indoor-outdoor units by noise, etc.	Repair	175
				(Noise)	• CPU-runaway on outdoor control PCB	Power reset or Repair	
				Outdoor control PCB	* Occurrence of defective outdoor control PCB on the way of power source (defective communication circuit)?	Replacement of PCB	
E6	1-time flash	Keeps flashing	Keeps flashing	Outdoor control PCB	• Defective outdoor control PCB on the way of power source	Replacement	176
				Fuse	• Blown fuse		
E7	1-time flash	Keeps flashing	Keeps flashing	Indoor heat exchanger temperature thermistor	• Defective indoor heat exchanger temperature thermistor (defective element, broken wire, short-circuit) • Poor contact of temperature thermistor connector	Replacement, repair of temperature thermistor	177
				Indoor control PCB	* Defective indoor control PCB (Defective temperature thermistor input circuit)?	Replacement of PCB	
E8	1-time flash	Keeps flashing	Keeps flashing	Installation or operating condition	• Heating over-load (Anomalously high indoor heat exchanger temperature)	Repair	178
				Indoor heat exchanger temperature thermistor	• Defective indoor heat exchanger temperature thermistor (short-circuit)	Replacement of temperature thermistor	
				Indoor control PCB	* Defective indoor control PCB (Defective temperature thermistor input circuit)?	Replacement of PCB	
E9	1-time flash	Keeps flashing	Keeps flashing	Drain trouble	• Defective drain pump (DM), broken drain pump wire, disconnected connector	Replacement, repair of DM	179
				Float switch	• Anomalous float switch operation (malfunction)	Repair	
				Indoor control PCB	* Defective indoor control PCB (Defective float switch input circuit) * Defective indoor control PCB (Defective DM drive output circuit)?	Replacement of PCB	
				Option	• Defective optional parts (At optional anomalous input setting)	Repair	
E10	Stays OFF	Keeps flashing	Keeps flashing	Number of connected indoor units	• When multi-unit control by remote control is performed, the number of units is over	Repair	180
E11	Keeps flashing	Keeps flashing	Keeps flashing	Address setting error	• Address setting error of indoor units	Repair	181
E16	1(2)-time flash	Keeps flashing	Keeps flashing	Fan motor	• Defective fan motor	Replacement, repair	182
				Indoor power PCB	• Defective indoor power PCB	Replacement	
E19	1-time flash	Keeps flashing	Keeps flashing	Indoor control PCB	• Improper operation mode setting	Repair	183

Remote control		Indoor control PCB		Location of trouble	Description of trouble	Repair method	Reference page
Error code	Red LED	Red LED	Green LED (1)				
E20	Keeps flashing	1(2)-time flash	Keeps flashing	Fan motor	• Defective by rotation speed of fan motor	Replacement, repair	184
				Indoor power PCB	• Defective indoor power PCB	Replacement	
E21		1-time flash	Keeps flashing	Panel switch detection	• Defective panel switch operation (FDT only)	Repair	185
E28	Stays OFF	Keeps flashing	Remote control temperature thermistor	• Broken wire of remote control temperature thermistor	Repair	186	

Notes (1) **Normal indicator lamp (Indoor unit: Green) extinguishes (or lights continuously) only when CPU is anomalous. It keeps flashing in any trouble other than anomalous CPU.**

(2) * mark in the description of trouble means that, in ordinary diagnosis, it cannot identify the cause definitely, and, if the trouble is repaired by replacing the part, it is judged consequently that the replaced part was defective.

(ii) Outdoor unit

Remote control		Indoor control PCB		Location of trouble	Description of trouble	Repair method	Reference page	
Error code	Red LED	Red LED	Green LED					
E35	Keeps flashing	Stays OFF	Keeps flashing	Installation, operation status	• Higher outdoor heat exchanger temperature	Repair	187	
				Outdoor heat exchanger temperature sensor	• Defective outdoor heat exchanger temperature sensor	Replacement, repair of temperature sensor		
				Outdoor control PCB	* Defective outdoor control PCB (Defective temperature sensor input circuit)?	Replacement of PCB		
E36		Stays OFF	Keeps flashing	Keeps flashing	Installation, operation status	• Higher discharge temperature	Repair	188
					Discharge pipe temperature sensor	• Defective discharge pipe temperature sensor	Replacement, repair of temperature sensor	
					Outdoor control PCB	* Defective outdoor control PCB (Defective temperature sensor input circuit)?	Replacement of PCB	
E37		Stays OFF	Keeps flashing	Keeps flashing	Outdoor heat exchanger temperature sensor	• Defective outdoor heat exchanger temperature sensor, broken wire or poor connector connection	Replacement, repair of temperature sensor	189
					Outdoor control PCB	* Defective outdoor control PCB (Defective temperature sensor input circuit)?	Replacement of PCB	
E38		Stays OFF	Keeps flashing	Keeps flashing	Outdoor air temperature sensor	• Defective outdoor air temperature sensor, broken wire or poor connector connection	Replacement, repair of temperature sensor	190
					Outdoor control PCB	* Defective outdoor control PCB (Defective temperature sensor input circuit)?	Replacement of PCB	
E39	Stays OFF	Keeps flashing	Keeps flashing	Discharge pipe temperature sensor	• Defective discharge pipe temperature sensor, broken wire or poor connector connection	Replacement, repair of temperature sensor	191	
				Outdoor control PCB	* Defective outdoor control PCB (Defective temperature sensor input circuit)?	Replacement of PCB		
E42	Stays OFF	Keeps flashing	Keeps flashing	Outdoor control PCB, compressor	• Current cut (Anomalous compressor over-current)	Replacement of PCB	192 • 193	
				Installation, operation status	• Service valve closing operation	Repair		
E47	Stays OFF	Keeps flashing	Keeps flashing	Outdoor control PCB	• Over voltage	Repair	194	
					• Defective active filter	PCB replacement		
E48	Stays OFF	Keeps flashing	Keeps flashing	Fan motor	• Defective fan motor	Replacement	195	
				Outdoor control PCB	• Defective outdoor control PCB			
E51	Stays OFF	Keeps flashing	Keeps flashing	Power transistor error (outdoor control PCB)	• Power transistor error	Replacement of PCB	196	
E57	Stays OFF	Keeps flashing	Keeps flashing	Operation status	• Shortage in refrigerant quantity	Repair	197	
				Installation status	• Service valve closing operation	Service valve opening check		
E58	Stays OFF	Keeps flashing	Keeps flashing	• Overload operation • Overcharge • Compressor locking	• Current safe stop	Replacement	198	
E59	Stays OFF	Keeps flashing	Keeps flashing	Compressor, outdoor control PCB	• Anomalous compressor startup • Voltage drop	Replacement	199	
E60	Stays OFF	Keeps flashing	Keeps flashing	Compressor	• Anomalous compressor rotor lock	Replacement	200	

Note (1) * mark in the description of trouble means that, in ordinary diagnosis, it cannot identify the cause definitely, and, if the trouble is repaired by replacing the part, it is judged consequently that the replaced part was defective.

(iv) Display sequence of error codes or inspection indicator lamps

■ Occurrence of one kind of error

Displays are shown respectively according to errors.

■ Occurrence of plural kinds of error

Section	Category of display
Error code on remote control	<ul style="list-style-type: none"> Displays the error of higher priority (When plural errors are persisting)
Red LED on indoor control PCB	<p style="text-align: center;"><i>E1 E5E10 >E35 >.....E60</i></p> <ul style="list-style-type: none"> Displays the present errors. (When a new error has occurred after the former error was reset.)

■ Error detecting timing

Section	Error description	Error code	Error detecting timing
Indoor	Drain trouble (Float switch activated)	<i>E9</i>	Whenever float switch is activated after 30 second had past since power ON.
	Communication error at initial operation	“ WAIT ”	No communication between indoor and outdoor units is established at initial operation.
	Remote control communication circuit error	<i>E1</i>	Communication between indoor unit and remote control is interrupted for mote than 2 minutes continuously after initial communication was established.
	Communication error during operation	<i>E5</i>	Communication between indoor and outdoor units is interrupted for mote than 2 minutes continuously after initial communication was established.
	Excessive number of connected indoor units by controlling with one remote control	<i>E10</i>	Whenever excessively connected indoor units is detected after power ON.
	Return air temperature thermistor anomaly	<i>E7</i>	-50°C or lower is detected for 5 seconds continuously within 60 minutes after initial detection of this anomalous temperature.
	Indoor heat exchanger temperature thermistor anomaly	<i>E6</i>	-50°C or lower is detected for 5 seconds continuously within 60 minutes after initial detection of this anomalous temperature. Or 70°C or higher is detected for 5 seconds continuously.
Outdoor	Outdoor air temperature sensor anomaly	<i>E38</i>	-55°C or lower is detected for 5 seconds continuously 3 times within 40 minutes after initial detection of this anomalous sensor. Or -55°C or lower is detected for 5 seconds continuously within 20 seconds after power ON.
	Outdoor heat exchanger temperature sensor anomaly	<i>E37</i>	-55°C or lower is detected for 5 seconds continuously 3 times within 40 minutes after initial detection of this anomalous sensor. Or -55°C or lower is detected for 5 seconds continuously within 20 seconds after power ON.
	Discharge pipe temperature sensor anomaly	<i>E39</i>	-25°C or lower is detected for 5 seconds continuously 3 times within 40 minutes after initial detection of this anomalous sensor.

■ **Error log and reset**

Error indicator	Memorized error log	Reset
Remote control display	• Higher priority error is memorized.	• Stop the unit by pressing the ON/OFF switch of remote control. • If the unit has recovered from anomaly, it can be operated.
Red LED on indoor control PCB	• Not memorized.	

■ **Resetting the error log**

- Resetting the memorized error log in the remote control
Holding down “CHECK” button, press “TIMER” button to reset the error log memorized in the remote control.
- Resetting the memorized error log in the indoor unit
The remote control transmits error log erase command to the indoor unit when “VENTI” button is pressed while holding down “CHECK” button.
Receiving the command, the indoor unit erase the log and answer the status of no error.

(2) **Troubleshooting procedure**

When any trouble has occurred, inspect as follows. Details of respective inspection method will be described on later pages.

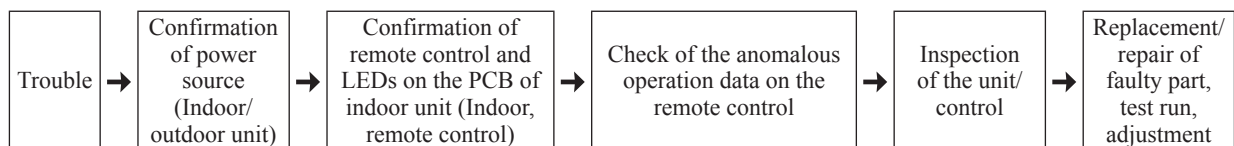

(3) **Troubleshooting at the indoor unit**

With the troubleshooting, find out any defective part by checking the voltage (AC, DC), resistance, etc. at respective connectors at around the indoor PCB, according to the inspection display or operation status of unit (the compressor does not run, fan does not run, the 4-way valve does not switch, etc.), and replace or repair in the unit of following part.

(a) **Replacement part related to indoor PCB's**

Control PCB, power source PCB, temperature thermistor (return air, indoor heat exchanger), remote control switch and fuse

Note (1) With regard to parts of high voltage circuits and refrigeration cycle, judge it according to ordinary inspection methods.

(b) **Instruction of how to replace indoor control PCB**

SAFETY PRECAUTIONS

- Read the "SAFETY PRECAUTIONS" carefully first of all and then strictly follow it during the replacement in order to protect yourself.
- The precautionary items mentioned below are distinguished into two levels, WARNING and CAUTION. Both mentions the important items to protect your health and safety so strictly follow them by any means.

	WARNING	Wrong installation would cause serious consequences such as injuries or death.
	CAUTION	Wrong installation might cause serious consequences depending on circumstances.

- After completing the replacement, do commissioning to confirm there are no anomaly.

WARNING

- Replacement should be performed by the specialist.
If you replace the PCB by yourself, it may lead to serious trouble such as electric shock or fire.
- Replace the PCB correctly according to these instructions.
Improper replacement may cause electric shock or fire.
- Shut off the power before electrical wiring work.
Replacement during the applying the current would cause the electric shock, unit failure or improper running.
It would cause the damage of connected equipment such as fan motor, etc.
- Fasten the wiring to the terminal securely, and hold the cable securely so as not to apply unexpected stress on the terminal.
Loose connections or hold could result in abnormal heat generation or fire.
- Check the connection of wiring to PCB correctly before turning on the power, after replacement.
Defectiveness of replacement may cause electric shock or fire.

CAUTION

- In connecting connector onto the PCB, connect not to deform the PCB. It may cause breakage or malfunction.
- Insert connector securely, and hook stopper. It may cause fire or improper running.
- Bundle the cables together so as not to be pinched or be tensioned. It may cause malfunction or electric shock for disconnection or deformation.

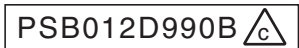

(i) Models FDT, FDE, FDU, FDUM series

1) Control PCB

Replace and set up the PCB according to this instruction.

- a) Set to an appropriate address and function using switch on PCB.
Select the same setting with the removed PCB.

item	switch	Content of control	
Address	SW2	Plural indoor units control by 1 remote control	
Test run	SW7-1	OFF	Normal
		ON	Operation check/drain motor test run

- b) Set to an appropriate capacity using the model selector switch(SW6).
Select the same capacity with the PCB removed from the unit.

SW6	-1	-2	-3	-4
100V	ON	ON	OFF	ON

- c) Replace the PCB
 - i) Exchange PCB after detaching all connectors connected with the PCB.
 - ii) Fix the PCB so as not to pitch the wiring.
 - iii) Connect connectors to the PCB. Match the wiring connector to the connector color on the PCB and connect it.
- d) Control PCB
Parts mounting are different by the kind of PCB.

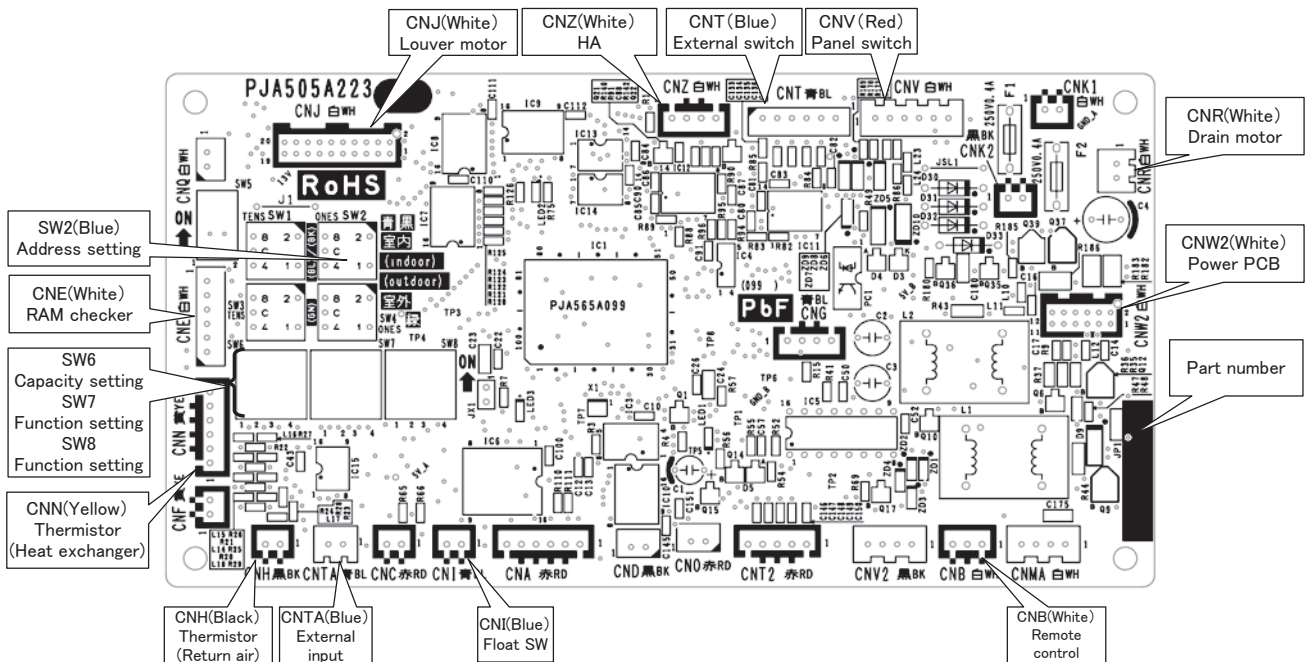

2) Power PCB

a) Models FDT, FDE, FDUM series

This PCB is a general PCB. Replace the PCB according to this instruction.

i) Replace the PCB

- ① Unscrew terminal of the wiring(yellow/green) connected to Terminal block (CNWO) from the box.
- ② Replace the PCB only after all the wirings connected to the connector are removed.
- ③ Fix the board such that it will not pinch any of the wires.
- ④ Reconnect the wirings to the PCB. Wiring connector color should match with the color of connector of the PCB.
- ⑤ Screw back the terminal of wiring, that was removed in 1.

ii) Power PCB

Parts mounting are different by the kind of PCB.

• Models FDT, FDE

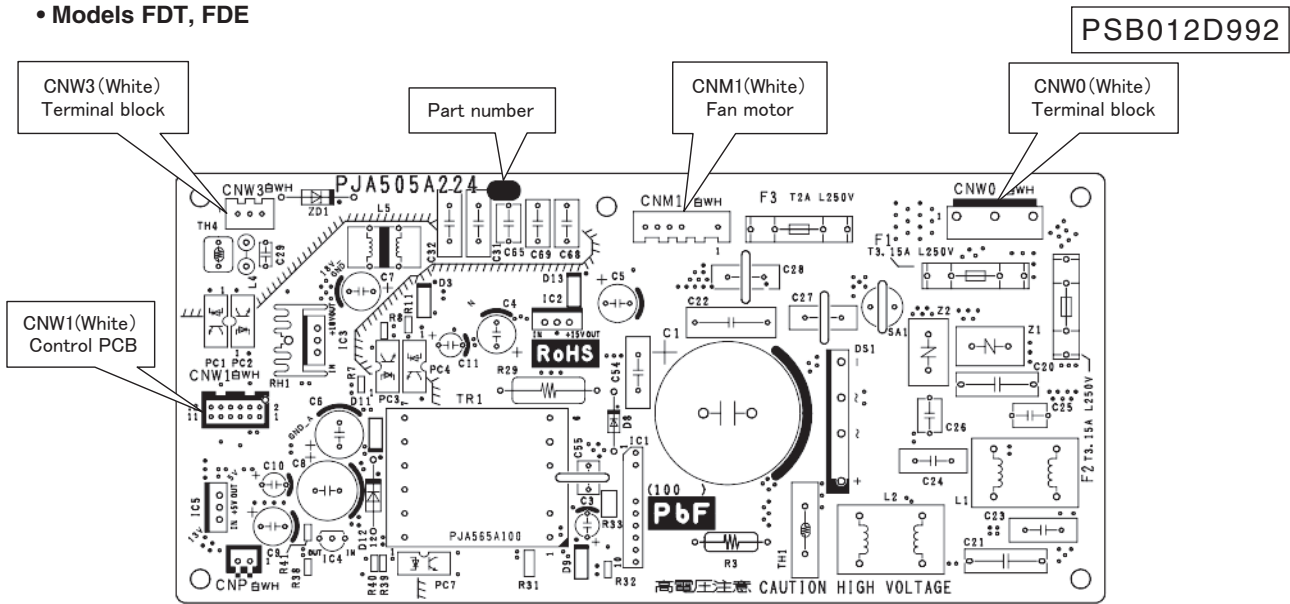

• Model FDUM

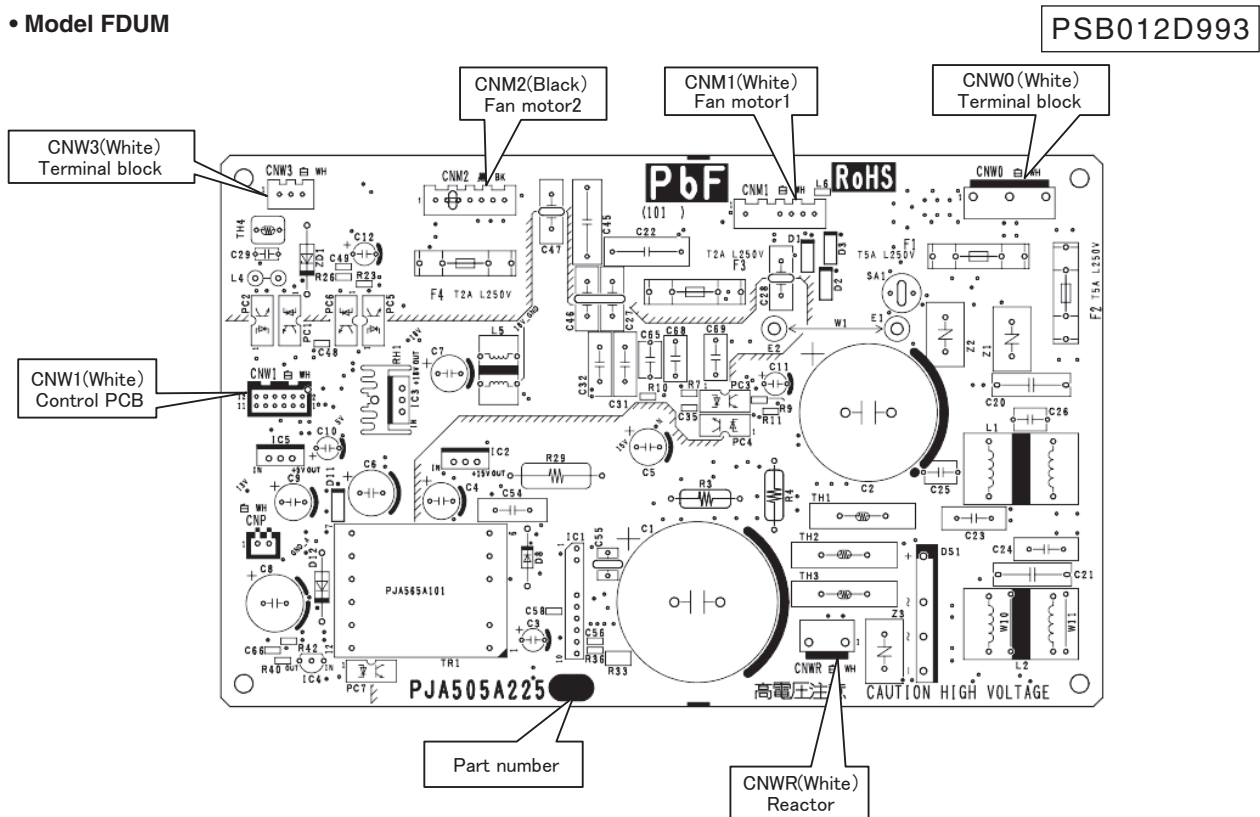

b) Model FDU series

PSC012D021

This PCB is a general PCB. Replace the PCB according to this instruction.

i) Replace the PCB

- ① Unscrew terminal(Arrow A) of the "E2" wiring(yellow/green) that is connected to PCB.
- ② Replace the PCB only after all the wirings connected to the connector are removed.
- ③ Fix the board such that it will not pinch any of the wires.
- ④ Reconnect the wirings to the PCB. Wiring connector color should match with the color of connector of the PCB.
- ⑤ Screw back the terminal(Arrow A) of the "E2" wiring, that was removed in 1.

ii) Power PCB

Parts mounting are different by the kind of PCB.

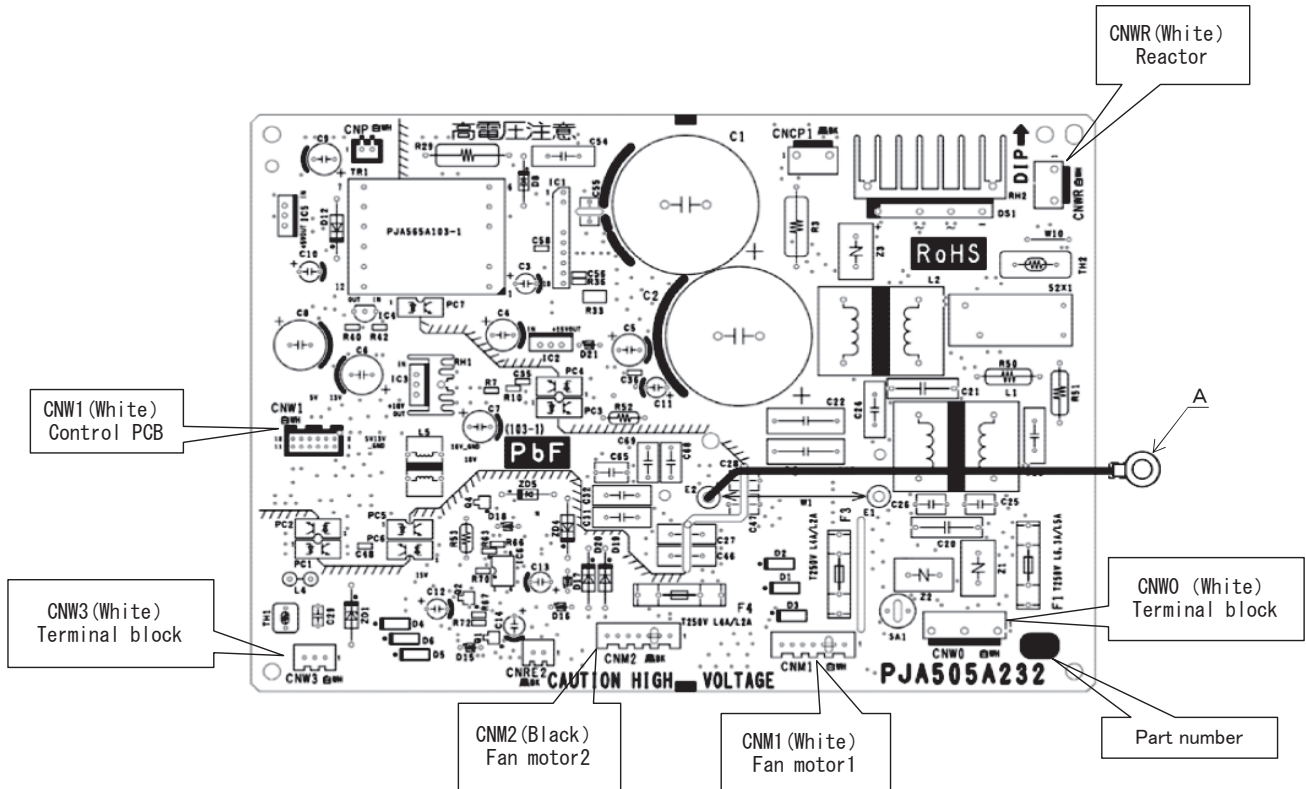

PSB012D976D

(ii) Model FDF series

1) Control PCB

Replace and set up the PCB according to this instruction.

- a) Set to an appropriate address and function using switch on PCB.

Select the same setting with the removed PCB.

item	switch	Content of control	
Address	SW2	Plural indoor units control by 1 remote control	
Test run	SW7-1	OFF	Normal
		ON	Operation check/drain motor test run

- b) Set to an appropriate capacity using the model selector switch(SW6).

Select the same capacity with the PCB removed from the unit.

SW6	-1	-2	-3	-4
100V	ON	ON	OFF	ON

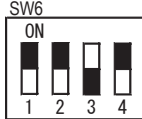

- c) Replace the PCB

- i) Fix the PCB so as not to pitch the cords.
- ii) Connect connectors to the PCB. Connect a cable connector with the PCB connector of the same color.
- iii) Do not pass CPU surrounding about wirings.

- d) Control PCB

Parts mounting are different by the kind of PCB.

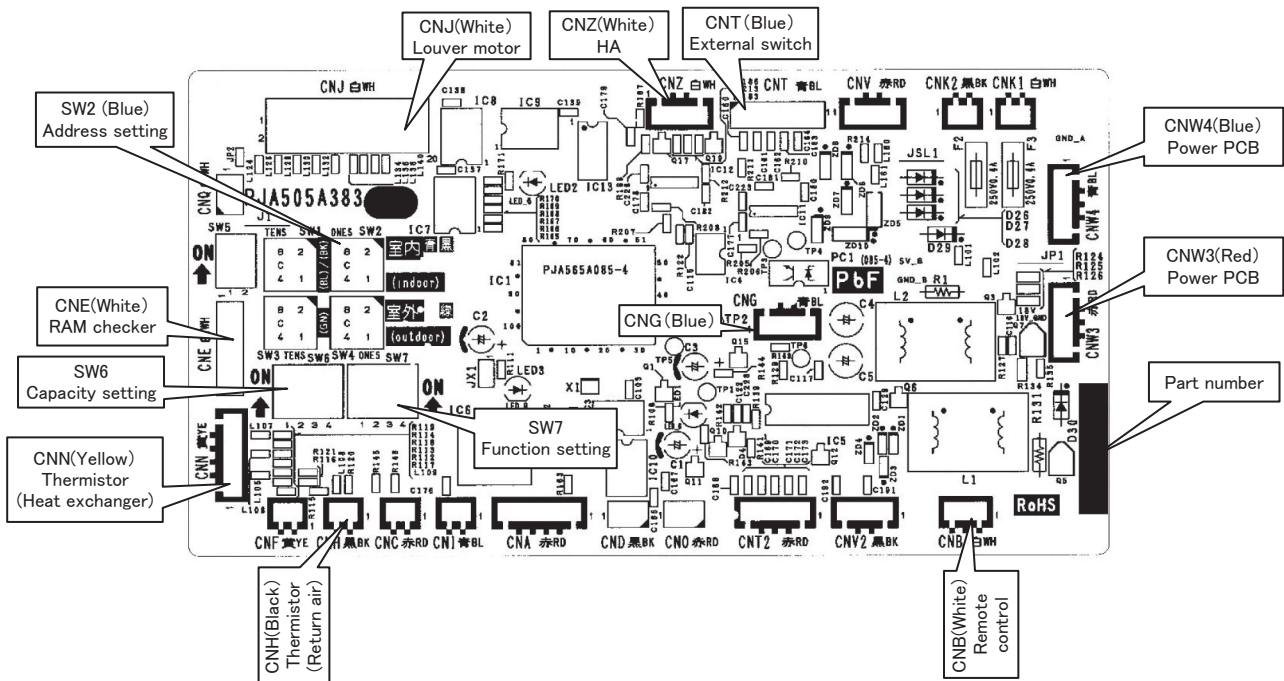

2) Power PCB

PSB012D953G

This PCB is a general PCB. Replace the PCB according to this instruction.

Replace the PCB

- a) Unscrew terminal of the wiring(yellow/green) soldered to PCB from the box.
- b) Replace the PCB only after all the wirings connected to the connector are removed.
- c) Fix the board such that it will not pinch any of the wires.
- d) Reconnect the wirings to the PCB. Wiring connector color should match with the color of connector of the PCB.
- e) Screw back the terminal of wiring (yellow/green) from PCB(T1), that was removed in 1.
In that case, do not place the crimping part of the wiring under the PCB.

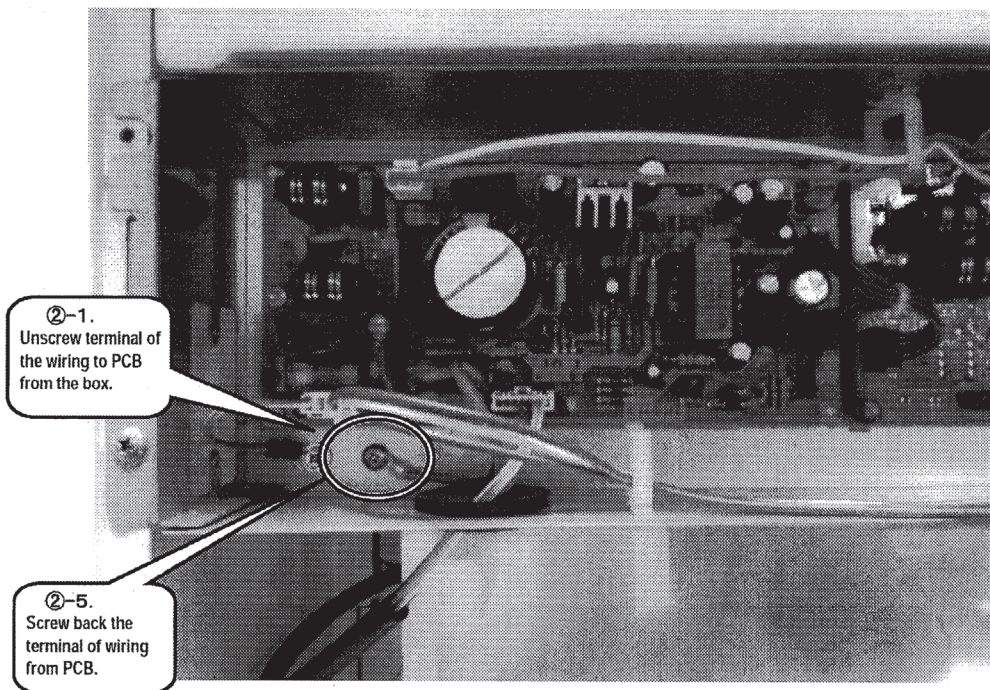
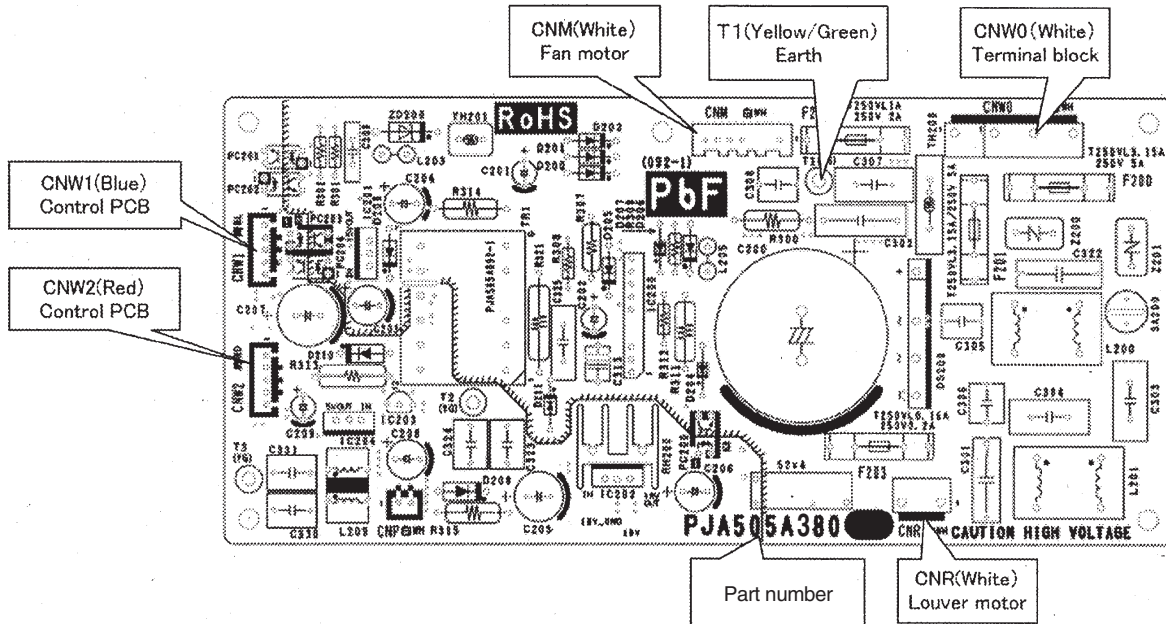

●DIP switch setting list

Switches	Description		Default setting		Remarks
SW2	Address No. setting at plural indoor units control by 1 R/C		0		0-F
SW5-1	Reserved		OFF		Keep OFF
SW5-2	Reserved		OFF		Keep OFF
SW6-1	Model selection		As per model		See table 1
SW6-2					
SW6-3					
SW6-4					
SW7-1	Test run, Drain motor	Normal*/Test run	OFF	Normal	
SW7-2	Reserved		OFF		Keep OFF
SW7-3	Powerful mode	Valid*/Invalid	ON	Valid	
SW7-4	Reserved		OFF		Keep OFF
SW8-1	Reserved		OFF		Keep OFF
SW8-2	Reserved		OFF		Keep OFF
SW8-3	Reserved		OFF		Keep OFF
SW8-4	Reserved		OFF		Keep OFF
JSL1	Superlink terminal spare	Normal*/switch to spare	With		

Note (1) : SW8 : FDT, FDE, FDU, FDUM only Default setting

Table 1: Indoor unit model selection with SW6-1-SW6-4

Switches	100V
SW6-1	ON
SW6-2	ON
SW6-3	OFF
SW6-4	ON

(4) Check of anomalous operation data with the remote control

(a) In case of RC-EX1A remote control

[Operating procedure]

① On the TOP screen, touch the buttons in the order of “Menu” → “Next” → “Service & Maintenance” → “Service password” → “Set” → “Error display” → “Error history”.

② When only one indoor unit is connected to the remote control, followings will be displayed.

1. When there is any anomaly: “Loading. Wait a while” is displayed, followed by the operation data at the occurrence of anomaly.

Contents of display

- Error code
- Number and data item

2. When there is no anomaly: “No anomaly” is displayed, and this mode is terminated.

③ When two or more indoor units are connected to the remote control, followings will be displayed.

1. When there is any anomaly: If the unit having anomaly is selected on the “Select IU” screen, “Loading. Wait a while” is displayed, followed by the operation data at the occurrence of anomaly.

Contents of display

- Indoor unit No.
- Error code
- Number and data item

2. When there is no anomaly: “No anomaly” is displayed, and this mode is terminated.

Note (1) When the number of connected units cannot be shown in a page, select “Next”.

④ If you press [RUN/STOP] button, the display returns to the TOP screen.

⊙ **If you touch “Back” button on the way of setting, the display returns to the last precious screen.**

Note (1) When two remote controls are used to control indoor units, the check of anomaly operation data can be made on the master remote control only. (It cannot be operated from the slave remote control.)

■ Anomaly operation data (Corresponding data may not be provided depending on models. Such items will not be displayed.)

Number		Data Item
01	🌀	(Operation Mode)
02	SET TEMP. ℃	(Set Temperature)
03	RETURN AIR ℃	(Return Air Temperature)
04	SENSOR ℃	(Remote Control Thermistor Temperature)
05	THI-R1 ℃	(Indoor Heat Exchanger Thermistor / U Bend)
06	THI-R2 ℃	(Indoor Heat Exchanger Thermistor / Capillary)
07	THI-R3 ℃	(Indoor Heat Exchanger Thermistor / Gas Header)
08	I/U FANSPEED	(Indoor Unit Fan Speed)
09	DEMAND Hz	(Frequency Requirements)
10	ANSWER Hz	(Response Frequency)
11	I/U EEV P	(Pulse of Indoor Unit Expansion Valve)
12	TOTAL I/U RUN H	(Total Running Hours of The Indoor Unit)
21	OUTDOOR ℃	(Outdoor Air Temperature)
22	THO-R1 ℃	(Outdoor Heat Exchanger Thermistor)
23	THO-R2 ℃	(Outdoor Heat Exchanger Thermistor)
24	COMP Hz	(Compressor Frequency)
25	HP MPa	(High Pressure)
26	LP MPa	(Low Pressure)
27	Td ℃	(Discharge Pipe Temperature)
28	COMP BOTTOM ℃	(Comp Bottom Temperature)
29	CT AMP	(Current)
30	TARGET SH ℃	(Target Super Heat)
31	SH ℃	(Super Heat)
32	TDSH ℃	(Discharge Pipe Super Heat)
33	PROTECTION No.	(Protection State No. of The Compressor)
34	O/U FANSPEED	(Outdoor Unit Fan Speed)
35	ESH1	(63H1 On/Off)
36	DEFROST	(Defrost Control On/Off)
37	TOTAL COMP RUN H	(Total Running Hours of The Compressor)
38	O/U EEV1 P	(Pulse of The Outdoor Unit Expansion Valve EEVC)
39	O/U EEV2 P	(Pulse of The Outdoor Unit Expansion Valve EEVH)

● Details of Compressor protection status No. 33

No.	Contents of display
"0"	Normal
"1"	Discharge pipe temperature protection control
"2"	Discharge pipe temperature anomaly
"3"	Current safe control of inverter primary current
"4"	High pressure protection control
"5"	High pressure anomaly
"6"	Low pressure protection control
"8"	Anti-frost prevention control
"9"	Current cut
"13"	Spare
"15"	Current safe control of inverter secondary current
"16"	Stop by compressor rotor lock
"17"	Stop by compressor startup failure
"18"	Active filter anomaly

Note(1) Operation data display on the remote control.

- Data is displayed until canceling the protection control.
- In case of multiple protections controlled, only the younger No. is displayed.

Note(2) Common item.

- ① In heating mode.
During protection control by the command signal for reducing compressor frequency from indoor unit, No. "4" is displayed.
- ② In cooling and dehumidifying mode.
During protection control by the command signal for reducing compressor frequency from indoor unit, No. "8" is displayed.

(b) In case of RC-E5 remote control

Operation data can be checked with remote control unit operation.

- ① Press the **CHECK** button.
The display change “OPER DATA ▼”
- ② Press the **○** (SET) button while “OPER DATA ▼” is displayed.
- ③ When only one indoor unit is connected to remote control, “DATA LOADING” is displayed (blinking indication during data loading).
Next, operation data of the indoor unit will be displayed. Skip to step ⑦.
- ④ When plural indoor units is connected, the smallest address number of indoor unit among all connected indoor unit is displayed.

[Example]:

“SELECT I/U” (blinking 1 seconds) → “I/U000 ▲” blinking.

- ⑤ Select the indoor unit number you would like to have data displayed with the **▲ ▼** button.
- ⑥ Determine the indoor unit number with the **○** (SET) button.
(The indoor unit number changes from blinking indication to continuous indication)

“I/U000” (The address of selected indoor unit is blinking for 2 seconds.)



“DATA LOADING” (A blinking indication appears while data loaded.)

Next, the operation data of the indoor unit is indicated.

- ⑦ Upon operation of the **▲ ▼** button, the current operation data is displayed in order from data number 01.

The items displayed are in the above table.

*Depending on models, the items that do not have corresponding data are not displayed.

- ⑧ To display the data of a different indoor unit, press the **AIR CON No.** button, which allows you to go back to the indoor unit selection screen.
- ⑨ Pressing the **○ ON/OFF** button will stop displaying data.

Pressing the **⌘** (RESET) button during remote control unit operation will undo your last operation and allow you to go back to the previous screen.

⊙ If two (2) remote controls are connected to one (1) inside unit, only the master control is available for trial operation and confirmation of operation data. (The slave remote control is not available.)

Number		Data Item
01	🌀	(Operation Mode)
02	SET TEMP	(Set Temperature)
03	RETURN AIR	(Return Air Temperature)
04	SENSOR	(Remote Control Thermistor Temperature)
05	THI-R1	(Indoor Heat Exchanger Thermistor / U Bend)
06	THI-R2	(Indoor Heat Exchanger Thermistor / Capillary)
07	THI-R3	(Indoor Heat Exchanger Thermistor / Gas Header)
08	I/U FANSPEED	(Indoor Unit Fan Speed)
09	DEMAND	(Frequency Requirements)
10	ANSWER	(Response Frequency)
11	I/U EEV	(Pulse of Indoor Unit Expansion Valve)
12	TOTAL I/U RUN	(Total Running Hours of The Indoor Unit)
21	OUTDOOR	(Outdoor Air Temperature)
22	THO-R1	(Outdoor Heat Exchanger Thermistor)
23	THO-R2	(Outdoor Heat Exchanger Thermistor)
24	COMP	(Compressor Frequency)
25	HP	(High Pressure)
26	LP	(Low Pressure)
27	Td	(Discharge Pipe Temperature)
28	COMP BOTTOM	(Comp Bottom Temperature)
29	CT	(Current)
30	TARGET SH	(Target Super Heat)
31	SH	(Super Heat)
32	TDSH	(Discharge Pipe Super Heat)
33	PROTECTION No.	(Protection State No. of The Compressor)
34	O/U FANSPEED	(Outdoor Unit Fan Speed)
35	63H1	(63H1 On/Off)
36	DEFROST	(Defrost Control On/Off)
37	TOTAL COMP RUN	(Total Running Hours of The Compressor)
38	O/U EEV1	(Pulse of The Outdoor Unit Expansion Valve EEVC)
39	O/U EEV2	(Pulse of The Outdoor Unit Expansion Valve EEVH)

●Details of Compressor protection status No. 33

No.	Contents of display
"0"	Normal
"1"	Discharge pipe temperature protection control
"2"	Discharge pipe temperature anomaly
"3"	Current safe control of inverter primary current
"4"	High pressure protection control
"5"	High pressure anomaly
"6"	Low pressure protection control
"8"	Anti-frost prevention control
"9"	Current cut
"13"	Spare
"15"	Current safe control of inverter secondary current
"16"	Stop by compressor rotor lock
"17"	Stop by compressor startup failure
"18"	Active filter anomaly

- Note(1) Operation data display on the remote control.
 •Data is displayed until canceling the protection control.
 •In case of multiple protections controlled, only the younger No. is displayed.
- Note(2) Common item.
 ① In heating mode.
 During protection control by the command signal for reducing compressor frequency from indoor unit, No. "4" is displayed.
 ② In cooling and dehumidifying mode.
 During protection control by the command signal for reducing compressor frequency from indoor unit, No. "8" is displayed.

(5) Outdoor unit control failure diagnosis circuit diagram
 ◆ Check point of outdoor unit

⚠ CAUTION – HIGH VOLTAGE

High voltage is produced in the control box. Don't touch electrical parts in the control box for 5 minutes after the unit is stopped.

Color symbol

Mark	Color
BK	Black
BL	Blue
RD	Red
WH	White
YE	Yellow
Y/G	Yellow/Green

◆ Voltage check in PCB

The normal range is as follows.

Display	Voltage range
① DC280V DC230V - DC310V	
② DC 20V DC 18V - DC 22V	
③ DC 13V DC 12V - DC 14V	
④ DC 15V DC 14V - DC 16V	
⑤ DC 5V DC 4V - DC 6V	
⑥ DC 2.5V DC 2.3V - DC 2.5V	

◆ Inspection power transistor

Remove the fasten terminal and test output voltage.

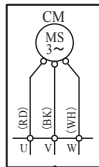

◆ Power source and serial signal inspection

- ① to ② : AC220/230/240V
- ① to ②/N : AC220/230/240V
- ②/N to ③ : Normal if the voltage oscillates between DC 0 and approx. 20V

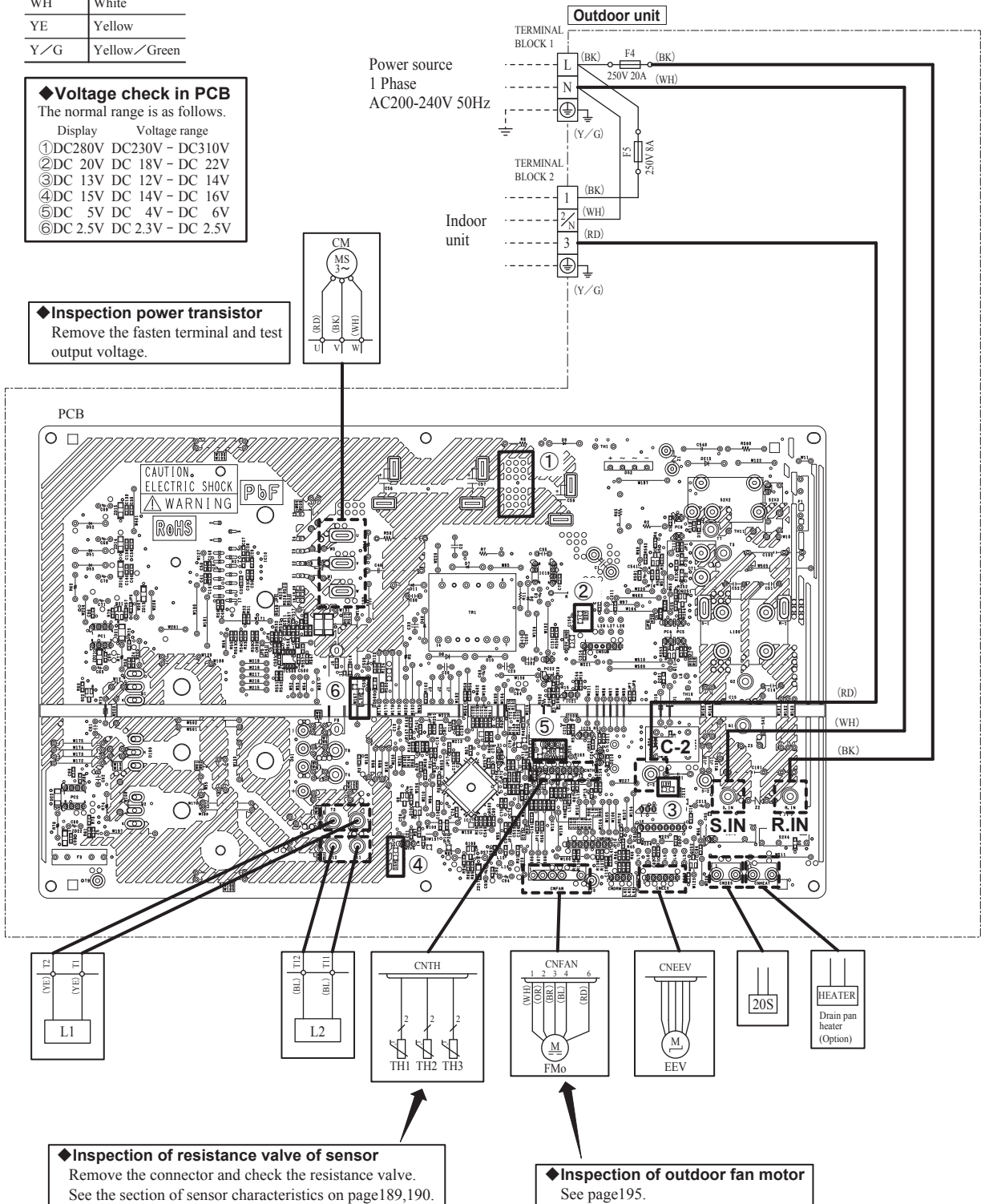



◆ Inspection of resistance valve of sensor
 Remove the connector and check the resistance valve.
 See the section of sensor characteristics on page189,190.

◆ Inspection of outdoor fan motor
 See page195.

12.1.2 Troubleshooting flow

(1) List of troubles

Remote control display	Description of trouble	Reference page
None	Operates but does not cool	160
None	Operates but does not heat	161
None	Earth leakage breaker activated	162
None	Excessive noise/vibration (1/3)	163
None	Excessive noise/vibration (2/3)	164
None	Excessive noise/vibration (3/3)	165
None	Louver motor failure (FDT, FDE, FDF series)	166
None	Power source system error (Power source to indoor control PCB)	167
None	Power source system error (Power source to remote control)	168
INSPECT I/U	INSPECT I/U (When 1 or 2 remote controls are connected)	169
INSPECT I/U	INSPECT I/U (Connection of 3 units or more remote controls)	170
 WAIT 	Communication error at initial operation	171-173
E1	Remote control communication circuit error	174
E5	Communication error during operation	175
E6	Indoor heat exchanger temperature thermistor anomaly	176
E7	Return air temperature thermistor anomaly	177
E8	Heating overload operation	178
E9	Drain trouble (FDT, FDU, FDUM series)	179
E10	Excessive number of connected indoor units (more than 17 units) by controlling with one remote control	180
E11	Address setting error of indoor units	181
E16	Indoor fan motor anomaly	182
E19	Indoor unit operation check	183
E20	Indoor fan motor rotation speed anomaly	184
E21	Defective panel switch operation (FDT only)	185
E28	Remote control temperature thermistor anomaly	186
E35	Cooling overload operation	187
E36	Discharge pipe temperature error	188
E37	Outdoor heat exchanger temperature sensor anomaly	189
E38	Outdoor air temperature sensor anomaly	190
E39	Discharge pipe temperature sensor anomaly	191
E42	Current cut	192,193
E47	Active filter voltage error	194
E48	Outdoor fan motor anomaly	195
E51	Power transistor anomaly	196
E57	Insufficient refrigerant amount or detection of service valve closure	197
E58	Current safe stop	198
E59	Compressor startup failure	199
E60	Compressor rotor lock error	200

(2) Troubleshooting

Error code Remote control: None	LED	Green	Red	Content Operates but does not cool
	Indoor	Keeps flashing	Stays OFF	

<p>1. Applicable model</p> <p>All models</p>	5. Troubleshooting	
<p>2. Error detection method</p>	Diagnosis	Countermeasure
<p>3. Condition of error displayed</p>	<pre> graph TD Start[Check the indoor unit fan operation. Check the temperature difference between return and supply air.] --> D1{Is the temperature difference between return and supply air 10-20°C at cooling?} D1 -- YES --> D2{Does the heat load increase after installation?} D1 -- NO --> D3{Is the compressor operating?} D2 -- YES --> Box1[Mistake in model selection. Calculate heat load once more.] D2 -- NO --> D4{“WAIT” message is displayed (for 3 seconds) when performing cooling, defrosting and heating operations from the remote control.} Box1 --> D4 D3 -- NO --> D4 D3 -- YES --> D5{Is the compressor rotation speed low?} D4 -- YES --> CM1[Compressor refrigerant oil protection control at starting is activated.] D4 -- NO --> CM2[Compressor may be stopped by the error detection control. For the contents of control, refer to anomalous stop control by controlling compressor rotation speed of microcomputer control functions.] D5 -- NO --> CM3[Inspect the followings. • Minor clogging of filter • Minor clogging of heat exchanger • Minor short-circuit • Minor shortage of refrigerant amount • Poor compression of compressor] D5 -- YES --> Box2[Check which control “Determination control of compressor rotation speed” or “Protective control by controlling compressor rotation speed” is appropriate to this phenomenon.] Box2 --> D6{Are the temperature conditions of room and outdoor air close to the rated conditions?} D6 -- YES --> CM4[Considering appropriate operation control, check suspicious points. Inspect the followings for reference. • Major clogging of filter • Major clogging of heat exchanger • Major short-circuit • Major shortage of refrigerant amount • Compressor protection ON • Indoor fan tap] D6 -- NO --> Box3[The unit is operating normally but is operating under the control for protecting compressor or other respective parts.] </pre>	
<p>4. Presumable cause</p> <ul style="list-style-type: none"> • Poor compression of compressor • Faulty expansion valve operation 		

Note:

Error code Remote control: None	LED	Green	Red	Content Operates but does not heat
	Indoor	Keeps flashing	Stays OFF	

1. Applicable model	5. Troubleshooting	
All models	Diagnosis	Countermeasure
2. Error detection method	<p>Check the indoor unit fan operation. Check the temperature difference between return and supply air.</p> <pre> graph TD Start[Check the indoor unit fan operation. Check the temperature difference between return and supply air.] --> D1{Is the temperature difference between return and supply air 10-30°C at heating?} D1 -- YES --> D2{Does the heat load increase after installation?} D1 -- NO --> D3{Is the compressor operating?} D2 -- YES --> Box1[Mistake in model selection. Calculate heat load once again.] D2 -- NO --> CM1[It is normal. (This unit is designed to start in the soft start mode by detecting the under dome temperature of compressor when it restart after power reset.)] D3 -- NO --> D4{"⏸️WAIT⏸️" message is displayed (for 3 seconds) when performing cooling, defrosting and heating operations from the remote control.} D3 -- YES --> D5{Is the compressor rotation speed low?} D4 -- YES --> CM2[It is necessary to replace to higher capacity one or to install additional unit.] D4 -- NO --> CM3[Compressor may be stopped by the error detection control. For the contents of control, refer to anomalous stop control by controlling compressor rotation speed of microcomputer control functions.] D5 -- YES --> Box2[Check which control "Determination control of compressor rotation speed" or "Protective control by controlling compressor rotation speed" is appropriate to this phenomenon.] D5 -- NO --> CM4[Inspect the followings. • Minor clogging of filter • Minor clogging of heat exchanger • Minor short-circuit • Minor shortage of refrigerant amount • Poor compression of compressor] Box2 --> D6{Are the temperature conditions of room and outdoor air close to the rated conditions? (1)} D6 -- YES --> CM5[Considering appropriate operation control, check suspicious points. Inspect the followings for reference. • Major clogging of filter • Major clogging of heat exchanger • Major short-circuit • Major shortage of refrigerant amount • Compressor protection ON • Indoor fan tap] D6 -- NO --> Box3[The unit is operating normally but is operating under the control for protecting compressor or other respective parts.] </pre> <p>Note (1) Outdoor: 7°C, Indoor: 20°C</p>	<p>It is normal. (This unit is designed to start in the soft start mode by detecting the under dome temperature of compressor when it restart after power reset.)</p> <p>It is necessary to replace to higher capacity one or to install additional unit.</p> <p>Compressor refrigerant oil protection control at starting is activated.</p> <p>Compressor may be stopped by the error detection control. For the contents of control, refer to anomalous stop control by controlling compressor rotation speed of microcomputer control functions.</p> <p>Inspect the followings.</p> <ul style="list-style-type: none"> • Minor clogging of filter • Minor clogging of heat exchanger • Minor short-circuit • Minor shortage of refrigerant amount • Poor compression of compressor <p>Considering appropriate operation control, check suspicious points. Inspect the followings for reference.</p> <ul style="list-style-type: none"> • Major clogging of filter • Major clogging of heat exchanger • Major short-circuit • Major shortage of refrigerant amount • Compressor protection ON • Indoor fan tap
3. Condition of error displayed		
4. Presumable cause		
<ul style="list-style-type: none"> • Faulty 4-way valve operation • Poor compression of compressor • Faulty expansion valve operation 		

Note: When the outdoor air temperature (TH2) is 10 °C or lower and compressor is not operated for long time, the unit start cooling mode up to 7 minutes at heating mode.

Error code Remote control: None	LED	Green	Red	Content Earth leakage breaker activated
	Indoor	Stays OFF	Stays OFF	

1. Applicable model	5. Troubleshooting		
All models	Diagnosis		Countermeasure
2. Error detection method	<pre> graph TD Q1{Are OK the insulation resistance and coil resistance of compressor?} -- NO --> C1[Replace compressor.*] Q1 -- YES --> Q2{Is insulation of respective harnesses OK? Is any harness bitten between pannel and casing or etc?} Q2 -- NO --> C2[Secure insulation resistance.] Q2 -- YES --> P1[Check the outdoor unit grounding wire/earth leakage breaker.] P1 --> P2[Check of the outdoor unit grounding wire/earth leakage breaker] </pre>		
3. Condition of error displayed	<p>Check of the outdoor unit grounding wire/earth leakage breaker</p> <p>① Run an independent grounding wire from the grounding screw of outdoor unit to the grounding terminal on the distribution panel. (Do not connect to another grounding wire.)</p> <p>② In order to prevent malfunction of the earth leakage breaker itself, confirm that it is conformed to higher harmonic regulation.</p> <p>* Insulation resistance of compressor</p> <ul style="list-style-type: none"> • Immediately after installation or when the unit has been left for long time without power source, the insulation resistance may drop to a few MΩ because of refrigerant migrated in the compressor. <p>When the earth breaker is activated at lower insulation resistance, check the following points.</p> <p>① Check if the earth leakage breaker is conformed to higher harmonic regulation or not.</p> <p>Since the unit is equipped with inverter, it is necessary to use components conformed to higher harmonic regulation in order to prevent malfunction of earth leakage breaker.</p>		
4. Presumable cause	<ul style="list-style-type: none"> • Defective compressor • Noise 		

Note:

Error code Remote control: None	LED	Green	Red	Content Excessive noise/vibration (1/3)
	Indoor	-	-	

1. Applicable model
All models

2. Error detection method

3. Condition of error displayed

4. Presumable cause
- ① Improper installation work
 - Improper anti-vibration work at installation
 - Insufficient strength of mounting face
 - ② Defective product
 - Before/after shipping from factory
 - ③ Improper adjustment during commissioning
 - Excess/shortage of refrigerant, etc.

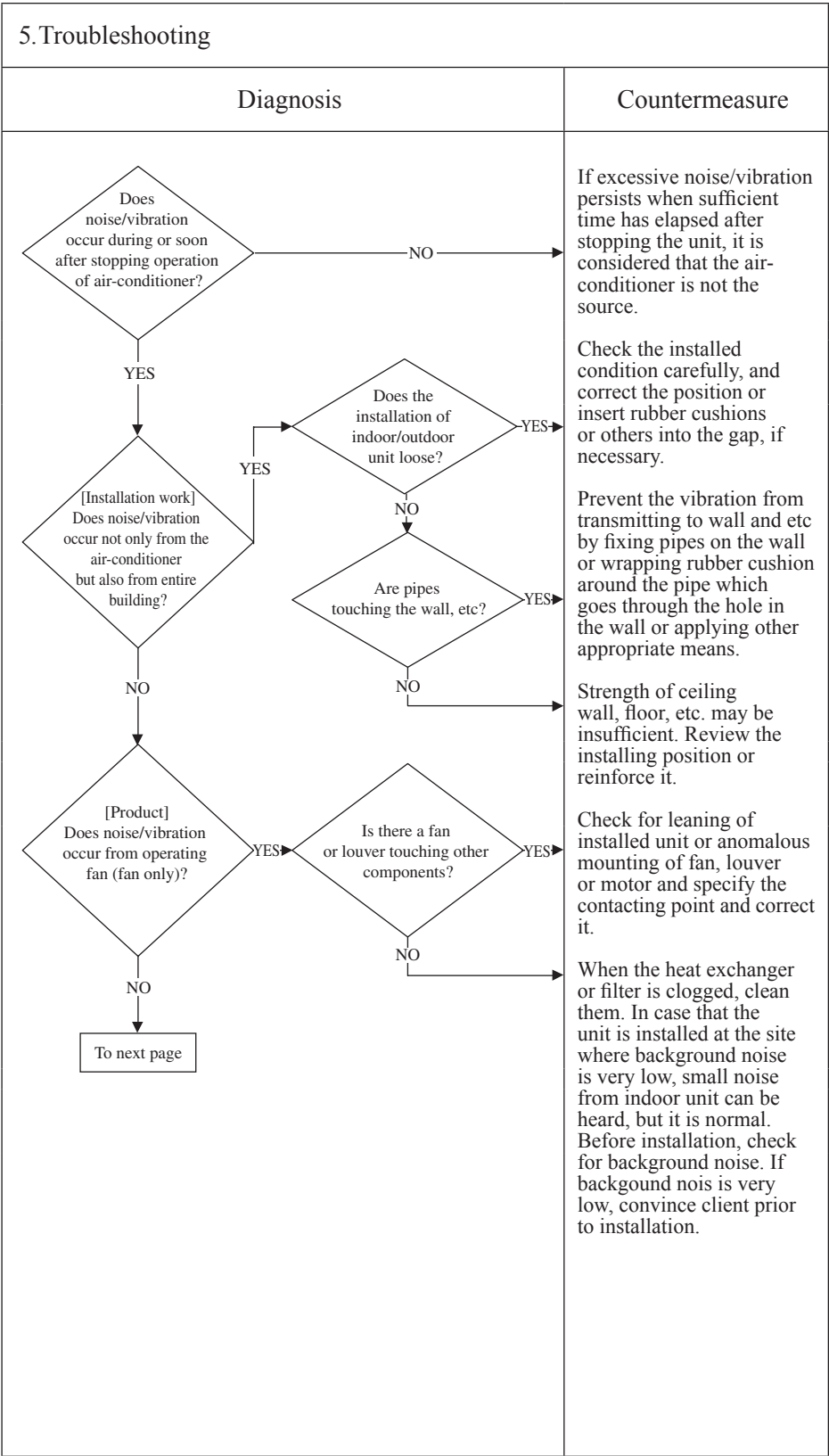

Note:

Error code Remote control: None	LED	Green	Red	Content Excessive noise/vibration (2/3)
	Indoor	-	-	

1. Applicable model	5. Troubleshooting		
All models	Diagnosis		Countermeasure
2. Error detection method	<pre> graph TD Start([From previous page]) --> D1{[Unit side] Does noise/vibration occur when the cooling/heating operation is performed normally?} D1 -- NO --> NextPage[To next page] D1 -- YES --> D2{Are the pipes contacting the casing?} D2 -- YES --> CM1[Rearrange the piping to avoid contact with the casing.] D2 -- NO --> D3{Is it heard continuous hissing or roaring sound?} D3 -- YES --> CM2[It is noise/vibration that is generated when the refrigerant gas or liquid flow through inside of piping of air-conditioner. It is likely to occur particularly during cooling or defrosting in the heating mode. It is normal.] D3 -- NO --> D4{Are hissing sounds heard at the startup or stopping?} D4 -- YES --> CM3[The noise/vibration occurs when the refrigerant starts or stops flowing. It is normal.] D4 -- NO --> D5{Is blowing sound heard at the start/stop of defrost operation during heating?} D5 -- YES --> CM4[When the defrost operation starts or stops during heating, the refrigerant flow is reversed due to switching 4-way valve. This causes a large change in pressure which produces a blowing sound. It may accompany also the hissing sounds as mentioned above. They are normal.] D5 -- NO --> D6{Is cracking noise heard during heating operation?} D6 -- YES --> CM5[After the start or stop of heating operation or during defrost operation, abrupt changes in temperature cause resin parts to shrink or expand. This is normal.] D6 -- NO --> D7{Hissing noise is heard during cooling operation or after stopping.} D7 -- YES --> CM6[It is the sound produced by the drain pump that discharges drain from the indoor unit. The pump continues to run for 5 minutes after stopping the cooling operation. This is normal.] D7 -- NO --> CM7[Apply the damper sealant at places considered to be the sources such as the pressure reducing mechanism (expansion valve), capillary, etc.] </pre>		
3. Condition of error displayed			
4. Presumable cause			

Note:

<table border="1"> <tr> <td>Error code</td> <td>LED</td> <td>Green</td> <td>Red</td> <td>Content</td> </tr> <tr> <td>Remote control: None</td> <td>Indoor</td> <td>–</td> <td>–</td> <td>Excessive noise/vibration (3/3)</td> </tr> </table>	Error code	LED	Green	Red	Content	Remote control: None	Indoor	–	–	Excessive noise/vibration (3/3)
Error code	LED	Green	Red	Content						
Remote control: None	Indoor	–	–	Excessive noise/vibration (3/3)						

<p>1. Applicable model</p> <p>All models</p>	<p>5. Troubleshooting</p>	
<p>2. Error detection method</p>	<p>Diagnosis</p>	<p>Countermeasure</p>
<p>3. Condition of error displayed</p>	<pre> graph TD A[From previous page] --> B{Adjustment during commissioning Does noise/vibration occur when the cooling/heating operation is in anomalous condition?} B -- YES --> C[Countermeasure] </pre>	
<p>4. Presumable cause</p>	<p>If insufficient cooling/heating problem happens due to anomalous operating conditions at cooling/heating, followings are suspicious.</p> <ul style="list-style-type: none"> • Overcharge of refrigerant • Insufficient charge of refrigerant • Intrusion of air, nitrogen, etc. <p>In such occasion, it is necessary to recover refrigerant, vacuum-dry and recharge refrigerant.</p> <p>* Since there could be many causes of noise/vibration, the above do not cover all. In such case, check the conditions when, where, how the noise/vibration occurs according to following check point.</p> <ul style="list-style-type: none"> • Indoor/outdoor unit • Cooling/heating/fan mode • Startup/stop/during operation • Operating condition (Indoor/outdoor temperatures, pressure) • Time it occurred • Operation data retained by the remote control such as compressor rotation speed, heat exchanger temperature, EEV opening degree, etc. • Tone (If available, record the noise) • Any other anomalies 	

Note:

Error code Remote control: None	LED	Green	Red	Content Louver motor failure (FDT, FDE, FDF series)
	Indoor	Keeps flashing	Stays OFF	

1. Applicable model
FDT, FDE, FDF series only

2. Error detection method

3. Condition of error displayed

4. Presumable cause
<ul style="list-style-type: none"> • Defective LM • LM wire breakage • Faulty indoor control PCB

5. Troubleshooting	
Diagnosis	Countermeasure
<p>▲ Check at the indoor unit side.</p> <pre> graph TD Start[Operate after waiting for more than 1 minute.] --> Q1{Does the louver operate at the power on?} Q1 -- NO --> Q2{Is LM wiring broken?} Q2 -- YES --> C1[Repair wiring.] Q2 -- NO --> Q3{Is LM locked?} Q3 -- NO --> C2[Defective indoor control PCB → Replace.] Q3 -- YES --> C3[Replace LM.] Q1 -- YES --> Q4{Is the louver operable with the remote control?} Q4 -- YES --> C4[Normal] Q4 -- NO --> C5[Adjust LM lever and then check again.] </pre> <p style="text-align: center;">LM: louver motor</p>	

Note:

Error code Remote control: None	LED	Green	Red	Content Power source system error (Power source to indoor control PCB)
	Indoor	Stays OFF	Stays OFF	

1. Applicable model All models
2. Error detection method
3. Condition of error displayed
4. Presumable cause <ul style="list-style-type: none"> • Misconnection or breakage of connecting wires • Blown fuse • Faulty transformer • Faulty indoor control or power PCB • Broken harness • Faulty outdoor control PCB

5. Troubleshooting	
Diagnosis	Countermeasure
<pre> graph TD Q1{Is AC220-240V detected between ① and ② on the terminal block of indoor unit?} Q2{Is AC220-240V detected between ① and ② on the terminal block of outdoor unit?} Q3{Isn't F5 fuse (250V,8A) blown?} Q4{Are fuses OK?} Q5{Is the check of resistance between ①-③ of CNW0 OK?} Q6{Is the checked result of resistance of FM, LM, etc OK?} Q7{Is DC5V detected between ④-⑤ of CNW2?} Q8{Is JX1 open?} Q1 -- YES --> Q4 Q1 -- NO --> Q2 Q2 -- YES --> C1[Misconnection or breakage of connecting wires] Q2 -- NO --> Q3 Q3 -- YES --> C2[Replace fuse.] Q3 -- NO --> C3[Defective outdoor control PCB] Q4 -- NO --> Q5 Q4 -- YES --> Q5 Q5 -- NO --> C4[Defective indoor control or power PCB → Replace.] Q5 -- YES --> Q6 Q6 -- NO --> C5[Replace FM, LM, etc.] Q6 -- YES --> C6[Replace fuse.] Q7 -- NO --> C7[Defective indoor power PCB → Replace.] Q7 -- YES --> Q8 Q8 -- NO --> C8[Open JX1.] Q8 -- YES --> C9[Defective indoor control PCB → Replace.] </pre>	Countermeasure

Note:

Error code Remote control: None	LED	Green	Red	Content Power source system error (Power source to remote control)
	Indoor	Keeps flashing	Stays OFF	

1. Applicable model	5. Troubleshooting		
All models	Diagnosis	Countermeasure	
2. Error detection method	<pre> graph TD D1{Isn't there any loose connection of remote control wires?} -- YES --> C1[Correct.] D1 -- NO --> D2{Isn't remote control wire broken or short-circuited?} D2 -- YES --> C2[Replace wires.] D2 -- NO --> P1[Disconnect remote control wires.] P1 --> D3{Is DC15V or higher detected between X-Y of indoor unit terminal block?} D3 -- YES --> C3[Replace remote control.] D3 -- NO --> D4{Is DC180V between ①-② of CNW2?} D4 -- YES --> C4[Defective indoor control PCB -> Replace.] D4 -- NO --> C5[Defective indoor power PCB -> Replace.] Note(1) FDF series: CNW3 </pre>		
3. Condition of error displayed			
4. Presumable cause	<ul style="list-style-type: none"> • Remote control wire breakage/short-circuit • Defective remote control • Malfunction by noise • Faulty indoor power PCB • Broken harness • Faulty indoor control PCB 		

Note:

Error code Remote control: INSPECT I/U	LED	Green	Red	Content INSPECT I/U (When 1 or 2 remote controls are connected)
	Indoor	Keeps flashing	Stays OFF	

1. Applicable model
All models

2. Error detection method
Communication between indoor unit and remote control is disabled for more than 30 minutes after the power on.

3. Condition of error displayed
Same as above

4. Presumable cause
<ul style="list-style-type: none"> • Improper setting • Surrounding environment • Defective remote control communication circuit • Faulty indoor control PCB

5. Troubleshooting	
Diagnosis	Countermeasure
<pre> graph TD Q1{Are 2 units of remote control connected?} Q2{Is it set at the slave remote control?} Q3{Does it become normal?} Q4{Do more than one indoor units have the same address?} Q5{Are remote control wires laid along high voltage wires?} Q6{Does drain motor start 60 seconds later automatically.} Q1 -- YES --> S1[Set one remote control for "Master" and the other for "Slave"] S1 --> Q3 Q3 -- NO --> Q2 Q1 -- NO --> Q2 Q2 -- YES --> C1[Set SW1 on remote control PCB at "Master".] Q2 -- NO --> Q4 Q3 -- YES --> Q4 Q4 -- YES --> C2[Set address again. (SW2 on indoor control PCB)] Q4 -- NO --> Q5 Q5 -- YES --> C3[Separate remote control wires from high voltage wires.] Q5 -- NO --> S2[Disconnect the connecting wire ③ between the indoor and outdoor unit.] S2 --> S3[Power source reset] S3 --> Q6 Q6 -- YES --> C4[Defective indoor control PCB -> Replace.] Q6 -- NO --> C5[Defective remote control -> Change.] </pre>	

Note: If any error is detected 30 minutes after displaying “WAIT” on the remote control, the display changes to “INSPECT I/U”.

Error code Remote control: INSPECT I/U	LED	Green	Red	Content INSPECT I/U (Connection of 3 units or more remote control)
	Indoor	Keeps flashing	Stays OFF	

1. Applicable model
All models
2. Error detection method
Indoor unit cannot communicate for more than 30 minutes after the power on with remote control.
3. Condition of error displayed
Same as above
4. Presumable cause
<ul style="list-style-type: none"> • Improper setting • Surrounding environment • Defective remote control communication circuit • Faulty indoor control or power PCB • Faulty outdoor control PCB

5. Troubleshooting	
Diagnosis	Countermeasure
<pre> graph TD Q1{Are more than 3 units of remote control connected?} -- YES --> C1[Reduce to 2 units or less.] Q1 -- NO --> Q2{Does remote control display "Slave"?} Q2 -- YES --> C2[Change remote control setting to "Master". (SW1 on remote control PCB)] Q2 -- NO --> Q3{Do more than one indoor units have the same address?} Q3 -- YES --> C3[Change address. (SW2 on indoor control PCB)] Q3 -- NO --> Q4{Is it set to a slave indoor unit. SW5-1, 2?} Q4 -- YES --> C4[Change to master. (SW5-1, 2 on indoor control PCB)] Q4 -- NO --> Q5{Is there loose or wrong connection at the terminal of wiring between indoor and outdoor units?} Q5 -- YES --> C5[Correct] Q5 -- NO --> Q6{Is the grounding wire connected properly?} Q6 -- YES --> C6[Correct] Q6 -- NO --> Q7{Is approx. DC20V detected between ②(N)-③ on the outdoor unit terminal block?} Q7 -- YES --> C7[Defective outdoor control PCB -> Replace.] Q7 -- NO --> Q8{Is approx. DC20V detected between ②-③ on the indoor unit terminal block?} Q8 -- YES --> C8[Broken connecting wire -> Correct.] Q8 -- NO --> C9[Defective indoor control or power PCB -> Replace.] </pre>	

Note: If any error is detected 30 minutes after displaying “WAIT” on the remote control, the display changes to “INSPECT I/U”.

Error code Remote control: 🏠WAIT🏠	LED	Green	Red	Content Communication error at initial operation (1/3)
	Indoor	Keeps flashing	Stays OFF	

1. Applicable model
All models
When the remote control LCD displays “🏠WAIT🏠” 2 minutes after the power on.

2. Error detection method

3. Condition of error displayed

4. Presumable cause

- Blown fuse
- Faulty outdoor control PCB
- Connection between PCB's
- Faulty indoor control PCB
- Defective remote control
- Broken remote control wire

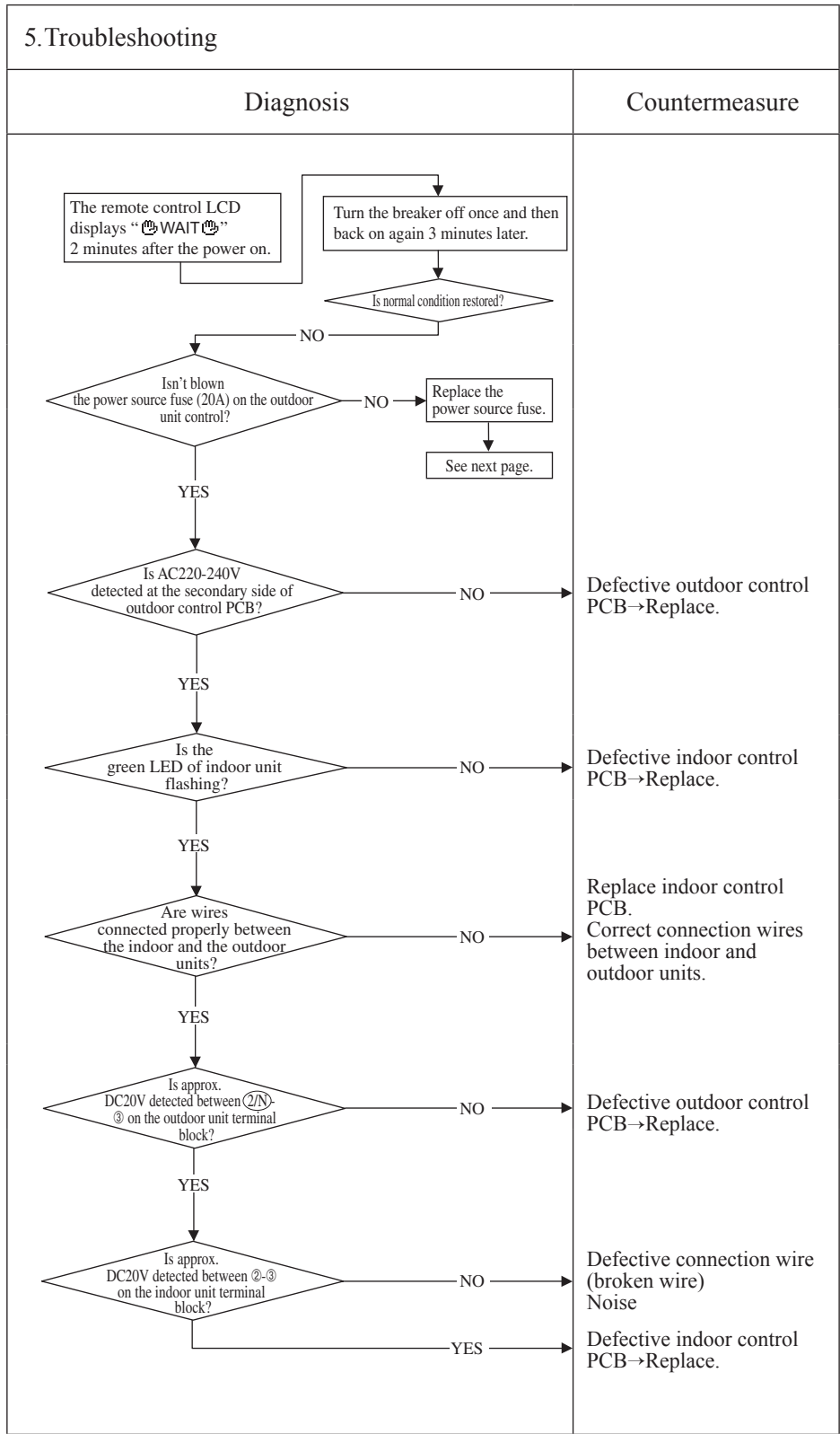

Note: If any anomaly is detected during communication, the error code E5 is displayed. Inspection procedure is same as above. (Excluding matters related to connection) When the power source is reset after the occurrence of E5, the LED will display “🏠WAIT🏠” if the anomaly continues. If the breaker ON/OFF is repeated in a short period of time (within 1 minute), “🏠WAIT🏠” may be displayed. In such occasion, turn the breaker off and wait for 3 minutes.

Error code Remote control: 🗄️ WAIT 🗄️	LED	Green	Red	Content Communication error at initial operation (2/3)
	Indoor	Keeps flashing	Stays OFF	

1. Applicable model

All models

When the fuse is blown, the method to inspect outdoor PCB before replacing the power source fuse

2. Error detection method

3. Condition of error displayed

4. Presumable cause

- Blown fuse
- Faulty outdoor control PCB
- Faulty reactor

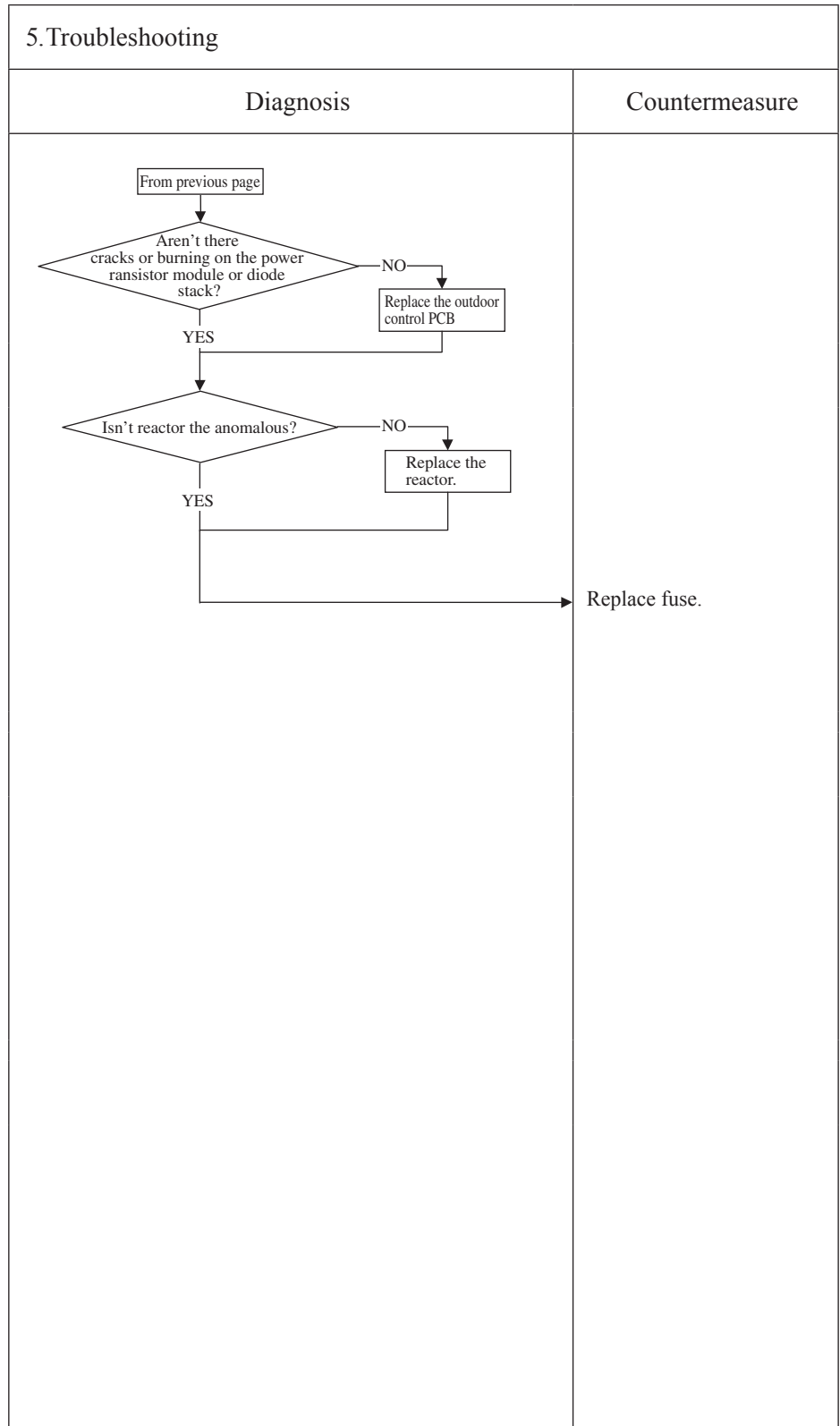

Note:

Error code Remote control: 🖱️WAIT🖱️	LED	Green	Red	Content Communication error at initial operation (3/3)
	Indoor	Keeps flashing	Stays OFF	

1. Applicable model
All models
When the remote control display is extinguished after the power on.

2. Error detection method

3. Condition of error displayed

- 4. Presumable cause**
- Blown fuse
 - Connection between PCB's
 - Blown fuse
 - Faulty indoor control PCB
 - Defective remote control
 - Wire breakage on remote control
 - Faulty outdoor control PCB

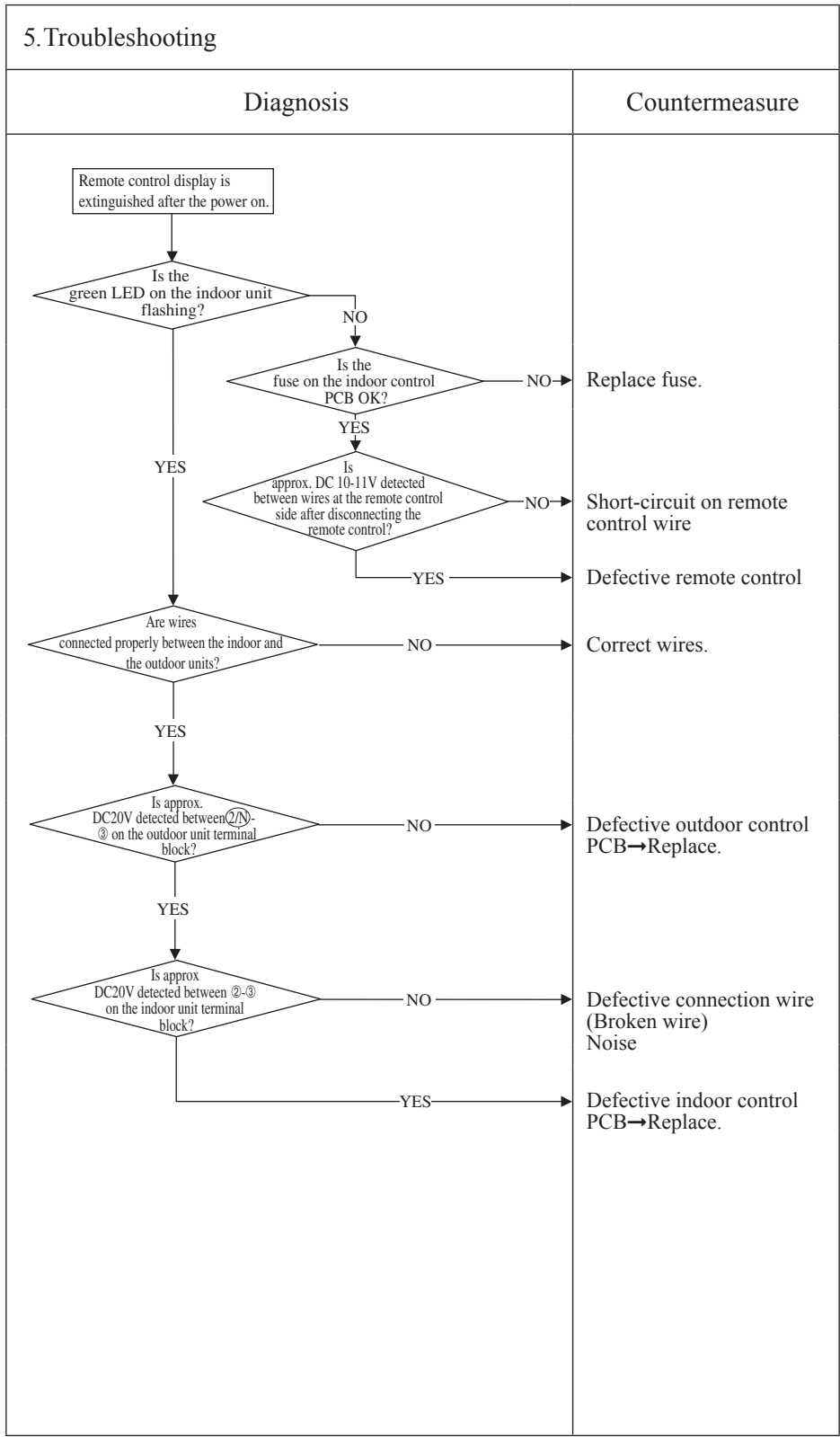

Note:

Error code Remote control: E1	LED	Green	Red	Content
	Indoor	Keeps flashing	Stays OFF	

Remote control communication circuit error

1. Applicable model
All models
2. Error detection method
When normal communication between the remote control and the indoor unit is interrupted for more than 2 minutes. (Detectable only with the remote control)
3. Condition of error displayed
Same as above
4. Presumable cause
<ul style="list-style-type: none"> • Defective communication circuit between remote control-indoor unit • Noise • Defective remote control • Faulty indoor control PCB

5. Troubleshooting	
Diagnosis	Countermeasure
<pre> graph TD A{Is it possible to reset normally by the power source reset?} -- YES --> B[Malfunction by noise Check peripheral environment.] A -- NO --> C[Turn SW7-1 to OFF. → ON Remove the wire ③ connecting between indoor/outdoor units.] C --> D[Power source reset] D --> E{Does the drain pump restart automatically 1 minute later?} E -- YES --> F[Defective indoor control PCB → Replace.] E -- NO --> G[Defective remote control → Replace.] </pre> <p>Note (2) Does the remote control still display “WAIT” even after 3 minutes?</p>	

Note: If the indoor unit cannot communicate normally with the remote control for 180 seconds, the indoor unit PCB starts to reset automatically.

Error code Remote control: E5	LED	Green	Red	Content Communication error during operation
	Indoor	Keeps flashing	2-time flash	

1. Applicable model
All models
2. Error detection method
When normal communication between indoor and outdoor unit is interrupted for more than 2 minutes.
3. Condition of error displayed
Same as above is detected during operation.
4. Presumable cause
<ul style="list-style-type: none"> • Unit No. setting error • Broken remote control wire • Faulty remote control wire connection • Faulty outdoor control PCB

5. Troubleshooting	
Diagnosis	Countermeasure
<p>Note (1) Inspect faulty connections (disconnection, looseness) on the outdoor unit terminal block.</p> <p>Is the connection of signal wires at the outdoor unit side OK?</p> <p>NO → Repair signal wires.</p> <p>YES</p> <p>Note (2) Check for faulty connection or breakage of signal wires between indoor-outdoor units.</p> <p>Is the connection of signal wires between indoor-outdoor units OK?</p> <p>NO → Repair signal wires.</p> <p>YES</p> <p>Power source reset</p> <p>Has the remote control LCD returned to normal state?</p> <p>NO → Defective outdoor control PCB (Defective network communication circuit) → Replace.</p> <p>YES → Unit is normal. (Malfunction by temporary noise, etc.)</p>	

Note:

Error code Remote control: E6	LED	Green	Red	Content Indoor heat exchanger temperature thermistor anomaly
	Indoor	Keeps flashing	1-time flash	

1. Applicable model
All models

2. Error detection method
Anomalously low temperature or high temperature (resistance) is detected on the indoor heat exchanger thermistor (Thi-R1, R2 or R3).

3. Condition of error displayed

- When the temperature thermistor detects -50°C or lower for 5 seconds continuously, the compressor stops. After 3-minutes delay, the compressor starts again automatically, but if this error occurs again within 60 minutes after the initial detection.
- Or if 70°C or higher is detected for 5 seconds continuously.

4. Presumable cause

- Defective indoor heat exchanger thermistor connector
- Indoor heat exchanger temperature thermistor anomaly
- Faulty indoor control PCB

5. Troubleshooting

Diagnosis	Countermeasure
<pre> graph TD Q1{Is the connection of indoor heat exchanger temperature thermistor connector OK?} Q2{Are characteristics of indoor heat exchanger temperature thermistor OK?} C1[Correct. -> Insert connector securely.] C2[Defective indoor heat exchanger temperature thermistor -> Replace.] C3[Defective indoor control PCB -> Replace. (Defective indoor unit heat exchanger temperature thermistor input circuit)] Q1 -- NO --> C1 Q1 -- YES --> Q2 Q2 -- NO --> C2 Q2 -- YES --> C3 </pre>	
<p>(Broken wire)</p> <p>(Short circuit)</p>	

Note:

Error code Remote control: E7	LED	Green	Red	Content Return air temperature thermistor anomaly
	Indoor	Keeps flashing	1-time flash	

1. Applicable model
All models

2. Error detection method
Anomalously low temperature or high temperature (resistance) is detected by indoor return air temperature thermistor (Thi-A)

3. Condition of error displayed

- When the temperature thermistor detects -50°C or lower for 5 seconds continuously, the compressor stops. After 3-minute delay, the compressor starts again automatically, but if this error occurs again within 60 minutes after the initial detection.

4. Presumable cause

- Defective return air temperature thermistor connector
- Defective return air temperature thermistor
- Faulty indoor control PCB

5. Troubleshooting

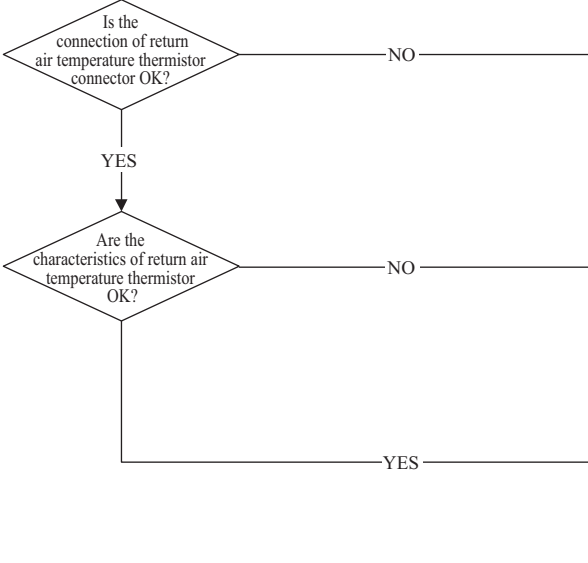
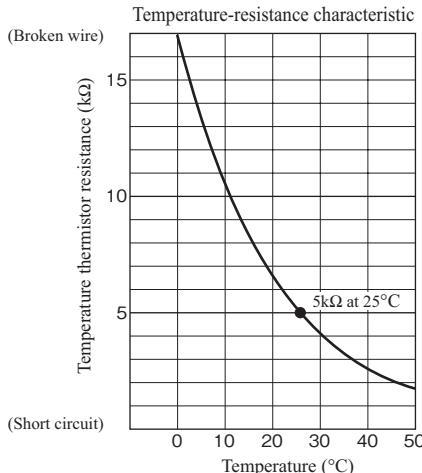
Diagnosis	Countermeasure
 <pre> graph TD Q1{Is the connection of return air temperature thermistor connector OK?} Q2{Are the characteristics of return air temperature thermistor OK?} C1[Correct. -> Connect connector.] C2[Defective return air temperature thermistor -> Replace.] C3[Defective indoor control PCB -> Replace. (Defective return air temperature thermistor input circuit)] Q1 -- NO --> C1 Q1 -- YES --> Q2 Q2 -- NO --> C2 Q2 -- YES --> C3 </pre>	
<p>Temperature-resistance characteristic</p>  <p>(Broken wire)</p> <p>(Short circuit)</p>	

Note:

Error code	LED	Green	Red	Content
Remote control: E8	Indoor	Keeps flashing	1-time flash	Heating overload operation

1. Applicable model

All models

2. Error detection method

Indoor heat exchanger temperature thermistor (Thi-R1, R2, R3)

3. Condition of error displayed

When it is detected 5 times within 60 minutes from initial detection or when the overload condition is detected for 6 minutes continuously.

4. Presumable cause

- Clogged air filter
- Defective indoor heat exchanger temperature thermistor connector
- Defective indoor heat exchanger temperature thermistor
- Anomalous refrigerant system

5. Troubleshooting

Diagnosis	Countermeasure
<pre> graph TD Q1{Is the air filter clogged?} -- YES --> C1[Wash.] Q1 -- NO --> Q2{Is the indoor heat exchanger temperature thermistor connection OK?} Q2 -- YES --> Q3{Are the characteristics of indoor heat exchanger temperature thermistor OK?} Q2 -- NO --> C2[Defective indoor heat exchanger temperature thermistor connector -> Correct.] Q3 -- YES --> R1[Check the error data with the remote control.] Q3 -- NO --> C3[Defective indoor heat exchanger temperature thermistor.] R1 --> Q4{Is the unit operating in the state of heating overload?} Q4 -- YES --> C4[Adjust] Q4 -- NO --> C5[Check refrigerant system.] </pre> <p>Note (1) Judge if it is in the state of overload or not as follows.</p> <ul style="list-style-type: none"> ▲ Is there any short-circuit of air? ▲ Isn't there any fouling or clogging on the indoor heat exchanger? ▲ Is the outdoor fan control normal? ▲ Isn't the indoor and outdoor air temperature too high? <p>Note (2) For characteristics of indoor heat exchanger temperature thermistor, see the error display E6.</p> <p>Indoor heat exchanger temperature (°C)</p>	<p>Wash.</p> <p>Defective indoor heat exchanger temperature thermistor connector → Correct.</p> <p>Defective indoor heat exchanger temperature thermistor.</p> <p>Check refrigerant system.</p> <p>Adjust</p>

Note: During heating operation; After starting compressor, compressor rotation speed is decreased by detecting indoor heat exchanger temperature (Thi-R) in order to control high pressure.

Error code Remote control: E9	LED	Green	Red	Content Drain trouble (FDT, FDU, FDUM series)
	Indoor	Keeps flashing	1-time flash	

1. Applicable model
FDT, FDU, FDUM series only
2. Error detection method
Float switch is activated
3. Condition of error displayed
If the float switch OPEN is detected for 3 seconds continuously or if float switch connector or wire is disconnected.
4. Presumable cause
<ul style="list-style-type: none"> • Defective indoor control or power PCB • Float switch setting error • Humidifier drain motor interlock setting error • Optional equipment setting error • Drain piping error • Defective drain motor • Disconnection of drain motor wiring

5. Troubleshooting	
Diagnosis	Countermeasure
<pre> graph TD Start[Check the error data in the remote control.] --> Overflow{Is there any overflow?} Overflow -- NO --> DC12V_CNI{Is DC 12V at CNI connector.} DC12V_CNI -- YES --> CheckFloat[Check float switch.] DC12V_CNI -- NO --> CNI_Firmly{Is the CNI connected firmly?} CNI_Firmly -- NO --> DefectivePCB1[Defective indoor control PCB → Replace.] CNI_Firmly -- YES --> Anomaly{Is there any anomaly on the optional equipment?} Anomaly -- NO --> DefectivePCB2[Defective indoor control PCB → Replace.] Anomaly -- YES --> CheckOption[Check option equipment] Overflow -- YES --> Humidifier{Is the humidifier connected?} Humidifier -- YES --> Interlock{Is the humidifier drain motor interlocked by the indoor unit function setting of remote control?} Interlock -- YES --> DrainMotorON[Drain motor ON from the remote control] Interlock -- NO --> CorrectSetting[Correct setting to "Humidifier drain motor interlock".] DrainMotorON --> Operate{Does drain motor operate?} Operate -- NO --> DC12V_CNR{Is DC12V detected at CNR connector?} DC12V_CNR -- YES --> CheckWiring[Check wiring of drain motor] DC12V_CNR -- NO --> DefectivePCB3[Defective indoor control PCB → Replace.] Operate -- YES --> Piping{Is the drain piping unclogged? Is the drain pipe slop OK?} Piping -- NO --> Correct[Correct.] Piping -- YES --> CheckMotor[Check drain motor.] </pre>	

Note: When this error occurred at power ON, disconnection of wire or connector of the float switch is suspected. Check and correct it (or replace it, if necessary).

Error code Remote control: E10	LED	Green	Red	Content Excessive number of connected indoor units (more than 17 units) by controlling with one remote control
	Indoor	Keeps flashing	Stays OFF	

1. Applicable model	5. Troubleshooting	
All models	Diagnosis	Countermeasure
	<pre> graph LR A{Aren't more than 17 indoor units connected to one remote control?} -- NO --> B[Defective remote control -> Replace.] A -- YES --> C[Reduce to 16 or less units.] </pre>	
2. Error detection method		
When it detects more than 17 of indoor units connected to one remote control		
3. Condition of error displayed		
Same as above		
4. Presumable cause		
<ul style="list-style-type: none"> • Excessive number of indoor units connected • Defective remote control 		

Note:

Error code Remote control: E11	LED	Green	Red	Content Address setting error of indoor units
	Indoor	Keeps flashing	Keeps flashing	

1.Applicable model
All models

2.Error detection method
Indoor unit address has been set using the “Indoor unit address set” function of remote control.

3.Condition of error displayed
Same as above

4.Presumable cause
Wrong address setting method. (It cannot set addresses from the remote control.)

5.Troubleshooting	
Diagnosis	Countermeasure
<pre> graph TD A[E11 occurs] --> B{Is "Indoor unit address set" function of remote control used?} B -- YES --> C[Change of address setting method. Addresses are set using the dip switch (SW2) on the indoor control PCB. (Refer to the page 120.)] </pre>	
<p>In case the wiring is below and “Indoor unit address set” is used, E11 is appeared.</p> <pre> graph TD RC[R/C] --- J(()) J --- IU1[IU 1] J --- IU2[IU 2] J --- IU3[IU 3] </pre>	
<p>Change of address setting method. Addresses are set using the dip switch (SW2) on the indoor control PCB. (Refer to the page 120.)</p>	

Note:

<table border="1"> <tr> <td>Error code</td> <td>LED</td> <td>Green</td> <td>Red</td> <td>Content</td> </tr> <tr> <td>Remote control: E16</td> <td>Indoor</td> <td>Keeps flashing</td> <td>1(2)-time flash</td> <td rowspan="2">Indoor fan motor anomaly</td> </tr> </table>	Error code	LED	Green	Red	Content	Remote control: E16	Indoor	Keeps flashing	1(2)-time flash	Indoor fan motor anomaly
Error code	LED	Green	Red	Content						
Remote control: E16	Indoor	Keeps flashing	1(2)-time flash	Indoor fan motor anomaly						

Note(1) Value in () is for the FDU, FDUM series FMI2 only.

<p>1. Applicable model</p> <p>All models</p>	5. Troubleshooting	
<p>2. Error detection method</p> <p>Detected by rotation speed of indoor fan motor</p>	Diagnosis	Countermeasure
<p>3. Condition of error displayed</p> <p>When actual rotation speed of indoor fan motor drops to lower than 200min^{-1} for 30 seconds continuously, the compressor and the indoor fan motor stop. After 2-seconds, it starts again automatically, but if this error occurs 4 times within 60 minutes after the initial detection.</p>	<pre> graph TD D1{Does any foreign material intervene in rotational area of fan propeller?} -- YES --> C1[Remove foreign material.] D1 -- NO --> D2{Does the fan rotate smoothly when turned by hand?} D2 -- YES --> D3{Is DC280V detected between ①-④ of fan motor connector CNM?} D2 -- NO --> C2[Replace the fan motor.] D3 -- YES --> PR[Power source reset] D3 -- NO --> D4{Is the fuse F3 or F4 (FDF: F202, F203) blown?} PR --> D5{Is it normalized?} D4 -- YES --> C3[Replace faulty fan motor and power PCB.] D4 -- NO --> C4[Check power voltage.] D5 -- YES --> C5[Malfunction by temporary noise] D5 -- NO --> C6[Replace fan motor. (If the error persists after replacing the fan motor, replace the indoor control PCB.)] </pre>	
<p>4. Presumable cause</p> <ul style="list-style-type: none"> • Defective indoor power PCB • Foreign material at rotational area of fan propeller • Defective fan motor • Dust on control PCB • Blown fuse • External noise, surge 		

Note:

Error code Remote control: E19	LED	Green	Red	Content Indoor unit operation check
	Indoor	Keeps flashing	1-time flash	

1. Applicable model
All models

2. Error detection method
After indoor operation check, when the communication between indoor and outdoor unit is established and SW7-1 is still kept ON.

3. Condition of error displayed
Same as above

4. Presumable cause
Mistake in SW7-1 setting (Due to forgetting to turn OFF SW7-1 after indoor operation check)

5. Troubleshooting	
Diagnosis	Countermeasure
<pre> graph TD Start[E19 occurs when the power ON] --> Decision{Is SW7-1 on the indoor control PCB ON?} Decision -- YES --> Countermeasure1[Turn SW7-1 on the indoor control PCB OFF and reset the power] Decision -- NO --> Countermeasure2[Defective indoor control PCB (Defective SW7) → Replace] </pre>	

Note:

Error code Remote control: E20	LED	Green	Red	Content Indoor fan motor rotation speed anomaly
	Indoor	Keeps flashing	1(2)-time flash	

Note(1) Value in () is for the FDU, FDUM series FMI2 only.

<p>1.Applicable model</p> <p>All models</p>	5.Troubleshooting	
<p>2.Error detection method</p> <p>Detected by rotation speed of indoor fan motor</p>	Diagnosis	Countermeasure
<p>3.Condition of error displayed</p> <p>When the actual fan rotation speed does not reach to the speed of [required speed -50 (FDU:-500) min⁻¹] after 2 minutes have been elapsed since the fan motor rotation speed command was output, the unit stops by detecting indoor fan motor anomaly.</p>	<pre> graph TD D1{Does any foreign material intervene in rotational area of fan propeller?} -- YES --> C1[Remove foreign material.] D1 -- NO --> D2{Does the fan rotate smoothly when turned by hand?} D2 -- YES --> D3{Is DC280V detected between ①-④ of fan motor connector CNM?} D2 -- NO --> C2[Replace the fan motor.] D3 -- YES --> PR[Power source reset] D3 -- NO --> D4{Is the fuse F3 or F4 (FDF: F202, F203) blown?} PR --> D5{Is it normalized?} D4 -- YES --> C3[Replace faulty fan motor and power PCB.] D4 -- NO --> C4[Check power voltage.] D5 -- YES --> C5[Malfunction by temporary noise] D5 -- NO --> C6[Replace fan motor. (If the error persists after replacing the fan motor, replace the indoor control PCB.)] </pre>	
<p>4.Presumable cause</p> <ul style="list-style-type: none"> • Defective indoor power PCB • Foreign material at rotational area of fan propeller • Defective fan motor • Dust on control PCB • Blown fuse • External noise, surge 		

Note:

Error code Remote control: E21	LED	Green	Red	Content
	Indoor	Keeps flashing	1-time flash	

Defective panel switch operation (FDT series)

<p>1. Applicable model</p> <p>FDT series only</p>	<p>5. Troubleshooting</p>	
<p>2. Error detection method</p> <p>Panel switch (PS) has detected Open for more than 1 second.</p>	<p style="text-align: center;">Diagnosis</p> <pre> graph TD Q1{Is grill opened?} -- YES --> C1[Reset the error and close the grill.] Q1 -- NO --> Q2{Does matter improve if panel switch is turned ON forcibly after resetting error?} Q2 -- YES --> C2["Insufficient push on the panel switch at the internal face of grill -> Attach 3 mm thick rubber sheet at the section where the panel switch touches the inside of grill. Close then the grill."] Q2 -- NO --> Q3{Are connectors at right inserted properly?} Q3 -- NO --> C3["Disconnected, poorly connected connectors -> Reinsert properly."] Q3 -- YES --> Q4{Is there continuity between ①-④ of CNV on indoor control PCB when panel switch operation is checked?} Q4 -- NO --> C4["• Defective panel switch or incorrect panel switch wiring -> Replace panel switch. • Broken wire between panel switch PCB (CNV) -> Correct or replace wire."] Q4 -- YES --> C5[Defective indoor control PCB -> Replace indoor control PCB.] </pre>	<p style="text-align: center;">Countermeasure</p>
<p>3. Condition of error displayed</p> <p>Same as above</p>		
<p>4. Presumable cause</p> <ul style="list-style-type: none"> • Defective panel switch • Disconnection of wiring • Defective indoor control PCB 		

Note:

Error code Remote control: E28	LED	Green	Red	Content Remote control temperature thermistor anomaly
	Indoor	Keeps flashing	Stays OFF	

1. Applicable model
All models

2. Error detection method
Detection of anomalously low temperature (resistance) of remote control temperature thermistor (Thc)

3. Condition of error displayed
When the temperature thermistor detects -50°C or lower for 5 seconds continuously, the compressor stops. After 3-minutes delay, the compressor starts again automatically, but if this error occurs again within 60 minutes after the initial detection.

4. Presumable cause

- Faulty connection of remote control temperature thermistor
- Defective remote control temperature thermistor
- Defective remote control PCB

5. Troubleshooting

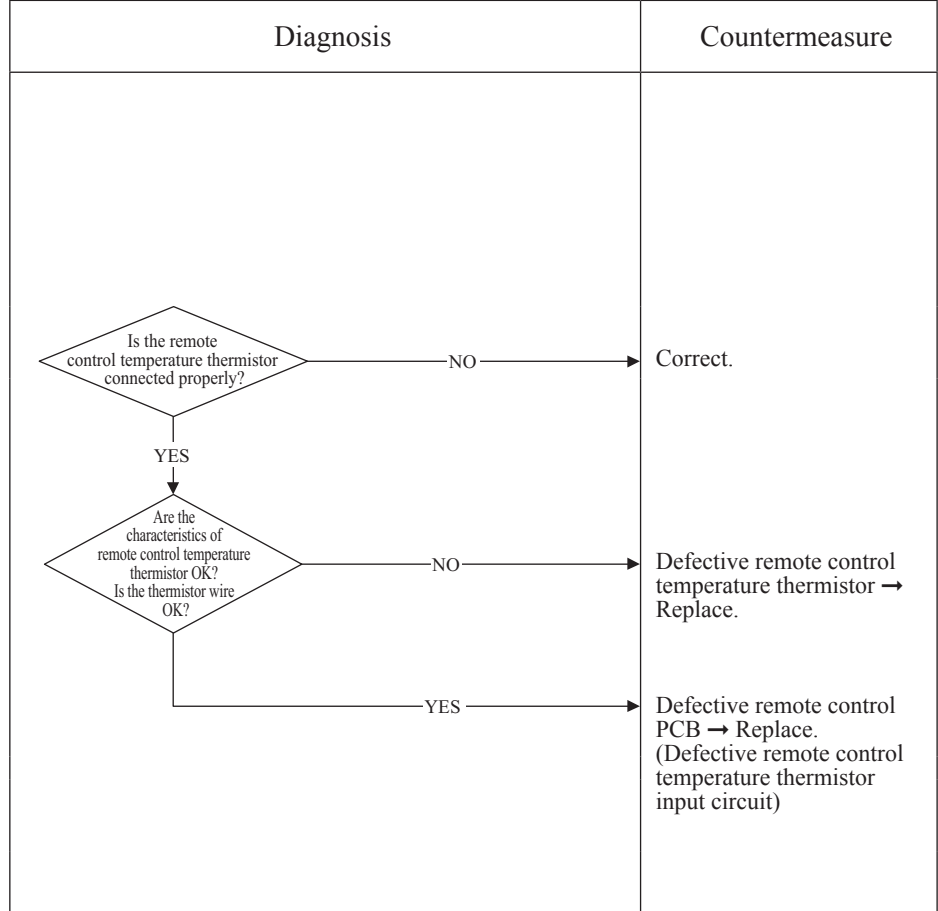

Resistance-temperature characteristics of remote control temperature thermistor (Thc)

Temperature (°C)	Resistance value (kΩ)	Temperature (°C)	Resistance value (kΩ)
0	65	30	16
1	62	32	15
2	59	34	14
4	53	36	13
6	48	38	12
8	44	40	11
10	40	42	9.9
12	36	44	9.2
14	33	46	8.5
16	30	48	7.8
18	27	50	7.3
20	25	52	6.7
22	23	54	6.3
24	21	56	5.8
26	19	58	5.4
28	18	60	5.0

Note: After 10 seconds has passed since remote control thermistor was switched from valid to invalid, E28 will not be displayed even if the thermistor harness is disconnected. At same time the thermistor, which is effective, is switched from remote control thermistor to indoor return air temperature thermistor. Even though the remote control thermistor is set to be Effective, the return air temperature displayed on remote control for checking still shows the value detected by indoor return air temperature thermistor, not by remote control temperature thermistor.

Error code Remote control: E35	LED	Green	Red	Content Cooling overload operation
	Indoor	Keeps flashing	Stays OFF	

1.Applicable model
All models

2. Error detection method
<p>Outdoor heat exchanger temperature (°C)</p> <p>Note (1) Values in () are applicable when outdoor temperature (TH2) is lower than 31 °C</p>

3. Condition of error displayed
When anomalous outdoor heat exchanger temperature occurs 5 times within 60 minutes or 60(56)°C or higher continues for 10 minutes, including the compressor stop.

4. Presumable cause
<ul style="list-style-type: none"> • Defective outdoor heat exchanger temperature sensor • Defective outdoor control PCB • Indoor, outdoor unit installation spaces • Short-circuit of air on indoor, outdoor units • Fouling, clogging of heat exchanger • Excessive refrigerant quantity

5. Troubleshooting	
Diagnosis	Countermeasure
<p style="text-align: right;">* For the characteristics of outdoor heat exchanger temperature sensor, refer to E37.</p> <p style="text-align: right;">* For the contents of control, refer to the protective control by controlling compressor rotation speed and cooling high pressure protective control of micro computer control function for corresponding models.</p>	<p>Replace outdoor heat exchanger temperature sensor.</p> <p>Check unit side.</p> <ul style="list-style-type: none"> • Isn't the air circulation of outdoor unit short-circuited? • Are installation spaces adequate? • Isn't there any fouling or clogging on heater exchanger? <p>Control operation check*</p> <p>Defective outdoor control PCB → Replace.</p> <p>Excessive refrigerant amount: Recharge refrigerant by weighing proper amount on a scale.</p>

Note:

Error code Remote control: E36	LED	Green	Red	Content Discharge pipe temperature error
	Indoor	Keeps flashing	Stays OFF	

1. Applicable model
All models
2. Error detection method
For the error detection method, refer to the protective control by controlling compressor rotation speed and cooling high pressure protective control of micro computer control function for corresponding models.
3. Condition of error displayed
When discharge pipe temperature anomaly is detected 2 times within 60 minutes is compressor stop.
4. Presumable cause
<ul style="list-style-type: none"> • Defective outdoor control PCB • Defective discharge pipe temperature sensor • Clogged filter • Indoor, outdoor unit installation spaces • Short-circuit of air on indoor, outdoor units • Fouling, clogging of heat exchanger

5. Troubleshooting	
Diagnosis	Countermeasure
<p>* For the characteristics of discharge pipe temperature, refer to E39.</p> <pre> graph TD D1{Are the characteristics of discharge pipe temperature sensor normal?} D2{Is the discharge pipe temperature error persisted during cooling operation?} D3{Is the discharge pipe temperature control normal?} D4{Is the temperature (measured actually) at detection of error correct?} D1 -- NO --> C1[Replace discharge pipe temperature sensor.] D1 -- YES --> D2 D2 -- YES --> C2[Insufficient refrigerant amount: Recharge refrigerant by weighing proper amount on a scale.] D2 -- NO --> D3 D3 -- NO --> C3[Control operation check *] D3 -- YES --> D4 D4 -- NO --> C4[Defective outdoor control PCB -> Replace.] D4 -- YES --> C5[Check unit side: • Isn't filter clogged? • Are adequate indoor, outdoor unit installation spaces? • Isn't there any short-circuit of air? • Isn't there any fouling, clogging on indoor heat exchanger?] </pre>	
<p>* For the contents of control, refer to the protective control by controlling compressor rotation speed and cooling high pressure protective control of micro computer control function for corresponding models.</p>	

Note:

Error code Remote control: E37	LED	Green	Red	Content Outdoor heat exchanger temperature sensor anomaly
	Indoor	Keeps flashing	Stays OFF	

1. Applicable model
All models

2. Error detection method
Detection of anomalously low temperature (resistance) on the outdoor heat exchanger temperature sensor

3. Condition of error displayed

- When the temperature sensor detects -55 °C or lower for 20 seconds continuously within 2 minutes to 2 minutes 20 seconds after the compressor ON, the compressor stops. After 3-minutes delay, the compressor starts again automatically, but if this anomalous temperature is detected 3 times within 40 minutes.
- When -55 °C or lower is detected for within 20 second after power ON.

4. Presumable cause

- Defective outdoor control PCB
- Broken sensor harness or temperature sensing section
- Disconnected wire connection (connector)

5. Troubleshooting

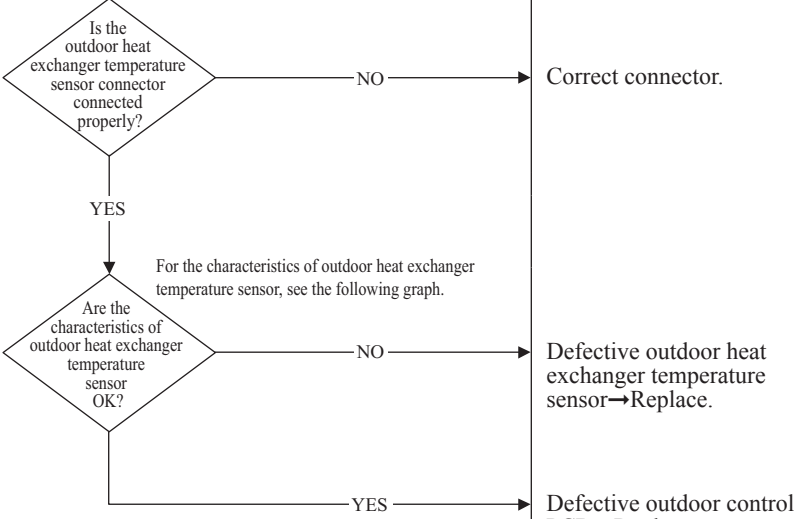
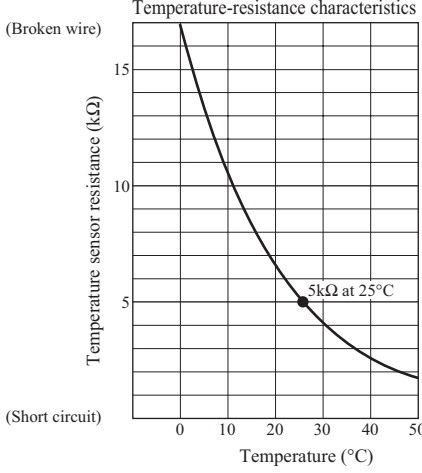
Diagnosis	Countermeasure
 <pre> graph TD Q1{Is the outdoor heat exchanger temperature sensor connector connected properly?} Q2{Are the characteristics of outdoor heat exchanger temperature sensor OK?} C1[Correct connector.] C2[Defective outdoor heat exchanger temperature sensor -> Replace.] C3[Defective outdoor control PCB -> Replace. (Defective outdoor heat exchanger temperature sensor input circuit)] Q1 -- NO --> C1 Q1 -- YES --> G1[For the characteristics of outdoor heat exchanger temperature sensor, see the following graph.] G1 --> Q2 Q2 -- NO --> C2 Q2 -- YES --> C3 </pre>	
<p>Temperature-resistance characteristics</p>  <p>(Broken wire)</p> <p>(Short circuit)</p>	

Note:

Error code Remote control: E38	LED	Green	Red	Content Outdoor air temperature sensor anomaly
	Indoor	Keeps flashing	Stays OFF	

1. Applicable model
All models

2. Error detection method
Detection of anomalously low temperature (resistance) on outdoor air temperature sensor

3. Condition of error displayed

- When the temperature sensor detects -55 °C or lower for 5 seconds continuously within 2 minutes to 2 minutes 20 seconds after the compressor ON, the compressor stops. After 3-minutes delay, the compressor starts again automatically, but if this anomalous temperature is detected 3 times within 40 minutes.
- When -55 °C or lower is detected for within 20 second after power ON.

4. Presumable cause

- Defective outdoor control PCB
- Broken sensor harness or temperature sensing section (Check molding.)
- Disconnected wire connection (connector)

5. Troubleshooting

Diagnosis	Countermeasure
	<p>Correct connector.</p> <p>Defective outdoor air temperature sensor → Replace.</p> <p>Defective outdoor control PCB → Replace. (Defective outdoor air temperature sensor input circuit)</p>

Temperature-resistance characteristics

(Broken wire)

(Short circuit)

Note:

Error code Remote control: E39	LED	Green	Red	Content Discharge pipe temperature sensor anomaly
	Indoor	Keeps flashing	Stays OFF	

1.Applicable model
All models

2.Error detection method
Detection of anomalously low temperature (resistance) on the discharge pipe temperature sensor

3.Condition of error displayed
When the temperature sensor detects -25 °C or lower for 5 seconds continuously within 10 minutes to 10 minutes 20 seconds after the compressor ON, the compressor stops. After 3-minutes delay, the compressor starts again automatically, but if this anomalous temperature is detected 3 times within 40 minutes.

4.Presumable cause
<ul style="list-style-type: none"> • Defective outdoor control PCB • Broken sensor harness or temperature sensing section (Check molding.) • Disconnected wire connection (connector)

5.Troubleshooting	
Diagnosis	Countermeasure
<p>(Broken wire) Temperature-resistance characteristics</p>	

Note:

Error code Remote control: E42	LED	Green	Red	Content Current cut (1/2)
	Indoor	Keeps flashing	Stays OFF	

1.Applicable model
All models

2.Error detection method
In order to prevent from overcurrent of inverter, if the current exceeds the specifications, it makes the compressor stopping.

3.Condition of error displayed
• If the output current of inveter exceeds the specifications, it makes the compressor stopping.

4.Presumable cause
<ul style="list-style-type: none"> • The valves closed • Faulty power source • Insufficient refrigerant amount • Faulty compressor • Faulty power transistor module

5.Troubleshooting	
Diagnosis	Countermeasure
<pre> graph TD D1{Is the Power source voltage OK?} -- NO --> C1[Check power source.] D1 -- YES --> D2{Are the service valves opened?} D2 -- NO --> C2[Open the service valves.] D2 -- YES --> D3{Is the high pressure during operation OK?} D3 -- NO --> C3[Check refrigerant amount and refregerant circuit *In case of transitional increase of high pressure and/or test run, several times restarting may recover it, because liquid refrigerant (migrated) in the compressor is discharged from the compressor.] D3 -- YES --> D4{Is the checked result of insulation resistance and coil resistance (l) of compressor motor OK? (1) 0.510Ω or more at 20°C} D4 -- NO --> C4[Replace compressor.] D4 -- YES --> E[To next page.] </pre>	<p>Check power source.</p> <p>Open the service valves.</p> <p>Check refrigerant amount and refregerant circuit *In case of transitional increase of high pressure and/or test run, several times restarting may recover it, because liquid refrigerant (migrated) in the compressor is discharged from the compressor.</p> <p>Replace compressor.</p>

Note:

Error code Remote control: E42	LED	Green	Red	Content Current cut (2/2)
	Indoor	Keeps flashing	Stays OFF	

1. Applicable model
All models

2. Error detection method
In order to prevent from overcurrent of inverter, if the current exceeds the specifications, it makes the compressor stopping.

3. Condition of error displayed
• If the output current of inverter exceeds the specifications, it makes the compressor stopping.

4. Presumable cause

- Defective outdoor control PCB
- Faulty power source
- Insufficient refrigerant amount
- Faulty compressor
- Faulty power transistor module

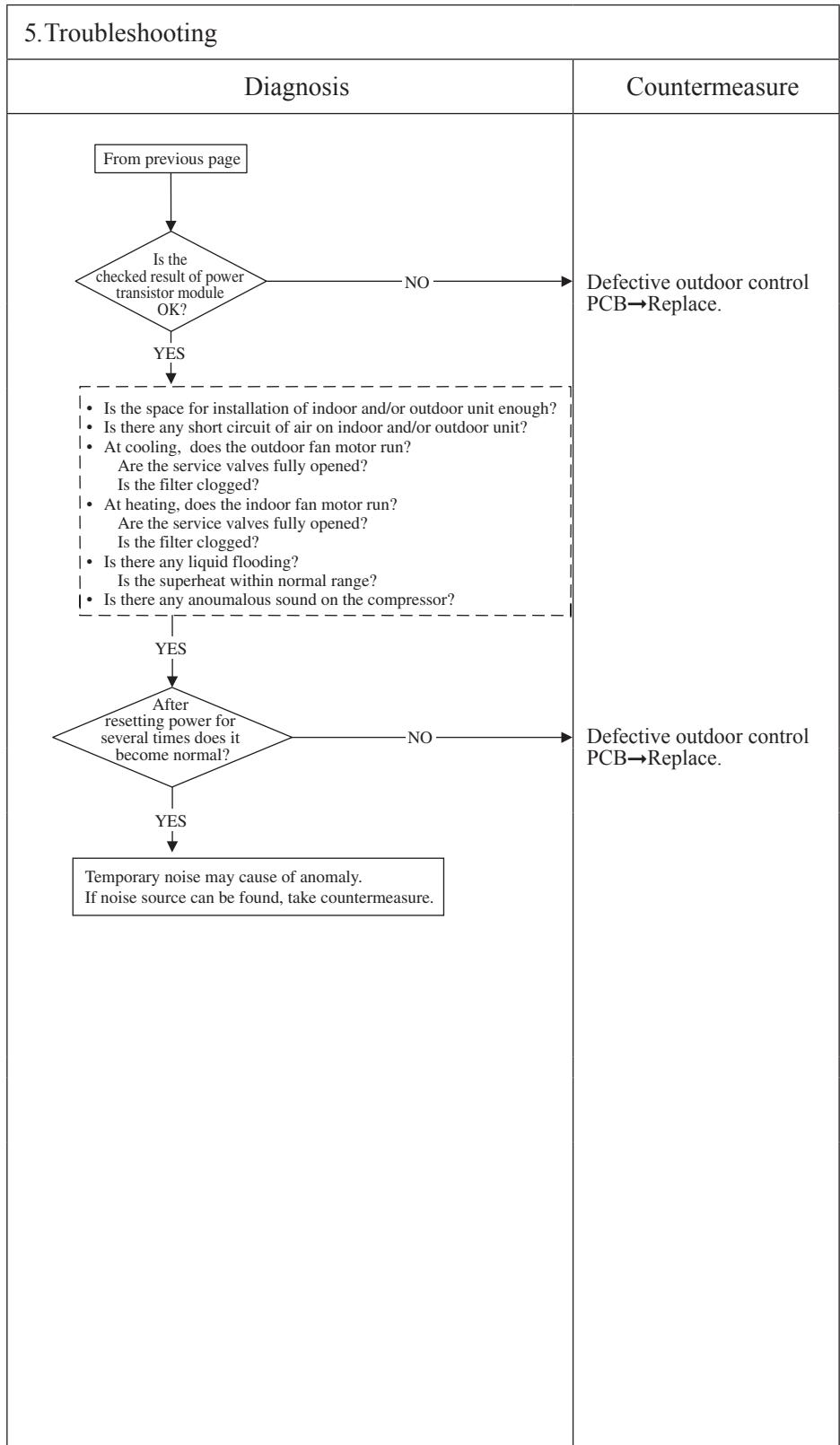

Note:

Error code Remote control: E47	LED	Green	Red	Content Active filter voltage error
	Indoor	Keeps flashing	Stays OFF	

1. Applicable model
All models

2. Error detection method
Error is displayed if the converter voltage exceeds target voltage (3 times within 20 minutes). Remote control may be set after 3 minutes delay. Error is displayed if the converter voltage is lower than DC 210V (1-time within 5 seconds after power ON)

3. Condition of error displayed
Same as above

4. Presumable cause
<ul style="list-style-type: none"> • Defective outdoor control PCB • Dust on outdoor control PCB • Anomalous power source

5. Troubleshooting	
Diagnosis	Countermeasure
<pre> graph TD A{Is the power source normal?} -- NO --> B[Restore normal condition.] A -- YES --> C{Is voltage within the specified range?} C -- NO --> D[Restore normal condition.] C -- YES --> E{Check soldered surfaces on the outdoor control PCB for foreign matter like dust, fouling, etc.} E -- NO --> F[Remove foreign matter like dust, fouling, etc.] E -- YES --> G[Defective outdoor control PCB -> Replace.] </pre>	

Note:

Error code Remote control: E48	LED	Green	Red	Content Outdoor fan motor anomaly
	Indoor	Keeps flashing	Stays OFF	

1. Applicable model
All models
2. Error detection method
Detected by rotation speed of outdoor fan motor
3. Condition of error displayed
When actual rotation speed of outdoor fan motor drops to 75min ⁻¹ or lower for 30 minutes continuously, the compressor and the outdoor fan motor stop. After 3-minutes delay, it starts again automatically, but if this anomaly occurs 3 times within 60 minutes after the initial detection.
4. Presumable cause
<ul style="list-style-type: none"> • Defective outdoor control PCB • Foreign material at rotational area of fan propeller • Defective fan motor • Dust on outdoor control PCB • Blown F3 fuse

5. Troubleshooting	
Diagnosis	Countermeasure
<pre> graph TD D1{Does any foreign material intervene in rotational area of fan propeller?} -- YES --> C1[Remove foreign matter.] D1 -- NO --> D2{Does the fan rotate smoothly when turned by hand?} D2 -- YES --> D3{Is DC280V detected between (CNFAN ④ -⑥) of fan motor connector?} D2 -- NO --> C2[Replace fan motor. If resistance between ① (FG) -④(GND) is detected 1kΩ or lower, it is faulty.] D3 -- YES --> R1[Power source reset] D3 -- NO --> D4{Is F3 (250V1A) fuse blown?} R1 --> D5{Is normal state restored?} D4 -- YES --> C3[Replace faulty fan motor and outdoor main PCB.] D4 -- NO --> C4[Check power source voltage.] D5 -- YES --> C5[Malfunction by temporary noise] D5 -- NO --> C6[Replace fan motor (If anomaly persists after replacing fan motor, replace outdoor control PCB.)] </pre>	

Note: When E48 error occurs, in almost cases F3 fuse (1A) on the outdoor control PCB is blown. There are a lot of cases that fuse is blown and E48 occurs due to defective fan motor. And even though only the outdoor control PCB (or fuse) is replaced,, another trouble could occur. Therefore when fuse is blown, check whether the fan motor is OK or not. After confirming the fan motor normal, check by power ON. (Don't power ON without confirming the fan motor normal.)

Error code Remote control: E51	LED	Green	Red	Content Power transistor anomaly
	Indoor	Keeps flashing	Stays OFF	

<p>1.Applicable model</p> <p>All models</p>	<p>5.Troubleshooting</p> <table border="1" style="width: 100%;"> <thead> <tr> <th style="width: 50%;">Diagnosis</th> <th style="width: 50%;">Countermeasure</th> </tr> </thead> <tbody> <tr> <td style="text-align: center;"> <pre> graph TD A{Check soldered surfaces on the outdoor control PCB for foreign matter like dust, fouling, etc.} -- NO --> B[Remove foreign matter like dust, fouling, etc.] A -- YES --> C{Isn't F8 fuse (250V, 20A) blown?} C -- YES --> D[Replace fuse.] C -- NO --> E[Defective outdoor control PCB -> Replace.] </pre> </td> <td></td> </tr> </tbody> </table>			Diagnosis	Countermeasure	<pre> graph TD A{Check soldered surfaces on the outdoor control PCB for foreign matter like dust, fouling, etc.} -- NO --> B[Remove foreign matter like dust, fouling, etc.] A -- YES --> C{Isn't F8 fuse (250V, 20A) blown?} C -- YES --> D[Replace fuse.] C -- NO --> E[Defective outdoor control PCB -> Replace.] </pre>	
Diagnosis	Countermeasure						
<pre> graph TD A{Check soldered surfaces on the outdoor control PCB for foreign matter like dust, fouling, etc.} -- NO --> B[Remove foreign matter like dust, fouling, etc.] A -- YES --> C{Isn't F8 fuse (250V, 20A) blown?} C -- YES --> D[Replace fuse.] C -- NO --> E[Defective outdoor control PCB -> Replace.] </pre>							
<p>2.Error detection method</p> <p>Power transistor primary current</p>							
<p>3.Condition of error displayed</p> <p>If the power transistor primary current exceeds the setting value for 3 seconds, the compressor stops.</p>							
<p>4.Presumable cause</p> <ul style="list-style-type: none"> • Faulty outdoor control PCB • Dust on outdoor control PCB • Blown fuse 							

Note:

Error code Remote control: E57	LED	Green	Red	Content Insufficient refrigerant amount or detection of service valve closure
	Indoor	Keeps flashing	Stays OFF	

1. Applicable model
All models
2. Error detection method
<ul style="list-style-type: none"> Judge insufficient refrigerant amount by detecting the temperature difference between indoor heat exchanger (Thi-R) and indoor return air (Thi-A).
3. Condition of error displayed
When the insufficient refrigerant amount is detected 3 times within 60 minutes.
4. Presumable cause
<ul style="list-style-type: none"> Defective indoor heat exchanger temperature thermistor Defective indoor return air temperature thermistor Defective indoor control PCB Insufficient refrigerant amount

5. Troubleshooting	
Diagnosis	Countermeasure
<pre> graph TD Q1{Is the service valve fully opened?} -- NO --> C1[Open fully.] Q1 -- YES --> Q2{Are the connections of indoor heat exchanger and/or return air temperature thermistor connectors OK?} Q2 -- NO --> C2[Correct indoor heat exchanger, return air temperature thermistor connector connections.] Q2 -- YES --> Q3{Are the characteristics of indoor heat exchanger and/or return air temperature thermistor OK?} Q3 -- NO --> C3[Defective indoor heat exchanger, return air temperature thermistor -> Replace.] Q3 -- YES --> Q4{Is the low pressure during operation normal?} Q4 -- NO --> C4[Charge refrigerant.] Q4 -- YES --> C5[Defective indoor control PCB -> Replace. (Defective indoor heat exchanger, return air temperature thermistor input circuits)] </pre>	
<p style="text-align: center;">Indoor heat exchanger, return air temperature thermistor Temperature-resistance characteristics</p> <p>(Broken wire)</p> <p>(Short circuit)</p>	

Note: When the compressor speed is 30 rps or under at 5 minutes after the start of compressor or the completion of defrosting, the low refrigerant protection control judges, by detecting the difference between the indoor heat exchanger temperature (Thi-R) and the indoor return air temperature (Thi-A), that it is in the state of gas low, and stops the compressor.
 Cooling: Indoor return air temperature (Thi-A) – Indoor heat exchanger temperature (Thi-R) \geq 4 deg
 Heating: Indoor heat exchanger temperature (Thi-R) – Indoor return air temperature (Thi-A) \leq 4 deg

Error code Remote control: E58	LED	Green	Red	Content Current safe stop
	Indoor	Keeps flashing	Stays OFF	

<p>1.Applicable model</p> <p>All models</p>	<p>5.Troubleshooting</p> <table border="1" style="width: 100%;"> <thead> <tr> <th style="width: 50%;">Diagnosis</th> <th style="width: 50%;">Countermeasure</th> </tr> </thead> <tbody> <tr> <td style="text-align: center;"> <pre> graph TD D1{Is the refrigerant amount normal?} -- NO --> C1[Adjust the refrigerant amount properly.] D1 -- YES --> D2{Is outdoor ventilation condition good?} D2 -- NO --> C2[Secure space for inlet and outlet.] D2 -- YES --> D3{Inspect compressor} D3 -- NO --> C3[Replace compressor.] D3 -- YES --> D4{Inspect outdoor air temperature sensor} D4 -- NO --> C4[Replace sensor.] D4 -- YES --> C5["Defective outdoor control PCB -> Replace. (Defective outdoor air temperature sensor input circuit)"] </pre> </td> <td></td> </tr> </tbody> </table>			Diagnosis	Countermeasure	<pre> graph TD D1{Is the refrigerant amount normal?} -- NO --> C1[Adjust the refrigerant amount properly.] D1 -- YES --> D2{Is outdoor ventilation condition good?} D2 -- NO --> C2[Secure space for inlet and outlet.] D2 -- YES --> D3{Inspect compressor} D3 -- NO --> C3[Replace compressor.] D3 -- YES --> D4{Inspect outdoor air temperature sensor} D4 -- NO --> C4[Replace sensor.] D4 -- YES --> C5["Defective outdoor control PCB -> Replace. (Defective outdoor air temperature sensor input circuit)"] </pre>	
Diagnosis	Countermeasure						
<pre> graph TD D1{Is the refrigerant amount normal?} -- NO --> C1[Adjust the refrigerant amount properly.] D1 -- YES --> D2{Is outdoor ventilation condition good?} D2 -- NO --> C2[Secure space for inlet and outlet.] D2 -- YES --> D3{Inspect compressor} D3 -- NO --> C3[Replace compressor.] D3 -- YES --> D4{Inspect outdoor air temperature sensor} D4 -- NO --> C4[Replace sensor.] D4 -- YES --> C5["Defective outdoor control PCB -> Replace. (Defective outdoor air temperature sensor input circuit)"] </pre>							
<p>2.Error detection method</p> <p>When the current safe control has operated at the compressor speed of 20 rps or under.</p>							
<p>3.Condition of error displayed</p> <p>Same as above</p>							
<p>4.Presumable cause</p> <ul style="list-style-type: none"> • Excessive refrigerant amount • Indoor,outdoor unit installation spaces • Faulty compressor • Defective outdoor air temperature sensor • Defective outdoor control PCB 							

Note:

Error code Remote control: E59	LED	Green	Red	Content Compressor startup failure
	Indoor	Keeps flashing	Stays OFF	

1.Applicable model
All models

2.Error detection method
<ul style="list-style-type: none"> If it fails to change over to the rotor detection operation of compressor motor

3.Condition of error displayed
If compressor fails to startup for 42 times

4.Presumable cause
<ul style="list-style-type: none"> Faulty outdoor fan motor Faulty outdoor control PCB Anomalous power source voltage Improper refrigerant amount and refrigerant circuit Faulty compressor (Motor bearing)

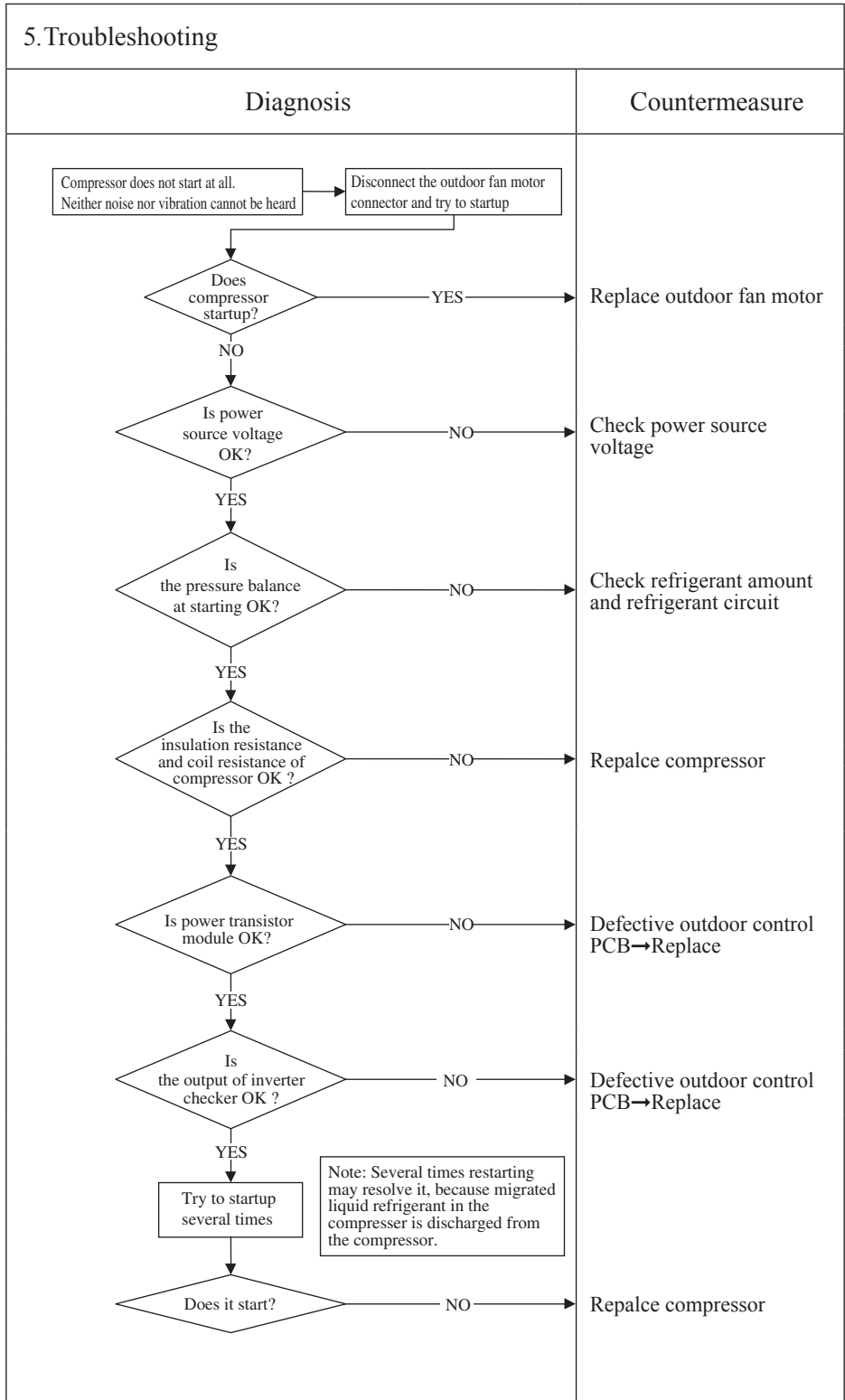

Note: Insulation resistance

- The unit is left for long period without power source or soon after installation, migrated liquid refrigerant may dissolve in the refrigerant oil in the compressor. In such case insulation resistance decreases upto several MΩ or lower. If the electric leakage breaker is activated due to low insulation resistance, check followings.
- Check whether the electric leakage breake conforms to high-hermonic specifications (As units has inverter, in order to prevent from improper operation, be sure to use high-hermonic one.)

Error code Remote control: E60	LED	Green	Red	Content Compressor rotor lock error
	Indoor	Keeps flashing	Stays OFF	

1. Applicable model
All models
2. Error detection method
Compressor rotor position
3. Condition of error displayed
If it fails again to detect the rotor position after shifting to the compressor rotor position detection operation, the compressor stops.
4. Presumable cause
<ul style="list-style-type: none"> • Defective outdoor fan motor • Defective outdoor control PCB • Anomalous power source voltage • Improper refrigerant amount and refrigerant circuit • Defective compressor (motor, bearing)

5. Troubleshooting	
Diagnosis	Countermeasure
<pre> graph TD Q1{Is the power source voltage OK?} -- NO --> C1[Check and correct the power source voltage] Q1 -- YES --> R1[Reset the power source and restart operation.] R1 --> Q2{Does the compressor start?} Q2 -- NO --> Q3{Does E59 occur?} Q3 -- YES --> C2[Correct it based on the troubleshooting of E59] Q3 -- NO --> Q4{Does the compressor run without occurrence of E42?} Q4 -- NO --> C3[Correct it based on the troubleshooting of E42] Q4 -- YES --> Q5{Is the output from inverter checker OK?} Q5 -- NO --> C4[Defective outdoor control PCB -> Replace.] Q5 -- YES --> Q6{Is the noise or vibration of compressor normal?} Q6 -- NO --> C5[Replace compressor.] Q6 -- YES --> Q7{Does it start up normally without recurrence of E60.} Q7 -- NO --> C6[Check compressor for insulation, resistance. Replace compressor if necessary.] Q7 -- YES --> C7[Defective outdoor control PCB -> Replace.] </pre>	

Note: Insulation resistance

- The unit is left for long period without power source or soon after installation, migrated liquid refrigerant may dissolve in the refrigerant oil in the compressor. In such case insulation resistance decreases upto several MΩ or lower. If the electric leakage breaker is activated due to low insulation resistance, check followings. Check whether the electric leakage break conforms to high-harmonic specifications (As units has inverter, in order to prevent from improper operation, be sure to use high-harmonic one.)

12.2 SRK series

This chapter has described about an indoor unit. Look at 12.1 chapters about the outdoor unit.

(1) Cautions

- (a) If you are disassembling and checking an air-conditioner, be sure to turn off the power before beginning. When working on indoor units, let the unit sit for about 1 minute after turning off the power before you begin work.
- (b) When taking out printed circuit boards, be sure to do so without exerting force on the circuit boards or package components.
- (c) When disconnecting and connecting connectors, take hold of the connector housing and do not pull on the lead wires.

(2) Items to check before troubleshooting

- (a) Have you thoroughly investigated the details of the trouble which the customer is complaining about?
- (b) Is the air-conditioner running? Is it displaying any self-diagnosis information?
- (c) Is a power source with the correct voltage connected?
- (d) Are the control lines connecting the indoor and outdoor units wired correctly and connected securely?
- (e) Is the outdoor unit's service valve open?

(3) Troubleshooting procedure (If the air-conditioner does not run at all)

If the air-conditioner does not run at all, diagnose the trouble using the following troubleshooting procedure. If the air-conditioner is running but breaks down, proceed to troubleshooting step (4).

Important When all the following conditions are met, we say that the air-conditioner will not run at all.

- (a) The RUN light does not light up.
- (b) The flaps do not open.
- (c) The indoor unit fan motors do not run.
- (d) The self-diagnosis display does not function.

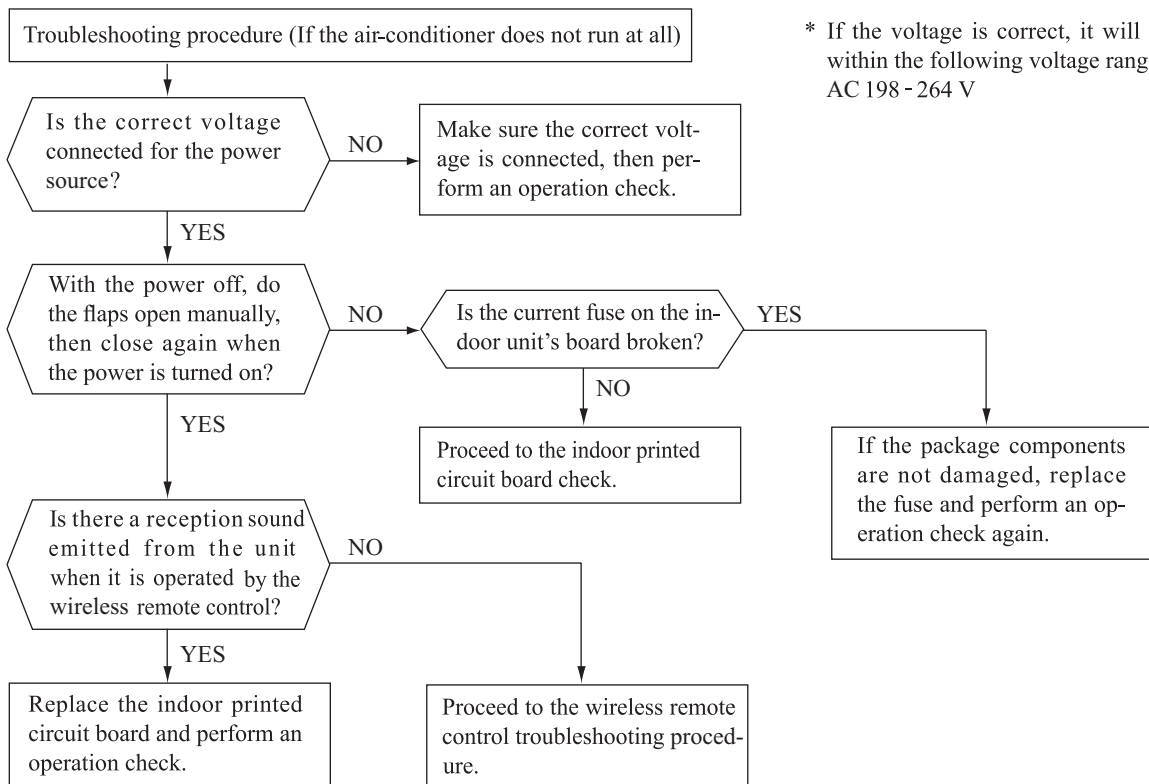

(4) Troubleshooting procedure (If the air-conditioner runs)

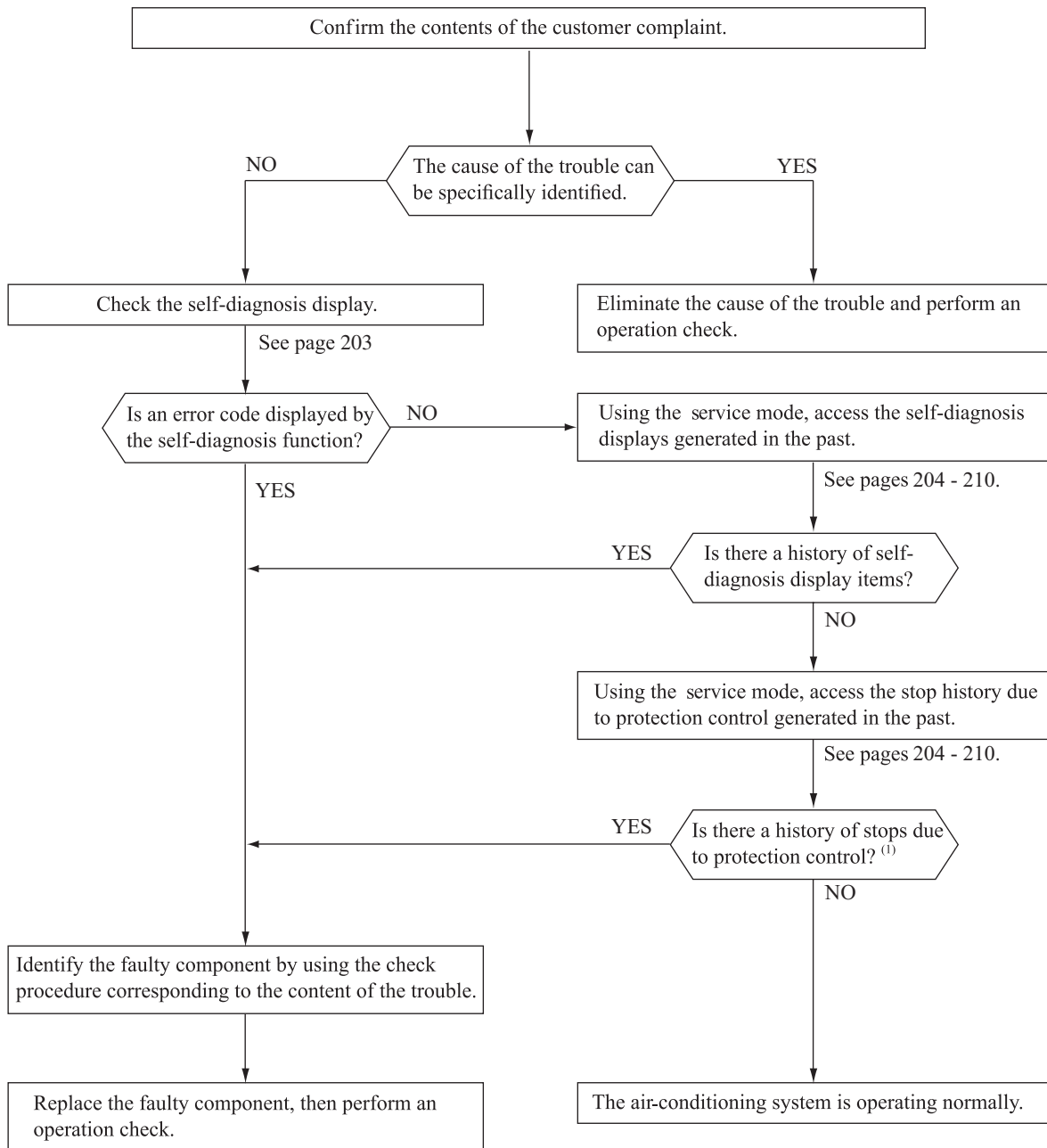

Note (1) Even in cases where only intermittent stop data are generated, the air-conditioning system is normal. However, if the same protective operation recurs repeatedly (3 or more times), it will lead to customer complaints. Judge the conditions in comparison with the contents of the complaints.

(5) Self-diagnosis table

When this air-conditioner performs an emergency stop, the reason why the emergency stop occurred is displayed by the flashing of display lights. If the air-conditioner is operated using the remote control 3 minutes or more after the emergency stop, the trouble display stops and the air-conditioner resumes operation.⁽¹⁾

Indoor unit display panel		Wired ⁽²⁾ remote control display	Description of trouble	Cause	Display (flashing) condition
RUN light	TIMER light				
1-time flash	ON	—	Heat exchanger sensor 1 error	<ul style="list-style-type: none"> Broken heat exchanger sensor 1 wire, poor connector connection Indoor control PCB is faulty 	When a heat exchanger sensor 1 wire disconnection is detected while operation is stopped. (If a temperature of -28°C or lower is detected for 15 seconds, it is judged that the wire is disconnected.) (Not displayed during operation.)
2-time flash	ON	—	Room temperature sensor error	<ul style="list-style-type: none"> Broken room temperature sensor wire, poor connector connection Indoor control PCB is faulty 	When a room temperature sensor wire disconnection is detected while operation is stopped. (If a temperature of -45°C or lower is detected for 15 seconds, it is judged that the wire is disconnected.) (Not displayed during operation.)
3-time flash	ON	—	Heat exchanger sensor 2 error	<ul style="list-style-type: none"> Broken heat exchanger sensor 2 wire, poor connector connection Indoor control PCB is faulty 	When a heat exchanger sensor 2 wire disconnection is detected while operation is stopped. (If a temperature of -28°C or lower is detected for 15 seconds, it is judged that the wire is disconnected.) (Not displayed during operation.)
6-time flash	ON	E 16	Indoor fan motor error	<ul style="list-style-type: none"> Defective fan motor, poor connector connection 	When conditions for turning the indoor unit's fan motor on exist during air-conditioner operation, an indoor unit fan motor speed of 300 min ⁻¹ or lower is measured for 30 seconds or longer. (The air-conditioner stops.)
Keeps flashing	1-time flash	E 38	Outdoor air temperature sensor anomaly	<ul style="list-style-type: none"> Outdoor air temperature sensor Outdoor control PCB is faulty 	-55°C or lower is detected for 5 seconds continuously 3 times within 40 minutes after initial detection of this anomalous temperature. Or -55°C or lower is detected for within 20 seconds after power ON.
Keeps flashing	2-time flash	E 37	Outdoor heat exchanger temperature sensor anomaly	<ul style="list-style-type: none"> Outdoor heat exchanger temperature sensor Outdoor control PCB is faulty 	-55°C or lower is detected for 5 seconds continuously 3 times within 40 minutes after initial detection of this anomalous sensor. Or -55°C or lower is detected for within 20 seconds after power ON.
Keeps flashing	4-time flash	E 39	Discharge pipe temperature sensor anomaly	<ul style="list-style-type: none"> Discharge pipe temperature sensor Outdoor control PCB 	-25°C or lower is detected for 5 seconds continuously 3 times within 40 minutes after initial detection of this anomalous sensor.
ON	1-time flash	E 42	Current cut	<ul style="list-style-type: none"> Outdoor control PCB is faulty Defective compressor Installation, operation status 	If the output current of inverter exceeds the specifications, it makes the compressor stopping.
ON	2-time flash	E 59	Compressor startup failure	<ul style="list-style-type: none"> Defective compressor Outdoor control PCB is faulty 	If compressor fails to startup for 42 times.
ON	3-time flash	E 58	Current safe stop	<ul style="list-style-type: none"> Overload operation Overcharge Compressor locking 	When the current safe control has operated at the compressor speed of 20 rps or under.
ON	4-time flash	E 51	Power transistor anomaly	<ul style="list-style-type: none"> Power transistor error (Outdoor control PCB is faulty) 	If the power transistor primary current exceeds the setting value for 3 seconds, the compressor stops.
ON	5-time flash	E 36	Discharge pipe temperature error	<ul style="list-style-type: none"> Installation, operation status Discharge pipe temperature sensor Outdoor control PCB is faulty 	When discharge pipe temperature anomaly is detected 2 times within 60 minutes is compressor stop.
ON	6-time flash	E 5	Error of signal transmission	<ul style="list-style-type: none"> Defective power source, Broken signal wire, defective indoor/outdoor control PCB 	When there is no signal between the indoor control PCB and outdoor control PCB for 10 seconds or longer (when the power is turned on), or when there is no signal for 7 minute 35 seconds or longer (during operation) (the compressor is stopped).
ON	7-time flash	E 48	Outdoor fan motor anomaly	<ul style="list-style-type: none"> Defective fan motor Outdoor control PCB is faulty 	When actual rotation speed of outdoor fan motor drops to 75min ⁻¹ or lower for 30 minutes continuously, the compressor and the outdoor fan motor stop. After 3-minutes delay, it starts again automatically, but if this anomaly occurs 3 times within 60 minutes after the initial detection.
ON	Keeps flashing	E 35	Cooling overload operation	<ul style="list-style-type: none"> Installation, operation status Outdoor heat exchanger temperature sensor Outdoor control PCB is faulty 	When anomalous outdoor heat exchanger temperature occurs 5 times within 60 minutes or 60°C or higher continues for 10 minutes, including the compressor stop.
2-time flash	2-time flash	E 60	Compressor rotor lock error	<ul style="list-style-type: none"> Defective compressor 	If it fails again to detect the rotor position after shifting to the compressor rotor position detection operation, the compressor stops.
5-time flash	ON	E 47	Active filter voltage error	<ul style="list-style-type: none"> Outdoor control PCB is faulty 	Error is displayed if the converter voltage exceeds target voltage (3 times within 20 minutes). Remote control may be set after 3 minutes delay. Error is displayed if the converter voltage is lower than 210V (1-time within 5 seconds after power ON)
7-time flash	ON	E 57	Insufficient refrigerant amount or detection of service valve closure	<ul style="list-style-type: none"> Operation status Installation status 	When the insufficient refrigerant amount is detected 3 times within 60 minutes.
—	—	E 1	Error of wired remote control wiring	<ul style="list-style-type: none"> Broken wired remote control wire, defective indoor control PCB 	The wired remote control wire Y is open. The wired remote control wires X and Y are reversely connected. Noise is penetrating the wired remote control lines. The wired remote control or indoor control PCB is faulty. (The communications circuit is faulty.)

Notes (1) The air-conditioner cannot be restarted using the remote control for 3 minutes after operation stops.

(2) The wired remote control is option parts.

(6) Service mode (Trouble mode access function)

This air-conditioner is capable of recording error displays and protective stops (service data) which have occurred in the past. If self-diagnosis displays cannot be confirmed, it is possible to get a grasp of the conditions at the time trouble occurred by checking these service data.

(a) Explanation of terms

Term	Explanation
Service mode	The service mode is the mode where service data are displayed by flashing of the display lights when the operations in item (b) below are performed with the indoor controller.
Service data	These are the contents of error displays and protective stops which occurred in the past in the air-conditioner system. Error display contents and protective stop data from past anomalous operations of the air-conditioner system are saved in the indoor unit controller's non-volatile memory (memory which is not erased when the power goes off). There are two types of data, self-diagnosis data and stop data, described below.
Self-diagnosis data	These are the data which display the reason why a stop occurred when an error display (self-diagnosis display) occurred in an indoor unit. Data are recorded for up to 5 previous occurrences. Data which are older than the 5th previous occurrence are erased. In addition, data on the temperature of each sensor (room temperature, indoor heat exchanger, outdoor heat exchanger, outdoor air temperature, discharge pipe), remote control information (operation switching, fan speed switching) are recorded when trouble occurs, so more detailed information can be checked.
Stop data	These are the data which display the reason by a stop occurred when the air-conditioning system performed protective stops, etc. in the past. Even if stop data alone are generated, the system restarts automatically. (After executing the stop mode while the display is normal, the system restarts automatically.) Data for up to 10 previous occasions are stored. Data older than the 10th previous occasion are erased. (Important) In cases where transient stop data only are generated, the air-conditioner system may still be normal. However, if the same protective stop occurs frequently (3 or more times), it could lead to customer complaints.

(b) Service mode display procedure

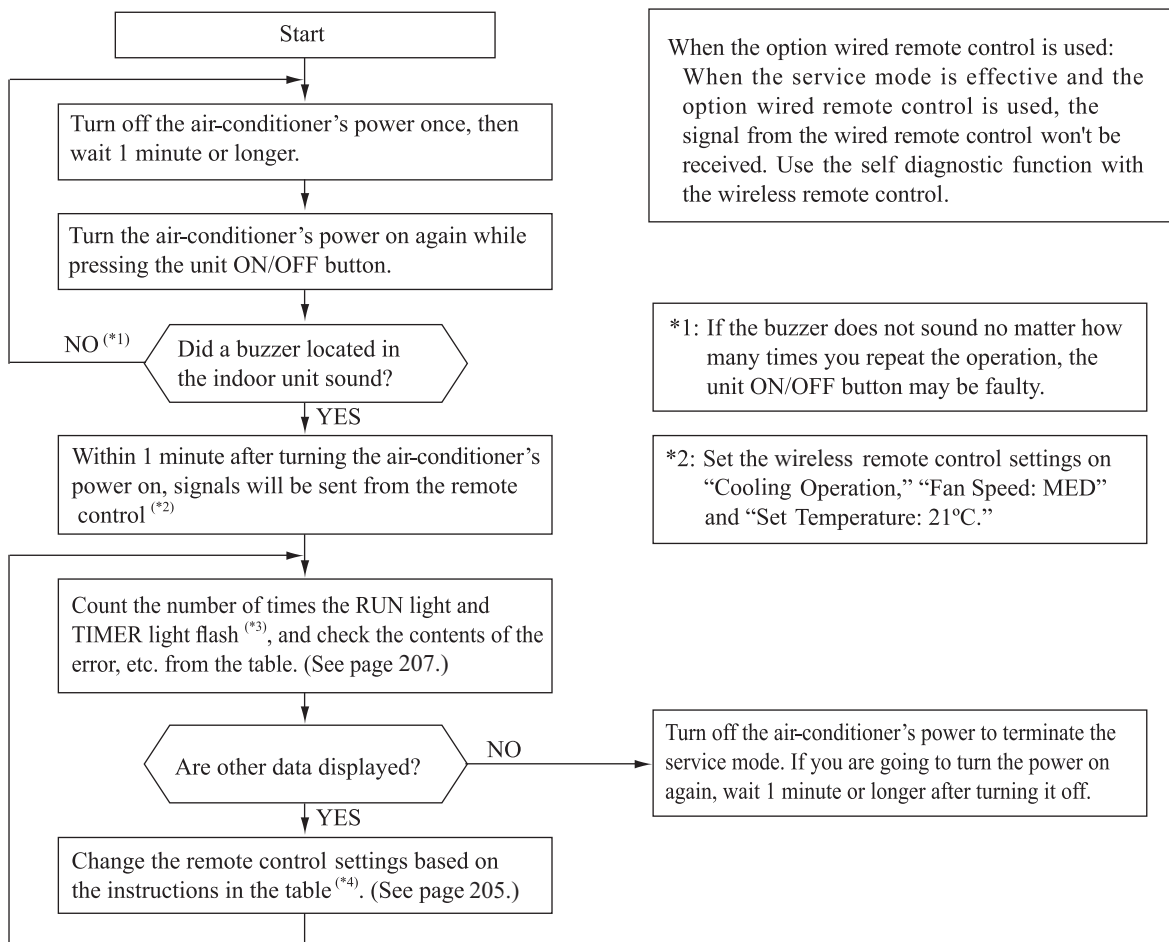

*3: To count the number of flashes in the service mode, count the number of flashes after the light lights up for 1.5 second initially (start signal). (The time that the light lights up for 1.5 second (start signal) is not counted in the number of flashes.)

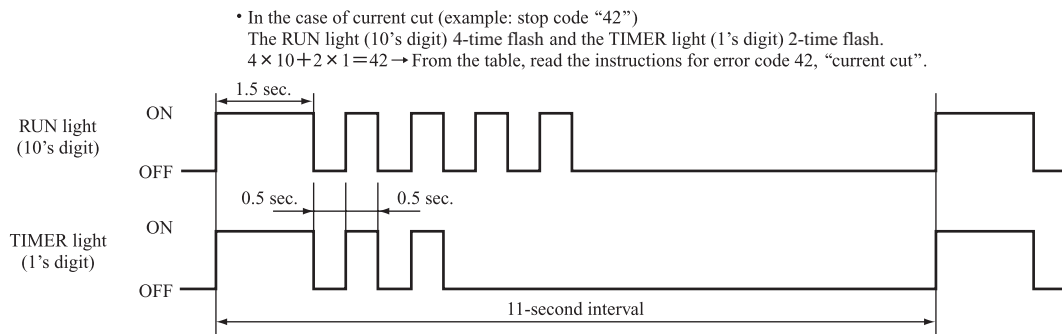

*4: When in the service mode, when the wireless remote control settings (operation mode, fan speed mode, temperature setting) are set as shown in the following table and sent to the air-conditioner unit, the unit switches to display of service data.

(i) Self-diagnosis data

What are Self-.....These are control data (reasons for stops, temperature at each sensor, wireless remote control information) diagnosis Data? from the time when there were error displays (abnormal stops) in the indoor unit in the past.

Data from up to 5 previous occasions are stored in memory. Data older than the 5th previous occasion are erased.

The temperature setting indicates how many occasions previous to the present setting the error display data are and the operation mode and fan speed mode data show the type of data.

Wireless remote control setting		Contents of output data
Operation mode	Fan speed mode	
Cooling	MED	Displays the reason for stopping display in the past (error code).
	HI	Displays the room temperature sensor temperature at the time the error code was displayed in the past.
	AUTO	Displays the indoor heat exchanger sensor temperature at the time the error code was displayed in the past.
Heating	LO	Displays the wireless remote control information at the time the error code was displayed in the past.
	MED	Displays the outdoor air temperature sensor temperature at the time the error code was displayed in the past.
	HI	Displays the outdoor heat exchanger sensor temperature at the time the error code was displayed in the past.
	AUTO	Displays the discharge pipe sensor temperature at the time the error code was displayed in the past.

Wireless remote control setting	Indicates the number of occasions previous to the present the error display data are from.
Temperature setting	
21°C	1 time previous (previous time)
22°C	2 times previous
23°C	3 times previous
24°C	4 times previous
25°C	5 times previous

Only for indoor heat exchanger sensor 2

Wireless remote control setting	Indicates the number of occasions previous to the present the error display data are from.
Temperature setting	
26°C	1 time previous (previous time)
27°C	2 times previous
28°C	3 times previous
29°C	4 times previous
30°C	5 times previous

(Example)

Wireless remote control setting			Displayed data
Operation mode	Fan speed mode	Temperature setting	
Cooling	MED	21°C	Displays the reason for the stop (error code) the previous time an error was displayed.
		22°C	Displays the reason for the stop (error code) 2 times previous when an error was displayed.
		23°C	Displays the reason for the stop (error code) 3 times previous when an error was displayed.
		24°C	Displays the reason for the stop (error code) 4 times previous when an error was displayed.
		25°C	Displays the reason for the stop (error code) 5 times previous when an error was displayed.

(ii) Stop data

Wireless remote control setting			Displayed data
Operation mode	Fan speed mode	Temperature setting	
Cooling	LO	21°C	Displays the reason for the stop (stop code) the previous time when the air-conditioner was stopped by protective stop control.
		22°C	Displays the reason for the stop (stop code) 2 times previous when the air-conditioner was stopped by protective stop control.
		23°C	Displays the reason for the stop (stop code) 3 times previous when the air-conditioner was stopped by protective stop control.
		24°C	Displays the reason for the stop (stop code) 4 times previous when the air-conditioner was stopped by protective stop control.
		25°C	Displays the reason for the stop (stop code) 5 times previous when the air-conditioner was stopped by protective stop control.
		26°C	Displays the reason for the stop (stop code) 6 times previous when the air-conditioner was stopped by protective stop control.
		27°C	Displays the reason for the stop (stop code) 7 times previous when the air-conditioner was stopped by protective stop control.
		28°C	Displays the reason for the stop (stop code) 8 times previous when the air-conditioner was stopped by protective stop control.
		29°C	Displays the reason for the stop (stop code) 9 times previous when the air-conditioner was stopped by protective stop control.
		30°C	Displays the reason for the stop (stop code) 10 times previous when the air-conditioner was stopped by protective stop control.

(c) **Error code, stop code table** (Assignment of error codes and stop codes is done in common for all models.)

Number of flashes when in service mode		Stop code or Error code	Error content	Cause	Occurrence conditions	Error display	Auto recovery
RUN light (10's digit)	TIMER light (1's digit)						
OFF	OFF	0	Normal	—	—	—	—
	1-time flash	01	Error of wired remote control wiring	Broken wired remote control wire, defective indoor control PCB	The wired remote control wire Y is open. The wired remote control wires X and Y are reversely connected. Noise is penetrating the wired remote control lines. The wired remote control or indoor control PCB is faulty.	—	○
	5-time flash	05	Can not receive signals for 35 seconds (if communications have recovered)	Power source is faulty. Power source cables and signal lines are improperly wired. Indoor or outdoor control PCB are faulty.	When 35 seconds passes without communications signals from either the outdoor unit or the indoor unit being detected correctly.	○	—
3-time flash	5-time flash	35	Cooling high pressure control	Cooling overload operation. Outdoor unit fan speed drops. Outdoor heat exchanger sensor is short circuit.	When the outdoor heat exchanger sensor's value exceeds the set value.	○ (5 times)	○
	6-time flash	36	Compressor overheat 115°C	Refrigerant is insufficient. Discharge pipe sensor is faulty. Service valve is closed.	When the discharge pipe sensor's value exceeds the set value.	○ (2 times)	○
	7-time flash	37	Outdoor heat exchanger sensor is abnormal	Outdoor heat exchanger sensor wire is disconnected. Connector connections are poor. Outdoor control PCB is faulty.	-55°C or lower is detected for 5 seconds continuously 3 times within 40 minutes after initial detection of this anomalous temperature. Or -55°C lower is detected for 5 seconds continuously within 20 seconds after power ON.	○ (3 times)	○
	8-time flash	38	Outdoor air temperature sensor is abnormal	Outdoor air temperature sensor wire is disconnected. Connector connections are poor. Outdoor control PCB is faulty.	-55°C or lower is detected for 5 seconds continuously 3 times within 40 minutes after initial detection of this anomalous temperature. Or -55°C lower is detected for 5 seconds continuously within 20 seconds after power ON.	○ (3 times)	○
	9-time flash	39	Discharge pipe sensor is abnormal (anomalous stop)	Discharge pipe sensor wire is disconnected. Connector connections are poor. Outdoor control PCB is faulty.	-25°C or lower is detected for 5 seconds continuously 3 times within 40 minutes after initial detection of this anomalous temperature.	○ (3 times)	○
4-time flash	2-time flash	42	Current cut	Compressor lock. Compressor wiring short circuit. Compressor output is open phase. Outdoor control PCB is faulty. Service valve is closed. Electronic expansion valve is faulty. Compressor is faulty.	In order to prevent from overcurrent of inverter, if the current exceeds the specifications, it makes the compressor stopping.	○ (2 times)	○
	7-time flash	47	Active filter voltage error	Defective active filter.	Error is displayed if the converter voltage exceeds target voltage (3 times within 20 minutes). Remote control may be set after 3 minutes delay. Error is displayed if the converter voltage is lower than 210V (1-time within 5 seconds after power ON)	○	—
	8-time flash	48	Outdoor unit's fan motor is abnormal	Outdoor fan motor is faulty. Connector connections are poor. Outdoor control PCB is faulty.	When a fan speed of 75 min ⁻¹ or lower continues for 30 seconds or longer.	○ (3 times)	○
5-time flash	1-time flash	51	Short circuit in the power transistor (high side) Current cut circuit breakdown	Outdoor control PCB is faulty. Power transistor is damaged.	When it is judged that the power transistor was damaged at the time the compressor started.	○	—
	7-time flash	57	Refrigeration cycle system protective control	Service valve is closed. Refrigerant is insufficient.	When refrigeration cycle system protective control operates.	○ (3 times)	○
	8-time flash	58	Current safe	Refrigerant is overcharge. Compressor lock. Overload operation.	When there is a current safe stop during operation.	—	○
	9-time flash	59	Compressor wiring is unconnection Voltage drop Low speed protective control	Compressor wiring is disconnected. Power transistor is damaged. Power source construction is defective. Outdoor control PCB is faulty. Compressor is faulty.	When the current is 1A or less at the time the compressor started. When the power source voltage drops during operation. When the compressor command speed is lower than 32 rps for 60 minutes.	○	○
6-time flash	OFF	60	Rotor lock	Compressor is faulty. Compressor output is open phase. Electronic expansion valve is faulty. Overload operation. Outdoor control PCB is faulty.	After the compressor starts, when the compressor stops due to rotor lock.	○ (2 times)	○
	1-time flash	61	Connection lines between the indoor and outdoor units are faulty	Connection lines are faulty. Indoor or outdoor control PCB are faulty.	When 10 seconds passes after the power is turned on without communications signals from the indoor or outdoor unit being detected correctly.	○	—
	2-time flash	62	Serial transmission error	Indoor or outdoor control PCB are faulty. Noise is causing faulty operation.	When 7 minute 35 seconds passes without communications signals from either the outdoor unit or the indoor unit being detected correctly.	○	—
8-time flash	OFF	80	Indoor unit's fan motor is abnormal	Indoor fan motor is faulty. Connector connections are poor. Indoor control PCB is faulty.	When the indoor unit's fan motor is detected to be running at 300 min ⁻¹ or lower speed with the fan motor in the ON condition while the air-conditioner is running.	○	—
	2-time flash	82	Indoor heat exchanger sensor is abnormal (anomalous stop)	Indoor heat exchanger sensor wire is disconnected. Connector connections are poor.	When a temperature of -28°C or lower is sensed continuously for 40 minutes during heating operation. (the compressor stops).	○	—
	4-time flash	84	Anti-condensation control	High humidity condition. Humidity sensor is faulty.	Anti-condensation prevention control is operating.	—	○
	5-time flash	85	Anti-frost control	Indoor unit fan speed drops. Indoor heat exchanger sensor is broken wire.	When the anti-frost control operates and the compressor stops during cooling operation.	—	○
	6-time flash	86	Heating high pressure control	Heating overload operation. Indoor unit fan speed drops. Indoor heat exchanger sensor is short circuit.	When high pressure control operates during heating operation and the compressor stops.	—	○

Notes (1) The number of flashes when in the service mode do not include the 1.5 second period when the lights light up at first (start signal). (See the example shown below.)

- In the case of current cut (example: stop code “42”)
 - The RUN light (10’s digit) 4-time flash and the TIMER light (1’s digit) 2-time flash.
 - $4 \times 10 + 2 \times 1 = 42 \rightarrow$ From the table, read the instructions for error code 42, “current cut”.

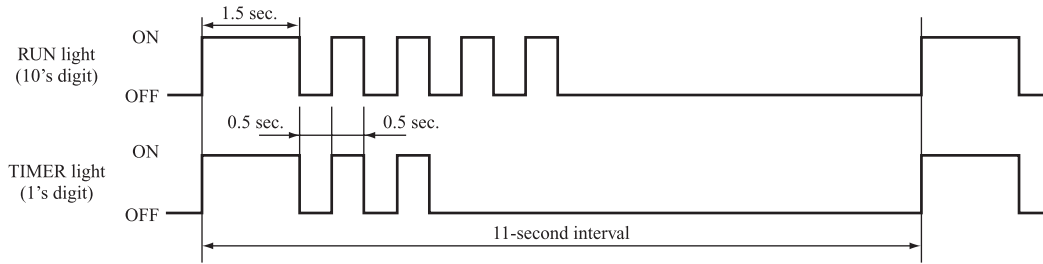

- (2) Error display:
 – Is not displayed. (automatic recovery only)
 Displayed.
 If there is a () displayed, the error display shows the number of times that an auto recovery occurred for the same reason has reached the number of times in ().
 If no () is displayed, the error display shows that the trouble has occurred once.
- (3) Auto Recovery:
 – Does not occur
 Auto recovery occurs.

(d) Operation mode, Fan speed mode information tables

(i) Operation mode

Display pattern when in service mode	Operation mode when there is an abnormal stop
RUN light (10's digit)	
—	AUTO
1-time flash	DRY
2-time flash	COOL
3-time flash	FAN
4-time flash	HEAT

(ii) Fan speed mode

Display pattern when in service mode	Fan speed mode when there is an abnormal stop
TIMER light (1's digit)	
—	AUTO
2-time flash	HI
3-time flash	MED
4-time flash	LO
5-time flash	ULO
6-time flash	HI POWER
7-time flash	ECONO

* If no data are recorded (error code is normal), the information display in the operation mode and fan speed mode becomes as follows.

Mode	Display when error code is normal.
Operation mode	AUTO
Fan speed mode	AUTO

(Example): Operation mode: COOL, Fan speed mode: HI

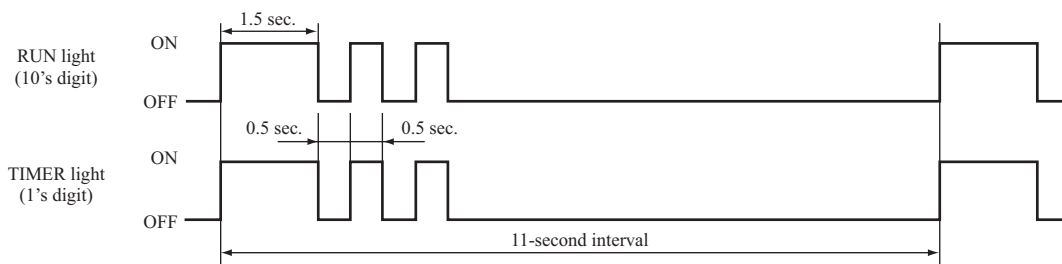

(e) Temperature information

(i) Room temperature sensor, indoor heat exchanger sensor, outdoor air temperature sensor, outdoor heat exchanger sensor temperature

Unit: °C

Buzzer sound	RUN light (10's digit)	TIMER light (1's digit)										
		0	1	2	3	4	5	6	7	8	9	
Yes (sounds for 0.1 second)	6	-60	-61	-62	-63	-64						
	5	-50	-51	-52	-53	-54	-55	-56	-57	-58	-59	
	4	-40	-41	-42	-43	-44	-45	-46	-47	-48	-49	
	3	-30	-31	-32	-33	-34	-35	-36	-37	-38	-39	
	2	-20	-21	-22	-23	-24	-25	-26	-27	-28	-29	
	1	-10	-11	-12	-13	-14	-15	-16	-17	-18	-19	
	0	/	-1	-2	-3	-4	-5	-6	-7	-8	-9	
No (does not sound)	0	0	1	2	3	4	5	6	7	8	9	
	1	10	11	12	13	14	15	16	17	18	19	
	2	20	21	22	23	24	25	26	27	28	29	
	3	30	31	32	33	34	35	36	37	38	39	
	4	40	41	42	43	44	45	46	47	48	49	
	5	50	51	52	53	54	55	56	57	58	59	
	6	60	61	62	63	64	65	66	67	68	69	
	7	70	71	72	73	74	75	76	77	78	79	
	8	80	81	82	83	84	85	86	87	88	89	
	9	90	91	92	93	94	95	96	97	98	99	

* If no data are recorded (error code is normal), the display for each temperature information becomes as shown below.

Sensor name	Sensor value displayed when the error code is normal
Room temperature sensor	-64°C
Indoor heat exchanger sensor	-64°C
Outdoor air temperature sensor	-64°C
Outdoor heat exchanger sensor	-64°C

(Example) Outdoor heat exchanger temperature data: “-9°C”

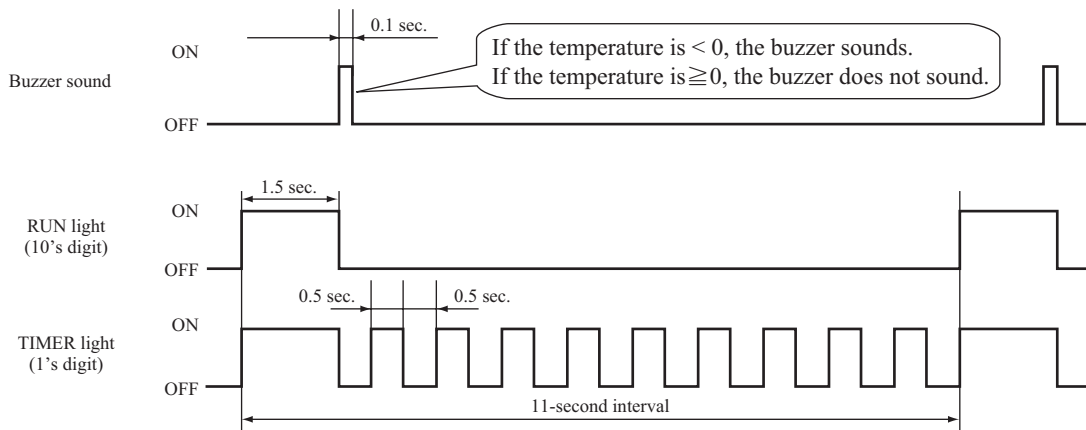

(ii) Discharge pipe sensor temperature

Unit: °C

Buzzer sound	RUN light (10's digit)	TIMER light (1's digit)										
		0	1	2	3	4	5	6	7	8	9	
Yes (sounds for 0.1 second)	3	-60	-62	-64								
	2	-40	-42	-44	-46	-48	-50	-52	-54	-56	-58	
	1	-20	-22	-24	-26	-28	-30	-32	-34	-36	-38	
	0	/	-2	-4	-6	-8	-10	-12	-14	-16	-18	
No (does not sound)	0	0	2	4	6	8	10	12	14	16	18	
	1	20	22	24	26	28	30	32	34	36	38	
	2	40	42	44	46	48	50	52	54	56	58	
	3	60	62	64	66	68	70	72	74	76	78	
	4	80	82	84	86	88	90	92	94	96	98	
	5	100	102	104	106	108	110	112	114	116	118	
	6	120	122	124	126	128	130	132	134	136	138	
	7	140	142	144	146	148	150					

* If no data are recorded (error code is normal), the display for each temperature information becomes as shown below.

Sensor name	Sensor value displayed when the error code is normal
Discharge pipe sensor	-64°C

(Example) Discharge pipe temperature data: "122°C"

* In the case of discharge pipe data, multiply the reading value by 2. (Below, 61 x 2 = "122°C")

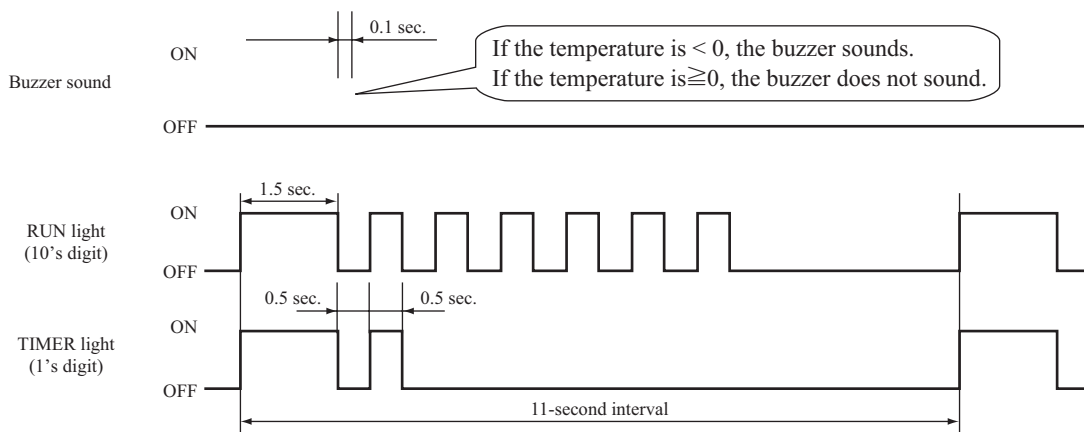

Service data record form

Customer		Model				
Date of investigation						
Machine name						
Content of complaint						
Wireless remote control settings			Display results		Display content	
Temperature setting	Operation mode	Fan speed mode	Content of displayed data	Buzzer (Yes/No.)		RUN light (Times)
21	Cooling	MED	Error code on previous occasion.	/		
		HI	Room temperature sensor on previous occasion.			
		AUTO	Indoor heat exchanger sensor 1 on previous occasion.			
	Heating	LO	Wireless remote control information on previous occasion.	/		
		MED	Outdoor air temperature sensor on previous occasion.			
		HI	Outdoor heat exchanger sensor on previous occasion.			
	AUTO	Discharge pipe sensor on previous occasion.				
26	Cooling	AUTO	Indoor heat exchanger sensor 2 on previous occasion.			
22	Cooling	MED	Error code on second previous occasion.	/		
		HI	Room temperature sensor on second previous occasion.			
		AUTO	Indoor heat exchanger sensor 1 on second previous occasion.			
	Heating	LO	Wireless remote control information on second previous occasion.	/		
		MED	Outdoor air temperature sensor on second previous occasion.			
		HI	Outdoor heat exchanger sensor on second previous occasion.			
	AUTO	Discharge pipe sensor on second previous occasion.				
27	Cooling	AUTO	Indoor heat exchanger sensor 2 on second occasion.			
23	Cooling	MED	Error code on third previous occasion.	/		
		HI	Room temperature sensor on third previous occasion.			
		AUTO	Indoor heat exchanger sensor 1 on third previous occasion.			
	Heating	LO	Wireless remote control information on third previous occasion.	/		
		MED	Outdoor air temperature sensor on third previous occasion.			
		HI	Outdoor heat exchanger sensor on third previous occasion.			
	AUTO	Discharge pipe sensor on third previous occasion.				
28	Cooling	AUTO	Indoor heat exchanger sensor 2 on third occasion.			
24	Cooling	MED	Error code on fourth previous occasion.	/		
		HI	Room temperature sensor on fourth previous occasion.			
		AUTO	Indoor heat exchanger sensor 1 on fourth previous occasion.			
	Heating	LO	Wireless remote control information on fourth previous occasion.	/		
		MED	Outdoor air temperature sensor on fourth previous occasion.			
		HI	Outdoor heat exchanger sensor on fourth previous occasion.			
	AUTO	Discharge pipe sensor on fourth previous occasion.				
29	Cooling	AUTO	Indoor heat exchanger sensor 2 on fourth occasion.			
25	Cooling	MED	Error code on fifth previous occasion.	/		
		HI	Room temperature sensor on fifth previous occasion.			
		AUTO	Indoor heat exchanger sensor 1 on fifth previous occasion.			
	Heating	LO	Wireless remote control information on fifth previous occasion.	/		
		MED	Outdoor air temperature sensor on fifth previous occasion.			
		HI	Outdoor heat exchanger sensor on fifth previous occasion.			
	AUTO	Discharge pipe sensor on fifth previous occasion.				
30	Cooling	AUTO	Indoor heat exchanger sensor 2 on fifth occasion.			
21	Cooling	LO	Stop code on previous occasion.			
22			Stop code on second previous occasion.			
23			Stop code on third previous occasion.			
24			Stop code on fourth previous occasion.			
25			Stop code on fifth previous occasion.			
26			Stop code on sixth previous occasion.			
27			Stop code on seventh previous occasion.			
28			Stop code on eighth previous occasion.			
29			Stop code on ninth previous occasion.			
30			Stop code on tenth previous occasion.			
Judgment						Examiner
Remarks						

Note (1) In the case of indoor heat exchanger sensor 2, match from 26 to 30 the temperature setting of wireless remote control. (Refer to page 205)

(7) Inspection procedures corresponding to detail of trouble

Sensor error

[Broken sensor wire, connector poor connection]

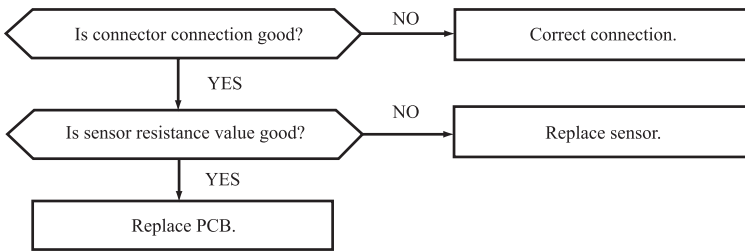

◆ Discharge pipe sensor temperature characteristics

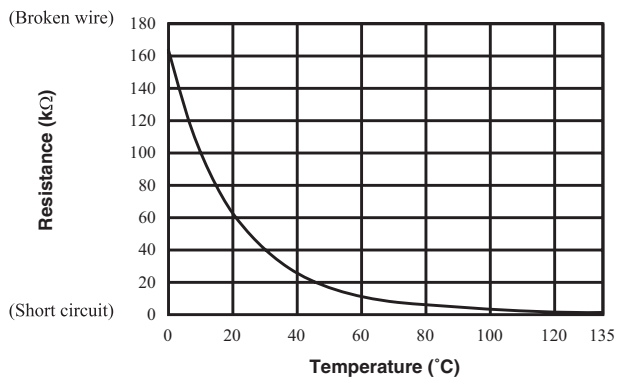

◆ Sensor temperature characteristics (Room temp., indoor heat exchanger temp., outdoor heat exchanger temp., outdoor air temp.)

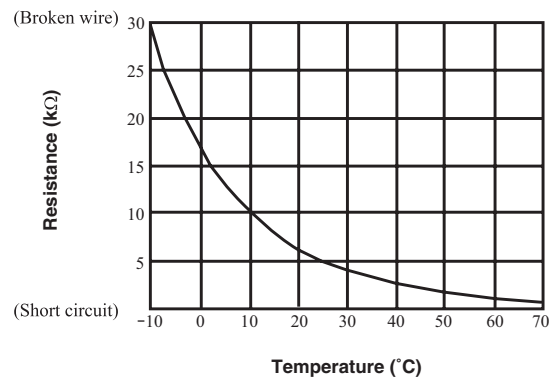

Indoor fan motor error

[Defective fan motor, connector poor connection, defective indoor control PCB]

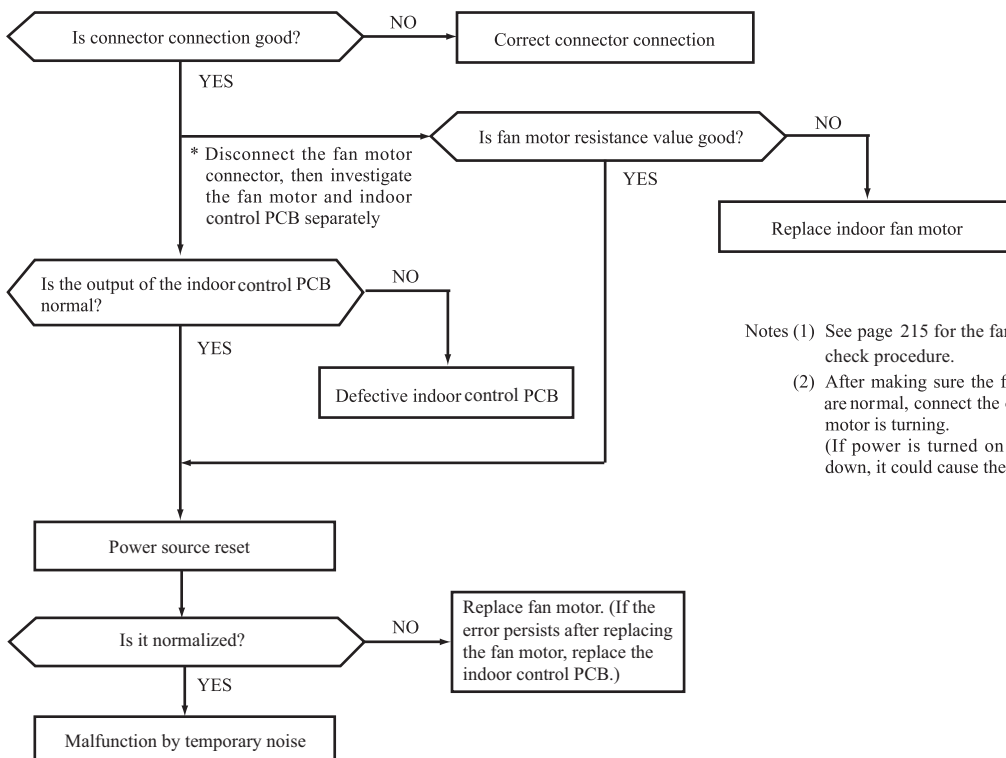

Notes (1) See page 215 for the fan motor and indoor control PCB check procedure.
 (2) After making sure the fan motor and indoor control PCB are normal, connect the connectors and confirm that the fan motor is turning.
 (If power is turned on while one or the other is broken down, it could cause the other to break down also.)

Error of signal transmission

[Wiring error including power cable, defective indoor/ outdoor control PCB]

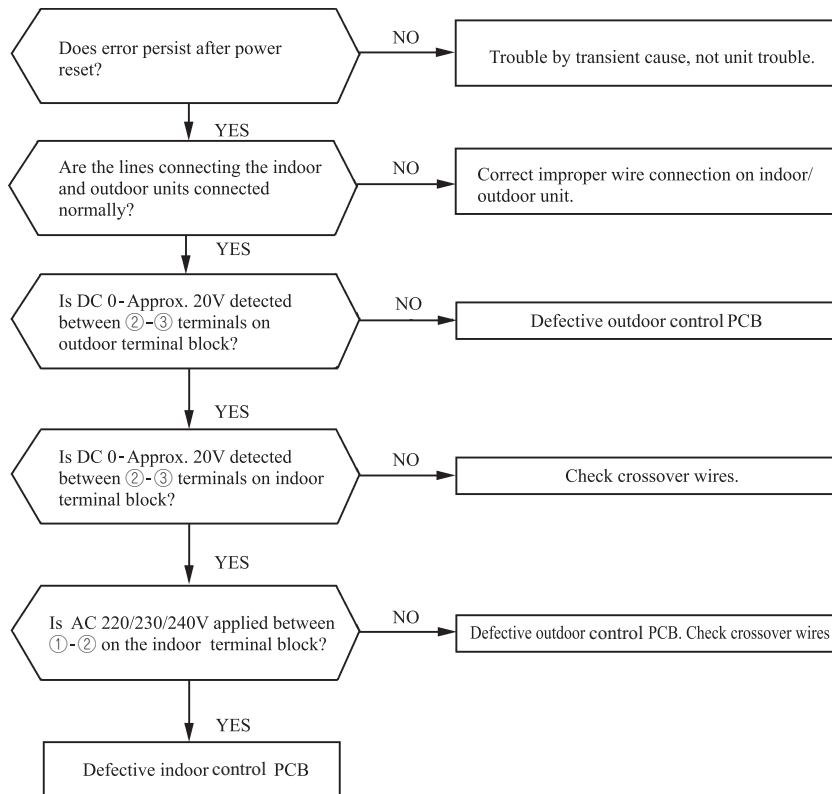

(8) Phenomenon observed after shortcircuit, wire breakage on sensor

Sensor	Operation mode	Phenomenon	
		Shortcircuit	Disconnected wire
Room temperature sensor	Cooling	Release of continuous compressor operation command.	Continuous compressor operation command is not released.
	Heating	Continuous compressor operation command is not released.	Release of continuous compressor operation command.
Heat exchanger sensor	Cooling	Freezing cycle system protection trips and stops the compressor.	Continuous compressor operation command is not released. (Anti-frosting)
	Heating	High pressure control mode (Compressor stop command)	Hot keep (Indoor fan stop)
Humidity sensor	Cooling	Refer to the table below.	Refer to the table below.
	Heating	Normal system operation is possible.	

■ Humidity sensor operation

Failure mode	Control input circuit reading	Air conditioning system operation
Disconnected wire	① Disconnected wire	Humidity reading is 0%
	② Disconnected wire	
	①② Disconnected wire	
Short circuit	① and ② are short circuited	Humidity reading is 100%

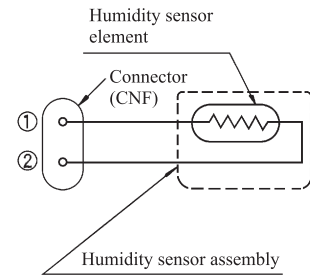

Remark: Do not perform a continuity check of the humidity sensor with a tester. If DC current is applied, it could damage the sensor.

(9) Checking the indoor electrical equipment

(a) Indoor control PCB check procedure

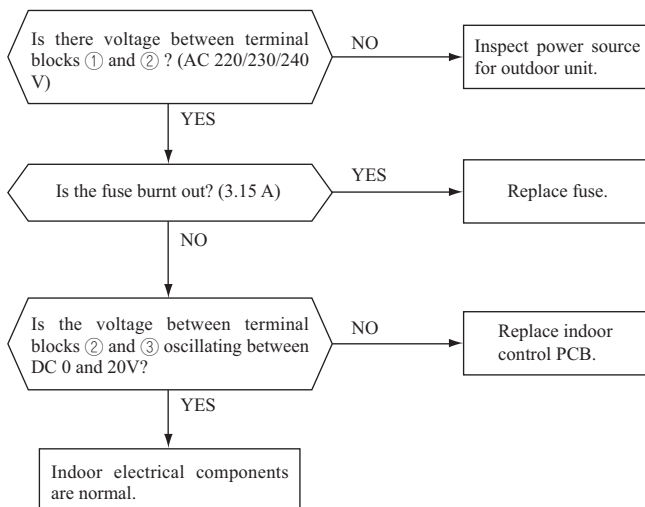

(b) Indoor unit fan motor check procedure

This is a diagnostic procedure for determining if the indoor unit's fan motor or the indoor control PCB is broken down.

1) Indoor control PCB output check

- a) Turn off the power.
- b) Remove the front panel, then disconnect the fan motor lead wire connector.
- c) Turn on the power. If the unit operates when the ON/OFF button is pressed, if trouble is detected after the voltages in the following figure are output for approximately 30 seconds, it means that the indoor control PCB is normal and the fan motor is broken down.

If the voltages in the following figure are not output at connector pins No. ①, ④ and ⑤, the indoor control PCB has failed and the fan motor is normal.

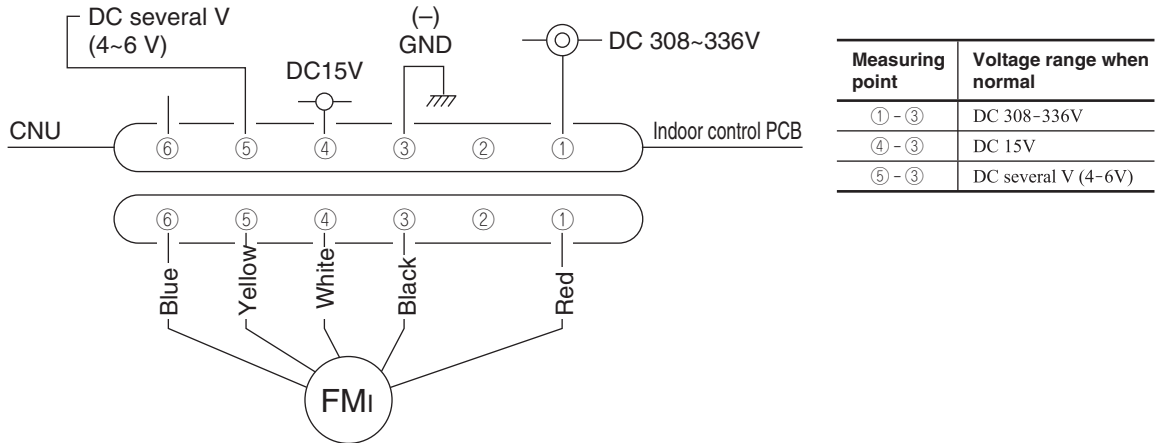

2) Fan motor resistance check

Measuring point	Resistance when normal
① - ③ (Red - Black)	20 MΩ or higher
④ - ③ (White - Black)	20 kΩ or higher

- Notes (1) Remove the fan motor and measure it without power connected to it.
 (2) If the measured value is below the value when the motor is normal, it means that the fan motor is faulty.

(10) How to make sure of wireless remote control

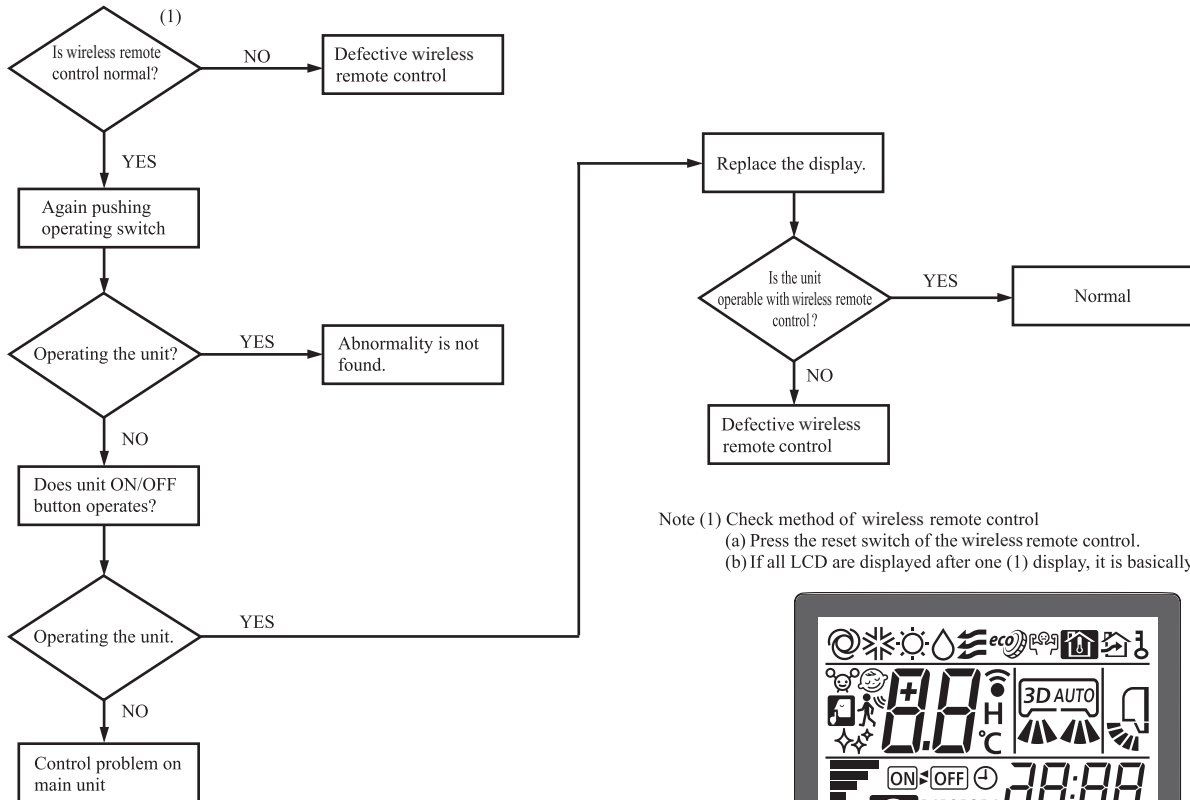

Note (1) Check method of wireless remote control
 (a) Press the reset switch of the wireless remote control.
 (b) If all LCD are displayed after one (1) display, it is basically normal.

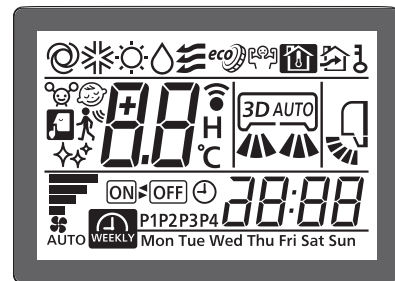

◆ Simplified check method of wireless remote control
 It is normal if the signal transmission section of the wireless remote control emits a whitish light at each transmission on the monitor of digital camera.

(11) Inspection procedure for blown fuse on the indoor control PCB

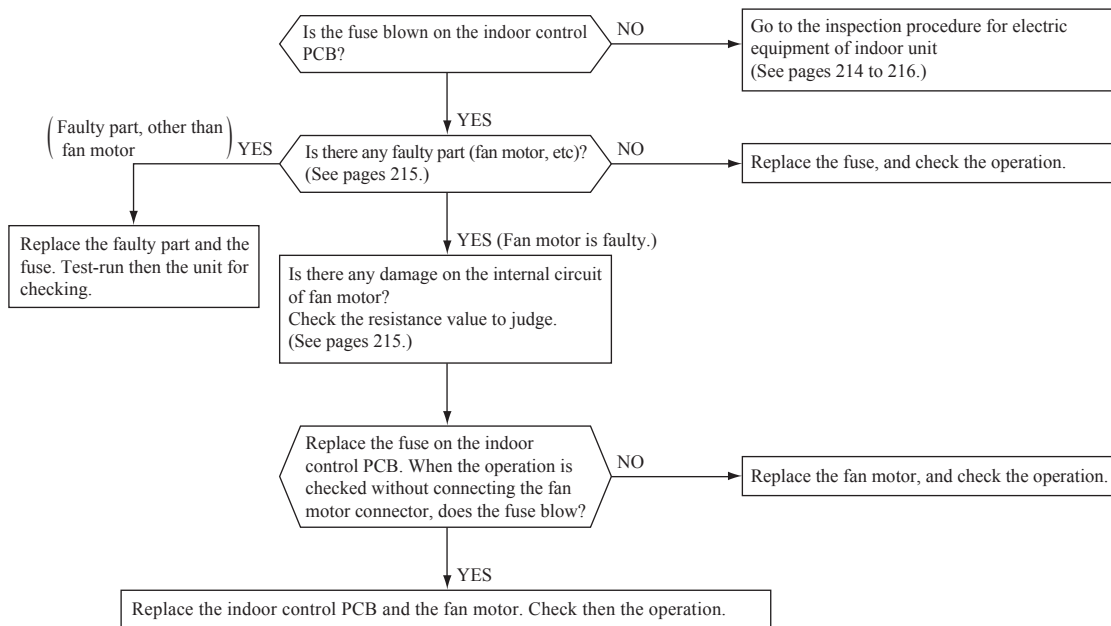

13. OPTION PARTS

13.1 Wireless kit

(1) FDT series (RCN-T-36W-E)

PJF012D010

Notes :

Following functions of indoor unit series are not able to be set with this wireless remote control (RCN-TC-36W-E).

1. Individual flap control system
2. 4-fan speed setting (P-Hi/Hi/Me/Lo) → 3-fan speed setting (Hi/Me/Lo)

⚠ WARNING

- Fasten the wiring to the terminal securely and hold the cable securely so as not to apply unexpected stress on the terminal. Loose connection or hold will cause abnormal heat generation or fire.
- Make sure the power source is turned off when electric wiring work. Otherwise, electric shock, malfunction and improper running may occur.

⚠ CAUTION

- DO NOT install the wireless kit at the following places in order to avoid malfunction.

(1) Places exposed to direct sunlight (2) Places near heat devices (3) High humidity places (4) Hot surface or cold surface enough to generate condensation (5) Places exposed to oil mist or steam directly (6) Uneven surface (7) Places affected by the direct airflow of the AC unit.	(8) Places where the receiver is influenced by the fluorescent lamp (especially inverter type) or sunlight. (9) Places where the receiver is affected by infrared rays of any other communication devices (10) Places where some object may obstruct the communication with the remote control
---	--
- DO NOT leave the wireless kit without the cover. In case the cover needs to be detached, protect the receiver with a packaging box or bag in order to keep it away from water and dust.

Attention

- Instruct the customer how to operate it correctly referring to the instruction manual.
- For the installation method of the air-conditioner itself, refer to the installation manual enclosed in the package.

① Accessories

Please make sure that you have all of the following accessories.

Receiver	1	Remote control holder	1
Wireless remote control	1	Wood screw for holder	2
Parts set	1	AAA dry cell battery (RC3)	2

② How to install the receiver

The receiver can be installed by replacing with a corner panel on the applicable decorative panel.

Preparation before installation

- ① Attach the decorative panel onto the air-conditioner according to the installation manual for the panel.
- ② Remove the air return grille.
- ③ Remove a corner panel located on the refrigerant pipes side.
- ④ Remove three screws and detach the cover (indicated as shadowed area) from the control box of the air-conditioner.

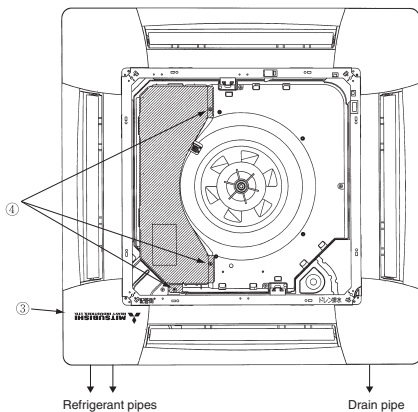

Setting on site

① PCB on the receiver has the following switches to set the functions. Default setting is shown with mark.

SW 1	Customized signal setting to avoid mixed communication	ON : Normal OFF : Remote
SW 2	Receiver master/slave setting	ON : Master OFF : Slave
SW 3	Buzzer valid/Invalid	ON : Valid OFF : Invalid
SW 4	Auto restart	ON : Valid OFF : Invalid

<To change the settings>

- ② Remove the cover by unscrewing two screws from the back of receiver.
- ③ Change the setting by the switch on PCB.

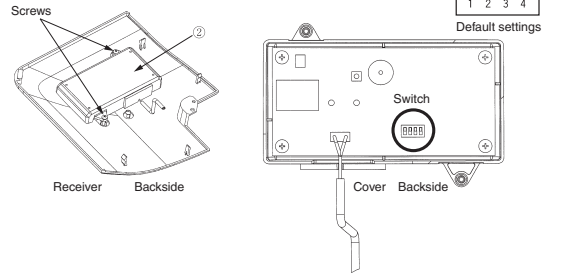

- ④ When SW1 is turned to OFF position, change the corresponding remote control setting as follows:

How to change the remote control setting

Pressing [ACL] and [AIR FLOW] button at the same time or inserting the batteries with pressing [AIR FLOW] button will customize the signal.

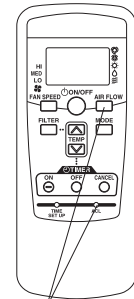

Note

※ When the batteries are removed, the setting will return to the default setting. Please make sure to reset it when the batteries are replaced.

Caution

Instruct the customer to set the mentioned above when replacing the batteries. (How to set is also mentioned in the user's manual attached on the air-conditioner.)

Radio interference prevention mode

Installation of the receiver

- ① Loosen the bolts which fix the panel and make a gap between the panel and the indoor unit
- ② Put the wiring of the receiver through the opening.
- ③ Put the wiring on the notch on the control box so as not to be pinched by the control box and lid as shown below.
- ④ Connect the wiring to the terminal block provided in the control box. (No polarity)
- ⑤ Attach the receiver to the panel according to the panel installation manual.
- ⑥ Fix the wiring with the clamp so that the wiring do not contact the edge of control box's metal sheet.
- ⑦ Reattach the control box lid with 3 screws removed.

※ Note: Make sure the wires not to be pinched by any other parts like panel, control box and indoor unit.

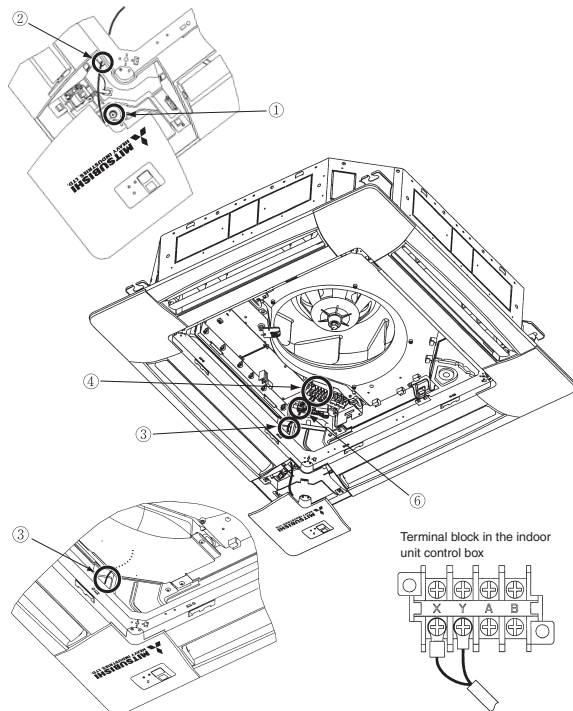

3 Remote control

Installation of the control holder

Caution

- DO NOT install it on the following places
1. Places exposed to direct sunlight
 2. Places near heat devices
 3. High humidity places
 4. Hot surface or cold surface enough to generate condensation
 5. Places exposed to oil mist or steam directly.
 6. Uneven surface

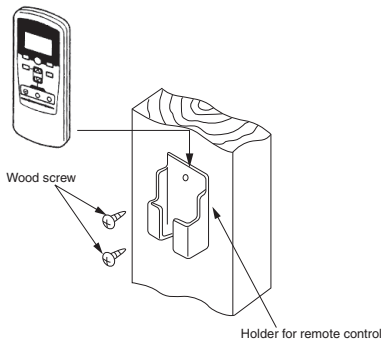

Installation tips for the remote control holder

- Adjust and keep the holder upright
- Tighten the screw to the end to avoid scratching the remote control.
- DO NOT attach the holder on plaster wall.

How to insert batteries

- 1 Detach the back lid.
- 2 Insert the batteries. (two AAA batteries)
- 3 Reattach the back lid.

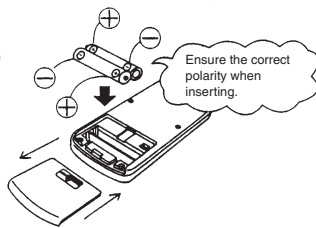

Control plural indoor units with one remote control

Up to 16 indoor units can be connected.

- 1 Connect the XY terminal with 2-core wire. As for the size, refer to the following note.
- 2 For Packaged air-conditioner series, set the indoor unit address with SW2 on the indoor unit PCB from [0] to [F] so as not to duplicate.

Restrictions on the thickness and length of wire (Maximum total extension 600m.)	
Standard	Within 100m x 0.3 mm ²
	Within 200m x 0.5 mm ²
	Within 300m x 0.75mm ²
	Within 400m x 1.25mm ²
	Within 600m x 2.0 mm ²

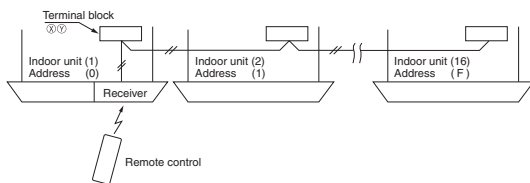

- 3 For VRF series, set the indoor unit address with SW1, SW2 and SW5-2 on the indoor unit PCB from [000] to [127] so as not to duplicate.

Master/Slave setting when using plural remote controls

Up to two receivers can be installed in one indoor unit group. When two receivers are used, it is necessary for a receiver to turn OFF SW2 on the receiver PCB to set it as slave.

(For the method of switching, please see **Setting on site** in the section of **How to install the receiver** in this manual.)

Wireless remote control's operable area

- 1 Standard reachable area of the signal
[condition] Illuminance at the receiver: 300lux
(when no lighting is installed within 1m of the receiver in an ordinary office.)

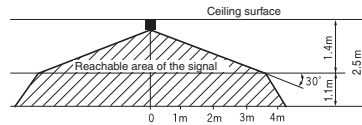

- 2 Correlation between illuminance at the receiver and reachable area of the signal in a plain view.
The drawing in the right shows the correlation between the reachable area of the signal and illuminance at the receiver when the remote control is operated at 1.1m high under the condition of ceiling height of 2.5m. When the illuminance becomes double, the area is narrowed down to two thirds.

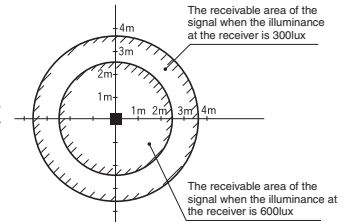

- 3 Installation tips when several receivers are installed close
Minimum distance between the indoor units which can avoid cross communication is 5m under the condition of 300lux of illuminance at the receiver.
(When no lighting is installed within 1m of the receiver in an ordinary office)

4 How to disable the Auto mode operation

VRF system (except heat recovery 3-pipe systems) cannot be operated in Auto mode.
Make sure to set the remote control for the models so as not to be able to choose Auto mode.

Pushing **ACL** and **MODE** button at the same time or inserting the batteries with pressing **MODE** button will make auto mode operation.

Attention

※ When the batteries are removed, the setting will return to the default setting (Auto mode is valid).

Caution

Instruct the customer to set the mentioned above when replacing the batteries. (How to set is also mentioned in the user's manual attached on the air-conditioner.)

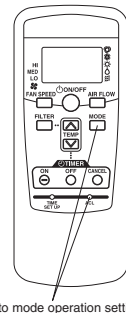

5 Backup button

A Backup button is provided on the receiver. Even when the operation from the wireless remote control is not possible (due to flat batteries, controller lost, or control failure), still it possible to operate as temporary means. Press the button directly when operating it.

- 1 The air-conditioner starts the operation with the condition of Auto mode, 23°C of set point, High fan speed and horizontal louver position.
- 2 The air-conditioner stops the operation when the button is pressed when in operation.

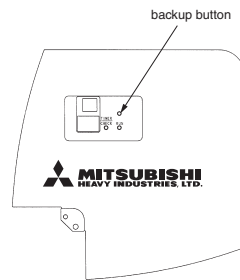

6 Cooling test run operation

- After safety confirmation, turn on the power.
- Transmit a cooling operation command with wireless remote control, while the backup button on the receiver is pressed.
- If the backup button on the receiver is pressed during a test run, it will end the test run.
- If you cannot operate the unit properly during a test run, please check by consulting with inspection guides on the wiring diagram of outdoor units.

7 How to read the two-digit display

On the receiver of a wireless kit, a two-digit (7-segment) display is provided.



- 1 An indication will be displayed for one hour after power on.
- 2 An indication will be displayed for 3.5 seconds after transmitting a "STOP" command from the wireless remote control or the operation of the backup button to stop the unit.
- 3 An indication appearing in (1) or (2) above will go off as soon as the unit starts operation.
- 4 When there are no error records to indicate, addresses of all the connected units are displayed.
- 5 When there are some error records remaining, the error records are displayed.
- 6 Error records can be cleared by transmitting a "STOP" command from the wireless remote control, while the backup button is pressed.

(2) FDE series (RCN-E-E)

Notes :
 Following functions of indoor unit series are not able to be set with this wireless remote control (RCN-E-E).
 1. Flap control system
 2. 4-fan speed setting (P-Hi/Hi/Me/Lo) → 3-fan speed setting (Hi/Me/Lo)

PFA012D619A

⚠ WARNING

- **Use specified wire for electrical wiring, fasten the wiring to the terminal securely, and hold the cable securely in order not to apply unexpected stress on the terminal.** 
 Loose connections or hold could result in abnormal heat generation or fire.
- **Turn off the power source during servicing or inspection work.** 
 If the power is supplied during servicing or inspection work, it could cause electric shock and injury by the operating fan.
- **Shut off the power before electrical wiring work.** 
 It could cause electric shock, unit failure and improper running.





⚠ CAUTION

- **DO NOT install it on the following places** 

1. Places exposed to direct sunlight	4. Places where the receiver is influenced by the fluorescent lamp or sunlight.
2. Places near heat devices	5. Places where the receiver is affected by infrared rays of any other communication devices.
3. High humidity places	6. Places where some object may obstruct the communication with the remote control.

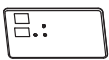
① Accessories

Please make sure that you have all of the following accessories.

Receiver	Remoto control holder	AAA dry cell battery (RO3)	Wood screw for holder	Wireless remote control
				
1	1	2	2	1

② Preparation before installation

Setting on site

PCB on the receiver has the following switches to set the function.
 Default setting is shown with mark.

SW1	Prevents interference during plural setting	ON : Normal (1ch) OFF : Customized (2ch)
SW2	Receiver master/slave setting	ON : Master OFF : Slave
SW3	Buzzer valid/Invalid	ON : Valid OFF : Invalid
SW4	Auto restart	ON : Valid OFF : Invalid

To change setting

1. Remove four screws located on the back of the receiver and detach the board.
2. Change the setting by the switch on PCB.

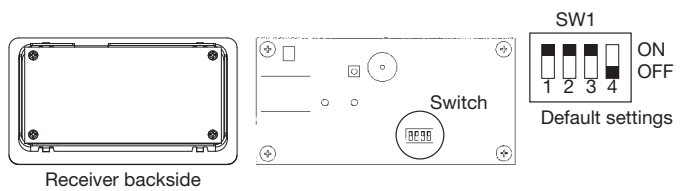

3. When switch 1 is turned to off position, change the wireless remote control setting.
 (For the method of changing the setting, refer to **Setting to avoid mixed communication** on page 2)
 Refer to **Wireless remote control unit operation distance** of **5 Receiver** in case of plural setting.

Master/Slave setting when using plural remote controls

Up to two receiver or wired remote control can be installed in one indoor unit group.
 When two receiver or wired remote control are used, it is necessary to change SW on the PCB to set it as slave.

③ How to install the receiver

The receiver can be installed by replacing with a cover of the panel.

CAUTION : When installing the receiver after unit has been fixed, injury due to falling may result because of working at high place.

① **Remove the cover**

Insert a flat-blade screwdriver into the dented part (2 places), and wrench slightly.

② **Connect the wiring**

Connect wiring of the receiver to the wiring in the back.

ATTENTION

DO NOT remove the clamp fixed the wiring.

③ **Installation of the receiver**

Check direction of the receiver, and fix to the panel.

CAUTION : Connect the connectors before installing the receiver.

In case of connecting after the receiver had been installed, it will be necessary to remove the panel.

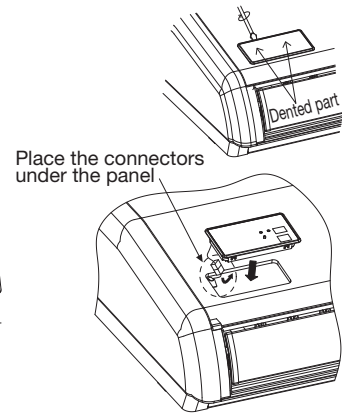
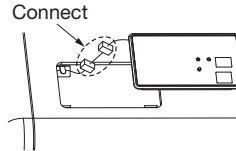

④ Wireless remote control

CAUTION DO NOT install it on the following places.

- | | |
|--------------------------------------|--|
| 1. Places exposed to direct sunlight | 2. Hot surface or cold surface enough to generate condensation |
| 3. Places near heat devices | 4. Places exposed to oil mist or steam directly. |
| 5. High humidity places | 6. Uneven surface |

Installation tips for the remote control holder

- Adjust and keep the holder up right.
- Tighten the screw to the end to avoid scratching the remote control.
- DO NOT attach the holder on plaster wall.

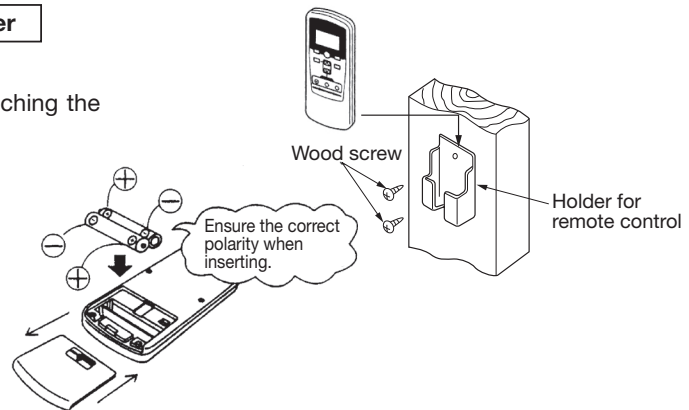

How to insert batteries

- ① Detach the back lid.
- ② Insert the batteries. (two AAA batteries)
- ③ Reattach the back lid.

Setting to avoid mixed communication

Pressing **ACL** and **AIR FLOW** button at the same time or inserting the batteries with pressing **AIR FLOW** button will customize the signal.

Setting to disable the Auto mode operation

VRF system (except heat recovery 3-pipe system) cannot be operated in Auto mode. Make sure to set the remote control for the models so as not to be able to choose Auto mode.

Pressing **ACL** and **MODE** button at the same time or inserting the batteries with pressing **MODE** button will make auto mode operation.

ATTENTION

When the batteries are removed, the setting will return to the default setting.

Please make sure to reset it when the batteries are replaced.

Caution

Instruct the customer to set the mentioned above when replacing the batteries.

(How to set is also mentioned in the user's manual attached on the air-conditioner.)

Radio prevention mode

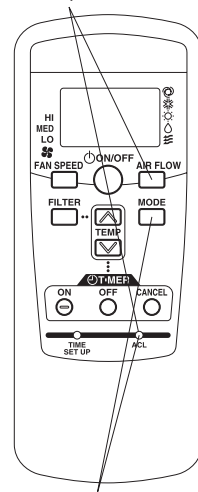

Auto mode operation setting

⑤ Receiver

Control plural indoor units with one remote control

Up to 16 indoor units can be connected.

- ① Connect indoor units with each other with 2-core wires. As for size, refer to the following note.
- ② The receiver wires must be connected only with the indoor unit that will be operated by the remote control directly.
- ③ Use the rotary SW1 and SW2 provided on the indoor unit PCB (Printed circuit board) to set unique remote control communication address avoiding duplication.

Restrictions on the thickness and length of wire
(Maximum total extension 600m.)

Standard	Within 100m x 0.3 mm ²
	Within 200m x 0.5 mm ²
	Within 300m x 0.75 mm ²
	Within 400m x 1.25 mm ²
	Within 600m x 2.0 mm ²

After a unit is energized, it is possible to display an indoor unit address by pressing [AIR CON No.] button on the remote control unit.
Press the ▲ or ▼ button to make sure that all indoor units connected are displayed in order.

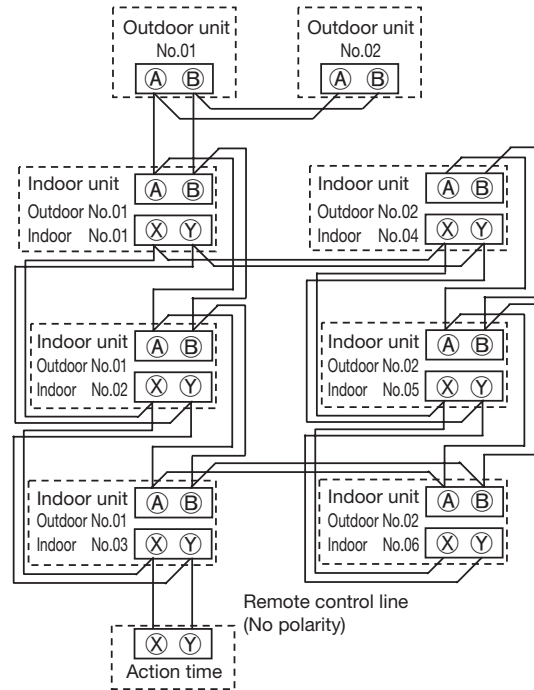

Wireless remote control unit operation distance

- ① Standard signal receiving range

[Condition]

Illuminance at the receiver area: 360 lux.
(When no lighting fixture is located within 1m of indoor unit in an ordinary office)

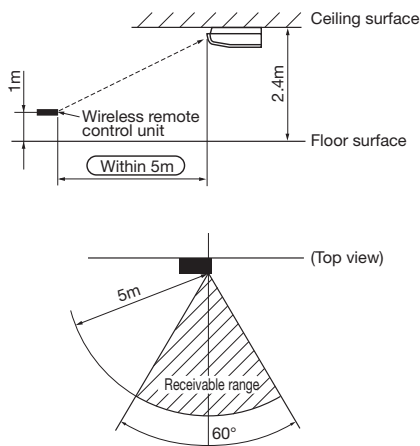

- ② Points for attention in connecting a plural number of indoor units

[Condition]

Illuminance at the receiver area: 360 lux.

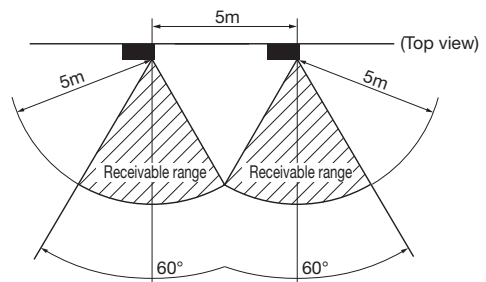

⑤ Receiver (continued)

Backup button

A backup switch is provided on the receiver section of the panel surface.

When operation from the wireless remote control unit is not possible (due to flat batteries, a mislaid unit, a unit failure), you can use it as an emergency means. You should operate this switch manually.

(1) If pressed while the air-conditioner is in a halt, it will cause the air-conditioner to start operation in the automatic mode (in the case of cooling only, in the cooling mode).

Wind speed: Hi fan, Temperature setting: 23°C, Louver: horizontal

(2) If pressed while the air-conditioner is in operation, it will stop the air-conditioner.

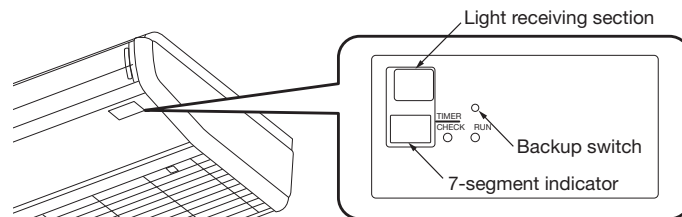

Cooling test run operation

- After safety confirmation, turn on the power.
- Transmit a cooling operation command with the wireless remote control unit, while the backup switch on the receiver is depressed.
- If the backup switch on the receiver is pressed during a test run, it will end the test run.
- If you cannot operate the unit properly during a test run, please check wiring by consulting with inspection guides.

How to read the two-digit display

A two-digit indicator (7-segment indicator) is provided on the receiver section.

- (1) An indication will be displayed for one hour after power on.
- (2) An indication appears for 3.5 seconds when a Stop command is sent from the wireless remote control unit while the air-conditioner is not running.
- (3) An indication appearing in (1) or (2) above will go off as soon as the unit starts operation.
- (4) When there are no error records to indicate, addresses are displayed for all of the connected units.
- (5) When there are some error records remaining, the error records are displayed.
- (6) Error records can be cleared by transmitting a "Stop" command from the wireless remote control unit, while the backup switch is depressed.

(3) FDU, FDUM, FDF series (RCN-KIT3-E)

Notes:

Following functions of indoor unit series are not able to be set with this wireless remote control (RCN-KIT3-E).

- 4-fan speed setting (PHI/Hi/Me/Lo) → 3-fan speed setting (Hi/Me/Lo)

Read this manual together with the installation manual attached to the air conditioner.

PJZ012D060

WARNING

- Fasten the wiring to the terminal securely and hold the cable securely so as not to apply unexpected stress on the terminal. **Loose connection or hold will cause abnormal heat generation or fire.**
- Make sure the power source is turned off when electric wiring work. **Otherwise, electric shock, malfunction and improper running may occur.**

CAUTION

- DO NOT install the wireless kit at the following places in order to avoid malfunction.
 - Places exposed to direct sunlight
 - Places near heat devices
 - High humidity places
 - Hot surface or cold surface enough to generate condensation
 - Places exposed to oil mist or steam directly
 - Uneven surface
 - Places affected by the direct airflow of the AC unit.
 - Places where the receiver is influenced by the fluorescent lamp (especially in verter type) or sunlight.
 - Places where the receiver is affected by infrared rays of any other communication devices.
 - Places where some object may obstruct the communication with the remote control
- DO NOT leave the wireless kit without the cover. In case the cover needs to be detached, protect the receiver with a packaging box or bag in order to keep it away from water and dust.

Attention

- Instruct the customer how to operate it correctly referring to the instruction manual.
- User's manual of a wireless remote control is attached to a indoor unit or a outside unit.
- Read this together with a manual attached to this kit.

1 Accessories

Please make sure that you have all of the following accessories.

① Receiver	1	① Remote control holder	1
② Wiring (3m)	1	② Screw for holder	2
③ Parts set (A)	1	③ AAA dry cell battery (R03)	2
④ Parts set (B)	1	① Screw for receiver	2
⑤ Parts set (C)	1	② Fixing band	1
⑥ Wireless remote control	1	③ Clamp	5
⑦ User's manual	1	④ Screw for clamp	5
		① Receiver installation bracket	1
		② Screw for the bracket	2
		③ Installation fitting	2

2 Wireless remote control's operable area

(1) When installed on ceiling

① Standard reachable area of the signal

condition Illuminance at the receiver : 300lux (when no lighting is installed within 1m of the receiver in an ordinary of ce.)

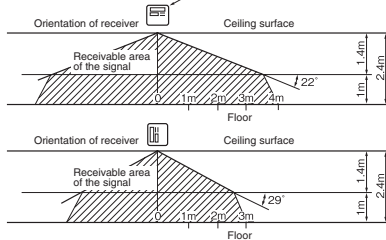

② Correlation between illuminance at the receiver and reachable area of the signal in a plain view.

condition Correlation between the reachable area of the signal and illuminance at the receiver when the remote control is operated at 1.1m high under the condition of ceiling height of 2.5m. When the illuminance becomes double, the area is narrowed down to two third.

(2) When installed on wall

condition Illuminance at the receiver : 800lux.

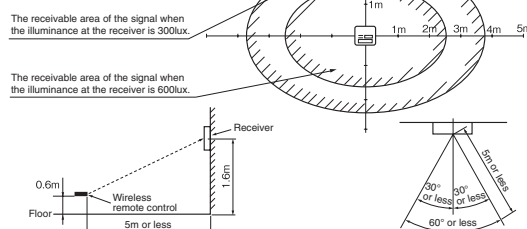

3 How to install the receiver

The following two methods can be used to install the receiver onto a ceiling or a wall. Select a method according to the installation position.

<Installation position>

- (A) Direct installation onto the ceiling with wood screws.
- (B) Installation with accessory's bracket

(1) Drilling of the ceiling (ceiling opening)

Drill the receiver installation holes with the following dimensions at the ceiling position where wires can be connected.

(A) Direct installation onto the ceiling with wood screws.	88mm(H)×101mm(W)
(B) Installation with enclosed bracket.	108mm(H)×108mm(W)

(2) Wiring connection of receiver

Caution

Do not connect the wiring to the power source of the terminal block. If it is connected, printed board will be damaged.

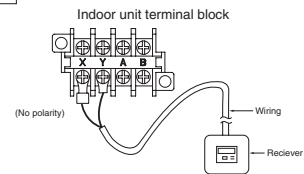

(3) Installation of the receiver

Remove the screw on the side of the receiver and sprit it into the upper case and lower case. Install the receiver with one of the two installation methods (A) or (B) shown below.

(A) Direct installation onto the ceiling with screws

Use this installation method when the ceiling is wooden, and there is no problem for strength in installing directly with wood screws.

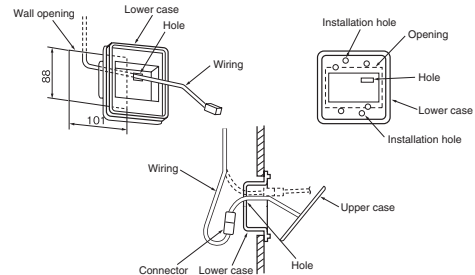

- Put through the wiring from the back side to the hole of the lower case.
- Fit the lower case into the ceiling opening. Make sure that the clearance between the convex part of the back of the lower case and the ceiling opening must be as equal as possible on both sides.
- Using the two installation holes shown above, fix the lower case onto the ceiling with the enclosed wood screws. (The other four holes are not used.)
- Connect the wiring with the wiring from the upper case by the connector.
- Take out the connector to the backside from the hole of the lower case putting through the wiring at ①.
- Fit the upper case and the lower case, and tighten the screws.

(B) Installation with enclosed bracket

Use this method when installaing onto a gypsum board (7 to 18mm), etc.

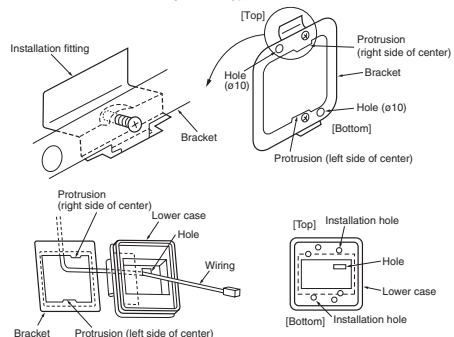

- Catch the two protrusion of the enclosed bracket onto the fitting as shown above, and temporarily fix with the screws. (The bracket has an up/down and front/back orientation. Confirm the top/bottom protrusion positions and the positional relation of the 10 holes on the bracket and the installation hole on the lower case with the above drawing.)
- Insert the end of the installation fitting into the back of the ceiling from the opening, and tighten the screws to fix the bracket onto the ceiling.
- Pass the wiring from the rear side through the hole on the lower case.
- Fit the lower case onto the bracket, and fix the lower case to the bracket using the two installation holes shown above. (The other four holes are not used.)
- Follow step ① to ⑥ for (A) to complete the installation.

④ Remote control

Installation of the control holder

Caution

DO NOT install it on the following places

- 1) Places exposed to direct sunlight
- 2) Places near heat devices
- 3) High humidity places
- 4) Hot surface or cold surface enough to generate condensation
- 5) Places exposed to oil mist or steam directly
- 6) Uneven surface

Installation tips for the remote control holder

- Adjust and keep the holder upright.
- Tighten the screw to the end to avoid scratching the remote control.
- DO NOT attach the holder to plaster wall.

How to insert batteries

- ① Detach the back lid.
- ② Insert the batteries. (two AAA batteries)
- ③ Reattach the back lid.

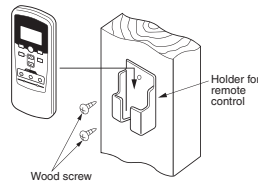

⑤ Cooling test run operation

- After safety confirmation, turn on the power.
- Transmit a cooling operation command with wireless remote control, while the backup button on the receiver is pressed.
- If the backup button on the receiver is pressed during a test run, it will end the test run.
- If you cannot operate the unit properly during a test run, please check by consulting with inspection guides on the wiring diagram of outdoor units.

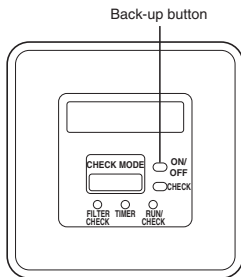

⑥ Setting of wireless remote control and receiver

(A) Methods of avoiding the malfunction due to the mixed communication

Do both procedures ① and ②.

This setting is to avoid the mixed communication with other household electric appliances or the mixed communication when two receivers are located closely.

① Setting change of the wireless remote control

Pressing **ACL** and **AIRFLOW** button at the same time or inserting the batteries with pressing **AIRFLOW** button will customize the signal.

Note *When the batteries are removed, the setting will return to the default setting. Make sure to reset it when the batteries are replaced.

② Setting the PCB of the receiver

Turn SW1-1 off.

† Wireless remote control

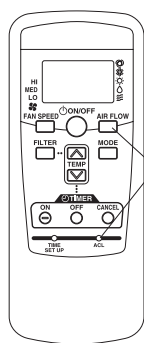

† PCB of the receiver

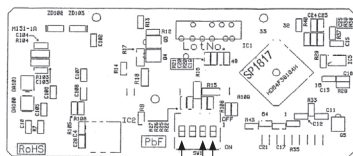

- SW1-4 (Auto restart)
- SW1-1 (Customized signal setting to avoid mixed communication)
- SW1-2 (Receiver master/slave setting)

SW1-1	Customized signal setting to avoid mixed communication	ON : Normal OFF : Remote
SW1-2	Receiver master/slave setting	ON : Master OFF : Slave
SW1-4	Auto restart	ON : Valid OFF : Invalid

□ : Default setting

(B) Control plural indoor units with one remote control

Up to 16 indoor units can be connected.

① Connect the XY terminal with 2-core wire.

As for the size, refer to the following note.

② For Packaged air-conditioner series, set the indoor unit address with SW2 on the indoor unit PCB from [0] to [F] so as not to duplicate.

Restrictions on the thickness and length of wire (Maximum total extension 600m.)	
Standard	Within 100m x 0.3 mm ²
	Within 200m x 0.5 mm ²
	Within 300m x 0.75mm ²
	Within 400m x 1.25mm ²
	Within 600m x 2.0 mm ²

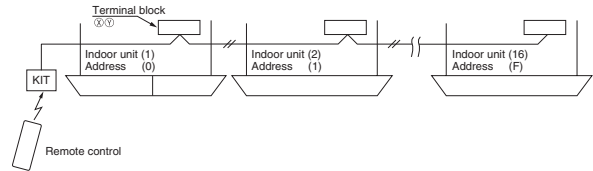

③ For VRF series, set the indoor unit address with SW1, SW2 and SW5-2 on the indoor unit PCB from [000] to [127] so as not to duplicate.

(C) Master/Slave setting when using plural remote control

Up to two receivers can be installed in one indoor unit group.

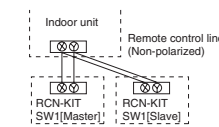

Switch	Setting	Function
SW1-2	ON	Master
	OFF	Slave

(D) Change setting of auto mode operation

Auto mode operation is prohibited to be selected for KX models (except for KXR models).

Therefore be sure to change setting of remote control to disable the auto mode operation for these models according to the following procedure.

While pressing the **MODE** button, press the **ACL** switch, or while pressing the **MODE** button, insert the batteries to the remote control. Then the auto mode can be invalid.

Attention

When the batteries are removed, it is returned to initial setting (Auto mode becomes valid).

Accordingly when replacing the batteries, be sure to perform the above operation once again.

(E) Change setting of fan speed

While pressing the **FAN SPEED** button, press the **ACL** switch, or while pressing the **FAN SPEED** button, insert the batteries to the remote control. Then the fan speed can be changed from 2-speed setting to 3-speed setting.

When changing fan speed setting of remote control, be sure to perform the same fan speed setting as that of the indoor unit model to be used.

Attention

When the batteries are removed, it is returned to initial setting (Fan speed setting is 2-speed).

Accordingly when replacing the batteries, be sure to perform the above operation once again.

13.2 Simple wired remote control (RCH-E3)

Notes:
 Following functions of indoor unit series are not able to be set with this simple wired remote control (RCH-E3).
 1. 4-fan speed setting (PHi/Hi/Me/Lo) →3-fan speed setting (Hi/Me/Lo)

Names and functions of sections

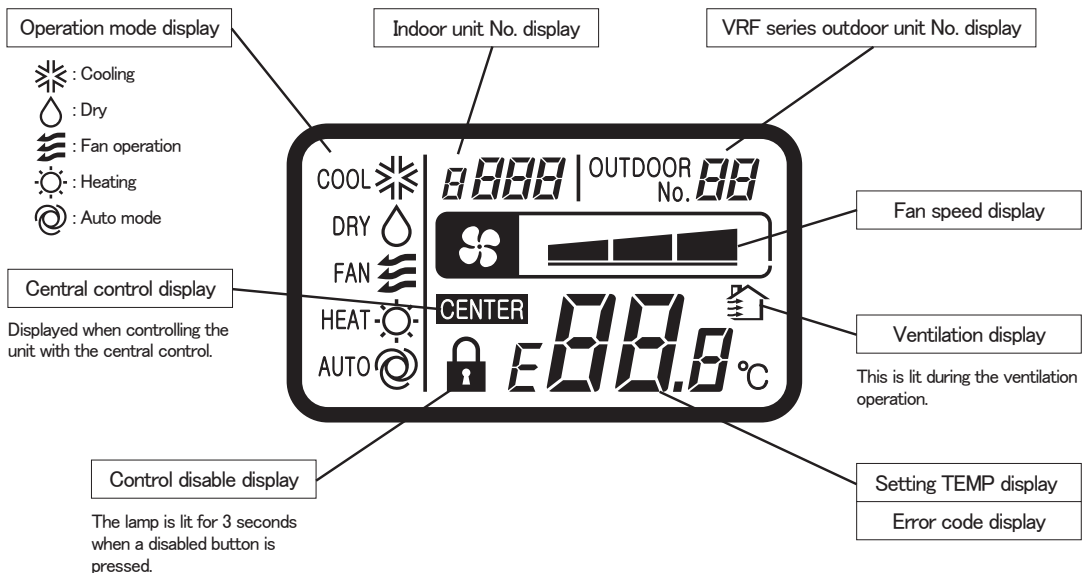
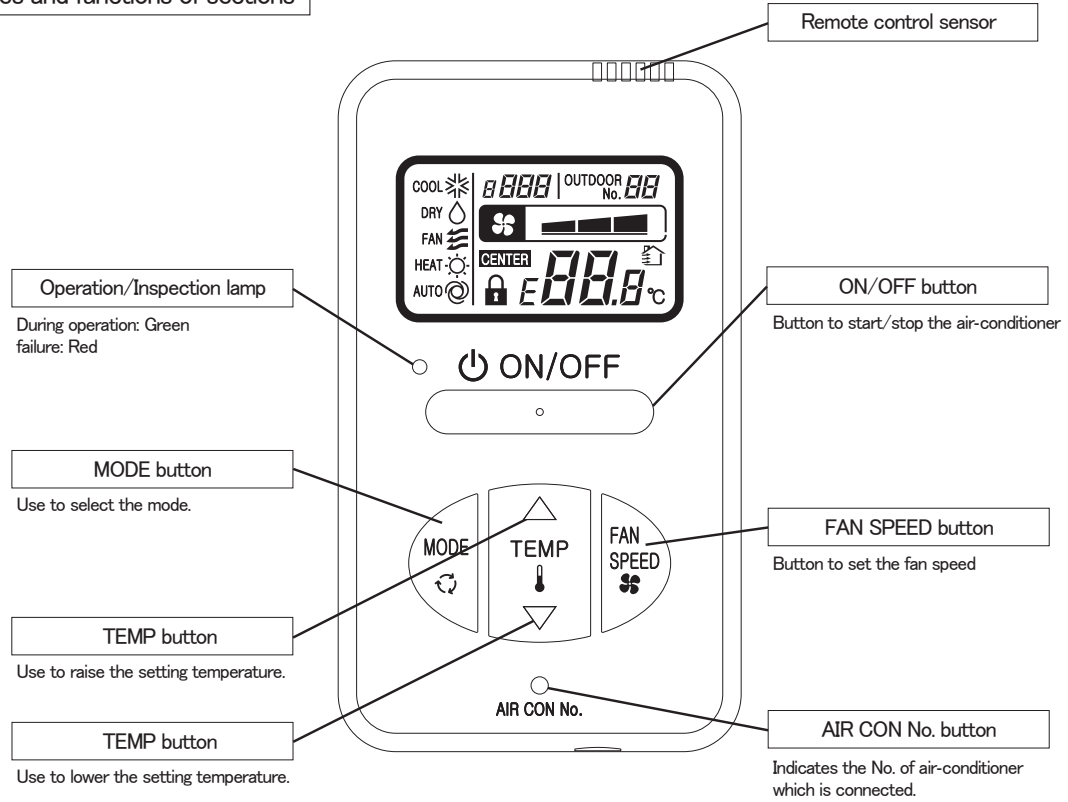

Installation of remote control

- DO NOT install the remote control at the following places in order to avoid malfunction.
- (1) Places exposed to direct sunlight
 - (2) Places near heat devices
 - (3) High humidity places
 - (4) Hot surface or cold surface enough to generate condensation
 - (5) Places exposed to oil mist or steam directly
 - (6) Uneven surface

PJZ000Z272

Remote control installation dimensions

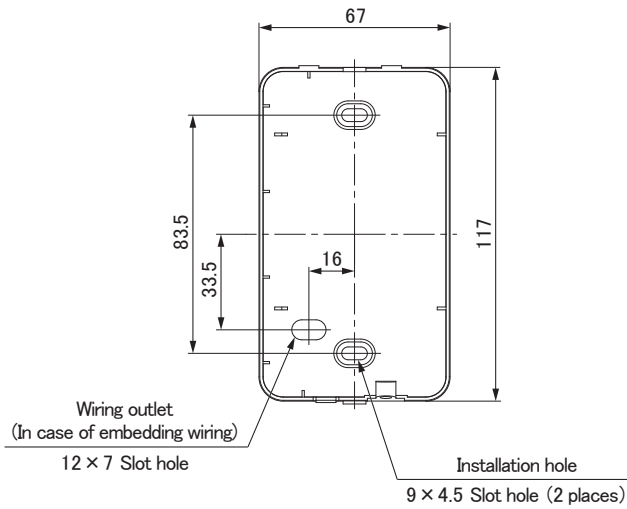

Note: Installation screw for remote control
M4 Screw (2 pieces)

In case of embedding wiring

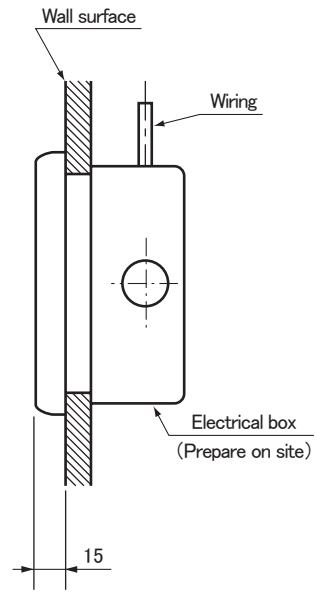

In case of exposing wiring

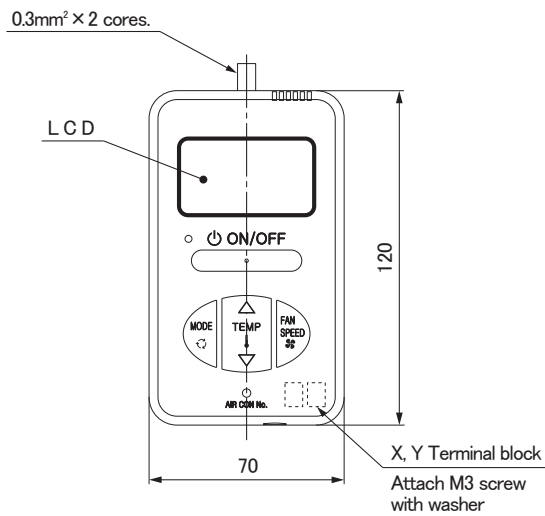

The remote control wiring can be extracted from the upper center. After the thin part in the upper side of the remote control upper case is scraped with a nipper or knife, remove burr with a file.

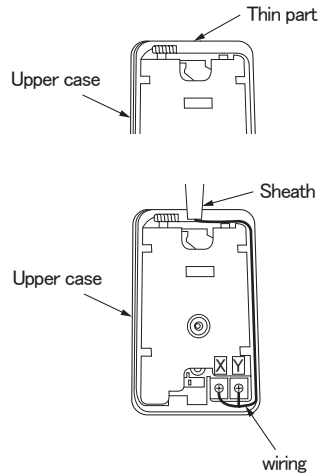

The peeling length of each wiring is as follows:

- X wiring : 160mm
- Y wiring : 150mm

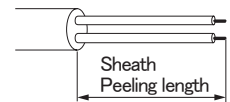

Wiring specifications

- (1) Wiring of remote control should use 0.3mm² × 2 core wires or cables. (on-site configuration)
- (2) Maximum prolongation of remote control wiring is 600m.
If the prolongation is over 100m, change to the size below.
But, the wiring in the remote control case should be 0.3mm² (recommended) to 0.5mm².
Change the wire size outside of the case according to wire connecting. Waterproof treatment is necessary at the wire connecting section. Be careful about contact failure.

Unit:mm

Length	Wiring thickness
100 to 200m	0.5mm ² × 2 cores
Under 300m	0.75mm ² × 2 cores
Under 400m	1.25mm ² × 2 cores
Under 600m	2.0mm ² × 2 cores

Adapted to **RoHS** directive

Simple Remote Control Installation Manual

PJZ012D069

Read together with indoor unit's installation manual.

⚠ WARNING

● **Fasten the wiring to the terminal securely and hold the cable securely so as not to apply unexpected stress on the terminal.**



Loose connection or hold will cause abnormal heat generation or fire.

● **Make sure the power source is turned off when electric wiring work.**



Otherwise, electric shock, malfunction and improper running may occur.

⚠ CAUTION

● **DO NOT install the remote control at the following places in order to avoid malfunction.**

- | | |
|---------------------------------------|---|
| (1) Places exposed to direct sunlight | (4) Hot surface or cold surface enough to generate condensation |
| (2) Places near heat devices | (5) Places exposed to oil mist or steam directly |
| (3) High humidity places | (6) Uneven surface |



● **DO NOT leave the remote control without the upper case.**

In case the upper case needs to be detached, protect the remote control with a packaging box or bag in order to keep it away from water and dust.



Accessories	Remote control, wood screw (φ 3.5 × 16) 2 pieces
Prepare on site	Remote control cord (2 cores) (Refer to [2. Installation and wiring of remote control]) [In case of embedding cord] Electrical box, M4 screw (2 pieces) [In case of exposing cord] Cord clamp (if needed)

1. Installation procedure

In case of embedding cord

- (1) **Make certain to remove** the screw on the bottom surface of the remote control.

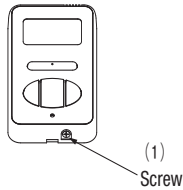

- (2) Remove the upper case of the remote control.
Insert a flat-blade screwdriver to a concave portion of the bottom surface of the remote control and slightly twist it, and the case is removed.

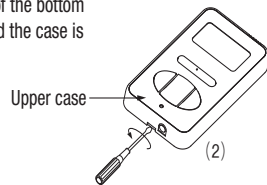

- (3) Pre-bury the electrical box and remote control cord.

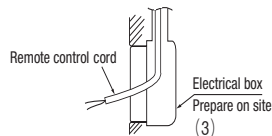

- (4) Prepare two M4 screws (recommended length: 12 – 16mm), and install the lower case to the electrical box. Do not use a screw whose screw head is larger than the height of the wall around the screw hole.

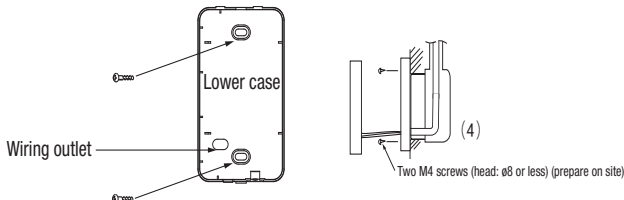

- (5) Connect the remote control cord to the terminal block.
Connect the terminals (X and Y) of the remote control and the terminals (X and Y) of the indoor unit. (No polarity of X and Y)

- (6) Mount the upper case for restoring to its former state so as not to crimp the remote control cord, and secure with the removed screw.

In case of exposing cord

- (1) **Make certain to remove** a screw on the bottom surface of the remote control.

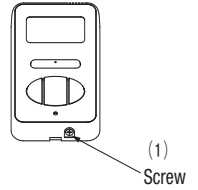

- (2) Remove the upper case of the remote control.
Insert a flat-blade screwdriver to a concave portion of the bottom surface of the remote control and slightly twist it, and the case is removed.

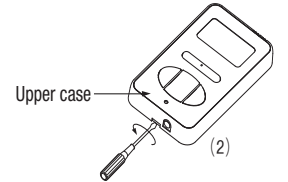

- (3) The remote control cord can be extracted from the upper center.
After the thin part in the upper side of the remote control upper case is scraped with a nipper or knife, remove burr with a file.

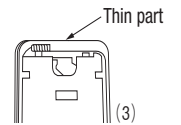

- (4) The lower case of the remote control is mounted to a flat wall with two accessory wood screws.

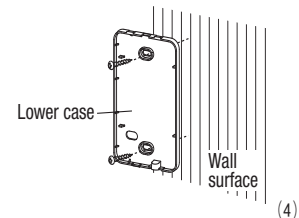

- (5) Connect the remote control cord to the terminal block.
Connect the terminals (X and Y) of the remote control and the terminals (X and Y) of the indoor unit. (No polarity of X and Y)
The wiring route is as shown in the right.

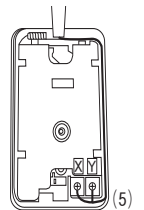

The wiring in the remote control case should be 0.3 mm² (recommended) to 0.5 mm² at maximum.

Further, peel off the sheath.

The peeling length of each wiring is as follows:

X wiring : 160mm
Y wiring : 150mm

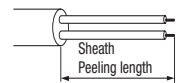

- (6) Mount the upper case for restoring to its former state so as not to crimp the remote control cord, and secure with the removed screw.

- (7) In the case of exposing installation, secure the remote control cord to the wall surface with a cord clamp so as not to loosen the remote control cord.

2. Installation and wiring of remote control

- (1) Wiring of remote control should use 0.3mm² × 2 core wires or cables. (on-site configuration)
- (2) Maximum prolongation of remote control wiring is 600 m.
If the prolongation is over 100m, change to the size below.
But, the wiring in the remote control case should be 0.3mm² (recommended) to 0.5mm².
Change the wire size outside of the case according to wire connecting. Waterproof treatment is necessary at the wire connecting section. Be careful about contact failure.
- | | |
|------------|-------------------------------|
| 100 - 200m | 0.5mm ² × 2 cores |
| Under 300m | 0.75mm ² × 2 cores |
| Under 400m | 1.25mm ² × 2 cores |
| Under 600m | 2.0mm ² × 2 cores |

3. Master/ slave setting when more than one remote control are used

- (1) Up to two remote controls can be connected to one unit (or one group) of indoor unit.

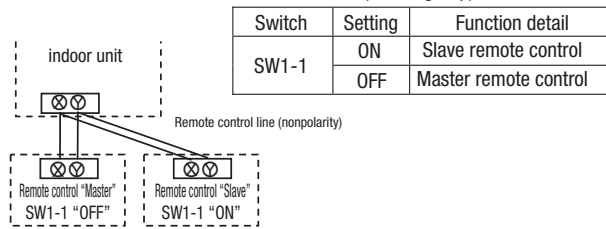

- (2) Set the switch SW1-1 of the slave remote control is "Slave" (ON). The factory default is set as "Master" (OFF).

- (Note) • The remote control thermistor enabled setting can be set only to the master remote control.
- Install the master remote control at the position to detect room temperature.
 - The air-conditioner operation follows the last operation of the remote control in case of the master / slave setting.

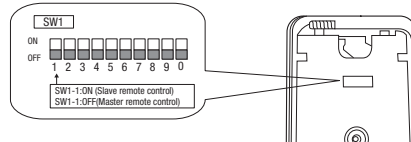

4. The indication when power source is supplied

- (1) At the time of turning the power source on, after the light is on for the first 2 seconds, the display becomes as shown below.

The number displayed on the upper side of LCD in the remote control is the software number, and this is not an error code.

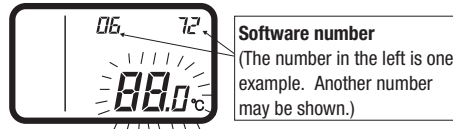

- (2) Then, "88.0 °C" blinks on the remote control until the communication between the remote control and the indoor unit is established.
- (3) In the case of connecting one remote control with one unit (or one group) of indoor unit, make certain to set the master remote control (factory default). If the slave remote control is set, a communication cannot be established.
- (4) If a state where the communication between the remote control and the indoor unit cannot be established continues about for 30 minutes, "E" is displayed. Confirm the wiring of the indoor unit and the outdoor unit and master/slave setting of the remote control.



5. Confirmation method for return air temperature

Return air temperature can be confirmed by the remote control operation.

- (1) Press **AIR CON No.** button for over 5 seconds.
 "88" blinks on the temperature setting indicator.
 ("88" blinks for approximately 2 seconds while data are read.)



Then, the return air temperature is displayed.
 (Example) return air temperature: "27 °C" (blinking)

(Note) For the return air temperature, in the normal case, the return air temperature of the indoor unit is displayed; however, in the case that the remote control thermistor is effective, detected temperature by the remote control thermistor is displayed.

- (2) Press **ON/OFF** button.
 End.

[In the case that the remote thermistor is ineffective and plural indoor units are connected to one remote control]

- (1) Press **AIR CON No.** button for over 5 seconds.
 indoor unit No. indicator: "U 000" (blinking)
 (Among the connected indoor units, the lowest number is displayed.)



- (2) Press **TEMP Δ** or **TEMP ▽** button.
 Select the indoor unit No.

- (3) Press **MODE** button.
 Decider the indoor unit No.
 (Example) indoor unit No. indicator: "U 000"

"88" blinks on the temperature setting indicator. (blinking for approximately 2 to 10 seconds while data is read) Then, the return air temperature is displayed. When **AIR CON No.** is pressed, return to the indoor unit selection display (example, "U 000").

- (4) Press **ON/OFF** button.
 End.

6. Function setting

Each function of the remote control and the indoor unit is automatically set to the initial setting, which is the standard use, on the occasion of connecting the remote control with the indoor unit. In the case of the standard use, the setting change is unnecessary. However, if you would like to change the initial setting "○", change the setting for only the item of the function number. **Record the setting contents and stored them.**

(1) Function setting item by switch on PCB

Switch No.	Setting	Setting detail	Initial setting	Switch No.	Setting	Setting detail	Initial setting
SW1-1	ON	Slave remote control		SW1-5	ON	"TEMP" button prohibited	
	OFF	Master remote control	○		OFF	"TEMP" button enabled	○
SW1-2	ON	Remote control thermistor enabled		SW1-6	ON	"FAN SPEED" button prohibited	※ Note 1
	OFF	Remote control thermistor disabled	○		OFF	"FAN SPEED" button enabled	※ Note 1
SW1-3	ON	"MODE" button prohibited		SW1-7	ON	Auto restart function enabled	
	OFF	"MODE" button enabled	○		OFF	Auto restart function disabled	○
SW1-4	ON	"ON/OFF" button prohibited		SW1-8, 9, 0	ON	Not used	
	OFF	"ON/OFF" button enabled	○		OFF	Not used	

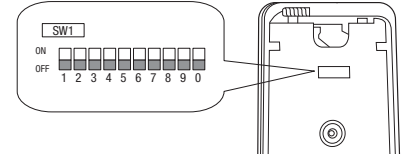

- As for the slave remote control, function setting is impossible other than SW1-1.
- In the indoor unit with only one fan speed, "FAN SPEED" button cannot be enabled.

(2) Function setting item by button operation

Classification	Function No.	Function	Setting No.	Setting	Initial setting	Remarks
Remote control function	01	Indoor unit fan speed	01	Fan speed: three steps	※ Note 1	The fan speed is three steps, $\text{Hi} - \text{Mid} - \text{Lo}$.
			02	Fan speed: two steps (Hi-Lo)	※ Note 1	The fan speed is two steps, $\text{Hi} - \text{Lo}$.
			03	Fan speed: two steps (Hi-Me)		The fan speed is two steps, $\text{Hi} - \text{Me}$.
			04	Fan: one step	※ Note 1	The fan speed is fixed to one step.
	03	Remote control thermistor at the time of cooling	01	Remote control thermistor: no offset	○	
			02	Remote control thermistor: +3.0 °C		At the time of cooling, in the case of remote control thermistor enabled, offset temperature at +3.0°C.
			03	Remote control thermistor: +2.0 °C		At the time of cooling, in the case of remote control thermistor enabled, offset temperature at +2.0°C.
			04	Remote control thermistor: +1.0 °C		At the time of cooling, in the case of remote control thermistor enabled, offset temperature at +1.0°C.
			05	Remote control thermistor: -1.0 °C		At the time of cooling, in the case of remote control thermistor enabled, offset temperature at -1.0°C.
			06	Remote control thermistor: -2.0 °C		At the time of cooling, in the case of remote control thermistor enabled, offset temperature at -2.0°C.
			07	Remote control thermistor: -3.0 °C		At the time of cooling, in the case of remote control thermistor enabled, offset temperature at -3.0°C.
	04	Remote control thermistor at the time of heating	01	Remote control thermistor: no offset	○	
			02	Remote control thermistor: +3.0 °C		At the time of heating, in the case of remote control thermistor enabled, offset temperature at +3.0°C.
			03	Remote control thermistor: +2.0 °C		At the time of heating, in the case of remote control thermistor enabled, offset temperature at +2.0°C.
			04	Remote control thermistor: +1.0 °C		At the time of heating, in the case of remote control thermistor enabled, offset temperature at +1.0°C.
			05	Remote control thermistor: -1.0 °C		At the time of heating, in the case of remote control thermistor enabled, offset temperature at -1.0°C.
			06	Remote control thermistor: -2.0 °C		At the time of heating, in the case of remote control thermistor enabled, offset temperature at -2.0°C.
			07	Remote control thermistor: -3.0 °C		At the time of heating, in the case of remote control thermistor enabled, offset temperature at -3.0°C.
	05	Ventilation setting	01	No ventilator connection	○	
			02	Ventilator links air-conditioner		In case of Single split series, by connecting ventilation device to CNT of the indoor printed circuit board (in case of VRF series, by connecting it to CND of the indoor printed circuit board), the operation of ventilation device is linked with the operation of indoor unit.
06	"Auto" operation setting	01	"Auto" operation enabled	※ Note 1		
		02	"Auto" operation disabled	※ Note 1	"Auto" operation disabled	
Indoor unit function	07	Operation permission/prohibition	01	Disabled	○	
			02	Enabled		Operation permission/prohibition control is enabled.
	08	External input	01	Level input	○	
			02	Pulse input		
	09	Fan speed setting	01	Standard	Note2	
			02	High speed 1	Note2	
			03	High speed 2	Note2	
	10	Fan remaining operation at the time of cooling	01	No remaining operation	○	After cooling stopped, no fan remaining operation
			02	0.5 hours		After cooling stopped, fan remaining operation for 0.5 hours
			03	1 hour		After cooling stopped, fan remaining operation for 1 hour
			04	6 hours		After cooling stopped, fan remaining operation for 6 hours
	11	Fan remaining operation at the time of heating	01	No remaining operation	○	After heating stopped or after heating thermostat OFF, no fan remaining operation
			02	0.5 hours		After heating stopped or after heating thermostat OFF, fan remaining operation for 0.5 hours
			03	2 hours		After heating stopped or after heating thermostat OFF, fan remaining operation for 2 hours
			04	6 hours		After heating stopped or after heating thermostat OFF, fan remaining operation for 6 hours
	12	Setting temperature offset at the time of heating	01	No offset	○	
			02	Setting temperature offset + 3.0 °C		The setting temperature at the time of heating is offset by +3.0 °C.
			03	Setting temperature offset + 2.0 °C		The setting temperature at the time of heating is offset by +2.0 °C.
			04	Setting temperature offset + 1.0 °C		The setting temperature at the time of heating is offset by +1.0 °C.
	13	Heating fan controller	01	Low fan speed	※ Note 1	At the time of heating thermostat OFF, operate with low fan speed.
02			Setting fan speed		At the time of heating thermostat OFF, operate with the setting fan speed.	
03			Intermittent operation	※ Note 1	At the time of heating thermostat OFF, intermittently operate.	
04			Fan off		At the time of heating thermostat OFF, a fan will be stopped. When the remote control thermistor is enabled, automatically set to "Fan off". Do not set at the time of the indoor unit thermistor.	
14	Return air temperature offset	01	No offset	○		
		02	Return air temperature offset +2.0 °C		Offset the return air temperature of the indoor unit by +2.0 °C.	
		03	Return air temperature offset +1.5 °C		Offset the return air temperature of the indoor unit by +1.5 °C.	
		04	Return air temperature offset +1.0 °C		Offset the return air temperature of the indoor unit by +1.0 °C.	
		05	Return air temperature offset -1.0 °C		Offset the return air temperature of the indoor unit by -1.0 °C.	
		06	Return air temperature offset -1.5 °C		Offset the return air temperature of the indoor unit by -1.5 °C.	
		07	Return air temperature offset -2.0 °C		Offset the return air temperature of the indoor unit by -2.0 °C.	

Note 1: The symbol "※" in the initial setting varies depending upon the indoor unit and the outdoor unit to be connected, and this is automatically determined as follows:

Swth No. Function No.	Function	Setting	Product model
SW1-6	"FAN SPEED" button	"FAN SPEED" button prohibited	Product model whose indoor fan speed is only one step
		"FAN SPEED" button enabled	Product model whose indoor fan speed is two steps or three steps
Remote control function 01	Indoor unit fan speed	Fan speed: three steps	Product model whose indoor unit fan speed is three steps
		Fan speed: two steps (Hi-Lo)	Product model whose indoor unit fan speed is two steps
		Fan speed: two steps (Hi-Me)	
		Fan: one step	Product model whose indoor unit fan speed is only one step
Remote control function 06	"Auto" operation setting	"Auto" operation enabled	Product model where "Auto" mode is selectable
		"Auto" operation disabled	Product model without "Auto" mode
Indoor unit function 13	Heating fan control	Low fan speed	Product model except FDUS
		Intermittent operation	FDUS

Note 2: Fan speed of "High speed" setting

Fan speed setting	Indoor unit fan speed setting		
	$\text{Hi} - \text{Mid} - \text{Lo}$	$\text{Hi} - \text{Lo}$	$\text{Hi} - \text{Hi}$
Standard	Hi - Mid - Lo	Hi - Lo	Hi - Mid
High speed 1 + 2	UHi - Hi - Mid	UHi - Mid	UHi - Hi

Initial setting of some indoor unit is "High speed".

Note 3: As for plural indoor unit, set indoor functions to each master and slave indoor unit.

But only master indoor unit is received the setting change of indoor unit function "07 Operation permission/prohibition" and "08 External input".

7. How to set functions by button operation

- (1) Stop air-conditioning, and simultaneously press **AIR CON NO.** and **MODE** buttons at the same time for over three seconds.
The function number "01" blinks in the upper right.

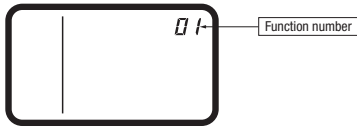

- (2) Press **TEMP▲** or **TEMP▼** button.
Select the function number.

- (3) Press **MODE** button.
Decide the function number.

- (4) [In the case of selecting the remote control function (01-06)]

- ① The current setting number of the selected function number blinks
(Example)
Function number: "01" (lighting)
Setting number: "01" (blinking)

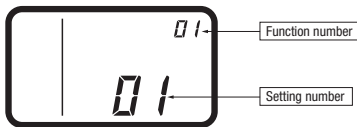

- ② Press **TEMP▲** or **TEMP▼** button.
Select the setting number.

- ③ Press **MODE** button.
The setting is completed.

Light is on for approximately 3 to 20 seconds while data of the decided function No. and setting No. is transmitted.

(Example)

Function number: "01" (lighting for 3 to 20 seconds)
Setting number: "01" (lighting for 3 to 20 seconds)

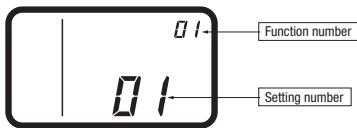

Then, the screen goes back to the function number blinking indication (1), if the setting is sequentially conducted, continue with the same procedures. If the setting is finished, proceed to (5).

- (5) Press **ON/OFF** button.
The setting is completed.

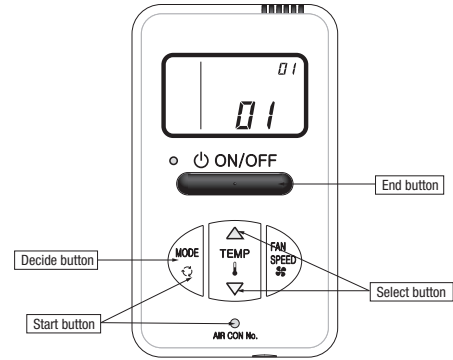

- [In the case of selecting the indoor unit function (07-14)]

- ① "88" blinks on the temperature setting indicators.
(blinking for approximately 2 to 10 seconds while data are read)



After that, the current setting number of the selected function number blinks.
(Example)

Function number: "07" (lighting)
Setting number: "01" (blinking)

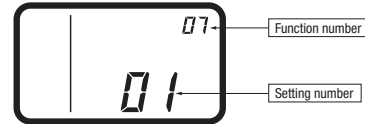

Proceed to ②.

[Note]

- a. In the case of connecting one remote control to plural indoor units, the display will be as follows:

Indoor unit No. display: "U 000" (blinking)
(Display the lowest number among the connected indoor units.)

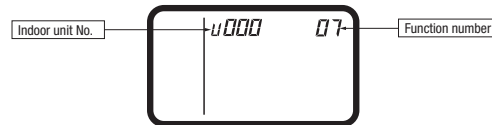

- b. Press **TEMP▲** or **TEMP▼** button.

Select the indoor unit No. to be set.
If "U ALL" is selected, the same setting can be set to all units.

- c. Press **MODE** button.
Decide the indoor unit No.

"88" blinks on the temperature setting indicators. (blinking for 2 to 10 seconds while data are read)

When **AIR CON NO.** button is pressed, go back to the indoor unit selection display (for example, "U 000" blinking).

- ② Press **TEMP▲** or **TEMP▼** button.
Select the setting number

- ③ Press **MODE** button.
The setting is completed.

Light is on for approximately 3 to 20 seconds while data of the decided function No. and setting No. are transmitted.

(Example)

Indoor unit No.: "U 000" (lighting for 3 to 20 seconds)
Function number: "07" (lighting for 3 to 20 seconds)
Setting number: "01" (lighting for 3 to 20 seconds)

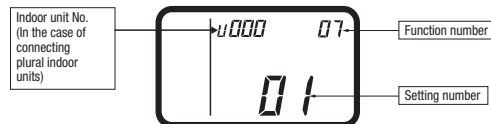

Then, the screen goes back to the function number blinking indication (1), if the setting is sequentially conducted, continue with the same procedures. If the setting is finished, proceed to (5).

- Even if **ON/OFF** button is pressed during setting, the setting is ended. However, any details where the setting has not been completed will be ineffective.
- The setting contents are stored in the controller, and even if the power failure occur, this will not be lost.

[Confirmation method for current setting]

According to the operation, the "setting number" displayed first after selecting "function number" and pressing **MODE** button is the currently set content. (However, in the case of selecting "U ALL" (all units), the setting number of the lowest number among the indoor units is displayed.)

13.3 Filter kit (FDUM series)

PJZ012D076A

This manual contains installation points and operating instructions for the filter kit manufactured by MHI. Carry out the work following the instructions below.

This manual also contains information on the usage after installation, so keep this manual properly with USER'S MANUAL provided with the indoor unit.





 **CAUTION**

- After unpacking, carry out this work on the ground.
- Do not carry out the work during operation, or there is a danger of being entangled in the rotating parts and getting injured.
- Clean the air filter regularly.
- Be sure to entrust qualified serviceman to performance on the air filter.
- Be sure to cut off the power and stop the unit before performing maintenance.

(1) Table of filter kit parts No. and corresponding object models

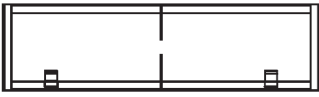
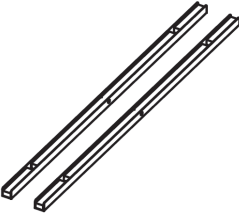
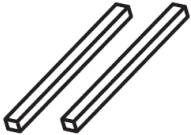
	Small model	Medium model	Large model
Single type	40, 50	60, 71	100 - 140
Multi type	22 - 56	71, 90	112 - 160
Filter Kit	UM-FL1EF	UM-FL2EF	UM-FL3EF

(2) Parts list of filter kit

Filter	Rail	Insulation
		
1pc	2pc	2pc
Bracket	Parts set (screw)	
		
1pc	(small and medium model : 5pcs.)	(large model : 7pcs.)
	1pc	

(3) Installation Points

(a) Stick the insulation on both inner sides of the duct, leaving no space up and down.

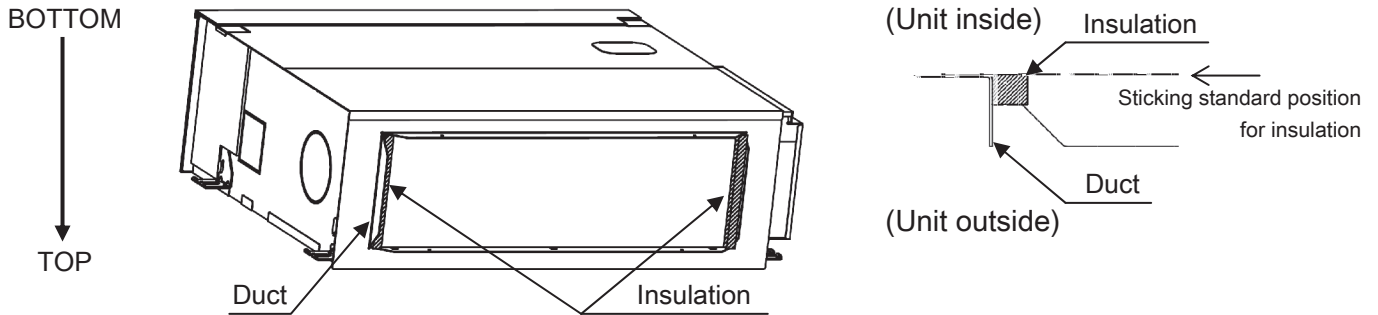

(*) After unpacking, bottom side of the unit is located at the upper side.

(b) Install the rail on both inner sides of the duct with the screw.

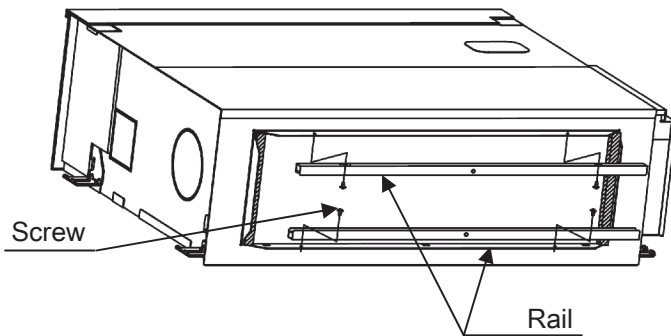

(c) Install the air filter on the rails.

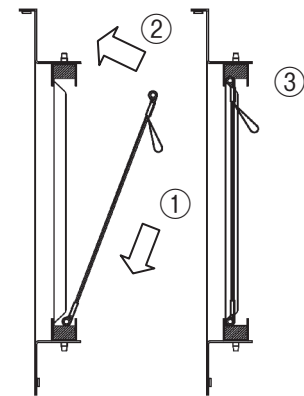
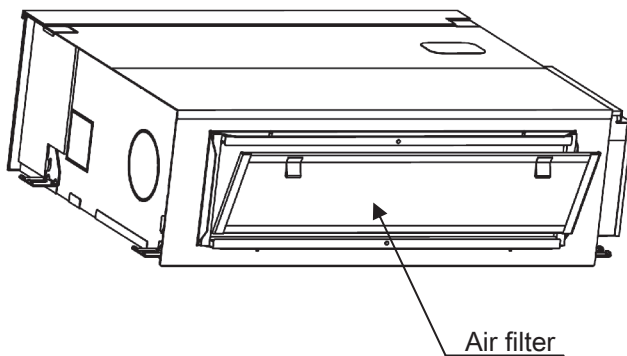

Installation procedure

(d) Install the bracket on the rail with the screw.

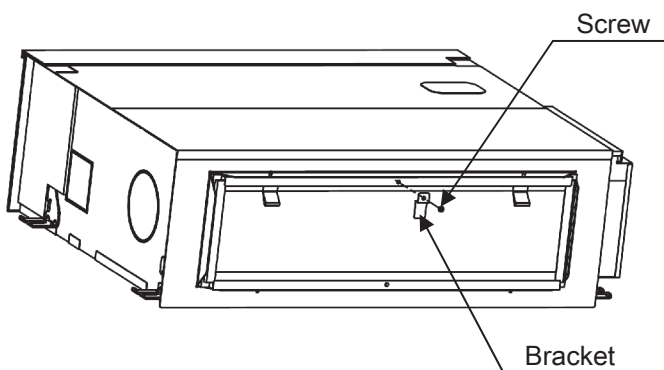

(**) When the unit is installed, bottom side of the unit is located at the lower side.

13.4 Interface kit (SC-BIKN-E)

RKZ012A088B

Accessories included in package

Be sure to check all the accessories included in package.

No.	Part name	Quantity
①	Indoor unit's connection cable (cable length: 1.8m)	1
②	Wood screws (for mounting the interface: φ4X 25)	2
③	Tapping screws (for the cable clamp and the interface mounting bracket)	3
④	Interface mounting bracket	1
⑤	Cable clamp (for the indoor unit's connection cable)	1
⑥*	CNT terminal connection cable (total cable length: 0.5m)	1

* SC-BIKN-EA only

Safety precautions

Before use, please read these Safety Precautions thoroughly before installation.

- All the cautionary items mentioned below are important safety related items to be taken into consideration, so be sure to observe them at all times.

Warning Incorrect installation could lead to serious consequences such as death, major injury or environmental destruction.

- Symbols used in these precautions

! Always go along these instruction.

- After completed installation, carry out trial operation to confirm no anomaly, and ask the user to keep this installation manual in a good place for future reference.

Warnings



- **Installation must be carried out by a qualified installer.**
If you install it by yourself, it may cause an electric shock, fire and personal injury, as a result of a system malfunction.
- **Install it in full accordance with the instruction manual.**
Incorrect installation may cause an electric shock, fire and personal injury.
- **Electrical work must be carried out by a qualified electrician in accordance with the technical standard for electrical equipment, the indoor wiring standard and this instruction manual.**
Incorrect installation may cause an electric shock, fire and personal injury.
- **Use the specific cables for wiring. And connect all the cables to terminals or connectors securely and clamp them with cable clamps in order for external forces not to be transmitted to the terminals directly.**
Incomplete connection may cause malfunction, and lead to heat generation and fire.
- **Use the original accessories and specified components for installation.**
If the parts other than those prescribed by us are used, it may cause an electric shock, fire and personal injury.

Connecting the indoor unit's connection cable to the interface

- ① Remove the upper case of the interface.
 - Remove 2 screws from the interface casing before removal of upper casing.
- ② Connect the indoor unit's connection cable to the interface.
 - Connect the connector of the indoor unit connection cable to the connector on the interface's circuit board.
- ③ Fix the indoor unit's connection cable with the cable clamp.
 - Cable can be brought in from the top or from the back.
 - Cut out the punch-outs for the connection cables running into the casing with cutter.
- ④ Connect the indoor unit's connection cable to the indoor control PCB.
 - Connect the indoor unit's connection cable to the indoor control PCB securely.
 - Clamp the connection cable to the indoor control box securely with the cable clamp provided as an accessory.
 - Regarding the cable connection to the indoor unit, refer to the instruction manual for indoor unit.

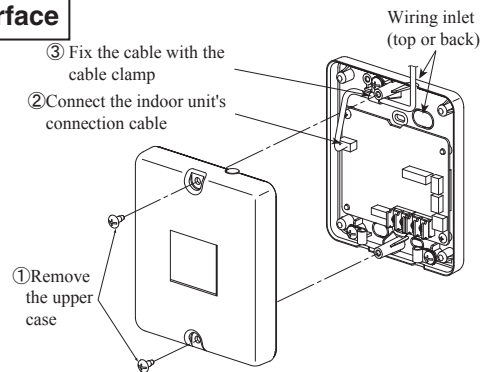

Name of each part of the interface

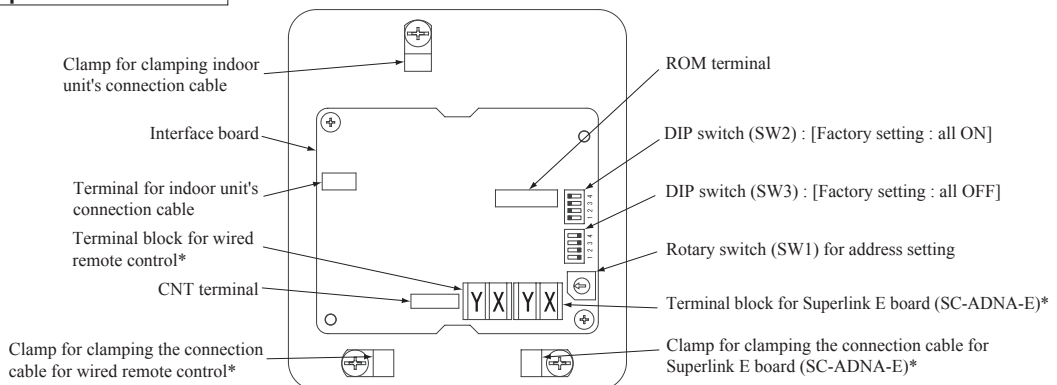

*Either the connection cables of Superlink E board (SC-ADNA-E) or of wired remote control is connectable.

Switch	Setting	Function	Switch	Setting	Function
SW2-1	ON**	CNT level input	SW2-3	ON**	External input (CNT input)
	OFF	CNT Pulse input		OFF	Operation permission/prohibition (CNT input)
SW2-2	ON**	Wired remote control : Enable	SW2-4	ON**	Annual cooling : Enable***
	OFF	Wired remote control : Disable		OFF	Annual cooling : Disable***

** Factory setting

*** Indoor fan control at low outdoor air temperature in cooling

Installation of the interface

- Install the interface within the range of the connection cable length (approximately 1.3m) from the indoor unit.
- Be sure not to extend the connection cable on site. If the connection cable is extended, malfunction may occur.
- Fix the interface on the wall, pillar or the like.

- DO NOT install the interface and wired remote control at the following places.
 - Places exposed to direct sunlight
 - Places near heating devices
 - High humidity places
 - Surfaces where are enough hot or cold to generate condensation
 - Places exposed to oil mist or steam directly
 - Uneven surface

Mounting the interface directly on a wall

- ① Mount the lower casing of the interface on a flat surface with wood screws provided as standard accessory.
- ② Mount the upper casing.

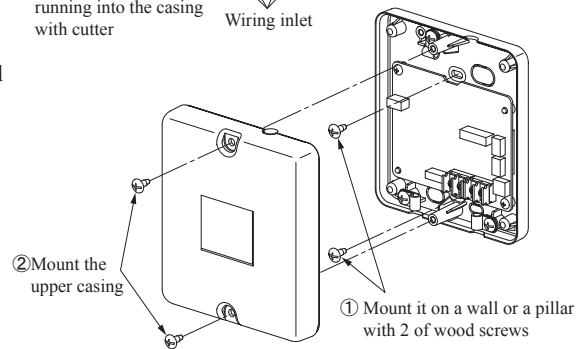
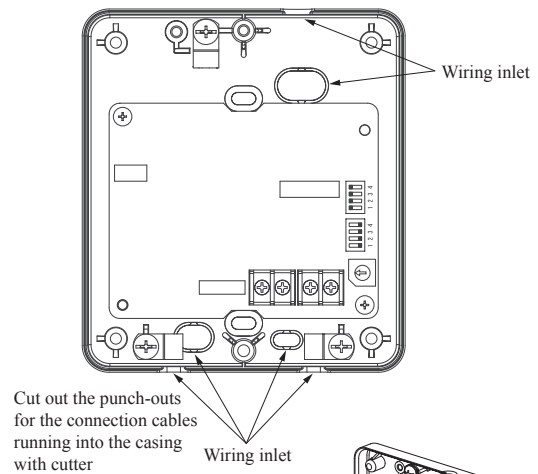

Recessing the interface in the wall

- ① Recess the electrical box (procured locally) and connection cables in the wall.
- ② Mount the lower casing of the interface to the electrical box with M4 screws (procured locally).
- ③ Mount the upper casing.

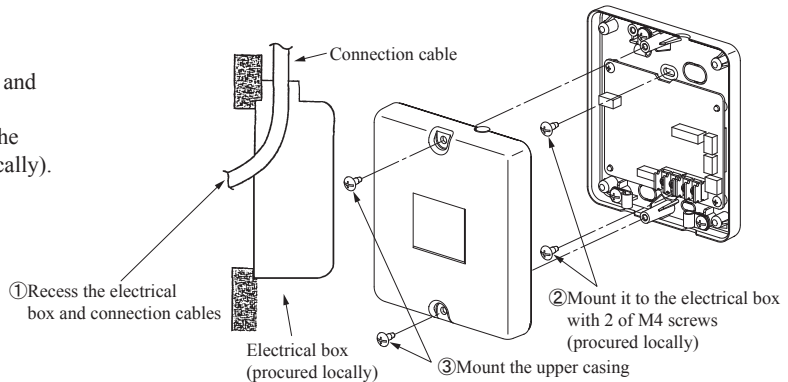

Mounting the interface with the mounting bracket

- ① Mount the mounting bracket to the interface with tapping screws provided as standard accessory.
- ② Mount the mounting bracket on wall or the like with wood screws provided as standard accessory.
- ③ Mount the mounting bracket to a wall surface, etc. using the wood screws provided.

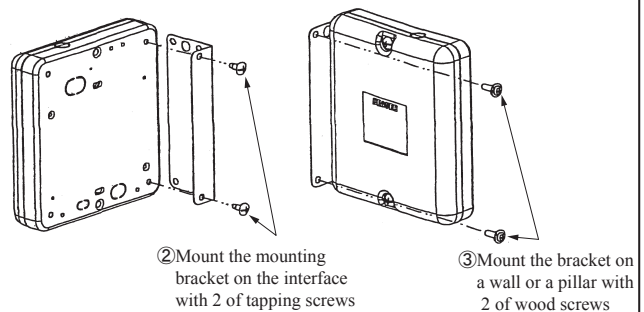

Installation check items

- Are the connection cables connected securely to the terminal blocks and connectors?
- Are the thickness and length of the connection cables conformed with the standard?

Functions of CNT connector

It is available to operate the air-conditioning unit and to monitor the operation status with the external control unit (remote display) by sending the input/output signal through CNT connector on the indoor control PCB.

- ① Connect an external remote control unit (procured locally) to CNT terminal.
- ② In case of the pulse input, switch OFF the DIP switch SW2-1 on the interface PCB.
- ③ When setting operation permission/prohibition mode, switch OFF the DIP switch SW2-3 on the interface PCB.

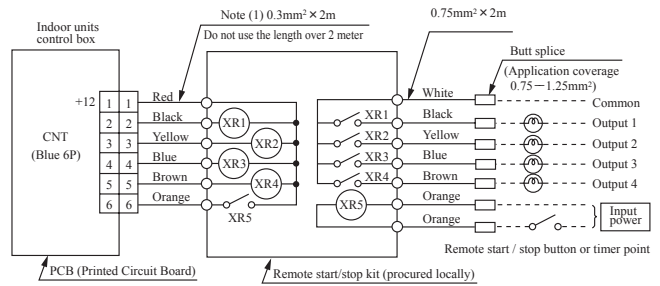

Input/Output	Function	Output signal		Content
		Relay	ON/OFF	
Output 1	Operation output	XR1	ON	During air-conditioner operation
Output 2	Heating output	XR2	ON	During heating operation
Output 3	Compressor operation output	XR3	ON	During compressor running
Output 4	Malfunction output	XR4	ON	During anomalous stop

- XR1-4 are for the DC 12V relay
- XR5 is a DC 12/24V or AC 220-240V relay
- CNT connector (local) maker, model

Connector	Molex	5264-06
Terminals	Molex	5263T

Input/Output	Function	SW2-1		SW2-3		Air-Conditioner	Operation by Remote Control		
		Setting		Input signal Level/Pulse	XR5			Content	
Input	External control input	ON*	Level input	ON*	Level	OFF→ON	External input	ON	Allowed
				ON→OFF		Operation permission	OFF		
		OFF	Pulse input	OFF→ON	Operation prohibition	OFF	Not allowed		
				ON→OFF	External input	OFF→ON		Allowed	
OFF	Level	OFF→ON	Operation permission	ON	Not allowed				
		ON→OFF	Operation prohibition	OFF					

* Factory setting

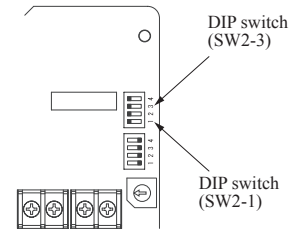

Connection of Superlink E board

Regarding the connection of Superlink E board, refer to the instruction manual of Superlink E board.

For electrical work, power source for all of units in the Superlink system must be turned OFF.

- ① Switch ON the DIP switch SW2-2 (Factory setting: ON) on the interface PCB.

Caution: Wireless remote control attached to the indoor unit can be used in parallel, after connecting the wired remote control. However, some of functions other than the basic functions such as RUN/STOP, Temperature Setting, etc. may not work properly and may have a mismatch between the display and the actual behavior.

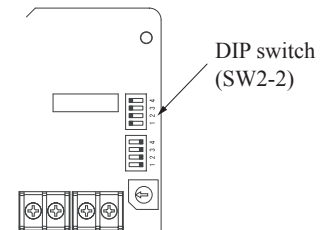

- ② Wiring connection between the interface and the Superlink E board.

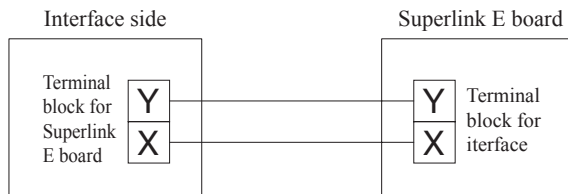

No.	Names of recommended signal wires
1	Shielded wire
2	Vinyl cabtyre round cord
3	Vinyl cabtyre round cable
4	Vinyl insulated wire/vinyl sheathed cable for control

Within 200 m 0.5 mm² × 2 cores
 Within 300 m 0.75 mm² × 2 cores
 Within 400 m 1.25 mm² × 2 cores
 Within 600 m 2.0 mm² × 2 cores

- ③ Clamp the connection cables with cable clamps.

Connection of wired remote control

Regarding the connection of wired remote control, refer to the instruction manual of wired remote control.

- ① Switch ON the DIP switch SW2-2 (Factory setting : ON) on the interface PCB.

Caution: Wireless remote control attached to the indoor unit can be used in parallel, after connecting the wired remote control. However, some of functions other than the basic functions such as RUN/STOP, Temperature Setting, etc. may not work properly and may have a mismatch between the display and the actual behavior.

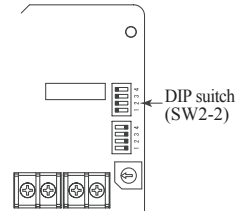

- ② Wiring connection between the interface and the wired remote control.

Installation and wiring of wired remote control

- Ⓐ Install the wired remote control with reference to the attached instruction manual of wired remote control.
- Ⓑ 0.3mm² × 2-core cable should be used for the wiring of wired remote control.
- Ⓒ Maximum length of wiring is 600m.
If the length of wiring exceeds 100m, change the size of cable as mentioned below.
100m-200m: 0.5mm² × 2-core, 300m or less: 0.75mm² × 2-core, 400m or less: 1.25mm² × 2-core, 600m or less: 2.0mm² × 2-core
However, cable size connecting to the terminal of wired remote control should not exceed 0.5mm². Accordingly if the size of connection cable exceeds 0.5mm², be sure to downsize it to 0.5mm² at the nearest section of the wired remote control and waterproof treatment should be done at the connecting section in order to avoid contact failure.
- Ⓓ Don't use the multi-core cable to avoid malfunction.
- Ⓔ Keep the wiring of wired remote control away from grounding (Don't touch it to any metal frame of building, etc.).
- Ⓕ Connect the connection cables to the terminal blocks of the wired remote control and the interface securely (no polarity).
- ③ Clamp the connection cables with cable clamps.

Control of multiple units by a single wired remote control

Multiple units (up to 16) can be controlled by a single wired remote control. In this case, all units connected with a single wired remote control will operate under the same mode and same setting temperature.

- ① Connect all the interface with 2-core cables of wired remote control line.
- ② Set the address of indoor unit for remote control communication from "0" to "F" with the rotary switch SW1 on the interface PCB.
- ③ After turning the power ON, the address of indoor unit can be displayed by pressing [AIR CON] button on the wired remote control.
Make sure all indoor units connected are displayed in order by pressing or button.

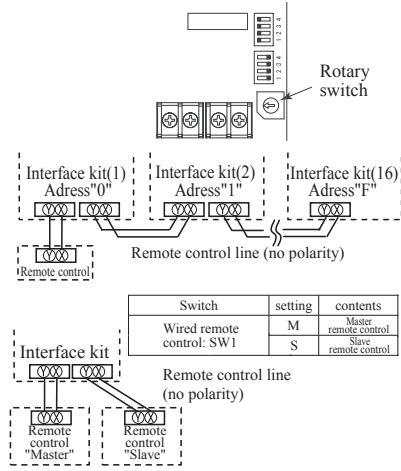

Master/Slave setting wired when 2 of wired remote control are used

- Maximum two wired remote control can be connected to one indoor unit (or one group of indoor units)
- ① Set the DIP switch SW1 on the wired remote control to "Slave" for the slave remote control. (Factory setting : Master)
○ Caution : Remote control sensor is invalid.

- When using the wireless remote control in parallel with the wired remote control; Since temperature setting range of wired remote control is different from that of wireless remote control, please adjust the setting range of wired remote control to be the same setting range of wireless remote control by following procedure. (The set temperature may not be displayed correctly on the wireless remote control, unless change of temperature setting range is done.)
Changing procedure of temperature setting range is as follows.

How to set upper and lower limit of temperature sting range

1. Stop the air-conditioner, and press (SET) and (MODE) button at the same time for 3 seconds or more.
The indication changes to "FUNCTION SET ▼"
2. Press button once, and change to the "TEMP RANGE ▲" indication.
3. Press (SET) button, and enter the temperature range setting mode.
4. Confirm that the "Upper limit ▼" is shown on the display.
5. Press (SET) button to fix.
6. ① Indication: " ∨ ∨ SET UP" → "UPPER 28°C ∨ ∨"
② Select the upper limit value 30°C with temperature setting button . "UPPER 30°C ∨"
(blinking)
③ Press (SET) button to fix. "UPPER 30°C" (Displayed for two seconds)
After the fixed upper limit value displayed for two seconds, the indication will return to "UPPER LIMIT ▼".
7. Press button once, "LOWER LIMIT ▲" is selected, press (SET) button to fix.
① Indication: " ∨ ∨ SET UP" → "LOWER 20°C ∨ ∨"
② Select the lower limit value 18°C with temperature setting button . "LOWER 18°C ∨"
(blinking)
③ Press (SET) button to fix. "LOWER 18°C" (Displayed for two seconds)
After the fixed lower limit value displayed for two seconds, the indication will return to "LOWER LIMIT ▼"
8. Press [ON/OFF] button to finish.
Temperature setting range

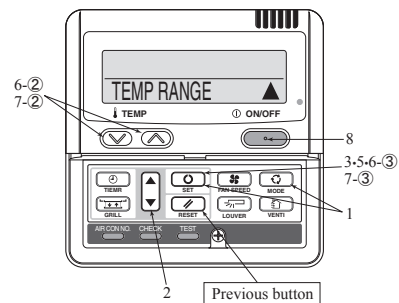

- It is possible to quit in the middle by pressing [ON/OFF] button, but the change of setting is incomplete.
- During setting, if pressing (RESET) button, it returns to the previous screen.

Mode	Temperature setting range
Cooling, Heating, Dry, Auto	18-30°C

13.5 Superlink E board (SC-ADNA-E)

PJZ012D029F

- Read and understand the instructions completely before starting installation.
- Refer to the instructions for both indoor and outdoor units.

Safety precautions

- Carefully read “Safety precautions” first. Follow the instructions for installation.
- Precautions are grouped into “Warning⚠” and “Caution⚠”. The “Warning⚠” group includes items that may lead to serious injury or death if not observed. The items included in the “Caution⚠” group also may lead to serious results under certain conditions. Both groups are crucial for safety installation. Read and understand them carefully.
- After installation, conduct the test operation of the device to check for any abnormalities. Describe how to operate the device to the customer following the installation instruction manual. Instruct the customer to keep this installation instruction for future reference.

⚠Warning

- This device should be installed by the dealer where you purchase the device or a licensed professional shop. If the device is incorrectly installed by the customer, it may result in electric shock or fire.
- Install the device carefully following the installation instruction. If the device is incorrectly installed, it may result in electric shock or fire.
- Use the accessory parts and specified parts for installation. If any parts that do not match the specifications are used, it may result in electric shock or fire.
- A person with the electrical service certification should conduct the service based on the “Technical standards for electrical facilities”, “Electrical Wiring Code”, and the installation instruction. If the work is done incorrectly, it may result in electric shock or fire.
- Wiring should be securely connected using the specified types of wire. No external force on the wire should be applied to any terminals. If a secure connection is not achieved, it may result in electric shock or fire.

⚠Caution

- Provide ground connection.
The ground line should never be connected to the gas supply piping, the water supply piping, the lightning conductor rod, nor the telephone ground. If the grounding is improper, it may result in electric shock.
- Do not install the device in the following locations.
 1. Where there is mist/spray of oil or steam such as kitchens.
 2. Where there is corrosive gases such as sulfuric acid gas.
 3. Where there is a device generating electromagnetic waves.
These may interfere with the control system resulting in the device becoming uncontrollable.
 4. Where flammable volatile materials such as paint thinner and gasoline may exist or where they are handled. This may cause a fire.

1 Application

Indoor-to-outdoor three core communication specification type 3 (since October 2007)

2 Accessories

SL E board	Metal box	Metal cover	Screw for Ground
			M4x8L 2 pieces
Pan head screws	Locking supports	Binding band	Grommet
φ4x8L 2 pieces	To secure the print board and the metal box Made of nylon 4 pieces		

5 Connection outline

Note for setting the address

- Set the address between 00 and 47 for the previous Superlink connection and between 000 and 127 for the new Superlink connection. (*1)
- Do not set the address overlapping with those of the other devices in the network. (The default is 000)

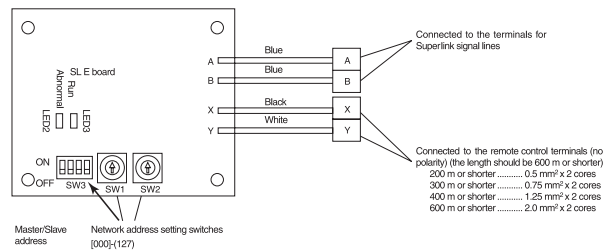

(*1) Whether the actual link is either the new Superlink or the previous Superlink depends on the models of the connected outdoor and indoor units. Consult the agent or the dealer.

3 Function

Allowing the center console SL1N-E, SL2N-E, and SL3N-AE/BE to control and monitor the commercial air conditioning unit.

4 Control switching

Settings can be changed by the switch SW3 on the SL E board as in the following.

Switch	Symbol	Switch	Remarks
SW3	1	ON	Master
		OFF (default)	Slave
	2	ON	Fixed previous protocol
		OFF (default)	Automatic adjustment of Superlink protocol
	3	ON	Indicates the forced operation stop when abnormality has occurred.
		OFF (default)	Indicates the status of running/stop as it is, when abnormality has occurred.
	4	ON	The hundredth address activated "1"
		OFF (default)	The hundredth address activated "0"

Signal line specification

Communication method	Previous Superlink	New Superlink
Line type	MVVS	MVVS
Line diameter	0.75 - 1.25mm ²	0.75/1.25mm ²
Signal line (total length)	up to 1000m	up to 1500/1000m (*2)
Signal line (maximum length)	up to 1000m	up to 1000m

(*2) Up to 1500 m for 0.75 mm², and up to 1000 m for 1.25 mm².

Do not use 2.0 mm². It may cause an error.

(*3) Connect grounding on both ends of the shielding wire.

For the grounding method, refer to the section “6 Installation”.

- (1) Set the Superlink network address with SW1 (tens place), SW2 (ones place), and SW3 (hundreds place).
- (2) Set the SL E board SW3-1 to be ON (Master) when using this without any remote control (no wired remote control nor wireless remote control).
- (3) Set up the plural master/slave device using the dip switches on the indoor unit board.
- (4) Set up the remote control master/slave device using the slide switch on the remote control board.
- (5) Set up "0" to "F" using the address rotary switch on the indoor unit board when controlling the indoor unit with the multiple remote control.

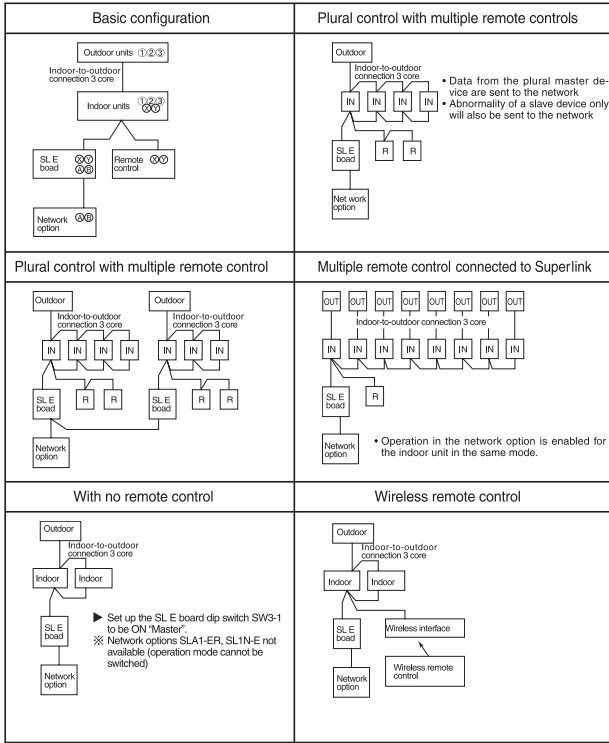

Connect grounding. Connect grounding for the power line to Ground ①, and grounding for the signal line to Ground ② or to the Ground on the indoor unit control box.

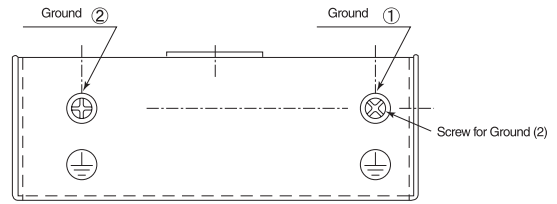

2. When connecting to the indoor unit control box (ceiling-concealed type and FDT type only):

- (1) Mount the SL E board in the control box using the locking supports.
- (2) Remove 6 bands from the box and put the wiring through the bands to be secured.

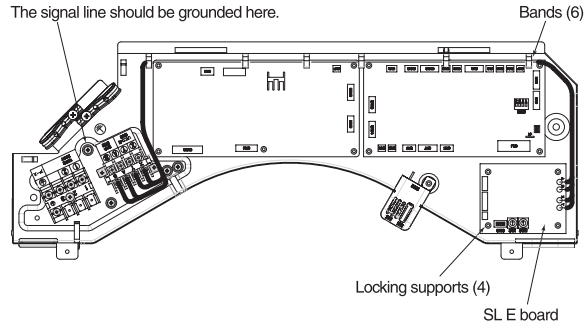

Electrical shock hazard! Make sure to turn the power off for servicing. Be cautious so that no abnormal force should be applied to the wiring. Do not damage the board with a screw driver.

The board is sensitive to static electricity. Release the static electricity of your body before servicing.
(you can do this by touching the control board which is grounded).

Location of installation

Install the device at the location where there are no electromagnetic waves nor where there is water and dust. The specified temperature range of the device is 0 to 40°C. Install the device at the location where the ambient temperature stays within the range. If it exceeds the specification, make sure to provide solution such as installing a cooling fan. When used outside of the range, it may cause abnormal operation.

6 Installation

1. When using the metal box (mounted on the indoor unit / mounted on the back of the remote control):

- (1) Mount the SL E board in the metal box using the locking supports.
- (2) Wiring should go through the provided grommet since then through the wiring to the hole on the Metal box.

Secure the grommet after inserting the grommet into the Metal box as shown in below figure, then tie the wiring at the outlet of the unit using a binding band.

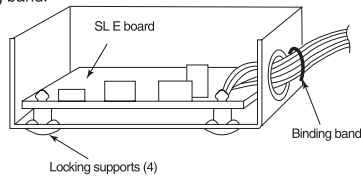

▲ When installed outside the indoor unit, put the metal cover on.

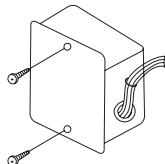

▲ When installed on the back of the remote control, mount it directly on the remote control bottom case.

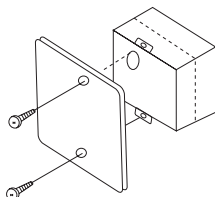

7 Indicator display

Check the LED 3 (green) and LED 2 (red) on the SL E board for flashing.

SL E board LEDs		Inspection mode	Display on the integrated network control device
Red	Green		
Off	Keeps flashing	Normal communication	
Off	Off	<ul style="list-style-type: none"> • Disconnection in the remote control communication line (X or Y) • Short-circuit in the remote control communication line (between X and Y) • Faulty indoor unit remote control power • Faulty remote control communication circuit • Faulty CPU on SL E board 	
1-time flash	Keeps flashing	<ul style="list-style-type: none"> • Disconnection in the Superlink signal line (A or B) • Short-circuit in the Superlink signal line (between A and B) • Faulty Superlink signal circuit 	No corresponding unit number
2-time flash	Keeps flashing	<ul style="list-style-type: none"> • Faulty address setting for the SL E board (Set up the address for previous SL E board : more than 48 new SL E board : more than 128) 	
3-time flash	Keeps flashing	<ul style="list-style-type: none"> • SL E board parent not set up when used without a remote control • Faulty remote control communication circuit 	E1
4-time flash	Keeps flashing	<ul style="list-style-type: none"> • Address overlapping for the SL E board and the Superlink network connected indoor unit 	E2
Off	Keeps flashing	<ul style="list-style-type: none"> • Number of connected devices exceeds the specification for the multiple indoor unit control 	E10

13.6 Base heater kit (CW-H-E1)

PCZ012D007B

⚠ WARNING

- Follow the instruction and installation manual for outdoor unit when installing the heater.
- This heater must be installed by authorized personnel.
- Turn off the power source when the kit is installed.
- Failure to follow the above will result in serious accident like electrical shock or fire.

⚠ CAUTION

- Follow the law or regulation of the country where it is installed.
- Do not alter the heater.
- Lay down the heater so that the edge of the sheet metal does not damage the heater.
- Bending radius must be bigger than 25mm.
- Do not use the heater near flammable substances.
- Be sure to check the electrical insulation before use.
- Be sure to check the drain is not trapped by the heater.
- Do not leave refrigerant oil on the base.

AREAS TO BE APPLIED

This kit is to be used in an area where the lowest temperature drops below zero.

⚠ Caution: In case the heater is not applied on the unit which is installed in an area mentioned above, it may be regarded as installation failure and warranty may not be given.

Components

- Heater : 1pc
- Bracket A : 4pcs
- Bracket B : 1pcs
- Bracket C : 1pcs
- Tapping screw (OD5) : 4pcs
- Tapping screw (OD4) : 4pcs
- Plastic band with clip ① : 2pcs
- Plastic band : 5pcs

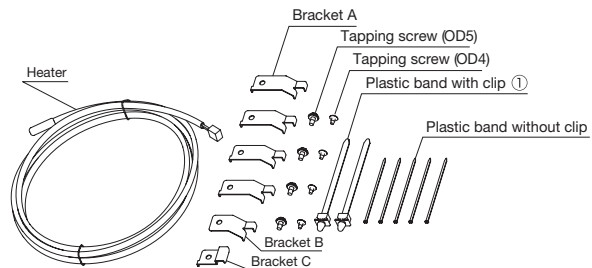

Applicable model

This heater kit is applicable for 3 different models.

<Model A>

Single fan with plastic fan guard model

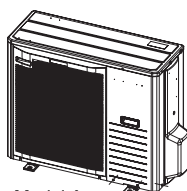

Model A

<Model B>

Single fan model (Without FDC 100VNP)
(Refer to page 7-8 for FDC 100VNP <Model D>)

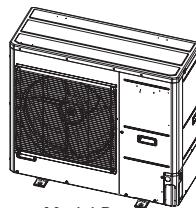

Model B

<Model C>

Double fan model

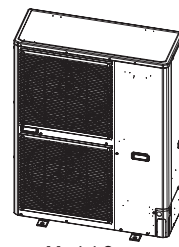

Model C

Installation procedure

Step 1

1. Remove the top panel of the outdoor unit

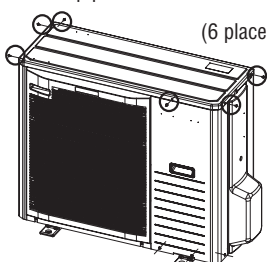

Model A

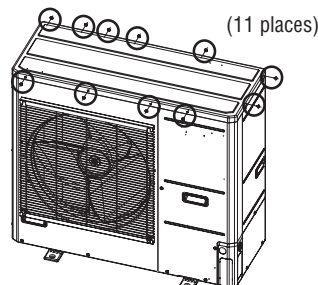

Model B

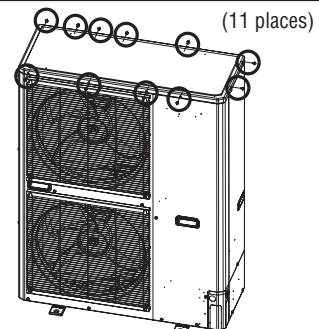

Model C

Step 2 2. Remove the service panel

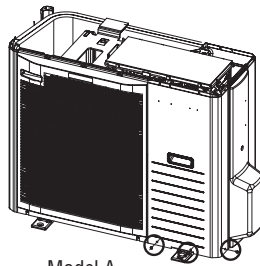

Model A

(3 places)

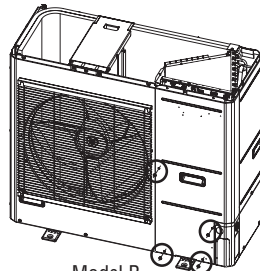

Model B

(4 places)

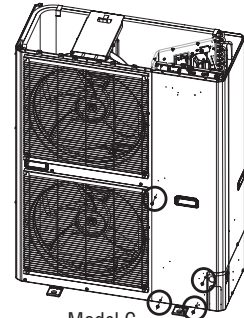

Model C

(4 places)

Step 3 3. Remove the front panel

Pull the panel straightforward so that the panel doesn't touch the fan blade.

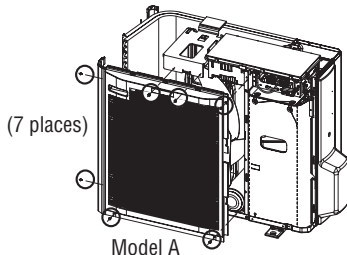

(7 places)

Model A

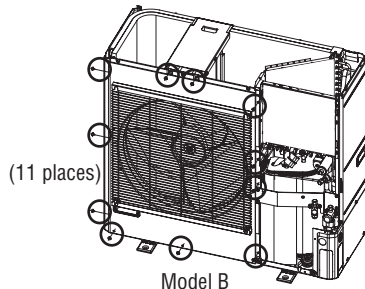

(11 places)

Model B

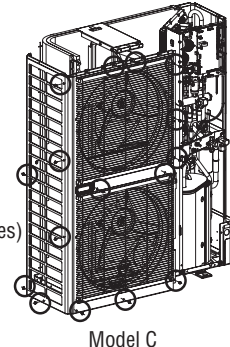

(16 places)

Model C

Step 4 4. Remove the fan blade if necessary. **<Note>**

Do not rotate the axis of fan motor when removing the fan blade. It may cause malfunction of the fan motor.

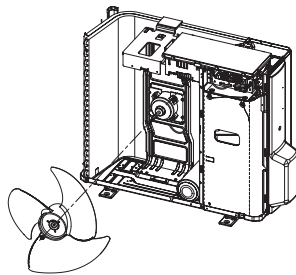

Model A

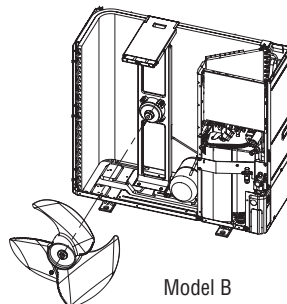

Model B

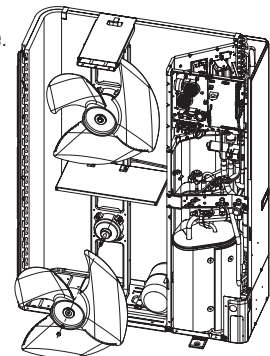

Model C

Step 5 5. Lay down the drain pan heater on the base.

For model A, put the cables rear the fan motor bracket.

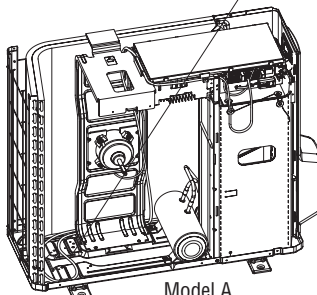
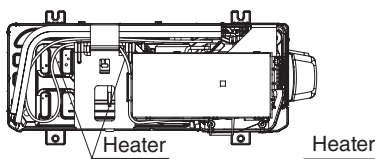

Model A

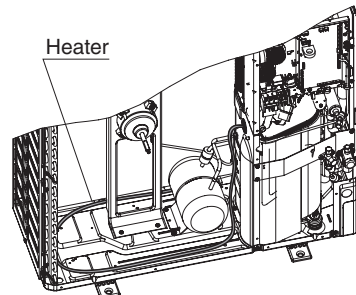

Model B, C

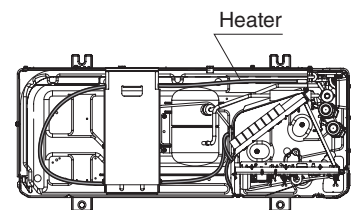

Step 6

6. Put the heater underneath the heat exchanger and align the end of heater with the end plate of heat exchanger.

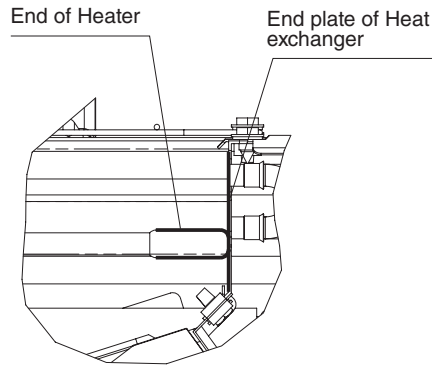

Step 7

7. Fix the heater with brackets.

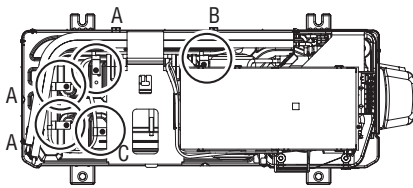

For model A, use 3 pcs of bracket A, 1pc of bracket B and C. Fix bracket A and C with the attached screw (OD4), and fix bracket B with the removed screw which is fastened at the same place.

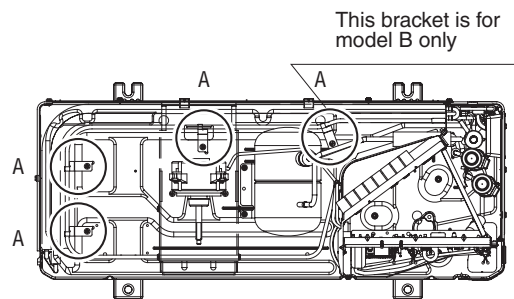

For model B and C, fix bracket A with the attached screw (OD5).

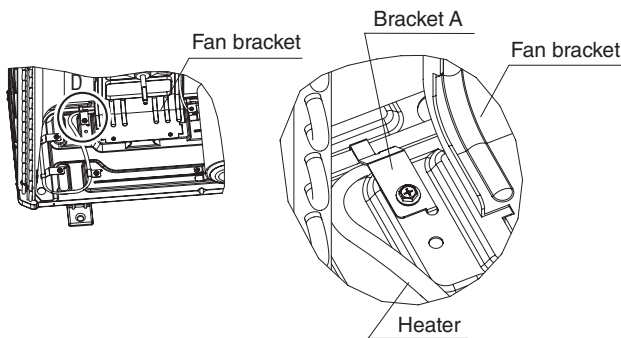

Model A

Detail view D

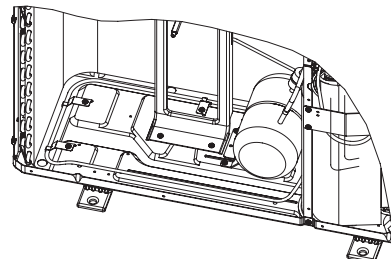

Model B, C

<Note for model A>

- 1) Put the end of heating part just after the bracket C
- 2) Fix the incoming and out going cable with one bracket A on the left of fan bracket as figure shows.

<Note>

- 1) Fix the heater so that the bracket doesn't pinch the heater as figure shows.
- 2) Place the heater so as to touch the base completely.
- 3) In bending position, twist the heater to make it easier to bend, and get back to be able to fix it with bracket.
- 4) Be careful not to be injured by aluminum fin when fixing the heater with screw.

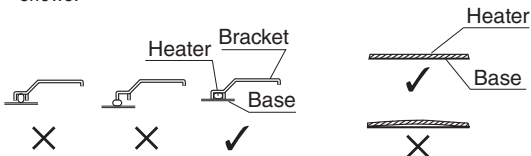

Step 8

8. Insert the plastic band with clip on the designated place (2 places), and fix the heater. (Model B,C only)

<Note>

1) Do not fasten the heating part with the plastic band.
There is a marking on the end of heating part.

2) When the heater is laid down correctly, the end of heating part comes to the corner of the base.

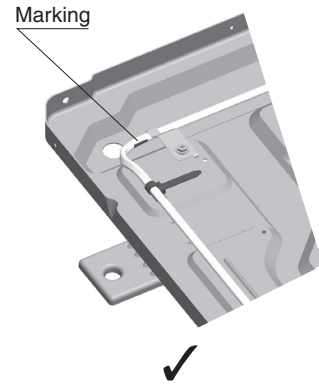
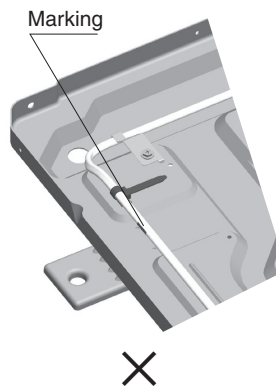
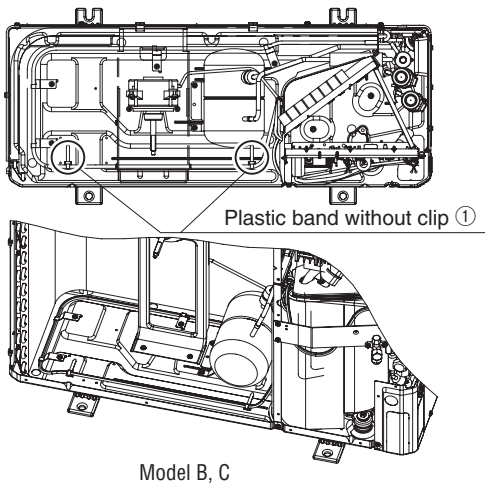

Step 9

9. Lay down the wiring on the same route of fan motor wiring, and fix the wire with attached plastic band at the same place where the fan motor wiring is banded.

Model A

Model B

Model C

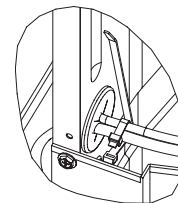
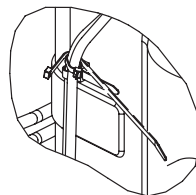
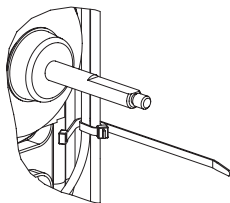
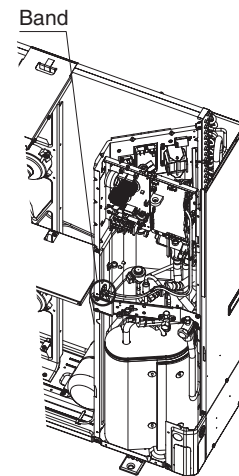
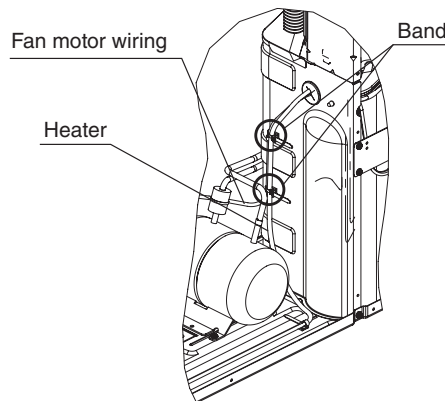
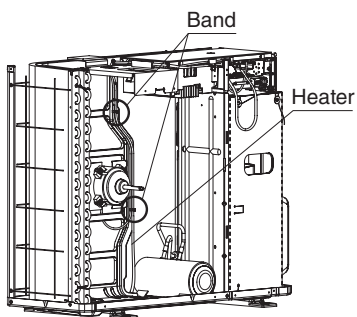

<Note>

Fan motor wiring is banded on the bracket so that it doesn't loosen.
Do not loose the band for the motor wiring to band the heater wire together but use the attached plastic band.

Step 10

10. Insert the connector to the port (Model A:CNN, Model B,C:CNF) on the PCB, and fix the wire with bands. Excess part of the wire should be dropped naturally.

<Note>

Be sure to cut the excess part of plastic band. It may cause abnormal noise when hit by fan blade or misassembling of panels. Do not bundle excess part of the wire. It may damage the heater.

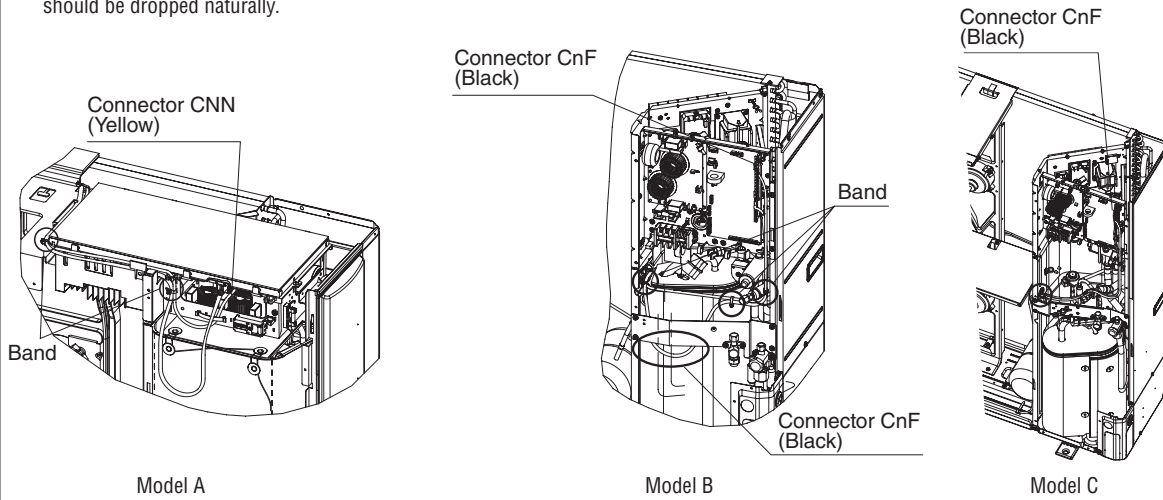

Step 11

11. Reassemble the fan blade.

Take care to align the D-cut of motor shaft and the fan blade. ▽ mark on the center of the fan shows the position of D-cut.

<Note>

1. Tightening torque of the nut is 4.0-4.9 N·m.
2. Do not rotate the axis of fan motor when tightening the nut. It may cause malfunction of the fan motor.

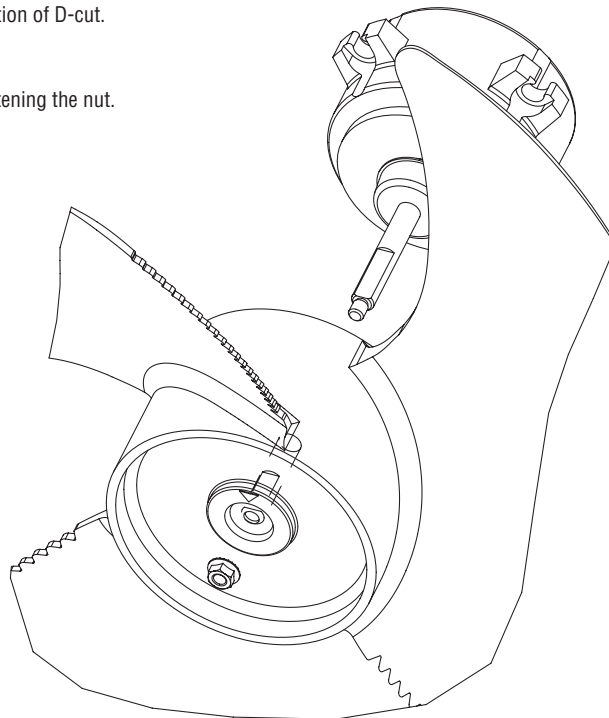

<Note>

- This heater should have bending radius of at least 25mm including non-heating part. Do not bundle the excess part of the wire. It may cause disconnection of the heater or insufficient capacity.
- Be sure to prevent the heater from touching any refrigerant piping. Especially, pay close attention not to make it touch with pipes which are close to the wiring route such as suction pipe, check valve and check joint.

Step 12

12. Reassemble the panels.

[Model A]

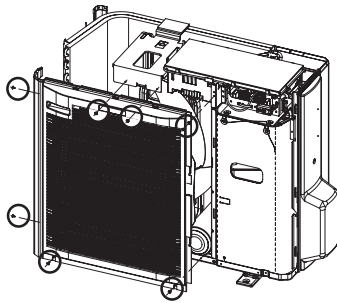

Front panel

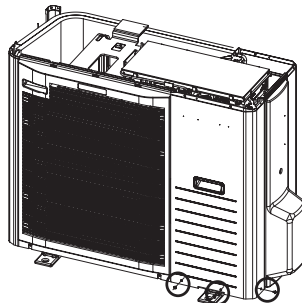

Service panel

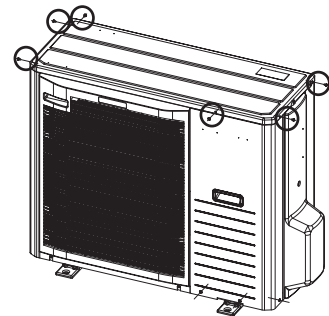

Top panel

[Model B]

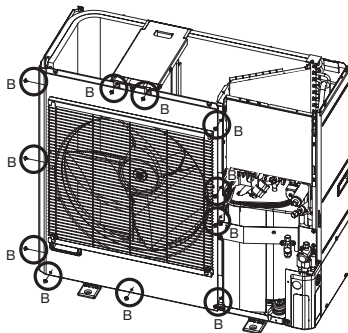

Front panel

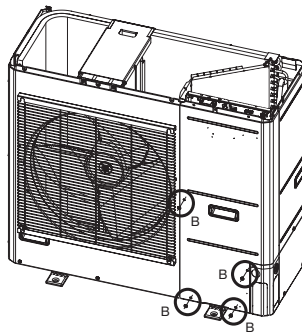

Service panel

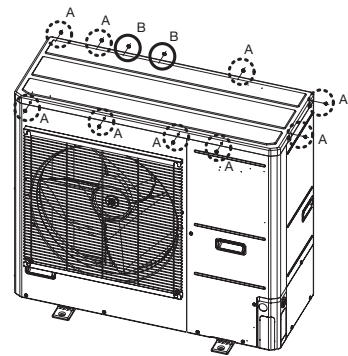

Top panel

[Model C]

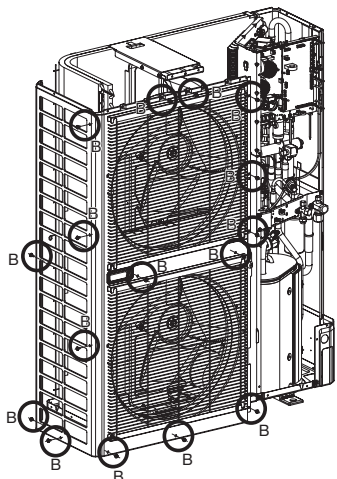

Front panel

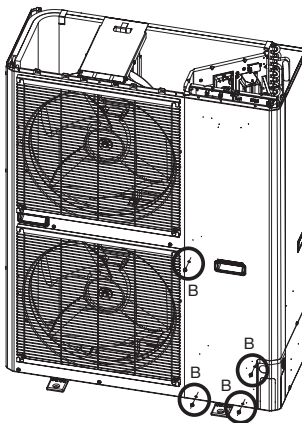

Service panel

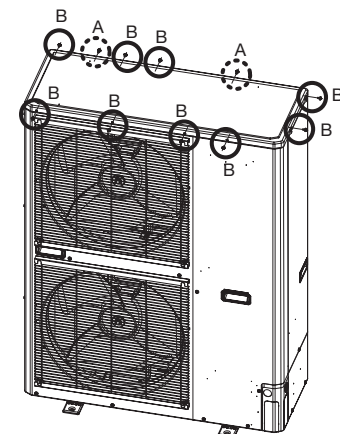

Top panel

<Note>

- 1) When reassembling the service panel, take care not to damage the front panel with the edge.
- 2) Top panel of model B and model C is fixed with two different screws.
Be sure to use correct screw as figure shows.



A



B

Applicable model

Model name : FDC100VNP
 <Model D>
 Single fan model

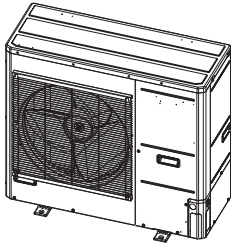

Components

- Heater : 1pc
- Bracket A : 4pcs
- Bracket B : 1pcs (※1)
- Bracket C : 1pcs (※1)
- Tapping screw (OD5) : 4pcs
- Tapping screw (OD4) : 4pcs
- Plastic band with clip ① : 2pcs
- Plastic band with clip ② : 2pcs (※2)
- Plastic band : 5pcs

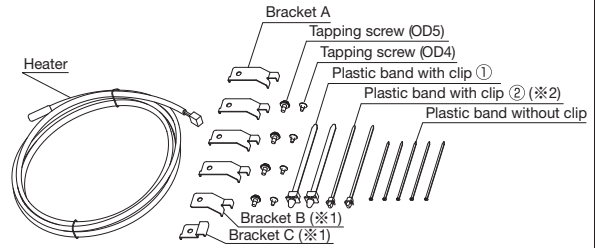

※1 This part is not used for FDC 100VNP
 ※2 These parts are equipped with FDC 100VNP as accessory part

Installation procedure

Step 1

1. Remove the top panel of the outdoor unit (11 pcs of tapping screws).

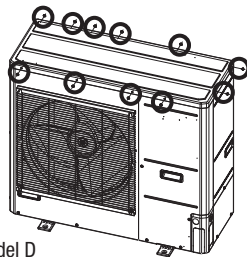

Model D

Step 2

2. Remove the service panel (4 pcs of tapping screws).

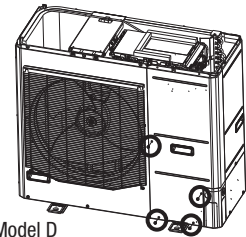

Model D

Step 3

3. Remove the front panel (11 pcs of tapping screws). Pull the panel straightforward so that the panel doesn't touch the fan blade.

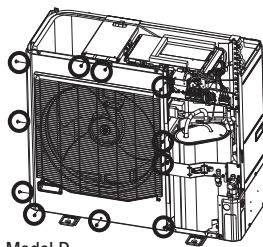

Model D

Step 4

4. Remove the fan blade if necessary.

<Note>

Do not rotate the axis of fan motor when removing the fan blade. It may cause malfunction of the fan motor.

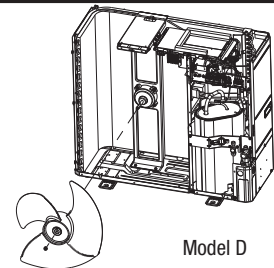

Model D

Step 5

5. Lay down the drain pan heater on the base.

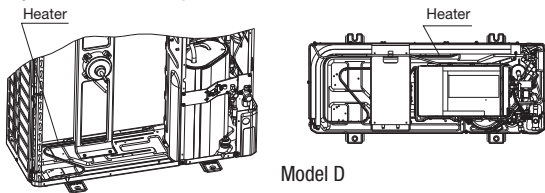

Model D

Step 6

6. Put the heater underneath the heat exchanger and align the end of heater with the end plate of heat exchanger.

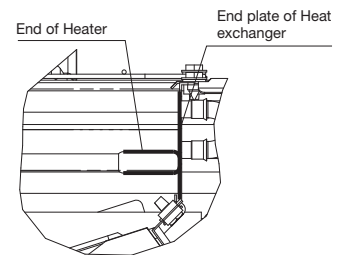

Step 7

7. Fix the heater with 4 brackets.

<Note>

- 1) Fix the heater so that the bracket doesn't pinch the heater as figure shows.
- 2) Place the heater so as to touch the base completely.
- 3) In bending position, twist the heater to make it easier to bend, and get back to be able to fix it with bracket.
- 4) Be careful not to be injured by aluminum fin when fixing the heater with screw.

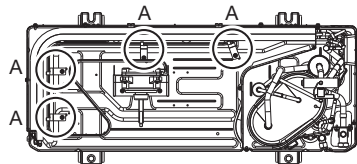

Model D

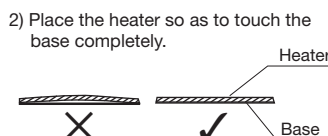
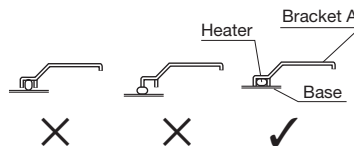

Step 8

8. Insert the plastic band with clip on the designated place (3 places), and fix the heater.

<Note>

1) Do not fasten the heating part with the plastic band. There is a marking on the end of heating part.

2) When the heater is laid down correctly, the end of heating part comes to the corner of the base.

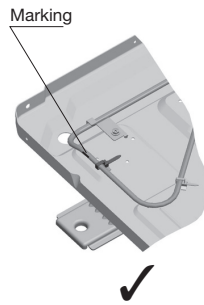
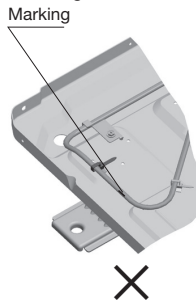
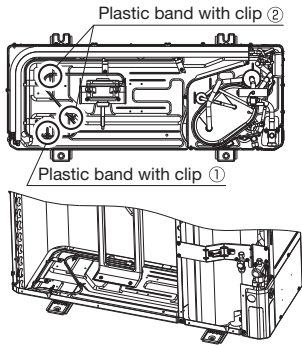

Model D

Step 9

9. Lay down the wiring on the same route of fan motor wiring.

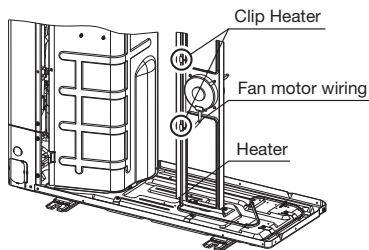

Model D

Step 10

10. Insert the connector to the port CnF (White).

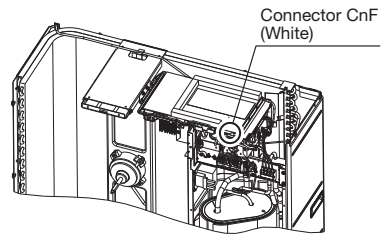

Model D

Step 11

11. Reassemble the fan blade.

Take care to align the D-cut of motor shaft and the fan blade. ▽ mark on the center of the fan shows the position of D-cut.

<Note>

1. Tightening torque of the nut is 4.0-4.9 N·m.
2. Do not rotate the axis of fan motor when tightening the nut. It may cause malfunction of the fan motor.

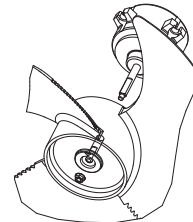

Step 12

12. Reassemble the panels.

1) Front panel

Use screw B for all places.

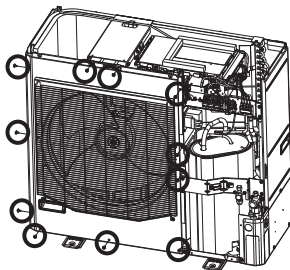

Model D

2) Service panel

Use screw B for all places.

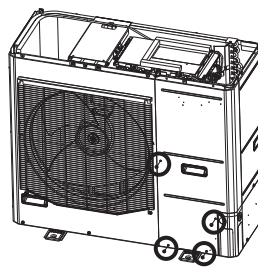

3) Top panel

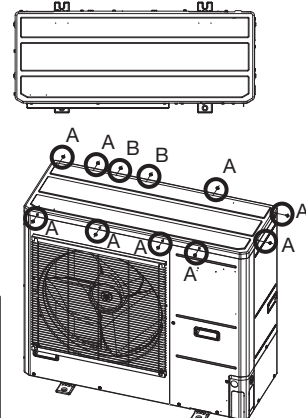

<Note>

- 1) When reassembling the service panel, take care not to damage the front panel with the edge.
- 2) There are two different length of screws. Be sure to use correct screw.
Long screw A: used for Top panel other than fixing fan bracket.
Short screw B: other place than A.



<Note>

- This heater should have bending radius of at least 25mm including non-heating part. Do not bundle the excess part of the wire. It may cause disconnection of the heater or insufficient capacity.
- Be sure to prevent the heater from touching any refrigerant piping. Especially, pay close attention not to make it touch with pipes which are close to the wiring route such as suction pipe, check valve and check joint.

14. TECHNICAL INFORMATION

(1) Ceiling cassette-4way type (FDT)

Information to identify the model(s) to which the information relates to:				If function includes heating: Indicate the heating season the information relates to. Indicated values should relate to one heating season at a time. Include at least the heating season 'Average'.			
Indoor unit model name		FDT100VF2		Average(mandatory)		Yes	
Outdoor unit model name		FDC100VNP		Warmer(if designated)		No	
Function(indicate if present)				Colder(if designated)			
cooling		Yes					
heating		Yes					
Item	symbol	value	unit	Item	symbol	value	class
Design load				Seasonal efficiency and energy efficiency class			
cooling	Pdesignc	10.0	kW	cooling	SEER	6.78	A++
heating / Average	Pdesignh	8.1	kW	heating / Average	SCOP/A	4.52	A+
heating / Warmer	Pdesignh	-	kW	heating / Warmer	SCOP/W	-	-
heating / Colder	Pdesignh	-	kW	heating / Colder	SCOP/C	-	-
				unit			
Declared capacity at outdoor temperature Tdesignh				Back up heating capacity at outdoor temperature Tdesignh			
heating / Average (-10°C)	Pdh	8.10	kW	heating / Average (-10°C)	elbu	0	kW
heating / Warmer (2°C)	Pdh	-	kW	heating / Warmer (2°C)	elbu	-	kW
heating / Colder (-22°C)	Pdh	-	kW	heating / Colder (-22°C)	elbu	-	kW
Declared capacity for cooling, at indoor temperature 27(19)°C and outdoor temperature Tj				Declared energy efficiency ratio, at indoor temperature 27(19)°C and outdoor temperature Tj			
Tj=35°C	Pdc	10.00	kW	Tj=35°C	EERd	3.62	-
Tj=30°C	Pdc	7.37	kW	Tj=30°C	EERd	5.30	-
Tj=25°C	Pdc	4.80	kW	Tj=25°C	EERd	8.28	-
Tj=20°C	Pdc	3.50	kW	Tj=20°C	EERd	12.07	-
Declared capacity for heating / Average season, at indoor temperature 20°C and outdoor temperature Tj				Declared coefficient of performance / Average season, at indoor temperature 20°C and outdoor temperature Tj			
Tj=-7°C	Pdh	7.10	kW	Tj=-7°C	COPd	2.96	-
Tj=2°C	Pdh	4.24	kW	Tj=2°C	COPd	4.46	-
Tj=7°C	Pdh	2.80	kW	Tj=7°C	COPd	5.83	-
Tj=12°C	Pdh	2.85	kW	Tj=12°C	COPd	6.95	-
Tj=bivalent temperature	Pdh	8.10	kW	Tj=bivalent temperature	COPd	2.66	-
Tj=operating limit	Pdh	7.15	kW	Tj=operating limit	COPd	2.50	-
Declared capacity for heating / Warmer season, at indoor temperature 20°C and outdoor temperature Tj				Declared coefficient of performance / Warmer season, at indoor temperature 20°C and outdoor temperature Tj			
Tj=2°C	Pdh	-	kW	Tj=2°C	COPd	-	-
Tj=7°C	Pdh	-	kW	Tj=7°C	COPd	-	-
Tj=12°C	Pdh	-	kW	Tj=12°C	COPd	-	-
Tj=bivalent temperature	Pdh	-	kW	Tj=bivalent temperature	COPd	-	-
Tj=operating limit	Pdh	-	kW	Tj=operating limit	COPd	-	-
Declared capacity for heating / Colder season, at indoor temperature 20°C and outdoor temperature Tj				Declared coefficient of performance / Colder season, at indoor temperature 20°C and outdoor temperature Tj			
Tj=-7°C	Pdh	-	kW	Tj=-7°C	COPd	-	-
Tj=2°C	Pdh	-	kW	Tj=2°C	COPd	-	-
Tj=7°C	Pdh	-	kW	Tj=7°C	COPd	-	-
Tj=12°C	Pdh	-	kW	Tj=12°C	COPd	-	-
Tj=bivalent temperature	Pdh	-	kW	Tj=bivalent temperature	COPd	-	-
Tj=operating limit	Pdh	-	kW	Tj=operating limit	COPd	-	-
Tj=-15°C	Pdh	-	kW	Tj=-15°C	COPd	-	-
Bivalent temperature				Operating limit temperature			
heating / Average	Tbiv	-10	°C	heating / Average	Tol	-15	°C
heating / Warmer	Tbiv	-	°C	heating / Warmer	Tol	-	°C
heating / Colder	Tbiv	-	°C	heating / Colder	Tol	-	°C
Cycling interval capacity				Cycling interval efficiency			
for cooling	Pcycc	-	kW	for cooling	EERcyc	-	-
for heating	Pcyhc	-	kW	for heating	COPcyc	-	-
Degradation coefficient				Degradation coefficient			
cooling	Cdc	0.25	-	heating	Cdh	0.25	-
Electric power input in power modes other than 'active mode'				Annual electricity consumption			
off mode	Poff	10	W	cooling	Qce	516	kWh/a
standby mode	Psb	10	W	heating / Average	Qhe	2507	kWh/a
thermostat-off mode	Pto	35	W	heating / Warmer	Qhe	-	kWh/a
crankcase heater mode	Pck	0	W	heating / colder	Qhe	-	kWh/a
Capacity control(indicate one of three options)				Other items			
fixed		No		Sound power level(indoor)	Lwa	65	dB(A)
staged		No		Sound power level(outdoor)	Lwa	70	dB(A)
variable		Yes		Global warming potential	GWP	1975	kgCO2eq.
				Rated air flow(indoor)	-	2220	m3/h
				Rated air flow(outdoor)	-	4500	m3/h
Contact details for obtaining more information		Name and address of the manufacturer or of its authorised representative.					
		Mitsubishi Heavy Industries Air-Conditioning Europe, Ltd. 7 Roundwood Avenue, Stockley Park, Uxbridge, Middlesex, UB11 1AX, United Kingdom					

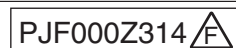

(2) Ceiling suspended type (FDE)

Information to identify the model(s) to which the information relates to:				If function includes heating: Indicate the heating season the information relates to. Indicated values should relate to one heating season at a time. Include at least the heating season 'Average'.			
Indoor unit model name		FDE100VG		Average(mandatory)		Yes	
Outdoor unit model name		FDC100VNP		Warmer(if designated)		No	
Function(indicate if present)				Colder(if designated)			
cooling		Yes					
heating		Yes					
Item	symbol	value	unit	Item	symbol	value	class
Design load				Seasonal efficiency and energy efficiency class			
cooling	Pdesignc	10.0	kW	cooling	SEER	6.73	A++
heating / Average	Pdesignh	8.1	kW	heating / Average	SCOP/A	4.44	A+
heating / Warmer	Pdesignh	-	kW	heating / Warmer	SCOP/W	-	-
heating / Colder	Pdesignh	-	kW	heating / Colder	SCOP/C	-	-
				unit			
Declared capacity at outdoor temperature Tdesignh				Back up heating capacity at outdoor temperature Tdesignh			
heating / Average (-10°C)		Pd _h 8.1 kW		heating / Average (-10°C)		elbu 0 kW	
heating / Warmer (2°C)		Pd _h - kW		heating / Warmer (2°C)		elbu - kW	
heating / Colder (-22°C)		Pd _h - kW		heating / Colder (-22°C)		elbu - kW	
Declared capacity for cooling, at indoor temperature 27(19)°C and outdoor temperature Tj				Declared energy efficiency ratio, at indoor temperature 27(19)°C and outdoor temperature Tj			
Tj=35°C		Pdc 10.00 kW		Tj=35°C		EERd 3.76 -	
Tj=30°C		Pdc 7.37 kW		Tj=30°C		EERd 5.30 -	
Tj=25°C		Pdc 4.80 kW		Tj=25°C		EERd 8.14 -	
Tj=20°C		Pdc 3.50 kW		Tj=20°C		EERd 11.67 -	
Declared capacity for heating / Average season, at indoor temperature 20°C and outdoor temperature Tj				Declared coefficient of performance / Average season, at indoor temperature 20°C and outdoor temperature Tj			
Tj=-7°C		Pd _h 7.20 kW		Tj=-7°C		COPd 2.58 -	
Tj=2°C		Pd _h 4.40 kW		Tj=2°C		COPd 4.44 -	
Tj=7°C		Pd _h 2.80 kW		Tj=7°C		COPd 5.96 -	
Tj=12°C		Pd _h 2.90 kW		Tj=12°C		COPd 7.07 -	
Tj=bivalent temperature		Pd _h 8.10 kW		Tj=bivalent temperature		COPd 2.71 -	
Tj=operating limit		Pd _h 7.17 kW		Tj=operating limit		COPd 2.56 -	
Declared capacity for heating / Warmer season, at indoor temperature 20°C and outdoor temperature Tj				Declared coefficient of performance / Warmer season, at indoor temperature 20°C and outdoor temperature Tj			
Tj=2°C		Pd _h - kW		Tj=2°C		COPd - -	
Tj=7°C		Pd _h - kW		Tj=7°C		COPd - -	
Tj=12°C		Pd _h - kW		Tj=12°C		COPd - -	
Tj=bivalent temperature		Pd _h - kW		Tj=bivalent temperature		COPd - -	
Tj=operating limit		Pd _h - kW		Tj=operating limit		COPd - -	
Declared capacity for heating / Colder season, at indoor temperature 20°C and outdoor temperature Tj				Declared coefficient of performance / Colder season, at indoor temperature 20°C and outdoor temperature Tj			
Tj=-7°C		Pd _h - kW		Tj=-7°C		COPd - -	
Tj=2°C		Pd _h - kW		Tj=2°C		COPd - -	
Tj=7°C		Pd _h - kW		Tj=7°C		COPd - -	
Tj=12°C		Pd _h - kW		Tj=12°C		COPd - -	
Tj=bivalent temperature		Pd _h - kW		Tj=bivalent temperature		COPd - -	
Tj=operating limit		Pd _h - kW		Tj=operating limit		COPd - -	
Tj=-15°C		Pd _h - kW		Tj=-15°C		COPd - -	
Bivalent temperature				Operating limit temperature			
heating / Average		Tbiv -10 °C		heating / Average		Tol -15 °C	
heating / Warmer		Tbiv - °C		heating / Warmer		Tol - °C	
heating / Colder		Tbiv - °C		heating / Colder		Tol - °C	
Cycling interval capacity				Cycling interval efficiency			
for cooling		Pcyc _c - kW		for cooling		EER _{cyc} - -	
for heating		Pcyc _h - kW		for heating		COP _{cyc} - -	
Degradation coefficient				Degradation coefficient			
cooling		Cdc 0.25 -		heating		Cdh 0.25 -	
Electric power input in power modes other than 'active mode'				Annual electricity consumption			
off mode		Poff 10 W		cooling		Qce 521 kWh/a	
standby mode		Psb 10 W		heating / Average		Qhe 2556 kWh/a	
thermostat-off mode		Pto 36 W		heating / Warmer		Qhe - kWh/a	
crankcase heater mode		Pck 0 W		heating / colder		Qhe - kWh/a	
Capacity control(indicate one of three options)				Other items			
fixed		No		Sound power level(indoor)		Lwa 64 dB(A)	
staged		No		Sound power level(outdoor)		Lwa 70 dB(A)	
variable		Yes		Global warming potential		GWP 1975 kgCO ₂ eq.	
				Rated air flow(indoor)		- 1920 m ³ /h	
				Rated air flow(outdoor)		- 4500 m ³ /h	
Contact details for obtaining more information		Name and address of the manufacturer or of its authorised representative. Mitsubishi Heavy Industries Air-Conditioning Europe, Ltd. 7 Roundwood Avenue, Stockley Park, Uxbridge, Middlesex, UB11 1AX, United Kingdom					

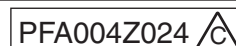

(3) Duct connected-High static pressure type (FDU)

Information to identify the model(s) to which the information relates to:				If function includes heating: Indicate the heating season the information relates to. Indicated values should relate to one heating season at a time. Include at least the heating season 'Average'.			
Indoor unit model name		FDU100VF2		Average(mandatory)		Yes	
Outdoor unit model name		FDC100VNP		Warmer(if designated)		No	
Function(indicate if present)				Colder(if designated)			
cooling		Yes					
heating		Yes					
Item	symbol	value	unit	Item	symbol	value	class
Design load cooling	Pdesignc	10.0	kW	Seasonal efficiency and energy efficiency class cooling	SEER	6.36	A++
heating / Average	Pdesignh	8.1	kW	heating / Average	SCOP/A	4.13	A+
heating / Warmer	Pdesignh	-	kW	heating / Warmer	SCOP/W	-	-
heating / Colder	Pdesignh	-	kW	heating / Colder	SCOP/C	-	-
				unit			
Declared capacity at outdoor temperature Tdesignh				Back up heating capacity at outdoor temperature Tdesignh			
heating / Average (-10°C)		Pdh 8.10 kW		heating / Average (-10°C)		elbu 0 kW	
heating / Warmer (2°C)		Pdh - kW		heating / Warmer (2°C)		elbu - kW	
heating / Colder (-22°C)		Pdh - kW		heating / Colder (-22°C)		elbu - kW	
Declared capacity for cooling, at indoor temperature 27(19)°C and outdoor temperature Tj				Declared energy efficiency ratio, at indoor temperature 27(19)°C and outdoor temperature Tj			
Tj=35°C		Pdc 10.00 kW		Tj=35°C		EERd 3.33 -	
Tj=30°C		Pdc 7.37 kW		Tj=30°C		EERd 4.75 -	
Tj=25°C		Pdc 4.74 kW		Tj=25°C		EERd 8.03 -	
Tj=20°C		Pdc 3.50 kW		Tj=20°C		EERd 11.67 -	
Declared capacity for heating / Average season, at indoor temperature 20°C and outdoor temperature Tj				Declared coefficient of performance / Average season, at indoor temperature 20°C and outdoor temperature Tj			
Tj=-7°C		Pdh 7.17 kW		Tj=-7°C		COPd 2.79 -	
Tj=2°C		Pdh 4.36 kW		Tj=2°C		COPd 4.04 -	
Tj=7°C		Pdh 2.83 kW		Tj=7°C		COPd 5.34 -	
Tj=12°C		Pdh 2.90 kW		Tj=12°C		COPd 6.17 -	
Tj=bivalent temperature		Pdh 8.10 kW		Tj=bivalent temperature		COPd 2.52 -	
Tj=operating limit		Pdh 7.15 kW		Tj=operating limit		COPd 2.38 -	
Declared capacity for heating / Warmer season, at indoor temperature 20°C and outdoor temperature Tj				Declared coefficient of performance / Warmer season, at indoor temperature 20°C and outdoor temperature Tj			
Tj=2°C		Pdh - kW		Tj=2°C		COPd - -	
Tj=7°C		Pdh - kW		Tj=7°C		COPd - -	
Tj=12°C		Pdh - kW		Tj=12°C		COPd - -	
Tj=bivalent temperature		Pdh - kW		Tj=bivalent temperature		COPd - -	
Tj=operating limit		Pdh - kW		Tj=operating limit		COPd - -	
Declared capacity for heating / Colder season, at indoor temperature 20°C and outdoor temperature Tj				Declared coefficient of performance / Colder season, at indoor temperature 20°C and outdoor temperature Tj			
Tj=-7°C		Pdh - kW		Tj=-7°C		COPd - -	
Tj=2°C		Pdh - kW		Tj=2°C		COPd - -	
Tj=7°C		Pdh - kW		Tj=7°C		COPd - -	
Tj=12°C		Pdh - kW		Tj=12°C		COPd - -	
Tj=bivalent temperature		Pdh - kW		Tj=bivalent temperature		COPd - -	
Tj=operating limit		Pdh - kW		Tj=operating limit		COPd - -	
Tj=-15°C		Pdh - kW		Tj=-15°C		COPd - -	
Bivalent temperature				Operating limit temperature			
heating / Average		Tbiv -10 °C		heating / Average		Tol -15 °C	
heating / Warmer		Tbiv - °C		heating / Warmer		Tol - °C	
heating / Colder		Tbiv - °C		heating / Colder		Tol - °C	
Cycling interval capacity				Cycling interval efficiency			
for cooling		Pcycc - kW		for cooling		EERcyc - -	
for heating		Pcyhc - kW		for heating		COPcyc - -	
Degradation coefficient				Degradation coefficient			
cooling		Cdc 0.25 -		heating		Cdh 0.25 -	
Electric power input in power modes other than 'active mode'				Annual electricity consumption			
off mode		Poff 10 W		cooling		Qce 551 kWh/a	
standby mode		Psb 10 W		heating / Average		Qhe 2746 kWh/a	
thermostat-off mode		Pto 50 W		heating / Warmer		Qhe - kWh/a	
crankcase heater mode		Pck 0 W		heating / colder		Qhe - kWh/a	
Capacity control(indicate one of three options)				Other items			
fixed		No		Sound power level(indoor)		Lwa 65 dB(A)	
staged		No		Sound power level(outdoor)		Lwa 70 dB(A)	
variable		Yes		Global warming potential		GWP 1975 kgCO2eq.	
				Rated air flow(indoor)		- 2160 m3/h	
				Rated air flow(outdoor)		- 4500 m3/h	
Contact details for obtaining more information		Name and address of the manufacturer or of its authorised representative. Mitsubishi Heavy Industries Air-Conditioning Europe, Ltd. 7 Roundwood Avenue, Stockley Park, Uxbridge, Middlesex, UB11 1AX, United Kingdom					

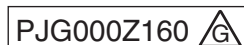

(4) Duct connected-Low / Middle static pressure type (FDUM)

Information to identify the model(s) to which the information relates to:				If function includes heating: Indicate the heating season the information relates to. Indicated values should relate to one heating season at a time. Include at least the heating season 'Average'.			
Indoor unit model name		FDUM100VF2		Average(mandatory)		Yes	
Outdoor unit model name		FDC100VNP		Warmer(if designated)		No	
Function(indicate if present)				Colder(if designated)			
cooling		Yes					
heating		Yes					
Item	symbol	value	unit	Item	symbol	value	class
Design load cooling	Pdesignc	10.0	kW	Seasonal efficiency and energy efficiency class cooling	SEER	6.36	A++
heating / Average	Pdesignh	8.1	kW	heating / Average	SCOP/A	4.13	A+
heating / Warmer	Pdesignh	-	kW	heating / Warmer	SCOP/W	-	-
heating / Colder	Pdesignh	-	kW	heating / Colder	SCOP/C	-	-
				unit			
Declared capacity at outdoor temperature Tdesignh				Back up heating capacity at outdoor temperature Tdesignh			
heating / Average (-10°C)		Pdh 8.10 kW		heating / Average (-10°C)		elbu 0 kW	
heating / Warmer (2°C)		Pdh - kW		heating / Warmer (2°C)		elbu - kW	
heating / Colder (-22°C)		Pdh - kW		heating / Colder (-22°C)		elbu - kW	
Declared capacity for cooling, at indoor temperature 27(19)°C and outdoor temperature Tj				Declared energy efficiency ratio, at indoor temperature 27(19)°C and outdoor temperature Tj			
Tj=35°C		Pdc 10.00 kW		Tj=35°C		EERd 3.33 -	
Tj=30°C		Pdc 7.37 kW		Tj=30°C		EERd 4.75 -	
Tj=25°C		Pdc 4.74 kW		Tj=25°C		EERd 8.03 -	
Tj=20°C		Pdc 3.50 kW		Tj=20°C		EERd 11.67 -	
Declared capacity for heating / Average season, at indoor temperature 20°C and outdoor temperature Tj				Declared coefficient of performance / Average season, at indoor temperature 20°C and outdoor temperature Tj			
Tj=-7°C		Pdh 7.17 kW		Tj=-7°C		COPd 2.79 -	
Tj=2°C		Pdh 4.36 kW		Tj=2°C		COPd 4.04 -	
Tj=7°C		Pdh 2.83 kW		Tj=7°C		COPd 5.34 -	
Tj=12°C		Pdh 2.90 kW		Tj=12°C		COPd 6.17 -	
Tj=bivalent temperature		Pdh 8.10 kW		Tj=bivalent temperature		COPd 2.52 -	
Tj=operating limit		Pdh 7.15 kW		Tj=operating limit		COPd 2.38 -	
Declared capacity for heating / Warmer season, at indoor temperature 20°C and outdoor temperature Tj				Declared coefficient of performance / Warmer season, at indoor temperature 20°C and outdoor temperature Tj			
Tj=2°C		Pdh - kW		Tj=2°C		COPd - -	
Tj=7°C		Pdh - kW		Tj=7°C		COPd - -	
Tj=12°C		Pdh - kW		Tj=12°C		COPd - -	
Tj=bivalent temperature		Pdh - kW		Tj=bivalent temperature		COPd - -	
Tj=operating limit		Pdh - kW		Tj=operating limit		COPd - -	
Declared capacity for heating / Colder season, at indoor temperature 20°C and outdoor temperature Tj				Declared coefficient of performance / Colder season, at indoor temperature 20°C and outdoor temperature Tj			
Tj=-7°C		Pdh - kW		Tj=-7°C		COPd - -	
Tj=2°C		Pdh - kW		Tj=2°C		COPd - -	
Tj=7°C		Pdh - kW		Tj=7°C		COPd - -	
Tj=12°C		Pdh - kW		Tj=12°C		COPd - -	
Tj=bivalent temperature		Pdh - kW		Tj=bivalent temperature		COPd - -	
Tj=operating limit		Pdh - kW		Tj=operating limit		COPd - -	
Tj=-15°C		Pdh - kW		Tj=-15°C		COPd - -	
Bivalent temperature				Operating limit temperature			
heating / Average		Tbiv -10 °C		heating / Average		Tol -15 °C	
heating / Warmer		Tbiv - °C		heating / Warmer		Tol - °C	
heating / Colder		Tbiv - °C		heating / Colder		Tol - °C	
Cycling interval capacity				Cycling interval efficiency			
for cooling		Pcycc - kW		for cooling		EERcyc - -	
for heating		Pcyhc - kW		for heating		COPcyc - -	
Degradation coefficient				Degradation coefficient			
cooling		Cdc 0.25 -		heating		Cdh 0.25 -	
Electric power input in power modes other than 'active mode'				Annual electricity consumption			
off mode		Poff 10 W		cooling		Qce 551 kWh/a	
standby mode		Psb 10 W		heating / Average		Qhe 2746 kWh/a	
thermostat-off mode		Pto 50 W		heating / Warmer		Qhe - kWh/a	
crankcase heater mode		Pck 0 W		heating / colder		Qhe - kWh/a	
Capacity control(indicate one of three options)				Other items			
fixed		No		Sound power level(indoor)		Lwa 65 dB(A)	
staged		No		Sound power level(outdoor)		Lwa 70 dB(A)	
variable		Yes		Global warming potential		GWP 1975 kgCO2eq.	
				Rated air flow(indoor)		- 2160 m3/h	
				Rated air flow(outdoor)		- 4500 m3/h	
Contact details for obtaining more information		Name and address of the manufacturer or of its authorised representative. Mitsubishi Heavy Industries Air-Conditioning Europe, Ltd. 7 Roundwood Avenue, Stockley Park, Uxbridge, Middlesex, UB11 1AX, United Kingdom					



(5) Floor standing type (FDF)

Information to identify the model(s) to which the information relates to:				If function includes heating: Indicate the heating season the information relates to. Indicated values should relate to one heating season at a time. Include at least the heating season 'Average'.			
Indoor unit model name		FDF100VD2		Average(mandatory)		Yes	
Outdoor unit model name		FDC100VNP		Warmer(if designated)		No	
Function(indicate if present)				Colder(if designated)			
cooling		Yes					
heating		Yes					
Item	symbol	value	unit	Item	symbol	value	class
Design load				Seasonal efficiency and energy efficiency class			
cooling	Pdesignc	10.0	kW	cooling	SEER	5.41	A
heating / Average	Pdesignh	8.1	kW	heating / Average	SCOP/A	3.94	A
heating / Warmer	Pdesignh	-	kW	heating / Warmer	SCOP/W	-	-
heating / Colder	Pdesignh	-	kW	heating / Colder	SCOP/C	-	-
				unit			
Declared capacity at outdoor temperature Tdesignh				Back up heating capacity at outdoor temperature Tdesignh			
heating / Average (-10°C)	Pdh	8.10	kW	heating / Average (-10°C)	elbu	0	kW
heating / Warmer (2°C)	Pdh	-	kW	heating / Warmer (2°C)	elbu	-	kW
heating / Colder (-22°C)	Pdh	-	kW	heating / Colder (-22°C)	elbu	-	kW
Declared capacity for cooling, at indoor temperature 27(19)°C and outdoor temperature Tj				Declared energy efficiency ratio, at indoor temperature 27(19)°C and outdoor temperature Tj			
Tj=35°C	Pdc	10.00	kW	Tj=35°C	EERd	3.13	-
Tj=30°C	Pdc	7.37	kW	Tj=30°C	EERd	4.47	-
Tj=25°C	Pdc	4.74	kW	Tj=25°C	EERd	6.58	-
Tj=20°C	Pdc	3.38	kW	Tj=20°C	EERd	8.45	-
Declared capacity for heating / Average season, at indoor temperature 20°C and outdoor temperature Tj				Declared coefficient of performance / Average season, at indoor temperature 20°C and outdoor temperature Tj			
Tj=-7°C	Pdh	7.17	kW	Tj=-7°C	COPd	2.70	-
Tj=2°C	Pdh	4.36	kW	Tj=2°C	COPd	3.93	-
Tj=7°C	Pdh	2.83	kW	Tj=7°C	COPd	4.96	-
Tj=12°C	Pdh	2.90	kW	Tj=12°C	COPd	5.58	-
Tj=bivalent temperature	Pdh	8.10	kW	Tj=bivalent temperature	COPd	2.45	-
Tj=operating limit	Pdh	7.15	kW	Tj=operating limit	COPd	2.32	-
Declared capacity for heating / Warmer season, at indoor temperature 20°C and outdoor temperature Tj				Declared coefficient of performance / Warmer season, at indoor temperature 20°C and outdoor temperature Tj			
Tj=2°C	Pdh	-	kW	Tj=2°C	COPd	-	-
Tj=7°C	Pdh	-	kW	Tj=7°C	COPd	-	-
Tj=12°C	Pdh	-	kW	Tj=12°C	COPd	-	-
Tj=bivalent temperature	Pdh	-	kW	Tj=bivalent temperature	COPd	-	-
Tj=operating limit	Pdh	-	kW	Tj=operating limit	COPd	-	-
Declared capacity for heating / Colder season, at indoor temperature 20°C and outdoor temperature Tj				Declared coefficient of performance / Colder season, at indoor temperature 20°C and outdoor temperature Tj			
Tj=-7°C	Pdh	-	kW	Tj=-7°C	COPd	-	-
Tj=2°C	Pdh	-	kW	Tj=2°C	COPd	-	-
Tj=7°C	Pdh	-	kW	Tj=7°C	COPd	-	-
Tj=12°C	Pdh	-	kW	Tj=12°C	COPd	-	-
Tj=bivalent temperature	Pdh	-	kW	Tj=bivalent temperature	COPd	-	-
Tj=operating limit	Pdh	-	kW	Tj=operating limit	COPd	-	-
Tj=-15°C	Pdh	-	kW	Tj=-15°C	COPd	-	-
Bivalent temperature				Operating limit temperature			
heating / Average	Tbiv	-10	°C	heating / Average	Tol	-15	°C
heating / Warmer	Tbiv	-	°C	heating / Warmer	Tol	-	°C
heating / Colder	Tbiv	-	°C	heating / Colder	Tol	-	°C
Cycling interval capacity				Cycling interval efficiency			
for cooling	Pcycc	-	kW	for cooling	EERcyc	-	-
for heating	Pcyhc	-	kW	for heating	COPcyc	-	-
Degradation coefficient				Degradation coefficient			
cooling	Cdc	0.25	-	heating	Cdh	0.25	-
Electric power input in power modes other than 'active mode'				Annual electricity consumption			
off mode	Poff	10	W	cooling	Qce	647	kWh/a
standby mode	Psb	10	W	heating / Average	Qhe	2875	kWh/a
thermostat-off mode	Pto	66	W	heating / Warmer	Qhe	-	kWh/a
crankcase heater mode	Pck	0	W	heating / colder	Qhe	-	kWh/a
Capacity control(indicate one of three options)				Other items			
fixed		No		Sound power level(indoor)	Lwa	65	dB(A)
staged		No		Sound power level(outdoor)	Lwa	70	dB(A)
variable		Yes		Global warming potential	GWP	1975	kgCO2eq.
				Rated air flow(indoor)	-	1740	m3/h
				Rated air flow(outdoor)	-	4500	m3/h
Contact details for obtaining more information	Name and address of the manufacturer or of its authorised representative. Mitsubishi Heavy Industries Air-Conditioning Europe, Ltd. 7 Roundwood Avenue, Stockley Park, Uxbridge, Middlesex, UB11 1AX, United Kingdom						

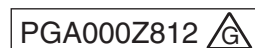

(6) Wall mounted type (SRK)

Information to identify the model(s) to which the information relates to:				If function includes heating: Indicate the heating season the information relates to. Indicated values should relate to one heating season at a time. Include at least the heating season 'Average'.			
Indoor unit model name		SRK100ZR-S		Average(mandatory)		Yes	
Outdoor unit model name		FDC100VNP		Warmer(if designated)		Yes	
Function(indicate if present)				Colder(if designated)			
cooling		Yes					
heating		Yes					
Item	symbol	value	unit	Item	symbol	value	class
Design load				Seasonal efficiency and energy efficiency class			
cooling	Pdesignc	10.00	kW	cooling	SEER	6.60	A++
heating / Average	Pdesignh	7.20	kW	heating / Average	SCOP/A	4.40	A+
heating / Warmer	Pdesignh	9.00	kW	heating / Warmer	SCOP/W	5.60	A+++
heating / Colder	Pdesignh	-	kW	heating / Colder	SCOP/C	-	-
Declared capacity at outdoor temperature Tdesignh				Back up heating capacity at outdoor temperature Tdesignh			
heating / Average (-10°C)	Pdh	7.20	kW	heating / Average (-10°C)	elbu	0	kW
heating / Warmer (2°C)	Pdh	9.00	kW	heating / Warmer (2°C)	elbu	0	kW
heating / Colder (-22°C)	Pdh	-	kW	heating / Colder (-22°C)	elbu	-	kW
Declared capacity for cooling, at indoor temperature 27(19)°C and outdoor temperature Tj				Declared energy efficiency ratio, at indoor temperature 27(19)°C and outdoor temperature Tj			
Tj=35°C	Pdc	10.00	kW	Tj=35°C	EERd	3.24	-
Tj=30°C	Pdc	7.37	kW	Tj=30°C	EERd	5.00	-
Tj=25°C	Pdc	4.74	kW	Tj=25°C	EERd	7.75	-
Tj=20°C	Pdc	3.52	kW	Tj=20°C	EERd	12.00	-
Declared capacity for heating / Average season, at indoor temperature 20°C and outdoor temperature Tj				Declared coefficient of performance / Average season, at indoor temperature 20°C and outdoor temperature Tj			
Tj=-7°C	Pdh	6.37	kW	Tj=-7°C	COPd	2.70	-
Tj=2°C	Pdh	3.88	kW	Tj=2°C	COPd	4.40	-
Tj=7°C	Pdh	3.39	kW	Tj=7°C	COPd	6.10	-
Tj=12°C	Pdh	3.95	kW	Tj=12°C	COPd	7.40	-
Tj=bivalent temperature	Pdh	7.20	kW	Tj=bivalent temperature	COPd	2.50	-
Tj=operating limit	Pdh	6.36	kW	Tj=operating limit	COPd	2.30	-
Declared capacity for heating / Warmer season, at indoor temperature 20°C and outdoor temperature Tj				Declared coefficient of performance / Warmer season, at indoor temperature 20°C and outdoor temperature Tj			
Tj=2°C	Pdh	9.00	kW	Tj=2°C	COPd	2.80	-
Tj=7°C	Pdh	5.79	kW	Tj=7°C	COPd	5.15	-
Tj=12°C	Pdh	3.95	kW	Tj=12°C	COPd	7.40	-
Tj=bivalent temperature	Pdh	9.00	kW	Tj=bivalent temperature	COPd	2.80	-
Tj=operating limit	Pdh	6.36	kW	Tj=operating limit	COPd	2.30	-
Declared capacity for heating / Colder season, at indoor temperature 20°C and outdoor temperature Tj				Declared coefficient of performance / Colder season, at indoor temperature 20°C and outdoor temperature Tj			
Tj=-7°C	Pdh	-	kW	Tj=-7°C	COPd	-	-
Tj=2°C	Pdh	-	kW	Tj=2°C	COPd	-	-
Tj=7°C	Pdh	-	kW	Tj=7°C	COPd	-	-
Tj=12°C	Pdh	-	kW	Tj=12°C	COPd	-	-
Tj=bivalent temperature	Pdh	-	kW	Tj=bivalent temperature	COPd	-	-
Tj=operating limit	Pdh	-	kW	Tj=operating limit	COPd	-	-
Tj=-15°C	Pdh	-	kW	Tj=-15°C	COPd	-	-
Bivalent temperature				Operating limit temperature			
heating / Average	Tbiv	-10	°C	heating / Average	Tol	-15	°C
heating / Warmer	Tbiv	2	°C	heating / Warmer	Tol	-15	°C
heating / Colder	Tbiv	-	°C	heating / Colder	Tol	-	°C
Cycling interval capacity				Cycling interval efficiency			
for cooling	Pcycc	-	kW	for cooling	EERcyc	-	-
for heating	Pcyh	-	kW	for heating	COPcyc	-	-
Degradation coefficient				Degradation coefficient			
cooling	Cdc	0.25	-	heating	Cdh	0.25	-
Electric power input in power modes other than 'active mode'				Annual electricity consumption			
off mode	Poff	5	W	cooling	Qce	531	kWh/a
standby mode	Psb	5	W	heating / Average	Qhe	2289	kWh/a
thermostat-off mode	Pto	16	W	heating / Warmer	Qhe	2251	kWh/a
crankcase heater mode	Pck	0	W	heating / colder	Qhe	-	kWh/a
Capacity control(indicate one of three options)				Other items			
fixed		No		Sound power level(indoor)	Lwa	63	dB(A)
staged		No		Sound power level(outdoor)	Lwa	70	dB(A)
variable		Yes		Global warming potential	GWP	1975	kgCO2eq.
				Rated air flow(indoor)	-	1470	m3/h
				Rated air flow(outdoor)	-	4500	m3/h
Contact details for obtaining more information		Name and address of the manufacturer or of its authorised representative. Mitsubishi Heavy Industries Air-Conditioning Europe, Ltd. 7 Roundwood Avenue, Stockley Park, Uxbridge, Middlesex, UB11 1AX, United Kingdom					

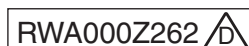

STANDARD INVERTER PACKAGED AIR-CONDITIONERS



MITSUBISHI HEAVY INDUSTRIES THERMAL SYSTEMS, LTD.

16-5 Konan 2-chome, Minato-ku, Tokyo, 108-8215, Japan
<http://www.mhi-mth.co.jp/>

Because of our policy of continuous improvement, we reserve the right to make changes in all specifications without notice.

© Copyright MITSUBISHI HEAVY INDUSTRIES THERMAL SYSTEMS, LTD.