

MICRO INVERTER PACKAGED AIR-CONDITIONERS (Split system, air to air heat pump type)

CEILING CASSETTE-4WAY TYPE

Single type	Twin type	Triple type
FDT100VNVF1	FDT100VNPVF	FDT140VNTVF
100VSVF1	100VSPVF	140VSTVF
100VNVF2	125VNPVF	200VSTVF1
100VSVF2	125VSPVF	Double twin type
125VNVF	140VNPVF1	FDT200VSDVF
125VSVF	140VSPVF1	250VSDVF
140VNVF	200VSPVF1	
140VSVF	250VSPVF1	

CEILING CASSETTE-4WAY COMPACT TYPE

Twin type	Triple type	Double twin type
FDTC100VNPVF	FDTC140VNTVF	FDTC200VSDVF
100VSPVF	140VSTVF	250VSDVF
125VNPVF		
125VSPVF		

CEILING SUSPENDED TYPE

Single type	Twin type	Triple type
FDEN100VNVF1	FDEN100VNPVF	FDEN140VNTVF
100VSVF1	100VSPVF	140VSTVF
125VNVF	125VNPVF	200VSTVF1
125VSVF	125VSPVF	Double twin type
140VNVF	140VNPVF1	FDEN200VSDVF
140VSVF	140VSPVF1	250VSDVF
	200VSPVF1	
	250VSPVF	

DUCT CONNECTED-LOW/MIDDLE STATIC PRESSURE TYPE

Single type	Twin type	Triple type
FDUM100VNVF1	FDUM100VNPVF	FDUM140VNTVF
100VSVF1	100VSPVF	140VSTVF
100VNVF2	125VNPVF	200VSTVF1
100VSVF2	125VSPVF	
125VNVF	140VNPVF1	
125VSVF	140VSPVF1	
140VNVF	200VSPVF1	
140VSVF	250VSPVF	

DUCT CONNECTED-HIGH STATIC PRESSURE TYPE

Single type	Twin type
FDU100VNVF1	FDU140VNVF
100VSVF1	140VSVF
100VNVF2	200VSVF
100VSVF2	250VSVF
125VNVF	
125VSVF	

WALL MOUNTED TYPE

Twin type	Triple type
SRK100VNPZMX	SRK140VNTZMX
100VSPZMX	140VSTZMX
125VNPZMX	
125VSPZMX	
140VNVF	
140VSVF	

V Multi System

(OUTDOOR UNIT)	(INDOOR UNIT)	
FDC100VN	FDT50VF	FDEN50VF
100VS	60VF	60VF
125VN	71VF1	71VF1
125VS	100VF1	100VF1
140VN	100VF2	125VF
140VS	125VF	
200VS		
250VS		

FLOOR STANDING TYPE

Single type	Twin type
FDF100VNVF1	FDF140VNPVD1
100VSDV1	140VSPVD1
100VNVF2	200VSPVD1
100VSDV2	250VSPVD
125VNVF	
125VSDV	

Service code

Model	History of service code							Changes
FDC100VN	Blank	A	B	C	D	L	M	Blank→A: Expanded operation temperature range down to -20°C in heating
FDC125VN	Blank	A	B	C	D	L	M	A→B: Expanded diameter of half punched hole for pipes to be drawn in from behind
FDC140VN	Blank	A	B	C	D	L	M	B→C: Replaced with new compressor and PCB, Complied with Lot10
FDC100VS	Blank	A	B	C	D	L	M	C→D: Connector discontinue countermeasure
FDC125VS	Blank	A	B	C	D	L	M	D→L: Complied with LVD (changing fan guard)
FDC140VS	Blank	A	B	C	D	L	M	L→M: Connector discontinue countermeasure

TABLE OF CONTENTS

1. MICRO INVERTER PACKAGED AIR-CONDITIONERS	2
2. V MULTI SYSTEM	490
3. OPTION PARTS	514

1. MICRO INVERTER PACKAGED AIR-CONDITIONERS

CONTENTS

1.1 SPECIFICATIONS	6
(1) Ceiling cassette-4way type (FDT)	6
(2) Ceiling cassette-4way compact type (FDTC)	25
(3) Ceiling suspended type (FDEN)	33
(4) Duct connected-High static pressure type (FDU)	52
(5) Duct connected-Low/Middle static pressure type (FDUM)	60
(6) Floor standing type (FDF)	77
(7) Wall mounted type (SRK)	87
1.2 EXTERIOR DIMENSIONS	93
(1) Indoor units	93
(2) Outdoor units	107
(3) Remote control (Option parts)	110
1.3 ELECTRICAL WIRING	113
(1) Indoor units	113
(2) Outdoor units	125
1.4 NOISE LEVEL	128
1.5 CHARACTERISTICS OF FAN	133
1.6 TEMPERATURE AND VELOCITY DISTRIBUTION	141
1.7 PIPING SYSTEM	150
1.8 RANGE OF USAGE & LIMITATIONS	155
1.9 SELECTION CHART	159
1.9.1 Capacity tables	159
(1) Ceiling cassette-4way type (FDT)	159
(2) Ceiling cassette-4way compact type (FDTC)	169
(3) Ceiling suspended type (FDEN)	173
(4) Duct connected-High static pressure type (FDU)	183
(5) Duct connected-Low/Middle static pressure type (FDUM)	187
(6) Floor standing type (FDF)	196
(7) Wall mounted type (SRK)	201
1.9.2 Correction of cooling and heating capacity in relation to air flow rate control (fan speed)	207
1.9.3 Correction of cooling and heating capacity in relation to one way length of refrigerant piping	207
1.9.4 Height difference between the indoor unit and outdoor unit	207
1.10 APPLICATION DATA	209
1.10.1 Installation of indoor unit	209
(1) Ceiling cassette-4way type (FDT)	209
(2) Ceiling cassette-4way compact type (FDTC)	216
(3) Ceiling suspended type (FDEN)	222
(4) Duct connected-High static pressure type (FDU)	226

(5) Duct connected-Low/Middle static pressure type (FDUM)	236
(6) Floor standing type (FDF)	242
(7) Wall mounted type (SRK)	246
(8) Effective range of cool/hot wind (Reference)	250
1.10.2 Electric wiring work installation	251
(1) FDT, FDTC, FDEN, FDU200-250, FDUM series	251
(2) FDU100 - 140 series	255
(3) FDF series	259
1.10.3 Installation of wired remote control (option)	263
1.10.4 Installation of outdoor unit	277
(1) Models FDC100 - 140VN, 100 - 140VS	277
(2) Models FDC200, 250VS	286
(3) Method for connecting the accessory pipe (Models FDC200, 250)	295
1.10.5 Instructions for branching pipe set (DIS-WA1,WB1,TA1,TB1)	297
1.11 OUTLINE OF OPERATION CONTROL BY MICROCOMPUTER	300
1.11.1 Remote control	300
1.11.2 Operation control function by the wired remote control	303
1.11.3 Operation control function by the indoor control	306
(I) FDT, FDTC, FDEN, FDU, FDUM, FDF series	306
(1) Auto operation	306
(2) Operations of functional items during cooling/heating	307
(3) Dehumidifying operation	307
(4) Timer operation	308
(5) Remote control display during the operation stop	309
(6) Hot start (Cold draft prevention at heating)	309
(7) Hot keep	309
(8) Auto swing control (FDT, FDTC, FDEN, FDF only)	310
(9) Thermostat operation	311
(10) Filter sign	312
(11) Compressor inching prevention control	312
(12) Drain pump control	313
(13) Drain motor (DM) control	313
(14) Operation check/drain pump test run operation mode	313
(15) Cooling, dehumidifying frost protection	314
(16) Heating overload protection	314
(17) Anomalous fan motor	315
(18) Plural unit control - Control of 16 units group by one remote control	315
(19) High ceiling control	315
(20) Abnormal temperature thermistor (return air/indoor heat exchanger) wire/short-circuit detection	316
(21) External input/output control (CnT or CnTA)	316

(22)	Operation permission/prohibition	318
(23)	Selection of cooling/heating external input function	319
(24)	Fan control at heating startup	320
(25)	Room temperature detection temperature compensation during heating	320
(26)	Return air temperature compensation	320
(27)	High power operation (RC-EX1A only)	320
(28)	Energy-saving operation (RC-EX1A only)	321
(29)	Warm-up control (RC-EX1A only)	321
(30)	Home leave mode (RC-EX1A only)	321
(31)	Auto temp. setting (RC-EX1A only)	321
(32)	Fan circulator operation (RC-EX1A only)	321
(33)	The operation judgment is executed every 5 minutes (RC-EX1 only)	321
(34)	Auto fan speed control (RC-EX1 only)	321
(35)	IU overload alarm (RC-EX1A only)	321
(II)	SRK Series	322
(1)	Unit ON/OFF button	322
(2)	Auto restart function	322
(3)	Auto swing control	322
(4)	Timer operation	323
(5)	Remote control display during the operation stop	324
(6)	Outline of heating or cooling operation	324
(7)	Indoor fan motor protection	325
(8)	Serial signal transmission error protection	325
(9)	Plural unit control - Control of 16 units group by one remote control	325
(10)	Filter sign	326
(11)	Outline of automatic operation	326
(12)	Frost prevention control	326
(13)	Dew prevention control II	327
(14)	Outline of dry (dehumidifying) operation	327
1.11.4	Operation control function by the outdoor control	328
(1)	Determination of compressor speed (frequency)	328
(2)	Compressor start control	328
(3)	Compressor soft start control	329
(4)	Outdoor unit fan control	330
(5)	Defrosting	332
(6)	Protective control/anomalous stop control by compressor's number of revolutions	333
(7)	Silent mode	336
(8)	Test run	336
(9)	Pump-down control	337
(10)	Base heater ON/OFF output control (option)	337

1.12 MAINTENANCE DATA	338
1.12.1 Diagnosing of microcomputer circuit	338
(1) Selfdiagnosis function	338
(2) Troubleshooting procedure	343
(3) Troubleshooting at the indoor unit	343
(4) Troubleshooting at the outdoor unit	359
(5) Check of anomalous operation data with the remote control	366
(6) Power transistor module (including the driver PCB) inspection procedure	368
(7) Inverter checker for diagnosis of inverter output	369
(8) Outdoor unit control failure diagnosis circuit diagram	370
1.12.2 Troubleshooting flow	373
(1) List of troubles	373
(2) Troubleshooting	375
1.13 TECHNICAL INFORMATION	470
(1) Ceiling cassette-4way type (FDT)	470
(2) Ceiling cassette-4way compact type (FDTC)	474
(3) Ceiling suspended type (FDEN)	476
(4) Duct connected-High static pressure type (FDU)	480
(5) Duct connected-Low/Middle static pressure type (FDUM)	482
(6) Floor standing type (FDF)	486
(7) Wall mounted type (SRK)	488

How to read the model name

Example: **FDT 100 VN P VF**

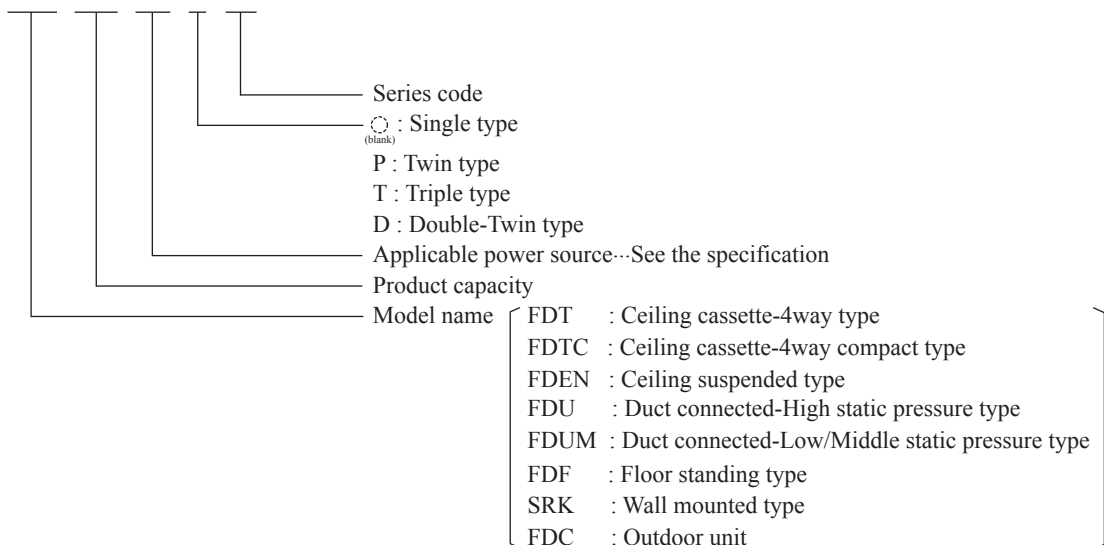

1.1 SPECIFICATIONS

(1) Ceiling cassette-4way type (FDT)

(a) Single type

Item		Model		FDT100VNVF1		
				Indoor unit FDT100VF1	Outdoor unit FDC100VN	
Power source		1 Phase 220-240V 50Hz / 220V 60Hz				
Operation data	Nominal cooling capacity (range)	kW		10.0 [4.0(Min.)~11.2(Max.)]		
	Nominal heating capacity (range)	kW		11.2 [4.0(Min.)~12.5(Max.)]		
	Power consumption	Cooling	kW		2.76	
		Heating	kW		2.74	
	Max power consumption			3.86		
	Running current	Cooling	A		12.1 / 12.7	
		Heating	A		12.0 / 12.6	
	Inrush current, max current			5, 24		
	Power factor	Cooling	%		99	
		Heating	%		99	
	EER	Cooling			3.62	
	COP	Heating			4.09	
	Sound power level	Cooling	dB(A)		65	
Heating		dB(A)		70		
Sound pressure level	Cooling	dB(A)		P-Hi : 51 Hi : 40 Me : 37 Lo : 35		
	Heating	dB(A)		49		
Silent mode sound pressure level			Cooling : 46 / Heating : 46			
Exterior dimensions (Height × Width × Depth)		mm		Unit 298 × 840 × 840 Panel 35 × 950 × 950		
Exterior appearance (Munsell color)				Plaster White (6.8Y8.9/0.2) near equivalent		
Net weight		kg		UNIT 27 PANEL 5.5		
Compressor type & Q'ty				—		
Compressor motor (Starting method)		kW		—		
Refrigerant oil (Amount, type)		ℓ		—		
Refrigerant (Type, amount, pre-charge length)		kg		R410A 3.8kg in outdoor unit (incl. the amount for the piping of : 30m)		
Heat exchanger				Louver fin & inner grooved tubing		
Refrigerant control				Electronic expansion valve		
Fan type & Q'ty				Turbo fan ×1		
Fan motor (Starting method)		W		140 < Direct line start >		
Air flow	Cooling	m³/min		P-Hi : 37 Hi : 27 Me : 24 Lo : 20		
	Heating	m³/min		75		
Available external static pressure		Pa		0		
Outside air intake				Possible		
Air filter, Quality / Quantity				Pocket plastic net ×1(Washable)		
Shock & vibration absorber				Rubber sleeve (for fan motor)		
Electric heater		W		—		
Operation control	Remote control			(option) wired : RC-EX1A, RC-E5, RCH-E3 wireless : RCN-T-36W-E		
	Room temperature control			Thermostat by electronics		
	Operation display			—		
Safety equipments				Overload protection for fan motor. Frost protection thermostat. Internal thermostat for fan motor. Abnormal discharge temperature protection.		
Installation data	Refrigerant piping size (O.D.)	mm		Liquid line: I/U φ 9.52 (3/8") Pipe φ 9.52(3/8")×0.8 O/U φ 9.52 (3/8") Gas line: φ 15.88 (5/8") φ 15.88 (5/8")×1.0 φ 15.88 (5/8")		
	Connecting method			Flare piping		
	Attached length of piping	m		—		
	Insulation for piping			Necessary (both Liquid & Gas lines)		
	Refrigerant line (one way) length	m		Max.50m		
	Vertical height diff. between O.U. and I.U.	m		Max.30m (Outdoor unit is higher)		
Drain hose			Hose connectable with VP25 (O.D.32)			
Drain pump, max lift height	mm		Built-in Drain pump, 700			
Recommended breaker size	A		—			
L.R.A. (Locked rotor ampere)	A		5.0			
Interconnecting wires	Size × Core number		φ 1.6mm×3 cores (+ earth cable 1.6mm) / Terminal block (Screw fixing type)			
IP number			IPX0			
Standard accessories			Mounting kit, Drain hose			
Option parts			Edging			
Note (1) The data are measured at the following conditions. The pipe length is 7.5m.						
		Indoor air temperature		Outdoor air temperature		
Operation	DB	WB	DB	WB	Standards	
	Cooling	27°C	19°C	35°C		24°C
Heating	20°C	—	7°C	6°C	ISO5151-T1	
(2) This air-conditioner is manufactured and tested in conformity with the ISO.						
(3) Sound level indicates the value in an anechoic chamber. During operation these value are somewhat higher due to ambient conditions.						
(4) Select the breaker size according to the own national standard.						
(5) When wireless remote control is used, fan is 3 speed setting (Hi-Me-Lo) only.						
(6) The operation data indicate when the air-conditioner is operated at 230V50Hz or 220V60Hz.						

Item		Model	FDT100VNVF2		
			Indoor unit FDT100VF2	Outdoor unit FDC100VN	
Power source			1 Phase 220-240V 50Hz / 220V 60Hz		
Operation data	Nominal cooling capacity (range)	kW	10.0 [4.0(Min.)~11.2(Max.)]		
	Nominal heating capacity (range)	kW	11.2 [4.0(Min.)~12.5(Max.)]		
	Power consumption	Cooling	kW	2.76	
		Heating		2.74	
	Max power consumption		3.86		
	Running current	Cooling	A	12.1 / 12.7	
		Heating		12.0 / 12.6	
	Inrush current, max current		5, 24		
	Power factor	Cooling	%	99	
		Heating		99	
	EER	Cooling		3.62	
COP	Heating		4.09		
Sound power level	Cooling	dB(A)	65		
	Heating		70		
Sound pressure level	Cooling	dB(A)	P-Hi : 51 Hi : 40 Me : 37 Lo : 35		
	Heating		49		
Silent mode sound pressure level			-		
Exterior dimensions (Height × Width × Depth)		mm	Unit 298 × 840 × 840 Panel 35 × 950 × 950		
Exterior appearance (Munsell color)			Plaster White (6.8Y8.9/0.2) near equivalent Stucco White (4.2Y7.5/1.1) near equivalent		
Net weight		kg	UNIT 27 PANEL 5.5 81		
Compressor type & Q'ty			- RMT5126MDE2×1		
Compressor motor (Starting method)		kW	- Direct line start		
Refrigerant oil (Amount, type)		ℓ	- 0.9 M-MA68		
Refrigerant (Type, amount, pre-charge length)		kg	R410A 3.8kg in outdoor unit (incl. the amount for the piping of : 30m)		
Heat exchanger			Louver fin & inner grooved tubing Straight fin & inner grooved tubing		
Refrigerant control			Electronic expansion valve		
Fan type & Q'ty			Turbo fan ×1 Propeller fan ×1		
Fan motor (Starting method)		W	140 < Direct line start > 86 < Direct line start >		
Air flow	Cooling	m³/min	P-Hi : 37 Hi : 27 Me : 24 Lo : 20		
	Heating		75		
Available external static pressure		Pa	0 -		
Outside air intake			Possible -		
Air filter, Quality / Quantity			Pocket plastic net ×1(Washable) -		
Shock & vibration absorber			Rubber sleeve (for fan motor) Rubber sleeve (for compressor)		
Electric heater		W	- 20 (Crank case heater)		
Operation control	Remote control		(option) wired : RC-EX1A, RC-E5, RCH-E3 wireless : RCN-T-36W-E		
	Room temperature control		Thermostat by electronics		
	Operation display		-		
Safety equipments			Overload protection for fan motor. Frost protection thermostat. Internal thermostat for fan motor. Abnormal discharge temperature protection.		
Installation data	Refrigerant piping size (O.D.)	mm	Liquid line: I/U φ 9.52 (3/8") Pipe φ 9.52(3/8")×0.8 O/U φ 9.52 (3/8") Gas line: φ 15.88 (5/8") φ 15.88 (5/8")×1.0 φ 15.88 (5/8")		
	Connecting method		Flare piping Flare piping		
	Attached length of piping	m	- -		
	Insulation for piping		Necessary (both Liquid & Gas lines)		
	Refrigerant line (one way) length	m	Max.50m		
	Vertical height diff. between O.U. and I.U.	m	Max.30m (Outdoor unit is higher) Max.15m (Outdoor unit is lower)		
Drain hose			Hose connectable with VP25 (O.D.32) Holes size φ 20 × 3pcs		
Drain pump, max lift height		mm	Built-in Drain pump, 700 -		
Recommended breaker size		A	-		
L.R.A. (Locked rotor ampere)		A	5.0		
Interconnecting wires Size × Core number			φ 1.6mm × 3 cores (including earth cable) / Terminal block (Screw fixing type)		
IP number			IPX0 IP24		
Standard accessories			Mounting kit, Drain hose Edging		
Option parts			-		

Note (1) The data are measured at the following conditions.

The pipe length is 7.5m.

Operation	Indoor air temperature		Outdoor air temperature		Standards
	DB	WB	DB	WB	
Cooling	27°C	19°C	35°C	24°C	ISO5151-T1
Heating	20°C	-	7°C	6°C	

- (2) This air-conditioner is manufactured and tested in conformity with the ISO.
- (3) Sound level indicates the value in an anechoic chamber. During operation these value are somewhat higher due to ambient conditions.
- (4) Select the breaker size according to the own national standard.
- (5) When wireless remote control is used, fan is 3 speed setting (Hi-Me-Lo) only.
- (6) The operation data indicate when the air-conditioner is operated at 230V50Hz or 220V60Hz.

Item		Model	FDT100VSVF1		
			Indoor unit FDT100VF1	Outdoor unit FDC100VS	
Power source			3 Phase 380-415V 50Hz / 380V 60Hz		
Operation data	Nominal cooling capacity (range)	kW	10.0 [4.0(Min.)~11.2(Max.)]		
	Nominal heating capacity (range)	kW	11.2 [4.0(Min.)~12.5(Max.)]		
	Power consumption	Cooling	kW	2.76	
		Heating		2.74	
	Max power consumption		3.86		
	Running current	Cooling	A	4.2 / 4.4	
		Heating		4.2 / 4.4	
	Inrush current, max current		5, 15		
	Power factor	Cooling	%	95 / 91	
		Heating		94 / 95	
	EER	Cooling		3.62	
	COP	Heating		4.09	
Sound power level	Cooling	dB(A)	65		
	Heating		70		
Sound pressure level	Cooling	dB(A)	P-Hi : 51 Hi : 40 Me : 37 Lo : 35		
	Heating		49		
Silent mode sound pressure level			Cooling : 46 / Heating : 46		
Exterior dimensions (Height × Width × Depth)		mm	Unit 298 × 840 × 840 Panel 35 × 950 × 950	845×970×370	
Exterior appearance (Munsell color)			Plaster White (6.8Y8.9/0.2) near equivalent	Stucco White (4.2Y7.5/1.1) near equivalent	
Net weight		kg	UNIT 27 PANEL 5.5	83	
Compressor type & Q'ty			—	RMT5126MDE3×1	
Compressor motor (Starting method)		kW	—	Direct line start	
Refrigerant oil (Amount, type)		ℓ	—	0.9 M-MA68	
Refrigerant (Type, amount, pre-charge length)		kg	R410A 3.8kg in outdoor unit (incl. the amount for the piping of : 30m)		
Heat exchanger			Louver fin & inner grooved tubing	Straight fin & inner grooved tubing	
Refrigerant control			Electronic expansion valve		
Fan type & Q'ty			Turbo fan ×1	Propeller fan ×1	
Fan motor (Starting method)		W	140 < Direct line start >	86 < Direct line start >	
Air flow	Cooling	m³/min	P-Hi : 37 Hi : 27 Me : 24 Lo : 20		
	Heating		75		
Available external static pressure		Pa	0	—	
Outside air intake			Possible	—	
Air filter, Quality / Quantity			Pocket plastic net ×1(Washable)	—	
Shock & vibration absorber			Rubber sleeve (for fan motor)	Rubber sleeve (for compressor)	
Electric heater		W	—	20 (Crank case heater)	
Operation control	Remote control		(option) wired : RC-EX1A, RC-E5, RCH-E3 wireless : RCN-T-36W-E		
	Room temperature control		Thermostat by electronics		
	Operation display		—		
Safety equipments			Overload protection for fan motor. Frost protection thermostat. Internal thermostat for fan motor. Abnormal discharge temperature protection.		
Installation data	Refrigerant piping size (O.D.)	mm	Liquid line: I/U φ 9.52 (3/8") Pipe φ 9.52(3/8")×0.8 O/U φ 9.52 (3/8") Gas line: φ 15.88 (5/8") φ 15.88 (5/8")×1.0 φ 15.88 (5/8")		
	Connecting method		Flare piping	Flare piping	
	Attached length of piping	m	—	—	
	Insulation for piping		Necessary (both Liquid & Gas lines)		
	Refrigerant line (one way) length	m	Max.50m		
	Vertical height diff. between O.U. and I.U.	m	Max.30m (Outdoor unit is higher) Max.15m (Outdoor unit is lower)		
Drain hose			Hose connectable with VP25 (O.D.32)	Holes size φ 20 × 3pcs	
Drain pump, max lift height		mm	Built-in Drain pump, 700		
Recommended breaker size		A	—		
L.R.A. (Locked rotor ampere)		A	5.0		
Interconnecting wires Size × Core number			φ 1.6mm×3 cores (+ earth cable 1.6mm) / Terminal block (Screw fixing type)		
IP number			IPX0	IP24	
Standard accessories			Mounting kit, Drain hose	Edging	
Option parts			—		
Note (1) The data are measured at the following conditions.			The pipe length is 7.5m.		
Operation	Indoor air temperature	Outdoor air temperature		Standards	
		DB	WB		DB
	Cooling	27°C	19°C		35°C
Heating	20°C	—	7°C	6°C	
(2) This air-conditioner is manufactured and tested in conformity with the ISO. (3) Sound level indicates the value in an anechoic chamber. During operation these value are somewhat higher due to ambient conditions. (4) Select the breaker size according to the own national standard. (5) When wireless remote control is used, fan is 3 speed setting (Hi-Me-Lo) only. (6) The operation data indicate when the air-conditioner is operated at 400V50Hz or 380V60Hz.					

Item		Model	FDT100VSF2			
			Indoor unit FDT100VF2	Outdoor unit FDC100VS		
Power source			3 Phase 380-415V 50Hz / 380V 60Hz			
Operation data	Nominal cooling capacity (range)	kW	10.0 [4.0(Min.)~11.2(Max.)]			
	Nominal heating capacity (range)	kW	11.2 [4.0(Min.)~12.5(Max.)]			
	Power consumption	Cooling	kW	2.76		
		Heating		2.74		
	Max power consumption		3.86			
	Running current	Cooling	A	4.2 / 4.4		
		Heating		4.2 / 4.4		
	Inrush current, max current		5, 15			
	Power factor	Cooling	%	95 / 91		
		Heating		94 / 95		
	EER	Cooling		3.62		
	COP	Heating		4.09		
Sound power level	Cooling	dB(A)	65			
	Heating		70			
Sound pressure level	Cooling	dB(A)	P-Hi : 51 Hi : 40 Me : 37 Lo : 35			
	Heating		49			
Silent mode sound pressure level			-			
Exterior dimensions (Height × Width × Depth)		mm	Unit 298 × 840 × 840 Panel 35 × 950 × 950	845×970×370		
Exterior appearance (Munsell color)			Plaster White (6.8Y8.9/0.2) near equivalent	Stucco White (4.2Y7.5/1.1) near equivalent		
Net weight		kg	UNIT 27 PANEL 5.5	83		
Compressor type & Q'ty			-	RMT5126MDE3×1		
Compressor motor (Starting method)		kW	-	Direct line start		
Refrigerant oil (Amount, type)		ℓ	-	0.9 M-MA68		
Refrigerant (Type, amount, pre-charge length)		kg	R410A 3.8kg in outdoor unit (incl. the amount for the piping of : 30m)			
Heat exchanger			Louver fin & inner grooved tubing	Straight fin & inner grooved tubing		
Refrigerant control			Electronic expansion valve			
Fan type & Q'ty			Turbo fan ×1	Propeller fan ×1		
Fan motor (Starting method)		W	140 < Direct line start >	86 < Direct line start >		
Air flow	Cooling	m³/min	P-Hi : 37 Hi : 27 Me : 24 Lo : 20			
	Heating		75			
Available external static pressure		Pa	0			
Outside air intake			Possible			
Air filter, Quality / Quantity			Pocket plastic net ×1(Washable)			
Shock & vibration absorber			Rubber sleeve (for fan motor)			
Electric heater		W	-	20 (Crank case heater)		
Operation control	Remote control		(option) wired : RC-EX1A, RC-E5, RCH-E3 wireless : RCN-T-36W-E			
	Room temperature control		Thermostat by electronics			
	Operation display		-			
Safety equipments			Overload protection for fan motor. Frost protection thermostat. Internal thermostat for fan motor. Abnormal discharge temperature protection.			
Installation data	Refrigerant piping size (O.D.)	mm	Liquid line: I/U φ 9.52 (3/8") Pipe φ 9.52(3/8")×0.8 O/U φ 9.52 (3/8") Gas line: φ 15.88 (5/8") φ 15.88 (5/8")×1.0 φ 15.88 (5/8")			
	Connecting method		Flare piping			
	Attached length of piping	m	-			
	Insulation for piping		Necessary (both Liquid & Gas lines)			
	Refrigerant line (one way) length	m	Max.50m			
	Vertical height diff. between O.U. and I.U.	m	Max.30m (Outdoor unit is higher) Max.15m (Outdoor unit is lower)			
Drain hose			Hose connectable with VP25 (O.D.32)	Holes size φ 20 × 3pcs		
Drain pump, max lift height	mm		Built-in Drain pump, 700			
Recommended breaker size	A		-			
L.R.A. (Locked rotor ampere)	A		5.0			
Interconnecting wires Size × Core number			φ 1.6 mm × 3 cores(including earth cable) / Terminal block (Screw fixing type)			
IP number			IPX0	IP24		
Standard accessories			Mounting kit, Drain hose	Edging		
Option parts			-			
Note (1) The data are measured at the following conditions.			The pipe length is 7.5m.			
Operation	Item	Indoor air temperature		Outdoor air temperature		Standards
		DB	WB	DB	WB	
	Cooling	27°C	19°C	35°C	24°C	
Heating	20°C	-	7°C	6°C		
(2) This air-conditioner is manufactured and tested in conformity with the ISO. (3) Sound level indicates the value in an anechoic chamber. During operation these value are somewhat higher due to ambient conditions. (4) Select the breaker size according to the own national standard. (5) When wireless remote control is used, fan is 3 speed setting (Hi-Me-Lo) only. (6) The operation data indicate when the air-conditioner is operated at 400V50Hz or 380V60Hz.						

Item		Model	FDT125VNVF		
			Indoor unit FDT125VF	Outdoor unit FDC125VN	
Power source			1 Phase 220-240V 50Hz / 220V 60Hz		
Operation data	Nominal cooling capacity (range)	kW	12.5 [5.0(Min.)~14.0(Max.)]		
	Nominal heating capacity (range)	kW	14.0 [4.0(Min.)~16.0(Max.)]		
	Power consumption	Cooling	kW	4.05	
		Heating		3.77	
	Max power consumption		5.27		
	Running current	Cooling	A	17.7 / 18.6	
		Heating		16.6 / 17.3	
	Inrush current, max current		5, 24		
	Power factor	Cooling	%	99	
		Heating		99	
	EER	Cooling		3.09	
	COP	Heating		3.71	
Sound power level	Cooling	dB(A)	68		
	Heating		72		
Sound pressure level	Cooling	dB(A)	P-Hi : 51 Hi : 42 Me : 40 Lo : 37		
	Heating		50		
Silent mode sound pressure level			51		
			Cooling : 46 / Heating : 48		
Exterior dimensions (Height × Width × Depth)		mm	Unit 298 × 840 × 840 Panel 35 × 950 × 950	845×970×370	
Exterior appearance (Munsell color)			Plaster White (6.8Y8.9/0.2) near equivalent	Stucco White (4.2Y7.5/1.1) near equivalent	
Net weight		kg	UNIT 27 PANEL 5.5	81	
Compressor type & Q'ty			—	RMT5126MDE2×1	
Compressor motor (Starting method)		kW	—	Direct line start	
Refrigerant oil (Amount, type)		ℓ	—	0.9 M-MA68	
Refrigerant (Type, amount, pre-charge length)		kg	R410A 3.8kg in outdoor unit (incl. the amount for the piping of : 30m)		
Heat exchanger			Louver fin & inner grooved tubing	Straight fin & inner grooved tubing	
Refrigerant control			Electronic expansion valve		
Fan type & Q'ty			Turbo fan ×1	Propeller fan ×1	
Fan motor (Starting method)		W	140 < Direct line start >	86 < Direct line start >	
Air flow	Cooling	m³/min	P-Hi : 37 Hi : 30 Me : 27 Lo : 23		
	Heating		75		
Available external static pressure		Pa	0		
Outside air intake			Possible		
Air filter, Quality / Quantity			Pocket plastic net ×1(Washable)		
Shock & vibration absorber			Rubber sleeve (for fan motor)		
Electric heater		W	—		
Operation control	Remote control		(option) wired : RC-EX1A, RC-E5, RCH-E3 wireless : RCN-T-36W-E		
	Room temperature control		Thermostat by electronics		
	Operation display		—		
Safety equipments			Overload protection for fan motor. Frost protection thermostat. Internal thermostat for fan motor. Abnormal discharge temperature protection.		
Installation data	Refrigerant piping size (O.D.)	mm	Liquid line: I/U φ 9.52 (3/8") Pipe φ 9.52(3/8")×0.8 O/U φ 9.52 (3/8") Gas line: φ 15.88 (5/8") φ 15.88 (5/8")×1.0 φ 15.88 (5/8")		
	Connecting method		Flare piping		
	Attached length of piping	m	—		
	Insulation for piping		Necessary (both Liquid & Gas lines)		
	Refrigerant line (one way) length	m	Max.50m		
	Vertical height diff. between O.U. and I.U.	m	Max.30m (Outdoor unit is higher) Max.15m (Outdoor unit is lower)		
Drain hose			Hose connectable with VP25 (O.D.32)	Holes size φ 20 × 3pcs	
Drain pump, max lift height		mm	Built-in Drain pump, 700		
Recommended breaker size		A	—		
L.R.A. (Locked rotor ampere)		A	5.0		
Interconnecting wires Size × Core number			φ 1.6mm×3 cores (+ earth cable 1.6mm) / Terminal block (Screw fixing type)		
IP number			IPX0 IP24		
Standard accessories			Mounting kit, Drain hose Edging		
Option parts			—		
Note (1) The data are measured at the following conditions.			The pipe length is 7.5m.		
Operation	Indoor air temperature	Outdoor air temperature		Standards	
		DB	WB		DB
	Cooling	27°C	19°C		35°C
Heating	20°C	—	7°C	6°C	
(2) This air-conditioner is manufactured and tested in conformity with the ISO. (3) Sound level indicates the value in an anechoic chamber. During operation these value are somewhat higher due to ambient conditions. (4) Select the breaker size according to the own national standard. (5) When wireless remote control is used, fan is 3 speed setting (Hi-Me-Lo) only. (6) The operation data indicate when the air-conditioner is operated at 230V50Hz or 220V60Hz.					

Item		Model	FDT125VSVF		
			Indoor unit FDT125VF	Outdoor unit FDC125VS	
Power source			3 Phase 380-415V 50Hz / 380V 60Hz		
Operation data	Nominal cooling capacity (range)	kW	12.5 [5.0(Min.)~14.0(Max.)]		
	Nominal heating capacity (range)	kW	14.0 [4.0(Min.)~16.0(Max.)]		
	Power consumption	Cooling	kW	4.05	
		Heating		3.77	
	Max power consumption		5.27		
	Running current	Cooling	A	5.9 / 6.3	
		Heating		5.5 / 5.9	
	Inrush current, max current		5, 15		
	Power factor	Cooling	%	99 / 98	
		Heating		99 / 97	
	EER	Cooling		3.09	
	COP	Heating		3.71	
Sound power level	Cooling	dB(A)	68		
	Heating		72		
Sound pressure level	Cooling	dB(A)	P-Hi : 51 Hi : 42 Me : 40 Lo : 37		
	Heating		50		
Silent mode sound pressure level			Cooling : 46 / Heating : 48		
Exterior dimensions (Height × Width × Depth)		mm	Unit 298 × 840 × 840 Panel 35 × 950 × 950	845×970×370	
Exterior appearance (Munsell color)			Plaster White (6.8Y8.9/0.2) near equivalent	Stucco White (4.2Y7.5/1.1) near equivalent	
Net weight		kg	UNIT 27 PANEL 5.5	83	
Compressor type & Q'ty			—	RMT5126MDE3×1	
Compressor motor (Starting method)		kW	—	Direct line start	
Refrigerant oil (Amount, type)		ℓ	—	0.9 M-MA68	
Refrigerant (Type, amount, pre-charge length)		kg	R410A 3.8kg in outdoor unit (incl. the amount for the piping of : 30m)		
Heat exchanger			Louver fin & inner grooved tubing	Straight fin & inner grooved tubing	
Refrigerant control			Electronic expansion valve		
Fan type & Q'ty			Turbo fan ×1	Propeller fan ×1	
Fan motor (Starting method)		W	140 < Direct line start >	86 < Direct line start >	
Air flow	Cooling	m ³ /min	P-Hi : 37 Hi : 30 Me : 27 Lo : 23		
	Heating		75		
Available external static pressure		Pa	0		
Outside air intake			Possible		
Air filter, Quality / Quantity			Pocket plastic net ×1(Washable)		
Shock & vibration absorber			Rubber sleeve (for fan motor)		
Electric heater		W	—	20 (Crank case heater)	
Operation control	Remote control		(option) wired : RC-EX1A, RC-E5, RCH-E3 wireless : RCN-T-36W-E		
	Room temperature control		Thermostat by electronics		
	Operation display		—		
Safety equipments			Overload protection for fan motor. Frost protection thermostat. Internal thermostat for fan motor. Abnormal discharge temperature protection.		
Installation data	Refrigerant piping size (O.D.)	mm	Liquid line: I/U φ 9.52 (3/8") Pipe φ 9.52(3/8")×0.8 O/U φ 9.52 (3/8") Gas line: φ 15.88 (5/8") φ 15.88 (5/8")×1.0 φ 15.88 (5/8")		
	Connecting method		Flare piping		
	Attached length of piping	m	—		
	Insulation for piping		Necessary (both Liquid & Gas lines)		
	Refrigerant line (one way) length	m	Max.50m		
	Vertical height diff. between O.U. and I.U.	m	Max.30m (Outdoor unit is higher) Max.15m (Outdoor unit is lower)		
Drain hose			Hose connectable with VP25 (O.D.32)	Holes size φ 20 × 3pcs	
Drain pump, max lift height		mm	Built-in Drain pump, 700		
Recommended breaker size		A	—		
L.R.A. (Locked rotor ampere)		A	5.0		
Interconnecting wires Size × Core number			φ 1.6mm×3 cores (+ earth cable 1.6mm) / Terminal block (Screw fixing type)		
IP number			IPX0 IP24		
Standard accessories			Mounting kit, Drain hose Edging		
Option parts			—		
Note (1) The data are measured at the following conditions.			The pipe length is 7.5m.		
Operation	Indoor air temperature	Outdoor air temperature		Standards	
		DB	WB		DB
	Cooling	27°C	19°C		35°C
Heating	20°C	—	7°C	6°C	
(2) This air-conditioner is manufactured and tested in conformity with the ISO.					
(3) Sound level indicates the value in an anechoic chamber. During operation these value are somewhat higher due to ambient conditions.					
(4) Select the breaker size according to the own national standard.					
(5) When wireless remote control is used, fan is 3 speed setting (Hi-Me-Lo) only.					
(6) The operation data indicate when the air-conditioner is operated at 400V50Hz or 380V60Hz.					

Item		Model	FDT140VNVF		
			Indoor unit FDT140VF	Outdoor unit FDC140VN	
Power source			1 Phase 220-240V 50Hz / 220V 60Hz		
Operation data	Nominal cooling capacity (range)	kW	14.0 [5.0(Min.)~14.5(Max.)]		
	Nominal heating capacity (range)	kW	16.0 [4.0(Min.)~16.5(Max.)]		
	Power consumption	Cooling	kW	4.98	
		Heating		4.57	
	Max power consumption		6.47		
	Running current	Cooling	A	22.0 / 23.0	
		Heating		20.2 / 21.2	
	Inrush current, max current		5, 24		
	Power factor	Cooling	%	98	
		Heating		98	
	EER	Cooling		2.81	
	COP	Heating		3.5	
Sound power level	Cooling	dB(A)	68		
	Heating		73		
Sound pressure level	Cooling	dB(A)	P-Hi : 51 Hi : 43 Me : 41 Lo : 38		
	Heating		51		
Silent mode sound pressure level			Cooling : 47 / Heating : 50		
Exterior dimensions (Height × Width × Depth)		mm	Unit 298 × 840 × 840 Panel 35 × 950 × 950	845×970×370	
Exterior appearance (Munsell color)			Plaster White (6.8Y8.9/0.2) near equivalent	Stucco White (4.2Y7.5/1.1) near equivalent	
Net weight		kg	UNIT 27 PANEL 5.5	81	
Compressor type & Q'ty			—	RMT5126MDE2×1	
Compressor motor (Starting method)		kW	—	Direct line start	
Refrigerant oil (Amount, type)		ℓ	—	0.9 M-MA68	
Refrigerant (Type, amount, pre-charge length)		kg	R410A 3.8kg in outdoor unit (incl. the amount for the piping of : 30m)		
Heat exchanger			Louver fin & inner grooved tubing	Straight fin & inner grooved tubing	
Refrigerant control			Electronic expansion valve		
Fan type & Q'ty			Turbo fan ×1	Propeller fan ×1	
Fan motor (Starting method)		W	140 < Direct line start >	86 < Direct line start >	
Air flow	Cooling	m³/min	P-Hi : 37 Hi : 30 Me : 27 Lo : 23		
	Heating		75		
Available external static pressure		Pa	0		
Outside air intake			Possible		
Air filter, Quality / Quantity			Pocket plastic net ×1(Washable)		
Shock & vibration absorber			Rubber sleeve (for fan motor)		
Electric heater		W	—	20 (Crank case heater)	
Operation control	Remote control		(option) wired : RC-EX1A, RC-E5, RCH-E3 wireless : RCN-T-36W-E		
	Room temperature control		Thermostat by electronics		
	Operation display		—		
Safety equipments			Overload protection for fan motor. Frost protection thermostat. Internal thermostat for fan motor. Abnormal discharge temperature protection.		
Installation data	Refrigerant piping size (O.D.)	mm	Liquid line: I/U φ 9.52 (3/8") Pipe φ 9.52(3/8")×0.8 O/U φ 9.52 (3/8") Gas line: φ 15.88 (5/8") φ 15.88 (5/8")×1.0 φ 15.88 (5/8")		
	Connecting method		Flare piping		
	Attached length of piping	m	—		
	Insulation for piping		Necessary (both Liquid & Gas lines)		
	Refrigerant line (one way) length	m	Max.50m		
	Vertical height diff. between O.U. and I.U.	m	Max.30m (Outdoor unit is higher) Max.15m (Outdoor unit is lower)		
Drain hose			Hose connectable with VP25 (O.D.32)	Holes size φ 20 × 3pcs	
Drain pump, max lift height		mm	Built-in Drain pump, 700		
Recommended breaker size		A	—		
L.R.A. (Locked rotor ampere)		A	5.0		
Interconnecting wires Size × Core number			φ 1.6mm×3 cores (+ earth cable 1.6mm) / Terminal block (Screw fixing type)		
IP number			IPX0 IP24		
Standard accessories			Mounting kit, Drain hose Edging		
Option parts			—		
Note (1) The data are measured at the following conditions.			The pipe length is 7.5m.		
Operation	Indoor air temperature	Outdoor air temperature		Standards	
		DB	WB		DB
	Cooling	27°C	19°C		35°C
Heating	20°C	—	7°C	6°C	
(2) This air-conditioner is manufactured and tested in conformity with the ISO. (3) Sound level indicates the value in an anechoic chamber. During operation these value are somewhat higher due to ambient conditions. (4) Select the breaker size according to the own national standard. (5) When wireless remote control is used, fan is 3 speed setting (Hi-Me-Lo) only. (6) The operation data indicate when the air-conditioner is operated at 230V50Hz or 220V60Hz.					

PJF000Z314 

Item		Model	FDT140VSVF			
			Indoor unit FDT140VF	Outdoor unit FDC140VS		
Power source			3 Phase 380-415V 50Hz / 380V 60Hz			
Operation data	Nominal cooling capacity (range)	kW	14.0 [5.0(Min.)~14.5(Max.)]			
	Nominal heating capacity (range)	kW	16.0 [4.0(Min.)~16.5(Max.)]			
	Power consumption	Cooling	kW	4.98		
		Heating		4.57		
	Max power consumption		6.47			
	Running current	Cooling	A	7.4 / 7.8		
		Heating		6.7 / 7.4		
	Inrush current, max current		5, 15			
	Power factor	Cooling	%	97		
		Heating		98 / 94		
	EER	Cooling		2.81		
	COP	Heating		3.5		
Sound power level	Cooling	dB(A)	68			
	Heating		73			
Sound pressure level	Cooling	dB(A)	P-Hi : 51 Hi : 43 Me : 41 Lo : 38			
	Heating		51			
Silent mode sound pressure level			Cooling : 47 / Heating : 50			
Exterior dimensions (Height × Width × Depth)		mm	Unit 298 × 840 × 840 Panel 35 × 950 × 950	845×970×370		
Exterior appearance (Munsell color)			Plaster White (6.8Y8.9/0.2) near equivalent	Stucco White (4.2Y7.5/1.1) near equivalent		
Net weight		kg	UNIT 27 PANEL 5.5	83		
Compressor type & Q'ty			—	RMT5126MDE3×1		
Compressor motor (Starting method)		kW	—	Direct line start		
Refrigerant oil (Amount, type)		ℓ	—	0.9 M-MA68		
Refrigerant (Type, amount, pre-charge length)		kg	R410A 3.8kg in outdoor unit (incl. the amount for the piping of : 30m)			
Heat exchanger			Louver fin & inner grooved tubing	Straight fin & inner grooved tubing		
Refrigerant control			Electronic expansion valve			
Fan type & Q'ty			Turbo fan ×1	Propeller fan ×1		
Fan motor (Starting method)		W	140 < Direct line start >	86 < Direct line start >		
Air flow	Cooling	m³/min	P-Hi : 37 Hi : 30 Me : 27 Lo : 23			
	Heating		75			
Available external static pressure		Pa	0			
Outside air intake			Possible			
Air filter, Quality / Quantity			Pocket plastic net ×1(Washable)			
Shock & vibration absorber			Rubber sleeve (for fan motor)			
Electric heater		W	—	20 (Crank case heater)		
Operation control	Remote control		(option) wired : RC-EX1A, RC-E5, RCH-E3 wireless : RCN-T-36W-E			
	Room temperature control		Thermostat by electronics			
	Operation display		—			
Safety equipments			Overload protection for fan motor. Frost protection thermostat. Internal thermostat for fan motor. Abnormal discharge temperature protection.			
Installation data	Refrigerant piping size (O.D.)	mm	Liquid line: I/U φ 9.52 (3/8") Pipe φ 9.52(3/8")×0.8 O/U φ 9.52 (3/8") Gas line: φ 15.88 (5/8") φ 15.88 (5/8")×1.0 φ 15.88 (5/8")			
	Connecting method		Flare piping			
	Attached length of piping	m	—			
	Insulation for piping		Necessary (both Liquid & Gas lines)			
	Refrigerant line (one way) length	m	Max.50m			
	Vertical height diff. between O.U. and I.U.	m	Max.30m (Outdoor unit is higher) Max.15m (Outdoor unit is lower)			
Drain hose			Hose connectable with VP25 (O.D.32)	Holes size φ 20 × 3pcs		
Drain pump, max lift height		mm	Built-in Drain pump, 700			
Recommended breaker size		A	—			
L.R.A. (Locked rotor ampere)		A	5.0			
Interconnecting wires Size × Core number			φ 1.6mm×3 cores (+ earth cable 1.6mm) / Terminal block (Screw fixing type)			
IP number			IPX0 IP24			
Standard accessories			Mounting kit, Drain hose Edging			
Option parts			—			
Note (1) The data are measured at the following conditions.			The pipe length is 7.5m.			
Item		Indoor air temperature		Outdoor air temperature		Standards
Operation		DB	WB	DB	WB	
	Cooling	27°C	19°C	35°C	24°C	
	Heating	20°C	—	7°C	6°C	
						ISO5151-T1
(2) This air-conditioner is manufactured and tested in conformity with the ISO.						
(3) Sound level indicates the value in an anechoic chamber. During operation these value are somewhat higher due to ambient conditions.						
(4) Select the breaker size according to the own national standard.						
(5) When wireless remote control is used, fan is 3 speed setting (Hi-Me-Lo) only.						
(6) The operation data indicate when the air-conditioner is operated at 400V50Hz or 380V60Hz.						

(b) Twin type

Item		Model	FDT100VNPVF		
			Indoor unit FDT50VF (2 units)	Outdoor unit FDC100VN	
Power source			1 Phase 220-240V 50Hz / 220V 60Hz		
Operation data	Nominal cooling capacity (range)	kW	10.0 [4.0(Min.)~11.2(Max.)]		
	Nominal heating capacity (range)	kW	11.2 [4.0(Min.)~12.5(Max.)]		
	Power consumption	Cooling	kW	2.94	
		Heating		3.09	
	Max power consumption		4.33		
	Running current	Cooling	A	12.9 / 13.7	
		Heating		13.6 / 14.2	
	Inrush current, max current		5, 24		
	Power factor	Cooling	%	99 / 98	
		Heating		99	
	EER	Cooling	3.40		
	COP	Heating	3.62		
	Sound power level	Cooling	dB(A)	55	
Heating		70			
Sound pressure level	Cooling	dB(A)	P-Hi : 39 Hi : 33 Me : 31 Lo : 30		
	Heating		49		
Silent mode sound pressure level		—			
Exterior dimensions (Height × Width × Depth)		mm	Unit 246 × 840 × 840 Panel 35 × 950 × 950	845×970×370	
Exterior appearance (Munsell color)			Plaster White (6.8Y8.9/0.2) near equivalent	Stucco White (4.2Y7.5/1.1) near equivalent	
Net weight		kg	UNIT 22 PANEL 5.5	81	
Compressor type & Q'ty			—	RMT5126MDE2×1	
Compressor motor (Starting method)		kW	—	Direct line start	
Refrigerant oil (Amount, type)		ℓ	—	0.9 M-MA68	
Refrigerant (Type, amount, pre-charge length)		kg	R410A 3.8kg (Pre-charged up to the piping length of 30m) Outdoor unit		
Heat exchanger			Louver fin & inner grooved tubing	Straight fin & inner grooved tubing	
Refrigerant control			Electronic expansion valve		
Fan type & Q'ty			Turbo fan ×1	Propeller fan ×1	
Fan motor (Starting method)		W	50 < Direct line start >	86 < Direct line start >	
Air flow	Cooling	m ³ /min	P-Hi : 20 Hi : 18 Me : 16 Lo : 14		
	Heating		75 73		
Available external static pressure		Pa	0		
Outside air intake			Possible		
Air filter, Quality / Quantity			Pocket plastic net ×1(Washable)		
Shock & vibration absorber			Rubber sleeve (for fan motor) Rubber sleeve (for compressor)		
Electric heater		W	—		
Operation control	Remote control		(option) wired : RC-EX1A, RC-E5, RCH-E3 wireless : RCN-T-36W-E		
	Room temperature control		Thermostat by electronics		
	Operation display		—		
Safety equipments			Overload protection for fan motor. Frost protection thermostat. Internal thermostat for fan motor. Abnormal discharge temperature protection.		
Installation data	Refrigerant piping size (O.D.)	mm	Liquid line: I/U φ 6.35 (1/4") ② φ 9.52 (3/8")×0.8 ① φ 9.52 (3/8")×0.8 O/U φ 9.52 (3/8") Gas line: I/U φ 12.7 (1/2") ② φ 12.7 (1/2")×0.8 ① φ 15.88 (5/8")×1.0 O/U φ 15.88 (5/8")		
	Connecting method		Flare piping		
	Attached length of piping	m	—		
	Insulation for piping		Necessary (both Liquid & Gas lines)		
	Refrigerant line (one way) length	m	Max.50m		
	Vertical height diff. between O.U. and I.U.	m	Max.30m (Outdoor unit is higher) Max.15m (Outdoor unit is lower)		
Drain hose		Hose connectable with VP25 (O.D.32) Holes size φ 20 × 3pcs			
Drain pump, max lift height	mm	Built-in Drain pump, 700			
Recommended breaker size	A	—			
L.R.A. (Locked rotor ampere)	A	5.0			
Interconnecting wires	Size × Core number	φ 1.6mm×3 cores (+ earth cable 1.6mm) / Terminal block (Screw fixing type)			
IP number		IPX0 IP24			
Standard accessories		Mounting kit, Drain hose Edging			
Option parts		—			

Note (1) The data are measured at the following conditions. The pipe length is 7.5m.

Operation	Indoor air temperature		Outdoor air temperature		Standards
	DB	WB	DB	WB	
Cooling	27°C	19°C	35°C	24°C	ISO5151-T1
Heating	20°C	—	7°C	6°C	

- (2) This air-conditioner is manufactured and tested in conformity with the ISO.
- (3) Sound level indicates the value in an anechoic chamber. During operation these value are somewhat higher due to ambient conditions.
- (4) Select the breaker size according to the own national standard.
- (5) When wireless remote control is used, fan is 3 speed setting (Hi-Me-Lo) only.
- (6) The operation data indicates when the air-conditioner is operated at 230V50Hz or 220V60Hz.
- (7) Indoor unit specification for one unit. Capacity and operation data are two indoor units are combined and run together.
- (8) Branching pipe set "DIS-WA1"×1(option). ① : Pipe of O/U~Branch, ② : Pipe of Branch~I/U

Item		Model	FDT100VSPVF			
			Indoor unit FDT50VF (2 units)	Outdoor unit FDC100VS		
Power source			3 Phase 380-415V 50Hz / 380V 60Hz			
Operation data	Nominal cooling capacity (range)	kW	10.0 [4.0(Min.)~11.2(Max.)]			
	Nominal heating capacity (range)	kW	11.2 [4.0(Min.)~12.5(Max.)]			
	Power consumption	Cooling	kW	2.94		
		Heating		3.09		
	Max power consumption		4.33			
	Running current	Cooling	A	4.3 / 4.6		
		Heating		4.5 / 4.8		
	Inrush current, max current		5, 15			
	Power factor	Cooling	%	99 / 97		
		Heating		99 / 98		
	EER	Cooling		3.4		
	COP	Heating		3.62		
Sound power level	Cooling	dB(A)	55			
	Heating		70			
Sound pressure level	Cooling	dB(A)	P-Hi : 39 Hi : 33 Me : 31 Lo : 30			
	Heating		49			
Silent mode sound pressure level			Cooling : 46 / Heating : 46			
Exterior dimensions (Height × Width × Depth)		mm	Unit 246 × 840 × 840 Panel 35 × 950 × 950			
Exterior appearance (Munsell color)			Plaster White (6.8Y8.9/0.2) near equivalent Stucco White (4.2Y7.5/1.1) near equivalent			
Net weight		kg	UNIT 22 PANEL 5.5 83			
Compressor type & Q'ty			— RMT5126MDE3×1			
Compressor motor (Starting method)		kW	— Direct line start			
Refrigerant oil (Amount, type)		ℓ	— 0.9 M-MA68			
Refrigerant (Type, amount, pre-charge length)		kg	R410A 3.8kg (Pre-charged up to the piping length of 30m) Outdoor unit			
Heat exchanger			Louver fin & inner grooved tubing Straight fin & inner grooved tubing			
Refrigerant control			Electronic expansion valve			
Fan type & Q'ty			Turbo fan ×1 Propeller fan ×1			
Fan motor (Starting method)		W	50 < Direct line start > 86 < Direct line start >			
Air flow	Cooling	m³/min	P-Hi : 20 Hi : 18 Me : 16 Lo : 14			
	Heating		75 73			
Available external static pressure		Pa	0 —			
Outside air intake			Possible —			
Air filter, Quality / Quantity			Pocket plastic net ×1(Washable) —			
Shock & vibration absorber			Rubber sleeve (for fan motor) Rubber sleeve (for compressor)			
Electric heater		W	— 20 (Crank case heater)			
Operation control	Remote control		(option) wired : RC-EX1A, RC-E5, RCH-E3 wireless : RCN-T-36W-E			
	Room temperature control		Thermostat by electronics			
	Operation display		—			
Safety equipments			Overload protection for fan motor. Frost protection thermostat. Internal thermostat for fan motor. Abnormal discharge temperature protection.			
Installation data	Refrigerant piping size (O.D.)	mm	Liquid line: I/U φ 6.35 (1/4") ② φ 9.52 (3/8")×0.8 ① φ 9.52 (3/8")×0.8 O/U φ 9.52 (3/8") Gas line: I/U φ 12.7 (1/2") ② φ 12.7 (1/2")×0.8 ① φ 15.88 (5/8")×1.0 O/U φ 15.88 (5/8")			
	Connecting method		Flare piping Flare piping			
	Attached length of piping	m	— —			
	Insulation for piping		Necessary (both Liquid & Gas lines)			
	Refrigerant line (one way) length	m	Max.50m			
	Vertical height diff. between O.U. and I.U.	m	Max.30m (Outdoor unit is higher) Max.15m (Outdoor unit is lower)			
	Drain hose		Hose connectable with VP25 (O.D.32) Holes size φ 20 × 3pcs			
Drain pump, max lift height		mm	Built-in Drain pump, 700 —			
Recommended breaker size		A	—			
L.R.A. (Locked rotor ampere)		A	5.0			
Interconnecting wires Size × Core number			φ 1.6mm×3 cores (+ earth cable 1.6mm) / Terminal block (Screw fixing type)			
IP number			IPX0 IP24			
Standard accessories			Mounting kit, Drain hose Edging			
Option parts			—			
Note (1) The data are measured at the following conditions.			The pipe length is 7.5m.			
	Item	Indoor air temperature		Outdoor air temperature		Standards ISO5151-T1
Operation		DB	WB	DB	WB	
	Cooling	27°C	19°C	35°C	24°C	
	Heating	20°C	—	7°C	6°C	
(2) This air-conditioner is manufactured and tested in conformity with the ISO. (3) Sound level indicates the value in an anechoic chamber. During operation these value are somewhat higher due to ambient conditions. (4) Select the breaker size according to the own national standard. (5) When wireless remote control is used, fan is 3 speed setting (Hi-Me-Lo) only. (6) The operation data indicate when the air-conditioner is operated at 400V50Hz or 380V60Hz. (7) Indoor unit specifications for one unit. Capacity and operation data are two indoor units are combined and run together. (8) Branching pipe set "DIS-WA1"×1(option). ① : Pipe of O/U~Branch, ② : Pipe of Branch~I/U						

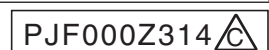

Item		Model	FDT125VNPVF			
			Indoor unit FDT60VF (2 units)	Outdoor unit FDC125VN		
Power source			1 Phase 220-240V 50Hz / 220V 60Hz			
Operation data	Nominal cooling capacity (range)	kW	12.5 [5.0(Min.)~14.0(Max.)]			
	Nominal heating capacity (range)	kW	14.0 [4.0(Min.)~16.0(Max.)]			
	Power consumption	Cooling	kW	3.95		
		Heating		3.70		
	Max power consumption		5.14			
	Running current	Cooling	A	17.7 / 18.5		
		Heating		16.6 / 17.3		
	Inrush current, max current		5, 24			
	Power factor	Cooling	%	97		
		Heating		97		
	EER	Cooling	3.16			
	COP	Heating	3.78			
	Sound power level	Cooling	dB(A)	60		
Heating		72				
Sound pressure level	Cooling	dB(A)	P-Hi : 46 Hi : 33 Me : 31 Lo : 30			
	Heating		50			
Silent mode sound pressure level		—				
			Cooling : 46 / Heating : 48			
Exterior dimensions (Height × Width × Depth)		mm	Unit 246 × 840 × 840 Panel 35 × 950 × 950	845×970×370		
Exterior appearance (Munsell color)			Plaster White (6.8Y8.9/0.2) near equivalent	Stucco White (4.2Y7.5/1.1) near equivalent		
Net weight		kg	UNIT 24 PANEL 5.5	81		
Compressor type & Q'ty			—	RMT5126MDE2×1		
Compressor motor (Starting method)		kW	—	Direct line start		
Refrigerant oil (Amount, type)		ℓ	—	0.9 M-MA68		
Refrigerant (Type, amount, pre-charge length)		kg	R410A 3.8kg (Pre-charged up to the piping length of 30m) Outdoor unit			
Heat exchanger			Louver fin & inner grooved tubing	Straight fin & inner grooved tubing		
Refrigerant control			Electronic expansion valve			
Fan type & Q'ty			Turbo fan ×1	Propeller fan ×1		
Fan motor (Starting method)		W	50 < Direct line start >	86 < Direct line start >		
Air flow	Cooling	m³/min	P-Hi : 28 Hi : 18 Me : 16 Lo : 14			
	Heating		75			
Available external static pressure		Pa	0			
Outside air intake			Possible			
Air filter, Quality / Quantity			Pocket plastic net ×1(Washable)			
Shock & vibration absorber			Rubber sleeve (for fan motor)			
Electric heater		W	—	20 (Crank case heater)		
Operation control	Remote control		(option) wired : RC-EX1A, RC-E5, RCH-E3 wireless : RCN-T-36W-E			
	Room temperature control		Thermostat by electronics			
	Operation display		—			
Safety equipments			Overload protection for fan motor. Frost protection thermostat. Internal thermostat for fan motor. Abnormal discharge temperature protection.			
Installation data	Refrigerant piping size (O.D.)	mm	Liquid line: I/U φ 6.35 (1/4") ② φ 9.52 (3/8")×0.8 ① φ 9.52 (3/8")×0.8 O/U φ 9.52 (3/8") Gas line: I/U φ 12.7 (1/2") ② φ 12.7 (1/2")×0.8 ① φ 15.88 (5/8")×1.0 O/U φ 15.88 (5/8")			
	Connecting method		Flare piping			
	Attached length of piping	m	—			
	Insulation for piping		Necessary (both Liquid & Gas lines)			
	Refrigerant line (one way) length	m	Max.50m			
	Vertical height diff. between O.U. and I.U.	m	Max.30m (Outdoor unit is higher) Max.15m (Outdoor unit is lower)			
	Drain hose		Hose connectable with VP25 (O.D.32) Holes size φ 20 × 3pcs			
Drain pump, max lift height		mm	Built-in Drain pump, 700			
Recommended breaker size		A	—			
L.R.A. (Locked rotor ampere)		A	5.0			
Interconnecting wires Size × Core number			φ 1.6mm×3 cores (+ earth cable 1.6mm) / Terminal block (Screw fixing type)			
IP number			IPX0 IP24			
Standard accessories			Mounting kit, Drain hose Edging			
Option parts			—			
Note (1) The data are measured at the following conditions.			The pipe length is 7.5m.			
	Item	Indoor air temperature		Outdoor air temperature		Standards ISO5151-T1
Operation		DB	WB	DB	WB	
	Cooling	27°C	19°C	35°C	24°C	
	Heating	20°C	—	7°C	6°C	
(2) This air-conditioner is manufactured and tested in conformity with the ISO. (3) Sound level indicates the value in an anechoic chamber. During operation these value are somewhat higher due to ambient conditions. (4) Select the breaker size according to the own national standard. (5) When wireless remote control is used, fan is 3 speed setting (Hi-Me-Lo) only. (6) The operation data indicate when the air-conditioner is operated at 230V50Hz or 220V60Hz. (7) Indoor unit specifications for one unit. Capacity and operation data are two indoor units are combined and run together. (8) Branching pipe set "DIS-WA1"×1(option). ① : Pipe of O/U~Branch, ② : Pipe of Branch~I/U						

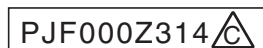

Item		Model	FDT125VSPVF		
			Indoor unit FDT60VF (2 units)	Outdoor unit FDC125VS	
Power source			3 Phase 380-415V 50Hz / 380V 60Hz		
Operation data	Nominal cooling capacity (range)	kW	12.5 [5.0(Min.)~14.0(Max.)]		
	Nominal heating capacity (range)	kW	14.0 [4.0(Min.)~16.0(Max.)]		
	Power consumption	Cooling	kW	3.95	
		Heating		3.70	
	Max power consumption		5.14		
	Running current	Cooling	A	5.9 / 6.2	
		Heating		5.5 / 5.8	
	Inrush current, max current		5, 15		
	Power factor	Cooling	%	97	
		Heating		97	
	EER	Cooling		3.16	
	COP	Heating		3.78	
	Sound power level	Cooling	dB(A)	60	
Heating		72			
Sound pressure level	Cooling	dB(A)	P-Hi : 46 Hi : 33 Me : 31 Lo : 30		
	Heating		50		
Silent mode sound pressure level			51		
			Cooling : 46 / Heating : 48		
Exterior dimensions (Height × Width × Depth)		mm	Unit 246 × 840 × 840 Panel 35 × 950 × 950	845×970×370	
Exterior appearance (Munsell color)			Plaster White (6.8Y8.9/0.2) near equivalent	Stucco White (4.2Y7.5/1.1) near equivalent	
Net weight		kg	UNIT 24 PANEL 5.5	83	
Compressor type & Q'ty			—	RMT5126MDE3×1	
Compressor motor (Starting method)		kW	—	Direct line start	
Refrigerant oil (Amount, type)		ℓ	—	0.9 M-MA68	
Refrigerant (Type, amount, pre-charge length)		kg	R410A 3.8kg (Pre-charged up to the piping length of 30m) Outdoor unit		
Heat exchanger			Louver fin & inner grooved tubing	Straight fin & inner grooved tubing	
Refrigerant control			Electronic expansion valve		
Fan type & Q'ty			Turbo fan ×1	Propeller fan ×1	
Fan motor (Starting method)		W	50 < Direct line start >	86 < Direct line start >	
Air flow	Cooling	m ³ /min	P-Hi : 28 Hi : 18 Me : 16 Lo : 14		
	Heating		75		
Available external static pressure		Pa	0		
Outside air intake			Possible		
Air filter, Quality / Quantity			Pocket plastic net ×1(Washable)		
Shock & vibration absorber			Rubber sleeve (for fan motor)		
Electric heater		W	—	Rubber sleeve (for compressor) 20 (Crank case heater)	
Operation control	Remote control		(option) wired : RC-EX1A, RC-E5, RCH-E3 wireless : RCN-T-36W-E		
	Room temperature control		Thermostat by electronics		
	Operation display		—		
Safety equipments			Overload protection for fan motor. Frost protection thermostat. Internal thermostat for fan motor. Abnormal discharge temperature protection.		
Installation data	Refrigerant piping size (O.D.)	mm	Liquid line: I/U φ 6.35 (1/4") ② φ 9.52 (3/8")×0.8 ① φ 9.52 (3/8")×0.8 O/U φ 9.52 (3/8") Gas line: I/U φ 12.7 (1/2") ② φ 12.7 (1/2")×0.8 ① φ 15.88 (5/8")×1.0 O/U φ 15.88 (5/8")		
	Connecting method		Flare piping		
	Attached length of piping	m	—		
	Insulation for piping		Necessary (both Liquid & Gas lines)		
	Refrigerant line (one way) length	m	Max.50m		
	Vertical height diff. between O.U. and I.U.	m	Max.30m (Outdoor unit is higher) Max.15m (Outdoor unit is lower)		
Drain hose			Hose connectable with VP25 (O.D.32)	Holes size φ 20 × 3pcs	
Drain pump, max lift height	mm	Built-in Drain pump, 700		—	
Recommended breaker size	A	—		—	
L.R.A. (Locked rotor ampere)	A	—		5.0	
Interconnecting wires Size × Core number		φ 1.6mm×3 cores (+ earth cable 1.6mm) / Terminal block (Screw fixing type)			
IP number		IPX0		IP24	
Standard accessories		Mounting kit, Drain hose		Edging	
Option parts		—		—	
Note (1) The data are measured at the following conditions.			The pipe length is 7.5m.		
	Item	Indoor air temperature	Outdoor air temperature		Standards ISO5151-T1
Operation		DB	DB	WB	
	Cooling	27°C	35°C	24°C	
	Heating	20°C	7°C	6°C	
<p>(2) This air-conditioner is manufactured and tested in conformity with the ISO.</p> <p>(3) Sound level indicates the value in an anechoic chamber. During operation these value are somewhat higher due to ambient conditions.</p> <p>(4) Select the breaker size according to the own national standard.</p> <p>(5) When wireless remote control is used, fan is 3 speed setting (Hi-Me-Lo) only.</p> <p>(6) The operation data indicate when the air-conditioner is operated at 400V50Hz or 380V60Hz.</p> <p>(7) Indoor unit specifications for one unit. Capacity and operation data are two indoor units are combined and run together.</p> <p>(8) Branching pipe set "DIS-WA1"×1(option). ① : Pipe of O/U~Branch, ② : Pipe of Branch~I/U</p>					

Item		Model	FDT140VNPVF1		
			Indoor unit FDT71VF1 (2 units)	Outdoor unit FDC140VN	
Power source			1 Phase 220-240V 50Hz / 220V 60Hz		
Operation data	Nominal cooling capacity (range)	kW	14.0 [5.0(Min.)~14.5(Max.)]		
	Nominal heating capacity (range)	kW	16.0 [4.0(Min.)~16.5(Max.)]		
	Power consumption	Cooling	kW	4.51	
		Heating		4.58	
	Max power consumption		5.95		
	Running current	Cooling	A	19.8 / 20.7	
		Heating		20.1 / 21.0	
	Inrush current, max current		5, 24		
	Power factor	Cooling	%	99	
		Heating		99	
	EER	Cooling		3.1	
	COP	Heating		3.49	
Sound power level	Cooling	dB(A)	64		
	Heating		73		
Sound pressure level	Cooling	dB(A)	P-Hi : 46 Hi : 35 Me : 36 Lo : 31		
	Heating		51		
Silent mode sound pressure level			Cooling : 47 / Heating : 50		
Exterior dimensions (Height × Width × Depth)		mm	Unit 246 × 840 × 840 Panel 35 × 950 × 950	845×970×370	
Exterior appearance (Munsell color)			Plaster White (6.8Y8.9/0.2) near equivalent	Stucco White (4.2Y7.5/1.1) near equivalent	
Net weight		kg	UNIT 24 PANEL 5.5	81	
Compressor type & Q'ty			—	RMT5126MDE2×1	
Compressor motor (Starting method)		kW	—	Direct line start	
Refrigerant oil (Amount, type)		ℓ	—	0.9 M-MA68	
Refrigerant (Type, amount, pre-charge length)		kg	R410A 3.8kg (Pre-charged up to the piping length of 30m) Outdoor unit		
Heat exchanger			Louver fin & inner grooved tubing	Straight fin & inner grooved tubing	
Refrigerant control			Electronic expansion valve		
Fan type & Q'ty			Turbo fan ×1	Propeller fan ×1	
Fan motor (Starting method)		W	50 < Direct line start >	86 < Direct line start >	
Air flow	Cooling	m³/min	P-Hi : 28 Hi : 21 Me : 19 Lo : 17		
	Heating		75		
Available external static pressure		Pa	0		
Outside air intake			Possible		
Air filter, Quality / Quantity			Pocket plastic net ×1(Washable)		
Shock & vibration absorber			Rubber sleeve (for fan motor)		
Electric heater		W	—	20 (Crank case heater)	
Operation control	Remote control		(option) wired : RC-EX1A, RC-E5, RCH-E3 wireless : RCN-T-36W-E		
	Room temperature control		Thermostat by electronics		
	Operation display		—		
Safety equipments			Overload protection for fan motor. Frost protection thermostat. Internal thermostat for fan motor. Abnormal discharge temperature protection.		
Installation data	Refrigerant piping size (O.D.)	mm	Liquid line: I/U φ 9.52 (3/8") ② φ 9.52 (3/8")×0.8 ① φ 9.52 (3/8")×0.8 O/U φ 9.52 (3/8") Gas line: I/U φ 15.88 (5/8") ② φ 15.88 (5/8")×1.0 ① φ 15.88 (5/8")×1.0 O/U φ 15.88 (5/8")		
	Connecting method		Flare piping		
	Attached length of piping	m	—		
	Insulation for piping		Necessary (both Liquid & Gas lines)		
	Refrigerant line (one way) length	m	Max.50m		
	Vertical height diff. between O.U. and I.U.	m	Max.30m (Outdoor unit is higher) Max.15m (Outdoor unit is lower)		
Drain hose			Hose connectable with VP25 (O.D.32)	Holes size φ 20 × 3pcs	
Drain pump, max lift height	mm	Built-in Drain pump, 700		—	
Recommended breaker size	A	—		—	
L.R.A. (Locked rotor ampere)	A	—		5.0	
Interconnecting wires	Size × Core number	φ 1.6mm×3 cores (+ earth cable 1.6mm) / Terminal block (Screw fixing type)			
IP number		IPX0		IP24	
Standard accessories		Mounting kit, Drain hose		Edging	
Option parts			—		
Note (1) The data are measured at the following conditions.			The pipe length is 7.5m.		
Operation	Indoor air temperature	Outdoor air temperature		Standards	
		DB	WB		DB
	Cooling	27°C	19°C		35°C
Heating	20°C	—	7°C	6°C	
(2) (2) This air-conditioner is manufactured and tested in conformity with the ISO.					
(3) Sound level indicates the value in an anechoic chamber. During operation these value are somewhat higher due to ambient conditions.					
(4) Select the breaker size according to the own national standard.					
(5) When wireless remote control is used, fan is 3 speed setting (Hi-Me-Lo) only.					
(6) The operation data indicate when the air-conditioner is operated at 230V/50Hz or 220V/60Hz.					
(7) Indoor unit specifications for one unit. Capacity and operation data are two indoor units are combined and run together.					
(8) Branching pipe set "DIS-WA1"×1(option). ① : Pipe of O/U~Branch, ② : Pipe of Branch~I/U					

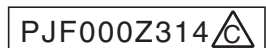

Item		Model	FDT140VSPVF1		
			Indoor unit FDT71VF1 (2 units)	Outdoor unit FDC140VS	
Power source			3 Phase 380-415V 50Hz / 380V 60Hz		
Operation data	Nominal cooling capacity (range)	kW	14.0 [5.0(Min.)~14.5(Max.)]		
	Nominal heating capacity (range)	kW	16.0 [4.0(Min.)~16.5(Max.)]		
	Power consumption	Cooling	kW	4.51	
		Heating		4.58	
	Max power consumption		5.95		
	Running current	Cooling	A	6.7 / 7.1	
		Heating		6.7 / 7.1	
	Inrush current, max current		5, 15		
	Power factor	Cooling	%	97	
		Heating		99 / 98	
	EER	Cooling		3.1	
	COP	Heating		3.49	
Sound power level	Cooling	dB(A)	64		
	Heating		73		
Sound pressure level	Cooling	dB(A)	P-Hi : 46 Hi : 35 Me : 33 Lo : 31		
	Heating		51		
Silent mode sound pressure level			Cooling : 47 / Heating : 50		
Exterior dimensions (Height × Width × Depth)		mm	Unit 246 × 840 × 840 Panel 35 × 950 × 950	845×970×370	
Exterior appearance (Munsell color)			Plaster White (6.8Y8.9/0.2) near equivalent	Stucco White (4.2Y7.5/1.1) near equivalent	
Net weight		kg	UNIT 24 PANEL 5.5	83	
Compressor type & Q'ty			—	RMT5126MDE3×1	
Compressor motor (Starting method)		kW	—	Direct line start	
Refrigerant oil (Amount, type)		ℓ	—	0.9 M-MA68	
Refrigerant (Type, amount, pre-charge length)		kg	R410A 3.8kg (Pre-charged up to the piping length of 30m) Outdoor unit		
Heat exchanger			Louver fin & inner grooved tubing	Straight fin & inner grooved tubing	
Refrigerant control			Electronic expansion valve		
Fan type & Q'ty			Turbo fan ×1	Propeller fan ×1	
Fan motor (Starting method)		W	50 < Direct line start >	86 < Direct line start >	
Air flow	Cooling	m³/min	P-Hi : 28 Hi : 21 Me : 19 Lo : 17		
	Heating		75		
Available external static pressure		Pa	0		
Outside air intake			Possible		
Air filter, Quality / Quantity			Pocket plastic net ×1(Washable)		
Shock & vibration absorber			Rubber sleeve (for fan motor)		
Electric heater		W	—	20 (Crank case heater)	
Operation control	Remote control		(option) wired : RC-EX1A, RC-E5, RCH-E3 wireless : RCN-T-36W-E		
	Room temperature control		Thermostat by electronics		
	Operation display		—		
Safety equipments			Overload protection for fan motor. Frost protection thermostat. Internal thermostat for fan motor. Abnormal discharge temperature protection.		
Installation data	Refrigerant piping size (O.D.)	mm	Liquid line: I/U φ 9.52 (3/8") ② φ 9.52 (3/8")×0.8 ① φ 9.52 (3/8")×0.8 O/U φ 9.52 (3/8") Gas line: I/U φ 15.88 (5/8") ② φ 15.88 (5/8")×1.0 ① φ 15.88 (5/8")×1.0 O/U φ 15.88 (5/8")		
	Connecting method		Flare piping		
	Attached length of piping	m	—		
	Insulation for piping		Necessary (both Liquid & Gas lines)		
	Refrigerant line (one way) length	m	Max.50m		
	Vertical height diff. between O.U. and I.U.	m	Max.30m (Outdoor unit is higher) Max.15m (Outdoor unit is lower)		
Drain hose			Hose connectable with VP25 (O.D.32)	Holes size φ 20 × 3pcs	
Drain pump, max lift height		mm	Built-in Drain pump, 700		
Recommended breaker size		A	—		
L.R.A. (Locked rotor ampere)		A	5.0		
Interconnecting wires Size × Core number			φ 1.6mm×3 cores (+ earth cable 1.6mm) / Terminal block (Screw fixing type)		
IP number			IPX0 IP24		
Standard accessories			Mounting kit, Drain hose Edging		
Option parts			—		
Note (1) The data are measured at the following conditions.			The pipe length is 7.5m.		
Item		Indoor air temperature	Outdoor air temperature		Standards ISO5151-T1
Operation		DB	DB	WB	
	Cooling	27°C	19°C	35°C	
	Heating	20°C	—	7°C	
(2) This air-conditioner is manufactured and tested in conformity with the ISO. (3) Sound level indicates the value in an anechoic chamber. During operation these value are somewhat higher due to ambient conditions. (4) Select the breaker size according to the own national standard. (5) When wireless remote control is used, fan is 3 speed setting (Hi-Me-Lo) only. (6) The operation data indicate when the air-conditioner is operated at 400V50Hz or 380V60Hz. (7) Indoor unit specifications for one unit. Capacity and operation data are two indoor units are combined and run together. (8) Branching pipe set "DIS-WA1"×1(option). ① : Pipe of O/U~Branch, ② : Pipe of Branch~I/U					

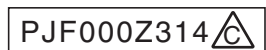

Item		Model	FDT200VSPVF1		
			Indoor unit FDT100VF1 (2 units)	Outdoor unit FDC200VS	
Power source			3 Phase 380-415V 50Hz / 380V 60Hz		
Operation data	Nominal cooling capacity (range)	kW	20.0 [7.0(Min.)~22.4(Max.)]		
	Nominal heating capacity (range)	kW	22.4 [7.6(Min.)~25.0(Max.)]		
	Power consumption	Cooling	kW	6.58	
		Heating		6.02	
	Max power consumption		8.36		
	Running current	Cooling	A	9.9 / 10.6	
		Heating		9.1 / 9.8	
	Inrush current, max current		5, 19		
	Power factor	Cooling	%	96 / 94	
		Heating		95 / 93	
	EER	Cooling		3.04	
	COP	Heating		3.72	
Sound power level	Cooling	dB(A)	65		
	Heating		74		
Sound pressure level	Cooling	dB(A)	P-Hi : 51 Hi : 40 Me : 37 Lo : 35		
	Heating		57		
Silent mode sound pressure level			Cooling : 56 / Heating : 56		
Exterior dimensions (Height × Width × Depth)		mm	Unit 298 × 840 × 840 Panel 35 × 950 × 950		
Exterior appearance (Munsell color)			Plaster White (6.8Y8.9/0.2) near equivalent Stucco White (4.2Y7.5/1.1) near equivalent		
Net weight		kg	UNIT 27 PANEL 5.5 122		
Compressor type & Q'ty			— GTC5150ND70K×1		
Compressor motor (Starting method)		kW	— Direct line start		
Refrigerant oil (Amount, type)		ℓ	— 1.45 M-MA32R		
Refrigerant (Type, amount, pre-charge length)		kg	R410A 5.4kg (Pre-charged up to the piping length of 30m) Outdoor unit		
Heat exchanger			Louver fin & inner grooved tubing Straight fin & inner grooved tubing		
Refrigerant control			Electronic expansion valve		
Fan type & Q'ty			Turbo fan ×1 Propeller fan ×2		
Fan motor (Starting method)		W	140 < Direct line start > 86 × 2 < Direct line start >		
Air flow	Cooling	m³/min	P-Hi : 37 Hi : 27 Me : 24 Lo : 20		
	Heating		150 145		
Available external static pressure		Pa	0 —		
Outside air intake			Possible —		
Air filter, Quality / Quantity			Pocket plastic net ×1(Washable) —		
Shock & vibration absorber			Rubber sleeve (for fan motor) Rubber sleeve (for compressor)		
Electric heater		W	— 33 (Crank case heater)		
Operation control	Remote control		(option) wired : RC-EX1A, RC-E5, RCH-E3 wireless : RCN-T-36W-E		
	Room temperature control		Thermostat by electronics		
	Operation display		—		
Safety equipments			Overload protection for fan motor. Frost protection thermostat. Internal thermostat for fan motor. Abnormal discharge temperature protection.		
Installation data	Refrigerant piping size (O.D.)	mm	Liquid line: I/U φ 9.52 (3/8") ② φ 9.52 (3/8")×0.8 ① φ 9.52 (3/8")×0.8 O/U φ 9.52 (3/8") Gas line: I/U φ 15.88 (5/8") ② φ 15.88 (5/8")×1.0 ① φ 22.22 (7/8")×1.6 O/U φ 22.22 (7/8")		
	Connecting method		Flare piping Liquid : Flare / Gas : Brazing		
	Attached length of piping	m	— —		
	Insulation for piping		Necessary (both Liquid & Gas lines)		
	Refrigerant line (one way) length	m	Max.70m		
	Vertical height diff. between O.U. and I.U.	m	Max.30m (Outdoor unit is higher) Max.15m (Outdoor unit is lower)		
	Drain hose		Hose connectable with VP25 (O.D.32) Holes size φ 20 × 3pcs		
Drain pump, max lift height		mm	Built-in Drain pump, 700 —		
Recommended breaker size		A	—		
L.R.A. (Locked rotor ampere)		A	5.0		
Interconnecting wires Size × Core number			φ 1.6mm×3 cores (+ earth cable 1.6mm) / Terminal block (Screw fixing type)		
IP number			IPX0 IP24		
Standard accessories			Mounting kit, Drain hose Connecting pipe, Edging		
Option parts			—		
Note (1) The data are measured at the following conditions.			The pipe length is 7.5m.		
Operation	Indoor air temperature	Outdoor air temperature		Standards	
		DB	WB		DB
	Cooling	27°C	19°C		35°C
Heating	20°C	—	7°C	6°C	
(2) This air-conditioner is manufactured and tested in conformity with the ISO.					
(3) Sound level indicates the value in an anechoic chamber. During operation these value are somewhat higher due to ambient conditions.					
(4) Select the breaker size according to the own national standard.					
(5) When wireless remote control is used, fan is 3 speed setting (Hi-Me-Lo) only.					
(6) The operation data indicate when the air-conditioner is operated at 400V50Hz or 380V60Hz.					
(7) Indoor unit specifications for one unit. Capacity and operation data are two indoor units are combined and run together.					
(8) Branching pipe set "DIS-WA1"×1(option). ① : Pipe of O/U~Branch, ② : Pipe of Branch~I/U					

PJF000Z314 

Item		Model	FDT250VSPVF																						
			Indoor unit FDT125VF (2 units)	Outdoor unit FDC250VS																					
Power source			3 Phase 380-415V 50Hz / 380V 60Hz																						
Operation data	Nominal cooling capacity (range)	kW	25.0 [10.0(Min.)~28.0(Max.)]																						
	Nominal heating capacity (range)	kW	28.0 [9.5(Min.)~31.5(Max.)]																						
	Power consumption	Cooling	kW	8.30																					
		Heating		7.75																					
	Max power consumption		9.96																						
	Running current	Cooling	A	12.4 / 13.0																					
		Heating		11.8 / 12.3																					
	Inrush current, max current			5, 22																					
	Power factor	Cooling	%	97																					
		Heating		95 / 96																					
	EER	Cooling		3.01																					
	COP	Heating		3.61																					
Sound power level	Cooling	dB(A)	68																						
	Heating		74																						
Sound pressure level	Cooling	dB(A)	P-Hi : 51 Hi : 42 Me : 40 Lo : 37																						
	Heating		57																						
Silent mode sound pressure level			Cooling : 56 / Heating : 57																						
Exterior dimensions (Height × Width × Depth)		mm	Unit 298 × 840 × 840 Panel 35 × 950 × 950	1,505×970×370																					
Exterior appearance (Munsell color)			Plaster White (6.8Y8.9/0.2) near equivalent	Stucco White (4.2Y7.5/1.1) near equivalent																					
Net weight		kg	UNIT 27 PANEL 5.5	140																					
Compressor type & Q'ty			—	GTC5150ND70K×1																					
Compressor motor (Starting method)		kW	—	Direct line start																					
Refrigerant oil (Amount, type)		ℓ	—	1.45 M-MA32R																					
Refrigerant (Type, amount, pre-charge length)		kg	R410A 7.2kg (Pre-charged up to the piping length of 30m) Outdoor unit																						
Heat exchanger			Louver fin & inner grooved tubing	Straight fin & inner grooved tubing																					
Refrigerant control			Electronic expansion valve																						
Fan type & Q'ty			Turbo fan ×1	Propeller fan ×2																					
Fan motor (Starting method)		W	140 < Direct line start >	86 × 2 < Direct line start >																					
Air flow	Cooling	m³/min	P-Hi : 37 Hi : 30 Me : 27 Lo : 23																						
	Heating		150																						
Available external static pressure		Pa	0																						
Outside air intake			Possible																						
Air filter, Quality / Quantity			Pocket plastic net ×1(Washable)																						
Shock & vibration absorber			Rubber sleeve (for fan motor)																						
Electric heater		W	—	33 (Crank case heater)																					
Operation control	Remote control		(option) wired : RC-EX1A, RC-E5, RCH-E3 wireless : RCN-T-36W-E																						
	Room temperature control		Thermostat by electronics																						
	Operation display		—																						
Safety equipments			Overload protection for fan motor. Frost protection thermostat. Internal thermostat for fan motor. Abnormal discharge temperature protection.																						
Installation data	Refrigerant piping size (O.D.)	mm	Liquid line: I/U φ 9.52 (3/8") ② φ 9.52 (3/8")×0.8 ① φ 12.7 (1/2")×0.8 O/U φ 12.7 (1/2") Gas line: I/U φ 15.88 (5/8") ② φ 15.88 (5/8")×1.0 ① φ 22.22 (7/8")×1.6 O/U φ 22.22 (7/8")																						
	Connecting method		Flare piping Liquid : Flare / Gas : Brazing																						
	Attached length of piping	m	—																						
	Insulation for piping		Necessary (both Liquid & Gas lines)																						
	Refrigerant line (one way) length	m	Max.70m																						
	Vertical height diff. between O.U. and I.U.	m	Max.30m (Outdoor unit is higher) Max.15m (Outdoor unit is lower)																						
Drain hose			Hose connectable with VP25 (O.D.32)	Holes size φ 20 × 3pcs																					
Drain pump, max lift height		mm	Built-in Drain pump, 700																						
Recommended breaker size		A	—																						
L.R.A. (Locked rotor ampere)		A	5.0																						
Interconnecting wires Size × Core number			φ 1.6mm×3 cores (+ earth cable 1.6mm) / Terminal block (Screw fixing type)																						
IP number			IPX0	IP24																					
Standard accessories			Mounting kit, Drain hose	Connecting pipe, Edging																					
Option parts			—																						
Note (1) The data are measured at the following conditions.			The pipe length is 7.5m.																						
<table border="1"> <thead> <tr> <th rowspan="2">Item</th> <th colspan="2">Indoor air temperature</th> <th colspan="2">Outdoor air temperature</th> <th rowspan="2">Standards</th> </tr> <tr> <th>DB</th> <th>WB</th> <th>DB</th> <th>WB</th> </tr> </thead> <tbody> <tr> <td>Cooling</td> <td>27°C</td> <td>19°C</td> <td>35°C</td> <td>24°C</td> <td rowspan="2">ISO5151-T1</td> </tr> <tr> <td>Heating</td> <td>20°C</td> <td>—</td> <td>7°C</td> <td>6°C</td> </tr> </tbody> </table>					Item	Indoor air temperature		Outdoor air temperature		Standards	DB	WB	DB	WB	Cooling	27°C	19°C	35°C	24°C	ISO5151-T1	Heating	20°C	—	7°C	6°C
Item	Indoor air temperature		Outdoor air temperature			Standards																			
	DB	WB	DB	WB																					
Cooling	27°C	19°C	35°C	24°C	ISO5151-T1																				
Heating	20°C	—	7°C	6°C																					
(2) This air-conditioner is manufactured and tested in conformity with the ISO.																									
(3) Sound level indicates the value in an anechoic chamber. During operation these value are somewhat higher due to ambient conditions.																									
(4) Select the breaker size according to the own national standard.																									
(5) When wireless remote control is used, fan is 3 speed setting (Hi-Me-Lo) only.																									
(6) The operation data indicate when the air-conditioner is operated at 400V50Hz or 380V60Hz.																									
(7) Indoor unit specifications for one unit. Capacity and operation data are two indoor units are combined and run together.																									
(8) Branching pipe set "DIS-WA1"×1(option). ① : Pipe of O/U~Branch, ② : Pipe of Branch~I/U																									

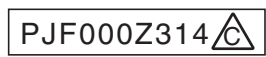

(c) Triple type

Item		Model	FDT140VNTVF																						
			Indoor unit FDT50VF (3 units)	Outdoor unit FDC140VN																					
Power source			1 Phase 220-240V 50Hz / 220V 60Hz																						
Operation data	Nominal cooling capacity (range)	kW	14.0 [5.0(Min.)~14.5(Max.)]																						
	Nominal heating capacity (range)	kW	16.0 [4.0(Min.)~16.5(Max.)]																						
	Power consumption	Cooling	kW	4.65																					
		Heating	kW	4.63																					
	Max power consumption		6.05																						
	Running current	Cooling	A	20.8 / 22.1																					
		Heating	A	20.3 / 21.2																					
	Inrush current, max current		5, 24																						
	Power factor	Cooling	%	97 / 96																					
		Heating	%	99																					
	EER	Cooling		3.01																					
	COP	Heating		3.46																					
Sound power level	Cooling	dB(A)	55																						
	Heating		73																						
Sound pressure level	Cooling	dB(A)	P-Hi : 39 Hi : 33 Me : 31 Lo : 30																						
	Heating		51																						
Silent mode sound pressure level			Cooling : 47 / Heating : 50																						
Exterior dimensions (Height × Width × Depth)		mm	Unit 246 × 840 × 840 Panel 35 × 950 × 950	845×970×370																					
Exterior appearance (Munsell color)			Plaster White (6.8Y8.9/0.2) near equivalent	Stucco White (4.2Y7.5/1.1) near equivalent																					
Net weight		kg	UNIT 22 PANEL 5.5 81																						
Compressor type & Q'ty			—	RMT5126MDE2×1																					
Compressor motor (Starting method)		kW	—	Direct line start																					
Refrigerant oil (Amount, type)		ℓ	—	0.9 M-MA68																					
Refrigerant (Type, amount, pre-charge length)		kg	R410A 3.8kg (Pre-charged up to the piping length of 30m) Outdoor unit																						
Heat exchanger			Louver fin & inner grooved tubing	Straight fin & inner grooved tubing																					
Refrigerant control			Electronic expansion valve																						
Fan type & Q'ty			Turbo fan ×1	Propeller fan ×1																					
Fan motor (Starting method)		W	50 < Direct line start >	86 < Direct line start >																					
Air flow	Cooling	m³/min	P-Hi : 20 Hi : 18 Me : 16 Lo : 14																						
	Heating		75 73																						
Available external static pressure		Pa	0 —																						
Outside air intake			Possible —																						
Air filter, Quality / Quantity			Pocket plastic net ×1(Washable) —																						
Shock & vibration absorber			Rubber sleeve (for fan motor) Rubber sleeve (for compressor)																						
Electric heater		W	—	20 (Crank case heater)																					
Operation control	Remote control		(option) wired : RC-EX1A, RC-E5, RCH-E3 wireless : RCN-T-36W-E																						
	Room temperature control		Thermostat by electronics																						
	Operation display		—																						
Safety equipments			Overload protection for fan motor. Frost protection thermostat. Internal thermostat for fan motor. Abnormal discharge temperature protection.																						
Installation data	Refrigerant piping size (O.D.)	mm	Liquid line: I/U φ 6.35 (1/4") ② φ 9.52 (3/8")×0.8 ① φ 9.52 (3/8")×0.8 O/U φ 9.52 (3/8") Gas line: I/U φ 12.7 (1/2") ② φ 12.7 (1/2")×0.8 ① φ 15.88 (5/8")×1.0 O/U φ 15.88 (5/8")																						
	Connecting method		Flare piping Flare piping																						
	Attached length of piping	m	— —																						
	Insulation for piping		Necessary (both Liquid & Gas lines)																						
	Refrigerant line (one way) length	m	Max.50m																						
	Vertical height diff. between O.U. and I.U.	m	Max.30m (Outdoor unit is higher) Max.15m (Outdoor unit is lower)																						
Drain hose		Hose connectable with VP25 (O.D.32) Holes size φ 20 × 3pcs																							
Drain pump, max lift height		mm	Built-in Drain pump, 700 —																						
Recommended breaker size		A	—																						
L.R.A. (Locked rotor ampere)		A	5.0																						
Interconnecting wires Size × Core number			φ 1.6mm×3 cores (+ earth cable 1.6mm) / Terminal block (Screw fixing type)																						
IP number			IPX0 IP24																						
Standard accessories			Mounting kit, Drain hose Edging																						
Option parts			—																						
Note (1) The data are measured at the following conditions. The pipe length is 7.5m.																									
<table border="1"> <thead> <tr> <th rowspan="2">Item</th> <th colspan="2">Indoor air temperature</th> <th colspan="2">Outdoor air temperature</th> <th rowspan="2">Standards</th> </tr> <tr> <th>DB</th> <th>WB</th> <th>DB</th> <th>WB</th> </tr> </thead> <tbody> <tr> <td>Cooling</td> <td>27°C</td> <td>19°C</td> <td>35°C</td> <td>24°C</td> <td rowspan="2">ISO5151-T1</td> </tr> <tr> <td>Heating</td> <td>20°C</td> <td>—</td> <td>7°C</td> <td>6°C</td> </tr> </tbody> </table>					Item	Indoor air temperature		Outdoor air temperature		Standards	DB	WB	DB	WB	Cooling	27°C	19°C	35°C	24°C	ISO5151-T1	Heating	20°C	—	7°C	6°C
Item	Indoor air temperature		Outdoor air temperature			Standards																			
	DB	WB	DB	WB																					
Cooling	27°C	19°C	35°C	24°C	ISO5151-T1																				
Heating	20°C	—	7°C	6°C																					
(2) This air-conditioner is manufactured and tested in conformity with the ISO.																									
(3) Sound level indicates the value in an anechoic chamber. During operation these value are somewhat higher due to ambient conditions.																									
(4) Select the breaker size according to the own national standard.																									
(5) When wireless remote control is used, fan is 3 speed setting (Hi-Me-Lo) only.																									
(6) The operation data indicate when the air-conditioner is operated at 230V50Hz or 220V60Hz.																									
(7) Indoor unit specifications for one unit. Capacity and operation data are three indoor units are combined and run together.																									
(8) Branching pipe set "DIS-TB1"×1(option). ① : Pipe of O/U~Branch, ② : Pipe of Branch~I/U																									

Item		Model	FDT140VSTVF			
			Indoor unit FDT50VF (3 units)	Outdoor unit FDC140VS		
Power source			3 Phase 380-415V 50Hz / 380V 60Hz			
Operation data	Nominal cooling capacity (range)	kW	14.0 [5.0(Min.) ~ 14.5(Max.)]			
	Nominal heating capacity (range)	kW	16.0 [4.0(Min.) ~ 16.5(Max.)]			
	Power consumption	Cooling	kW	4.65		
		Heating		4.63		
	Max power consumption		6.05			
	Running current	Cooling	A	6.9 / 7.4		
		Heating		6.8 / 7.1		
	Inrush current, max current		5, 15			
	Power factor	Cooling	%	97 / 95		
		Heating		98 / 99		
	EER	Cooling	3.01			
	COP	Heating	3.46			
Sound power level	Cooling	dB(A)	55	73		
	Heating					
Sound pressure level	Cooling	dB(A)	P-Hi : 39 Hi : 33 Me : 31 Lo : 30			
	Heating		51			
Silent mode sound pressure level			Cooling : 47 / Heating : 50			
Exterior dimensions (Height × Width × Depth)		mm	Unit 246×840×840 Panel 35×950×950	845×970×370		
Exterior appearance (Munsell color)			Plaster White (6.8Y8.9/0.2) near equivalent	Stucco White (4.2Y7.5/1.1) near equivalent		
Net weight		kg	UNIT 22 PANEL 5.5	83		
Compressor type & Q'ty			—	RMT5126MDE3×1		
Compressor motor (Starting method)		kW	—	Direct line start		
Refrigerant oil (Amount, type)		ℓ	—	0.9 M-MA68		
Refrigerant (Type, amount, pre-charge length)		kg	R410A 3.8kg (Pre-charged up to the piping length of 30m) Outdoor unit			
Heat exchanger			Louver fin & inner grooved tubing	Straight fin & inner grooved tubing		
Refrigerant control			Electronic expansion valve			
Fan type & Q'ty			Turbo fan ×1	Propeller fan ×1		
Fan motor (Starting method)		W	50 < Direct line start >	86 < Direct line start >		
Air flow	Cooling	m ³ /min	P-Hi : 20 Hi : 18 Me : 16 Lo : 14			
	Heating		75			
Available external static pressure		Pa	0	—		
Outside air intake			Possible	—		
Air filter, Quality / Quantity			Pocket plastic net ×1(Washable)	—		
Shock & vibration absorber			Rubber sleeve (for fan motor)	Rubber sleeve (for compressor)		
Electric heater		W	—	20 (Crank case heater)		
Operation control	Remote control		(option) wired :RC-EX1A, RC-E5, RCH-E3 wireless : RCN-T-36W-E			
	Room temperature control		Thermostat by electronics			
	Operation display		—			
Safety equipments			Overload protection for fan motor. Frost protection thermostat. Internal thermostat for fan motor. Abnormal discharge temperature protection.			
Installation data	Refrigerant piping size (O.D.)	mm	Liquid line: I/U φ 6.35 (1/4") ② φ 9.52(3/8")x0.8 ① φ 9.52(3/8")x0.8 O/U φ 9.52 (3/8") Gas line: I/U φ 12.7 (1/2") ② φ 12.7(1/2")x0.8 ① φ 15.88(5/8")x1.0 O/U φ 15.88 (5/8")			
	Connecting method		Flare piping	Flare piping		
	Attached length of piping	m	—	—		
	Insulation for piping		Necessary (both Liquid & Gas lines)			
	Refrigerant line (one way) length	m	Max.50m			
	Vertical height diff. between O.U. and I.U.	m	Max.30m (Outdoor unit is higher)	Max.15m (Outdoor unit is lower)		
Drain hose		Hose connectable with VP25 (O.D.32)		Holes size φ 20 × 3pcs		
Drain pump, max lift height	mm	Built-in Drain pump, 700		—		
Recommended breaker size	A	—				
L.R.A. (Locked rotor ampere)	A	5.0				
Interconnecting wires	Size × Core number	φ 1.6mm×3 cores (+ earth cable 1.6mm) / Terminal block (Screw fixing type)				
IP number		IPX0	IP24			
Standard accessories		Mounting kit, Drain hose	Edging			
Option parts		—				
Note (1) The data are measured at the following conditions.			The pipe length is 7.5m.			
Operation	Item	Indoor air temperature		Outdoor air temperature		Standards
		DB	WB	DB	WB	
	Cooling	27°C	19°C	35°C	24°C	
	Heating	20°C	—	7°C	6°C	
(2) This air-conditioner is manufactured and tested in conformity with the ISO.						
(3) Sound level indicates the value in an anechoic chamber. During operation these value are somewhat higher due to ambient conditions.						
(4) Select the breaker size according to the own national standard.						
(5) When wireless remote control is used, fan is 3 speed setting (Hi-Me-Lo) only.						
(6) The operation data indicate when the air-conditioner is operated at 400V50Hz or 380V60Hz.						
(7) Indoor unit specifications for one unit. Capacity and operation data are three indoor units are combined and run together.						
(8) Branching pipe set "DIS-TB1"×1(option). ① : Pipe of O/U ~ Branch, ② : Pipe of Branch ~ I/U						

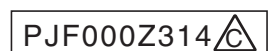

Item		Model		FDT200VSTVF1			
				Indoor unit FDT71VF1 (3 units)	Outdoor unit FDC200VS		
Power source		3 Phase 380-415V 50Hz / 380V 60Hz					
Operation data	Nominal cooling capacity (range)		kW		20.0 [7.0(Min.) ~ 22.4(Max.)]		
	Nominal heating capacity (range)		kW		22.4 [7.6(Min.) ~ 25.0(Max.)]		
	Power consumption	Cooling	kW		6.49		
		Heating	kW		6.12		
	Max power consumption		kW		8.24		
	Running current	Cooling	A		9.7 / 10.2		
		Heating	A		9.1 / 9.6		
	Inrush current, max current		A		5, 19		
	Power factor	Cooling	%		97		
		Heating	%		97		
	EER		Cooling		3.08		
	COP		Heating		3.66		
	Sound power level	Cooling	dB(A)		64		
Heating		dB(A)		74			
Sound pressure level	Cooling	dB(A)		P-Hi : 49 Hi : 35 Me : 33 Lo : 31			
	Heating	dB(A)		57			
Silent mode sound pressure level		dB(A)		—			
Exterior dimensions (Height × Width × Depth)		mm	Unit 246×840×840 Panel 35×950×950	1,300×970×370			
Exterior appearance (Munsell color)			Plaster White (6.8Y8.9/0.2) near equivalent	Stucco White (4.2Y7.5/1.1) near equivalent			
Net weight		kg	UNIT 22 PANEL 5.5	122			
Compressor type & Q'ty			—	GTC5150ND70K×1			
Compressor motor (Starting method)		kW	—	Direct line start			
Refrigerant oil (Amount, type)		ℓ	—	1.45 M-MA32R			
Refrigerant (Type, amount, pre-charge length)		kg	R410A 5.4kg (Pre-charged up to the piping length of 30m) Outdoor unit				
Heat exchanger			Louver fin & inner grooved tubing	Straight fin & inner grooved tubing			
Refrigerant control			Electronic expansion valve				
Fan type & Q'ty			Turbo fan ×1	Propeller fan ×2			
Fan motor (Starting method)		W	50 < Direct line start >	86×2 < Direct line start >			
Air flow	Cooling	m ³ /min	P-Hi : 28 Hi : 21 Me : 19 Lo : 17	150			
	Heating	m ³ /min		145			
Available external static pressure		Pa	0	—			
Outside air intake			Possible	—			
Air filter, Quality / Quantity			Pocket plastic net ×1(Washable)	—			
Shock & vibration absorber			Rubber sleeve (for fan motor)	Rubber sleeve (for compressor)			
Electric heater		W	—	33 (Crank case heater)			
Operation control	Remote control		(option) wired :RC-EX1A, RC-E5, RCH-E3 wireless : RCN-T-36W-E				
	Room temperature control		Thermostat by electronics				
	Operation display		—				
Safety equipments			Overload protection for fan motor. Frost protection thermostat. Internal thermostat for fan motor. Abnormal discharge temperature protection.				
Installation data	Refrigerant piping size (O.D.)		mm		Liquid line: I/U φ 9.52 (3/8") ② φ 9.52(3/8")×0.8 ① φ 9.52(3/8")×0.8 O/U φ 9.52 (3/8") Gas line: I/U φ 15.88 (5/8") ② φ 15.88(5/8")×1.0 ① φ 22.22(7/8")×1.6 O/U φ 22.22 (7/8")		
	Connecting method		mm		Flare piping		
	Attached length of piping		m		Liquid: Flare / Gas: Brazing		
	Insulation for piping		m		Necessary (both Liquid & Gas lines)		
	Refrigerant line (one way) length		m		Max.70m		
	Vertical height diff. between O.U. and I.U.		m		Max.30m (Outdoor unit is higher) Max.15m (Outdoor unit is lower)		
Drain hose		mm		Hose connectable with VP25 (O.D.32) Holes size φ 20 × 3pcs			
Drain pump, max lift height		mm		Built-in Drain pump, 700			
Recommended breaker size		A		—			
L.R.A. (Locked rotor ampere)		A		5.0			
Interconnecting wires Size × Core number				φ 1.6mm×3 cores (+ earth cable 1.6mm) / Terminal block (Screw fixing type)			
IP number				IPX0 IP24			
Standard accessories				Mounting kit, Drain hose Edging			
Option parts				—			
Note (1) The data are measured at the following conditions.				The pipe length is 7.5m.			
Operation	Indoor air temperature		Outdoor air temperature		Standards		
	DB	WB	DB	WB			
	27°C	19°C	35°C	24°C			
Cooling				ISO5151-T1			
Heating							
				20°C	—	7°C	6°C
<p>(2) This air-conditioner is manufactured and tested in conformity with the ISO.</p> <p>(3) Sound level indicates the value in an anechoic chamber. During operation these value are somewhat higher due to ambient conditions.</p> <p>(4) Select the breaker size according to the own national standard.</p> <p>(5) When wireless remote control is used, fan is 3 speed setting (Hi-Me-Lo) only.</p> <p>(6) The operation data indicate when the air-conditioner is operated at 400V50Hz or 380V60Hz.</p> <p>(7) Indoor unit specifications for one unit. Capacity and operation data are three indoor units are combined and run together.</p> <p>(8) Branching pipe set "DIS-TB1"×1(option). ① : Pipe of O/U ~ Branch, ② : Pipe of Branch ~ I/U</p>							

(d) Double twin type

		Model	FDT200VSDVF			
Item			Indoor unit FDT50VF (4 units)	Outdoor unit FDC200VS		
Power source			3 Phase 380-415V 50Hz / 380V 60Hz			
Operation data	Nominal cooling capacity (range)	kW	20.0 [7.0(Min.) ~ 22.4(Max.)]			
	Nominal heating capacity (range)	kW	22.4 [7.6(Min.) ~ 25.0(Max.)]			
	Power consumption	Cooling	kW	6.58		
		Heating		6.15		
	Max power consumption		8.36			
	Running current	Cooling	A	9.8 / 10.3		
		Heating		9.2 / 9.6		
	Inrush current, max current		5, 19			
	Power factor	Cooling	%	97		
		Heating		97		
	EER	Cooling		3.04		
	COP	Heating		3.64		
	Sound power level	Cooling	dB(A)	55		
Heating		74				
Sound pressure level	Cooling	dB(A)	P-Hi : 39 Hi : 33 Me : 31 Lo : 30			
	Heating		57			
Silent mode sound pressure level			Cooling : 56 / Heating : 56			
Exterior dimensions (Height × Width × Depth)		mm	Unit 246×840×840 Panel 35×950×950	1,300×970×370		
Exterior appearance (Munsell color)			Plaster White (6.8Y8.9/0.2) near equivalent	Stucco White (4.2Y7.5/1.1) near equivalent		
Net weight		kg	UNIT 22 PANEL 5.5	122		
Compressor type & Q'ty			—	GTC5150ND70K×1		
Compressor motor (Starting method)		kW	—	Direct line start		
Refrigerant oil (Amount, type)		ℓ	—	1.45 M-MA32R		
Refrigerant (Type, amount, pre-charge length)		kg	R410A 5.4kg (Pre-charged up to the piping length of 30m) Outdoor unit			
Heat exchanger			Louver fin & inner grooved tubing	Straight fin & inner grooved tubing		
Refrigerant control			Electronic expansion valve			
Fan type & Q'ty			Turbo fan ×1	Propeller fan ×2		
Fan motor (Starting method)		W	50 < Direct line start >	86×2 < Direct line start >		
Air flow	Cooling	m ³ /min	P-Hi : 20 Hi : 18 Me : 16 Lo : 14			
	Heating		150 145			
Available external static pressure		Pa	0			
Outside air intake			Possible			
Air filter, Quality / Quantity			Pocket plastic net ×1(Washable)			
Shock & vibration absorber			Rubber sleeve (for fan motor) Rubber sleeve (for compressor)			
Electric heater		W	—	33 (Crank case heater)		
Operation control	Remote control		(option) wired :RC-EX1A, RC-E5, RCH-E3 wireless : RCN-T-36W-E			
	Room temperature control		Thermostat by electronics			
	Operation display		—			
Safety equipments			Overload protection for fan motor. Frost protection thermostat. Internal thermostat for fan motor. Abnormal discharge temperature protection.			
Installation data	Refrigerant piping size (O.D.)	mm	Liquid line: I/U φ 6.35 (1/4") ③②φ 9.52(3/8")×0.8 ①φ 9.52(3/8")×0.8 O/U φ 9.52 (3/8") Gas line: I/U φ 12.7 (1/2") ③φ 12.7×0.8 s φ 15.88 ①φ 22.22(7/8")×1.6 O/U φ 22.22 (7/8")			
	Connecting method		Flare piping Liquid: Flare / Gas: Brazing			
	Attached length of piping	m	—			
	Insulation for piping		Necessary (both Liquid & Gas lines)			
	Refrigerant line (one way) length	m	Max.70m			
	Vertical height diff. between O.U. and I.U.	m	Max.30m (Outdoor unit is higher) Max.15m (Outdoor unit is lower)			
Drain hose		Hose connectable with VP25 (O.D.32) Holes size φ 20 × 3pcs				
Drain pump, max lift height	mm	Built-in Drain pump, 700				
Recommended breaker size	A	—				
L.R.A. (Locked rotor ampere)	A	5.0				
Interconnecting wires Size × Core number		φ 1.6mm×3 cores (+ earth cable 1.6mm) / Terminal block (Screw fixing type)				
IP number		IPX0 IP24				
Standard accessories		Mounting kit, Drain hose Connecting pipe, Edging				
Option parts		—				
Note (1) The data are measured at the following conditions.			The pipe length is 7.5m.			
Operation	Cooling	Indoor air temperature		Outdoor air temperature		Standards
		DB	WB	DB	WB	
	27°C	19°C	35°C	24°C		
Heating	20°C		7°C 6°C		ISO5151-T1	
(2) This air-conditioner is manufactured and tested in conformity with the ISO. (3) Sound level indicates the value in an anechoic chamber. During operation these value are somewhat higher due to ambient conditions. (4) Select the breaker size according to the own national standard. (5) When wireless remote control is used, fan is 3 speed setting (Hi-Me-Lo) only. (6) The operation data indicate when the air-conditioner is operated at 400V50Hz or 380V60Hz. (7) Indoor unit specifications for one unit. Capacity and operation data are four indoor units are combined and run together. (8) Branching pipe set "DIS-WB1"×1, "DIS-WA1"×2 (option). Pipe ① : O/U ~ Branch, ② : Branch ~ Branch, ③ : Branch ~ I/U						

Item		Model	FDT250VSDVF		
			Indoor unit FDT60VF (4 units)	Outdoor unit FDC250VS	
Power source			3 Phase 380-415V 50Hz / 380V 60Hz		
Operation data	Nominal cooling capacity (range)	kW	25.0 [10.0(Min.) ~ 28.0(Max.)]		
	Nominal heating capacity (range)	kW	28.0 [9.5(Min.) ~ 31.5(Max.)]		
	Power consumption	Cooling	kW	8.28	
		Heating		7.70	
	Max power consumption			9.94	
	Running current	Cooling	A	12.3 / 13.0	
		Heating		11.5 / 12.1	
	Inrush current, max current			5, 22	
	Power factor	Cooling	%	97	
		Heating		97	
	EER	Cooling		3.02	
	COP	Heating		3.64	
Sound power level	Cooling	dB(A)	60		
	Heating		74		
Sound pressure level	Cooling	dB(A)	P-Hi : 46 Hi : 33 Me : 31 Lo : 30		
	Heating		57		
Silent mode sound pressure level			Cooling : 56 / Heating : 57		
Exterior dimensions (Height × Width × Depth)		mm	Unit 246×840×840 Panel 35×950×950	1,505×970×370	
Exterior appearance (Munsell color)			Plaster White (6.8Y8.9/0.2) near equivalent	Stucco White (4.2Y7.5/1.1) near equivalent	
Net weight		kg	UNIT 24 PANEL 5.5	140	
Compressor type & Q'ty			—	GTC5150ND70K×1	
Compressor motor (Starting method)		kW	—	Direct line start	
Refrigerant oil (Amount, type)		ℓ	—	1.45 M-MA32R	
Refrigerant (Type, amount, pre-charge length)		kg	R410A 7.2kg (Pre-charged up to the piping length of 30m) Outdoor unit		
Heat exchanger			Louver fin & inner grooved tubing	Straight fin & inner grooved tubing	
Refrigerant control			Electronic expansion valve		
Fan type & Q'ty			Turbo fan ×1	Propeller fan ×2	
Fan motor (Starting method)		W	50 < Direct line start >	86×2 < Direct line start >	
Air flow	Cooling	m³/min	P-Hi : 28 Hi : 18 Me : 16 Lo : 14		
	Heating		150		
Available external static pressure		Pa	0	—	
Outside air intake			Possible	—	
Air filter, Quality / Quantity			Pocket plastic net ×1(Washable)	—	
Shock & vibration absorber			Rubber sleeve (for fan motor)	Rubber sleeve (for compressor)	
Electric heater		W	—	33 (Crank case heater)	
Operation control	Remote control		(option) wired :RC-EX1A, RC-E5, RCH-E3 wireless : RCN-T-36W-E		
	Room temperature control		Thermostat by electronics		
	Operation display		—		
Safety equipments			Overload protection for fan motor. Frost protection thermostat. Internal thermostat for fan motor. Abnormal discharge temperature protection.		
Installation data	Refrigerant piping size (O.D.)	mm	Liquid line: I/U φ 6.35 (1/4") ③②φ 9.52(3/8")x0.8 ①φ 12.7(1/2")x0.8 O/U φ 12.7 (1/2") Gas line: I/U φ 12.7 (1/2") ③φ 12.7x0.8 ②φ 15.88 ①φ 22.22(7/8")x1.6 O/U φ 22.22 (7/8")		
	Connecting method		Flare piping	Liquid: Flare / Gas: Brazing	
	Attached length of piping	m	—	—	
	Insulation for piping		Necessary (both Liquid & Gas lines)		
	Refrigerant line (one way) length	m	Max.70m		
	Vertical height diff. between O.U. and I.U.	m	Max.30m (Outdoor unit is higher)	Max.15m (Outdoor unit is lower)	
Drain hose			Hose connectable with VP25 (O.D.32)	Holes size φ 20 × 3pcs	
Drain pump, max lift height		mm	Built-in Drain pump, 700	—	
Recommended breaker size		A	—	—	
L.R.A. (Locked rotor ampere)		A	—	5.0	
Interconnecting wires Size × Core number			φ 1.6mm×3 cores (+ earth cable 1.6mm) / Terminal block (Screw fixing type)		
IP number			IPX0	IP24	
Standard accessories			Mounting kit, Drain hose	Connecting pipe, Edging	
Option parts			—		

Note (1) The data are measured at the following conditions.

The pipe length is 7.5m.

Item	Indoor air temperature		Outdoor air temperature		Standards
	DB	WB	DB	WB	
Operation	27°C	19°C	35°C	24°C	ISO5151-T1
Cooling	27°C	19°C	35°C	24°C	
Heating	20°C	—	7°C	6°C	

(2) This air-conditioner is manufactured and tested in conformity with the ISO.

(3) Sound level indicates the value in an anechoic chamber. During operation these value are somewhat higher due to ambient conditions.

(4) Select the breaker size according to the own national standard.

(5) When wireless remote control is used, fan is 3 speed setting (Hi-Me-Lo) only.

(6) The operation data indicate when the air-conditioner is operated at 400V50Hz or 380V60Hz.

(7) Indoor unit specifications for one unit. Capacity and operation data are four indoor units are combined and run together.

(8) Branching pipe set "DIS-WB1"×1,"DIS-WA1"×2 (option). Pipe ① : O/U ~ Branch, ② : Branch ~ Branch, ③ : Branch ~ I/U

(2) Ceiling cassette-4way compact type (FDTC)

(a) Twinn type

Item		Model	FDTC100VNPVF		
			Indoor unit FDTC50VF (2 units)	Outdoor unit FDC100VN	
Power source			1 Phase 220-240V 50Hz / 220V 60Hz		
Operation data	Nominal cooling capacity (range)	kW	10.0 [4.0(Min.) ~ 11.2(Max.)]		
	Nominal heating capacity (range)	kW	11.2 [4.0(Min.) ~ 12.5(Max.)]		
	Power consumption	Cooling	kW	3.25	
		Heating		3.26	
	Max power consumption		4.56		
	Running current	Cooling	A	14.3 / 14.9	
		Heating		14.3 / 14.9	
	Inrush current, max current		5, 24		
	Power factor	Cooling	%	99	
		Heating		99	
	EER	Cooling		3.08	
	COP	Heating		3.44	
Sound power level	Cooling	dB(A)	60		
	Heating		70		
Sound pressure level	Cooling	dB(A)	P-Hi : 47 Hi : 42 Me : 36 Lo : 30		
	Heating		P-Hi : 47 Hi : 42 Me : 36 Lo : 32		
Silent mode sound pressure level			Cooling : 46 / Heating : 46		
Exterior dimensions (Height × Width × Depth)	mm		Unit 248×570×570 Panel 35×700×700	845×970×370	
Exterior appearance (Munsell color)			Plaster White (6.8Y8.9/0.2) near equivalent	Stucco White (4.2Y7.5/1.1) near equivalent	
Net weight	kg		UNIT 15 PANEL 3.5	81	
Compressor type & Q'ty			—	RMT5126MDE2×1	
Compressor motor (Starting method)	kW		—	Direct line start	
Refrigerant oil (Amount, type)	ℓ		—	0.9 M-MA68	
Refrigerant (Type, amount, pre-charge length)	kg		R410A 3.8kg (Pre-charged up to the piping length of 30m) Outdoor unit		
Heat exchanger			Louver fin & inner grooved tubing	Straight fin & inner grooved tubing	
Refrigerant control			Electronic expansion valve		
Fan type & Q'ty			Turbo fan ×1	Propeller fan ×1	
Fan motor (Starting method)	W		33 < Direct line start >	86 < Direct line start >	
Air flow	Cooling	m³/min	P-Hi : 13.5 Hi : 11.5 Me : 9 Lo : 7		
	Heating		P-Hi : 13.5 Hi : 11.5 Me : 9 Lo : 8		
Available external static pressure	Pa		0		
Outside air intake			Not possible		
Air filter, Quality / Quantity			Pocket plastic net ×1(Washable)		
Shock & vibration absorber			Rubber sleeve (for fan motor)		
Electric heater	W		0	20 (Crank case heater)	
Operation control	Remote control		(option) wired :RC-EX1A, RC-E5, RCH-E3 wireless : RCN-TC-24W-ER		
	Room temperature control		Thermostat by electronics		
	Operation display		—		
Safety equipments			Overload protection for fan motor. Frost protection thermostat. Internal thermostat for fan motor. Abnormal discharge temperature protection.		
Installation data	Refrigerant piping size (O.D.)	mm	Liquid line: I/U φ 6.35 (1/4") ② φ 9.52(3/8")x0.8 ① φ 9.52(3/8")x0.8 O/U φ 9.52 (3/8 ") Gas line: I/U φ 12.7 (1/2") ② φ 12.7(1/2")x0.8 ① φ 15.88(5/8")x1.0 O/U φ 15.88 (5/8")		
	Connecting method		Flare piping		
	Attached length of piping	m	—		
	Insulation for piping		Necessary (both Liquid & Gas lines)		
	Refrigerant line (one way) length	m	Max.50m		
	Vertical height diff. between O.U. and I.U.	m	Max.30m (Outdoor unit is higher) Max.15m (Outdoor unit is lower)		
Drain hose			Hose connectable with VP20 (O.D.26)	Holes size φ 20 × 3pcs	
Drain pump, max lift height	mm		Built-in Drain pump		
Recommended breaker size	A		—		
L.R.A. (Locked rotor ampere)	A		5.0		
Interconnecting wires Size × Core number			φ 1.6mm×3 cores (+ earth cable 1.6mm) / Terminal block (Screw fixing type)		
IP number			IPX0	IP24	
Standard accessories			Mounting kit, Drain hose	Edging	
Option parts			TC-OAS-E, TC-OAD-E		
Note (1) The data are measured at the following conditions.			The pipe length is 7.5m.		
	Item	Indoor air temperature	Outdoor air temperature		
Operation		DB	DB	WB	
	Cooling	27°C	35°C	24°C	
	Heating	20°C	7°C	6°C	
			Standards		
			ISO5151-T1		
(2) This air-conditioner is manufactured and tested in conformity with the ISO.					
(3) Sound level indicates the value in an anechoic chamber. During operation these value are somewhat higher due to ambient conditions.					
(4) Select the breaker size according to the own national standard.					
(5) When wireless remote control is used, fan is 3 speed setting (Hi-Me-Lo) only.					
(6) The operation data indicate when the air-conditioner is operated at 230V50Hz or 220V60Hz.					
(7) Indoor unit specifications for one unit. Capacity and operation data are two indoor units are combined and run together.					
(8) Branching pipe set "DIS-WA1"×1(option). ① :Pipe of O/U ~ Branch. ② :Pipe of Branch ~ I/U					

Item		Model	FDTC100VSPVF			
			Indoor unit FDT50VF (2 units)	Outdoor unit FDC100VS		
Power source			3 Phase 380-415V 50Hz / 380V 60Hz			
Operation data	Nominal cooling capacity (range)	kW	10.0 [4.0(Min.) ~ 11.2(Max.)]			
	Nominal heating capacity (range)	kW	11.2 [4.0(Min.) ~ 12.5(Max.)]			
	Power consumption	Cooling	kW	3.25		
		Heating		3.26		
	Max power consumption		4.56			
	Running current	Cooling	A	4.8 / 5.0		
		Heating		4.8 / 5.1		
	Inrush current, max current		5, 15			
	Power factor	Cooling	%	98		
		Heating		99 / 97		
	EER	Cooling		3.08		
	COP	Heating		3.44		
Sound power level	Cooling	dB(A)	60	70		
	Heating					
Sound pressure level	Cooling	dB(A)	P-Hi : 47 Hi : 42 Me : 36 Lo : 30	49		
	Heating		P-Hi : 47 Hi : 42 Me : 36 Lo : 32			
Silent mode sound pressure level			Cooling : 46 / Heating : 46			
Exterior dimensions (Height × Width × Depth)		mm	Unit 248×570×570 Panel 35×700×700	845×970×370		
Exterior appearance (Munsell color)			Plaster White (6.8Y8.9/0.2) near equivalent	Stucco White (4.2Y7.5/1.1) near equivalent		
Net weight		kg	UNIT 15 PANEL 3.5	83		
Compressor type & Q'ty			—	RMT5126MDE2×1		
Compressor motor (Starting method)		kW	—	Direct line start		
Refrigerant oil (Amount, type)		ℓ	—	0.9 M-MA68		
Refrigerant (Type, amount, pre-charge length)		kg	R410A 3.8kg (Pre-charged up to the piping length of 30m) Outdoor unit			
Heat exchanger			Louver fin & inner grooved tubing	Straight fin & inner grooved tubing		
Refrigerant control			Electronic expansion valve			
Fan type & Q'ty			Turbo fan ×1	Propeller fan ×1		
Fan motor (Starting method)		W	33 < Direct line start >	86 < Direct line start >		
Air flow	Cooling	m ³ /min	P-Hi : 13.5 Hi : 11.5 Me : 9 Lo : 7	75		
	Heating		P-Hi : 13.5 Hi : 11.5 Me : 9 Lo : 8	73		
Available external static pressure		Pa	0			
Outside air intake			Not possible			
Air filter, Quality / Quantity			Pocket plastic net ×1(Washable)			
Shock & vibration absorber			Rubber sleeve (for fan motor)	Rubber sleeve (for compressor)		
Electric heater		W	0			
Operation control	Remote control		(option) wired :RC-EX1A, RC-E5, RCH-E3 wireless : RCN-TC-24W-ER			
	Room temperature control		Thermostat by electronics			
	Operation display		—			
Safety equipments			Overload protection for fan motor. Frost protection thermostat. Internal thermostat for fan motor. Abnormal discharge temperature protection.			
Installation data	Refrigerant piping size (O.D.)	mm	Liquid line: I/U φ 6.35 (1/4") ② φ 9.52(3/8")x0.8 ① φ 9.52(3/8")x0.8 O/U φ 9.52 (3/8 ") Gas line: I/U φ 12.7 (1/2") ② φ 12.7(1/2")x0.8 ① φ 15.88(5/8")x1.0 O/U φ 15.88 (5/8")			
	Connecting method		Flare piping			
	Attached length of piping	m	—			
	Insulation for piping		Necessary (both Liquid & Gas lines)			
	Refrigerant line (one way) length	m	Max.50m			
	Vertical height diff. between O.U. and I.U.	m	Max.30m (Outdoor unit is higher) Max.15m (Outdoor unit is lower)			
Drain hose			Hose connectable with VP20 (O.D.26)	Holes size φ 20 × 3pcs		
Drain pump, max lift height		mm	Built-in Drain pump			
Recommended breaker size		A	—			
L.R.A. (Locked rotor ampere)		A	5.0			
Interconnecting wires Size × Core number			φ 1.6mm×3 cores (+ earth cable 1.6mm) / Terminal block (Screw fixing type)			
IP number			IPX0	IP24		
Standard accessories			Mounting kit, Drain hose	Edging		
Option parts			TC-OAS-E, TC-OAD-E			
Note (1) The data are measured at the following conditions.			The pipe length is 7.5m.			
	Item	Indoor air temperature		Outdoor air temperature	Standards	
Operation		DB	WB	DB		WB
	Cooling	27°C	19°C	35°C		24°C
	Heating	20°C	—	7°C		6°C
(2) This air-conditioner is manufactured and tested in conformity with the ISO.						
(3) Sound level indicates the value in an anechoic chamber. During operation these value are somewhat higher due to ambient conditions.						
(4) Select the breaker size according to the own national standard.						
(5) When wireless remote control is used, fan is 3 speed setting (Hi-Me-Lo) only.						
(6) The operation data indicate when the air-conditioner is operated at 400V50Hz or 380V60Hz.						
(7) Indoor unit specifications for one unit. Capacity and operation data are two indoor units are combined and run together.						
(8) Branching pipe set "DIS-WA1"×1(option). ① :Pipe of O/U ~ Branch. ② :Pipe of Branch ~ I/U						

Item		Model	FDTCT125VNPVF			
			Indoor unit FDTCT60VF (2 units)	Outdoor unit FDC125VN		
Power source			1 Phase 220-240V 50Hz / 220V 60Hz			
Operation data	Nominal cooling capacity (range)	kW	12.5 [5.0(Min.) ~ 14.0(Max.)]			
	Nominal heating capacity (range)	kW	14.0 [4.0(Min.) ~ 16.0(Max.)]			
	Power consumption	Cooling	kW	5.35		
		Heating		4.62		
	Max power consumption		6.96			
	Running current	Cooling	A	24.0 / 25.1		
		Heating		20.7 / 21.6		
	Inrush current, max current		5, 24			
	Power factor	Cooling	%	97		
		Heating		97		
	EER	Cooling	2.34			
	COP	Heating	3.03			
Sound power level	Cooling	dB(A)	60			
	Heating		72			
Sound pressure level	Cooling	dB(A)	P-Hi : 47 Hi : 46 Me : 39 Lo : 30			
	Heating		P-Hi : 47 Hi : 46 Me : 39 Lo : 32			
Silent mode sound pressure level		—				
			Cooling : 46 / Heating : 48			
Exterior dimensions (Height × Width × Depth)		mm	Unit 248×570×570 Panel 35×700×700	845×970×370		
Exterior appearance (Munsell color)			Plaster White (6.8Y8.9/0.2) near equivalent	Stucco White (4.2Y7.5/1.1) near equivalent		
Net weight		kg	UNIT 15 PANEL 3.5	81		
Compressor type & Q'ty			—	RMT5126MDE2×1		
Compressor motor (Starting method)		kW	—	Direct line start		
Refrigerant oil (Amount, type)		ℓ	—	0.9 M-MA68		
Refrigerant (Type, amount, pre-charge length)		kg	R410A 3.8kg (Pre-charged up to the piping length of 30m) Outdoor unit			
Heat exchanger			Louver fin & inner grooved tubing	Straight fin & inner grooved tubing		
Refrigerant control			Electronic expansion valve			
Fan type & Q'ty			Turbo fan ×1	Propeller fan ×1		
Fan motor (Starting method)		W	33 < Direct line start >	86 < Direct line start >		
Air flow	Cooling	m ³ /min	P-Hi : 13.5 Hi : 13.5 Me : 10 Lo : 7	75		
	Heating		P-Hi : 13.5 Hi : 13.5 Me : 10 Lo : 8	73		
Available external static pressure		Pa	0			
Outside air intake			Not possible			
Air filter, Quality / Quantity			Pocket plastic net ×1(Washable)			
Shock & vibration absorber			Rubber sleeve (for fan motor)	Rubber sleeve (for compressor)		
Electric heater		W	0			
Operation control	Remote control		(option) wired :RC-EX1A, RC-E5, RCH-E3 wireless : RCN-TC-24W-ER			
	Room temperature control		Thermostat by electronics			
	Operation display		—			
Safety equipments			Overload protection for fan motor. Frost protection thermostat. Internal thermostat for fan motor. Abnormal discharge temperature protection.			
Installation data	Refrigerant piping size (O.D.)	mm	Liquid line: I/U φ 6.35 (1/4") ② φ 9.52(3/8")x0.8 ① φ 9.52(3/8")x0.8 O/U φ 9.52 (3/8 ") Gas line: I/U φ 12.7 (1/2") ② φ 12.7(1/2")x0.8 ① φ 15.88(5/8")x1.0 O/U φ 15.88 (5/8")			
	Connecting method		Flare piping			
	Attached length of piping	m	—			
	Insulation for piping		Necessary (both Liquid & Gas lines)			
	Refrigerant line (one way) length	m	Max.50m			
	Vertical height diff. between O.U. and I.U.	m	Max.30m (Outdoor unit is higher) Max.15m (Outdoor unit is lower)			
Drain hose			Hose connectable with VP20 (O.D.26)	Holes size φ 20 × 3pcs		
Drain pump, max lift height		mm	Built-in Drain pump			
Recommended breaker size		A	—			
L.R.A. (Locked rotor ampere)		A	5.0			
Interconnecting wires Size × Core number			φ 1.6mm×3 cores (+ earth cable 1.6mm) / Terminal block (Screw fixing type)			
IP number			IPX0			
Standard accessories			Mounting kit, Drain hose	Edging		
Option parts			TC-OAS-E, TC-OAD-E			
Note (1) The data are measured at the following conditions.			The pipe length is 7.5m.			
	Item	Indoor air temperature		Outdoor air temperature	Standards	
Operation		DB	WB	DB		WB
	Cooling	27°C	19°C	35°C		24°C
	Heating	20°C	—	7°C		6°C
(2) This air-conditioner is manufactured and tested in conformity with the ISO.						
(3) Sound level indicates the value in an anechoic chamber. During operation these value are somewhat higher due to ambient conditions.						
(4) Select the breaker size according to the own national standard.						
(5) When wireless remote control is used, fan is 3 speed setting (Hi-Me-Lo) only.						
(6) The operation data indicate when the air-conditioner is operated at 230V50Hz or 220V60Hz.						
(7) Indoor unit specifications for one unit. Capacity and operation data are two indoor units are combined and run together.						
(8) Branching pipe set "DIS-WA1"×1(option). ① :Pipe of O/U ~ Branch. ② :Pipe of Branch ~ I/U						

Item		Model	FDTCT125VSPVF		
			Indoor unit FDTCT60VF (2 units)	Outdoor unit FDC125VS	
Power source			3 Phase 380-415V 50Hz / 380V 60Hz		
Operation data	Nominal cooling capacity (range)	kW	12.5 [5.0(Min.) ~ 14.0(Max.)]		
	Nominal heating capacity (range)	kW	14.0 [4.0(Min.) ~ 16.0(Max.)]		
	Power consumption	Cooling	kW	5.35	
		Heating		4.62	
	Max power consumption		6.96		
	Running current	Cooling	A	8.0 / 8.4	
		Heating		6.9 / 7.2	
	Inrush current, max current		5, 15		
	Power factor	Cooling	%	97	
		Heating		97	
	EER	Cooling	2.34		
	COP	Heating	3.03		
	Sound power level	Cooling	dB(A)	60	
Heating		72			
Sound pressure level	Cooling	dB(A)	P-Hi : 47 Hi : 46 Me : 39 Lo : 30		
	Heating		P-Hi : 47 Hi : 46 Me : 39 Lo : 32		
Silent mode sound pressure level		Cooling : 46 / Heating : 48			
Exterior dimensions (Height × Width × Depth)		mm	Unit 248×570×570 Panel 35×700×700	845×970×370	
Exterior appearance (Munsell color)			Plaster White (6.8Y8.9/0.2) near equivalent	Stucco White (4.2Y7.5/1.1) near equivalent	
Net weight		kg	UNIT 15 PANEL 3.5	83	
Compressor type & Q'ty			—	RMT5126MDE2×1	
Compressor motor (Starting method)		kW	—	Direct line start	
Refrigerant oil (Amount, type)		ℓ	—	0.9 M-MA68	
Refrigerant (Type, amount, pre-charge length)		kg	R410A 3.8kg (Pre-charged up to the piping length of 30m) Outdoor unit		
Heat exchanger			Louver fin & inner grooved tubing	Straight fin & inner grooved tubing	
Refrigerant control			Electronic expansion valve		
Fan type & Q'ty			Turbo fan ×1	Propeller fan ×1	
Fan motor (Starting method)		W	33 < Direct line start >	86 < Direct line start >	
Air flow	Cooling	m ³ /min	P-Hi : 13.5 Hi : 13.5 Me : 10 Lo : 7		
	Heating		P-Hi : 13.5 Hi : 13.5 Me : 10 Lo : 8		
Available external static pressure		Pa	0		
Outside air intake			Not possible		
Air filter, Quality / Quantity			Pocket plastic net ×1(Washable)		
Shock & vibration absorber			Rubber sleeve (for fan motor)		
Electric heater		W	0	20 (Crank case heater)	
Operation control	Remote control		(option) wired :RC-EX1A, RC-E5, RCH-E3 wireless : RCN-TC-24W-ER		
	Room temperature control		Thermostat by electronics		
	Operation display		—		
Safety equipments			Overload protection for fan motor. Frost protection thermostat. Internal thermostat for fan motor. Abnormal discharge temperature protection.		
Installation data	Refrigerant piping size (O.D.)	mm	Liquid line: I/U φ 6.35 (1/4") ② φ 9.52(3/8")x0.8 ① φ 9.52(3/8")x0.8 O/U φ 9.52 (3/8 ") Gas line: I/U φ 12.7 (1/2") ② φ 12.7(1/2")x0.8 ① φ 15.88(5/8")x1.0 O/U φ 15.88 (5/8")		
	Connecting method		Flare piping		
	Attached length of piping	m	—		
	Insulation for piping		Necessary (both Liquid & Gas lines)		
	Refrigerant line (one way) length	m	Max.50m		
	Vertical height diff. between O.U. and I.U.	m	Max.30m (Outdoor unit is higher) Max.15m (Outdoor unit is lower)		
Drain hose		Hose connectable with VP20 (O.D.26) Holes size φ 20 × 3pcs			
Drain pump, max lift height	mm	Built-in Drain pump			
Recommended breaker size	A	—			
L.R.A. (Locked rotor ampere)	A	5.0			
Interconnecting wires Size × Core number		φ 1.6mm×3 cores (+ earth cable 1.6mm) / Terminal block (Screw fixing type)			
IP number		IPX0 IP24			
Standard accessories		Mounting kit, Drain hose Edging			
Option parts		TC-OAS-E, TC-OAD-E			
Note (1) The data are measured at the following conditions.		The pipe length is 7.5m.			
Operation	Indoor air temperature		Outdoor air temperature		Standards
	DB	WB	DB	WB	
	Cooling	27°C	19°C	35°C	
Heating	20°C	—	7°C	6°C	ISO5151-T1
(2) This air-conditioner is manufactured and tested in conformity with the ISO. (3) Sound level indicates the value in an anechoic chamber. During operation these value are somewhat higher due to ambient conditions. (4) Select the breaker size according to the own national standard. (5) When wireless remote control is used, fan is 3 speed setting (Hi-Me-Lo) only. (6) The operation data indicate when the air-conditioner is operated at 400V50Hz or 380V60Hz. (7) Indoor unit specifications for one unit. Capacity and operation data are two indoor units are combined and run together. (8) Branching pipe set "DIS-WA1"×1(option). ① :Pipe of O/U ~ Branch. ② :Pipe of Branch ~ I/U					

(b) Triple type

Item		Model	FDTC140VNTVF		
			Indoor unit FDTC50VF (3 units)	Outdoor unit FDC140VN	
Power source			1 Phase 220-240V 50Hz / 220V 60Hz		
Operation data	Nominal cooling capacity (range)	kW	14.0 [5.0(Min.) ~ 14.5(Max.)]		
	Nominal heating capacity (range)	kW	16.0 [4.0(Min.) ~ 16.5(Max.)]		
	Power consumption	Cooling	kW	4.64	
		Heating		4.52	
	Max power consumption		A	6.03	
	Running current	Cooling		20.4 / 21.3	
		Heating	20.0 / 20.9		
	Inrush current, max current			5, 24	
	Power factor	Cooling	%	99	
		Heating		98	
	EER	Cooling		3.02	
	COP	Heating		3.54	
	Sound power level	Cooling	dB(A)	60	
Heating		73			
Sound pressure level	Cooling		P-Hi : 47 Hi : 42 Me : 36 Lo : 30		
	Heating		P-Hi : 47 Hi : 42 Me : 36 Lo : 32		
Silent mode sound pressure level			Cooling : 47 / Heating : 50		
Exterior dimensions (Height × Width × Depth)		mm	Unit 248×570×570 Panel 35×700×700	845×970×370	
Exterior appearance (Munsell color)			Plaster White (6.8Y8.9/0.2) near equivalent	Stucco White (4.2Y7.5/1.1) near equivalent	
Net weight		kg	UNIT 15 PANEL 3.5	81	
Compressor type & Q'ty			—	RMT5126MDE2×1	
Compressor motor (Starting method)		kW	—	Direct line start	
Refrigerant oil (Amount, type)		ℓ	—	0.9 M-MA68	
Refrigerant (Type, amount, pre-charge length)		kg	R410A 3.8kg (Pre-charged up to the piping length of 30m) Outdoor unit		
Heat exchanger			Louver fin & inner grooved tubing	Straight fin & inner grooved tubing	
Refrigerant control			Electronic expansion valve		
Fan type & Q'ty			Turbo fan ×1	Propeller fan ×1	
Fan motor (Starting method)		W	33 < Direct line start >	86 < Direct line start >	
Air flow	Cooling	m ³ /min	P-Hi : 13.5 Hi : 11.5 Me : 9 Lo : 7		
	Heating		P-Hi : 13.5 Hi : 11.5 Me : 9 Lo : 8		
Available external static pressure		Pa	0		
Outside air intake			Not possible		
Air filter, Quality / Quantity			Pocket plastic net ×1(Washable)		
Shock & vibration absorber			Rubber sleeve (for fan motor)	Rubber sleeve (for compressor)	
Electric heater		W	0		
Operation control	Remote control		(option) wired :RC-EX1A, RC-E5, RCH-E3 wireless : RCN-TC-24W-ER		
	Room temperature control		Thermostat by electronics		
	Operation display		—		
Safety equipments			Overload protection for fan motor. Frost protection thermostat. Internal thermostat for fan motor. Abnormal discharge temperature protection.		
Installation data	Refrigerant piping size (O.D.)	mm	Liquid line: I/U φ 6.35 (1/4") ② φ 9.52(3/8")x0.8 ① φ 9.52(3/8")x0.8 O/U φ 9.52 (3/8 ") Gas line: I/U φ 12.7 (1/2") ② φ 12.7(1/2")x0.8 ① φ 15.88(5/8")x1.0 O/U φ 15.88 (5/8")		
	Connecting method		Flare piping		
	Attached length of piping	m	—		
	Insulation for piping		Necessary (both Liquid & Gas lines)		
	Refrigerant line (one way) length	m	Max.50m		
	Vertical height diff. between O.U. and I.U.	m	Max.30m (Outdoor unit is higher) Max.15m (Outdoor unit is lower)		
Drain hose			Hose connectable with VP20 (O.D.26)	Holes size φ 20 × 3pcs	
Drain pump, max lift height		mm	Built-in Drain pump		
Recommended breaker size		A	—		
L.R.A. (Locked rotor ampere)		A	5.0		
Interconnecting wires Size × Core number			φ 1.6mm×3 cores (+ earth cable 1.6mm) / Terminal block (Screw fixing type)		
IP number			IPX0	IP24	
Standard accessories			Mounting kit, Drain hose	Edging	
Option parts			TC-OAS-E, TC-OAD-E		
Note (1) The data are measured at the following conditions.			The pipe length is 7.5m.		
Operation	Cooling	Indoor air temperature	Outdoor air temperature		Standards
		DB	WB	DB	
	27°C	19°C	35°C	24°C	
Heating	20°C	—	7°C	6°C	ISO5151-T1
(2) This air-conditioner is manufactured and tested in conformity with the ISO.					
(3) Sound level indicates the value in an anechoic chamber. During operation these value are somewhat higher due to ambient conditions.					
(4) Select the breaker size according to the own national standard.					
(5) When wireless remote control is used, fan is 3 speed setting (Hi-Me-Lo) only.					
(6) The operation data indicate when the air-conditioner is operated at 230V50Hz or 220V60Hz.					
(7) Indoor unit specifications for one unit. Capacity and operation data are three indoor units are combined and run together.					
(8) Branching pipe set "DIS-TA1"×1(option). ① :Pipe of O/U ~ Branch. ② :Pipe of Branch ~ I/U					

Item	Model	FDTC140VSTVF				
		Indoor unit FDTC50VF (3 units)	Outdoor unit FDC140VS			
Power source		3 Phase 380-415V 50Hz / 380V 60Hz				
Operation data	Nominal cooling capacity (range)	kW 14.0 [5.0(Min.) ~ 14.5(Max.)]				
	Nominal heating capacity (range)	kW 16.0 [4.0(Min.) ~ 16.5(Max.)]				
	Power consumption	Cooling	kW 4.64			
		Heating	4.52			
	Max power consumption	kW 6.03				
	Running current	Cooling	A 6.8 / 7.1			
		Heating	6.6 / 7.0			
	Inrush current, max current	A 5, 15				
	Power factor	Cooling	% 98 / 99			
		Heating	99 / 98			
	EER	Cooling	3.02			
	COP	Heating	3.54			
Sound power level	Cooling	dB(A) 60				
	Heating	73				
Sound pressure level	Cooling	P-Hi : 47 Hi : 42 Me : 36 Lo : 30				
	Heating	P-Hi : 47 Hi : 42 Me : 36 Lo : 32				
Silent mode sound pressure level			Cooling : 47 / Heating : 50			
Exterior dimensions (Height × Width × Depth)	mm	Unit 248×570×570 Panel 35×700×700	845×970×370			
Exterior appearance (Munsell color)		Plaster White (6.8Y8.9/0.2) near equivalent	Stucco White (4.2Y7.5/1.1) near equivalent			
Net weight	kg	UNIT 15 PANEL 3.5	83			
Compressor type & Q'ty		—	RMT5126MDE3×1			
Compressor motor (Starting method)	kW	—	Direct line start			
Refrigerant oil (Amount, type)	ℓ	—	0.9 M-MA68			
Refrigerant (Type, amount, pre-charge length)	kg	R410A 3.8kg (Pre-charged up to the piping length of 30m) Outdoor unit				
Heat exchanger		Louver fin & inner grooved tubing	Straight fin & inner grooved tubing			
Refrigerant control		Electronic expansion valve				
Fan type & Q'ty		Turbo fan ×1	Propeller fan ×1			
Fan motor (Starting method)	W	33 < Direct line start >	86 < Direct line start >			
Air flow	Cooling	m ³ /min P-Hi : 13.5 Hi : 11.5 Me : 9 Lo : 7				
	Heating	P-Hi : 13.5 Hi : 11.5 Me : 9 Lo : 8				
Available external static pressure	Pa	0				
Outside air intake		Not possible				
Air filter, Quality / Quantity		Pocket plastic net ×1(Washable)				
Shock & vibration absorber		Rubber sleeve (for fan motor)	Rubber sleeve (for compressor)			
Electric heater	W	0	20 (Crank case heater)			
Operation control	Remote control	(option) wired :RC-EX1A, RC-E5, RCH-E3 wireless : RCN-TC-24W-ER				
	Room temperature control	Thermostat by electronics				
	Operation display	—				
Safety equipments		Overload protection for fan motor. Frost protection thermostat. Internal thermostat for fan motor. Abnormal discharge temperature protection.				
Installation data	Refrigerant piping size (O.D.)	mm Liquid line: I/U φ 6.35 (1/4") ② φ 9.52(3/8")x0.8 ① φ 9.52(3/8")x0.8 O/U φ 9.52 (3/8 ") Gas line: I/U φ 12.7 (1/2") ② φ 12.7(1/2")x0.8 ① φ 15.88(5/8")x1.0 O/U φ 15.88 (5/8")				
	Connecting method	Flare piping				
	Attached length of piping	m —				
	Insulation for piping	Necessary (both Liquid & Gas lines)				
	Refrigerant line (one way) length	m Max.50m				
	Vertical height diff. between O.U. and I.U.	m Max.30m (Outdoor unit is higher) Max.15m (Outdoor unit is lower)				
Drain hose	Hose connectable with VP20 (O.D.26) Holes size φ 20 × 3pcs					
Drain pump, max lift height	mm	Built-in Drain pump —				
Recommended breaker size	A	—				
L.R.A. (Locked rotor ampere)	A	5.0				
Interconnecting wires Size × Core number		φ 1.6mm×3 cores (+ earth cable 1.6mm) / Terminal block (Screw fixing type)				
IP number		IPX0	IP24			
Standard accessories		Mounting kit, Drain hose	Edging			
Option parts		TC-OAS-E, TC-OAD-E				
Note (1) The data are measured at the following conditions. The pipe length is 7.5m.						
	Item	Indoor air temperature		Outdoor air temperature		Standards
Operation		DB	WB	DB	WB	
	Cooling	27°C	19°C	35°C	24°C	
	Heating	20°C	—	7°C	6°C	
(2) This air-conditioner is manufactured and tested in conformity with the ISO. (3) Sound level indicates the value in an anechoic chamber. During operation these value are somewhat higher due to ambient conditions. (4) Select the breaker size according to the own national standard. (5) When wireless remote control is used, fan is 3 speed setting (Hi-Me-Lo) only. (6) The operation data indicate when the air-conditioner is operated at 400V50Hz or 380V60Hz. (7) Indoor unit specifications for one unit. Capacity and operation data are three indoor units are combined and run together. (8) Branching pipe set "DIS-TA1"×1(option). ① :Pipe of O/U ~ Branch. ② :Pipe of Branch ~ I/U						

(c) Double twin type

Item		Model	FDC200VSDVF			
			Indoor unit FDC50VF (4 units)	Outdoor unit FDC200VS		
Power source			3 Phase 380-415V 50Hz / 380V 60Hz			
Operation data	Nominal cooling capacity (range)	kW	20.0 [7.0(Min.) ~ 22.4(Max.)]			
	Nominal heating capacity (range)	kW	22.4 [7.6(Min.) ~ 25.0(Max.)]			
	Power consumption	Cooling	kW	7.33		
		Heating		6.98		
	Max power consumption		9.31			
	Running current	Cooling	A	10.9 / 11.5		
		Heating		10.4 / 10.9		
	Inrush current, max current		5, 19			
	Power factor	Cooling	%	97		
		Heating		97		
	EER	Cooling	2.73			
	COP	Heating	3.21			
	Sound power level	Cooling	dB(A)	60		
Heating		74				
Sound pressure level	Cooling		P-Hi : 47 Hi : 42 Me : 36 Lo : 30			
	Heating		P-Hi : 47 Hi : 42 Me : 36 Lo : 32			
Silent mode sound pressure level		Cooling : 56 / Heating : 56				
Exterior dimensions (Height × Width × Depth)		mm	Unit 248×570×570 Panel 35×700×700	1,300×970×370		
Exterior appearance (Munsell color)			Plaster White (6.8Y8.9/0.2) near equivalent	Stucco White (4.2Y7.5/1.1) near equivalent		
Net weight		kg	UNIT 15 PANEL 3.5	122		
Compressor type & Q'ty			—	GTC5150ND70K×1		
Compressor motor (Starting method)		kW	—	Direct line start		
Refrigerant oil (Amount, type)		ℓ	—	1.45 M-MA32R		
Refrigerant (Type, amount, pre-charge length)		kg	R410A 5.4kg (Pre-charged up to the piping length of 30m) Outdoor unit			
Heat exchanger			Louver fin & inner grooved tubing	Straight fin & inner grooved tubing		
Refrigerant control			Electronic expansion valve			
Fan type & Q'ty			Turbo fan ×1	Propeller fan ×2		
Fan motor (Starting method)		W	33 < Direct line start >	86×2 < Direct line start >		
Air flow	Cooling	m ³ /min	P-Hi : 13.5 Hi : 11.5 Me : 9 Lo : 7			
	Heating		P-Hi : 13.5 Hi : 11.5 Me : 9 Lo : 8			
Available external static pressure		Pa	0			
Outside air intake			Not possible			
Air filter, Quality / Quantity			Pocket plastic net ×1(Washable)			
Shock & vibration absorber			Rubber sleeve (for fan motor)			
Electric heater		W	0	33 (Crank case heater)		
Operation control	Remote control		(option) wired :RC-EX1A, RC-E5, RCH-E3 wireless :RCN-TC-24W-ER			
	Room temperature control		Thermostat by electronics			
	Operation display		—			
Safety equipments			Overload protection for fan motor. Frost protection thermostat. Internal thermostat for fan motor. Abnormal discharge temperature protection.			
Installation data	Refrigerant piping size (O.D.)	mm	Liquid line: I/U φ 6.35 (1/4") ③② φ 9.52(3/8")×0.8 ① φ 9.52(3/8")×0.8 O/U φ 9.52 (3/8 ") Gas line: I/U φ 12.7 (1/2") ③ φ 12.7×0.8 ② φ 15.88 ① φ 22.22(7/8")×1.6 O/U φ 22.22 (7/8")			
	Connecting method		Flare piping			
	Attached length of piping	m	—			
	Insulation for piping		Necessary (both Liquid & Gas lines)			
	Refrigerant line (one way) length	m	Max.70m			
	Vertical height diff. between O.U. and I.U.	m	Max.30m (Outdoor unit is higher) Max.15m (Outdoor unit is lower)			
Drain hose		Hose connectable with VP20 (O.D.26) Holes size φ 20 × 3pcs				
Drain pump, max lift height		mm	Built-in Drain pump			
Recommended breaker size		A	—			
L.R.A. (Locked rotor ampere)		A	5.0			
Interconnecting wires Size × Core number			φ 1.6mm×3 cores (+ earth cable 1.6mm) / Terminal block (Screw fixing type)			
IP number			IPX0 IP24			
Standard accessories			Mounting kit, Drain hose Connecting pipe, Edging			
Option parts			TC-OAS-E, TC-OAD-E			
Note (1) The data are measured at the following conditions.			The pipe length is 7.5m.			
Operation	Cooling	Indoor air temperature		Outdoor air temperature		Standards
		DB	WB	DB	WB	
	27°C	19°C	35°C	24°C	ISO5151-T1	
Heating	20°C	—	7°C	6°C		
(2) This air-conditioner is manufactured and tested in conformity with the ISO.						
(3) Sound level indicates the value in an anechoic chamber. During operation these value are somewhat higher due to ambient conditions.						
(4) Select the breaker size according to the own national standard.						
(5) When wireless remote control is used, fan is 3 speed setting (Hi-Me-Lo) only.						
(6) The operation data indicate when the air-conditioner is operated at 400V50Hz or 380V60Hz.						
(7) Indoor unit specifications for one unit. Capacity and operation data are four indoor units are combined and run together.						
(8) Branching pipe set "DIS-WB1"×1,"DIS-WA1"×2 (option). Pipe ① : O/U ~ Branch, ② : Branch ~ Branch, ③ :Branch ~ I/U						

Item		Model	FDTC250VSDVF		
			Indoor unit FDTC60VF (4 units)	Outdoor unit FDC250VS	
Power source			3 Phase 380-415V 50Hz / 380V 60Hz		
Operation data	Nominal cooling capacity (range)	kW	25.0 [10.0(Min.) ~ 28.0(Max.)]		
	Nominal heating capacity (range)	kW	28.0 [9.5(Min.) ~ 31.5(Max.)]		
	Power consumption	Cooling	kW	11.28	
		Heating		10.19	
	Max power consumption		13.54		
	Running current	Cooling	A	16.8 / 17.7	
		Heating		15.2 / 16.0	
	Inrush current, max current		5, 22		
	Power factor	Cooling	%	97	
		Heating		97	
	EER	Cooling		2.22	
	COP	Heating		2.75	
	Sound power level	Cooling	dB(A)	60	
Heating		74			
Sound pressure level	Cooling		P-Hi : 47 Hi : 46 Me : 39 Lo : 30		
	Heating		P-Hi : 47 Hi : 46 Me : 39 Lo : 32		
Silent mode sound pressure level			Cooling : 56 / Heating : 57		
Exterior dimensions (Height × Width × Depth)		mm	Unit 248×570×570 Panel 35×700×700	1,505×970×370	
Exterior appearance (Munsell color)			Plaster White (6.8Y8.9/0.2) near equivalent	Stucco White (4.2Y7.5/1.1) near equivalent	
Net weight		kg	UNIT 15 PANEL 3.5	140	
Compressor type & Q'ty			—	GTC5150ND70K×1	
Compressor motor (Starting method)		kW	—	Direct line start	
Refrigerant oil (Amount, type)		ℓ	—	1.45 M-MA32R	
Refrigerant (Type, amount, pre-charge length)		kg	R410A 7.2kg (Pre-charged up to the piping length of 30m) Outdoor unit		
Heat exchanger			Louver fin & inner grooved tubing	Straight fin & inner grooved tubing	
Refrigerant control			Electronic expansion valve		
Fan type & Q'ty			Turbo fan ×1	Propeller fan ×2	
Fan motor (Starting method)		W	33 < Direct line start >	86×2 < Direct line start >	
Air flow	Cooling	m³/min	P-Hi : 13.5 Hi : 13.5 Me : 10 Lo : 7		
	Heating		P-Hi : 13.5 Hi : 13.5 Me : 10 Lo : 8		
Available external static pressure		Pa	0		
Outside air intake			Not possible		
Air filter, Quality / Quantity			Pocket plastic net ×1(Washable)		
Shock & vibration absorber			Rubber sleeve (for fan motor)		
Electric heater		W	0	33 (Crank case heater)	
Operation control	Remote control		(option) wired :RC-EX1A, RC-E5, RCH-E3 wireless :RCN-TC-24W-ER		
	Room temperature control		Thermostat by electronics		
	Operation display		—		
Safety equipments			Overload protection for fan motor. Frost protection thermostat. Internal thermostat for fan motor. Abnormal discharge temperature protection.		
Installation data	Refrigerant piping size (O.D.)	mm	Liquid line: I/U φ 6.35 (1/4") ③②φ 9.52(3/8")x0.8 ①φ 12.7(1/2")x0.8 O/U φ 12.7 (1/2 ") Gas line: I/U φ 12.7 (1/2") ③φ 12.7x0.8 ②φ 15.88 ①φ 22.22(7/8")x1.6 O/U φ 22.22 (7/8")		
	Connecting method		Flare piping		
	Attached length of piping	m	—		
	Insulation for piping		Necessary (both Liquid & Gas lines)		
	Refrigerant line (one way) length	m	Max.70m		
	Vertical height diff. between O.U. and I.U.	m	Max.30m (Outdoor unit is higher) Max.15m (Outdoor unit is lower)		
Drain hose		Hose connectable with VP20 (O.D.26) Holes size φ 20 × 3pcs			
Drain pump, max lift height	mm	Built-in Drain pump, 600			
Recommended breaker size	A	—			
L.R.A. (Locked rotor ampere)	A	5.0			
Interconnecting wires	Size × Core number	φ 1.6mm×3 cores (+ earth cable 1.6mm) / Terminal block (Screw fixing type)			
IP number		IPX0 IP24			
Standard accessories		Mounting kit, Drain hose Connecting pipe, Edging			
Option parts		TC-OAS-E, TC-OAD-E			
Note (1) The data are measured at the following conditions.		The pipe length is 7.5m.			
Operation	Cooling	Indoor air temperature		Standards	
		DB	WB		
	27°C	19°C	35°C		24°C
Heating	20°C	—	7°C	6°C	
(2) This air-conditioner is manufactured and tested in conformity with the ISO. (3) Sound level indicates the value in an anechoic chamber. During operation these value are somewhat higher due to ambient conditions. (4) Select the breaker size according to the own national standard. (5) When wireless remote control is used, fan is 3 speed setting (Hi-Me-Lo) only. (6) The operation data indicate when the air-conditioner is operated at 400V50Hz or 380V60Hz. (7) Indoor unit specifications for one unit. Capacity and operation data are four indoor units are combined and run together. (8) Branching pipe set "DIS-WB1"×1, "DIS-WA1"×2 (option). Pipe ① : O/U ~ Branch, ② : Branch ~ Branch, ③ :Branch ~ I/U					

(3) Ceiling suspended type (FDEN)

(a)Single type

Item		Model	FDEN100VNVF1			
			Indoor unit FDEN100VF1	Outdoor unit FDC100VN		
Power source			1 Phase 220-240V 50Hz / 220V 60Hz			
Operation data	Nominal cooling capacity (range)	kW	10.0 [4.0(Min.) ~ 11.2(Max.)]			
	Nominal heating capacity (range)	kW	11.2 [4.0(Min.) ~ 12.5(Max.)]			
	Power consumption	Cooling	kW	2.85		
		Heating		2.97		
	Max power consumption		4.16			
	Running current	Cooling	A	12.5 / 13.1		
		Heating		13.0 / 13.6		
	Inrush current, max current		5, 24			
	Power factor	Cooling	%	99		
		Heating		99		
	EER	Cooling		3.51		
	COP	Heating		3.77		
	Sound power level	Cooling	dB(A)	64		
		Heating		70		
Sound pressure level	Cooling	dB(A)	P-Hi : 46 Hi : 44 Me : 41 Lo : 39			
	Heating		49			
Silent mode sound pressure level			Cooling : 46 / Heating : 46			
Exterior dimensions (Height × Width × Depth)		mm	250 × 1,620 × 690			
Exterior appearance (Munsell color)			Plaster White (6.8Y8.9/0.2) near equivalent			
Net weight		kg	49			
Compressor type & Q'ty			—			
Compressor motor (Starting method)		kW	—			
Refrigerant oil (Amount, type)		ℓ	—			
Refrigerant (Type, amount, pre-charge length)		kg	R410A 3.8kg in outdoor unit (incl. the amount for the piping of : 30m)			
Heat exchanger			Louver fin & inner grooved tubing			
Refrigerant control			Electronic expansion valve			
Fan type & Q'ty			Turbo fan ×4			
Fan motor (Starting method)		W	30×2 < Direct line start >			
Air flow	Cooling	m³/min	P-Hi: 28 Hi: 26 Me: 23 Lo: 21			
	Heating		75			
Available external static pressure		Pa	0			
Outside air intake			Not possible			
Air filter, Quality / Quantity			Pocket plastic net ×2(Washable)			
Shock & vibration absorber			Rubber sleeve (for fan motor)			
Electric heater		W	0			
Operation control	Remote control		(option) wired : RC-EX1A, RC-E5, RCH-E3 wireless : RCN-E1R			
	Room temperature control		Thermostat by electronics			
	Operation display		RUN: Green, TIMER: Yellow, CHECK: Yellow			
Safety equipments			Internal thermostat for fan motor. Frost protection thermostat. Internal thermostat for fan motor. Abnormal discharge temperature protection.			
Installation data	Refrigerant piping size (O.D.)	mm	Liquid line: l/U φ 9.52 (3/8") Pipe φ 9.52(3/8")x0.8 O/U φ 9.52 (3/8") Gas line: φ 15.88 (5/8") φ 15.88(5/8")x1.0 φ 15.88 (5/8")			
	Connecting method		Flare piping			
	Attached length of piping	m	—			
	Insulation for piping		Necessary (both Liquid & Gas lines)			
	Refrigerant line (one way) length	m	Max.50m			
	Vertical height diff. between O.U. and I.U.	m	Max.30m (Outdoor unit is higher) Max.15m (Outdoor unit is lower)			
	Drain hose		Hose connectable with VP20 (O.D.26) Holes size φ 20 × 3pcs			
Drain pump, max lift height		mm	Built-in Drain pump			
Recommended breaker size		A	—			
L.R.A. (Locked rotor ampere)		A	5.0			
Interconnecting wires Size × Core number			φ 1.6mm×3 cores (+ earth cable 1.6mm) / Terminal block (Screw fixing type)			
IP number			IPX0 IP24			
Standard accessories			Mounting kit, Drain hose Edging			
Option parts			—			
Note (1) The data are measured at the following conditions.			The pipe length is 7.5m.			
Operation	Cooling	Indoor air temperature		Outdoor air temperature		Standards
		DB	WB	DB	WB	
	27°C	19°C	35°C	24°C		
Heating	20°C	—	7°C	6°C	ISO5151-T1	
<p>(2) This air-conditioner is manufactured and tested in conformity with the ISO.</p> <p>(3) Sound level indicates the value in an anechoic chamber. During operation these value are somewhat higher due to ambient conditions.</p> <p>(4) Select the breaker size according to the own national standard.</p> <p>(5) When wireless remote control is used, fan is 3 speed setting (Hi-Me-Lo) only.</p> <p>(6) The operation data indicate when the air-conditioner is operated at 230V50Hz or 220V60Hz.</p>						

Item		Model	FDEN100VSVF1			
			Indoor unit FDEN100VF1	Outdoor unit FDC100VS		
Power source			3 Phase 380-415V 50Hz / 380V 60Hz			
Operation data	Nominal cooling capacity (range)	kW	10.0 [4.0(Min.) ~ 11.2(Max.)]			
	Nominal heating capacity (range)	kW	11.2 [4.0(Min.) ~ 12.5(Max.)]			
	Power consumption	Cooling	kW	2.85		
		Heating		2.97		
	Max power consumption		4.16			
	Running current	Cooling	A	4.2 / 4.4		
		Heating		4.3 / 4.6		
	Inrush current, max current		5, 15			
	Power factor	Cooling	%	98		
		Heating		99 / 98		
	EER	Cooling		3.51		
	COP	Heating		3.77		
Sound power level	Cooling	dB(A)	64			
	Heating		70			
Sound pressure level	Cooling	dB(A)	P-Hi : 46 Hi : 44 Me : 41 Lo : 39			
	Heating		49			
Silent mode sound pressure level			Cooling : 46 / Heating : 46			
Exterior dimensions (Height × Width × Depth)		mm	250 × 1,620 × 690			
Exterior appearance (Munsell color)			Plaster White (6.8Y8.9/0.2) near equivalent			
Net weight		kg	49			
Compressor type & Q'ty			RMT5126MDE3×1			
Compressor motor (Starting method)		kW	Direct line start			
Refrigerant oil (Amount, type)		ℓ	0.9 M-MA68			
Refrigerant (Type, amount, pre-charge length)		kg	R410A 3.8kg in outdoor unit (incl. the amount for the piping of : 30m)			
Heat exchanger			Louver fin & inner grooved tubing			
Refrigerant control			Straight fin & inner grooved tubing			
Fan type & Q'ty			Electronic expansion valve			
Fan motor (Starting method)		W	Turbo fan ×4			
Air flow		m ³ /min	Propeller fan ×1			
Available external static pressure		Pa	30×2 < Direct line start >			
Outside air intake			86 < Direct line start >			
Air filter, Quality / Quantity			75			
Shock & vibration absorber			73			
Electric heater		W	0			
Operation control			Not possible			
Remote control			Pocket plastic net ×2(Washable)			
Room temperature control			Rubber sleeve (for fan motor)			
Operation display			Rubber sleeve (for compressor)			
Safety equipments			20 (Crank case heater)			
Refrigerant piping size (O.D.)		mm	(option) wired : RC-EX1A, RC-E5, RCH-E3 wireless : RCN-E1R			
Connecting method			Thermostat by electronics			
Attached length of piping		m	RUN: Green, TIMER: Yellow, CHECK: Yellow			
Insulation for piping			Internal thermostat for fan motor.			
Refrigerant line (one way) length		m	Frost protection thermostat.			
Vertical height diff. between O.U. and I.U.		m	Internal thermostat for fan motor.			
Drain hose			Abnormal discharge temperature protection.			
Drain pump, max lift height		mm	Liquid line: I/U φ 9.52 (3/8") Pipe φ 9.52(3/8")x0.8 O/U φ 9.52 (3/8")			
Recommended breaker size		A	Gas line: φ 15.88 (5/8") φ 15.88(5/8")x1.0 φ 15.88 (5/8")			
L.R.A. (Locked rotor ampere)		A	Flare piping			
Interconnecting wires		Size × Core number	Flare piping			
IP number			Necessary (both Liquid & Gas lines)			
Standard accessories			Max.50m			
Option parts			Max.30m (Outdoor unit is higher) Max.15m (Outdoor unit is lower)			
Note (1) The data are measured at the following conditions.			Hose connectable with VP20 (O.D.26) Holes size φ 20 × 3pcs			
			The pipe length is 7.5m.			
Operation	Item	Indoor air temperature		Outdoor air temperature		Standards
		DB	WB	DB	WB	
		Cooling	27°C	19°C	35°C	
Heating	20°C	—	7°C	6°C	ISO5151-T1	
(2) This air-conditioner is manufactured and tested in conformity with the ISO.						
(3) Sound level indicates the value in an anechoic chamber. During operation these value are somewhat higher due to ambient conditions.						
(4) Select the breaker size according to the own national standard.						
(5) When wireless remote control is used, fan is 3 speed setting (Hi-Me-Lo) only.						
(6) The operation data indicate when the air-conditioner is operated at 400V50Hz or 380V60Hz.						

Item		Model	FDEN125VNVF			
			Indoor unit FDEN125VF	Outdoor unit FDC125VN		
Power source			1 Phase 220-240V 50Hz / 220V 60Hz			
Operation data	Nominal cooling capacity (range)	kW	12.5 [5.0(Min.) ~ 14.0(Max.)]			
	Nominal heating capacity (range)	kW	14.0 [4.0(Min.) ~ 16.0(Max.)]			
	Power consumption	Cooling	kW	4.45		
		Heating		4.08		
	Max power consumption		5.79			
	Running current	Cooling	A	19.5 / 20.4		
		Heating		17.9 / 18.7		
	Inrush current, max current		5, 24			
	Power factor	Cooling	%	99		
		Heating		99		
	EER	Cooling		2.81		
	COP	Heating		3.43		
Sound power level	Cooling	dB(A)	67			
	Heating		72			
Sound pressure level	Cooling	dB(A)	P-Hi : 50 Hi : 46 Me : 44 Lo : 43			
	Heating		50			
Silent mode sound pressure level			Cooling : 46 / Heating : 48			
Exterior dimensions (Height × Width × Depth)		mm	250 × 1,620 × 690			
Exterior appearance (Munsell color)			Plaster White (6.8Y8.9/0.2) near equivalent			
Net weight		kg	49			
Compressor type & Q'ty			—			
Compressor motor (Starting method)		kW	—			
Refrigerant oil (Amount, type)		ℓ	—			
Refrigerant (Type, amount, pre-charge length)		kg	R410A 3.8kg in outdoor unit (incl. the amount for the piping of : 30m)			
Heat exchanger			Louver fin & inner grooved tubing			
Refrigerant control			Electronic expansion valve			
Fan type & Q'ty			Turbo fan ×4			
Fan motor (Starting method)		W	40×2 < Direct line start >			
Air flow	Cooling	m ³ /min	P-Hi: 32 Hi: 29 Me: 26 Lo: 23			
	Heating		75			
Available external static pressure		Pa	0			
Outside air intake			Not possible			
Air filter, Quality / Quantity			Pocket plastic net ×2(Washable)			
Shock & vibration absorber			Rubber sleeve (for fan motor)			
Electric heater		W	0			
Operation control	Remote control		(option) wired : RC-EX1A, RC-E5, RCH-E3 wireless : RCN-E1R			
	Room temperature control		Thermostat by electronics			
	Operation display		RUN: Green, TIMER: Yellow, CHECK: Yellow			
Safety equipments			Internal thermostat for fan motor. Frost protection thermostat. Internal thermostat for fan motor. Abnormal discharge temperature protection.			
Installation data	Refrigerant piping size (O.D.)	mm	Liquid line: I/U φ 9.52 (3/8") Pipe φ 9.52(3/8")x0.8 O/U φ 9.52 (3/8")			
	Connecting method		Flare piping			
	Attached length of piping	m	—			
	Insulation for piping		Necessary (both Liquid & Gas lines)			
	Refrigerant line (one way) length	m	Max.50m			
	Vertical height diff. between O.U. and I.U.	m	Max.30m (Outdoor unit is higher) Max.15m (Outdoor unit is lower)			
Drain hose			Hose connectable with VP20 (O.D.26) Holes size φ 20 × 3pcs			
Drain pump, max lift height	mm		—			
Recommended breaker size	A		—			
L.R.A. (Locked rotor ampere)	A		5.0			
Interconnecting wires	Size × Core number		φ 1.6mm×3 cores (+ earth cable 1.6mm) / Terminal block (Screw fixing type)			
IP number			IPX0			
Standard accessories			Mounting kit, Drain hose			
Option parts			—			
Note (1) The data are measured at the following conditions.			The pipe length is 7.5m.			
Operation	Item	Indoor air temperature		Outdoor air temperature		Standards
		DB	WB	DB	WB	
	Cooling	27°C	19°C	35°C	24°C	
Heating	20°C	—	7°C	6°C		
(2) This air-conditioner is manufactured and tested in conformity with the ISO.						
(3) Sound level indicates the value in an anechoic chamber. During operation these value are somewhat higher due to ambient conditions.						
(4) Select the breaker size according to the own national standard.						
(5) When wireless remote control is used, fan is 3 speed setting (Hi-Me-Lo) only.						
(6) The operation data indicate when the air-conditioner is operated at 230V50Hz or 220V60Hz.						

Item		Model	FDEN125VSVF																							
			Indoor unit FDEN125VF	Outdoor unit FDC125VS																						
Power source			3 Phase 380-415V 50Hz / 380V 60Hz																							
Operation data	Nominal cooling capacity (range)	kW	12.5 [5.0(Min.)~14.0(Max.)]																							
	Nominal heating capacity (range)	kW	14.0 [4.0(Min.)~16.0(Max.)]																							
	Power consumption	Cooling	kW	4.45																						
		Heating		4.08																						
	Max power consumption		5.79																							
	Running current	Cooling	A	6.6 / 6.8																						
		Heating		6.0 / 6.3																						
	Inrush current, max current		5, 15																							
	Power factor	Cooling	%	97 / 99																						
		Heating		98 / 99																						
	EER	Cooling		2.81																						
	COP	Heating		3.43																						
Sound power level	Cooling	dB(A)	67																							
	Heating		72																							
Sound pressure level	Cooling	dB(A)	P-Hi : 50 Hi : 46 Me : 44 Lo : 43																							
	Heating		50																							
Silent mode sound pressure level			51																							
Exterior dimensions (Height × Width × Depth)		mm	250 × 1,620 × 690																							
Exterior appearance (Munsell color)			Plaster White (6.8Y8.9/0.2) near equivalent																							
Net weight		kg	49																							
Compressor type & Q'ty			—																							
Compressor motor (Starting method)		kW	—																							
Refrigerant oil (Amount, type)		ℓ	—																							
Refrigerant (Type, amount, pre-charge length)		kg	R410A 3.8kg in outdoor unit (incl. the amount for the piping of : 30m)																							
Heat exchanger			Louver fin & inner grooved tubing																							
Refrigerant control			Straight fin & inner grooved tubing																							
Fan type & Q'ty			Electronic expansion valve																							
Fan motor (Starting method)		W	Centrifugal fan ×4																							
Air flow		m ³ /min	Propeller fan ×1																							
Available external static pressure		Pa	40×2 < Direct line start >																							
Outside air intake			86 < Direct line start >																							
Air filter, Quality / Quantity			75																							
Shock & vibration absorber			73																							
Electric heater		W	0																							
Operation control			Rubber sleeve (for fan motor)																							
Room temperature control			Rubber sleeve (for compressor)																							
Operation display			20 (Crank case heater)																							
Safety equipments			(option) wired : RC-EX1A, RC-E5, RCH-E3 wireless : RCN-E1R																							
Refrigerant piping size (O.D.)		mm	Internal thermostat for fan motor.																							
Connecting method			Frost protection thermostat.																							
Attached length of piping		m	Internal thermostat for fan motor.																							
Insulation for piping			Abnormal discharge temperature protection.																							
Refrigerant line (one way) length		m	Liquid line: I/U φ 9.52 (3/8") Pipe φ 9.52 (3/8")x0.8 O/U φ 9.52 (3/8")																							
Vertical height diff. between O.U. and I.U.		m	Gas line: φ 15.88 (5/8") φ 15.88 (5/8")x1.0 φ 15.88 (5/8")																							
Drain hose			Flare piping																							
Drain pump, max lift height		mm	Flare piping																							
Recommended breaker size		A	—																							
L.R.A. (Locked rotor ampere)		A	5.0																							
Interconnecting wires Size × Core number			φ 1.6mm×3 cores (+ earth cable 1.6mm) / Terminal block (Screw fixing type)																							
IP number			IPX0																							
Standard accessories			Mounting kit, Drain hose																							
Option parts			Edging																							
Note (1) The data are measured at the following conditions.			The pipe length is 7.5m.																							
<table border="1"> <thead> <tr> <th rowspan="2">Item</th> <th colspan="2">Indoor air temperature</th> <th colspan="2">Outdoor air temperature</th> <th rowspan="2">Standards</th> </tr> <tr> <th>DB</th> <th>WB</th> <th>DB</th> <th>WB</th> </tr> </thead> <tbody> <tr> <td>Cooling</td> <td>27°C</td> <td>19°C</td> <td>35°C</td> <td>24°C</td> <td rowspan="2">ISO5151-T1</td> </tr> <tr> <td>Heating</td> <td>20°C</td> <td>—</td> <td>7°C</td> <td>6°C</td> </tr> </tbody> </table>		Item	Indoor air temperature		Outdoor air temperature		Standards	DB	WB	DB	WB	Cooling	27°C	19°C	35°C	24°C	ISO5151-T1	Heating	20°C	—	7°C	6°C				
Item	Indoor air temperature		Outdoor air temperature		Standards																					
	DB	WB	DB	WB																						
Cooling	27°C	19°C	35°C	24°C	ISO5151-T1																					
Heating	20°C	—	7°C	6°C																						
(2) This air-conditioner is manufactured and tested in conformity with the ISO.																										
(3) Sound level indicates the value in an anechoic chamber. During operation these value are somewhat higher due to ambient conditions.																										
(4) Select the breaker size according to the own national standard.																										
(5) When wireless remote control is used, fan is 3 speed setting (Hi-Me-Lo) only.																										
(6) The operation data indicate when the air-conditioner is operated at 400V50Hz or 380V60Hz.																										

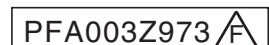

Item		Model	FDEN140VNVF			
			Indoor unit FDEN140VF	Outdoor unit FDC140VN		
Power source			1 Phase 220-240V 50Hz / 220V 60Hz			
Operation data	Nominal cooling capacity (range)	kW	14.0 [5.0(Min.) ~ 14.5(Max.)]			
	Nominal heating capacity (range)	kW	16.0 [4.0(Min.) ~ 16.5(Max.)]			
	Power consumption	Cooling	kW	5.80		
		Heating		4.92		
	Max power consumption		7.54			
	Running current	Cooling	A	25.2 / 26.0		
		Heating		21.6 / 22.6		
	Inrush current, max current		5, 26			
	Power factor	Cooling	%	99		
		Heating		99		
	EER	Cooling		2.41		
	COP	Heating		3.25		
Sound power level	Cooling	dB(A)	67			
	Heating		73			
Sound pressure level	Cooling	dB(A)	P-Hi : 50 Hi : 46 Me : 44 Lo : 43			
	Heating		51			
Silent mode sound pressure level			Cooling : 47 / Heating : 50			
Exterior dimensions (Height × Width × Depth)		mm	250 × 1,620 × 690			
Exterior appearance (Munsell color)			Plaster White (6.8Y8.9/0.2) near equivalent			
			Stucco White (4.2Y7.5/1.1) near equivalent			
Net weight		kg	49			
			81			
Compressor type & Q'ty			—			
Compressor motor (Starting method)		kW	—			
Refrigerant oil (Amount, type)		ℓ	—			
Refrigerant (Type, amount, pre-charge length)		kg	R410A 3.8kg in outdoor unit (incl. the amount for the piping of : 30m)			
Heat exchanger			Louver fin & inner grooved tubing			
Refrigerant control			Straight fin & inner grooved tubing			
Fan type & Q'ty			Electronic expansion valve			
Fan motor (Starting method)		W	Centrifugal fan ×4			
			Propeller fan ×1			
Air flow		m³/min	40×2 < Direct line start >			
	Cooling		75			
	Heating	73				
Available external static pressure		Pa	0			
Outside air intake			Not possible			
Air filter, Quality / Quantity			Pocket plastic net ×2(Washable)			
Shock & vibration absorber			Rubber sleeve (for fan motor)			
Electric heater		W	Rubber sleeve (for compressor)			
Operation control			0			
Remote control			(option) wired : RC-EX1A, RC-E5, RCH-E3 wireless : RCN-E1R			
Room temperature control			Thermostat by electronics			
Operation display			RUN: Green, TIMER: Yellow, CHECK: Yellow			
Safety equipments			Internal thermostat for fan motor. Frost protection thermostat. Internal thermostat for fan motor. Abnormal discharge temperature protection.			
Installation data	Refrigerant piping size (O.D.)	mm	Liquid line: I/U φ 9.52 (3/8") Pipe φ 9.52 (3/8")×0.8 O/U φ 9.52 (3/8")			
	Connecting method		Gas line: φ 15.88 (5/8") φ 15.88 (5/8")×1.0 φ 15.88 (5/8")			
	Attached length of piping	m	Flare piping			
	Insulation for piping		Flare piping			
	Refrigerant line (one way) length	m	Necessary (both Liquid & Gas lines)			
	Vertical height diff. between O.U. and I.U.	m	Max.50m			
Drain hose			Max.30m (Outdoor unit is higher)			
			Max.15m (Outdoor unit is lower)			
Drain pump, max lift height	mm		Hose connectable with VP20 (O.D.26)			
Recommended breaker size	A		Holes size φ 20 × 3pcs			
L.R.A. (Locked rotor ampere)	A		—			
Interconnecting wires Size × Core number			5.0			
IP number			φ 1.6mm×3 cores (+ earth cable φ1.6mm) / Terminal block (Screw fixing type)			
Standard accessories			IPX0			
Option parts			IP24			
			Mounting kit, Drain hose			
			Edging			
Note (1) The data are measured at the following conditions. The pipe length is 7.5m.						
Operation	Item	Indoor air temperature		Outdoor air temperature		Standards
		DB	WB	DB	WB	
	Cooling	27°C	19°C	35°C	24°C	
Heating	20°C	—	7°C	6°C		
(2) This air-conditioner is manufactured and tested in conformity with the ISO.						
(3) Sound level indicates the value in an anechoic chamber. During operation these value are somewhat higher due to ambient conditions.						
(4) Select the breaker size according to the own national standard.						
(5) When wireless remote control is used, fan is 3 speed setting (Hi-Me-Lo) only.						
(6) The operation data indicate when the air-conditioner is operated at 230V50Hz or 220V60Hz.						

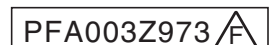

Item		Model	FDEN140VSVF			
			Indoor unit FDEN140VF	Outdoor unit FDC140VS		
Power source			3 Phase 380-415V 50Hz / 380V 60Hz			
Operation data	Nominal cooling capacity (range)	kW	14.0 [5.0(Min.)~14.5(Max.)]			
	Nominal heating capacity (range)	kW	16.0 [4.0(Min.)~16.5(Max.)]			
	Power consumption	Cooling	kW	5.80		
		Heating		4.92		
	Max power consumption		7.54			
	Running current	Cooling	A	8.6 / 9.1		
		Heating		7.2 / 7.6		
	Inrush current, max current		5, 15			
	Power factor	Cooling	%	97		
		Heating		99		
	EER	Cooling		2.41		
	COP	Heating		3.25		
	Sound power level	Cooling	dB(A)	67		
Heating		73				
Sound pressure level	Cooling	dB(A)	P-Hi : 50 Hi : 46 Me : 44 Lo : 43			
	Heating		51			
Silent mode sound pressure level			Cooling : 47 / Heating : 50			
Exterior dimensions (Height × Width × Depth)		mm	250 × 1,620 × 690			
Exterior appearance (Munsell color)			Plaster White (6.8Y8.9/0.2) near equivalent			
			Stucco White (4.2Y7.5/1.1) near equivalent			
Net weight		kg	49			
Compressor type & Q'ty			—			
Compressor motor (Starting method)		kW	—			
Refrigerant oil (Amount, type)		ℓ	—			
Refrigerant (Type, amount, pre-charge length)		kg	R410A 3.8kg in outdoor unit (incl. the amount for the piping of : 30m)			
Heat exchanger			Louver fin & inner grooved tubing			
Refrigerant control			Straight fin & inner grooved tubing			
Refrigerant control			Electronic expansion valve			
Fan type & Q'ty			Centrifugal fan ×4			
Fan motor (Starting method)		W	40×2 < Direct line start >			
Air flow		m ³ /min	Propeller fan ×1			
	Cooling		75			
	Heating	73				
Available external static pressure		Pa	0			
Outside air intake			Not possible			
Air filter, Quality / Quantity			Pocket plastic net ×2(Washable)			
Shock & vibration absorber			Rubber sleeve (for fan motor)			
Electric heater		W	Rubber sleeve (for compressor)			
Operation control			20 (Crank case heater)			
Remote control			(option) wired : RC-EX1A, RC-E5, RCH-E3 wireless : RCN-E1R			
Room temperature control			Thermostat by electronics			
Operation display			RUN: Green, TIMER: Yellow, CHECK: Yellow			
Safety equipments			Internal thermostat for fan motor. Frost protection thermostat. Internal thermostat for fan motor. Abnormal discharge temperature protection.			
Installation data	Refrigerant piping size (O.D.)	mm	Liquid line: I/U φ 9.52 (3/8") Pipe φ 9.52 (3/8")×0.8 O/U φ 9.52 (3/8")			
			Gas line: φ 15.88 (5/8") φ 15.88 (5/8")×1.0 φ 15.88 (5/8")			
	Connecting method		Flare piping			
	Attached length of piping	m	—			
	Insulation for piping		Necessary (both Liquid & Gas lines)			
	Refrigerant line (one way) length	m	Max.50m			
Vertical height diff. between O.U. and I.U.	m	Max.30m (Outdoor unit is higher)				
Drain hose		Max.15m (Outdoor unit is lower)				
Drain pump, max lift height	mm	Hose connectable with VP20 (O.D.26)				
Recommended breaker size	A	Holes size φ 20 × 3pcs				
L.R.A. (Locked rotor ampere)	A	—				
Interconnecting wires Size × Core number		5.0				
IP number		φ 1.6mm×3 cores (+ earth cable 1.6mm) / Terminal block (Screw fixing type)				
Standard accessories		IPX0				
Option parts		IP24				
Note (1) The data are measured at the following conditions		The pipe length is 7.5m.				
Operation	Item	Indoor air temperature		Outdoor air temperature		Standards
		DB	WB	DB	WB	
	Cooling	27°C	19°C	35°C	24°C	
Heating	20°C	—	7°C	6°C		
<p>(2) This air-conditioner is manufactured and tested in conformity with the ISO.</p> <p>(3) Sound level indicates the value in an anechoic chamber. During operation these value are somewhat higher due to ambient conditions.</p> <p>(4) Select the breaker size according to the own national standard.</p> <p>(5) When wireless remote control is used, fan is 3 speed setting (Hi-Me-Lo) only.</p> <p>(6) The operation data indicate when the air-conditioner is operated at 400V50Hz or 380V60Hz.</p>						

(b) Twin type

Item		Model	FDEN100VNPVF		
			Indoor unit FDEN50VF (2 units)	Outdoor unit FDC100VN	
Power source			1 Phase 220-240V 50Hz / 220V 60Hz		
Operation data	Nominal cooling capacity (range)	kW	10.0 [4.0(Min.)~11.2(Max.)]		
	Nominal heating capacity (range)	kW	11.2 [4.0(Min.)~12.5(Max.)]		
	Power consumption	Cooling	kW	3.12	
		Heating		3.49	
	Max power consumption		4.89		
	Running current	Cooling	A	13.7 / 14.3	
		Heating		15.3 / 16.0	
	Inrush current, max current		5, 24		
	Power factor	Cooling	%	99	
		Heating		99	
	EER	Cooling		3.21	
	COP	Heating		3.21	
	Sound power level	Cooling	dB(A)	60	
Heating		70			
Sound pressure level	Cooling	dB(A)	P-Hi : 46 Hi : 39 Me : 38 Lo : 37		
	Heating		49		
Silent mode sound pressure level			Cooling : 46 / Heating : 46		
Exterior dimensions (Height × Width × Depth)	mm		210 × 1,070 × 690	845×970×370	
Exterior appearance (Munsell color)			Plaster White (6.8Y8.9/0.2) near equivalent	Stucco White (4.2Y7.5/1.1) near equivalent	
Net weight	kg		28	81	
Compressor type & Q'ty			—	RMT5126MDE2×1	
Compressor motor (Starting method)	kW		—	Direct line start	
Refrigerant oil (Amount, type)	ℓ		—	0.9 M-MA68	
Refrigerant (Type, amount, pre-charge length)	kg		R410A 3.8kg (Pre-charged up to the piping length of 30m) Outdoor unit		
Heat exchanger			Louver fin & inner grooved tubing	Straight fin & inner grooved tubing	
Refrigerant control			Electronic expansion valve		
Fan type & Q'ty			Centrifugal fan ×2	Propeller fan ×1	
Fan motor (Starting method)	W		25 < Direct line start >	86 < Direct line start >	
Air flow	Cooling	m³/min	P-Hi : 11 Hi : 10 Me : 9 Lo : 7		
	Heating		75		
Available external static pressure	Pa		0		
Outside air intake			Not possible		
Air filter, Quality / Quantity			Pocket plastic net ×2(Washable)		
Shock & vibration absorber			Rubber sleeve (for fan motor)	Rubber sleeve (for compressor)	
Electric heater	W		—	20 (Crank case heater)	
Operation control	Remote control		(option) wired : RC-EX1A, RC-E5, RCH-E3 wireless : RCN-E1R		
	Room temperature control		Thermostat by electronics		
Operation display			RUN: Green, TIMER: Yellow, CHECK: Yellow		
Safety equipments			Internal thermostat for fan motor.		
			Frost protection thermostat.		
			Internal thermostat for fan motor.		
			Abnormal discharge temperature protection.		
Installation data	Refrigerant piping size (O.D.)	mm	Liquid line: I/U φ 6.35 (1/4") ② φ 9.52(3/8")×0.8 ① φ 9.52(3/8")×0.8 O/U φ 9.52 (3/8")		
	Connecting method		Gas line: I/U φ 12.7 (1/2") ② φ 12.7(1/2")×0.8 ① φ 15.88(5/8")×1.0 O/U φ 15.88 (5/8")		
	Attached length of piping	m	Flare piping		
	Insulation for piping		Necessary (both Liquid & Gas lines)		
	Refrigerant line (one way) length	m	Max.50m		
	Vertical height diff. between O.U. and I.U.	m	Max.30m (Outdoor unit is higher) Max.15m (Outdoor unit is lower)		
Drain hose			Hose connectable with VP20 (O.D.26)	Holes size φ 20 × 3pcs	
Drain pump, max lift height	mm		—		
Recommended breaker size	A		—		
L.R.A. (Locked rotor ampere)	A		5.0		
Interconnecting wires Size × Core number			φ 1.6mm×3 cores (+ earth cable 1.6mm) / Terminal block (Screw fixing type)		
IP number			IPX0	IP24	
Standard accessories			Mounting kit, Drain hose	Edging	
Option parts			—		

Note (1) The data are measured at the following conditions.

The pipe length is 7.5m.

Item	Indoor air temperature		Outdoor air temperature		Standards
	DB	WB	DB	WB	
Cooling	27°C	19°C	35°C	24°C	ISO5151-T1
Heating	20°C	—	7°C	6°C	

(2) This air-conditioner is manufactured and tested in conformity with the ISO.

(3) Sound level indicates the value in an anechoic chamber. During operation these value are somewhat higher due to ambient conditions.

(4) Select the breaker size according to the own national standard.

(5) When wireless remote control is used, fan is 3 speed setting (Hi-Me-Lo) only.

(6) The operation data indicate when the air-conditioner is operated at 230V50Hz or 220V60Hz.

(7) Indoor unit specifications for one unit. Capacity and operation data are two indoor units are combined and run together.

(8) Branching pipe set "DIS-WA1"×1(option). ① : Pipe of O/U~Branch, ② : Pipe of Branch~I/U

Item		Model	FDEN100VSPVF		
			Indoor unit FDEN50VF (2 units)	Outdoor unit FDC100VS	
Power source			3 Phase 380-415V 50Hz / 380V 60Hz		
Operation data	Nominal cooling capacity (range)	kW	10.0 [4.0(Min.)~11.2(Max.)]		
	Nominal heating capacity (range)	kW	11.2 [4.0(Min.)~12.5(Max.)]		
	Power consumption	Cooling	kW	3.12	
		Heating		3.49	
	Max power consumption		4.89		
	Running current	Cooling	A	4.6 / 4.8	
		Heating		5.1 / 5.4	
	Inrush current, max current		5, 15		
	Power factor	Cooling	%	98	
		Heating		99	
	EER	Cooling		3.21	
	COP	Heating		3.21	
Sound power level	Cooling	dB(A)	60	70	
	Heating				
Sound pressure level	Cooling	dB(A)	P-Hi : 46 Hi : 39 Me : 38 Lo : 37		
	Heating		49		
Silent mode sound pressure level			Cooling : 46 / Heating : 46		
Exterior dimensions (Height × Width × Depth)		mm	210 × 1,070 × 690		
Exterior appearance (Munsell color)			Plaster White (6.8Y8.9/0.2) near equivalent		
Net weight		kg	28		
Compressor type & Q'ty			RMT5126MDE3×1		
Compressor motor (Starting method)		kW	Direct line start		
Refrigerant oil (Amount, type)		ℓ	0.9 M-MA68		
Refrigerant (Type, amount, pre-charge length)		kg	R410A 3.8kg (Pre-charged up to the piping length of 30m) Outdoor unit		
Heat exchanger			Louver fin & inner grooved tubing		
Refrigerant control			Straight fin & inner grooved tubing		
Fan type & Q'ty			Electronic expansion valve		
Fan motor (Starting method)		W	Centrifugal fan ×2		
Air flow		m ³ /min	Propeller fan ×1		
Available external static pressure		Pa	25 < Direct line start >		
Outside air intake			86 < Direct line start >		
Air filter, Quality / Quantity			75		
Shock & vibration absorber			73		
Electric heater		W	0		
Operation control			Not possible		
Remote control			Pocket plastic net ×2(Washable)		
Room temperature control			Rubber sleeve (for fan motor)		
Operation display			Rubber sleeve (for compressor)		
Safety equipments			20 (Crank case heater)		
Refrigerant piping size (O.D.)		mm	(option) wired : RC-EX1A, RC-E5, RCH-E3 wireless : RCN-E1R		
Connecting method			Thermostat by electronics		
Attached length of piping		m	RUN: Green, TIMER: Yellow, CHECK: Yellow		
Insulation for piping			Internal thermostat for fan motor.		
Refrigerant line (one way) length		m	Frost protection thermostat.		
Vertical height diff. between O.U. and I.U.		m	Internal thermostat for fan motor.		
Drain hose			Abnormal discharge temperature protection.		
Drain pump, max lift height		mm	Liquid line: I/U φ 6.35 (1/4") ② φ 9.52(3/8")x0.8 ① φ 9.52(3/8")x0.8 O/U φ 9.52 (3/8")		
Recommended breaker size		A	Gas line: I/U φ 12.7 (1/2") ② φ 12.7(1/2")x0.8 ① φ 15.88(5/8")x1.0 O/U φ 15.88 (5/8")		
L.R.A. (Locked rotor ampere)		A	Flare piping		
Interconnecting wires Size × Core number			Flare piping		
IP number			Necessary (both Liquid & Gas lines)		
Standard accessories			Max.50m		
Option parts			Max.30m (Outdoor unit is higher)		
Note (1) The data are measured at the following conditions.			Max.15m (Outdoor unit is lower)		
The pipe length is 7.5m.			Hose connectable with VP20 (O.D.26)		
			Holes size φ 20 × 3pcs		
			—		
			5.0		
			φ 1.6mm×3 cores (+ earth cable 1.6mm) / Terminal block (Screw fixing type)		
			IPX0		
			IP24		
			Mounting kit, Drain hose		
			Edging		
			—		
Note (1) The data are measured at the following conditions.			The pipe length is 7.5m.		
Operation	Indoor air temperature	Outdoor air temperature		Standards	
		DB	WB		DB
	27°C	19°C	35°C		24°C
20°C	—	7°C	6°C		
(2) This air-conditioner is manufactured and tested in conformity with the ISO. (3) Sound level indicates the value in an anechoic chamber. During operation these value are somewhat higher due to ambient conditions. (4) Select the breaker size according to the own national standard. (5) When wireless remote control is used, fan is 3 speed setting (Hi-Me-Lo) only. (6) The operation data indicate when the air-conditioner is operated at 400V50Hz or 380V60Hz. (7) Indoor unit specifications for one unit. Capacity and operation data are two indoor units are combined and run together. (8) Branching pipe set "DIS-WA1"×1(option). ① : Pipe of O/U~Branch, ② : Pipe of Branch~I/U					

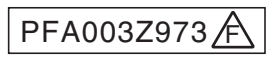

Item		Model	FDEN125VNPVF																						
			Indoor unit FDEN60VF (2 units)	Outdoor unit FDC125VN																					
Power source			1 Phase 220-240V 50Hz / 220V 60Hz																						
Operation data	Nominal cooling capacity (range)	kW	12.5 [5.0(Min.)~14.0(Max.)]																						
	Nominal heating capacity (range)	kW	14.0 [4.0(Min.)~16.0(Max.)]																						
	Power consumption	Cooling	kW	4.23																					
		Heating		3.83																					
	Max power consumption		5.50																						
	Running current	Cooling	A	18.5 / 19.4																					
		Heating		16.8 / 17.6																					
	Inrush current, max current		5, 24																						
	Power factor	Cooling	%	99																					
		Heating		99																					
	EER	Cooling		2.96																					
	COP	Heating		3.66																					
	Sound power level	Cooling	dB(A)	60																					
Heating		72																							
Sound pressure level	Cooling	dB(A)	P-Hi : 48 Hi : 41 Me : 39 Lo : 38																						
	Heating		50																						
Silent mode sound pressure level			Cooling : 46 / Heating : 48																						
Exterior dimensions (Height × Width × Depth)		mm	210 × 1,320 × 690																						
Exterior appearance (Munsell color)			Plaster White (6.8Y8.9/0.2) near equivalent																						
Net weight		kg	37																						
Compressor type & Q'ty			—																						
Compressor motor (Starting method)		kW	—																						
Refrigerant oil (Amount, type)		ℓ	—																						
Refrigerant (Type, amount, pre-charge length)		kg	R410A 3.8kg (Pre-charged up to the piping length of 30m) Outdoor unit																						
Heat exchanger			Louver fin & inner grooved tubing																						
Refrigerant control			Electronic expansion valve																						
Fan type & Q'ty			Centrifugal fan ×4																						
Fan motor (Starting method)		W	20×2 < Direct line start >																						
Air flow	Cooling	m³/min	P-Hi : 20 Hi : 16 Me : 14 Lo : 12																						
	Heating		75																						
Available external static pressure		Pa	0																						
Outside air intake			Not possible																						
Air filter, Quality / Quantity			Pocket plastic net ×2(Washable)																						
Shock & vibration absorber			Rubber sleeve (for fan motor)																						
Electric heater		W	—																						
Operation control	Remote control		(option) wired : RC-EX1A, RC-E5, RCH-E3 wireless : RCN-E1R																						
	Room temperature control		Thermostat by electronics																						
	Operation display		RUN: Green, TIMER: Yellow, CHECK: Yellow																						
Safety equipments			Internal thermostat for fan motor. Frost protection thermostat. Internal thermostat for fan motor. Abnormal discharge temperature protection.																						
Installation data	Refrigerant piping size (O.D.)	mm	Liquid line: I/U φ 6.35 (1/4") ② φ 9.52(3/8")x0.8 ① φ 9.52(3/8")x0.8 O/U φ 9.52 (3/8") Gas line: I/U φ 12.7 (1/2") ② φ 12.7(1/2")x0.8 ① φ 15.88(5/8")x1.0 O/U φ 15.88 (5/8")																						
	Connecting method		Flare piping																						
	Attached length of piping	m	—																						
	Insulation for piping		Necessary (both Liquid & Gas lines)																						
	Refrigerant line (one way) length	m	Max.50m																						
	Vertical height diff. between O.U. and I.U.	m	Max.30m (Outdoor unit is higher) Max.15m (Outdoor unit is lower)																						
Drain hose			Hose connectable with VP20 (O.D.26) Holes size φ 20 × 3pcs																						
Drain pump, max lift height	mm		—																						
Recommended breaker size	A		—																						
L.R.A. (Locked rotor ampere)	A		5.0																						
Interconnecting wires Size × Core number			φ 1.6mm×3 cores (+ earth cable 1.6mm) / Terminal block (Screw fixing type)																						
IP number			IPX0 IP24																						
Standard accessories			Mounting kit, Drain hose Edging																						
Option parts			—																						
Note (1) The data are measured at the following conditions.			The pipe length is 7.5m.																						
<table border="1"> <thead> <tr> <th rowspan="2">Item</th> <th colspan="2">Indoor air temperature</th> <th colspan="2">Outdoor air temperature</th> <th rowspan="2">Standards</th> </tr> <tr> <th>DB</th> <th>WB</th> <th>DB</th> <th>WB</th> </tr> </thead> <tbody> <tr> <td>Cooling</td> <td>27°C</td> <td>19°C</td> <td>35°C</td> <td>24°C</td> <td rowspan="2">ISO5151-T1</td> </tr> <tr> <td>Heating</td> <td>20°C</td> <td>—</td> <td>7°C</td> <td>6°C</td> </tr> </tbody> </table>					Item	Indoor air temperature		Outdoor air temperature		Standards	DB	WB	DB	WB	Cooling	27°C	19°C	35°C	24°C	ISO5151-T1	Heating	20°C	—	7°C	6°C
Item	Indoor air temperature		Outdoor air temperature			Standards																			
	DB	WB	DB	WB																					
Cooling	27°C	19°C	35°C	24°C	ISO5151-T1																				
Heating	20°C	—	7°C	6°C																					
<p>(2) This air-conditioner is manufactured and tested in conformity with the ISO.</p> <p>(3) Sound level indicates the value in an anechoic chamber. During operation these value are somewhat higher due to ambient conditions.</p> <p>(4) Select the breaker size according to the own national standard.</p> <p>(5) When wireless remote control is used, fan is 3 speed setting (Hi-Me-Lo) only.</p> <p>(6) The operation data indicate when the air-conditioner is operated at 230V50Hz or 220V60Hz.</p> <p>(7) Indoor unit specifications for one unit. Capacity and operation data are two indoor units are combined and run together.</p> <p>(8) Branching pipe set "DIS-WA1"×1(option). ① : Pipe of O/U~Branch, ② : Pipe of Branch~I/U</p>																									

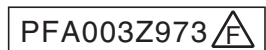

Item		Model	FDEN125VSPVF		
			Indoor unit FDEN60VF (2 units)	Outdoor unit FDC125VS	
Power source			3 Phase 380-415V 50Hz / 380V 60Hz		
Operation data	Nominal cooling capacity (range)	kW	12.5 [5.0(Min.)~14.0(Max.)]		
	Nominal heating capacity (range)	kW	14.0 [4.0(Min.)~16.0(Max.)]		
	Power consumption	Cooling	kW	4.23	
		Heating		3.83	
	Max power consumption		5.50		
	Running current	Cooling	A	6.2 / 6.5	
		Heating		5.6 / 5.9	
	Inrush current, max current		5, 15		
	Power factor	Cooling	%	98 / 99	
		Heating		99	
	EER	Cooling		2.96	
	COP	Heating		3.66	
	Sound power level	Cooling	dB(A)	60	
		Heating		72	
Sound pressure level	Cooling	dB(A)	P-Hi : 48 Hi : 41 Me : 39 Lo : 38		
	Heating		50		
Silent mode sound pressure level			Cooling : 46 / Heating : 48		
Exterior dimensions (Height × Width × Depth)		mm	210 × 1,320 × 690		
Exterior appearance (Munsell color)			Plaster White (6.8Y8.9/0.2) near equivalent		
Net weight		kg	37		
Compressor type & Q'ty			—		
Compressor motor (Starting method)		kW	—		
Refrigerant oil (Amount, type)		ℓ	—		
Refrigerant (Type, amount, pre-charge length)		kg	R410A 3.8kg (Pre-charged up to the piping length of 30m) Outdoor unit		
Heat exchanger			Louver fin & inner grooved tubing		
Refrigerant control			Straight fin & inner grooved tubing		
Fan type & Q'ty			Electronic expansion valve		
Fan motor (Starting method)		W	Centrifugal fan ×4		
Air flow		m ³ /min	Propeller fan ×1		
Available external static pressure		Pa	20×2 < Direct line start >		
Outside air intake			86 < Direct line start >		
Air filter, Quality / Quantity			75		
Shock & vibration absorber			73		
Electric heater		W	0		
Operation control			Not possible		
Remote control			Pocket plastic net ×2(Washable)		
Room temperature control			Rubber sleeve (for fan motor)		
Operation display			Rubber sleeve (for compressor)		
Safety equipments			20 (Crank case heater)		
Refrigerant piping size (O.D.)		mm	(option) wired : RC-EX1A, RC-E5, RCH-E3 wireless : RCN-E1R		
Connecting method			Thermostat by electronics		
Attached length of piping		m	RUN: Green, TIMER: Yellow, CHECK: Yellow		
Insulation for piping			Internal thermostat for fan motor.		
Refrigerant line (one way) length		m	Frost protection thermostat.		
Vertical height diff. between O.U. and I.U.		m	Internal thermostat for fan motor.		
Drain hose			Abnormal discharge temperature protection.		
Drain pump, max lift height		mm	Liquid line: I/U φ 6.35 (1/4") ② φ 9.52(3/8")x0.8 ① φ 9.52(3/8")x0.8 O/U φ 9.52 (3/8")		
Recommended breaker size		A	Gas line: I/U φ 12.7 (1/2") ② φ 12.7(1/2")x0.8 ① φ 15.88(5/8")x1.0 O/U φ 15.88 (5/8")		
L.R.A. (Locked rotor ampere)		A	Flare piping		
Interconnecting wires Size × Core number			Flare piping		
IP number			Necessary (both Liquid & Gas lines)		
Standard accessories			Max.50m		
Option parts			Max.30m (Outdoor unit is higher)		
Note (1) The data are measured at the following conditions.			Max.15m (Outdoor unit is lower)		
The pipe length is 7.5m.			Hose connectable with VP20 (O.D.26)		
			Holes size φ 20 × 3pcs		
			—		
			5.0		
			φ 1.6mm×3 cores (+ earth cable 1.6mm) / Terminal block (Screw fixing type)		
			IPX0		
			IP24		
			Mounting kit, Drain hose		
			Edging		
			—		
Note (1) The data are measured at the following conditions.			The pipe length is 7.5m.		
Operation	Indoor air temperature	Outdoor air temperature		Standards	
		DB	WB		DB
	27°C	19°C	35°C		24°C
20°C	—	7°C	6°C		
(2) This air-conditioner is manufactured and tested in conformity with the ISO. (3) Sound level indicates the value in an anechoic chamber. During operation these value are somewhat higher due to ambient conditions. (4) Select the breaker size according to the own national standard. (5) When wireless remote control is used, fan is 3 speed setting (Hi-Me-Lo) only. (6) The operation data indicate when the air-conditioner is operated at 400V50Hz or 380V60Hz. (7) Indoor unit specifications for one unit. Capacity and operation data are two indoor units are combined and run together. (8) Branching pipe set "DIS-WA1"×1(option). ① : Pipe of O/U~Branch, ② : Pipe of Branch~I/U					

PFA003Z973 

Item		Model	FDEN140VNPVF1																						
			Indoor unit FDEN71VF1 (2 units)	Outdoor unit FDC140VN																					
Power source			1 Phase 220-240V 50Hz / 220V 60Hz																						
Operation data	Nominal cooling capacity (range)	kW	14.0 [5.0(Min.)~14.5(Max.)]																						
	Nominal heating capacity (range)	kW	16.0 [4.0(Min.)~16.5(Max.)]																						
	Power consumption	Cooling	kW	4.87																					
		Heating		4.59																					
	Max power consumption		6.33																						
	Running current	Cooling	A	21.6 / 22.6																					
		Heating		20.1 / 21.0																					
	Inrush current, max current		5, 24																						
	Power factor	Cooling	%	98																					
		Heating		99																					
	EER	Cooling		2.87																					
	COP	Heating		3.49																					
Sound power level	Cooling	dB(A)	62																						
	Heating		73																						
Sound pressure level	Cooling		P-Hi : 51 Hi : 41 Me : 39 Lo : 38																						
	Heating		51																						
Silent mode sound pressure level			Cooling : 47 / Heating : 50																						
Exterior dimensions (Height × Width × Depth)		mm	210 × 1,320 × 690																						
Exterior appearance (Munsell color)			Plaster White (6.8Y8.9/0.2) near equivalent																						
			Stucco White (4.2Y7.5/1.1) near equivalent																						
Net weight		kg	37																						
Compressor type & Q'ty			—																						
Compressor motor (Starting method)		kW	—																						
Refrigerant oil (Amount, type)		ℓ	—																						
Refrigerant (Type, amount, pre-charge length)		kg	R410A 3.8kg (Pre-charged up to the piping length of 30m) Outdoor unit																						
Heat exchanger			Louver fin & inner grooved tubing																						
Refrigerant control			Straight fin & inner grooved tubing																						
Refrigerant control			Electronic expansion valve																						
Fan type & Q'ty			Centrifugal fan ×4																						
Fan motor (Starting method)		W	20×2 < Direct line start >																						
			86 < Direct line start >																						
Air flow	Cooling	m³/min	P-Hi : 20 Hi : 16 Me : 14 Lo : 12																						
	Heating		75																						
Available external static pressure		Pa	0																						
Outside air intake			Not possible																						
Air filter, Quality / Quantity			Pocket plastic net ×2(Washable)																						
Shock & vibration absorber			Rubber sleeve (for fan motor)																						
Electric heater		W	—																						
			20 (Crank case heater)																						
Operation control	Remote control		(option) wired : RC-EX1A, RC-E5, RCH-E3 wireless : RCN-E1R																						
	Room temperature control		Thermostat by electronics																						
	Operation display		RUN: Green, TIMER: Yellow, CHECK: Yellow																						
Safety equipments			Internal thermostat for fan motor. Frost protection thermostat. Internal thermostat for fan motor. Abnormal discharge temperature protection.																						
Installation data	Refrigerant piping size (O.D.)	mm	Liquid line: I/U φ 9.52 (3/8") ② φ 9.52(3/8")x0.8 ① φ 9.52(3/8")x0.8 O/U φ 9.52 (3/8") Gas line: I/U φ 15.88 (5/8") ② φ 15.88(5/8")x1.0 ① φ 15.88(5/8")x1.0 O/U φ 15.88 (5/8")																						
	Connecting method		Flare piping																						
	Attached length of piping	m	—																						
	Insulation for piping		Necessary (both Liquid & Gas lines)																						
	Refrigerant line (one way) length	m	Max.50m																						
	Vertical height diff. between O.U. and I.U.	m	Max.30m (Outdoor unit is higher) Max.15m (Outdoor unit is lower)																						
	Drain hose		Hose connectable with VP20 (O.D.26) Holes size φ 20 × 3pcs																						
Drain pump, max lift height		mm	—																						
Recommended breaker size		A	—																						
L.R.A. (Locked rotor ampere)		A	5.0																						
Interconnecting wires Size × Core number			φ 1.6mm×3 cores (+ earth cable 1.6mm) / Terminal block (Screw fixing type)																						
IP number			IPX0 IP24																						
Standard accessories			Mounting kit, Drain hose Edging																						
Option parts			—																						
Note (1) The data are measured at the following conditions.			The pipe length is 7.5m.																						
<table border="1"> <thead> <tr> <th rowspan="2">Item</th> <th colspan="2">Indoor air temperature</th> <th colspan="2">Outdoor air temperature</th> <th rowspan="2">Standards</th> </tr> <tr> <th>DB</th> <th>WB</th> <th>DB</th> <th>WB</th> </tr> </thead> <tbody> <tr> <td>Cooling</td> <td>27°C</td> <td>19°C</td> <td>35°C</td> <td>24°C</td> <td rowspan="2">ISO5151-T1</td> </tr> <tr> <td>Heating</td> <td>20°C</td> <td>—</td> <td>7°C</td> <td>6°C</td> </tr> </tbody> </table>		Item	Indoor air temperature		Outdoor air temperature		Standards	DB	WB	DB	WB	Cooling	27°C	19°C	35°C	24°C	ISO5151-T1	Heating	20°C	—	7°C	6°C			
Item	Indoor air temperature		Outdoor air temperature		Standards																				
	DB	WB	DB	WB																					
Cooling	27°C	19°C	35°C	24°C	ISO5151-T1																				
Heating	20°C	—	7°C	6°C																					
(2) This air-conditioner is manufactured and tested in conformity with the ISO.																									
(3) Sound level indicates the value in an anechoic chamber. During operation these value are somewhat higher due to ambient conditions.																									
(4) Select the breaker size according to the own national standard.																									
(5) When wireless remote control is used, fan is 3 speed setting (Hi-Me-Lo) only.																									
(6) The operation data indicate when the air-conditioner is operated at 230V50Hz or 220V60Hz.																									
(7) Indoor unit specifications for one unit. Capacity and operation data are two indoor units are combined and run together.																									
(8) Branching pipe set "DIS-WA1"×1(option). ① : Pipe of O/U~Branch, ② : Pipe of Branch~I/U																									

PFA003Z973 

Item		Model	FDEN140VSPVF1																						
			Indoor unit FDEN71VF1 (2 units)	Outdoor unit FDC140VS																					
Power source			3 Phase 380-415V 50Hz / 380V 60Hz																						
Operation data	Nominal cooling capacity (range)	kW	14.0 [5.0(Min.)~14.5(Max.)]																						
	Nominal heating capacity (range)	kW	16.0 [4.0(Min.)~16.5(Max.)]																						
	Power consumption	Cooling	kW	4.87																					
		Heating		4.59																					
	Max power consumption		6.33																						
	Running current	Cooling	A	7.2 / 7.6																					
		Heating		6.7 / 7.1																					
	Inrush current, max current		5, 15																						
	Power factor	Cooling	%	98																					
		Heating		99 / 98																					
	EER	Cooling		2.87																					
	COP	Heating		3.49																					
Sound power level	Cooling	dB(A)	62																						
	Heating		73																						
Sound pressure level	Cooling	dB(A)	P-Hi : 50 Hi : 41 Me : 39 Lo : 38																						
	Heating		51																						
Silent mode sound pressure level			Cooling : 47 / Heating : 50																						
Exterior dimensions (Height × Width × Depth)		mm	210 × 1,320 × 690																						
Exterior appearance (Munsell color)			Plaster White (6.8Y8.9/0.2) near equivalent																						
			Stucco White (4.2Y7.5/1.1) near equivalent																						
Net weight		kg	37																						
Compressor type & Q'ty			—																						
Compressor motor (Starting method)		kW	—																						
Refrigerant oil (Amount, type)		ℓ	—																						
Refrigerant (Type, amount, pre-charge length)		kg	R410A 3.8kg (Pre-charged up to the piping length of 30m) Outdoor unit																						
Heat exchanger			Louver fin & inner grooved tubing																						
Refrigerant control			Straight fin & inner grooved tubing																						
Refrigerant control			Electronic expansion valve																						
Fan type & Q'ty			Centrifugal fan ×4																						
Fan motor (Starting method)		W	20×2 < Direct line start >																						
Fan motor (Starting method)			86 < Direct line start >																						
Air flow	Cooling	m³/min	P-Hi : 20 Hi : 16 Me : 14 Lo : 12																						
	Heating		75																						
Available external static pressure		Pa	0																						
Outside air intake			Not possible																						
Air filter, Quality / Quantity			Pocket plastic net ×2(Washable)																						
Shock & vibration absorber			Rubber sleeve (for fan motor)																						
Electric heater		W	—																						
Electric heater			20 (Crank case heater)																						
Operation control	Remote control		(option) wired : RC-EX1A, RC-E5, RCH-E3 wireless : RCN-E1R																						
	Room temperature control		Thermostat by electronics																						
	Operation display		RUN: Green, TIMER: Yellow, CHECK: Yellow																						
Safety equipments			Internal thermostat for fan motor. Frost protection thermostat. Internal thermostat for fan motor. Abnormal discharge temperature protection.																						
Installation data	Refrigerant piping size (O.D.)	mm	Liquid line: I/U φ 9.52(3/8") ② φ 9.52(3/8")×0.8 ① φ 9.52(3/8")×0.8 O/U φ 9.52 (3/8") Gas line: I/U φ 15.88 (5/8") ② φ 15.88 (5/8")×1.0 ① φ 15.88(5/8")×1.0 O/U φ 15.88 (5/8")																						
	Connecting method		Flare piping																						
	Attached length of piping	m	—																						
	Insulation for piping		Necessary (both Liquid & Gas lines)																						
	Refrigerant line (one way) length	m	Max.50m																						
	Vertical height diff. between O.U. and I.U.	m	Max.30m (Outdoor unit is higher) Max.15m (Outdoor unit is lower)																						
	Drain hose		Hose connectable with VP20 (O.D.26) Holes size φ 20 × 3pcs																						
Drain pump, max lift height	mm	—																							
Recommended breaker size	A	—																							
L.R.A. (Locked rotor ampere)	A	5.0																							
Interconnecting wires Size × Core number		φ 1.6mm×3 cores (+ earth cable 1.6mm) / Terminal block (Screw fixing type)																							
IP number		IPX0 IP24																							
Standard accessories		Mounting kit, Drain hose Edging																							
Option parts		—																							
Note (1) The data are measured at the following conditions.			The pipe length is 7.5m.																						
<table border="1"> <thead> <tr> <th rowspan="2">Operation</th> <th colspan="2">Indoor air temperature</th> <th colspan="2">Outdoor air temperature</th> <th rowspan="2">Standards</th> </tr> <tr> <th>DB</th> <th>WB</th> <th>DB</th> <th>WB</th> </tr> </thead> <tbody> <tr> <td>Cooling</td> <td>27°C</td> <td>19°C</td> <td>35°C</td> <td>24°C</td> <td rowspan="2">ISO5151-T1</td> </tr> <tr> <td>Heating</td> <td>20°C</td> <td>—</td> <td>7°C</td> <td>6°C</td> </tr> </tbody> </table>					Operation	Indoor air temperature		Outdoor air temperature		Standards	DB	WB	DB	WB	Cooling	27°C	19°C	35°C	24°C	ISO5151-T1	Heating	20°C	—	7°C	6°C
Operation	Indoor air temperature		Outdoor air temperature			Standards																			
	DB	WB	DB	WB																					
Cooling	27°C	19°C	35°C	24°C	ISO5151-T1																				
Heating	20°C	—	7°C	6°C																					
(2) This air-conditioner is manufactured and tested in conformity with the ISO.																									
(3) Sound level indicates the value in an anechoic chamber. During operation these value are somewhat higher due to ambient conditions.																									
(4) Select the breaker size according to the own national standard.																									
(5) When wireless remote control is used, fan is 3 speed setting (Hi-Me-Lo) only.																									
(6) The operation data indicate when the air-conditioner is operated at 400V50Hz or 380V60Hz.																									
(7) Indoor unit specifications for one unit. Capacity and operation data are two indoor units are combined and run together.																									
(8) Branching pipe set "DIS-WA1"×1(option). ① : Pipe of O/U~Branch, ② : Pipe of Branch~I/U																									

PFA003Z973 

Item		Model	FDEN200VSPVF1																						
			Indoor unit FDEN100VF1 (2 units)	Outdoor unit FDC200VS																					
Power source			3 Phase 380-415V 50Hz / 380V 60Hz																						
Operation data	Nominal cooling capacity (range)	kW	20.0 [7.0(Min.)~22.4(Max.)]																						
	Nominal heating capacity (range)	kW	22.4 [7.6(Min.)~25.0(Max.)]																						
	Power consumption	Cooling	kW	6.47																					
		Heating		5.97																					
	Max power consumption		8.22																						
	Running current	Cooling	A	9.7 / 10.1																					
		Heating		9.1 / 9.5																					
	Inrush current, max current		5, 19																						
	Power factor	Cooling	%	96 / 97																					
		Heating		95																					
	EER	Cooling		3.09																					
	COP	Heating		3.75																					
Sound power level	Cooling	dB(A)	64																						
	Heating		74																						
Sound pressure level	Cooling	dB(A)	P-Hi : 46 Hi : 44 Me : 41 Lo : 39																						
	Heating		57																						
Silent mode sound pressure level			Cooling : 56 / Heating : 56																						
Exterior dimensions (Height × Width × Depth)		mm	250 × 1,620 × 690																						
Exterior appearance (Munsell color)			Plaster White (6.8Y8.9/0.2) near equivalent																						
			Stucco White (4.2Y7.5/1.1) near equivalent																						
Net weight		kg	49																						
Compressor type & Q'ty			—																						
Compressor motor (Starting method)		kW	—																						
Refrigerant oil (Amount, type)		ℓ	—																						
Refrigerant (Type, amount, pre-charge length)		kg	R410A 5.4kg (Pre-charged up to the piping length of 30m) Outdoor unit																						
Heat exchanger			Louver fin & inner grooved tubing																						
Refrigerant control			Straight fin & inner grooved tubing																						
Fan type & Q'ty			Electronic expansion valve																						
Fan motor (Starting method)		W	Centrifugal fan ×4																						
			Propeller fan ×2																						
Air flow		m³/min	30 ×2 < Direct line start >																						
	Cooling		86 ×2 < Direct line start >																						
Available external static pressure		Pa	0																						
Outside air intake			Not possible																						
Air filter, Quality / Quantity			Pocket plastic net ×2(Washable)																						
Shock & vibration absorber			Rubber sleeve (for fan motor)																						
Electric heater		W	Rubber sleeve (for compressor)																						
Operation control			33 (Crank case heater)																						
Remote control			(option) wired : RC-EX1A, RC-E5, RCH-E3 wireless : RCN-E1R																						
Room temperature control			Thermostat by electronics																						
Operation display			RUN: Green, TIMER: Yellow, CHECK: Yellow																						
Safety equipments			Internal thermostat for fan motor. Frost protection thermostat. Internal thermostat for fan motor. Abnormal discharge temperature protection.																						
Installation data	Refrigerant piping size (O.D.)	mm	Liquid line: I/U φ 9.52(3/8") ② φ 9.52(3/8")x0.8 ① φ 9.52(3/8")x0.8 O/U φ 9.52 (3/8")																						
	Connecting method		Gas line: I/U φ 15.88 (5/8") ② φ 15.88 (5/8")x1.0 ① φ 22.22(7/8")x1.6 O/U φ 22.22(7/8")																						
	Attached length of piping	m	Flare piping																						
	Insulation for piping		Liquid : Flare / Gas : Brazing																						
	Refrigerant line (one way) length	m	Necessary (both Liquid & Gas lines)																						
	Vertical height diff. between O.U. and I.U.	m	Max.70m																						
	Drain hose		Max.30m (Outdoor unit is higher) Max.15m (Outdoor unit is lower)																						
Drain pump, max lift height	mm	Hose connectable with VP20 (O.D.26)																							
Recommended breaker size	A	Holes size φ 20 × 3pcs																							
L.R.A. (Locked rotor ampere)	A	—																							
Interconnecting wires Size × Core number		5.0																							
IP number		φ 1.6mm×3 cores (+ earth cable 1.6mm) / Terminal block (Screw fixing type)																							
Standard accessories		IPX0																							
Option parts		IP24																							
Note (1) The data are measured at the following conditions.		The pipe length is 7.5m.																							
<table border="1"> <thead> <tr> <th rowspan="2">Item</th> <th colspan="2">Indoor air temperature</th> <th colspan="2">Outdoor air temperature</th> <th rowspan="2">Standards</th> </tr> <tr> <th>DB</th> <th>WB</th> <th>DB</th> <th>WB</th> </tr> </thead> <tbody> <tr> <td>Cooling</td> <td>27°C</td> <td>19°C</td> <td>35°C</td> <td>24°C</td> <td rowspan="2">ISO5151-T1</td> </tr> <tr> <td>Heating</td> <td>20°C</td> <td>—</td> <td>7°C</td> <td>6°C</td> </tr> </tbody> </table>		Item	Indoor air temperature		Outdoor air temperature		Standards	DB	WB	DB	WB	Cooling	27°C	19°C	35°C	24°C	ISO5151-T1	Heating	20°C	—	7°C	6°C			
Item	Indoor air temperature		Outdoor air temperature		Standards																				
	DB	WB	DB	WB																					
Cooling	27°C	19°C	35°C	24°C	ISO5151-T1																				
Heating	20°C	—	7°C	6°C																					
(2) This air-conditioner is manufactured and tested in conformity with the ISO.																									
(3) Sound level indicates the value in an anechoic chamber. During operation these value are somewhat higher due to ambient conditions.																									
(4) Select the breaker size according to the own national standard.																									
(5) When wireless remote control is used, fan is 3 speed setting (Hi-Me-Lo) only.																									
(6) The operation data indicate when the air-conditioner is operated at 400V50Hz or 380V60Hz.																									
(7) Indoor unit specifications for one unit. Capacity and operation data are two indoor units are combined and run together.																									
(8) Branching pipe set "DIS-WB1"×1(option). ① : Pipe of O/U~Branch, ② : Pipe of Branch~I/U																									

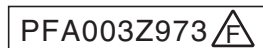

Item		Model	FDEN250VSPVF			
			Indoor unit FDEN125VF (2 units)	Outdoor unit FDC250VS		
Power source			3 Phase 380-415V 50Hz / 380V 60Hz			
Operation data	Nominal cooling capacity (range)	kW	25.0 [10.0(Min.)~28.0(Max.)]			
	Nominal heating capacity (range)	kW	28.0 [9.5(Min.)~31.5(Max.)]			
	Power consumption	Cooling	kW	9.01		
		Heating		8.05		
	Max power consumption		10.81			
	Running current	Cooling	A	13.5 / 14.1		
		Heating		12.2 / 12.8		
	Inrush current, max current		5, 22			
	Power factor	Cooling	%	96 / 97		
		Heating		95 / 96		
	EER	Cooling		2.77		
	COP	Heating		3.48		
Sound power level	Cooling	dB(A)	67			
	Heating		74			
Sound pressure level	Cooling	dB(A)	P-Hi : 50 Hi : 46 Me : 44 Lo : 43			
	Heating		57			
Silent mode sound pressure level			Cooling : 56 / Heating : 57			
Exterior dimensions (Height × Width × Depth)		mm	250 × 1,620 × 690			
Exterior appearance (Munsell color)			Plaster White (6.8Y8.9/0.2) near equivalent			
			Stucco White (4.2Y7.5/1.1) near equivalent			
Net weight		kg	49			
Compressor type & Q'ty			—			
Compressor motor (Starting method)		kW	—			
Refrigerant oil (Amount, type)		ℓ	—			
Refrigerant (Type, amount, pre-charge length)		kg	R410A 7.2kg (Pre-charged up to the piping length of 30m) Outdoor unit			
Heat exchanger			Louver fin & inner grooved tubing			
Refrigerant control			Straight fin & inner grooved tubing			
Fan type & Q'ty			Electronic expansion valve			
Fan motor (Starting method)		W	Centrifugal fan ×4			
			Propeller fan ×2			
Air flow		m³/min	40×2 < Direct line start >			
	Cooling		86×2 < Direct line start >			
	Heating	150				
Available external static pressure		Pa	0			
Outside air intake			Not possible			
Air filter, Quality / Quantity			Pocket plastic net ×2(Washable)			
Shock & vibration absorber			Rubber sleeve (for fan motor)			
Electric heater		W	Rubber sleeve (for compressor)			
Operation control			0			
Remote control			33 (Crank case heater)			
Room temperature control			(option) wired : RC-EX1A, RC-E5, RCH-E3 wireless : RCN-E1R			
Operation display			Thermostat by electronics			
Safety equipments			RUN: Green, TIMER: Yellow, CHECK: Yellow			
			Internal thermostat for fan motor.			
			Frost protection thermostat.			
			Internal thermostat for fan motor.			
			Abnormal discharge temperature protection.			
Installation data	Refrigerant piping size (O.D.)	mm	Liquid line: I/U φ 9.52(3/8") ② φ 9.52(3/8")x0.8 ① φ 12.7(1/2")x0.8 O/U φ 12.7(1/2")			
	Connecting method		Gas line: I/U φ 15.88 (5/8") ② φ 15.88 (5/8")x1.0 ① φ 22.22(7/8")x1.6 O/U φ 22.22(7/8")			
	Attached length of piping	m	Flare piping			
	Insulation for piping		Liquid : Flare / Gas : Brazing			
	Refrigerant line (one way) length	m	Necessary (both Liquid & Gas lines)			
	Vertical height diff. between O.U. and I.U.	m	Max.70m			
Drain hose			Max.30m (Outdoor unit is higher)			
Drain pump, max lift height	mm		Max.15m (Outdoor unit is lower)			
Recommended breaker size	A		Hose connectable with VP20 (O.D.26)			
L.R.A. (Locked rotor ampere)	A		Holes size φ 20 × 3pcs			
Interconnecting wires Size × Core number			—			
IP number			5.0			
Standard accessories			φ 1.6mm×3 cores (+ earth cable 1.6mm) / Terminal block (Screw fixing type)			
Option parts			IPX0			
Note (1) The data are measured at the following conditions.			IP24			
			Mounting kit, Drain hose			
			Connecting pipe, Edging			
			—			
Note (1) The data are measured at the following conditions.			The pipe length is 7.5m.			
Operation	Item	Indoor air temperature		Outdoor air temperature		Standards
		DB	WB	DB	WB	
	Cooling	27°C	19°C	35°C	24°C	
Heating	20°C	—	7°C	6°C		
(2) This air-conditioner is manufactured and tested in conformity with the ISO. (3) Sound level indicates the value in an anechoic chamber. During operation these value are somewhat higher due to ambient conditions. (4) Select the breaker size according to the own national standard. (5) When wireless remote control is used, fan is 3 speed setting (Hi-Me-Lo) only. (6) The operation data indicate when the air-conditioner is operated at 400V50Hz or 380V60Hz. (7) Indoor unit specifications for one unit. Capacity and operation data are two indoor units are combined and run together. (8) Branching pipe set "DIS-WB1"×1(option). ① : Pipe of O/U~Branch, ② : Pipe of Branch~I/U						

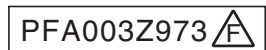

(c) Triple type

Item		Model	FDEN140VNTVF		
			Indoor unit FDEN50VF (3 units)	Outdoor unit FDC140VN	
Power source			1 Phase 220-240V 50Hz / 220V 60Hz		
Operation data	Nominal cooling capacity (range)	kW	14.0 [5.0(Min.)~14.5(Max.)]		
	Nominal heating capacity (range)	kW	16.0 [4.0(Min.)~16.5(Max.)]		
	Power consumption	Cooling	kW	4.88	
		Heating		4.58	
	Max power consumption		6.34		
	Running current	Cooling	A	21.7 / 22.6	
		Heating		20.2 / 21.1	
	Inrush current, max current		5, 24		
	Power factor	Cooling	%	98	
		Heating		99	
	EER	Cooling		2.87	
	COP	Heating		3.49	
	Sound power level	Cooling	dB(A)	60	
Heating		73			
Sound pressure level	Cooling	dB(A)	P-Hi : 46 Hi : 39 Me : 38 Lo : 37		
	Heating		51		
Silent mode sound pressure level			Cooling : 47 / Heating : 50		
Exterior dimensions (Height × Width × Depth)	mm	210 × 1,070 × 690		845×970×370	
Exterior appearance (Munsell color)		Plaster White (6.8Y8.9/0.2) near equivalent		Stucco White (4.2Y7.5/1.1) near equivalent	
Net weight	kg	28		81	
Compressor type & Q'ty		—		RMT5126MDE2×1	
Compressor motor (Starting method)	kW	—		Direct line start	
Refrigerant oil (Amount, type)	ℓ	—		0.9 M-MA68	
Refrigerant (Type, amount, pre-charge length)	kg	R410A 3.8kg (Pre-charged up to the piping length of 30m) Outdoor unit			
Heat exchanger		Louver fin & inner grooved tubing		Straight fin & inner grooved tubing	
Refrigerant control		Electronic expansion valve			
Fan type & Q'ty		Centrifugal fan ×2		Propeller fan ×1	
Fan motor (Starting method)	W	25 < Direct line start >		86 < Direct line start >	
Air flow	Cooling	m³/min	P-Hi : 11 Hi : 10 Me : 9 Lo : 7		
	Heating		75		
Available external static pressure	Pa	0		73	
Outside air intake		Not possible			
Air filter, Quality / Quantity		Pocket plastic net ×2(Washable)			
Shock & vibration absorber		Rubber sleeve (for fan motor)		Rubber sleeve (for compressor)	
Electric heater	W	—		20 (Crank case heater)	
Operation control	Remote control	(option) wired : RC-EX1A, RC-E5, RCH-E3 wireless : RCN-E1R			
	Room temperature control	Thermostat by electronics			
	Operation display	RUN: Green, TIMER: Yellow, CHECK: Yellow			
Safety equipments		Internal thermostat for fan motor.			
		Frost protection thermostat.			
		Internal thermostat for fan motor.			
		Abnormal discharge temperature protection.			
Installation data	Refrigerant piping size (O.D.)	mm	Liquid line: I/U φ 6.35 (1/4") ② φ 9.52(3/8")×0.8 ① φ 9.52(3/8")×0.8 O/U φ 9.52 (3/8")		
	Connecting method		Gas line: I/U φ 12.7 (1/2") ② φ 12.7(1/2")×0.8 ① φ 15.88(5/8")×1.0 O/U φ 15.88 (5/8")		
	Attached length of piping	m	Flare piping		
	Insulation for piping		Necessary (both Liquid & Gas lines)		
	Refrigerant line (one way) length	m	Max.50m		
	Vertical height diff. between O.U. and I.U.	m	Max.30m (Outdoor unit is higher) Max.15m (Outdoor unit is lower)		
Drain hose		Hose connectable with VP20 (O.D.26)		Holes size φ 20 × 3pcs	
Drain pump, max lift height	mm	—			
Recommended breaker size	A	—			
L.R.A. (Locked rotor ampere)	A	5.0			
Interconnecting wires Size × Core number		φ 1.6mm×3 cores (+ earth cable 1.6mm) / Terminal block (Screw fixing type)			
IP number		IPX0		IP24	
Standard accessories		Mounting kit, Drain hose		Edging	
Option parts		—			

Note (1) The data are measured at the following conditions.

The pipe length is 7.5m.

Item	Indoor air temperature		Outdoor air temperature		Standards
	DB	WB	DB	WB	
Cooling	27°C	19°C	35°C	24°C	ISO5151-T1
Heating	20°C	—	7°C	6°C	

(2) This air-conditioner is manufactured and tested in conformity with the ISO.

(3) Sound level indicates the value in an anechoic chamber. During operation these value are somewhat higher due to ambient conditions.

(4) Select the breaker size according to the own national standard.

(5) When wireless remote control is used, fan is 3 speed setting (Hi-Me-Lo) only.

(6) The operation data indicate when the air-conditioner is operated at 230V50Hz or 220V60Hz.

(7) Indoor unit specifications for one unit. Capacity and operation data are three indoor units are combined and run together.

(8) Branching pipe set "DIS-TA1"×1(option). ① : Pipe of O/U~Branch, ② : Pipe of Branch~I/U

Item		Model	FDEN140VSTVF																						
			Indoor unit FDEN50VF (3 units)	Outdoor unit FDC140VS																					
Power source			3 Phase 380-415V 50Hz / 380V 60Hz																						
Operation data	Nominal cooling capacity (range)	kW	14.0 [5.0(Min.)~14.5(Max.)]																						
	Nominal heating capacity (range)	kW	16.0 [4.0(Min.)~16.5(Max.)]																						
	Power consumption	Cooling	kW	4.88																					
		Heating		4.58																					
	Max power consumption		6.34																						
	Running current	Cooling	A	7.2 / 7.6																					
		Heating		6.7 / 7.0																					
	Inrush current, max current		5, 15																						
	Power factor	Cooling	%	98																					
		Heating		99																					
	EER	Cooling		2.87																					
	COP	Heating		3.49																					
Sound power level	Cooling	dB(A)	60																						
	Heating		70																						
Sound pressure level	Cooling	dB(A)	P-Hi : 46 Hi : 39 Me : 38 Lo : 37																						
	Heating		51																						
Silent mode sound pressure level			Cooling : 47 / Heating : 50																						
Exterior dimensions (Height × Width × Depth)		mm	210 × 1,070 × 690																						
Exterior appearance (Munsell color)			Plaster White (6.8Y8.9/0.2) near equivalent																						
			Stucco White (4.2Y7.5/1.1) near equivalent																						
Net weight		kg	28																						
Compressor type & Q'ty			—																						
Compressor motor (Starting method)		kW	—																						
Refrigerant oil (Amount, type)		ℓ	—																						
Refrigerant (Type, amount, pre-charge length)		kg	R410A 3.8kg (Pre-charged up to the piping length of 30m) Outdoor unit																						
Heat exchanger			Louver fin & inner grooved tubing																						
Refrigerant control			Straight fin & inner grooved tubing																						
Fan type & Q'ty			Electronic expansion valve																						
Fan motor (Starting method)		W	Centrifugal fan ×2																						
			Propeller fan ×1																						
Air flow		m³/min	25 < Direct line start >																						
	Cooling		75																						
	Heating	73																							
Available external static pressure		Pa	0																						
Outside air intake			Not possible																						
Air filter, Quality / Quantity			Pocket plastic net ×2(Washable)																						
Shock & vibration absorber			Rubber sleeve (for fan motor)																						
Electric heater		W	Rubber sleeve (for compressor)																						
Operation control			20 (Crank case heater)																						
Remote control			(option) wired : RC-EX1A, RC-E5, RCH-E3 wireless : RCN-E1R																						
Room temperature control			Thermostat by electronics																						
Operation display			RUN: Green, TIMER: Yellow, CHECK: Yellow																						
Safety equipments			Internal thermostat for fan motor. Frost protection thermostat. Internal thermostat for fan motor. Abnormal discharge temperature protection.																						
Installation data	Refrigerant piping size (O.D.)	mm	Liquid line: I/U φ 6.35 (1/4") ② φ 9.52(3/8")x0.8 ① φ 9.52(3/8")x0.8 O/U φ 9.52 (3/8") Gas line: I/U φ 12.7 (1/2") ② φ 12.7(1/2")x0.8 ① φ 15.88(5/8")x1.0 O/U φ 15.88 (5/8")																						
	Connecting method		Flare piping																						
	Attached length of piping	m	—																						
	Insulation for piping		Necessary (both Liquid & Gas lines)																						
	Refrigerant line (one way) length	m	Max.50m																						
	Vertical height diff. between O.U. and I.U.	m	Max.30m (Outdoor unit is higher) Max.15m (Outdoor unit is lower)																						
Drain hose			Hose connectable with VP20 (O.D.26) Holes size φ 20 × 3pcs																						
Drain pump, max lift height	mm		—																						
Recommended breaker size	A		—																						
L.R.A. (Locked rotor ampere)	A		5.0																						
Interconnecting wires Size × Core number			φ 1.6mm×3 cores (+ earth cable 1.6mm) / Terminal block (Screw fixing type)																						
IP number			IPX0 IP24																						
Standard accessories			Mounting kit, Drain hose Edging																						
Option parts			—																						
Note (1) The data are measured at the following conditions.			The pipe length is 7.5m.																						
<table border="1"> <thead> <tr> <th rowspan="2">Item</th> <th colspan="2">Indoor air temperature</th> <th colspan="2">Outdoor air temperature</th> <th rowspan="2">Standards</th> </tr> <tr> <th>DB</th> <th>WB</th> <th>DB</th> <th>WB</th> </tr> </thead> <tbody> <tr> <td>Cooling</td> <td>27°C</td> <td>19°C</td> <td>35°C</td> <td>24°C</td> <td rowspan="2">ISO5151-T1</td> </tr> <tr> <td>Heating</td> <td>20°C</td> <td>—</td> <td>7°C</td> <td>6°C</td> </tr> </tbody> </table>					Item	Indoor air temperature		Outdoor air temperature		Standards	DB	WB	DB	WB	Cooling	27°C	19°C	35°C	24°C	ISO5151-T1	Heating	20°C	—	7°C	6°C
Item	Indoor air temperature		Outdoor air temperature			Standards																			
	DB	WB	DB	WB																					
Cooling	27°C	19°C	35°C	24°C	ISO5151-T1																				
Heating	20°C	—	7°C	6°C																					
(2) This air-conditioner is manufactured and tested in conformity with the ISO.																									
(3) Sound level indicates the value in an anechoic chamber. During operation these value are somewhat higher due to ambient conditions.																									
(4) Select the breaker size according to the own national standard.																									
(5) When wireless remote control is used, fan is 3 speed setting (Hi-Me-Lo) only.																									
(6) The operation data indicate when the air-conditioner is operated at 400V50Hz or 380V60Hz.																									
(7) Indoor unit specifications for one unit. Capacity and operation data are three indoor units are combined and run together.																									
(8) Branching pipe set "DIS-TA1"×1(option). ① : Pipe of O/U~Branch, ② : Pipe of Branch~I/U																									

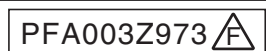

Item		Model	FDEN200VSTVF1		
			Indoor unit FDEN71VF1 (3 units)	Outdoor unit FDC200VS	
Power source			3 Phase 380-415V 50Hz / 380V 60Hz		
Operation data	Nominal cooling capacity (range)	kW	20.0 [7.0(Min.)~22.4(Max.)]		
	Nominal heating capacity (range)	kW	22.4 [7.6(Min.)~25.0(Max.)]		
	Power consumption	Cooling	kW	6.40	
		Heating		5.90	
	Max power consumption		8.13		
	Running current	Cooling	A	9.6 / 10.0	
		Heating		9.0 / 9.4	
	Inrush current, max current		5, 19		
	Power factor	Cooling	%	96 / 97	
		Heating		95	
	EER	Cooling		3.13	
	COP	Heating		3.80	
Sound power level	Cooling	dB(A)	62		
	Heating		74		
Sound pressure level	Cooling	dB(A)	P-Hi : 50 Hi : 41 Me : 39 Lo : 38		
	Heating		57		
Silent mode sound pressure level			Cooling : 56 / Heating : 56		
Exterior dimensions (Height × Width × Depth)		mm	210 × 1,320 × 690		
Exterior appearance (Munsell color)			Plaster White (6.8Y8.9/0.2) near equivalent		
			Stucco White (4.2Y7.5/1.1) near equivalent		
Net weight		kg	37		
Compressor type & Q'ty			—		
Compressor motor (Starting method)		kW	—		
Refrigerant oil (Amount, type)		ℓ	—		
Refrigerant (Type, amount, pre-charge length)		kg	R410A 5.4kg (Pre-charged up to the piping length of 30m) Outdoor unit		
Heat exchanger			Louver fin & inner grooved tubing		
Refrigerant control			Straight fin & inner grooved tubing		
Refrigerant control			Electronic expansion valve		
Fan type & Q'ty			Centrifugal fan ×4		
Fan motor (Starting method)		W	20×2 < Direct line start >		
			Propeller fan ×2		
Air flow	Cooling	m³/min	P-Hi : 20 Hi : 16 Me : 14 Lo : 12		
	Heating		150		
Available external static pressure		Pa	0		
Outside air intake			Not possible		
Air filter, Quality / Quantity			Pocket plastic net ×2 (Washable)		
Shock & vibration absorber			Rubber sleeve (for fan motor)		
Electric heater		W	—		
			33 (Crank case heater)		
Operation control	Remote control		(option) wired : RC-EX1A, RC-E5, RCH-E3 wireless : RCN-E1R		
	Room temperature control		Thermostat by electronics		
	Operation display		RUN: Green, TIMER: Yellow, CHECK: Yellow		
Safety equipments			Internal thermostat for fan motor. Frost protection thermostat. Internal thermostat for fan motor. Abnormal discharge temperature protection.		
Installation data	Refrigerant piping size (O.D.)	mm	Liquid line: I/U φ 9.52(3/8") ② φ 9.52(3/8")x0.8 ① φ 9.52(3/8")x0.8 O/U φ 9.52 (3/8") Gas line: I/U φ 15.88(5/8") ② φ 15.88(5/8")x1.0 ① φ 22.22(7/8")x1.6 O/U φ 22.22(7/8")		
	Connecting method		Flare piping		
	Attached length of piping	m	—		
	Insulation for piping		Necessary (both Liquid & Gas lines)		
	Refrigerant line (one way) length	m	Max.70m		
	Vertical height diff. between O.U. and I.U.	m	Max.30m (Outdoor unit is higher)		
Drain hose		Hose connectable with VP20 (O.D.26)			
Drain pump, max lift height	mm	—			
Recommended breaker size	A	—			
L.R.A. (Locked rotor ampere)	A	5.0			
Interconnecting wires Size × Core number		φ 1.6mm×3 cores (+ earth cable 1.6mm) / Terminal block (Screw fixing type)			
IP number		IPX0			
Standard accessories		Mounting kit, Drain hose			
Option parts		Connecting pipe, Edging			

Note (1) The data are measured at the following conditions. The pipe length is 7.5m.

Operation	Indoor air temperature		Outdoor air temperature		Standards
	DB	WB	DB	WB	
Cooling	27°C	19°C	35°C	24°C	ISO5151-T1
Heating	20°C	—	7°C	6°C	

- (2) This air-conditioner is manufactured and tested in conformity with the ISO.
- (3) Sound level indicates the value in an anechoic chamber. During operation these value are somewhat higher due to ambient conditions.
- (4) Select the breaker size according to the own national standard.
- (5) When wireless remote control is used, fan is 3 speed setting (Hi-Me-Lo) only.
- (6) The operation data indicate when the air-conditioner is operated at 400V50Hz or 380V60Hz.
- (7) Indoor unit specifications for one unit. Capacity and operation data are three indoor units are combined and run together.
- (8) Branching pipe set "DIS-TB1"×1(option). ① : Pipe of O/U~Branch, ② : Pipe of Branch~I/U

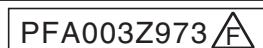

(c) Double twin type

Item		Model	FDEN200VSDVF		
			Indoor unit FDEN50VF (4 units)	Outdoor unit FDC200VS	
Power source			3 Phase 380-415V 50Hz / 380V 60Hz		
Operation data	Nominal cooling capacity (range)	kW	20.0 [7.0(Min.)~22.4(Max.)]		
	Nominal heating capacity (range)	kW	22.4 [7.6(Min.)~25.0(Max.)]		
	Power consumption	Cooling	kW	7.43	
		Heating		7.26	
	Max power consumption		9.44		
	Running current	Cooling	A	11.1 / 11.6	
		Heating		10.8 / 11.4	
	Inrush current, max current		5, 19		
	Power factor	Cooling	%	97	
		Heating		97	
	EER	Cooling	2.69		
	COP	Heating	3.09		
	Sound power level	Cooling	dB(A)	60	70
Heating					
Sound pressure level	Cooling	dB(A)	P-Hi : 46 Hi : 39 Me : 38 Lo : 37		
	Heating		57		
Silent mode sound pressure level			Cooling : 56 / Heating : 56		
Exterior dimensions (Height × Width × Depth)	mm	210 × 1,070 × 690		1,300×970×370	
Exterior appearance (Munsell color)		Plaster White (6.8Y8.9/0.2) near equivalent		Stucco White (4.2Y7.5/1.1) near equivalent	
Net weight	kg	28		122	
Compressor type & Q'ty		—		GTC5150ND70K×1	
Compressor motor (Starting method)	kW	—		Direct line start	
Refrigerant oil (Amount, type)	ℓ	—		1.45 M-MA32R	
Refrigerant (Type, amount, pre-charge length)	kg	R410A 5.4kg (Pre-charged up to the piping length of 30m) Outdoor unit			
Heat exchanger		Louver fin & inner grooved tubing		Straight fin & inner grooved tubing	
Refrigerant control		Electronic expansion valve			
Fan type & Q'ty		Centrifugal fan ×2		Propeller fan ×2	
Fan motor (Starting method)	W	25 < Direct line start >		86×2 < Direct line start >	
Air flow	Cooling	m³/min	P-Hi : 11 Hi : 10 Me : 9 Lo : 7		
	Heating		150		
Available external static pressure	Pa	0			
Outside air intake		Not possible			
Air filter, Quality / Quantity		Pocket plastic net ×2(Washable)			
Shock & vibration absorber		Rubber sleeve (for fan motor)		Rubber sleeve (for Compressor)	
Electric heater	W	—			
Operation control	Remote control	(option) wired : RC-EX1A, RC-E5, RCH-E3 wireless : RCN-E1R			
	Room temperature control	Thermostat by electronics			
	Operation display	RUN: Green, TIMER: Yellow, CHECK: Yellow			
Safety equipments		Internal thermostat for fan motor.			
		Frost protection thermostat.			
		Internal thermostat for fan motor.			
		Abnormal discharge temperature protection.			
Installation data	Refrigerant piping size (O.D.)	mm	Liquid line: 1/O φ 6.35 (1/4") ③② φ 9.52(3/8")×0.8 ① φ 9.52(3/8")×0.8 O/U φ 9.52 (3/8")		
			Gas line: 1/U φ 12.7 (1/2") ③ φ 12.7×0.8 ② φ 15.88 ① φ 22.22(7/8")×1.6 O/U φ 22.22 (7/8")		
	Connecting method		Flare piping		
	Attached length of piping	m	Liquid : Flare / Gas : Brazing		
	Insulation for piping		Necessary (both Liquid & Gas lines)		
	Refrigerant line (one way) length	m	Max.70m		
Vertical height diff. between O.U. and I.U.	m	Max.30m (Outdoor unit is higher)		Max.15m (Outdoor unit is lower)	
Drain hose		Hose connectable with VP20 (O.D.26)		Holes size φ 20 × 3pcs	
Drain pump, max lift height	mm	—			
Recommended breaker size	A	—			
L.R.A. (Locked rotor ampere)	A	5.0			
Interconnecting wires	Size × Core number	φ 1.6mm×3 cores (+ earth cable 1.6mm) / Terminal block (Screw fixing type)			
IP number		IPX0		IP24	
Standard accessories		Mounting kit, Drain hose		Connecting pipe, Edging	
Option parts		—			

Note (1) The data are measured at the following conditions.

The pipe length is 7.5m.

Operation	Indoor air temperature		Outdoor air temperature		Standards
	DB	WB	DB	WB	
Cooling	27°C	19°C	35°C	24°C	ISO5151-T1
Heating	20°C	—	7°C	6°C	

(2) This air-conditioner is manufactured and tested in conformity with the ISO.

(3) Sound level indicates the value in an anechoic chamber. During operation these value are somewhat higher due to ambient conditions.

(4) Select the breaker size according to the own national standard.

(5) When wireless remote control is used, fan is 3 speed setting (Hi-Me-Lo) only.

(6) The operation data indicate when the air-conditioner is operated at 400V50Hz or 380V60Hz

(7) Indoor unit specifications for one unit. Capacity and operation data are four indoor units are combined and run together.

(8) Branching pipe set "DIS-WB1"×1, "DIS-WA1"×2(option). Pipe① : O/U~Branch, ② : Branch~Branch, ③ : Branch~I/U

Item		Model	FDEN250VSDVF		
			Indoor unit FDEN60VF (4 units)	Outdoor unit FDC250VS	
Power source			3 Phase 380-415V 50Hz / 380V 60Hz		
Operation data	Nominal cooling capacity (range)	kW	25.0 [10.0(Min.)~ 28.0(Max.)]		
	Nominal heating capacity (range)	kW	28.0 [9.5(Min.)~ 31.5(Max.)]		
	Power consumption	Cooling	kW	9.50	
		Heating		8.69	
	Max power consumption		11.40		
	Running current	Cooling	A	14.1 / 14.9	
		Heating		12.9 / 13.6	
	Inrush current, max current		5, 22		
	Power factor	Cooling	%	97	
		Heating		97	
	EER	Cooling		2.63	
	COP	Heating		3.22	
Sound power level	Cooling	dB(A)	60		
	Heating		74		
Sound pressure level	Cooling	dB(A)	P-Hi : 48 Hi : 41 Me : 39 Lo : 38		
	Heating		57		
Silent mode sound pressure level			58		
Exterior dimensions (Height × Width × Depth)		mm	210 × 1,320 × 690		
Exterior appearance (Munsell color)			Plaster White (6.8Y8.9/0.2) near equivalent		
Net weight		kg	37		
Compressor type & Q'ty			—		
Compressor motor (Starting method)		kW	—		
Refrigerant oil (Amount, type)		ℓ	—		
Refrigerant (Type, amount, pre-charge length)		kg	R410A 7.2kg (Pre-charged up to the piping length of 30m) Outdoor unit		
Heat exchanger			Louver fin & inner grooved tubing		
Refrigerant control			Straight fin & inner grooved tubing		
Fan type & Q'ty			Electronic expansion valve		
Fan motor (Starting method)		W	Centrifugal fan ×4		
Air flow		m ³ /min	Propeller fan ×2		
Available external static pressure		Pa	20×2 < Direct line start >		
Outside air intake			86×2 < Direct line start >		
Air filter, Quality / Quantity			150		
Shock & vibration absorber			145		
Electric heater		W	0		
Operation control			Rubber sleeve (for fan motor)		
Safety equipments			Rubber sleeve (for compressor)		
Installation data			33 (Crank case heater)		
Refrigerant piping size (O.D.)		mm	(option) wired : RC-EX1A, RC-E5, RCH-E3 wireless : RCN-E1R		
Connecting method			Thermostat by electronics		
Attached length of piping		m	RUN: Green, TIMER: Yellow, CHECK: Yellow		
Insulation for piping			Internal thermostat for fan motor.		
Refrigerant line (one way) length		m	Frost protection thermostat.		
Vertical height diff. between O.U. and I.U.		m	Internal thermostat for fan motor.		
Drain hose			Abnormal discharge temperature protection.		
Drain pump, max lift height		mm	Liquid line: I/O φ 6.35 (1/4") ③ ② φ 9.52(3/8")x0.8 ① φ 12.7(1/2")x0.8 O/U φ 12.7 (1/2")		
Recommended breaker size		A	Gas line: I/U φ 12.7 (1/2") ③ φ 12.7x0.8 ② φ 15.88 ① φ 22.22(7/8")x1.6 O/U φ 22.22 (7/8")		
L.R.A. (Locked rotor ampere)		A	Flare piping		
Interconnecting wires Size × Core number			Liquid : Flare / Gas : Brazing		
IP number			Necessary (both Liquid & Gas lines)		
Standard accessories			Max.30m (Outdoor unit is higher)		
Option parts			Max.15m (Outdoor unit is lower)		
Remote control			Hose connectable with VP20 (O.D.26)		
Room temperature control			Holes size φ 20 × 3pcs		
Operation display			—		
Refrigerant piping size (O.D.)		mm	—		
Connecting method			—		
Attached length of piping		m	—		
Insulation for piping			—		
Refrigerant line (one way) length		m	—		
Vertical height diff. between O.U. and I.U.		m	—		
Drain hose			—		
Drain pump, max lift height		mm	—		
Recommended breaker size		A	—		
L.R.A. (Locked rotor ampere)		A	5.0		
Interconnecting wires Size × Core number			φ 1.6mm×3 cores (+ earth cable 1.6mm) / Terminal block (Screw fixing type)		
IP number			IPX0		
Standard accessories			IP24		
Option parts			Mounting kit, Drain hose		
			Connecting pipe, Edging		

Note (1) The data are measured at the following conditions. The pipe length is 7.5m.

Item	Indoor air temperature		Outdoor air temperature		Standards
	DB	WB	DB	WB	
Cooling	27°C	19°C	35°C	24°C	ISO5151-T1
Heating	20°C	—	7°C	6°C	

- (2) This air-conditioner is manufactured and tested in conformity with the ISO.
- (3) Sound level indicates the value in an anechoic chamber. During operation these value are somewhat higher due to ambient conditions.
- (4) Select the breaker size according to the own national standard.
- (5) When wireless remote control is used, fan is 3 speed setting (Hi-Me-Lo) only.
- (6) The operation data indicate when the air-conditioner is operated at 400V50Hz or 380V60Hz.
- (7) Indoor unit specifications for one unit. Capacity and operation data are four indoor units are combined and run together.
- (8) Branching pipe set "DIS-WB1"×1, "DIS-WA1"×2 (option). Pipe ① : O/U ~ Branch, ② : Branch ~ Branch, ③ : Branch ~ I/U

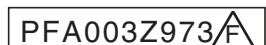

(4) Duct connected-High static pressure type (FDU)

Item		Model	FDU100VNVF1		
			Indoor unit FDU100VF1	Outdoor unit FDC100VN	
Power source			1 Phase 220-240V 50Hz / 220V 60Hz		
Operation data	Nominal cooling capacity (range)	kW	10.0 [4.0(Min.)~11.2(Max.)]		
	Nominal heating capacity (range)	kW	11.2 [4.0(Min.)~12.5(Max.)]		
	Power consumption	Cooling	kW	2.80	
		Heating		3.02	
	Max power consumption		4.23		
	Running current	Cooling	A	12.6 / 13.2	
		Heating		13.5 / 14.1	
	Inrush current, max current		5, 25		
	Power factor	Cooling	%	97 / 96	
		Heating		97	
	EER	Cooling		3.57	
	COP	Heating		3.71	
	Sound power level	Cooling	dB(A)	65	
Heating		70			
Sound pressure level	Cooling	dB(A)	P-Hi : 44 Hi : 38 Me : 36 Lo : 30		
	Heating		49		
Silent mode sound pressure level			Cooling : 46 / Heating : 46		
Exterior dimensions (Height × Width × Depth)	mm	280 × 1370 × 740		845×970×370	
Exterior appearance (Munsell color)		-		Stucco White (4.2Y7.5/1.1) near equivalent	
Net weight	kg	54		81	
Compressor type & Q'ty		-		RMT5126MDE6×1	
Compressor motor (Starting method)	kW	-		Direct line start	
Refrigerant oil (Amount, type)	ℓ	-		0.9 M-MA68	
Refrigerant (Type, amount, pre-charge length)	kg	R410A 3.8kg in outdoor unit (incl. the amount for the piping of : 30m)			
Heat exchanger		Louver fin & inner grooved tubing		Straight fin & inner grooved tubing	
Refrigerant control		Electronic expansion valve			
Fan type & Q'ty		Centrifugal fan ×3		Propeller fan ×1	
Fan motor (Starting method)	W	100 + 130 < Direct line start >		86 < Direct line start >	
Air flow	Cooling	m³/min	P-Hi : 36 Hi : 28 Me : 25 Lo : 19		
	Heating		75		
Available external static pressure	Pa	Standard : 60 Max : 200		73	
Outside air intake		Possible		0	
Air filter, Quality / Quantity		Procure locally		-	
Shock & vibration absorber		Rubber sleeve (for fan motor)		Rubber sleeve (for compressor)	
Electric heater	W	-		20 (Crank case heater)	
Operation control	Remote control	(option) wired : RC-EX1A, RC-E5, RCH-E3 wireless : RCN-KIT3-E			
	Room temperature control	Thermostat by electronics			
	Operation display	-			
Safety equipments		Overload protection for fan motor. Frost protection thermostat. Internal thermostat for fan motor. Abnormal discharge temperature protection.			
Installation data	Refrigerant piping size (O.D.)	mm	Liquid line: I/U φ 9.52 (3/8") Pipe φ 9.52(3/8")×0.8 O/U φ 9.52 (3/8") Gas line: φ 15.88 (5/8") φ 15.88 (5/8")×1.0 φ 15.88 (5/8")		
	Connecting method		Flare piping		
	Attached length of piping	m	-		
	Insulation for piping		Necessary (both Liquid & Gas lines)		
	Refrigerant line (one way) length	m	Max.50m		
	Vertical height diff. between O.U. and I.U.	m	Max.30m (Outdoor unit is higher) Max.15m (Outdoor unit is lower)		
Drain hose		Hose connectable VP25 (I.D.25 O.D.32)		Holes size φ 20 × 3pcs	
Drain pump, max lift height	mm	Built-in Drain pump, 600		-	
Recommended breaker size	A	-			
L.R.A. (Locked rotor ampere)	A	5 / 5			
Interconnecting wires Size × Core number		φ 1.6mm×3 cores (+ earth cable 1.6mm) / Terminal block (Screw fixing type)			
IP number		IPX0		IP24	
Standard accessories		Mounting kit, Drain hose		Edging	
Option parts		-			

Note (1) The data are measured at the following conditions. The pipe length is 7.5m.

Operation	Indoor air temperature		Outdoor air temperature		External static pressure of indoor unit	Standards
	DB	WB	DB	WB		
Cooling	27°C	19°C	35°C	24°C	60Pa	ISO5151-T1
Heating	20°C	-	7°C	6°C		

- (2) This air-conditioner is manufactured and tested in conformity with the ISO.
- (3) Sound level indicates the value in an anechoic chamber. During operation these value are somewhat higher due to ambient conditions.
- (4) Select the breaker size according to the own national standard.
- (5) When wireless remote control is used, fan is 3 speed setting (Hi-Me-Lo) only.
- (6) The operation data indicate when the air-conditioner is operated at 230V50Hz or 220V60Hz.
- (7) The factory E.S.P. setting is set within the range of 80 - 150 Pa.If SW8-4 is turned to "ON", E.S.P. setting range can be changed to 10 - 200 Pa.(For RC-EX1A and RC-E5 only)

Item		Model	FDU100VNVF2		
			Indoor unit FDU100VF2	Outdoor unit FDC100VN	
Power source			1 Phase 220-240V 50Hz / 220V 60Hz		
Operation data	Nominal cooling capacity (range)	kW	10.0 [4.0(Min.)~11.2(Max.)]		
	Nominal heating capacity (range)	kW	11.2 [4.0(Min.)~12.5(Max.)]		
	Power consumption	Cooling	kW	2.80	
		Heating		3.02	
	Max power consumption			4.23	
	Running current	Cooling	A	12.6 / 13.2	
		Heating		13.5 / 14.1	
	Inrush current, max current			5, 25	
	Power factor	Cooling	%	97 / 96	
		Heating		97	
	EER	Cooling		3.57	
	COP	Heating		3.71	
Sound power level	Cooling	dB(A)	65	70	
	Heating				
Sound pressure level	Cooling	dB(A)	P-Hi : 44 Hi : 38 Me : 36 Lo : 30		
	Heating		49		
Silent mode sound pressure level			-		
Exterior dimensions (Height × Width × Depth)	mm		280 × 1370 × 740	845×970×370	
Exterior appearance (Munsell color)			-	Stucco White (4.2Y7.5/1.1) near equivalent	
Net weight	kg		54	81	
Compressor type & Q'ty			-	RMT5126MDE6×1	
Compressor motor (Starting method)	kW		-	Direct line start	
Refrigerant oil (Amount, type)	ℓ		-	0.9 M-MA68	
Refrigerant (Type, amount, pre-charge length)	kg		R410A 3.8kg in outdoor unit (incl. the amount for the piping of : 30m)		
Heat exchanger			Louver fin & inner grooved tubing	Straight fin & inner grooved tubing	
Refrigerant control			Electronic expansion valve		
Fan type & Q'ty			Centrifugal fan ×3	Propeller fan ×1	
Fan motor (Starting method)	W		100 + 130 < Direct line start >	86 < Direct line start >	
Air flow	Cooling	m ³ /min	P-Hi : 36 Hi : 28 Me : 25 Lo : 19		
	Heating		75 73		
Available external static pressure	Pa		Standard : 60 Max : 200	0	
Outside air intake			Possible	-	
Air filter, Quality / Quantity			Procure locally	-	
Shock & vibration absorber			Rubber sleeve (for fan motor)	Rubber sleeve (for compressor)	
Electric heater	W		-	20 (Crank case heater)	
Operation control	Remote control		(option) wired : RC-EX1A, RC-E5, RCH-E3 wireless : RCN-KIT3-E		
	Room temperature control		Thermostat by electronics		
	Operation display		-		
Safety equipments			Overload protection for fan motor. Frost protection thermostat. Internal thermostat for fan motor. Abnormal discharge temperature protection.		
Installation data	Refrigerant piping size (O.D.)	mm	Liquid line: I/U φ 9.52 (3/8") Pipe φ 9.52(3/8")×0.8 O/U φ 9.52 (3/8") Gas line: φ 15.88 (5/8") φ 15.88 (5/8")×1.0 φ 15.88 (5/8")		
	Connecting method		Flare piping	Flare piping	
	Attached length of piping	m	-	-	
	Insulation for piping		Necessary (both Liquid & Gas lines)		
	Refrigerant line (one way) length	m	Max.50m		
	Vertical height diff. between O.U. and I.U.	m	Max.30m (Outdoor unit is higher) Max.15m (Outdoor unit is lower)		
Drain hose			Hose connectable VP25 (I.D.25 O.D.32)	Holes size φ 20 × 3pcs	
Drain pump, max lift height	mm		Built-in Drain pump, 600		
Recommended breaker size	A		-		
L.R.A. (Locked rotor ampere)	A		5 / 5		
Interconnecting wires Size × Core number			φ 1.6mm×3 cores (including earth cable) / Terminal block (Screw fixing type)		
IP number			IPX0	IP24	
Standard accessories			Mounting kit, Drain hose	Edging	
Option parts			-		

Note (1) The data are measured at the following conditions. The pipe length is 7.5m.

Item	Indoor air temperature		Outdoor air temperature		External static pressure of indoor unit	Standards
	DB	WB	DB	WB		
Cooling	27°C	19°C	35°C	24°C	60Pa	ISO5151-T1
Heating	20°C	-	7°C	6°C		

- (2) This air-conditioner is manufactured and tested in conformity with the ISO.
- (3) Sound level indicates the value in an anechoic chamber. During operation these value are somewhat higher due to ambient conditions.
- (4) Select the breaker size according to the own national standard.
- (5) When wireless remote control is used, fan is 3 speed setting (Hi-Me-Lo) only.
- (6) The operation data indicate when the air-conditioner is operated at 230V50Hz or 220V60Hz.
- (7) The factory E.S.P. setting is set within the range of 80 - 150 Pa.If SW8-4 is turned to "ON", E.S.P. setting range can be changed to 10 - 200 Pa.(For RC-EX1A and RC-E5 only)

Item		Model	FDU100VSVF1		
			Indoor unit FDU100VF1	Outdoor unit FDC100VS	
Power source			3 Phase 380-415V 50Hz / 380V 60HZ		
Operation data	Nominal cooling capacity (range)	kW	10.0 [4.0(Min.)~11.2(Max.)]		
	Nominal heating capacity (range)	kW	11.2 [4.0(Min.)~12.5(Max.)]		
	Power consumption	Cooling	kW	2.80	
		Heating		3.02	
	Max power consumption		4.23		
	Running current	Cooling	A	4.2 / 4.4	
		Heating		4.5 / 4.7	
	Inrush current, max current		5, 16		
	Power factor	Cooling	%	96 / 97	
		Heating		97 / 98	
	EER	Cooling		3.57	
	COP	Heating		3.71	
Sound power level	Cooling	dB(A)	65		
	Heating		70		
Sound pressure level	Cooling	dB(A)	P-Hi : 44 Hi : 38 Me : 36 Lo : 30		
	Heating		49		
Silent mode sound pressure level			Cooling : 46 / Heating : 46		
Exterior dimensions (Height × Width × Depth)		mm	280 × 1370 × 740		
Exterior appearance (Munsell color)			Stucco White (4.2Y7.5/1.1) near equivalent		
Net weight		kg	54 / 83		
Compressor type & Q'ty			RMT5126MDE7×1		
Compressor motor (Starting method)		kW	Direct line start		
Refrigerant oil (Amount, type)		ℓ	0.9 M-MA68		
Refrigerant (Type, amount, pre-charge length)		kg	R410A 3.8kg in outdoor unit (incl. the amount for the piping of : 30m)		
Heat exchanger			Louver fin & inner grooved tubing	Straight fin & inner grooved tubing	
Refrigerant control			Electronic expansion valve		
Fan type & Q'ty			Centrifugal fan ×3	Propeller fan ×1	
Fan motor (Starting method)		W	100 + 130 < Direct line start > / 86 < Direct line start >		
Air flow	Cooling	m³/min	P-Hi : 36 Hi : 28 Me : 25 Lo : 19		
	Heating		75 / 73		
Available external static pressure		Pa	Standard : 60 Max : 200 / 0		
Outside air intake			Possible	—	
Air filter, Quality / Quantity			Procure locally	—	
Shock & vibration absorber			Rubber sleeve (for fan motor)	Rubber sleeve (for compressor)	
Electric heater		W	— / 20 (Crank case heater)		
Operation control	Remote control		(option) wired : RC-EX1A, RC-E5, RCH-E3 wireless : RCN-KIT3-E		
	Room temperature control		Thermostat by electronics		
	Operation display		—		
Safety equipments			Overload protection for fan motor. Frost protection thermostat. Internal thermostat for fan motor. Abnormal discharge temperature protection.		
Installation data	Refrigerant piping size (O.D.)	mm	Liquid line: I/U φ 9.52 (3/8") Pipe φ 9.52(3/8")×0.8 O/U φ 9.52 (3/8") Gas line: φ 15.88 (5/8") φ 15.88 (5/8")×1.0 φ 15.88 (5/8")		
	Connecting method		Flare piping / Flare piping		
	Attached length of piping	m	— / —		
	Insulation for piping		Necessary (both Liquid & Gas lines)		
	Refrigerant line (one way) length	m	Max.50m		
	Vertical height diff. between O.U. and I.U.	m	Max.30m (Outdoor unit is higher) / Max.15m (Outdoor unit is lower)		
Drain hose		Hose connectable VP25 (I.D.25 O.D.32) / Holes size φ 20 × 3pcs			
Drain pump, max lift height		mm	Built-in Drain pump, 600 / —		
Recommended breaker size		A	—		
L.R.A. (Locked rotor ampere)		A	5 / 5		
Interconnecting wires Size × Core number			φ 1.6mm×3 cores (+ earth cable 1.6mm) / Terminal block (Screw fixing type)		
IP number			IPX0 / IP24		
Standard accessories			Mounting kit, Drain hose / Edging		
Option parts			—		

Note (1) The data are measured at the following conditions. The pipe length is 7.5m.

Operation	Indoor air temperature		Outdoor air temperature		External static pressure of indoor unit	Standards
	DB	WB	DB	WB		
Cooling	27°C	19°C	35°C	24°C	60Pa	ISO5151-T1
Heating	20°C	—	7°C	6°C		

- (2) This air-conditioner is manufactured and tested in conformity with the ISO.
- (3) Sound level indicates the value in an anechoic chamber. During operation these value are somewhat higher due to ambient conditions.
- (4) Select the breaker size according to the own national standard.
- (5) When wireless remote control is used, fan is 3 speed setting (Hi-Me-Lo) only.
- (6) The operation data indicate when the air-conditioner is operated at 400V50Hz or 380V60Hz.
- (7) The factory E.S.P. setting is set within the range of 80 - 150 Pa.If SW8-4 is turned to "ON", E.S.P. setting range can be changed to 10 - 200 Pa.(For RC-EX1A and RC-E5 only)

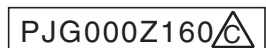

Item		Model		FDU100VSF2		
				Indoor unit FDU100VF2	Outdoor unit FDC100VS	
Power source		3 Phase 380-415V 50Hz / 380V 60HZ				
Operation data	Nominal cooling capacity (range)	kW	10.0 [4.0(Min.)~11.2(Max.)]			
	Nominal heating capacity (range)	kW	11.2 [4.0(Min.)~12.5(Max.)]			
	Power consumption	Cooling	kW	2.80		
		Heating	kW	3.02		
	Max power consumption		4.23			
	Running current	Cooling	A	4.2 / 4.4		
		Heating	A	4.5 / 4.7		
	Inrush current, max current		5, 16			
	Power factor	Cooling	%	96 / 97		
		Heating	%	97 / 98		
	EER	Cooling		3.57		
	COP	Heating		3.71		
Sound power level	Cooling	dB(A)	65		70	
	Heating		P-Hi : 44 Hi : 38 Me : 36 Lo : 30		49	
Sound pressure level	Cooling	dB(A)	-		-	
	Heating		-		-	
Silent mode sound pressure level			-			
Exterior dimensions (Height × Width × Depth)	mm	280 × 1370 × 740		845×970×370		
Exterior appearance (Munsell color)		-		Stucco White (4.2Y7.5/1.1) near equivalent		
Net weight	kg	54		83		
Compressor type & Q'ty		-		RMT5126MDE7×1		
Compressor motor (Starting method)	kW	-		Direct line start		
Refrigerant oil (Amount, type)	ℓ	-		0.9 M-MA68		
Refrigerant (Type, amount, pre-charge length)	kg	R410A 3.8kg in outdoor unit (incl. the amount for the piping of : 30m)				
Heat exchanger		Louver fin & inner grooved tubing		Straight fin & inner grooved tubing		
Refrigerant control		Electronic expansion valve				
Fan type & Q'ty		Centrifugal fan ×3		Propeller fan ×1		
Fan motor (Starting method)	W	100 + 130 < Direct line start >		86 < Direct line start >		
Air flow	Cooling	m³/min	P-Hi : 36 Hi : 28 Me : 25 Lo : 19		75	
	Heating				73	
Available external static pressure	Pa	Standard : 60 Max : 200		0		
Outside air intake		Possible		-		
Air filter, Quality / Quantity		Procure locally		-		
Shock & vibration absorber		Rubber sleeve (for fan motor)		Rubber sleeve (for compressor)		
Electric heater	W	-		20 (Crank case heater)		
Operation control	Remote control	(option) wired : RC-EX1A, RC-E5, RCH-E3 wireless : RCN-KIT3-E				
	Room temperature control	Thermostat by electronics				
	Operation display	-				
Safety equipments		Overload protection for fan motor. Frost protection thermostat. Internal thermostat for fan motor. Abnormal discharge temperature protection.				
Installation data	Refrigerant piping size (O.D.)	mm	Liquid line: I/U φ 9.52 (3/8") Pipe φ 9.52(3/8")×0.8 O/U φ 9.52 (3/8") Gas line: φ 15.88 (5/8") φ 15.88 (5/8")×1.0 φ 15.88 (5/8")			
	Connecting method		Flare piping		Flare piping	
	Attached length of piping	m	-		-	
	Insulation for piping		Necessary (both Liquid & Gas lines)			
	Refrigerant line (one way) length	m	Max.50m			
	Vertical height diff. between O.U. and I.U.	m	Max.30m (Outdoor unit is higher)		Max.15m (Outdoor unit is lower)	
Drain hose		Hose connectable VP25 (I.D.25 O.D.32)		Holes size φ 20 × 3pcs		
Drain pump, max lift height	mm	Built-in Drain pump, 600		-		
Recommended breaker size	A	-				
L.R.A. (Locked rotor ampere)	A	5 / 5				
Interconnecting wires Size × Core number		φ 1.6mm×3 cores (including earth cable) / Terminal block (Screw fixing type)				
IP number		IPX0		IP24		
Standard accessories		Mounting kit, Drain hose		Edging		
Option parts		-				

Note (1) The data are measured at the following conditions. The pipe length is 7.5m.

Operation	Indoor air temperature		Outdoor air temperature		External static pressure of indoor unit	Standards
	DB	WB	DB	WB		
Cooling	27°C	19°C	35°C	24°C	60Pa	ISO5151-T1
Heating	20°C	-	7°C	6°C		

- (2) This air-conditioner is manufactured and tested in conformity with the ISO.
- (3) Sound level indicates the value in an anechoic chamber. During operation these value are somewhat higher due to ambient conditions.
- (4) Select the breaker size according to the own national standard.
- (5) When wireless remote control is used, fan is 3 speed setting (Hi-Me-Lo) only.
- (6) The operation data indicate when the air-conditioner is operated at 400V50Hz or 380V60Hz.
- (7) The factory E.S.P. setting is set within the range of 80 - 150 Pa.If SW8-4 is turned to "ON", E.S.P. setting range can be changed to 10 - 200 Pa.(For RC-EX1A and RC-E5 only)

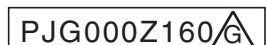

Item		Model	FDU125VNVF		
			Indoor unit FDU125VF	Outdoor unit FDC125VN	
Power source			1 Phase 220-240V 50Hz / 220V 60Hz		
Operation data	Nominal cooling capacity (range)	kW	12.5 [5.0(Min.)~14.0(Max.)]		
	Nominal heating capacity (range)	kW	14.0 [4.0(Min.)~16.0(Max.)]		
	Power consumption	Cooling	kW	3.90	
		Heating		3.88	
	Max power consumption		5.46		
	Running current	Cooling	A	17.5 / 18.3	
		Heating		17.4 / 18.2	
	Inrush current, max current		5, 27		
	Power factor	Cooling	%	97	
		Heating		97	
	EER	Cooling		3.21	
	COP	Heating		3.61	
Sound power level	Cooling	dB(A)	67		
	Heating		72		
Sound pressure level	Cooling	dB(A)	P-Hi : 45 Hi : 40 Me : 34 Lo : 29		
	Heating		50		
Silent mode sound pressure level			51		
Exterior dimensions (Height × Width × Depth)		mm	280 × 1370 × 740		
Exterior appearance (Munsell color)			Stucco White (4.2Y7.5/1.1) near equivalent		
Net weight		kg	54		
Compressor type & Q'ty			RMT5126MDE6×1		
Compressor motor (Starting method)		kW	Direct line start		
Refrigerant oil (Amount, type)		ℓ	0.9 M-MA68		
Refrigerant (Type, amount, pre-charge length)		kg	R410A 3.8kg in outdoor unit (incl. the amount for the piping of : 30m)		
Heat exchanger			Louver fin & inner grooved tubing	Straight fin & inner grooved tubing	
Refrigerant control			Electronic expansion valve		
Fan type & Q'ty			Centrifugal fan ×3	Propeller fan ×1	
Fan motor (Starting method)		W	100 + 200 < Direct line start >	86 < Direct line start >	
Air flow	Cooling	m³/min	P-Hi : 39 Hi : 32 Me : 26 Lo : 20		
	Heating		75		
Available external static pressure		Pa	Standard : 60 Max : 200		
Outside air intake			Possible		
Air filter, Quality / Quantity			Procure locally		
Shock & vibration absorber			Rubber sleeve (for fan motor)	Rubber sleeve (for compressor)	
Electric heater		W	20 (Crank case heater)		
Operation control	Remote control		(option) wired : RC-EX1A, RC-E5, RCH-E3 wireless : RCN-KIT3-E		
	Room temperature control		Thermostat by electronics		
	Operation display		-		
Safety equipments			Overload protection for fan motor. Frost protection thermostat. Internal thermostat for fan motor. Abnormal discharge temperature protection.		
Installation data	Refrigerant piping size (O.D.)	mm	Liquid line: I/U φ 9.52 (3/8") Pipe φ 9.52(3/8")×0.8 O/U φ 9.52 (3/8") Gas line: φ 15.88 (5/8") φ 15.88 (5/8")×1.0 φ 15.88 (5/8")		
	Connecting method		Flare piping		
	Attached length of piping	m	-		
	Insulation for piping		Necessary (both Liquid & Gas lines)		
	Refrigerant line (one way) length	m	Max.50m		
	Vertical height diff. between O.U. and I.U.	m	Max.30m (Outdoor unit is higher) Max.15m (Outdoor unit is lower)		
Drain hose		Hose connectable VP25 (I.D.25, O.D.32) Holes size φ 20 × 3pcs			
Drain pump, max lift height		mm	Built-in Drain pump, 600		
Recommended breaker size		A	-		
L.R.A. (Locked rotor ampere)		A	5 / 5		
Interconnecting wires Size × Core number			φ 1.6mm×3 cores (+ earth cable 1.6mm) / Terminal block (Screw fixing type)		
IP number			IPX0		
Standard accessories			Mounting kit, Drain hose		
Option parts			Edging		

Note (1) The data are measured at the following conditions. The pipe length is 7.5m.

Operation	Indoor air temperature		Outdoor air temperature		External static pressure of indoor unit	Standards
	DB	WB	DB	WB		
Cooling	27°C	19°C	35°C	24°C	60Pa	ISO5151-T1
Heating	20°C	-	7°C	6°C		

- (2) This air-conditioner is manufactured and tested in conformity with the ISO.
- (3) Sound level indicates the value in an anechoic chamber. During operation these value are somewhat higher due to ambient conditions.
- (4) Select the breaker size according to the own national standard.
- (5) When wireless remote control is used, fan is 3 speed setting (Hi-Me-Lo) only.
- (6) The operation data indicate when the air-conditioner is operated at 230V50Hz or 220V60Hz.
- (7) The factory E.S.P. setting is set within the range of 80 - 150 Pa.If SW8-4 is turned to "ON", E.S.P. setting range can be changed to 10 - 200 Pa.(For RC-EX1A and RC-E5 only)

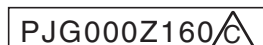

Item		Model	FDU125VSVF		
			Indoor unit FDT125VF	Outdoor unit FDC125VS	
Power source			3 Phase 380-415V 50Hz / 380V 60Hz		
Operation data	Nominal cooling capacity (range)	kW	12.5 [5.0(Min.)~14.0(Max.)]		
	Nominal heating capacity (range)	kW	14.0 [4.0(Min.)~16.0(Max.)]		
	Power consumption	Cooling	kW	3.90	
		Heating		3.88	
	Max power consumption		5.46		
	Running current	Cooling	A	5.8 / 6.1	
		Heating		5.8 / 6.1	
	Inrush current, max current		5, 18		
	Power factor	Cooling	%	97	
		Heating		97	
	EER	Cooling		3.21	
	COP	Heating		3.61	
Sound power level	Cooling	dB(A)	67		
	Heating		72		
Sound pressure level	Cooling	dB(A)	P-Hi : 45 Hi : 40 Me : 34 Lo : 29		
	Heating		50		
Silent mode sound pressure level			51		
Exterior dimensions (Height × Width × Depth)		mm	280 × 1370 × 740		
Exterior appearance (Munsell color)			Stucco White (4.2Y7.5/1.1) near equivalent		
Net weight		kg	54		
Compressor type & Q'ty			RMT5126MDE7×1		
Compressor motor (Starting method)		kW	Direct line start		
Refrigerant oil (Amount, type)		ℓ	0.9 M-MA68		
Refrigerant (Type, amount, pre-charge length)		kg	R410A 3.8kg in outdoor unit (incl. the amount for the piping of : 30m)		
Heat exchanger			Louver fin & inner grooved tubing	Straight fin & inner grooved tubing	
Refrigerant control			Electronic expansion valve		
Fan type & Q'ty			Centrifugal fan ×3	Propeller fan ×1	
Fan motor (Starting method)		W	100 + 200 < Direct line start >	86 < Direct line start >	
Air flow	Cooling	m³/min	P-Hi : 39 Hi : 32 Me : 26 Lo : 20		
	Heating		75		
Available external static pressure		Pa	Standard : 60 Max : 200		
Outside air intake			Possible		
Air filter, Quality / Quantity			Procure locally		
Shock & vibration absorber			Rubber sleeve (for fan motor)	Rubber sleeve (for compressor)	
Electric heater		W	20 (Crank case heater)		
Operation control	Remote control		(option) wired : RC-EX1A, RC-E5, RCH-E3 wireless : RCN-KIT3-E		
	Room temperature control		Thermostat by electronics		
	Operation display		-		
Safety equipments			Overload protection for fan motor. Frost protection thermostat. Internal thermostat for fan motor. Abnormal discharge temperature protection.		
Installation data	Refrigerant piping size (O.D.)	mm	Liquid line: I/U φ 9.52 (3/8") Pipe φ 9.52(3/8")×0.8 O/U φ 9.52 (3/8") Gas line: φ 15.88 (5/8") φ 15.88 (5/8")×1.0 φ 15.88 (5/8")		
	Connecting method		Flare piping		
	Attached length of piping	m	-		
	Insulation for piping		Necessary (both Liquid & Gas lines)		
	Refrigerant line (one way) length	m	Max.50m		
	Vertical height diff. between O.U. and I.U.	m	Max.30m (Outdoor unit is higher) Max.15m (Outdoor unit is lower)		
Drain hose		Hose connectable VP25 (I.D.25, O.D.32) Holes size φ 20 × 3pcs			
Drain pump, max lift height		mm	Built-in Drain pump, 600		
Recommended breaker size		A	-		
L.R.A. (Locked rotor ampere)		A	5 / 5		
Interconnecting wires Size × Core number			φ 1.6mm×3 cores (+ earth cable 1.6mm) / Terminal block (Screw fixing type)		
IP number			IPX0		
Standard accessories			Mounting kit, Drain hose		
Option parts			Edging		

Note (1) The data are measured at the following conditions. The pipe length is 7.5m.

Operation	Indoor air temperature		Outdoor air temperature		External static pressure of indoor unit	Standards
	DB	WB	DB	WB		
Cooling	27°C	19°C	35°C	24°C	60Pa	ISO5151-T1
Heating	20°C	-	7°C	6°C		

- (2) This air-conditioner is manufactured and tested in conformity with the ISO.
- (3) Sound level indicates the value in an anechoic chamber. During operation these value are somewhat higher due to ambient conditions.
- (4) Select the breaker size according to the own national standard.
- (5) When wireless remote control is used, fan is 3 speed setting (Hi-Me-Lo) only.
- (6) The operation data indicate when the air-conditioner is operated at 400V50Hz or 380V60Hz.
- (7) The factory E.S.P. setting is set within the range of 80 - 150 Pa.If SW8-4 is turned to "ON", E.S.P. setting range can be changed to 10 - 200 Pa.(For RC-EX1A and RC-E5 only)

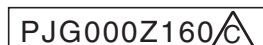

Item		Model	FDU140VNVF		
			Indoor unit FDU140VF	Outdoor unit FDC140VN	
Power source			1 Phase 220-240V 50Hz / 220V 60Hz		
Operation data	Nominal cooling capacity (range)	kW	14.0 [5.0(Min.)~14.5(Max.)]		
	Nominal heating capacity (range)	kW	16.0 [4.0(Min.)~16.5(Max.)]		
	Power consumption	Cooling	kW	4.95	
		Heating	kW	4.69	
	Max power consumption		6.44		
	Running current	Cooling	A	22.2 / 23.2	
		Heating	A	21.0 / 22.0	
	Inrush current, max current			5, 28	
	Power factor	Cooling	%	97	
		Heating	%	97	
	EER	Cooling		2.83	
	COP	Heating		3.41	
Sound power level	Cooling	dB(A)	70		
	Heating		73		
Sound pressure level	Cooling	dB(A)	P-Hi : 47 Hi : 40 Me : 35 Lo : 30		
	Heating		51		
Silent mode sound pressure level			Cooling : 47 / Heating : 50		
Exterior dimensions (Height × Width × Depth)		mm	280 × 1370 × 740		
Exterior appearance (Munsell color)			Stucco White (4.2Y7.5/1.1) near equivalent		
Net weight		kg	54 / 81		
Compressor type & Q'ty			RMT5126MDE6×1		
Compressor motor (Starting method)		kW	Direct line start		
Refrigerant oil (Amount, type)		ℓ	0.9 M-MA68		
Refrigerant (Type, amount, pre-charge length)		kg	R410A 3.8kg in outdoor unit (incl. the amount for the piping of : 30m)		
Heat exchanger			Louver fin & inner grooved tubing	Straight fin & inner grooved tubing	
Refrigerant control			Electronic expansion valve		
Fan type & Q'ty			Centrifugal fan ×3	Propeller fan ×1	
Fan motor (Starting method)		W	100 + 200 < Direct line start >	86 < Direct line start >	
Air flow	Cooling	m³/min	P-Hi : 48 Hi : 35 Me : 28 Lo : 22		
	Heating		75 / 73		
Available external static pressure		Pa	Standard : 60 Max : 200		
Outside air intake			Possible		
Air filter, Quality / Quantity			Procure locally		
Shock & vibration absorber			Rubber sleeve (for fan motor)	Rubber sleeve (for compressor)	
Electric heater		W	20 (Crank case heater)		
Operation control	Remote control		(option) wired : RC-EX1A, RC-E5, RCH-E3 wireless : RCN-KIT3-E		
	Room temperature control		Thermostat by electronics		
	Operation display		-		
Safety equipments			Overload protection for fan motor. Frost protection thermostat. Internal thermostat for fan motor. Abnormal discharge temperature protection.		
Installation data	Refrigerant piping size (O.D.)	mm	Liquid line: I/U φ 9.52 (3/8") Pipe φ 9.52(3/8")×0.8 O/U φ 9.52 (3/8") Gas line: φ 15.88 (5/8") φ 15.88 (5/8")×1.0 φ 15.88 (5/8")		
	Connecting method		Flare piping / Flare piping		
	Attached length of piping	m	-		
	Insulation for piping		Necessary (both Liquid & Gas lines)		
	Refrigerant line (one way) length	m	Max.50m		
	Vertical height diff. between O.U. and I.U.	m	Max.30m (Outdoor unit is higher) / Max.15m (Outdoor unit is lower)		
Drain hose		Hose connectable VP25 (I.D.25, O.D.32) / Holes size φ 20 × 3pcs			
Drain pump, max lift height		mm	Built-in Drain pump, 600		
Recommended breaker size		A	-		
L.R.A. (Locked rotor ampere)		A	5 / 5		
Interconnecting wires Size × Core number			φ 1.6mm×3 cores (+ earth cable 1.6mm) / Terminal block (Screw fixing type)		
IP number			IPX0 / IP24		
Standard accessories			Mounting kit, Drain hose / Edging		
Option parts			-		

Note (1) The data are measured at the following conditions. The pipe length is 7.5m.

Operation	Indoor air temperature		Outdoor air temperature		External static pressure of indoor unit	Standards
	DB	WB	DB	WB		
Cooling	27°C	19°C	35°C	24°C	60Pa	ISO5151-T1
Heating	20°C	-	7°C	6°C		

- (2) This air-conditioner is manufactured and tested in conformity with the ISO.
- (3) Sound level indicates the value in an anechoic chamber. During operation these value are somewhat higher due to ambient conditions.
- (4) Select the breaker size according to the own national standard.
- (5) When wireless remote control is used, fan is 3 speed setting (Hi-Me-Lo) only.
- (6) The operation data indicate when the air-conditioner is operated at 230V50Hz or 220V60Hz.
- (7) The factory E.S.P. setting is set within the range of 80 - 150 Pa.If SW8-4 is turned to "ON", E.S.P. setting range can be changed to 10 - 200 Pa.(For RC-EX1A and RC-E5 only)

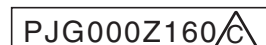

Item		Model	FDU140VSVF		
			Indoor unit FDU140VF	Outdoor unit FDC140VS	
Power source			3 Phase 380-415V 50Hz / 380V 60Hz		
Operation data	Nominal cooling capacity (range)	kW	14.0 [5.0(Min.)~14.5(Max.)]		
	Nominal heating capacity (range)	kW	16.0 [4.0(Min.)~16.5(Max.)]		
	Power consumption	Cooling	kW	4.95	
		Heating		4.69	
	Max power consumption		6.44		
	Running current	Cooling	A	7.4 / 7.8	
		Heating		7.0 / 7.4	
	Inrush current, max current		5, 19		
	Power factor	Cooling	%	97 / 96	
		Heating		97 / 96	
	EER	Cooling		2.83	
	COP	Heating		3.41	
Sound power level	Cooling	dB(A)	70		
	Heating		73		
Sound pressure level	Cooling	dB(A)	P-Hi : 47 Hi : 40 Me : 35 Lo : 30		
	Heating		51		
Silent mode sound pressure level			Cooling : 47 / Heating : 50		
Exterior dimensions (Height × Width × Depth)		mm	280 × 1370 × 740		
Exterior appearance (Munsell color)			Stucco White (4.2Y7.5/1.1) near equivalent		
Net weight		kg	54 / 83		
Compressor type & Q'ty			RMT5126MDE7×1		
Compressor motor (Starting method)		kW	Direct line start		
Refrigerant oil (Amount, type)		ℓ	0.9 M-MA68		
Refrigerant (Type, amount, pre-charge length)		kg	R410A 3.8kg in outdoor unit (incl. the amount for the piping of : 30m)		
Heat exchanger			Louver fin & inner grooved tubing	Straight fin & inner grooved tubing	
Refrigerant control			Electronic expansion valve		
Fan type & Q'ty			Centrifugal fan ×3	Propeller fan ×1	
Fan motor (Starting method)		W	100 + 200 < Direct line start > / 86 < Direct line start >		
Air flow	Cooling	m³/min	P-Hi : 48 Hi : 35 Me : 28 Lo : 22		
	Heating		75 / 73		
Available external static pressure		Pa	Standard : 60 Max : 200 / 0		
Outside air intake			Possible / -		
Air filter, Quality / Quantity			Procure locally / -		
Shock & vibration absorber			Rubber sleeve (for fan motor)	Rubber sleeve (for compressor)	
Electric heater		W	- / 20 (Crank case heater)		
Operation control	Remote control		(option) wired : RC-EX1A, RC-E5, RCH-E3 wireless : RCN-KIT3-E		
	Room temperature control		Thermostat by electronics		
	Operation display		-		
Safety equipments			Overload protection for fan motor. Frost protection thermostat. Internal thermostat for fan motor. Abnormal discharge temperature protection.		
Installation data	Refrigerant piping size (O.D.)	mm	Liquid line: I/U φ 9.52 (3/8") Pipe φ 9.52(3/8")×0.8 O/U φ 9.52 (3/8") Gas line: φ 15.88 (5/8") φ 15.88 (5/8")×1.0 φ 15.88 (5/8")		
	Connecting method		Flare piping / Flare piping		
	Attached length of piping	m	- / -		
	Insulation for piping		Necessary (both Liquid & Gas lines)		
	Refrigerant line (one way) length	m	Max.50m		
	Vertical height diff. between O.U. and I.U.	m	Max.30m (Outdoor unit is higher) / Max.15m (Outdoor unit is lower)		
Drain hose		Hose connectable VP25 (I.D.25, O.D.32) / Holes size φ 20 × 3pcs			
Drain pump, max lift height		mm	Built-in Drain pump, 600 / -		
Recommended breaker size		A	-		
L.R.A. (Locked rotor ampere)		A	5 / 5		
Interconnecting wires Size × Core number			φ 1.6mm×3 cores (+ earth cable 1.6mm) / Terminal block (Screw fixing type)		
IP number			IPX0 / IP24		
Standard accessories			Mounting kit, Drain hose / Edging		
Option parts			-		

Note (1) The data are measured at the following conditions. The pipe length is 7.5m.

Operation	Indoor air temperature		Outdoor air temperature		External static pressure of indoor unit	Standards
	DB	WB	DB	WB		
Cooling	27°C	19°C	35°C	24°C	60Pa	ISO5151-T1
Heating	20°C	-	7°C	6°C		

- (2) This air-conditioner is manufactured and tested in conformity with the ISO.
- (3) Sound level indicates the value in an anechoic chamber. During operation these value are somewhat higher due to ambient conditions.
- (4) Select the breaker size according to the own national standard.
- (5) When wireless remote control is used, fan is 3 speed setting (Hi-Me-Lo) only.
- (6) The operation data indicate when the air-conditioner is operated at 400V50Hz or 380V60Hz.
- (7) The factory E.S.P. setting is set within the range of 80 - 150 Pa.If SW8-4 is turned to "ON", E.S.P. setting range can be changed to 10 - 200 Pa.(For RC-EX1A and RC-E5 only)

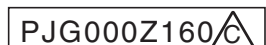

Item		Model	FDU200VSVF	
			Indoor unit FDU200VF	Outdoor unit FDC200VS
Power source		3 Phase 380-415V 50Hz / 380V 60Hz		
Operation data		Cooling		Heating
Nominal capacity	kW	20.0 [7.0 (Min.)~22.4 (Max.)]		22.4 [7.6 (Min.)~25.0 (Max.)]
Power consumption	kW	6.59 / 6.58		6.08 / 5.84
Running current	A	10.8 / 11.4		10.2 / 10.3
Power factor	%	88		86
Inrush current	A	5 < Max.running current 24 >		
Sound pressure level	dB(A)	51		57
Silent mode sound pressure level		Cooling : 56 / Heating : 56		
Exterior dimensions Height x Width x Depth	mm	360 × 1,570 × 830		1,300 × 970 × 370
Exterior appearance (Munsell color)		—		Stucco White (4.2Y7.5/1.1) near equivalent
Net weight	kg	92		122
Compressor type & Q'ty		—		GTC5150ND70K × 1
Starting method		—		Direct line start
Refrigerant oil	ℓ	—		1.45 M-MA32R
Heat exchanger		Louver fin & inner grooved tubing		Straight fin & inner grooved tubing
Refrigerant control		—		Electronic expansion valve
Air handling equipment Fan type & Q'ty		Centrifugal fan × 4		Propeller fan × 2
Motor <Starting method >	W	270 × 2 < Direct line start >		86 × 2 < Direct line start >
Air flow	CMM	Hi : 51 / 60		Cooling : 150 , Heating : 145
External static pressure	Pa	200		0
Outdoor air intake		Possible (on return duct)		—
Air filter, Q'ty		Procure locally		—
Shock & vibration absorber		Rubber sleeve (for fan motor)		Rubber sleeve (for compressor)
Insulation (noise & heat)		Polyurethane form		—
Electric heater	W	—		33 (Crank case heater)
Remote control		wired : RC-EX1A (option) wired : RC-E5 (option) wireless : RCN-KIT3-E (option)		
Room temperature control		Thermostat by electronics		—
Safety equipment		Internal thermostat for fan motor Frost protection thermostat		Internal thermostat for fan motor Abnormal discharge temperature protection.
Installation data Refrigerant piping size	mm	Liquid line : I/U φ 9.52 (3/8") Pipe φ 9.52 (3/8") × 0.8 O/U φ 9.52 (3/8")		
Connecting method		Gas line : I/U φ 25.4 (1") φ 22.22 (7/8") × 1.6 φ 22.22 (7/8")		Liquid : Flare / Gas : Brazing
Refrigerant line (one way) length		Max.70m		
Vertical height difference between outdoor unit and indoor unit		Max.30m (Outdoor unit is higher) Max.15m (Outdoor unit is lower)		
Refrigerant Quantity		R410A 5.4kg in outdoor unit (incl. the amount for the piping of : 30m)		
Drain pump		—		—
Drain		Hose connectable with VP25		Holes size φ 20 × 3pcs
Insulation for piping		Necessary (both Liquid & Gas lines)		
IP code		IPX0		IPX4
Standard Accessories		—		Connecting pipe, Edging

Notes (1) The data are measured at the following conditions.

Item	Indoor air temperature		Outdoor air temperature		External static pressure of indoor unit Pa
	DB	WB	DB	WB	
Operation	27°C	19°C	35°C	24°C	100 (With optional fan controller kit :U-FCRA)
Cooling	27°C	19°C	35°C	24°C	
Heating	20°C		7°C	6°C	

(2) This packaged air-conditioner is manufactured and tested in conformity with the ISO.

(3) Sound pressure level indicates the value in an anechoic chamber. During operation these value are somewhat higher due to ambient temperature.

(4) The operation data indicate when the air-conditioner is operated at 400V50Hz or 380V60Hz.

(5) Values of sound pressure level become increased 5dB(A) when external static pressure is 200Pa (factory setting).

(6) Values of air flow are those at external static pressure 200Pa (factory setting).

PJD001Z362

Item		Model	FDU250VSVF	
			Indoor unit FDU250VSVF	Outdoor unit FDC250VS
Power source		3 Phase 380-415V 50Hz / 380V 60Hz		
Operation data		Cooling		Heating
Nominal capacity	kW	25.0 [10.0 (Min.)~28.0 (Max.)]		28.0 [9.5 (Min.)~31.5 (Max.)]
Power consumption	kW	9.91 / 10.21		8.50 / 8.22
Running current	A	15.7 / 17.0		14.4 / 14.7
Power factor	%	91		85
Inrush current	A	5 < Max.running current 27 >		
Sound pressure level	dB(A)	52		Cooling : 57 Heating : 58
Silent mode sound pressure level		Cooling : 56 / Heating : 57		
Exterior dimensions Height x Width x Depth	mm	360 × 1,570 × 830		1,505 × 970 × 370
Exterior appearance (Munsell color)		—		Stucco White (4.2Y7.5/1.1) near equivalent
Net weight	kg	92		140
Compressor type & Q'ty		—		GTC5150ND70K × 1
Starting method		—		Direct line start
Refrigerant oil	ℓ	—		1.45 M-MA32R
Heat exchanger		Louver fin & inner grooved tubing		Straight fin & inner grooved tubing
Refrigerant control		—		Electronic expansion valve
Air handling equipment Fan type & Q'ty		Centrifugal fan × 4		Propeller fan × 2
Motor <Starting method>	W	270 × 2 < Direct line start >		86 × 2 < Direct line start >
Air flow	CMM	Hi : 68 / 80		Cooling : 150 , Heating : 145
External static pressure	Pa	200		0
Outdoor air intake		Possible (on return duct)		—
Air filter, Q'ty		Procure locally		—
Shock & vibration absorber		Rubber sleeve (for fan motor)		Rubber sleeve (for compressor)
Insulation (noise & heat)		Polyurethane form		—
Electric heater	W	—		33 (Crank case heater)
Remote control		wired : RC-EX1A (option) wired : RC-E5 (option) wireless : RCN-KIT3-E (option)		
Room temperature control		Thermostat by electronics		—
Safety equipment		Internal thermostat for fan motor Frost protection thermostat		Internal thermostat for fan motor Abnormal discharge temperature protection.
Installation data Refrigerant piping size	mm	Liquid line : I/U φ 12.7 (1/2") Pipe φ 12.7 (1/2") × 0.8 O/U φ 12.7 (1/2")		
Connecting method		Gas line : I/U φ 25.4 (1") φ 22.22 (7/8") × 1.6 φ 22.22 (7/8")		Liquid : Flare / Gas : Brazing
Refrigerant line (one way) length		Max.70m		
Vertical height difference between outdoor unit and indoor unit		Max.30m (Outdoor unit is higher) Max.15m (Outdoor unit is lower)		
Refrigerant Quantity		R410A 7.2kg in outdoor unit (incl. the amount for the piping of : 30m)		
Drain pump		—		—
Drain		Hose connectable with VP25		Holes size φ 20 × 3pcs
Insulation for piping		Necessary (both Liquid & Gas lines)		
IP code		IPX0		IPX4
Standard Accessories		—		Connecting pipe, Edging

Notes (1) The data are measured at the following conditions.

Item	Indoor air temperature		Outdoor air temperature		External static pressure of indoor unit Pa
	DB	WB	DB	WB	
Operation	27°C	19°C	35°C	24°C	100 (With optional fan controller kit :U-FCRA)
Cooling	20°C		7°C	6°C	
Heating					

(2) This packaged air-conditioner is manufactured and tested in conformity with the ISO.

(3) Sound pressure level indicates the value in an anechoic chamber. During operation these value are somewhat higher due to ambient temperature.

(4) The operation data indicate when the air-conditioner is operated at 400V50Hz or 380V60Hz.

(5) Values of sound pressure level become increased 5dB (A) when external static pressure is 200Pa (factory setting).

(6) Values of air flow are those at external static pressure 200Pa (factory setting).

PJD001Z362

(5) Duct connected - Low / Middle static pressure type (FDUM)
(a) Single type

Item		Model	FDUM100VNVF1				
			Indoor unit FDUM100VF1	Outdoor unit FDC100VN			
Power source			1 Phase 220-240V 50Hz / 220V 60Hz				
Operation data	Nominal cooling capacity (range)	kW	10.0 [4.0(Min.) ~ 11.2(Max.)]				
	Nominal heating capacity (range)	kW	11.2 [4.0(Min.) ~ 12.5(Max.)]				
	Power consumption	Cooling	kW	2.80			
		Heating		3.02			
	Max power consumption			4.23			
	Running current	Cooling	A	12.6 / 13.2			
		Heating		13.5 / 14.1			
	Inrush current, max current			5, 24			
	Power factor	Cooling	%	97 / 96			
		Heating		97			
	EER	Cooling		3.57			
	COP	Heating		3.71			
	Sound power level	Cooling	dB(A)	65	70		
Heating							
Sound pressure level	Cooling	dB(A)	P-Hi : 44 Hi : 38 Me : 36 Lo : 30				
	Heating		49				
Silent mode sound pressure level			Cooling : 46 / Heating : 46				
Exterior dimensions (Height × Width × Depth)		mm	280 × 1370 × 740	845×970×370			
Exterior appearance (Munsell color)			—	Stucco White (4.2Y7.5/1.1)near equivalent			
Net weight		kg	54	81			
Compressor type & Q'ty			—	RMT5126MDE2×1			
Compressor motor (Starting method)		kW	—	Direct line start			
Refrigerant oil (Amount, type)		ℓ	—	0.9 M-MA68			
Refrigerant (Type, amount, pre-charge length)		kg	R410A 3.8kg in outdoor unit (incl. the amount for the piping of : 30m)				
Heat exchanger			Louver fin & inner grooved tubing	Straight fin & inner grooved tubing			
Refrigerant control			Electronic expansion valve				
Fan type & Q'ty			Centrifugal fan ×3	Propeller fan ×1			
Fan motor (Starting method)		W	100 + 130 < Direct line start >	86 < Direct line start >			
Air flow	Cooling	m³/min	P-Hi : 36 Hi : 28 Me : 25 Lo : 19				
	Heating		75 73				
Available external static pressure		Pa	Standard : 60 Max : 100	—			
Outside air intake			Possible	—			
Air filter, Quality / Quantity			Procure locally	—			
Shock & vibration absorber			Rubber sleeve (for fan motor)	Rubber sleeve (for compressor)			
Electric heater		W	—	20 (Crank case heater)			
Operation control	Remote control		(option) wired : RC-EX1A, RC-E5, RCH-E3 wireless : RCN-KIT3-E				
	Room temperature control		Thermostat by electronics				
	Operation display		—				
Safety equipments			Overload protection for fan motor. Frost protection thermostat. Internal thermostat for fan motor. Abnormal discharge temperature protection.				
Installation data	Refrigerant piping size (O.D.)	mm	Liquid line: I/U φ 9.52 (3/8") Pipe φ 9.52(3/8")×0.8 O/U φ 9.52 (3/8") Gas line: φ 15.88 (5/8") φ 15.88(5/8")×1.0 φ 15.88 (5/8")				
	Connecting method		Flare piping	Flare piping			
	Attached length of piping	m	—	—			
	Insulation for piping			Necessary (both Liquid & Gas lines)			
	Refrigerant line (one way) length	m	Max.50m				
	Vertical height diff. between O.U. and I.U.	m	Max.30m (Outdoor unit is higher)		Max.15m (Outdoor unit is lower)		
Drain hose			Hose connectable with VP25 (O.D.32)	Holes size φ 20 × 3pcs			
Drain pump, max lift height		mm	Built-in Drain pump, 600				
Recommended breaker size		A	—				
L.R.A. (Locked rotor ampere)		A	5.0				
Interconnecting wires Size x Core number			φ 1.6mm×3 cores (+ earth cable 1.6mm) / Terminal block (Screw fixing type)				
IP number			IPX0	IP24			
Standard accessories			Mounting kit, Drain hose	Edging			
Option parts			UM-FL3EF				
Note (1) The data are measured at the following conditions. The pipe length is 7.5m.							
Operation	Item	Indoor air temperature		Outdoor air temperature		External static pressure of indoor unit	Standards
		DB	WB	DB	WB		
	Cooling	27°C	19°C	35°C	24°C		
Heating	20°C	—	7°C	6°C			
(2) This air-conditioner is manufactured and tested in conformity with the ISO. (3) Sound level indicates the value in an anechoic chamber. During operation these value are somewhat higher due to ambient conditions. (4) Select the breaker size according to the own national standard. (5) When wireless remote control is used, fan is 3 speed setting (Hi-Me-Lo) only. (6) The operation data indicate when the air-conditioner is operated at 230V50Hz or 220V60Hz. (7) Static pressure of optional air filter "UM-FL3EF" is 5Pa initially. (8) The external static pressure setting can be changed to 10-100Pa. (For RC-EX1A and RC-E5 only)							

Item		Model	FDUM100VNVF2			
			Indoor unit FDUM100VF2	Outdoor unit FDC100VN		
Power source			1 Phase 220-240V 50Hz / 220V 60Hz			
Operation data	Nominal cooling capacity (range)	kW	10.0 [4.0(Min.) ~ 11.2(Max.)]			
	Nominal heating capacity (range)	kW	11.2 [4.0(Min.) ~ 12.5(Max.)]			
	Power consumption	Cooling	kW	2.80		
		Heating		3.02		
	Max power consumption			4.23		
	Running current	Cooling	A	12.6 / 13.2		
		Heating		13.5 / 14.1		
	Inrush current, max current			5, 24		
	Power factor	Cooling	%	97 / 96		
		Heating		97		
	EER	Cooling		3.57		
	COP	Heating		3.71		
Sound power level	Cooling	dB(A)	65	70		
	Heating					
Sound pressure level	Cooling	dB(A)	P-Hi : 44 Hi : 38 Me : 36 Lo : 30			
	Heating		49			
Silent mode sound pressure level			-			
Exterior dimensions (Height × Width × Depth)		mm	280 × 1370 × 740	845×970×370		
Exterior appearance (Munsell color)			-	Stucco White (4.2Y7.5/1.1)near equivalent		
Net weight		kg	54	81		
Compressor type & Q'ty			-	RMT5126MDE2×1		
Compressor motor (Starting method)		kW	-	Direct line start		
Refrigerant oil (Amount, type)		ℓ	-	0.9 M-MA68		
Refrigerant (Type, amount, pre-charge length)		kg	R410A 3.8kg in outdoor unit (incl. the amount for the piping of : 30m)			
Heat exchanger			Louver fin & inner grooved tubing	Straight fin & inner grooved tubing		
Refrigerant control			Electronic expansion valve			
Fan type & Q'ty			Centrifugal fan ×3	Propeller fan ×1		
Fan motor (Starting method)		W	100 + 130 < Direct line start >	86 < Direct line start >		
Air flow	Cooling	m³/min	P-Hi : 36 Hi : 28 Me : 25 Lo : 19			
	Heating		75 73			
Available external static pressure		Pa	Standard : 60 Max : 100	-		
Outside air intake			Possible	-		
Air filter, Quality / Quantity			Procure locally	-		
Shock & vibration absorber			Rubber sleeve (for fan motor)	Rubber sleeve (for compressor)		
Electric heater		W	-	20 (Crank case heater)		
Operation control	Remote control		(option) wired : RC-EX1A, RC-E5, RCH-E3 wireless : RCN-KIT3-E			
	Room temperature control		Thermostat by electronics			
	Operation display		-			
Safety equipments			Overload protection for fan motor. Frost protection thermostat. Internal thermostat for fan motor. Abnormal discharge temperature protection.			
Installation data	Refrigerant piping size (O.D.)	mm	Liquid line: I/U φ 9.52 (3/8") Pipe φ 9.52(3/8")×0.8 O/U φ 9.52 (3/8") Gas line: φ 15.88 (5/8") φ 15.88(5/8")×1.0 φ 15.88 (5/8")			
	Connecting method		Flare piping	Flare piping		
	Attached length of piping	m	-	-		
	Insulation for piping			Necessary (both Liquid & Gas lines)		
	Refrigerant line (one way) length	m	Max.50m			
	Vertical height diff. between O.U. and I.U.	m	Max.30m (Outdoor unit is higher)		Max.15m (Outdoor unit is lower)	
Drain hose			Hose connectable with VP25 (O.D.32)	Holes size φ 20 × 3pcs		
Drain pump, max lift height		mm	Built-in Drain pump, 600			
Recommended breaker size		A	-			
L.R.A. (Locked rotor ampere)		A	5.0			
Interconnecting wires Size x Core number			φ 1.6mm × 3 cores (including earth cable) / Terminal block (Screw fixing type)			
IP number			IPX0	IP24		
Standard accessories			Mounting kit, Drain hose	Edging		
Option parts			UM-FL3EF			
Note (1) The data are measured at the following conditions. The pipe length is 7.5m.						
Operation	Cooling	Indoor air temperature		External static pressure of indoor unit	Standards	
		DB	WB			DB
	27°C	19°C	35°C			24°C
Heating	Indoor air temperature		External static pressure of indoor unit	Standards		
	20°C	-			7°C	6°C
(2) This air-conditioner is manufactured and tested in conformity with the ISO. (3) Sound level indicates the value in an anechoic chamber. During operation these value are somewhat higher due to ambient conditions. (4) Select the breaker size according to the own national standard. (5) When wireless remote control is used, fan is 3 speed setting (Hi-Me-Lo) only. (6) The operation data indicate when the air-conditioner is operated at 230V50Hz or 220V60Hz. (7) Static pressure of optional air filter "UM-FL3EF" is 5Pa initially. (8) The external static pressure setting can be changed to 10-100Pa. (For RC-EX1A and RC-E5 only)						

Item		Model	FDUM100VSVF1		
			Indoor unit FDUM100VF1	Outdoor unit FDC100VS	
Power source			3 Phase 380-415V 50Hz / 380V 60Hz		
Operation data	Nominal cooling capacity (range)	kW	10.0 [4.0(Min.) ~ 11.2(Max.)]		
	Nominal heating capacity (range)	kW	11.2 [4.0(Min.) ~ 12.5(Max.)]		
	Power consumption	Cooling	kW	2.80	
		Heating		3.02	
	Max power consumption		4.23		
	Running current	Cooling	A	4.2 / 4.4	
		Heating		4.5 / 4.7	
	Inrush current, max current		5, 15		
	Power factor	Cooling	%	96 / 97	
		Heating		97 / 98	
	EER	Cooling		3.57	
	COP	Heating		3.71	
Sound power level	Cooling	dB(A)	65	70	
	Heating				
Sound pressure level	Cooling	dB(A)	P-Hi : 44 Hi : 38 Me : 36 Lo : 30		
	Heating		49		
Silent mode sound pressure level			Cooling : 46 / Heating : 46		
Exterior dimensions (Height x Width x Depth)	mm	280 x 1370 x 740		845 x 970 x 370	
Exterior appearance (Munsell color)		-		Stucco White (4.2Y7.5/1.1)near equivalent	
Net weight	kg	54		83	
Compressor type & Q'ty		-		RMT5126MDE3x1	
Compressor motor (Starting method)	kW	-		Direct line start	
Refrigerant oil (Amount, type)	ℓ	-		0.9 M-MA68	
Refrigerant (Type, amount, pre-charge length)	kg	R410A 3.8kg in outdoor unit (incl. the amount for the piping of : 30m)			
Heat exchanger		Louver fin & inner grooved tubing		Straight fin & inner grooved tubing	
Refrigerant control		Electronic expansion valve			
Fan type & Q'ty		Centrifugal fan x3		Propeller fan x1	
Fan motor (Starting method)	W	100 + 130 < Direct line start >		86 < Direct line start >	
Air flow	Cooling	m³/min	P-Hi : 36 Hi : 28 Me : 25 Lo : 19		
	Heating		75 73		
Available external static pressure	Pa	Standard : 60 Max : 100		-	
Outside air intake		Possible		-	
Air filter, Quality / Quantity		Procure locally		-	
Shock & vibration absorber		Rubber sleeve (for fan motor)		Rubber sleeve (for compressor)	
Electric heater	W	-		20 (Crank case heater)	
Operation control	Remote control	(option) wired : RC-EX1A, RC-E5, RCH-E3 wireless : RCN-KIT3-E			
	Room temperature control	Thermostat by electronics			
	Operation display	-			
Safety equipments		Overload protection for fan motor. Frost protection thermostat. Internal thermostat for fan motor. Abnormal discharge temperature protection.			
Installation data	Refrigerant piping size (O.D.)	mm	Liquid line: I/U φ 9.52 (3/8") Pipe φ 9.52(3/8")x0.8 O/U φ 9.52 (3/8") Gas line: φ 15.88 (5/8") φ 15.88(5/8")x1.0 φ 15.88 (5/8")		
	Connecting method		Flare piping		
	Attached length of piping	m	-		
	Insulation for piping		Necessary (both Liquid & Gas lines)		
	Refrigerant line (one way) length	m	Max.50m		
	Vertical height diff. between O.U. and I.U.	m	Max.30m (Outdoor unit is higher) Max.15m (Outdoor unit is lower)		
Drain hose		Hose connectable with VP25 (O.D.32)		Holes size φ 20 x 3pcs	
Drain pump, max lift height	mm	Built-in Drain pump, 600			
Recommended breaker size	A	-			
L.R.A. (Locked rotor ampere)	A	5.0			
Interconnecting wires	Size x Core number	φ 1.6mmx3 cores (+ earth cable 1.6mm) / Terminal block (Screw fixing type)			
IP number		IPX0		IP24	
Standard accessories		Mounting kit, Drain hose		Edging	
Option parts		UM-FL3EF			

Note (1) The data are measured at the following conditions. The pipe length is 7.5m.

Operation	Indoor air temperature		Outdoor air temperature		External static pressure of indoor unit	Standards
	DB	WB	DB	WB		
Cooling	27°C	19°C	35°C	24°C	60Pa	ISO5151-T1
Heating	20°C	-	7°C	6°C		

- (2) This air-conditioner is manufactured and tested in conformity with the ISO.
- (3) Sound level indicates the value in an anechoic chamber. During operation these value are somewhat higher due to ambient conditions.
- (4) Select the breaker size according to the own national standard.
- (5) When wireless remote control is used, fan is 3 speed setting (Hi-Me-Lo) only.
- (6) The operation data indicate when the air-conditioner is operated at 400V50Hz or 380V60Hz.
- (7) Static pressure of optional air filter "UM-FL3EF" is 5Pa initially.
- (8) The external static pressure setting can be changed to 10-100Pa. (For RC-EX1A and RC-E5 only)



Item		Model	FDUM100VS VF2		
			Indoor unit FDUM100VF2	Outdoor unit FDC100VS	
Power source			3 Phase 380-415V 50Hz / 380V 60Hz		
Operation data	Nominal cooling capacity (range)	kW	10.0 [4.0(Min.) ~ 11.2(Max.)]		
	Nominal heating capacity (range)	kW	11.2 [4.0(Min.) ~ 12.5(Max.)]		
	Power consumption	Cooling	kW	2.80	
		Heating		3.02	
	Max power consumption		4.23		
	Running current	Cooling	A	4.2 / 4.4	
		Heating		4.5 / 4.7	
	Inrush current, max current		5, 15		
	Power factor	Cooling	%	96 / 97	
		Heating		97 / 98	
	EER	Cooling		3.57	
	COP	Heating		3.71	
Sound power level	Cooling	dB(A)	65	70	
	Heating				
Sound pressure level	Cooling	dB(A)	P-Hi : 44 Hi : 38 Me : 36 Lo : 30		
	Heating		49		
Silent mode sound pressure level			-		
Exterior dimensions (Height x Width x Depth)	mm	280 x 1370 x 740		845 x 970 x 370	
Exterior appearance (Munsell color)		-		Stucco White (4.2Y7.5/1.1)near equivalent	
Net weight	kg	54		83	
Compressor type & Q'ty		-		RMT5126MDE3x1	
Compressor motor (Starting method)	kW	-		Direct line start	
Refrigerant oil (Amount, type)	ℓ	-		0.9 M-MA68	
Refrigerant (Type, amount, pre-charge length)	kg	R410A 3.8kg in outdoor unit (incl. the amount for the piping of : 30m)			
Heat exchanger		Louver fin & inner grooved tubing		Straight fin & inner grooved tubing	
Refrigerant control		Electronic expansion valve			
Fan type & Q'ty		Centrifugal fan x3		Propeller fan x1	
Fan motor (Starting method)	W	100 + 130 < Direct line start >		86 < Direct line start >	
Air flow	Cooling	m³/min	P-Hi : 36 Hi : 28 Me : 25 Lo : 19		
	Heating		75 73		
Available external static pressure	Pa	Standard : 60 Max : 100		-	
Outside air intake		Possible		-	
Air filter, Quality / Quantity		Procure locally		-	
Shock & vibration absorber		Rubber sleeve (for fan motor)		Rubber sleeve (for compressor)	
Electric heater	W	-		20 (Crank case heater)	
Operation control	Remote control	(option) wired : RC-EX1A, RC-E5, RCH-E3 wireless : RCN-KIT3-E			
	Room temperature control	Thermostat by electronics			
	Operation display	-			
Safety equipments		Overload protection for fan motor. Frost protection thermostat. Internal thermostat for fan motor. Abnormal discharge temperature protection.			
Installation data	Refrigerant piping size (O.D.)	mm	Liquid line: I/U φ 9.52 (3/8") Pipe φ 9.52(3/8")x0.8 O/U φ 9.52 (3/8") Gas line: φ 15.88 (5/8") φ 15.88(5/8")x1.0 φ 15.88 (5/8")		
	Connecting method		Flare piping		
	Attached length of piping	m	-		
	Insulation for piping		Necessary (both Liquid & Gas lines)		
	Refrigerant line (one way) length	m	Max.50m		
	Vertical height diff. between O.U. and I.U.	m	Max.30m (Outdoor unit is higher) Max.15m (Outdoor unit is lower)		
Drain hose		Hose connectable with VP25 (O.D.32)		Holes size φ 20 x 3pcs	
Drain pump, max lift height	mm	Built-in Drain pump, 600			
Recommended breaker size	A	-			
L.R.A. (Locked rotor ampere)	A	5.0			
Interconnecting wires	Size x Core number	φ 1.6mm x3 cores (including earth cable) / Terminal block (Screw fixing type)			
IP number		IPX0		IP24	
Standard accessories		Mounting kit, Drain hose		Edging	
Option parts		UM-FL3EF			

Note (1) The data are measured at the following conditions. The pipe length is 7.5m.

Operation	Indoor air temperature		Outdoor air temperature		External static pressure of indoor unit	Standards
	DB	WB	DB	WB		
Cooling	27°C	19°C	35°C	24°C	60Pa	ISO5151-T1
Heating	20°C	-	7°C	6°C		

- (2) This air-conditioner is manufactured and tested in conformity with the ISO.
- (3) Sound level indicates the value in an anechoic chamber. During operation these value are somewhat higher due to ambient conditions.
- (4) Select the breaker size according to the own national standard.
- (5) When wireless remote control is used, fan is 3 speed setting (Hi-Me-Lo) only.
- (6) The operation data indicate when the air-conditioner is operated at 400V50Hz or 380V60Hz.
- (7) Static pressure of optional air filter "UM-FL3EF" is 5Pa initially.
- (8) The external static pressure setting can be changed to 10-100Pa. (For RC-EX1A and RC-E5 only)

Item		Model	FDUM125VNVF		
			Indoor unit FDUM125VF	Outdoor unit FDC125VN	
Power source			1 Phase 220-240V 50Hz / 220V 60Hz		
Operation data	Nominal cooling capacity (range)	kW	12.5 [5.0(Min.) ~ 14.0(Max.)]		
	Nominal heating capacity (range)	kW	14.0 [4.0(Min.) ~ 16.0(Max.)]		
	Power consumption	Cooling	kW	3.90	
		Heating		3.88	
	Max power consumption		5.46		
	Running current	Cooling	A	17.5 / 18.3	
		Heating		17.4 / 18.2	
	Inrush current, max current		5, 24		
	Power factor	Cooling	%	97	
		Heating		97	
	EER	Cooling	3.21		
	COP	Heating	3.61		
	Sound power level	Cooling	dB(A)	67	72
		Heating			
Sound pressure level	Cooling	dB(A)	P-Hi : 45 Hi : 40 Me : 34 Lo : 29		
	Heating		50		
Silent mode sound pressure level			Cooling : 46 / Heating : 48		
Exterior dimensions (Height x Width x Depth)	mm	280 x 1370 x 740		845x970x370	
Exterior appearance (Munsell color)		-		Stucco White (4.2Y7.5/1.1)near equivalent	
Net weight	kg	54		81	
Compressor type & Q'ty		-		RMT5126MDE2x1	
Compressor motor (Starting method)	kW	-		Direct line start	
Refrigerant oil (Amount, type)	ℓ	-		0.9 M-MA68	
Refrigerant (Type, amount, pre-charge length)	kg	R410A 3.8kg in outdoor unit (incl. the amount for the piping of : 30m)			
Heat exchanger		Louver fin & inner grooved tubing		Straight fin & inner grooved tubing	
Refrigerant control		Electronic expansion valve			
Fan type & Q'ty		Centrifugal fan x3		Propeller fan x1	
Fan motor (Starting method)	W	100 + 200 < Direct line start >		86 < Direct line start >	
Air flow	Cooling	m³/min	P-Hi : 39 Hi : 32 Me : 26 Lo : 20		
	Heating		75		
Available external static pressure	Pa	Standard : 60 Max : 100		-	
Outside air intake		Possible		-	
Air filter, Quality / Quantity		Procure locally		-	
Shock & vibration absorber		Rubber sleeve (for fan motor)		Rubber sleeve (for compressor)	
Electric heater	W	-		20 (Crank case heater)	
Operation control	Remote control	(option) wired : RC-EX1A, RC-E5, RCH-E3 wireless : RCN-KIT3-E			
	Room temperature control	Thermostat by electronics			
	Operation display	-			
Safety equipments		Overload protection for fan motor. Frost protection thermostat. Internal thermostat for fan motor. Abnormal discharge temperature protection.			
Installation data	Refrigerant piping size (O.D.)	mm	Liquid line: I/U φ 9.52 (3/8") Pipe φ 9.52(3/8")x0.8 O/U φ 9.52 (3/8") Gas line: φ 15.88 (5/8") φ 15.88(5/8")x1.0 φ 15.88 (5/8")		
	Connecting method		Flare piping		
	Attached length of piping	m	-		
	Insulation for piping		Necessary (both Liquid & Gas lines)		
	Refrigerant line (one way) length	m	Max.50m		
	Vertical height diff. between O.U. and I.U.	m	Max.30m (Outdoor unit is higher) Max.15m (Outdoor unit is lower)		
Drain hose		Hose connectable with VP25 (O.D.32)		Holes size φ 20 x 3pcs	
Drain pump, max lift height	mm	Built-in Drain pump, 600			
Recommended breaker size	A	-			
L.R.A. (Locked rotor ampere)	A	5.0			
Interconnecting wires	Size x Core number	φ 1.6mmx3 cores (+ earth cable 1.6mm) / Terminal block (Screw fixing type)			
IP number		IPX0		IP24	
Standard accessories		Mounting kit, Drain hose		Edging	
Option parts		UM-FL3EF			

Note (1) The data are measured at the following conditions. The pipe length is 7.5m.

Operation	Indoor air temperature		Outdoor air temperature		External static pressure of indoor unit	Standards
	DB	WB	DB	WB		
Cooling	27°C	19°C	35°C	24°C	60Pa	ISO5151-T1
Heating	20°C	-	7°C	6°C		

- (2) This air-conditioner is manufactured and tested in conformity with the ISO.
- (3) Sound level indicates the value in an anechoic chamber. During operation these value are somewhat higher due to ambient conditions.
- (4) Select the breaker size according to the own national standard.
- (5) When wireless remote control is used, fan is 3 speed setting (Hi-Me-Lo) only.
- (6) The operation data indicate when the air-conditioner is operated at 230V50Hz or 220V60Hz.
- (7) Static pressure of optional air filter "UM-FL3EF" is 5Pa initially.
- (8) The external static pressure setting can be changed to 10-100Pa. (For RC-EX1A and RC-E5 only)

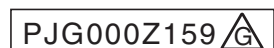

Item		Model	FDUM125VSVF		
			Indoor unit FDUM125VF	Outdoor unit FDC125VS	
Power source			3 Phase 380-415V 50Hz / 380V 60Hz		
Operation data	Nominal cooling capacity (range)	kW	12.5 [5.0(Min.) ~ 14.0(Max.)]		
	Nominal heating capacity (range)	kW	14.0 [4.0(Min.) ~ 16.0(Max.)]		
	Power consumption	Cooling	kW	3.90	
		Heating		3.88	
	Max power consumption		5.46		
	Running current	Cooling	A	5.8 / 6.1	
		Heating		5.8 / 6.1	
	Inrush current, max current		5, 15		
	Power factor	Cooling	%	97	
		Heating		97	
	EER	Cooling		3.21	
	COP	Heating		3.61	
Sound power level	Cooling	dB(A)	67	72	
	Heating				
Sound pressure level	Cooling	dB(A)	P-Hi : 45 Hi : 40 Me : 34 Lo : 29		
	Heating		50		
Silent mode sound pressure level			Cooling : 46 / Heating : 48		
Exterior dimensions (Height x Width x Depth)	mm	280 x 1370 x 740		845 x 970 x 370	
Exterior appearance (Munsell color)		-		Stucco White (4.2Y7.5/1.1)near equivalent	
Net weight	kg	54		83	
Compressor type & Q'ty		-		RMT5126MDE3x1	
Compressor motor (Starting method)	kW	-		Direct line start	
Refrigerant oil (Amount, type)	ℓ	-		0.9 M-MA68	
Refrigerant (Type, amount, pre-charge length)	kg	R410A 3.8kg in outdoor unit (incl. the amount for the piping of : 30m)			
Heat exchanger		Louver fin & inner grooved tubing		Straight fin & inner grooved tubing	
Refrigerant control		Electronic expansion valve			
Fan type & Q'ty		Centrifugal fan x3		Propeller fan x1	
Fan motor (Starting method)	W	100 + 200 < Direct line start >		86 < Direct line start >	
Air flow	Cooling	m³/min	P-Hi : 39 Hi : 32 Me : 26 Lo : 20		
	Heating		75		
Available external static pressure	Pa	Standard : 60 Max : 100		-	
Outside air intake		Possible		-	
Air filter, Quality / Quantity		Procure locally		-	
Shock & vibration absorber		Rubber sleeve (for fan motor)		Rubber sleeve (for compressor)	
Electric heater	W	-		20 (Crank case heater)	
Operation control	Remote control	(option) wired : RC-EX1A, RC-E5, RCH-E3 wireless : RCN-KIT3-E			
	Room temperature control	Thermostat by electronics			
	Operation display	-			
Safety equipments		Overload protection for fan motor. Frost protection thermostat. Internal thermostat for fan motor. Abnormal discharge temperature protection.			
Installation data	Refrigerant piping size (O.D.)	mm	Liquid line: I/U φ 9.52 (3/8") Pipe φ 9.52(3/8")x0.8 O/U φ 9.52 (3/8") Gas line: φ 15.88 (5/8") φ 15.88(5/8")x1.0 φ 15.88 (5/8")		
	Connecting method		Flare piping		
	Attached length of piping	m	-		
	Insulation for piping		Necessary (both Liquid & Gas lines)		
	Refrigerant line (one way) length	m	Max.50m		
	Vertical height diff. between O.U. and I.U.	m	Max.30m (Outdoor unit is higher) Max.15m (Outdoor unit is lower)		
Drain hose		Hose connectable with VP25 (O.D.32)		Holes size φ 20 x 3pcs	
Drain pump, max lift height	mm	Built-in Drain pump, 600			
Recommended breaker size	A	-			
L.R.A. (Locked rotor ampere)	A	5.0			
Interconnecting wires	Size x Core number	φ 1.6mmx3 cores (+ earth cable 1.6mm) / Terminal block (Screw fixing type)			
IP number		IPX0		IP24	
Standard accessories		Mounting kit, Drain hose		Edging	
Option parts		UM-FL3EF			

Note (1) The data are measured at the following conditions. The pipe length is 7.5m.

Operation	Indoor air temperature		Outdoor air temperature		External static pressure of indoor unit	Standards
	DB	WB	DB	WB		
Cooling	27°C	19°C	35°C	24°C	60Pa	ISO5151-T1
Heating	20°C	-	7°C	6°C		

- (2) This air-conditioner is manufactured and tested in conformity with the ISO.
- (3) Sound level indicates the value in an anechoic chamber. During operation these value are somewhat higher due to ambient conditions.
- (4) Select the breaker size according to the own national standard.
- (5) When wireless remote control is used, fan is 3 speed setting (Hi-Me-Lo) only.
- (6) The operation data indicate when the air-conditioner is operated at 400V50Hz or 380V60Hz.
- (7) Static pressure of optional air filter "UM-FL3EF" is 5Pa initially.
- (8) The external static pressure setting can be changed to 10-100Pa. (For RC-EX1A and RC-E5 only)



Item		Model	FDUM140VNVF		
			Indoor unit FDUM140VF	Outdoor unit FDC140VN	
Power source			1 Phase 220-240V 50Hz / 220V 60Hz		
Operation data	Nominal cooling capacity (range)	kW	14.0 [5.0(Min.) ~ 14.5(Max.)]		
	Nominal heating capacity (range)	kW	16.0 [4.0(Min.) ~ 16.5(Max.)]		
	Power consumption	Cooling	kW	4.95	
		Heating		4.69	
	Max power consumption		6.44		
	Running current	Cooling	A	22.2 / 23.2	
		Heating		21.0 / 22.0	
	Inrush current, max current		5, 24		
	Power factor	Cooling	%	97	
		Heating		97	
	EER	Cooling		2.83	
	COP	Heating		3.41	
Sound power level	Cooling	dB(A)	70		
	Heating		73		
Sound pressure level	Cooling	dB(A)	P-Hi : 47 Hi : 40 Me : 35 Lo : 30		
	Heating		51		
Silent mode sound pressure level			Cooling : 47 / Heating : 50		
Exterior dimensions (Height x Width x Depth)	mm	280 x 1370 x 740		845x970x370	
Exterior appearance (Munsell color)		-		Stucco White (4.2Y7.5/1.1)near equivalent	
Net weight	kg	54		81	
Compressor type & Q'ty		-		RMT5126MDE2x1	
Compressor motor (Starting method)	kW	-		Direct line start	
Refrigerant oil (Amount, type)	ℓ	-		0.9 M-MA68	
Refrigerant (Type, amount, pre-charge length)	kg	R410A 3.8kg in outdoor unit (incl. the amount for the piping of : 30m)			
Heat exchanger		Louver fin & inner grooved tubing		Straight fin & inner grooved tubing	
Refrigerant control		Electronic expansion valve			
Fan type & Q'ty		Centrifugal fan x3		Propeller fan x1	
Fan motor (Starting method)	W	100 + 200 < Direct line start >		86 < Direct line start >	
Air flow	Cooling	m³/min	P-Hi : 48 Hi : 35 Me : 28 Lo : 22		
	Heating		75 73		
Available external static pressure	Pa	Standard : 60 Max : 100		-	
Outside air intake		Possible		-	
Air filter, Quality / Quantity		Procure locally		-	
Shock & vibration absorber		Rubber sleeve (for fan motor)		Rubber sleeve (for compressor)	
Electric heater	W	-		20 (Crank case heater)	
Operation control	Remote control	(option) wired : RC-EX1A, RC-E5, RCH-E3 wireless : RCN-KIT3-E			
	Room temperature control	Thermostat by electronics			
	Operation display	-			
Safety equipments		Overload protection for fan motor. Frost protection thermostat. Internal thermostat for fan motor. Abnormal discharge temperature protection.			
Installation data	Refrigerant piping size (O.D.)	mm	Liquid line: I/U φ 9.52 (3/8") Pipe φ 9.52(3/8")x0.8 O/U φ 9.52 (3/8") Gas line: φ 15.88 (5/8") φ 15.88(5/8")x1.0 φ 15.88 (5/8")		
	Connecting method		Flare piping		
	Attached length of piping	m	-		
	Insulation for piping		Necessary (both Liquid & Gas lines)		
	Refrigerant line (one way) length	m	Max.50m		
	Vertical height diff. between O.U. and I.U.	m	Max.30m (Outdoor unit is higher) Max.15m (Outdoor unit is lower)		
Drain hose		Hose connectable with VP25 (O.D.32)		Holes size φ 20 x 3pcs	
Drain pump, max lift height	mm	Built-in Drain pump, 600			
Recommended breaker size	A	-			
L.R.A. (Locked rotor ampere)	A	5.0			
Interconnecting wires	Size x Core number	φ 1.6mmx3 cores (+ earth cable 1.6mm) / Terminal block (Screw fixing type)			
IP number		IPX0		IP24	
Standard accessories		Mounting kit, Drain hose		Edging	
Option parts		UM-FL3EF			

Note (1) The data are measured at the following conditions. The pipe length is 7.5m.

Operation	Indoor air temperature		Outdoor air temperature		External static pressure of indoor unit	Standards
	DB	WB	DB	WB		
Cooling	27°C	19°C	35°C	24°C	60Pa	ISO5151-T1
Heating	20°C	-	7°C	6°C		

- (2) This air-conditioner is manufactured and tested in conformity with the ISO.
- (3) Sound level indicates the value in an anechoic chamber. During operation these value are somewhat higher due to ambient conditions.
- (4) Select the breaker size according to the own national standard.
- (5) When wireless remote control is used, fan is 3 speed setting (Hi-Me-Lo) only.
- (6) The operation data indicate when the air-conditioner is operated at 230V50Hz or 220V60Hz.
- (7) Static pressure of optional air filter "UM-FL3EF" is 5Pa initially.
- (8) The external static pressure setting can be changed to 10-100Pa. (For RC-EX1A and RC-E5 only)

Item		Model	FDUM140VSVF		
			Indoor unit FDUM140VF	Outdoor unit FDC140VS	
Power source			3 Phase 380-415V 50Hz / 380V 60Hz		
Operation data	Nominal cooling capacity (range)	kW	14.0 [5.0(Min.) ~ 14.5(Max.)]		
	Nominal heating capacity (range)	kW	16.0 [4.0(Min.) ~ 16.5(Max.)]		
	Power consumption	Cooling	kW	4.95	
		Heating		4.69	
	Max power consumption		6.44		
	Running current	Cooling	A	7.4 / 7.8	
		Heating		7.0 / 7.4	
	Inrush current, max current		5, 15		
	Power factor	Cooling	%	97 / 96	
		Heating		97 / 96	
	EER	Cooling		2.83	
	COP	Heating		3.41	
Sound power level	Cooling	dB(A)	70		
	Heating		73		
Sound pressure level	Cooling		P-Hi : 47 Hi : 40 Me : 35 Lo : 30		
	Heating		51		
Silent mode sound pressure level			Cooling : 47 / Heating : 50		
Exterior dimensions (Height x Width x Depth)	mm	280 x 1370 x 740		845x970x370	
Exterior appearance (Munsell color)		-		Stucco White (4.2Y7.5/1.1)near equivalent	
Net weight	kg	54		83	
Compressor type & Q'ty		-		RMT5126MDE3x1	
Compressor motor (Starting method)	kW	-		Direct line start	
Refrigerant oil (Amount, type)	ℓ	-		0.9 M-MA68	
Refrigerant (Type, amount, pre-charge length)	kg	R410A 3.8kg in outdoor unit (incl. the amount for the piping of : 30m)			
Heat exchanger		Louver fin & inner grooved tubing		Straight fin & inner grooved tubing	
Refrigerant control		Electronic expansion valve			
Fan type & Q'ty		Centrifugal fan x3		Propeller fan x1	
Fan motor (Starting method)	W	100 + 200 < Direct line start >		86 < Direct line start >	
Air flow	Cooling	m³/min	P-Hi : 48 Hi : 35 Me : 28 Lo : 22		
	Heating		75 73		
Available external static pressure	Pa	Standard : 60 Max : 100		-	
Outside air intake		Possible		-	
Air filter, Quality / Quantity		Procure locally		-	
Shock & vibration absorber		Rubber sleeve (for fan motor)		Rubber sleeve (for compressor)	
Electric heater	W	-		20 (Crank case heater)	
Operation control	Remote control	(option) wired : RC-EX1A, RC-E5, RCH-E3 wireless : RCN-KIT3-E			
	Room temperature control	Thermostat by electronics			
	Operation display	-			
Safety equipments		Overload protection for fan motor. Frost protection thermostat. Internal thermostat for fan motor. Abnormal discharge temperature protection.			
Installation data	Refrigerant piping size (O.D.)	mm	Liquid line: I/U φ 9.52 (3/8") Pipe φ 9.52(3/8")x0.8 O/U φ 9.52 (3/8") Gas line: φ 15.88 (5/8") φ 15.88(5/8")x1.0 φ 15.88 (5/8")		
	Connecting method		Flare piping		
	Attached length of piping	m	-		
	Insulation for piping		Necessary (both Liquid & Gas lines)		
	Refrigerant line (one way) length	m	Max.50m		
	Vertical height diff. between O.U. and I.U.	m	Max.30m (Outdoor unit is higher) Max.15m (Outdoor unit is lower)		
Drain hose		Hose connectable with VP25 (O.D.32)		Holes size φ 20 x 3pcs	
Drain pump, max lift height	mm	Built-in Drain pump, 600			
Recommended breaker size	A	-			
L.R.A. (Locked rotor ampere)	A	5.0			
Interconnecting wires	Size x Core number	φ 1.6mmx3 cores (+ earth cable 1.6mm) / Terminal block (Screw fixing type)			
IP number		IPX0		IP24	
Standard accessories		Mounting kit, Drain hose		Edging	
Option parts		UM-FL3EF			

Note (1) The data are measured at the following conditions. The pipe length is 7.5m.

Operation	Indoor air temperature		Outdoor air temperature		External static pressure of indoor unit	Standards
	DB	WB	DB	WB		
Cooling	27°C	19°C	35°C	24°C	60Pa	ISO5151-T1
Heating	20°C	-	7°C	6°C		

- (2) This air-conditioner is manufactured and tested in conformity with the ISO.
- (3) Sound level indicates the value in an anechoic chamber. During operation these value are somewhat higher due to ambient conditions.
- (4) Select the breaker size according to the own national standard.
- (5) When wireless remote control is used, fan is 3 speed setting (Hi-Me-Lo) only.
- (6) The operation data indicate when the air-conditioner is operated at 400V50Hz or 380V60Hz.
- (7) Static pressure of optional air filter "UM-FL3EF" is 5Pa initially.
- (8) The external static pressure setting can be changed to 10-100Pa. (For RC-EX1A and RC-E5 only)

(b) Twin type

Item		Model	FDUM100VNPVF		
			Indoor unit FDUM50VF (2 units)	Outdoor unit FDC100VN	
Power source			1 Phase 220-240V 50Hz / 220V 60Hz		
Operation data	Nominal cooling capacity (range)	kW	10.0 [4.0(Min.)~ 11.2(Max.)]		
	Nominal heating capacity (range)	kW	11.2 [4.0(Min.)~ 12.5(Max.)]		
	Power consumption	Cooling	kW	2.84	
		Heating		3.35	
	Max power consumption		4.69		
	Running current	Cooling	A	12.7 / 13.3	
		Heating		15.0 / 15.7	
	Inrush current, max current		5, 24		
	Power factor	Cooling	%	97	
		Heating		97	
	EER	Cooling	3.52		
	COP	Heating	3.34		
Sound power level	Cooling	dB(A)	60	70	
	Heating				
Sound pressure level	Cooling	dB(A)	P-Hi : 37 Hi : 32 Me : 29 Lo : 26	49	
	Heating				
Silent mode sound pressure level			Cooling : 46 / Heating : 46		
Exterior dimensions (Height × Width × Depth)		mm	280 × 750 × 635		
Exterior appearance (Munsell color)			Stucco White (4.2Y7.5/1.1) near equivalent		
Net weight		kg	29		
Compressor type & Q'ty			RMT5126MDE2×1		
Compressor motor (Starting method)		kW	Direct line start		
Refrigerant oil (Amount, type)		ℓ	0.9 M-MA68		
Refrigerant (Type, amount, pre-charge length)		kg	R410A 3.8kg in outdoor unit (incl. the amount for the piping of : 30m)		
Heat exchanger			Louver fin & inner grooved tubing	Straight fin & inner grooved tubing	
Refrigerant control			Electronic expansion valve		
Fan type & Q'ty			Centrifugal fan ×1	Propeller fan ×1	
Fan motor (Starting method)		W	100 < Direct line start >	86 < Direct line start >	
Air flow	Cooling	m³/min	P-Hi : 13 Hi : 10 Me : 9 Lo : 8		
	Heating		75		
Available external static pressure		Pa	Standard : 35 Max : 100		
Outside air intake			Possible		
Air filter, Quality / Quantity			Procure locally		
Shock & vibration absorber			Rubber sleeve (for fan motor)	Rubber sleeve (for compressor)	
Electric heater		W	20 (Crank case heater)		
Operation control	Remote control		(option) wired : RC-EX1A, RC-E5, RCH-E3 wireless : RCN-KIT3-E		
	Room temperature control		Thermostat by electronics		
	Operation display		-		
Safety equipments			Overload protection for fan motor. Frost protection thermostat. Internal thermostat for fan motor. Abnormal discharge temperature protection.		
Installation data	Refrigerant piping size (O.D.)	mm	Liquid line: I/U φ 6.35 (1/4") ② φ 9.52(3/8")×0.8 ① φ 9.52(3/8")×0.8 O/U φ 9.52 (3/8") Gas line: I/U φ 12.7 (1/2") ② φ 12.7(1/2")×0.8 ① φ 15.88(5/8")×1.0 O/U φ 15.88 (5/8")		
	Connecting method		Flare piping	Flare piping	
	Attached length of piping	m	-		
	Insulation for piping		Necessary (both Liquid & Gas lines)		
	Refrigerant line (one way) length	m	Max.50m		
	Vertical height diff. between O.U. and I.U.	m	Max.30m (Outdoor unit is higher)	Max.15m (Outdoor unit is lower)	
Drain hose		Hose connectable with VP25 (O.D.32)		Holes size φ 20 × 3pcs	
Drain pump, max lift height	mm	Built-in Drain pump, 600		-	
Recommended breaker size	A	-		-	
L.R.A. (Locked rotor ampere)	A	-		5.0	
Interconnecting wires	Size × Core number	φ 1.6mm×3 cores (+ earth cable 1.6mm) / Terminal block (Screw fixing type)			
IP number		IPX0		IP24	
Standard accessories		Mounting kit, Drain hose		Edging	
Option parts			UM-FL1EF		
Note (1) The data are measured at the following conditions.		The pipe length is 7.5m.			
	Item	Indoor air temperature	Outdoor air temperature	External static pressure of indoor unit	Standards
operation		DB	DB	35Pa	ISO5151-T1
		WB	WB		
		27°C	19°C		
		20°C	-	7°C	6°C
<p>(2) This air-conditioner is manufactured and tested in conformity with the ISO.</p> <p>(3) Sound level indicates the value in an anechoic chamber. During operation these value are somewhat higher due to ambient conditions.</p> <p>(4) Select the breaker size according to the own national standard.</p> <p>(5) When wireless remote control is used, fan is 3 speed setting (Hi-Me-Lo) only.</p> <p>(6) The operation data indicate when the air-conditioner is operated at 230V50Hz or 220V60Hz.</p> <p>(7) Indoor unit specifications for one unit. Capacity and operation data is two indoor units are combined and run together.</p> <p>(8) Branching pipe set "DIS-WA1"×1(option). ① : Pipe of O/U-Branch, ② : Pipe of Branch-I/U</p> <p>(9) Static pressure of optional air filter "UM-FL1EF" is 5Pa initially.</p> <p>(10) The external static pressure setting can be changed to 10-100Pa. (For RC-EX1A and RC-E5 only)</p>					

Item		Model	FDUM100VSPVF			
			Indoor unit FDUM50VF (2 units)	Outdoor unit FDC100VS		
Power source			3 Phase 380-415V 50Hz / 380V 60Hz			
Operation data	Nominal cooling capacity (range)	kW	10.0 [4.0(Min.)~11.2(Max.)]			
	Nominal heating capacity (range)	kW	11.2 [4.0(Min.)~12.5(Max.)]			
	Power consumption	Cooling	kW	2.84		
		Heating		3.35		
	Max power consumption		4.69			
	Running current	Cooling	A	4.2 / 4.4		
		Heating		5.0 / 5.3		
	Inrush current, max current		5, 15			
	Power factor	Cooling	%	98		
		Heating		97 / 96		
	EER	Cooling	3.52			
COP	Heating	3.34				
Sound power level	Cooling	dB(A)	60	70		
	Heating					
Sound pressure level	Cooling	dB(A)	P-Hi : 37 Hi : 32 Me : 29 Lo : 26			
	Heating		49			
Silent mode sound pressure level			— Cooling : 46 / Heating : 46			
Exterior dimensions (Height × Width × Depth)	mm	280 × 750 × 635		845×970×370		
Exterior appearance (Munsell color)		—		Stucco White (4.2Y7.5/1.1) near equivalent		
Net weight	kg	29		83		
Compressor type & Q'ty		—		RMT5126MDE3×1		
Compressor motor (Starting method)	kW	—		Direct line start		
Refrigerant oil (Amount, type)	ℓ	—		0.9 M-MA68		
Refrigerant (Type, amount, pre-charge length)	kg	R410A 3.8kg in outdoor unit (incl. the amount for the piping of : 30m)				
Heat exchanger		Louver fin & inner grooved tubing		Straight fin & inner grooved tubing		
Refrigerant control		Electronic expansion valve				
Fan type & Q'ty		Centrifugal fan ×1		Propeller fan ×1		
Fan motor (Starting method)	W	100 < Direct line start >		86 < Direct line start >		
Air flow	Cooling	m³/min	P-Hi : 13 Hi : 10 Me : 9 Lo : 8			
	Heating		75			
Available external static pressure	Pa	Standard : 35 Max : 100		—		
Outside air intake		Possible		—		
Air filter, Quality / Quantity		Procure locally		—		
Shock & vibration absorber		Rubber sleeve (for fan motor)		Rubber sleeve (for compressor)		
Electric heater	W	—		20 (Crank case heater)		
Operation control	Remote control	(option) wired : RC-EX1A, RC-E5, RCH-E3 wireless : RCN-KIT3-E				
	Room temperature control	Thermostat by electronics				
	Operation display	—				
Safety equipments		Overload protection for fan motor. Frost protection thermostat. Internal thermostat for fan motor. Abnormal discharge temperature protection.				
Installation data	Refrigerant piping size (O.D.)	mm	Liquid line: I/U φ 6.35 (1/4") ② φ 9.52(3/8")×0.8 ① φ 9.52(3/8")×0.8 O/U φ 9.52 (3/8") Gas line: I/U φ 12.7 (1/2") ② φ 12.7(1/2")×0.8 ① φ 15.88(5/8")×1.0 O/U φ 15.88 (5/8")			
	Connecting method		Flare piping			
	Attached length of piping	m	—			
	Insulation for piping		Necessary (both Liquid & Gas lines)			
	Refrigerant line (one way) length	m	Max.50m			
	Vertical height diff. between O.U. and I.U.	m	Max.30m (Outdoor unit is higher)		Max.15m (Outdoor unit is lower)	
Drain hose		Hose connectable with VP25 (O.D.32)		Holes size φ 20 × 3pcs		
Drain pump, max lift height	mm	Built-in Drain pump, 600		—		
Recommended breaker size	A	—				
L.R.A. (Locked rotor ampere)	A	5.0				
Interconnecting wires	Size × Core number	φ 1.6mm×3 cores (+ earth cable 1.6mm) / Terminal block (Screw fixing type)				
IP number		IPX0		IP24		
Standard accessories		Mounting kit, Drain hose		Edging		
Option parts		UM-FL1EF				
Note (1) The data are measured at the following conditions.		The pipe length is 7.5m.				
operation	Indoor air temperature	Outdoor air temperature		External static pressure of indoor unit	Standards	
		DB	WB			DB
	27°C	19°C	35°C			24°C
Heating	20°C	—	7°C	6°C		
<p>(2) This air-conditioner is manufactured and tested in conformity with the ISO.</p> <p>(3) Sound level indicates the value in an anechoic chamber. During operation these value are somewhat higher due to ambient conditions.</p> <p>(4) Select the breaker size according to the own national standard.</p> <p>(5) When wireless remote control is used, fan is 3 speed setting (Hi-Me-Lo) only.</p> <p>(6) The operation data indicate when the air-conditioner is operated at 400V50Hz or 380V60Hz.</p> <p>(7) Indoor unit specifications for one unit. Capacity and operation data are two indoor units are combined and run together.</p> <p>(8) Branching pipe set "DIS-WA1"×1(option). ①: Pipe of O/U~Branch, ②: Pipe of Branch~I/U</p> <p>(9) Static pressure of optional air filter "UM-FL1EF" is 5Pa initially.</p> <p>(10) The external static pressure setting can be changed to 10-100Pa. (For RC-EX1A and RC-E5 only)</p>						

Item		Model	FDUM125VNPVF				
			Indoor unit FDUM60VF (2 units)	Outdoor unit FDC125VN			
Power source			1 Phase 220-240V 50Hz / 220V 60Hz				
Operation data	Nominal cooling capacity (range)	kW	12.5 [5.0(Min.)~14.0(Max.)]				
	Nominal heating capacity (range)	kW	14.0 [4.0(Min.)~16.0(Max.)]				
	Power consumption	Cooling	kW	3.87			
		Heating		4.07			
	Max power consumption		5.70				
	Running current	Cooling	A	17.3 / 18.1			
		Heating		18.2 / 19.0			
	Inrush current, max current		5, 24				
	Power factor	Cooling	%	97			
		Heating		97			
	EER	Cooling		3.23			
COP	Heating		3.44				
Sound power level	Cooling	dB(A)	60	72			
	Heating						
Sound pressure level	Cooling	dB(A)	P-Hi : 36 Hi : 31 Me : 28 Lo : 25				
	Heating		50				
Silent mode sound pressure level			Cooling : 46 / Heating : 48				
Exterior dimensions (Height × Width × Depth)	mm	280 × 950 × 635		845×970×370			
Exterior appearance (Munsell color)		—		Stucco White (4.2Y7.5/1.1) near equivalent			
Net weight	kg	34		81			
Compressor type & Q'ty		—		RMT5126MDE2×1			
Compressor motor (Starting method)	kW	—		Direct line start			
Refrigerant oil (Amount, type)	ℓ	—		0.9 M-MA68			
Refrigerant (Type, amount, pre-charge length)	kg	R410A 3.8kg in outdoor unit (incl. the amount for the piping of : 30m)					
Heat exchanger		Louver fin & inner grooved tubing		Straight fin & inner grooved tubing			
Refrigerant control		Electronic expansion valve					
Fan type & Q'ty		Centrifugal fan ×2		Propeller fan ×1			
Fan motor (Starting method)	W	130 < Direct line start >		86 < Direct line start >			
Air flow	Cooling	m³/min	P-Hi : 20 Hi : 15 Me : 13 Lo : 10				
	Heating		75				
Available external static pressure	Pa	Standard : 35 Max : 100		—			
Outside air intake		Possible		—			
Air filter, Quality / Quantity		Procure locally		—			
Shock & vibration absorber		Rubber sleeve (for fan motor)		Rubber sleeve (for compressor)			
Electric heater	W	—		20 (Crank case heater)			
Operation control	Remote control	(option) wired : RC-EX1A, RC-E5, RCH-E3 wireless : RCN-KIT3-E					
	Room temperature control	Thermostat by electronics					
	Operation display	—					
Safety equipments		Overload protection for fan motor. Frost protection thermostat. Internal thermostat for fan motor. Abnormal discharge temperature protection.					
Installation data	Refrigerant piping size (O.D.)	mm	Liquid line: I/U φ 6.35 (1/4") ② φ 9.52(3/8")×0.8 ① φ 9.52(3/8")×0.8 O/U φ 9.52 (3/8") Gas line: I/U φ 12.7 (1/2") ② φ 12.7(1/2")×0.8 ① φ 15.88(5/8")×1.0 O/U φ 15.88 (5/8")				
	Connecting method		Flare piping				
	Attached length of piping	m	—				
	Insulation for piping		Necessary (both Liquid & Gas lines)				
	Refrigerant line (one way) length	m	Max.50m				
	Vertical height diff. between O.U. and I.U.	m	Max.30m (Outdoor unit is higher)		Max.15m (Outdoor unit is lower)		
Drain hose		Hose connectable with VP25 (O.D.32)		Holes size φ 20 × 3pcs			
Drain pump, max lift height	mm	Built-in Drain pump, 600		—			
Recommended breaker size	A	—					
L.R.A. (Locked rotor ampere)	A	5.0					
Interconnecting wires	Size × Core number	φ 1.6mm×3 cores (+ earth cable 1.6mm) / Terminal block (Screw fixing type)					
IP number		IPX0		IP24			
Standard accessories		Mounting kit, Drain hose		Edging			
Option parts		UM-FL2EF					
Note (1) The data are measured at the following conditions.		The pipe length is 7.5m.					
operation	Item	Indoor air temperature		Outdoor air temperature		External static pressure of indoor unit	Standards
		DB	WB	DB	WB		
	Cooling	27°C	19°C	35°C	24°C		
Heating	20°C	—	7°C	6°C			
(2) This air-conditioner is manufactured and tested in conformity with the ISO. (3) Sound level indicates the value in an anechoic chamber. During operation these value are somewhat higher due to ambient conditions. (4) Select the breaker size according to the own national standard. (5) When wireless remote control is used, fan is 3 speed setting (Hi-Me-Lo) only. (6) The operation data indicate when the air-conditioner is operated at 230V50Hz or 220V60Hz. (7) Indoor unit specifications for one unit. Capacity and operation data are two indoor units are combined and run together. (8) Branching pipe set "DIS-WA1"×1(option). ①: Pipe of O/U~Branch, ②: Pipe of Branch~I/U (9) Static pressure of optional air filter "UM-FL2EF" is 5Pa initially. (10) The external static pressure setting can be changed to 10-100Pa. (For RC-EX1A and RC-E5 only)							

Item		Model	FDUM125VSPVF			
			Indoor unit FDUM60VF (2 units)	Outdoor unit FDC125VS		
Power source			3 Phase 380-415V 50Hz / 380V 60Hz			
Operation data	Nominal cooling capacity (range)	kW	12.5 [5.0(Min.)~14.0(Max.)]			
	Nominal heating capacity (range)	kW	14.0 [4.0(Min.)~16.0(Max.)]			
	Power consumption	Cooling	kW	3.87		
		Heating		4.07		
	Max power consumption		5.70			
	Running current	Cooling	A	5.8 / 6.1		
		Heating		6.1 / 6.4		
	Inrush current, max current		5, 15			
	Power factor	Cooling	%	96		
		Heating		96 / 97		
	EER	Cooling	3.23			
COP	Heating	3.44				
Sound power level	Cooling	dB(A)	60			
	Heating		72			
Sound pressure level	Cooling	dB(A)	P-Hi : 36 Hi : 31 Me : 28 Lo : 25			
	Heating		50			
Silent mode sound pressure level			Cooling : 46 / Heating : 48			
Exterior dimensions (Height × Width × Depth)	mm	280 × 950 × 635		845×970×370		
Exterior appearance (Munsell color)		—		Stucco White (4.2Y7.5/1.1) near equivalent		
Net weight	kg	34		83		
Compressor type & Q'ty		—		RMT5126MDE3×1		
Compressor motor (Starting method)	kW	—		Direct line start		
Refrigerant oil (Amount, type)	ℓ	—		0.9 M-MA68		
Refrigerant (Type, amount, pre-charge length)	kg	R410A 3.8kg in outdoor unit (incl. the amount for the piping of : 30m)				
Heat exchanger		Louver fin & inner grooved tubing		Straight fin & inner grooved tubing		
Refrigerant control		Electronic expansion valve				
Fan type & Q'ty		Centrifugal fan ×2		Propeller fan ×1		
Fan motor (Starting method)	W	130 < Direct line start >		86 < Direct line start >		
Air flow	Cooling	m³/min	P-Hi : 20 Hi : 15 Me : 13 Lo : 10			
	Heating		75			
Available external static pressure	Pa	Standard : 35 Max : 100		—		
Outside air intake		Possible		—		
Air filter, Quality / Quantity		Procure locally		—		
Shock & vibration absorber		Rubber sleeve (for fan motor)		Rubber sleeve (for compressor)		
Electric heater	W	—		20 (Crank case heater)		
Operation control	Remote control	(option) wired : RC-EX1A, RC-E5, RCH-E3 wireless : RCN-KIT3-E				
	Room temperature control	Thermostat by electronics				
	Operation display	—				
Safety equipments		Overload protection for fan motor. Frost protection thermostat. Internal thermostat for fan motor. Abnormal discharge temperature protection.				
Installation data	Refrigerant piping size (O.D.)	mm	Liquid line: I/U φ 6.35 (1/4") ② φ 9.52(3/8")×0.8 ① φ 9.52(3/8")×0.8 O/U φ 9.52 (3/8") Gas line: I/U φ 12.7 (1/2") ② φ 12.7(1/2")×0.8 ① φ 15.88(5/8")×1.0 O/U φ 15.88 (5/8")			
	Connecting method		Flare piping			
	Attached length of piping	m	—			
	Insulation for piping		Necessary (both Liquid & Gas lines)			
	Refrigerant line (one way) length	m	Max.50m			
	Vertical height diff. between O.U. and I.U.	m	Max.30m (Outdoor unit is higher)		Max.15m (Outdoor unit is lower)	
Drain hose		Hose connectable with VP25 (O.D.32)		Holes size φ 20 × 3pcs		
Drain pump, max lift height	mm	Built-in Drain pump, 600		—		
Recommended breaker size	A	—				
L.R.A. (Locked rotor ampere)	A	5.0				
Interconnecting wires	Size × Core number	φ 1.6mm×3 cores (+ earth cable 1.6mm) / Terminal block (Screw fixing type)				
IP number		IPX0		IP24		
Standard accessories		Mounting kit, Drain hose		Edging		
Option parts		UM-FL2EF				
Note (1) The data are measured at the following conditions.		The pipe length is 7.5m.				
operation	Indoor air temperature	DB	Outdoor air temperature		External static pressure of indoor unit	Standards
		WB	DB	WB		
	27°C	19°C	35°C	24°C		
20°C	—	7°C	6°C			
<p>(2) This air-conditioner is manufactured and tested in conformity with the ISO.</p> <p>(3) Sound level indicates the value in an anechoic chamber. During operation these value are somewhat higher due to ambient conditions.</p> <p>(4) Select the breaker size according to the own national standard.</p> <p>(5) When wireless remote control is used, fan is 3 speed setting (Hi-Me-Lo) only.</p> <p>(6) The operation data indicate when the air-conditioner is operated at 400V50Hz or 380V60Hz.</p> <p>(7) Indoor unit specifications for one unit. Capacity and operation data are two indoor units are combined and run together.</p> <p>(8) Branching pipe set "DIS-WA1"×1(option). ①: Pipe of O/U~Branch, ②: Pipe of Branch~I/U</p> <p>(9) Static pressure of optional air filter "UM-FL2EF" is 5Pa initially.</p> <p>(10) The external static pressure setting can be changed to 10-100Pa. (For RC-EX1A and RC-E5 only)</p>						

Item		Model	FDUM140VNPVF1				
			Indoor unit FDUM71VF1 (2 units)	Outdoor unit FDC140VN			
Power source			1 Phase 220-240V 50Hz / 220V 60Hz				
Operation data	Nominal cooling capacity (range)	kW	14.0 [5.0(Min.)~14.5(Max.)]				
	Nominal heating capacity (range)	kW	16.0 [4.0(Min.)~16.5(Max.)]				
	Power consumption	Cooling	kW	4.78			
		Heating		4.60			
	Max power consumption		6.21				
	Running current	Cooling	A	21.4 / 22.4			
		Heating		20.6 / 21.5			
	Inrush current, max current		5, 24				
	Power factor	Cooling	%	97			
		Heating		97			
	EER	Cooling		2.93			
COP	Heating		3.48				
Sound power level	Cooling	dB(A)	65				
	Heating		73				
Sound pressure level	Cooling	dB(A)	P-Hi : 38 Hi : 33 Me : 29 Lo : 25				
	Heating		51				
Silent mode sound pressure level			Cooling : 47 / Heating : 50				
Exterior dimensions (Height × Width × Depth)	mm	280 × 950 × 635		845×970×370			
Exterior appearance (Munsell color)		—		Stucco White (4.2Y7.5/1.1) near equivalent			
Net weight	kg	34		81			
Compressor type & Q'ty		—		RMT5126MDE2×1			
Compressor motor (Starting method)	kW	—		Direct line start			
Refrigerant oil (Amount, type)	ℓ	—		0.9 M-MA68			
Refrigerant (Type, amount, pre-charge length)	kg	R410A 3.8kg in outdoor unit (incl. the amount for the piping of : 30m)					
Heat exchanger		Louver fin & inner grooved tubing		Straight fin & inner grooved tubing			
Refrigerant control		Electronic expansion valve					
Fan type & Q'ty		Centrifugal fan ×2		Propeller fan ×1			
Fan motor (Starting method)	W	130 < Direct line start >		86 < Direct line start >			
Air flow	Cooling	m³/min	P-Hi : 24 Hi : 19 Me : 15 Lo : 10				
	Heating		75				
Available external static pressure	Pa	Standard : 35 Max : 100		—			
Outside air intake		Possible		—			
Air filter, Quality / Quantity		Procure locally		—			
Shock & vibration absorber		Rubber sleeve (for fan motor)		Rubber sleeve (for compressor)			
Electric heater	W	—		20 (Crank case heater)			
Operation control	Remote control	(option) wired : RC-EX1A, RC-E5, RCH-E3 wireless : RCN-KIT3-E					
	Room temperature control	Thermostat by electronics					
	Operation display	—					
Safety equipments		Overload protection for fan motor. Frost protection thermostat. Internal thermostat for fan motor. Abnormal discharge temperature protection.					
Installation data	Refrigerant piping size (O.D.)	mm	Liquid line: I/U φ 9.52 (3/8") ② φ 9.52(3/8")×0.8 ① φ 9.52(3/8")×0.8 O/U φ 9.52 (3/8") Gas line: I/U φ 15.88 (5/8") ② φ 15.88(5/8")×1.0 ① φ 15.88(5/8")×1.0 O/U φ 15.88 (5/8")				
	Connecting method		Flare piping				
	Attached length of piping	m	—				
	Insulation for piping		Necessary (both Liquid & Gas lines)				
	Refrigerant line (one way) length	m	Max.50m				
	Vertical height diff. between O.U. and I.U.	m	Max.30m (Outdoor unit is higher)		Max.15m (Outdoor unit is lower)		
Drain hose		Hose connectable with VP25 (O.D.32)		Holes size φ 20 × 3pcs			
Drain pump, max lift height	mm	Built-in Drain pump, 600		—			
Recommended breaker size	A	—					
L.R.A. (Locked rotor ampere)	A	5.0					
Interconnecting wires	Size × Core number	φ 1.6mm×3 cores (+ earth cable 1.6mm) / Terminal block (Screw fixing type)					
IP number		IPX0		IP24			
Standard accessories		Mounting kit, Drain hose		Edging			
Option parts		UM-FL2EF					
Note (1) The data are measured at the following conditions.		The pipe length is 7.5m.					
operation	Item	Indoor air temperature		Outdoor air temperature		External static pressure of indoor unit	Standards
		DB	WB	DB	WB		
	Cooling	27°C	19°C	35°C	24°C		
Heating	20°C	—	7°C	6°C			
(2) This air-conditioner is manufactured and tested in conformity with the ISO. (3) Sound level indicates the value in an anechoic chamber. During operation these value are somewhat higher due to ambient conditions. (4) Select the breaker size according to the own national standard. (5) When wireless remote control is used, fan is 3 speed setting (Hi-Me-Lo) only. (6) The operation data indicate when the air-conditioner is operated at 230V50Hz or 220V60Hz. (7) Indoor unit specifications for one unit. Capacity and operation data are two indoor units are combined and run together. (8) Branching pipe set "DIS-WA1"×1(option). ①: Pipe of O/U~Branch, ②: Pipe of Branch~I/U (9) Static pressure of optional air filter "UM-FL2EF" is 5Pa initially. (10) The external static pressure setting can be changed to 10-100Pa. (For RC-EX1A and RC-E5 only)							

Item		Model	FDUM140VSPVF1				
			Indoor unit FDUM71VF1 (2 units)	Outdoor unit FDC140VS			
Power source			3 Phase 380-415V 50Hz / 380V 60Hz				
Operation data	Nominal cooling capacity (range)	kW	14.0 [5.0(Min.)~14.5(Max.)]				
	Nominal heating capacity (range)	kW	16.0 [4.0(Min.)~16.5(Max.)]				
	Power consumption	Cooling	kW	4.78			
		Heating		4.60			
	Max power consumption		6.21				
	Running current	Cooling	A	7.1 / 7.5			
		Heating		6.8 / 7.2			
	Inrush current, max current		5, 15				
	Power factor	Cooling	%	97			
		Heating		98 / 97			
	EER	Cooling	2.93				
COP	Heating	3.48					
Sound power level	Cooling	dB(A)	65	73			
	Heating						
Sound pressure level	Cooling	dB(A)	P-Hi : 38 Hi : 33 Me : 29 Lo : 25				
	Heating		51				
Silent mode sound pressure level			Cooling : 47 / Heating : 50				
Exterior dimensions (Height × Width × Depth)	mm	280 × 950 × 635		845×970×370			
Exterior appearance (Munsell color)		—		Stucco White (4.2Y7.5/1.1) near equivalent			
Net weight	kg	34		83			
Compressor type & Q'ty		—		RMT5126MDE3×1			
Compressor motor (Starting method)	kW	—		Direct line start			
Refrigerant oil (Amount, type)	ℓ	—		0.9 M-MA68			
Refrigerant (Type, amount, pre-charge length)	kg	R410A 3.8kg in outdoor unit (incl. the amount for the piping of : 30m)					
Heat exchanger		Louver fin & inner grooved tubing		Straight fin & inner grooved tubing			
Refrigerant control		Electronic expansion valve					
Fan type & Q'ty		Centrifugal fan ×2		Propeller fan ×1			
Fan motor (Starting method)	W	130 < Direct line start >		86 < Direct line start >			
Air flow	Cooling	m³/min	P-Hi : 24 Hi : 19 Me : 15 Lo : 10				
	Heating		75				
Available external static pressure	Pa	Standard : 35 Max : 100		—			
Outside air intake		Possible		—			
Air filter, Quality / Quantity		Procure locally		—			
Shock & vibration absorber		Rubber sleeve (for fan motor)		Rubber sleeve (for compressor)			
Electric heater	W	—		20 (Crank case heater)			
Operation control	Remote control	(option) wired : RC-EX1A, RC-E5, RCH-E3 wireless : RCN-KIT3-E					
	Room temperature control	Thermostat by electronics					
	Operation display	—					
Safety equipments		Overload protection for fan motor. Frost protection thermostat. Internal thermostat for fan motor. Abnormal discharge temperature protection.					
Installation data	Refrigerant piping size (O.D.)	mm	Liquid line: I/U φ 9.52 (3/8") ② φ 9.52(3/8")×0.8 ① φ 9.52(3/8")×0.8 O/U φ 9.52 (3/8") Gas line: I/U φ 15.88 (5/8") ② φ 15.88(5/8")×1.0 ① φ 15.88(5/8")×1.0 O/U φ 15.88 (5/8")				
	Connecting method		Flare piping				
	Attached length of piping	m	—				
	Insulation for piping		Necessary (both Liquid & Gas lines)				
	Refrigerant line (one way) length	m	Max.50m				
	Vertical height diff. between O.U. and I.U.	m	Max.30m (Outdoor unit is higher)		Max.15m (Outdoor unit is lower)		
Drain hose		Hose connectable with VP25 (O.D.32)		Holes size φ 20 × 3pcs			
Drain pump, max lift height	mm	Built-in Drain pump, 600		—			
Recommended breaker size	A	—					
L.R.A. (Locked rotor ampere)	A	5.0					
Interconnecting wires	Size × Core number	φ 1.6mm×3 cores (+ earth cable 1.6mm) / Terminal block (Screw fixing type)					
IP number		IPX0		IP24			
Standard accessories		Mounting kit, Drain hose		Edging			
Option parts		UM-FL2EF					
Note (1) The data are measured at the following conditions.		The pipe length is 7.5m.					
operation	Item	Indoor air temperature		Outdoor air temperature		External static pressure of indoor unit	Standards
		DB	WB	DB	WB		
	Cooling	27°C	19°C	35°C	24°C		
Heating	20°C	—	7°C	6°C			
(2) This air-conditioner is manufactured and tested in conformity with the ISO. (3) Sound level indicates the value in an anechoic chamber. During operation these value are somewhat higher due to ambient conditions. (4) Select the breaker size according to the own national standard. (5) When wireless remote control is used, fan is 3 speed setting (Hi-Me-Lo) only. (6) The operation data indicate when the air-conditioner is operated at 400V50Hz or 380V60Hz. (7) Indoor unit specifications for one unit. Capacity and operation data are two indoor units are combined and run together. (8) Branching pipe set "DIS-WA1"×1(option). ①: Pipe of O/U~Branch, ②: Pipe of Branch~I/U (9) Static pressure of optional air filter "UM-FL2EF" is 5Pa initially. (10) The external static pressure setting can be changed to 10-100Pa. (For RC-EX1A and RC-E5 only)							

Item		Model	FDUM200VSPVF1				
			Indoor unit FDUM100VF1 (2 units)	Outdoor unit FDC200VS			
Power source			3 Phase 380-415V 50Hz / 380V 60Hz				
Operation data	Nominal cooling capacity (range)	kW	20.0 [7.0(Min.)~22.4(Max.)]				
	Nominal heating capacity (range)	kW	22.4 [7.6(Min.)~25.0(Max.)]				
	Power consumption	Cooling	kW	6.86			
		Heating		7.22			
	Max power consumption		9.17				
	Running current	Cooling	A	10.5 / 11.1			
		Heating		11.1 / 11.7			
	Inrush current, max current		5, 19				
	Power factor	Cooling	%	94			
		Heating		94			
	EER	Cooling		2.92			
	COP	Heating		3.1			
Sound power level	Cooling	dB(A)	65	74			
	Heating						
Sound pressure level	Cooling	dB(A)	P-Hi : 44 Hi : 38 Me : 36 Lo : 30				
	Heating		57				
Silent mode sound pressure level			Cooling : 56 / Heating : 56				
Exterior dimensions (Height × Width × Depth)	mm	280 × 1370 × 740		1,300×970×370			
Exterior appearance (Munsell color)		—		Stucco White (4.2Y7.5/1.1) near equivalent			
Net weight	kg	54		122			
Compressor type & Q'ty		—		GTC5150ND70K×1			
Compressor motor (Starting method)	kW	—		Direct line start			
Refrigerant oil (Amount, type)	ℓ	—		1.45 M-MA32R			
Refrigerant (Type, amount, pre-charge length)	kg	R410A 5.4kg (Pre-charged up to the piping length of 30m) Outdoor unit					
Heat exchanger		Louver fin & inner grooved tubing		Straight fin & inner grooved tubing			
Refrigerant control		Electronic expansion valve					
Fan type & Q'ty		Centrifugal fan ×3		Propeller fan ×2			
Fan motor (Starting method)	W	100 + 130 < Direct line start >		86 × 2 < Direct line start >			
Air flow	Cooling	m³/min	P-Hi : 36 Hi : 28 Me : 25 Lo : 19				
	Heating		150				
Available external static pressure	Pa	Standard : 60 Max : 100		—			
Outside air intake		Possible		—			
Air filter, Quality / Quantity		Procure locally		—			
Shock & vibration absorber		Rubber sleeve (for fan motor)		Rubber sleeve (for compressor)			
Electric heater	W	—		33 (Crank case heater)			
Operation control	Remote control	(option) wired : RC-EX1A, RC-E5, RCH-E3 wireless : RCN-KIT3-E					
	Room temperature control	Thermostat by electronics					
	Operation display	—					
Safety equipments		Overload protection for fan motor. Frost protection thermostat. Internal thermostat for fan motor. Abnormal discharge temperature protection.					
Installation data	Refrigerant piping size (O.D.)	mm	Liquid line: I/U φ 9.52 (3/8") ② φ 9.52(3/8")×0.8 ① φ 9.52(3/8")×0.8 O/U φ 9.52 (3/8") Gas line: I/U φ 15.88 (5/8") ② φ 15.88(5/8")×1.0 ① φ 22.22(7/8")×1.6 O/U φ 22.22 (7/8")				
	Connecting method		Flare piping Liquid: Flare / Gas: Brazing				
	Attached length of piping	m	—				
	Insulation for piping		Necessary (both Liquid & Gas lines)				
	Refrigerant line (one way) length	m	Max.70m				
	Vertical height diff. between O.U. and I.U.	m	Max.30m (Outdoor unit is higher) Max.15m (Outdoor unit is lower)				
Drain hose		Hose connectable with VP25 (O.D.32) Holes size φ 20 × 3pcs					
Drain pump, max lift height	mm	Built-in Drain pump, 600		—			
Recommended breaker size	A	—		—			
L.R.A. (Locked rotor ampere)	A	—		5.0			
Interconnecting wires	Size × Core number	φ 1.6mm×3 cores (+ earth cable 1.6mm) / Terminal block (Screw fixing type)					
IP number		IPX0		IP24			
Standard accessories		Mounting kit, Drain hose		Connecting pipe, Edging			
Option parts		UM-FL3EF					
Note (1) The data are measured at the following conditions.		The pipe length is 7.5m.					
operation	Item	Indoor air temperature		Outdoor air temperature		External static pressure of indoor unit	Standards
		DB	WB	DB	WB		
	Cooling	27°C	19°C	35°C	24°C		
Heating	20°C	—	7°C	6°C			
<p>(2) This air-conditioner is manufactured and tested in conformity with the ISO.</p> <p>(3) Sound level indicates the value in an anechoic chamber. During operation these value are somewhat higher due to ambient conditions.</p> <p>(4) Select the breaker size according to the own national standard.</p> <p>(5) When wireless remote control is used, fan is 3 speed setting (Hi-Me-Lo) only.</p> <p>(6) The operation data indicate when the air-conditioner is operated at 400V50Hz or 380V60Hz.</p> <p>(7) Indoor unit specifications for one unit. Capacity and operation data are two indoor units are combined and run together.</p> <p>(8) Branching pipe set "DIS-WB1"×1(option). ①: Pipe of O/U~Branch, ②: Pipe of Branch~I/U</p> <p>(9) Static pressure of optional air filter "UM-FL3EF" is 5Pa initially.</p> <p>(10) The external static pressure setting can be changed to 10-100Pa. (For RC-EX1A and RC-E5 only)</p>							

Item		Model	FDUM250VSPVF			
			Indoor unit FDUM125VF (2 units)	Outdoor unit FDC250VS		
Power source			3 Phase 380-415V 50Hz / 380V 60Hz			
Operation data	Nominal cooling capacity (range)	kW	25.0 [10.0(Min.)~28.0(Max.)]			
	Nominal heating capacity (range)	kW	28.0 [9.5(Min.)~31.5(Max.)]			
	Power consumption	Cooling	kW	9.05		
		Heating		8.51		
	Max power consumption			10.86		
	Running current	Cooling	A	13.9 / 14.6		
		Heating		13.1 / 13.8		
	Inrush current, max current			5, 22		
	Power factor	Cooling	%	94		
		Heating		94		
	EER	Cooling		2.76		
COP	Heating		3.29			
Sound power level	Cooling	dB(A)	67			
	Heating		74			
Sound pressure level	Cooling	dB(A)	P-Hi : 45 Hi : 40 Me : 34 Lo : 29			
	Heating		57			
Silent mode sound pressure level			Cooling : 56 / Heating : 57			
Exterior dimensions (Height × Width × Depth)		mm	280 × 1370 × 740			
Exterior appearance (Munsell color)			Stucco White (4.2Y7.5/1.1) near equivalent			
Net weight		kg	54 / 140			
Compressor type & Q'ty			GTC5150ND70K×1			
Compressor motor (Starting method)		kW	Direct line start			
Refrigerant oil (Amount, type)		ℓ	1.45 M-MA32R			
Refrigerant (Type, amount, pre-charge length)		kg	R410A 7.2kg (Pre-charged up to the piping length of 30m) Outdoor unit			
Heat exchanger			Louver fin & inner grooved tubing	Straight fin & inner grooved tubing		
Refrigerant control			Electronic expansion valve			
Fan type & Q'ty			Centrifugal fan ×3	Propeller fan ×2		
Fan motor (Starting method)		W	100 + 200 < Direct line start >			
Air flow	Cooling	m³/min	P-Hi : 39 Hi : 32 Me : 26 Lo : 20			
	Heating		150 / 145			
Available external static pressure		Pa	Standard : 60 Max : 100			
Outside air intake			Possible			
Air filter, Quality / Quantity			Procure locally			
Shock & vibration absorber			Rubber sleeve (for fan motor)	Rubber sleeve (for compressor)		
Electric heater		W	33 (Crank case heater)			
Operation control	Remote control		(option) wired : RC-EX1A, RC-E5, RCH-E3 wireless : RCN-KIT3-E			
	Room temperature control		Thermostat by electronics			
	Operation display		-			
Safety equipments			Overload protection for fan motor. Frost protection thermostat. Internal thermostat for fan motor. Abnormal discharge temperature protection.			
Installation data	Refrigerant piping size (O.D.)	mm	Liquid line: I/U φ 9.52 (3/8") ② φ 9.52(3/8")×0.8 ① φ 12.7(1/2")×0.8 O/U φ 12.7 (1/2") Gas line: I/U φ 15.88 (5/8") ② φ 15.88(5/8")×1.0 ① φ 22.22(7/8")×1.6 O/U φ 22.22 (7/8")			
	Connecting method		Flare piping / Liquid: Flare / Gas: Brazing			
	Attached length of piping	m	-			
	Insulation for piping		Necessary (both Liquid & Gas lines)			
	Refrigerant line (one way) length	m	Max.70m			
	Vertical height diff. between O.U. and I.U.	m	Max.30m (Outdoor unit is higher) / Max.15m (Outdoor unit is lower)			
Drain hose			Hose connectable with VP25 (O.D.32)	Holes size φ 20 × 3pcs		
Drain pump, max lift height		mm	Built-in Drain pump, 600			
Recommended breaker size		A	-			
L.R.A. (Locked rotor ampere)		A	5.0			
Interconnecting wires Size × Core number			φ 1.6mm×3 cores (+ earth cable 1.6mm) / Terminal block (Screw fixing type)			
IP number			IPX0	IP24		
Standard accessories			Mounting kit, Drain hose	Connecting pipe, Edging		
Option parts			UM-FL3EF			
Note (1) The data are measured at the following conditions.			The pipe length is 7.5m.			
operation	Indoor air temperature	DB	Outdoor air temperature		External static pressure of indoor unit	Standards
		WB	DB	WB		
	27°C	19°C	35°C	24°C		
Heating	20°C	-	7°C	6°C		
<p>(2) This air-conditioner is manufactured and tested in conformity with the ISO.</p> <p>(3) Sound level indicates the value in an anechoic chamber. During operation these value are somewhat higher due to ambient conditions.</p> <p>(4) Select the breaker size according to the own national standard.</p> <p>(5) When wireless remote control is used, fan is 3 speed setting (Hi-Me-Lo) only.</p> <p>(6) The operation data indicate when the air-conditioner is operated at 400V50Hz or 380V60Hz.</p> <p>(7) Indoor unit specifications for one unit. Capacity and operation data are two indoor units are combined and run together.</p> <p>(8) Branching pipe set "DIS-WB1"×1(option). ①: Pipe of O/U~Branch, ②: Pipe of Branch~I/U</p> <p>(9) Static pressure of optional air filter "UM-FL3EF" is 5Pa initially.</p> <p>(10) The external static pressure setting can be changed to 10-100Pa. (For RC-EX1A and RC-E5 only)</p>						

(c) Triple type

Item		Model	FDUM140VNTVF				
			Indoor unit FDUM50VF (3 units)		Outdoor unit FDC140VN		
Power source			1 Phase 220-240V 50Hz / 220V 60Hz				
Operation data	Nominal cooling capacity (range)	kW	14.0 [5.0(Min.)~14.5(Max.)]				
	Nominal heating capacity (range)	kW	16.0 [4.6(Min.)~16.5(Max.)]				
	Power consumption	Cooling	kW	4.65			
		Heating		5.15			
	Max power consumption			6.70			
	Running current	Cooling	A	20.8 / 21.7			
		Heating		23.1 / 24.2			
	Inrush current, max current			5, 24			
	Power factor	Cooling	%	97			
		Heating		97			
	EER	Cooling		3.01			
	COP	Heating		3.11			
Sound power level	Cooling	dB(A)	60		73		
	Heating		P-Hi : 37 Hi : 32 Me : 29 Lo : 26		51		
Sound pressure level	Cooling	dB(A)	—				
	Heating		Cooling : 47 / Heating : 50				
Silent mode sound pressure level			—				
Exterior dimensions (Height × Width × Depth)		mm	280 × 750 × 635		845×970×370		
Exterior appearance (Munsell color)			—		Stucco White (4.2Y7.5/1.1) near equivalent		
Net weight		kg	29		81		
Compressor type & Q'ty			—		RMT5126MDE2×1		
Compressor motor (Starting method)		kW	—		Direct line start		
Refrigerant oil (Amount, type)		ℓ	—		0.9 M-MA68		
Refrigerant (Type, amount, pre-charge length)		kg	R410A 3.8kg in outdoor unit (incl. the amount for the piping of : 30m)				
Heat exchanger			Louver fin & inner grooved tubing		Straight fin & inner grooved tubing		
Refrigerant control			Electronic expansion valve				
Fan type & Q'ty			Centrifugal fan ×1		Propeller fan ×1		
Fan motor (Starting method)		W	100 < Direct line start >		86 < Direct line start >		
Air flow	Cooling	m³/min	P-Hi : 13 Hi : 10 Me : 9 Lo : 8				
	Heating		75				
Available external static pressure		Pa	Standard : 35 Max : 100		—		
Outside air intake			Possible		—		
Air filter, Quality / Quantity			Procure locally		—		
Shock & vibration absorber			Rubber sleeve (for fan motor)		Rubber sleeve (for compressor)		
Electric heater		W	—		20 (Crank case heater)		
Operation control	Remote control		(option) wired : RC-EX1A, RC-E5, RCH-E3 wireless : RCN-KIT3-E				
	Room temperature control		Thermostat by electronics				
	Operation display		—				
Safety equipments			Overload protection for fan motor. Frost protection thermostat. Internal thermostat for fan motor. Abnormal discharge temperature protection.				
Installation data	Refrigerant piping size (O.D.)	mm	Liquid line: I/U φ 6.35 (1/4") ② φ 9.52(3/8")×0.8 ① φ 9.52(3/8")×0.8 O/U φ 9.52 (3/8") Gas line: I/U φ 12.7 (1/2") ② φ 12.7(1/2")×0.8 ① φ 15.88(5/8")×1.0 O/U φ 15.88 (5/8")				
	Connecting method		Flare piping		Flare piping		
	Attached length of piping	m	—		—		
	Insulation for piping		Necessary (both Liquid & Gas lines)				
	Refrigerant line (one way) length	m	Max.50m				
	Vertical height diff. between O.U. and I.U.	m	Max.30m (Outdoor unit is higher)		Max.15m (Outdoor unit is lower)		
Drain hose			Hose connectable with VP25 (O.D.32)		Holes size φ 20 × 3pcs		
Drain pump, max lift height		mm	Built-in Drain pump, 600		—		
Recommended breaker size		A	—				
L.R.A. (Locked rotor ampere)		A	5.0				
Interconnecting wires Size × Core number			φ 1.6mm×3 cores (+ earth cable 1.6mm) / Terminal block (Screw fixing type)				
IP number			IPX0		IP24		
Standard accessories			Mounting kit, Drain hose		Edging		
Option parts			UM-FL1EF				
Note (1) The data are measured at the following conditions.			The pipe length is 7.5m.				
operation	Item	Indoor air temperature		Outdoor air temperature		External static pressure of indoor unit	Standards
		DB	WB	DB	WB		
	Cooling	27°C	19°C	35°C	24°C		
Heating	20°C	—	7°C	6°C			
<p>(2) This air-conditioner is manufactured and tested in conformity with the ISO.</p> <p>(3) Sound level indicates the value in an anechoic chamber. During operation these value are somewhat higher due to ambient conditions.</p> <p>(4) Select the breaker size according to the own national standard.</p> <p>(5) When wireless remote control is used, fan is 3 speed setting (Hi-Me-Lo) only.</p> <p>(6) The operation data indicate when the air-conditioner is operated at 230V50Hz or 220V60Hz.</p> <p>(7) Indoor unit specifications for one unit. Capacity and operation data are three indoor units are combined and run together.</p> <p>(8) Branching pipe set "DIS-TA1"×1(option). ①: Pipe of O/U-Branch, ②: Pipe of Branch-I/U</p> <p>(9) Static pressure of optional air filter "UM-FL1EF" is 5Pa initially.</p> <p>(10) The external static pressure setting can be changed to 10-100Pa. (For RC-EX1A and RC-E5 only)</p>							

Item		Model	FDUM140VSTVF				
			Indoor unit FDUM50VF (3 units)	Outdoor unit FDC140VS			
Power source			3 Phase 380-415V 50Hz / 380V 60Hz				
Operation data	Nominal cooling capacity (range)	kW	14.0 [5.0(Min.) ~ 14.5(Max.)]				
	Nominal heating capacity (range)	kW	16.0 [4.0(Min.) ~ 16.5(Max.)]				
	Power consumption	Cooling	kW	4.65			
		Heating		5.15			
	Max power consumption			6.70			
	Running current	Cooling	A	6.9 / 7.3			
		Heating		7.7 / 8.1			
	Inrush current, max current			5, 15			
	Power factor	Cooling	%	97			
		Heating		97			
	EER	Cooling		3.01			
	COP	Heating		3.11			
Sound power level	Cooling	dB(A)	60	73			
	Heating						
Sound pressure level	Cooling	dB(A)	P-Hi : 37 Hi : 32 Me : 29 Lo : 26				
	Heating		51				
Silent mode sound pressure level			Cooling : 47 / Heating : 50				
Exterior dimensions (Height × Width × Depth)	mm		280 × 750 × 635	845×970×370			
Exterior appearance (Munsell color)			—	Stucco White (4.2Y7.5/1.1) near equivalent			
Net weight	kg		29	83			
Compressor type & Q'ty			—	RMT5126MDE3×1			
Compressor motor (Starting method)	kW		—	Direct line start			
Refrigerant oil (Amount, type)	ℓ		—	0.9 M-MA68			
Refrigerant (Type, amount, pre-charge length)	kg		R410A 3.8kg in outdoor unit (incl. the amount for the piping of : 30m)				
Heat exchanger			Louver fin & inner grooved tubing	Straight fin & inner grooved tubing			
Refrigerant control			Electronic expansion valve				
Fan type & Q'ty			Centrifugal fan ×1	Propeller fan ×1			
Fan motor (Starting method)	W		100 < Direct line start >	86 < Direct line start >			
Air flow	Cooling	m³/min	P-Hi : 13 Hi : 10 Me : 9 Lo : 8				
	Heating		75				
Available external static pressure	Pa		Standard : 35 Max : 100	—			
Outside air intake			Possible	—			
Air filter, Quality / Quantity			Procure locally	—			
Shock & vibration absorber			Rubber sleeve (for fan motor)	Rubber sleeve (for compressor)			
Electric heater	W		—	20 (Crank case heater)			
Operation control	Remote control		(option) wired : RC-EX1A, RC-E5, RCH-E3 wireless : RCN-KIT3-E				
	Room temperature control		Thermostat by electronics				
	Operation display		—				
Safety equipments			Overload protection for fan motor. Frost protection thermostat. Internal thermostat for fan motor. Abnormal discharge temperature protection.				
Installation data	Refrigerant piping size (O.D.)	mm	Liquid line: I/U φ 6.35 (1/4") ② φ 9.52(3/8")×0.8 ① φ 9.52(3/8")×0.8 O/U φ 9.52 (3/8") Gas line: I/U φ 12.7 (1/2") ② φ 12.7(1/2")×0.8 ① φ 15.88(5/8")×1.0 O/U φ 15.88 (5/8")				
	Connecting method		Flare piping	Flare piping			
	Attached length of piping	m	—	—			
	Insulation for piping		Necessary (both Liquid & Gas lines)				
	Refrigerant line (one way) length	m	Max.50m				
	Vertical height diff. between O.U. and I.U.	m	Max.30m (Outdoor unit is higher)	Max.15m (Outdoor unit is lower)			
Drain hose		Hose connectable with VP25 (O.D.32)	Holes size φ 20 × 3pcs				
Drain pump, max lift height	mm	Built-in Drain pump, 600		—			
Recommended breaker size	A	—		—			
L.R.A. (Locked rotor ampere)	A	—		5.0			
Interconnecting wires	Size × Core number	φ 1.6mm×3 cores (+ earth cable 1.6mm) / Terminal block (Screw fixing type)					
IP number		IPX0		IP24			
Standard accessories		Mounting kit, Drain hose		Edging			
Option parts		UM-FL1EF					
Note (1) The data are measured at the following conditions.		The pipe length is 7.5m.					
operation	Item	Indoor air temperature		Outdoor air temperature		External static pressure of indoor unit	Standards
		DB	WB	DB	WB		
	Cooling	27°C	19°C	35°C	24°C		
Heating	20°C	—	7°C	6°C			
(2) This air-conditioner is manufactured and tested in conformity with the ISO. (3) Sound level indicates the value in an anechoic chamber. During operation these value are somewhat higher due to ambient conditions. (4) Select the breaker size according to the own national standard. (5) When wireless remote control is used, fan is 3 speed setting (Hi-Me-Lo) only. (6) The operation data indicate when the air-conditioner is operated at 400V50Hz or 380V60Hz. (7) Indoor unit specifications for one unit. Capacity and operation data are two indoor units are combined and run together. (8) Branching pipe set "DIS-TA1"×1(option). ①: Pipe of O/U~Branch, ②: Pipe of Branch~I/U (9) Static pressure of optional air filter "UM-FL1EF" is 5Pa initially. (10) The external static pressure setting can be changed to 10-100Pa. (For RC-EX1A and RC-E5 only).							

Item		Model	FDUM200VSTVF1				
			Indoor unit FDUM71VF1 (3 units)	Outdoor unit FDC200VS			
Power source			3 Phase 380-415V 50Hz / 380V 60Hz				
Operation data	Nominal cooling capacity (range)	kW	20.0 [7.0(Min.)~22.4(Max.)]				
	Nominal heating capacity (range)	kW	22.4 [7.6(Min.)~25.0(Max.)]				
	Power consumption	Cooling	kW	6.57			
		Heating		6.26			
	Max power consumption		8.34				
	Running current	Cooling	A	10.1 / 10.6			
		Heating		9.6 / 10.1			
	Inrush current, max current		5, 19				
	Power factor	Cooling	%	94			
		Heating		94			
	EER	Cooling	3.04				
COP	Heating	3.58					
Sound power level	Cooling	dB(A)	65	74			
	Heating						
Sound pressure level	Cooling	dB(A)	P-Hi : 38 Hi : 33 Me : 29 Lo : 25				
	Heating		57				
Silent mode sound pressure level			Cooling : 56 / Heating : 56				
Exterior dimensions (Height × Width × Depth)	mm	280 × 950 × 635		1,300×970×370			
Exterior appearance (Munsell color)		—		Stucco White (4.2Y7.5/1.1) near equivalent			
Net weight	kg	34		122			
Compressor type & Q'ty		—		GTC5150ND70K×1			
Compressor motor (Starting method)	kW	—		Direct line start			
Refrigerant oil (Amount, type)	ℓ	—		1.45 M-MA32R			
Refrigerant (Type, amount, pre-charge length)	kg	R410A 5.4kg (Pre-charged up to the piping length of 30m) Outdoor unit					
Heat exchanger		Louver fin & inner grooved tubing		Straight fin & inner grooved tubing			
Refrigerant control		Electronic expansion valve					
Fan type & Q'ty		Centrifugal fan ×2		Propeller fan ×2			
Fan motor (Starting method)	W	130 < Direct line start >		86 × 2 < Direct line start >			
Air flow	Cooling	m³/min	P-Hi : 24 Hi : 19 Me : 15 Lo : 10				
	Heating		150				
Available external static pressure	Pa	Standard : 35 Max : 100		—			
Outside air intake		Possible		—			
Air filter, Quality / Quantity		Procure locally		—			
Shock & vibration absorber		Rubber sleeve (for fan motor)		Rubber sleeve (for compressor)			
Electric heater	W	—		33 (Crank case heater)			
Operation control	Remote control	(option) wired : RC-EX1A, RC-E5, RCH-E3 wireless : RCN-KIT3-E					
	Room temperature control	Thermostat by electronics					
	Operation display	—					
Safety equipments		Overload protection for fan motor. Frost protection thermostat. Internal thermostat for fan motor. Abnormal discharge temperature protection.					
Installation data	Refrigerant piping size (O.D.)	mm	Liquid line: I/U φ 9.52 (3/8") ② φ 9.52(3/8")×0.8 ① φ 9.52(3/8")×0.8 O/U φ 9.52 (3/8")				
	Connecting method		Gas line: I/U φ 15.88 (5/8") ② φ 15.88(5/8")×1.0 ① φ 22.22(7/8")×1.6 O/U φ 22.22 (7/8")				
	Attached length of piping	m	Flare piping				
	Insulation for piping		Liquid: Flare / Gas: Brazing				
	Refrigerant line (one way) length	m	Necessary (both Liquid & Gas lines)				
	Vertical height diff. between O.U. and I.U.	m	Max.70m				
Drain hose		Max.30m (Outdoor unit is higher)		Max.15m (Outdoor unit is lower)			
Drain pump, max lift height	mm	Hose connectable with VP25 (O.D.32)		Holes size φ 20 × 3pcs			
Recommended breaker size	A	Built-in Drain pump, 600		—			
L.R.A. (Locked rotor ampere)	A	—		5.0			
Interconnecting wires	Size × Core number	φ 1.6mm×3 cores (+ earth cable 1.6mm) / Terminal block (Screw fixing type)					
IP number		IPX0		IP24			
Standard accessories		Mounting kit, Drain hose		Connecting pipe, Edging			
Option parts		UM-FL2EF					
Note (1) The data are measured at the following conditions.		The pipe length is 7.5m.					
operation	Item	Indoor air temperature		Outdoor air temperature		External static pressure of indoor unit	Standards
		DB	WB	DB	WB		
	Cooling	27°C	19°C	35°C	24°C		
Heating	20°C	—	7°C	6°C			
(2) This air-conditioner is manufactured and tested in conformity with the ISO. (3) Sound level indicates the value in an anechoic chamber. During operation these value are somewhat higher due to ambient conditions. (4) Select the breaker size according to the own national standard. (5) When wireless remote control is used, fan is 3 speed setting (Hi-Me-Lo) only. (6) The operation data indicate when the air-conditioner is operated at 400V50Hz or 380V60Hz. (7) Indoor unit specifications for one unit. Capacity and operation data are three indoor units are combined and run together. (8) Branching pipe set "DIS-TB1"×1(option). ①: Pipe of O/U~Branch, ②: Pipe of Branch-I/U (9) Static pressure of optional air filter "UM-FL2EF" is 5Pa initially. (10) The external static pressure setting can be changed to 10-100Pa. (For RC-EX1A and RC-E5 only)							

(6) Floor standing type (FDF)

(a) Single type

Item		Model	FDF100VNVD1			
			Indoor unit FDF100VD1	Outdoor unit FDC100VN		
Power source			1 Phase 220-240V 50Hz / 220V 60Hz			
Operation data	Nominal cooling capacity (range)	kW	10.0 [4.0(Min.) ~ 11.2(Max.)]			
	Nominal heating capacity (range)	kW	11.2 [4.0(Min.) ~ 12.5(Max.)]			
	Power consumption	Cooling	kW	3.12		
		Heating		3.10		
	Max power consumption			4.37		
	Running current	Cooling	A	13.8 / 14.5		
		Heating		13.8 / 14.4		
	Inrush current, max current			5, 24		
	Power factor	Cooling	%	98		
		Heating		98		
	EER	Cooling		3.21		
	COP	Heating		3.61		
Sound power level	Cooling	dB(A)	65	70		
	Heating					
Sound pressure level	Cooling	dB(A)	P-Hi : 54 Hi : 50 Me : 48 Lo : 44			
	Heating		49			
Silent mode sound pressure level			—			
Exterior dimensions (Height × Width × Depth)		mm	1,850 × 600 × 320	845×970×370		
Exterior appearance (Munsell color)			Ceramic White (N8.0) near equivalent	Stucco White (4.2Y7.5/1.1) near equivalent		
Net weight		kg	52	81		
Compressor type & Q'ty			—	RMT5126MDE2×1		
Compressor motor (Starting method)		kW	—	Direct line start		
Refrigerant oil (Amount, type)		ℓ	—	0.9 M-MA68		
Refrigerant (Type, amount, pre-charge length)		kg	R410A 3.8kg in outdoor unit (incl. the amount for the piping of : 30m)			
Heat exchanger			Louver fine & inner grooved tubing	Straight fin & inner grooved tubing		
Refrigerant control			Electronic expansion valve			
Fan type & Q'ty			Centrifugal fan ×1	Propeller fan ×1		
Fan motor (Starting method)		W	157 < Direct line start >	86 < Direct line start >		
Air flow	Cooling	m³/min	P-Hi : 29 Hi : 26 Me : 23 Lo : 19			
	Heating		75			
Available external static pressure		Pa	0	—		
Outside air intake			Not possible	—		
Air filter, Quality / Quantity			Plastic net ×1(Washable)	—		
Shock & vibration absorber			Rubber sleeve (for fan motor)	Rubber sleeve (for compressor)		
Electric heater		W	—	20 (Crank case heater)		
Operation control	Remote control		RC-E5 (Installed) / wireless : RCN-KIT3-E (option)			
	Room temperature control		Thermostat by electronics			
	Operation display		—			
Safety equipments			Overload protection for fan motor. Frost protection thermostat. Internal thermostat for fan motor. Abnormal discharge temperature protection.			
Installation data	Refrigerant piping size (O.D.)	mm	Liquid line: I/U φ 9.52 (3/8") Pipe φ 9.52(3/8")×0.8 O/U φ 9.52 (3/8") Gas line: φ 15.88 (5/8") φ 15.88(5/8")×1.0 φ 15.88 (5/8")			
	Connecting method		Flare piping	Flare piping		
	Attached length of piping	m	—	—		
	Insulation for piping		Necessary (both Liquid & Gas lines)			
	Refrigerant line (one way) length	m	Max.50m			
	Vertical height diff. between O.U. and I.U.	m	Max.30m (Outdoor unit is higher)	Max.15m (Outdoor unit is lower)		
Drain hose			Hose connectable with VP20	Holes size φ 20 × 3pcs		
Drain pump, max lift height		mm	—	—		
Recommended breaker size		A	—			
L.R.A. (Locked rotor ampere)		A	5.0			
Interconnecting wires Size × Core number			φ 1.6mm×3 cores (+ earth cable 1.6mm) / Terminal block (Screw fixing type)			
IP number			IPX0	IP24		
Standard accessories			Mounting kit	Edging		
Option parts			—			
Note (1) The data are measured at the following conditions.			The pipe length is 7.5m.			
operation	Item	Indoor air temperature		Outdoor air temperature		Standards
		DB	WB	DB	WB	
	Cooling	27°C	19°C	35°C	24°C	
Heating	20°C	—	7°C	6°C		
(2) This air-conditioner is manufactured and tested in conformity with the ISO. (3) Sound level indicates the value in an anechoic chamber. During operation these value are somewhat higher due to ambient conditions. (4) Select the breaker size according to the own national standard. (5) When wireless remote control is used, fan is 3 speed setting (Hi-Me-Lo) only. (6) The operation data indicate when the air-conditioner is operated at 230V50Hz or 220V60Hz.						

Item		Model	FDF100VNVD2		
			Indoor unit FDF100VD2	Outdoor unit FDC100VN	
Power source			1 Phase 220-240V 50Hz / 220V 60Hz		
Operation data	Nominal cooling capacity (range)	kW	10.0 [4.0(Min.) ~ 11.2(Max.)]		
	Nominal heating capacity (range)	kW	11.2 [4.0(Min.) ~ 12.5(Max.)]		
	Power consumption	Cooling	kW	3.12	
		Heating		3.10	
	Max power consumption		4.37		
	Running current	Cooling	A	13.8 / 14.5	
		Heating		13.8 / 14.4	
	Inrush current, max current		5, 24		
	Power factor	Cooling	%	98	
		Heating		98	
	EER	Cooling		3.21	
COP	Heating		3.61		
Sound power level	Cooling	dB(A)	65	70	
	Heating				
Sound pressure level	Cooling	dB(A)	P-Hi : 54 Hi : 50 Me : 48 Lo : 44		
	Heating		49		
Silent mode sound pressure level			—		
Exterior dimensions (Height × Width × Depth)		mm	1,850 × 600 × 320	845×970×370	
Exterior appearance (Munsell color)			Ceramic White (N8.0) near equivalent	Stucco White (4.2Y7.5/1.1) near equivalent	
Net weight		kg	52	81	
Compressor type & Q'ty			—	RMT5126MDE2×1	
Compressor motor (Starting method)		kW	—	Direct line start	
Refrigerant oil (Amount, type)		ℓ	—	0.9 M-MA68	
Refrigerant (Type, amount, pre-charge length)		kg	R410A 3.8kg in outdoor unit (incl. the amount for the piping of : 30m)		
Heat exchanger			Louver fine & inner grooved tubing	Straight fin & inner grooved tubing	
Refrigerant control			Electronic expansion valve		
Fan type & Q'ty			Centrifugal fan ×1	Propeller fan ×1	
Fan motor (Starting method)		W	157 < Direct line start >	86 < Direct line start >	
Air flow	Cooling	m³/min	P-Hi : 29 Hi : 26 Me : 23 Lo : 19		
	Heating		75		
Available external static pressure		Pa	0	—	
Outside air intake			Not possible	—	
Air filter, Quality / Quantity			Plastic net ×1(Washable)	—	
Shock & vibration absorber			Rubber sleeve (for fan motor)	Rubber sleeve (for compressor)	
Electric heater		W	—	20 (Crank case heater)	
Operation control	Remote control		RC-E5 (Installed) / wireless : RCN-KIT3-E (option)		
	Room temperature control		Thermostat by electronics		
	Operation display		—		
Safety equipments			Overload protection for fan motor. Frost protection thermostat. Internal thermostat for fan motor. Abnormal discharge temperature protection.		
Installation data	Refrigerant piping size (O.D.)	mm	Liquid line: I/U φ 9.52 (3/8") Pipe φ 9.52(3/8")×0.8 O/U φ 9.52 (3/8") Gas line: φ 15.88 (5/8") φ 15.88(5/8")×1.0 φ 15.88 (5/8")		
	Connecting method		Flare piping	Flare piping	
	Attached length of piping	m	—	—	
	Insulation for piping		Necessary (both Liquid & Gas lines)		
	Refrigerant line (one way) length	m	Max.50m		
	Vertical height diff. between O.U. and I.U.	m	Max.30m (Outdoor unit is higher)	Max.15m (Outdoor unit is lower)	
Drain hose			Hose connectable with VP20	Holes size φ 20 × 3pcs	
Drain pump, max lift height		mm	—	—	
Recommended breaker size		A	—		
L.R.A. (Locked rotor ampere)		A	5.0		
Interconnecting wires Size × Core number			φ 1.6mm×3 cores (+ earth cable 1.6mm) / Terminal block (Screw fixing type)		
IP number			IPX0	IP24	
Standard accessories			Mounting kit	Edging	
Option parts			—		

Note (1) The data are measured at the following conditions. The pipe length is 7.5m.

operation	Indoor air temperature		Outdoor air temperature		Standards
	DB	WB	DB	WB	
Cooling	27°C	19°C	35°C	24°C	ISO5151-T1
Heating	20°C	—	7°C	6°C	

- (2) This air-conditioner is manufactured and tested in conformity with the ISO.
- (3) Sound level indicates the value in an anechoic chamber. During operation these value are somewhat higher due to ambient conditions.
- (4) Select the breaker size according to the own national standard.
- (5) When wireless remote control is used, fan is 3 speed setting (Hi-Me-Lo) only.
- (6) The operation data indicate when the air-conditioner is operated at 230V50Hz or 220V60Hz.

Item		Model	FDF100VSVD1			
			Indoor unit FDF100VD1	Outdoor unit FDC100VS		
Power source			3 Phase 380-415V 50Hz / 380V 60Hz			
Operation data	Nominal cooling capacity (range)	kW	10.0 [4.0(Min.) ~ 11.2(Max.)]			
	Nominal heating capacity (range)	kW	11.2 [4.0(Min.) ~ 12.5(Max.)]			
	Power consumption	Cooling	kW	3.12		
		Heating		3.10		
	Max power consumption		4.37			
	Running current	Cooling	A	4.6 / 4.8		
		Heating		4.6 / 4.8		
	Inrush current, max current		5, 15			
	Power factor	Cooling	%	98 / 99		
		Heating		97 / 98		
	EER	Cooling		3.21		
COP	Heating		3.61			
Sound power level	Cooling	dB(A)	65	70		
	Heating					
Sound pressure level	Cooling	dB(A)	P-Hi : 54 Hi : 50 Me : 48 Lo : 44			
	Heating		49			
Silent mode sound pressure level			—			
Cooling : 46 / Heating : 46						
Exterior dimensions (Height × Width × Depth)		mm	1,850 × 600 × 320			
Exterior appearance (Munsell color)			Ceramic White (N8.0) near equivalent			
Stucco White (4.2Y7.5/1.1) near equivalent						
Net weight		kg	52			
Compressor type & Q'ty			—			
Compressor motor (Starting method)		kW	—			
Refrigerant oil (Amount, type)		ℓ	—			
Refrigerant (Type, amount, pre-charge length)		kg	R410A 3.8kg in outdoor unit (incl. the amount for the piping of : 30m)			
Heat exchanger			Louver fine & inner grooved tubing			
Refrigerant control			Straight fin & inner grooved tubing			
Fan type & Q'ty			Electronic expansion valve			
Fan motor (Starting method)		W	Centrifugal fan ×1			
Air flow		m³/min	Propeller fan ×1			
Available external static pressure		Pa	157 < Direct line start >			
Outside air intake			86 < Direct line start >			
Air filter, Quality / Quantity			75			
Shock & vibration absorber			73			
Electric heater		W	0			
Operation control			Not possible			
Remote control			Plastic net ×1 (Washable)			
Room temperature control			Rubber sleeve (for fan motor)			
Operation display			Rubber sleeve (for compressor)			
Safety equipments			20 (Crank case heater)			
Installation data			RC-E5 (Installed) / wireless : RCN-KIT3-E (option)			
Refrigerant piping size (O.D.)		mm	Thermostat by electronics			
Connecting method			—			
Attached length of piping		m	Overload protection for fan motor.			
Insulation for piping			Frost protection thermostat.			
Refrigerant line (one way) length		m	Internal thermostat for fan motor.			
Vertical height diff. between O.U. and I.U.		m	Abnormal discharge temperature protection.			
Drain hose			Liquid line: I/U φ 9.52 (3/8") Pipe φ 9.52(3/8")×0.8 O/U φ 9.52 (3/8")			
Drain pump, max lift height		mm	Gas line: φ 15.88 (5/8") φ 15.88(5/8")×1.0 φ 15.88 (5/8")			
Recommended breaker size		A	Flare piping			
L.R.A. (Locked rotor ampere)		A	Flare piping			
Interconnecting wires Size × Core number			Necessary (both Liquid & Gas lines)			
IP number			Max.50m			
Standard accessories			Max.30m (Outdoor unit is higher)			
Option parts			Max.15m (Outdoor unit is lower)			
Note (1) The data are measured at the following conditions.			Hose connectable with VP20			
			Holes size φ 20 × 3pcs			
			—			
			—			
			5.0			
			φ 1.6mm×3 cores (+ earth cable 1.6mm) / Terminal block (Screw fixing type)			
			IPX0			
			IP24			
			Mounting kit			
			Edging			
			—			
Note (1) The data are measured at the following conditions.			The pipe length is 7.5m.			
operation	Item	Indoor air temperature		Outdoor air temperature		Standards
		DB	WB	DB	WB	
	Cooling	27°C	19°C	35°C	24°C	
Heating	20°C	—	7°C	6°C		
<p>(2) This air-conditioner is manufactured and tested in conformity with the ISO.</p> <p>(3) Sound level indicates the value in an anechoic chamber. During operation these value are somewhat higher due to ambient conditions.</p> <p>(4) Select the breaker size according to the own national standard.</p> <p>(5) When wireless remote control is used, fan is 3 speed setting (Hi-Me-Lo) only.</p> <p>(6) The operation data indicate when the air-conditioner is operated at 400V50Hz or 380V60Hz.</p>						

Item		Model	FDF100VSVD2		
			Indoor unit FDF100VD2	Outdoor unit FDC100VS	
Power source			3 Phase 380-415V 50Hz / 380V 60Hz		
Operation data	Nominal cooling capacity (range)	kW	10.0 [4.0(Min.) ~ 11.2(Max.)]		
	Nominal heating capacity (range)	kW	11.2 [4.0(Min.) ~ 12.5(Max.)]		
	Power consumption	Cooling	kW	3.12	
		Heating		3.10	
	Max power consumption		4.37		
	Running current	Cooling	A	4.6 / 4.8	
		Heating		4.6 / 4.8	
	Inrush current, max current		5, 15		
	Power factor	Cooling	%	98 / 99	
		Heating		97 / 98	
	EER	Cooling		3.21	
COP	Heating		3.61		
Sound power level	Cooling	dB(A)	65		
	Heating		70		
Sound pressure level	Cooling	dB(A)	P-Hi : 54 Hi : 50 Me : 48 Lo : 44		
	Heating		49		
Silent mode sound pressure level			—		
Cooling : 46 / Heating : 46					
Exterior dimensions (Height × Width × Depth)		mm	1,850 × 600 × 320		
Exterior appearance (Munsell color)			Ceramic White (N8.0) near equivalent		
Net weight		kg	52		
Compressor type & Q'ty			—		
Compressor motor (Starting method)		kW	—		
Refrigerant oil (Amount, type)		ℓ	—		
Refrigerant (Type, amount, pre-charge length)		kg	R410A 3.8kg in outdoor unit (incl. the amount for the piping of : 30m)		
Heat exchanger			Louver fine & inner grooved tubing		
Refrigerant control			Electronic expansion valve		
Fan type & Q'ty			Centrifugal fan ×1		
Fan motor (Starting method)		W	157 < Direct line start >		
Air flow	Cooling	m³/min	P-Hi : 29 Hi : 26 Me : 23 Lo : 19		
	Heating		75		
Available external static pressure		Pa	0		
Outside air intake			Not possible		
Air filter, Quality / Quantity			Plastic net ×1 (Washable)		
Shock & vibration absorber			Rubber sleeve (for fan motor)		
Electric heater		W	—		
Operation control	Remote control		RC-E5 (Installed) / wireless : RCN-KIT3-E (option)		
	Room temperature control		Thermostat by electronics		
	Operation display		—		
Safety equipments			Overload protection for fan motor. Frost protection thermostat. Internal thermostat for fan motor. Abnormal discharge temperature protection.		
Installation data	Refrigerant piping size (O.D.)	mm	Liquid line: I/U φ 9.52 (3/8") Pipe φ 9.52(3/8")×0.8 O/U φ 9.52 (3/8")		
	Connecting method		Gas line: φ 15.88 (5/8") φ 15.88(5/8")×1.0 φ 15.88 (5/8")		
	Attached length of piping	m	Flare piping		
	Insulation for piping		Necessary (both Liquid & Gas lines)		
	Refrigerant line (one way) length	m	Max.50m		
	Vertical height diff. between O.U. and I.U.	m	Max.30m (Outdoor unit is higher) Max.15m (Outdoor unit is lower)		
Drain hose		Hose connectable with VP20			
Drain pump, max lift height		mm	—		
Recommended breaker size		A	—		
L.R.A. (Locked rotor ampere)		A	5.0		
Interconnecting wires Size × Core number			φ 1.6mm×3 cores (+ earth cable 1.6mm) / Terminal block (Screw fixing type)		
IP number			IPX0		
Standard accessories			Mounting kit		
Option parts			Edging		

Note (1) The data are measured at the following conditions. The pipe length is 7.5m.

operation	Indoor air temperature		Outdoor air temperature		Standards
	DB	WB	DB	WB	
Cooling	27°C	19°C	35°C	24°C	ISO5151-T1
Heating	20°C	—	7°C	6°C	

- (2) This air-conditioner is manufactured and tested in conformity with the ISO.
- (3) Sound level indicates the value in an anechoic chamber. During operation these value are somewhat higher due to ambient conditions.
- (4) Select the breaker size according to the own national standard.
- (5) When wireless remote control is used, fan is 3 speed setting (Hi-Me-Lo) only.
- (6) The operation data indicate when the air-conditioner is operated at 400V50Hz or 380V60Hz.

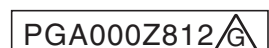

Item		Model	FDF125VNVD		
			Indoor unit FDF125VD	Outdoor unit FDC125VN	
Power source			1 Phase 220-240V 50Hz / 220V 60Hz		
Operation data	Nominal cooling capacity (range)	kW	12.5 [5.0(Min.) ~ 14.0(Max.)]		
	Nominal heating capacity (range)	kW	14.0 [4.0(Min.) ~ 16.0(Max.)]		
	Power consumption	Cooling	kW	4.40	
		Heating		4.36	
	Max power consumption		5.72		
	Running current	Cooling	A	19.5 / 20.4	
		Heating		19.3 / 20.2	
	Inrush current, max current		5, 24		
	Power factor	Cooling	%	98	
		Heating		98	
	EER	Cooling	2.84		
	COP	Heating	3.21		
Sound power level	Cooling	dB(A)	73		
	Heating		72		
Sound pressure level	Cooling	dB(A)	P-Hi : 54 Hi : 50 Me : 48 Lo : 44		
	Heating		50		
Silent mode sound pressure level			Cooling : 46 / Heating : 48		
Exterior dimensions (Height × Width × Depth)	mm	1,850 × 600 × 320		845×970×370	
Exterior appearance (Munsell color)		Ceramic White (N8.0) near equivalent		Stucco White (4.2Y7.5/1.1) near equivalent	
Net weight	kg	52		81	
Compressor type & Q'ty		—		RMT5126MDE2×1	
Compressor motor (Starting method)	kW	—		Direct line start	
Refrigerant oil (Amount, type)	ℓ	—		0.9 M-MA68	
Refrigerant (Type, amount, pre-charge length)	kg	R410A 3.8kg in outdoor unit (incl. the amount for the piping of : 30m)			
Heat exchanger		Louver fine & inner grooved tubing		Straight fin & inner grooved tubing	
Refrigerant control		Electronic expansion valve			
Fan type & Q'ty		Centrifugal fan ×1		Propeller fan ×1	
Fan motor (Starting method)	W	157 < Direct line start >		86 < Direct line start >	
Air flow	Cooling	m³/min	P-Hi : 29 Hi : 26 Me : 23 Lo : 19		
	Heating		75		
Available external static pressure	Pa	0		—	
Outside air intake		Not possible		—	
Air filter, Quality / Quantity		Plastic net ×1(Washable)		—	
Shock & vibration absorber		Rubber sleeve (for fan motor)		Rubber sleeve (for compressor)	
Electric heater	W	—		20 (Crank case heater)	
Operation control	Remote control	RC-E5 (Installed) / wireless : RCN-KIT3-E (option)			
	Room temperature control	Thermostat by electronics			
	Operation display	—			
Safety equipments		Overload protection for fan motor. Frost protection thermostat. Internal thermostat for fan motor. Abnormal discharge temperature protection.			
Installation data	Refrigerant piping size (O.D.)	mm	Liquid line: I/U φ 9.52 (3/8") Pipe φ 9.52(3/8")×0.8 O/U φ 9.52 (3/8") Gas line: φ 15.88 (5/8") φ 15.88(5/8")×1.0 φ 15.88 (5/8")		
	Connecting method		Flare piping		
	Attached length of piping	m	—		
	Insulation for piping		Necessary (both Liquid & Gas lines)		
	Refrigerant line (one way) length	m	Max.50m		
	Vertical height diff. between O.U. and I.U.	m	Max.30m (Outdoor unit is higher)		Max.15m (Outdoor unit is lower)
Drain hose		Hose connectable with VP20		Holes size φ 20 × 3pcs	
Drain pump, max lift height	mm	—		—	
Recommended breaker size	A	—			
L.R.A. (Locked rotor ampere)	A	5.0			
Interconnecting wires	Size × Core number	φ 1.6mm×3 cores (+ earth cable 1.6mm) / Terminal block (Screw fixing type)			
IP number		IPX0		IP24	
Standard accessories		Mounting kit		Edging	
Option parts		—			

Note (1) The data are measured at the following conditions. The pipe length is 7.5m.

operation	Indoor air temperature		Outdoor air temperature		Standards
	DB	WB	DB	WB	
Cooling	27°C	19°C	35°C	24°C	ISO5151-T1
Heating	20°C	—	7°C	6°C	

- (2) This air-conditioner is manufactured and tested in conformity with the ISO.
- (3) Sound level indicates the value in an anechoic chamber. During operation these value are somewhat higher due to ambient conditions.
- (4) Select the breaker size according to the own national standard.
- (5) When wireless remote control is used, fan is 3 speed setting (Hi-Me-Lo) only.
- (6) The operation data indicate when the air-conditioner is operated at 230V50Hz or 220V60Hz.

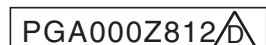

Item		Model	FDF125VSVD		
			Indoor unit FDF125VD	Outdoor unit FDC125VS	
Power source			3 Phase 380-415V 50Hz / 380V 60Hz		
Operation data	Nominal cooling capacity (range)	kW	12.5 [5.0(Min.) ~ 14.0(Max.)]		
	Nominal heating capacity (range)	kW	14.0 [4.0(Min.) ~ 16.0(Max.)]		
	Power consumption	Cooling	kW	4.40	
		Heating		4.36	
	Max power consumption		5.72		
	Running current	Cooling	A	6.5 / 6.8	
		Heating		6.5 / 6.8	
	Inrush current, max current		5, 15		
	Power factor	Cooling	%	98	
		Heating		97	
	EER	Cooling		2.84	
	COP	Heating		3.21	
Sound power level	Cooling	dB(A)	73		
	Heating		72		
Sound pressure level	Cooling	dB(A)	P-Hi : 54 Hi : 50 Me : 48 Lo : 44		
	Heating		50		
Silent mode sound pressure level			51		
			Cooling : 46 / Heating : 48		
Exterior dimensions (Height × Width × Depth)		mm	1,850 × 600 × 320		
Exterior appearance (Munsell color)			Ceramic White (N8.0) near equivalent		
Net weight		kg	52		
Compressor type & Q'ty			—		
Compressor motor (Starting method)		kW	—		
Refrigerant oil (Amount, type)		ℓ	—		
Refrigerant (Type, amount, pre-charge length)		kg	R410A 3.8kg in outdoor unit (incl. the amount for the piping of : 30m)		
Heat exchanger			Louver fine & inner grooved tubing		
Refrigerant control			Electronic expansion valve		
Fan type & Q'ty			Centrifugal fan ×1		
Fan motor (Starting method)		W	157 < Direct line start >		
Air flow	Cooling	m³/min	P-Hi : 29 Hi : 26 Me : 23 Lo : 19		
	Heating		75		
Available external static pressure		Pa	0		
Outside air intake			Not possible		
Air filter, Quality / Quantity			Plastic net ×1(Washable)		
Shock & vibration absorber			Rubber sleeve (for fan motor)		
Electric heater		W	—		
Operation control	Remote control		RC-E5 (Installed) / wireless : RCN-KIT3-E (option)		
	Room temperature control		Thermostat by electronics		
	Operation display		—		
Safety equipments			Overload protection for fan motor. Frost protection thermostat. Internal thermostat for fan motor. Abnormal discharge temperature protection.		
Installation data	Refrigerant piping size (O.D.)	mm	Liquid line: I/U φ 9.52 (3/8") Pipe φ 9.52(3/8")×0.8 O/U φ 9.52 (3/8")		
	Connecting method		Gas line: φ 15.88 (5/8") φ 15.88(5/8")×1.0 φ 15.88 (5/8")		
	Attached length of piping	m	Flare piping		
	Insulation for piping		Necessary (both Liquid & Gas lines)		
	Refrigerant line (one way) length	m	Max.50m		
	Vertical height diff. between O.U. and I.U.	m	Max.30m (Outdoor unit is higher) Max.15m (Outdoor unit is lower)		
Drain hose		Hose connectable with VP20			
Drain pump, max lift height	mm	—			
Recommended breaker size	A	—			
L.R.A. (Locked rotor ampere)	A	5.0			
Interconnecting wires	Size × Core number	φ 1.6mm×3 cores (+ earth cable 1.6mm) / Terminal block (Screw fixing type)			
IP number		IPX0			
Standard accessories		Mounting kit			
Option parts		Edging			

Note (1) The data are measured at the following conditions. The pipe length is 7.5m.

operation	Indoor air temperature		Outdoor air temperature		Standards
	DB	WB	DB	WB	
Cooling	27°C	19°C	35°C	24°C	ISO5151-T1
Heating	20°C	—	7°C	6°C	

- (2) This air-conditioner is manufactured and tested in conformity with the ISO.
- (3) Sound level indicates the value in an anechoic chamber. During operation these value are somewhat higher due to ambient conditions.
- (4) Select the breaker size according to the own national standard.
- (5) When wireless remote controll is used, fan is 3 speed setting (Hi-Me-Lo) only.
- (6) The operation data indicate when the air-conditioner is operated at 400V50Hz or 380V60Hz.

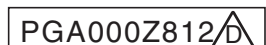

Item		Model	FDF140VNVD		
			Indoor unit FDF140VD	Outdoor unit FDC140VN	
Power source			1 Phase 220-240V 50Hz / 220V 60Hz		
Operation data	Nominal cooling capacity (range)	kW	14.0 [5.0(Min.)~ 14.5(Max.)]		
	Nominal heating capacity (range)	kW	16.0 [4.0(Min.)~ 16.5(Max.)]		
	Power consumption	Cooling	kW	5.15	
		Heating		5.31	
	Max power consumption		6.90		
	Running current	Cooling	A	22.8 / 23.9	
		Heating		23.6 / 24.6	
	Inrush current, max current		5, 24		
	Power factor	Cooling	%	98	
		Heating		98	
	EER	Cooling		2.72	
	COP	Heating		3.01	
Sound power level	Cooling	dB(A)	73		
	Heating		73		
Sound pressure level	Cooling	dB(A)	P-Hi : 54 Hi : 50 Me : 48 Lo : 44		
	Heating		51		
Silent mode sound pressure level			Cooling : 47 / Heating : 50		
Exterior dimensions (Height × Width × Depth)		mm	1,850 × 600 × 320		
Exterior appearance (Munsell color)			Ceramic White (N8.0) near equivalent		
Net weight		kg	52		
Compressor type & Q'ty			—		
Compressor motor (Starting method)		kW	—		
Refrigerant oil (Amount, type)		ℓ	—		
Refrigerant (Type, amount, pre-charge length)		kg	R410A 3.8kg in outdoor unit (incl. the amount for the piping of : 30m)		
Heat exchanger			Louver fin & inner grooved tubing		
Refrigerant control			Straight fin & inner grooved tubing		
Fan type & Q'ty			Electronic expansion valve		
Fan motor (Starting method)		W	Centrifugal fan ×1		
Air flow		m ³ /min	Propeller fan ×1		
Available external static pressure		Pa	157 < Direct line start >		
Outside air intake			86 < Direct line start >		
Air filter, Quality / Quantity			75		
Shock & vibration absorber			73		
Electric heater		W	0		
Remote control			Not Possible		
Room temperature control			Plastic net ×1 (Washable)		
Operation display			—		
Safety equipments			Rubber sleeve (for fan motor)		
Refrigerant piping size (O.D.)		mm	Rubber sleeve (for compressor)		
Connecting method			20 (Crank case heater)		
Attached length of piping		m	RC-E5 (Installed) / wireless : RCN-KIT3-E (option)		
Insulation for piping			Thermostat by electronics		
Refrigerant line (one way) length		m	—		
Vertical height diff. between O.U. and I.U.		m	Overload protection for fan motor. Frost protection thermostat. Internal thermostat for fan motor. Abnormal discharge temperature protection.		
Drain hose			Liquid line: I/U φ 9.52 (3/8") Pipe φ 9.52(3/8")×0.8 O/U φ 9.52 (3/8") Gas line: φ 15.88 (5/8") φ 15.88 (5/8")×1.0 φ 15.88 (5/8")		
Drain pump, max lift height		mm	Flare piping		
Recommended breaker size		A	Flare piping		
L.R.A. (Locked rotor ampere)		A	—		
Interconnecting wires Size × Core number			Necessary (both Liquid & Gas lines) Max.50m		
IP number			Max.30m (Outdoor unit is higher) Max.15m (Outdoor unit is lower)		
Standard accessories			Hose connectable with VP20 Holes size φ 20 × 3pcs		
Option parts			—		

Note (1) The data are measured at the following conditions.

The pipe length is 7.5m.

Operation	Indoor air temperature		Outdoor air temperature		Standards
	DB	WB	DB	WB	
Cooling	27°C	19°C	35°C	24°C	ISO5151-T1
Heating	20°C	—	7°C	6°C	

- (2) This air-conditioner is manufactured and tested in conformity with the ISO.
- (3) Sound level indicates the value in an anechoic chamber. During operation these value are somewhat higher due to ambient conditions.
- (4) Select the breaker size according to the own national standard.
- (5) When wireless remote control is used, fan is 3 speed setting (Hi-Me-Lo) only.
- (6) The operation data indicate when the air-conditioner is operated at 230V50Hz or 220V60Hz.

Item		Model	FDF140VSVD																						
			Indoor unit FDF140VD	Outdoor unit FDC140VS																					
Power source			3 Phase 380-415V 50Hz / 380V 60Hz																						
Operation data	Nominal cooling capacity (range)	kW	14.0 [5.0(Min.) ~ 14.5(Max.)]																						
	Nominal heating capacity (range)	kW	16.0 [4.0(Min.) ~ 16.5(Max.)]																						
	Power consumption	Cooling	kW	5.15																					
		Heating		5.31																					
	Max power consumption		6.90																						
	Running current	Cooling	A	7.6 / 8.0																					
		Heating		7.9 / 8.2																					
	Inrush current, max current		5, 15																						
	Power factor	Cooling	%	98																					
		Heating		97 / 98																					
	EER	Cooling		2.72																					
	COP	Heating		3.01																					
Sound power level	Cooling	dB(A)	73																						
	Heating		73																						
Sound pressure level	Cooling	dB(A)	P-Hi : 54 Hi : 50 Me : 48 Lo : 44																						
	Heating		51																						
Silent mode sound pressure level			Cooling : 47 / Heating : 50																						
Exterior dimensions (Height × Width × Depth)		mm	1,850 × 600 × 320																						
Exterior appearance (Munsell color)			Ceramic White (N8.0) near equivalent																						
Net weight		kg	52																						
Compressor type & Q'ty			—																						
Compressor motor (Starting method)		kW	—																						
Refrigerant oil (Amount, type)		ℓ	—																						
Refrigerant (Type, amount, pre-charge length)		kg	R410A 3.8kg in outdoor unit (incl. the amount for the piping of : 30m)																						
Heat exchanger			Louver fin & inner grooved tubing																						
Refrigerant control			Electronic expansion valve																						
Fan type & Q'ty			Centrifugal fan ×1																						
Fan motor (Starting method)		W	157 < Direct line start >																						
Air flow	Cooling	m³/min	P-Hi : 29 Hi : 26 Me : 23 Lo : 19																						
	Heating		75																						
Available external static pressure		Pa	0																						
Outside air intake			Not Possible																						
Air filter, Quality / Quantity			Plastic net ×1 (Washable)																						
Shock & vibration absorber			Rubber sleeve (for fan motor)																						
Electric heater		W	—																						
Operation control	Remote control		RC-E5 (Installed) / wireless : RCN-KIT3-E (option)																						
	Room temperature control		Thermostat by electronics																						
	Operation display		—																						
Safety equipments			Overload protection for fan motor. Frost protection thermostat. Internal thermostat for fan motor. Abnormal discharge temperature protection.																						
Installation data	Refrigerant piping size (O.D.)	mm	Liquid line: I/U φ 9.52 (3/8") Pipe φ 9.52(3/8")×0.8 O/U φ 9.52 (3/8") Gas line: φ 15.88 (5/8") φ 15.88 (5/8")×1.0 φ 15.88 (5/8")																						
	Connecting method		Flare piping																						
	Attached length of piping	m	—																						
	Insulation for piping		Necessary (both Liquid & Gas lines)																						
	Refrigerant line (one way) length	m	Max.50m																						
	Vertical height diff. between O.U. and I.U.	m	Max.30m (Outdoor unit is higher) Max.15m (Outdoor unit is lower)																						
Drain hose			Hose connectable with VP20																						
Drain pump, max lift height		mm	—																						
Recommended breaker size		A	—																						
L.R.A. (Locked rotor ampere)		A	5.0																						
Interconnecting wires Size × Core number			φ 1.6mm×3 cores (+ earth cable 1.6mm) / Terminal block (Screw fixing type)																						
IP number			IPX0																						
Standard accessories			Mounting kit																						
Option parts			—																						
Note (1) The data are measured at the following conditions.			The pipe length is 7.5m.																						
<table border="1"> <thead> <tr> <th rowspan="2">Item</th> <th colspan="2">Indoor air temperature</th> <th colspan="2">Outdoor air temperature</th> <th rowspan="2">Standards</th> </tr> <tr> <th>DB</th> <th>WB</th> <th>DB</th> <th>WB</th> </tr> </thead> <tbody> <tr> <td>Cooling</td> <td>27°C</td> <td>19°C</td> <td>35°C</td> <td>24°C</td> <td rowspan="2">ISO5151-T1</td> </tr> <tr> <td>Heating</td> <td>20°C</td> <td>—</td> <td>7°C</td> <td>6°C</td> </tr> </tbody> </table>		Item	Indoor air temperature		Outdoor air temperature		Standards	DB	WB	DB	WB	Cooling	27°C	19°C	35°C	24°C	ISO5151-T1	Heating	20°C	—	7°C	6°C			
Item	Indoor air temperature		Outdoor air temperature		Standards																				
	DB	WB	DB	WB																					
Cooling	27°C	19°C	35°C	24°C	ISO5151-T1																				
Heating	20°C	—	7°C	6°C																					
(2) This air-conditioner is manufactured and tested in conformity with the ISO.																									
(3) Sound level indicates the value in an anechoic chamber. During operation these value are somewhat higher due to ambient conditions.																									
(4) Select the breaker size according to the own national standard.																									
(5) When wireless remote control is used, fan is 3 speed setting (Hi-Me-Lo) only.																									
(6) The operation data indicate when the air-conditioner is operated at 400V50Hz or 380V60Hz.																									

(b) Twin type

Item		Model	FDF140VNPVD1																						
			Indoor unit FDF71VD1 (2 units)	Outdoor unit FDC140VN																					
Power source			1 Phase 220-240V 50Hz / 220V 60Hz																						
Operation data	Nominal cooling capacity (range)	kW	14.0 [5.0(Min.)~ 14.5(Max.)]																						
	Nominal heating capacity (range)	kW	16.0 [4.0(Min.)~ 16.5(Max.)]																						
	Power consumption	Cooling	kW	5.16																					
		Heating		5.01																					
	Max power consumption		6.71																						
	Running current	Cooling	A	22.9 / 23.9																					
		Heating		22.2 / 23.2																					
	Inrush current, max current		5, 24																						
	Power factor	Cooling	%	98																					
		Heating		98																					
	EER	Cooling		2.71																					
	COP	Heating		3.19																					
	Sound power level	Cooling	dB(A)	61																					
Heating		73																							
Sound pressure level	Cooling	dB(A)	P-Hi : 42 Hi : 39 Me : 35 Lo : 33																						
	Heating		51																						
Silent mode sound pressure level			Cooling : 47 / Heating : 50																						
Exterior dimensions (Height × Width × Depth)		mm	1,850 × 600 × 320																						
Exterior appearance (Munsell color)			Ceramic White (N8.0) near equivalent																						
Net weight		kg	49																						
Compressor type & Q'ty			RMT5126MDE2×1																						
Compressor motor (Starting method)		kW	Direct line start																						
Refrigerant oil (Amount, type)		ℓ	0.9 M-MA68																						
Refrigerant (Type, amount, pre-charge length)		kg	R410A 3.8kg (Pre-charged up to the piping length of 30m) Outdoor unit																						
Heat exchanger			Louver fin & inner grooved tubing																						
Refrigerant control			Electronic expansion valve																						
Fan type & Q'ty			Centrifugal fan ×1																						
Fan motor (Starting method)		W	157 < Direct line start >																						
Air flow	Cooling	m³/min	75																						
	Heating		73																						
Available external static pressure		Pa	0																						
Outside air intake			Not Possible																						
Air filter, Quality / Quantity			Plastic net ×1(Washable)																						
Shock & vibration absorber			Rubber sleeve (for fan motor)																						
Electric heater		W	20 (Crank case heater)																						
Operation control	Remote control		RC-E5 (Installed) / wireless : RCN-KIT3-E (option)																						
	Room temperature control		Thermostat by electronics																						
	Operation display		-																						
Safety equipments			Overload protection for fan motor. Frost protection thermostat. Internal thermostat for fan motor. Abnormal discharge temperature protection.																						
Installation data	Refrigerant piping size (O.D.)	mm	Liquid line: I/U φ 9.52 (3/8") ② φ 9.52(3/8")×0.8 ① φ 9.52 (3/8")×0.8 O/U φ 9.52 (3/8") Gas line: I/U φ 15.88 (5/8") ② φ 15.88(5/8")×1.0 ① φ 15.88 (5/8")×1.0 O/U φ 15.88 (5/8")																						
	Connecting method		Flare piping																						
	Attached length of piping	m	-																						
	Insulation for piping		Necessary (both Liquid & Gas lines)																						
	Refrigerant line (one way) length	m	Max.50m																						
	Vertical height diff. between O.U. and I.U.	m	Max.30m (Outdoor unit is higher) Max.15m (Outdoor unit is lower)																						
Drain hose		Hose connectable with VP20 Holes size φ 20 × 3pcs																							
Drain pump, max lift height		mm	-																						
Recommended breaker size		A	-																						
L.R.A. (Locked rotor ampere)		A	5.0																						
Interconnecting wires Size × Core number			φ 1.6mm×3 cores (+ earth cable 1.6mm) / Terminal block (Screw fixing type)																						
IP number			IPX0																						
Standard accessories			Mounting kit																						
Option parts			-																						
Note (1) The data are measured at the following conditions. The pipe length is 7.5m.																									
<table border="1"> <thead> <tr> <th rowspan="2">Item</th> <th colspan="2">Indoor air temperature</th> <th colspan="2">Outdoor air temperature</th> <th rowspan="2">Standards</th> </tr> <tr> <th>DB</th> <th>WB</th> <th>DB</th> <th>WB</th> </tr> </thead> <tbody> <tr> <td>Cooling</td> <td>27°C</td> <td>19°C</td> <td>35°C</td> <td>24°C</td> <td rowspan="2">ISO5151-T1</td> </tr> <tr> <td>Heating</td> <td>20°C</td> <td>-</td> <td>7°C</td> <td>6°C</td> </tr> </tbody> </table>					Item	Indoor air temperature		Outdoor air temperature		Standards	DB	WB	DB	WB	Cooling	27°C	19°C	35°C	24°C	ISO5151-T1	Heating	20°C	-	7°C	6°C
Item	Indoor air temperature		Outdoor air temperature			Standards																			
	DB	WB	DB	WB																					
Cooling	27°C	19°C	35°C	24°C	ISO5151-T1																				
Heating	20°C	-	7°C	6°C																					
(2) This air-conditioner is manufactured and tested in conformity with the ISO.																									
(3) Sound level indicates the value in an anechoic chamber. During operation these value are somewhat higher due to ambient conditions.																									
(4) Select the breaker size according to the own national standard.																									
(5) When wireless remote control is used, fan is 3 speed setting (Hi-Me-Lo) only.																									
(6) The operation data indicate when the air-conditioner is operated at 230V50Hz or 220V60Hz.																									
(7) Indoor unit specifications for one unit. Capacity and operation data are two indoor units are combined and run together.																									
(8) Branching pipe set "DIS-WA1"×1(option). ① : Pipe of O/U ~ Branch, ② : Pipe of Branch ~ I/U																									

Item		Model	FDF140VSPVD1		
			Indoor unit FDF71VD1 (2 units)	Outdoor unit FDC140VS	
Power source			3 Phase 380-415V 50Hz / 380V 60Hz		
Operation data	Nominal cooling capacity (range)	kW	14.0 [5.0(Min.) ~ 14.5(Max.)]		
	Nominal heating capacity (range)	kW	16.0 [4.0(Min.) ~ 16.5(Max.)]		
	Power consumption	Cooling	kW	5.16	
		Heating		5.01	
	Max power consumption		6.71		
	Running current	Cooling	A	7.6 / 8.0	
		Heating		7.4 / 7.8	
	Inrush current, max current		5, 15		
	Power factor	Cooling	%	98	
		Heating		98	
	EER	Cooling		2.71	
	COP	Heating		3.19	
Sound power level	Cooling	dB(A)	61		
	Heating		73		
Sound pressure level	Cooling	dB(A)	P-Hi : 42 Hi : 39 Me : 35 Lo : 33		
	Heating		51		
Silent mode sound pressure level			Cooling : 47 / Heating : 50		
Exterior dimensions (Height × Width × Depth)	mm	1,850 × 600 × 320		845×970×370	
Exterior appearance (Munsell color)		Ceramic White (N8.0) near equivalent		Stucco White (4.2Y7.5/1.1) near equivalent	
Net weight	kg	49		83	
Compressor type & Q'ty		—		RMT5126MDE3×1	
Compressor motor (Starting method)	kW	—		Direct line start	
Refrigerant oil (Amount, type)	ℓ	—		0.9 M-MA68	
Refrigerant (Type, amount, pre-charge length)	kg	R410A 3.8kg (Pre-charged up to the piping length of 30m) Outdoor unit			
Heat exchanger		Louver fin & inner grooved tubing		Straight fin & inner grooved tubing	
Refrigerant control		Electronic expansion valve			
Fan type & Q'ty		Centrifugal fan ×1		Propeller fan ×1	
Fan motor (Starting method)	W	157 < Direct line start >		86 < Direct line start >	
Air flow	Cooling	m³/min	P-Hi : 18 Hi : 16 Me : 14 Lo : 12		
	Heating		75		
Available external static pressure	Pa	0		—	
Outside air intake		Not possible		—	
Air filter, Quality / Quantity		Plastic net ×1 (Washable)		—	
Shock & vibration absorber		Rubber sleeve (for fan motor)		Rubber sleeve (for compressor)	
Electric heater	W	—		20 (Crank case heater)	
Operation control	Remote control	RC-E5 (Installed) / wireless : RCN-KIT3-E (option)			
	Room temperature control	Thermostat by electronics			
	Operation display	—			
Safety equipments		Overload protection for fan motor. Frost protection thermostat. Internal thermostat for fan motor. Abnormal discharge temperature protection.			
Installation data	Refrigerant piping size (O.D.)	mm	Liquid line: I/U φ 9.52 (3/8") ② φ 9.52(3/8")×0.8 ① φ 9.52 (3/8")×0.8 O/U φ 9.52 (3/8") Gas line: I/U φ 15.88 (5/8") ② φ 15.88(5/8")×1.0 ① φ 15.88 (5/8")×1.0 O/U φ 15.88 (5/8")		
	Connecting method		Flare piping		
	Attached length of piping	m	—		
	Insulation for piping		Necessary (both Liquid & Gas lines)		
	Refrigerant line (one way) length	m	Max.50m		
	Vertical height diff. between O.U. and I.U.	m	Max.30m (Outdoor unit is higher)		Max.15m (Outdoor unit is lower)
Drain hose		Hose connectable with VP20		Holes size φ 20 × 3pcs	
Drain pump, max lift height	mm	—		—	
Recommended breaker size	A	—			
L.R.A. (Locked rotor ampere)	A	5.0			
Interconnecting wires Size × Core number		φ 1.6mm×3 cores (+ earth cable 1.6mm) / Terminal block (Screw fixing type)			
IP number		IPX0		IP24	
Standard accessories		Mounting kit		Edging	
Option parts		—			
Note (1) The data are measured at the following conditions.		The pipe length is 7.5m.			
	Item	Indoor air temperature	Outdoor air temperature		Standards
Operation		DB	DB	WB	
	Cooling	27°C	35°C	24°C	
	Heating	20°C	7°C	6°C	
					ISO5151-T1
(2) This air-conditioner is manufactured and tested in conformity with the ISO.					
(3) Sound level indicates the value in an anechoic chamber. During operation these value are somewhat higher due to ambient conditions.					
(4) Select the breaker size according to the own national standard.					
(5) When wireless remote control is used, fan is 3 speed setting (Hi-Me-Lo) only.					
(6) The operation data indicate when the air-conditioner is operated at 400V50Hz or 380V60Hz.					
(7) Indoor unit specifications for one unit. Capacity and operation data are two indoor units are combined and run together.					
(8) Branching pipe set "DIS-WA1"×1(option). ① : Pipe of O/U ~ Branch, ② : Pipe of Branch ~ I/U					

Item		Model	FDF200VSPVD1		
			Indoor unit FDF100VD1 (2 units)	Outdoor unit FDC200VS	
Power source			3 Phase 380-415V 50Hz / 380V 60Hz		
Operation data	Nominal cooling capacity (range)	kW	20.0 [7.0(Min.) ~ 22.4(Max.)]		
	Nominal heating capacity (range)	kW	22.4 [7.6(Min.) ~ 25.0(Max.)]		
	Power consumption	Cooling	kW	6.50	
		Heating		6.42	
	Max power consumption		8.26		
	Running current	Cooling	A	9.6 / 10.1	
		Heating		9.5 / 10.0	
	Inrush current, max current		5, 19		
	Power factor	Cooling	%	98	
		Heating		98	
	EER	Cooling		3.08	
	COP	Heating		3.49	
Sound power level	Cooling	dB(A)	65		
	Heating		74		
Sound pressure level	Cooling	dB(A)	P-Hi : 54 Hi : 50 Me : 48 Lo : 44		
	Heating		57		
Silent mode sound pressure level			Cooling : 56 / Heating : 56		
Exterior dimensions (Height × Width × Depth)		mm	1,850 × 600 × 320		
Exterior appearance (Munsell color)			Ceramic White (N8.0) near equivalent		
Net weight		kg	52		
Compressor type & Q'ty			GTC5150ND70K×1		
Compressor motor (Starting method)		kW	Direct line start		
Refrigerant oil (Amount, type)		ℓ	1.45 M-MA32R		
Refrigerant (Type, amount, pre-charge length)		kg	R410A 5.4kg (Pre-charged up to the piping length of 30m) Outdoor unit		
Heat exchanger			Louver fin & inner grooved tubing		
Refrigerant control			Straight fin & inner grooved tubing		
Fan type & Q'ty			Electronic expansion valve		
Fan motor (Starting method)		W	Centrifugal fan ×1		
Air flow		m³/min	Propeller fan ×2		
Available external static pressure		Pa	157 < Direct line start >		
Outside air intake			86×2 < Direct line start >		
Air filter, Quality / Quantity			150		
Shock & vibration absorber			145		
Electric heater		W	0		
Remote control			Not Possible		
Room temperature control			Plastic net ×1 (Washable)		
Operation display			Rubber sleeve (for fan motor)		
Safety equipments			Rubber sleeve (for compressor)		
Refrigerant piping size (O.D.)		mm	33 (Crank case heater)		
Connecting method			RC-E5 (Installed) / wireless : RCN-KIT3-E (option)		
Attached length of piping		m	Thermostat by electronics		
Insulation for piping			—		
Refrigerant line (one way) length		m	Overload protection for fan motor.		
Vertical height diff. between O.U. and I.U.		m	Frost protection thermostat.		
Drain hose			Internal thermostat for fan motor.		
Drain pump, max lift height		mm	Abnormal discharge temperature protection.		
Recommended breaker size		A	Liquid line: I/U φ 9.52 (3/8") ② φ 9.52(3/8")×0.8 ① φ 9.52 (3/8")×0.8 O/U φ 9.52 (3/8")		
L.R.A. (Locked rotor ampere)		A	Gas line: I/U φ 15.88 (5/8") ② φ 15.88(5/8")×1.0 ① φ 22.22 (7/8")×1.6 O/U φ 22.22 (7/8")		
Interconnecting wires Size × Core number			Flare piping		
IP number			Liquid : Flare / Gas : Brazing		
Standard accessories			Necessary (both Liquid & Gas lines)		
Option parts			Max.70m		
Note (1) The data are measured at the following conditions.			Max.30m (Outdoor unit is higher)		
			Max.15m (Outdoor unit is lower)		
			Hose connectable with VP20		
			Holes size φ 20 × 3pcs		
			—		
			5.0		
			φ 1.6mm×3 cores (+ earth cable 1.6mm) / Terminal block (Screw fixing type)		
			IPX0		
			IP24		
			Mounting kit		
			Connecting pipe, Edging		
			—		

Note (1) The data are measured at the following conditions.

The pipe length is 7.5m.

Operation	Indoor air temperature		Outdoor air temperature		Standards
	DB	WB	DB	WB	
Cooling	27°C	19°C	35°C	24°C	ISO5151-T1
Heating	20°C	—	7°C	6°C	

(2) This air-conditioner is manufactured and tested in conformity with the ISO.

(3) Sound level indicates the value in an anechoic chamber. During operation these value are somewhat higher due to ambient conditions.

(4) Select the breaker size according to the own national standard.

(5) When wireless remote control is used, fan is 3 speed setting (Hi-Me-Lo) only.

(6) The operation data indicate when the air-conditioner is operated at 400V50Hz or 380V60Hz.

(7) Indoor unit specifications for one unit. Capacity and operation data are two indoor units are combined and run together.

(8) Branching pipe set "DIS-WB1"×1(option). ① : Pipe of O/U ~ Branch, ② : Pipe of Branch ~ I/U

Item		Model	FDF250VSPVD		
			Indoor unit FDF125VD (2 units)	Outdoor unit FDC250VS	
Power source			3 Phase 380-415V 50Hz / 380V 60Hz		
Operation data	Nominal cooling capacity (range)	kW	25.0 [10.0(Min.) ~ 28.0(Max.)]		
	Nominal heating capacity (range)	kW	28.0 [9.5(Min.) ~ 31.5(Max.)]		
	Power consumption	Cooling	kW	8.95	
		Heating		9.17	
	Max power consumption		11.00		
	Running current	Cooling	A	13.2 / 13.9	
		Heating		13.5 / 14.2	
	Inrush current, max current		5, 22		
	Power factor	Cooling	%	98	
		Heating		98	
	EER	Cooling		2.79	
	COP	Heating		3.05	
Sound power level	Cooling	dB(A)	73		
	Heating		74		
Sound pressure level	Cooling	dB(A)	P-Hi : 54 Hi : 50 Me : 48 Lo : 44		
	Heating		57		
Silent mode sound pressure level			Cooling : 56 / Heating : 57		
Exterior dimensions (Height × Width × Depth)	mm	1,850 × 600 × 320		1,505 × 970 × 370	
Exterior appearance (Munsell color)		Ceramic White (N8.0) near equivalent		Stucco White (4.2Y7.5/1.1) near equivalent	
Net weight	kg	52		140	
Compressor type & Q'ty		—		GTC5150ND70K×1	
Compressor motor (Starting method)	kW	—		Direct line start	
Refrigerant oil (Amount, type)	ℓ	—		1.45 M-MA32R	
Refrigerant (Type, amount, pre-charge length)	kg	R410A 7.2kg (Pre-charged up to the piping length of 30m) Outdoor unit			
Heat exchanger		Louver fin & inner grooved tubing		Straight fin & inner grooved tubing	
Refrigerant control		Electronic expansion valve			
Fan type & Q'ty		Centrifugal fan ×1		Propeller fan ×2	
Fan motor (Starting method)	W	157 < Direct line start >		86×2 < Direct line start >	
Air flow	Cooling	m³/min	P-Hi : 29 Hi : 26 Me : 23 Lo : 19		
	Heating		150		
Available external static pressure	Pa	0		—	
Outside air intake		Not possible		—	
Air filter, Quality / Quantity		Plastic net ×1 (Washable)		—	
Shock & vibration absorber		Rubber sleeve (for fan motor)		Rubber sleeve (for compressor)	
Electric heater	W	—		33 (Crank case heater)	
Operation control	Remote control	RC-E5 (Installed) / wireless : RCN-KIT3-E (option)			
	Room temperature control	Thermostat by electronics			
	Operation display	—			
Safety equipments		Overload protection for fan motor. Frost protection thermostat. Internal thermostat for fan motor. Abnormal discharge temperature protection.			
Installation data	Refrigerant piping size (O.D.)	mm	Liquid line: I/U φ 9.52 (3/8") ② φ 9.52(3/8")×0.8 ① φ 12.7 (1/2")×0.8 O/U φ 12.7 (1/2") Gas line: I/U φ 15.88 (5/8") ② φ 15.88(5/8")×1.0 ① φ 22.22 (7/8")×1.6 O/U φ 22.22 (7/8")		
	Connecting method		Flare piping Liquid : Flare / Gas : Brazing		
	Attached length of piping	m	—		
	Insulation for piping		Necessary (both Liquid & Gas lines)		
	Refrigerant line (one way) length	m	Max.70m		
	Vertical height diff. between O.U. and I.U.	m	Max.30m (Outdoor unit is higher) Max.15m (Outdoor unit is lower)		
Drain hose		Hose connectable with VP20		Holes size φ 20 × 3pcs	
Drain pump, max lift height	mm	—		—	
Recommended breaker size	A	—			
L.R.A. (Locked rotor ampere)	A	5.0			
Interconnecting wires Size × Core number		φ 1.6mm×3 cores (+ earth cable 1.6mm) / Terminal block (Screw fixing type)			
IP number		IPX0		IP24	
Standard accessories		Mounting kit		Connecting pipe, Edging	
Option parts		—			

Note (1) The data are measured at the following conditions. The pipe length is 7.5m.

Item	Indoor air temperature		Outdoor air temperature		Standards
	DB	WB	DB	WB	
Cooling	27°C	19°C	35°C	24°C	ISO5151-T1
Heating	20°C	—	7°C	6°C	

- (2) This air-conditioner is manufactured and tested in conformity with the ISO.
- (3) Sound level indicates the value in an anechoic chamber. During operation these value are somewhat higher due to ambient conditions.
- (4) Select the breaker size according to the own national standard.
- (5) When wireless remote control is used, fan is 3 speed setting (Hi-Me-Lo) only.
- (6) The operation data indicate when the air-conditioner is operated at 400V50Hz or 380V60Hz.
- (7) Indoor unit specifications for one unit. Capacity and operation data are two indoor units are combined and run together.
- (8) Branching pipe set "DIS-WB1"×1(option). ① : Pipe of O/U ~ Branch, ② : Pipe of Branch ~ I/U

(7) Wall mounted type (SRK)
(a) Twin type

Item		Model		SRK100VNPZMX		
				Indoor unit SRK50ZMX-S (2 units)	Outdoor unit FDC100VN	
Power source				1 Phase 220-240V 50Hz / 220V 60Hz		
Operation data	Nominal cooling capacity (range)	kW	10.0 [4.0(Min.)~ 11.2(Max.)]			
	Nominal heating capacity (range)	kW	11.2 [4.0(Min.)~ 12.5(Max.)]			
	Power consumption	Cooling	kW	2.72		
		Heating		2.86		
	Max power consumption		4.00			
	Running current	Cooling	A	11.9 / 12.5		
		Heating		12.6 / 13.1		
	Inrush current, max current		5, 24			
	Power factor	Cooling	%	99		
		Heating		99		
	EER	Cooling		3.68		
	COP	Heating		3.92		
	Sound power level	Cooling	dB(A)	60		70
Heating		64				
Sound pressure level	Cooling	dB(A)	Hi : 47 Me : 40 Lo : 27 ULo : 25		49	
	Heating		Hi : 48 Me : 40 Lo : 33 ULo : 26			
Silent mode sound pressure level			-		Cooling : 46 / Heating : 46	
Exterior dimensions (Height × Width × Depth)	mm	309 × 890 × 220		845×970×370		
Exterior appearance (Munsell color)		Fine snow (8.0Y 9.3 / 0.1) near equivalent		Stucco White (4.2Y7.5/1.1) near equivalent		
Net weight	kg	15		81		
Compressor type & Q'ty		-		RMT5126MDE2×1		
Compressor motor (Starting method)	kW	-		Direct line start		
Refrigerant oil (Amount, type)	ℓ	-		0.9 M-MA68		
Refrigerant (Type, amount, pre-charge length)	kg	R410A 3.8kg (Pre-charged up to the piping length of 30m) Outdoor unit				
Heat exchanger		Louver fin & inner grooved tubing		Straight fin & inner grooved tubing		
Refrigerant control		Electronic expansion valve				
Fan type & Q'ty		Tangential fan ×1		Propeller fan ×1		
Fan motor (Starting method)	W	27 < Direct line start >		86 < Direct line start >		
Air flow	Cooling	m³/min	Hi : 13.5 Me : 11 Lo : 8 ULo : 7.0		75	
	Heating		Hi : 17 Me : 14.5 Lo : 10.5 ULo : 8.0		73	
Available external static pressure	Pa	0				
Outside air intake		Not Possible				
Air filter, Quality / Quantity		Polypropylene net (washable) ×2				
Shock & vibration absorber		Rubber sleeve (for fan motor)		Rubber sleeve (for compressor)		
Electric heater	W	-		20 (Crank case heater)		
Operation control	Remote control	(option) wired : RC-EX1A, RC-E5, RCH-E3 Interface kit : SC-BIKN-E				
	Room temperature control	Thermostat by electronics				
	Operation display	RUN: Green, TIMER: Yellow, HI POWER: Green, 3D AUTO: Green, ECONO: Blue				
Safety equipments		Internal thermostat for fan motor. Frost protection thermostat. Abnormal discharge temperature protection.				
Installation data	Refrigerant piping size (O.D.)	mm	Liquid line: I/U φ 6.35 (1/4") ② φ 9.52(3/8")×0.8 ① φ 9.52 (3/8")×0.8 O/U φ 9.52 (3/8") Gas line: I/U φ 12.7 (1/2") ② φ 12.7(1/2")×0.8 ① φ 15.88 (5/8")×1.0 O/U φ 15.88 (5/8")			
	Connecting method		Flare piping		Flare piping	
	Attached length of piping	m	-		-	
	Insulation for piping		Necessary (both Liquid & Gas lines)			
	Refrigerant line (one way) length	m	Max.50m			
	Vertical height diff. between O.U. and I.U.	m	Max.30m (Outdoor unit is higher)		Max.15m (Outdoor unit is lower)	
Drain hose		Hose connectable with VP16		Holes size φ 20 × 3pcs		
Drain pump, max lift height	mm	-				
Recommended breaker size	A	-				
L.R.A. (Locked rotor ampere)	A	5.0				
Interconnecting wires Size × Core number		φ 1.6mm×3 cores (+ earth cable 1.6mm) / Terminal block (Screw fixing type)				
IP number		IPX0		IP24		
Standard accessories		Mounting kit, Clean filter		Edging		
Option parts		-				

Note (1) The data are measured at the following conditions. The pipe length is 7.5m.

Item	Indoor air temperature		Outdoor air temperature		Standards
	DB	WB	DB	WB	
Cooling	27°C	19°C	35°C	24°C	ISO5151-T1
Heating	20°C	-	7°C	6°C	

(2) This air-conditioner is manufactured and tested in conformity with the ISO.

(3) Sound level indicates the value in an anechoic chamber. During operation these value are somewhat higher due to ambient conditions.

(4) Select the breaker size according to the own national standard.

(5) The operation data indicate when the air-conditioner is operated at 230V50Hz or 220V60Hz.

(6) Indoor unit specifications for one unit. Capacity and operation data are two indoor units are combined and run together.

(7) Branching pipe set "DIS-WA1"×1(option). ① : Pipe of O/U ~ Branch, ② : Pipe of Branch ~ I/U

Item		Model	SRK100VSPZMX		
			Indoor unit SRK50ZMX-S (2 units)	Outdoor unit FDC100VS	
Power source			3 Phase 380-415V 50Hz / 380V 60Hz		
Operation data	Nominal cooling capacity (range)	kW	10.0 [4.0(Min.) ~ 11.2(Max.)]		
	Nominal heating capacity (range)	kW	11.2 [4.0(Min.) ~ 12.5(Max.)]		
	Power consumption	Cooling	kW	2.72	
		Heating		2.86	
	Max power consumption		4.00		
	Running current	Cooling	A	4.0 / 4.2	
		Heating		4.2 / 4.4	
	Inrush current, max current		5, 15		
	Power factor	Cooling	%	98	
		Heating		98	
	EER	Cooling	3.68		
	COP	Heating	3.92		
Sound power level	Cooling	dB(A)	60		
	Heating		64		
Sound pressure level	Cooling	dB(A)	Hi : 47 Me : 40 Lo : 27 ULo : 25		
	Heating		Hi : 48 Me : 40 Lo : 33 ULo : 26		
Silent mode sound pressure level		-			
Exterior dimensions (Height × Width × Depth)		mm	309 × 890 × 220		
Exterior appearance (Munsell color)			Fine snow (8.0Y 9.3 / 0.1) near equivalent		
Net weight		kg	15		
Compressor type & Q'ty			-		
Compressor motor (Starting method)		kW	-		
Refrigerant oil (Amount, type)		ℓ	-		
Refrigerant (Type, amount, pre-charge length)		kg	R410A 3.8kg (Pre-charged up to the piping length of 30m) Outdoor unit		
Heat exchanger			Louver fin & inner grooved tubing		
Refrigerant control			Electronic expansion valve		
Fan type & Q'ty			Tangential fan ×1		
Fan motor (Starting method)		W	27 < Direct line start >		
Air flow	Cooling	m³/min	Hi : 13.5 Me : 11 Lo : 8 ULo : 7.0		
	Heating		Hi : 17 Me : 14.5 Lo : 10.5 ULo : 8.0		
Available external static pressure		Pa	0		
Outside air intake			Not possible		
Air filter, Quality / Quantity			Polypropylene net (Washable) ×2		
Shock & vibration absorber			Rubber sleeve (for fan motor)		
Electric heater		W	-		
Operation control	Remote control		(option) wired : RC-EX1A, RC-E5, RCH-E3 Interface kit : SC-BIKN-E		
	Room temperature control		Thermostat by electronics		
	Operation display		RUN: Green, TIMER: Yellow, HI POWER: Green, 3D AUTO: Green, ECONO: Blue		
Safety equipments			Internal thermostat for fan motor. Frost protection thermostat. Abnormal discharge temperature protection.		
Installation data	Refrigerant piping size (O.D.)	mm	Liquid line: I/U φ 6.35 (1/4") ② φ 9.52(3/8")×0.8 ① φ 9.52 (3/8")×0.8 O/U φ 9.52 (3/8") Gas line: I/U φ 12.7 (1/2") ② φ 12.7(1/2")×0.8 ① φ 15.88 (5/8")×1.0 O/U φ 15.88 (5/8")		
	Connecting method		Flare piping		
	Attached length of piping	m	-		
	Insulation for piping		Necessary (both Liquid & Gas lines)		
	Refrigerant line (one way) length	m	Max.50m		
	Vertical height diff. between O.U. and I.U.	m	Max.30m (Outdoor unit is higher) Max.15m (Outdoor unit is lower)		
Drain hose		Hose connectable with VP16 Holes size φ 20 × 3pcs			
Drain pump, max lift height		mm	-		
Recommended breaker size		A	-		
L.R.A. (Locked rotor ampere)		A	5.0		
Interconnecting wires Size × Core number			φ 1.6mm×3 cores (+ earth cable 1.6mm) / Terminal block (Screw fixing type)		
IP number			IPX0		
Standard accessories			Mounting kit, Clean filter		
Option parts			-		

Note (1) The data are measured at the following conditions. The pipe length is 7.5m.

Item	Indoor air temperature		Outdoor air temperature		Standards
	DB	WB	DB	WB	
Cooling	27°C	19°C	35°C	24°C	ISO5151-T1
Heating	20°C	-	7°C	6°C	

- (2) This air-conditioner is manufactured and tested in conformity with the ISO.
- (3) Sound level indicates the value in an anechoic chamber. During operation these value are somewhat higher due to ambient conditions.
- (4) Select the breaker size according to the own national standard.
- (5) The operation data indicate when the air-conditioner is operated at 400V50Hz or 380V60Hz.
- (6) Indoor unit specifications for one unit. Capacity and operation data are two indoor units are combined and run together.
- (7) Branching pipe set "DIS-WA1"×1(option). ① : Pipe of O/U ~ Branch, ② : Pipe of Branch ~ I/U

PCA001Z717 

Item		Model	SRK125VNPZMX		
			Indoor unit SRK60ZMX-S (2 units)	Outdoor unit FDC125VN	
Power source			1 Phase 220-240V 50Hz / 220V 60Hz		
Operation data	Nominal cooling capacity (range)	kW	12.5 [5.0(Min.)~ 14.0(Max.)]		
	Nominal heating capacity (range)	kW	14.0 [4.0(Min.)~ 16.0(Max.)]		
	Power consumption	Cooling	kW	4.25	
		Heating		4.29	
	Max power consumption		5.58		
	Running current	Cooling	A	18.7 / 19.5	
		Heating		18.8 / 19.7	
	Inrush current, max current		5, 24		
	Power factor	Cooling	%	99	
		Heating		99	
	EER	Cooling		2.94	
	COP	Heating		3.26	
Sound power level	Cooling	dB(A)	64		
	Heating		72		
Sound pressure level	Cooling	dB(A)	Hi : 51 Me : 41 Lo : 29 ULo : 25		
	Heating		Hi : 48 Me : 41 Lo : 34 ULo : 27		
Silent mode sound pressure level			Cooling : 46 / Heating : 48		
Exterior dimensions (Height × Width × Depth)		mm	309 × 890 × 220		
Exterior appearance (Munsell color)			Fine snow (8.0Y 9.3 / 0.1) near equivalent		
Net weight		kg	15		
Compressor type & Q'ty			RMT5126MDE2×1		
Compressor motor (Starting method)		kW	Direct line start		
Refrigerant oil (Amount, type)		ℓ	0.9 M-MA68		
Refrigerant (Type, amount, pre-charge length)		kg	R410A 3.8kg (Pre-charged up to the piping length of 30m) Outdoor unit		
Heat exchanger			Louver fin & inner grooved tubing		
Refrigerant control			Straight fin & inner grooved tubing		
Fan type & Q'ty			Electronic expansion valve		
Fan motor (Starting method)		W	Tangential fan ×1		
Air flow		m ³ /min	Propeller fan ×1		
Available external static pressure		Pa	27 < Direct line start >		
Outside air intake			86 < Direct line start >		
Air filter, Quality / Quantity			Hi : 14.5 Me : 12.5 Lo : 8.5 ULo : 7.0		
Shock & vibration absorber			Hi : 17.5 Me : 15 Lo : 11 ULo : 8.5		
Electric heater		W	0		
Remote control			Not Possible		
Room temperature control			Polypropylene net (washable) ×2		
Operation display			Rubber sleeve (for fan motor)		
Safety equipments			Rubber sleeve (for compressor)		
Refrigerant piping size (O.D.)		mm	20 (Crank case heater)		
Connecting method			(option) wired : RC-EX1A, RC-E5, RCH-E3 Interface kit : SC-BIKN-E		
Attached length of piping		m	Thermostat by electronics		
Insulation for piping			RUN: Green, TIMER: Yellow, HI POWER: Green, 3D AUTO: Green, ECONO: Blue		
Refrigerant line (one way) length		m	Internal thermostat for fan motor.		
Vertical height diff. between O.U. and I.U.		m	Frost protection thermostat.		
Drain hose			Abnormal discharge temperature protection.		
Drain pump, max lift height		mm	Liquid line: I/U φ 6.35 (1/4") ② φ 9.52(3/8")×0.8 ① φ 9.52 (3/8")×0.8 O/U φ 9.52 (3/8")		
Recommended breaker size		A	Gas line: I/U φ 12.7 (1/2") ② φ 12.7(1/2")×0.8 ① φ 15.88 (5/8")×1.0 O/U φ 15.88 (5/8")		
L.R.A. (Locked rotor ampere)		A	Flare piping		
Interconnecting wires Size × Core number			Flare piping		
IP number			Necessary (both Liquid & Gas lines)		
Standard accessories			Max.50m		
Option parts			Max.30m (Outdoor unit is higher) Max.15m (Outdoor unit is lower)		
Note (1) The data are measured at the following conditions.			Hose connectable with VP16		
The pipe length is 7.5m.			Holes size φ 20 × 3pcs		

Operation	Indoor air temperature		Outdoor air temperature		Standards
	DB	WB	DB	WB	
Cooling	27°C	19°C	35°C	24°C	ISO5151-T1
Heating	20°C	—	7°C	6°C	

- (2) This air-conditioner is manufactured and tested in conformity with the ISO.
- (3) Sound level indicates the value in an anechoic chamber. During operation these value are somewhat higher due to ambient conditions.
- (4) Select the breaker size according to the own national standard.
- (5) The operation data indicate when the air-conditioner is operated at 230V50Hz or 220V60Hz.
- (6) Indoor unit specifications for one unit. Capacity and operation data are two indoor units are combined and run together.
- (7) Branching pipe set "DIS-WA1"×1(option). ① : Pipe of O/U ~ Branch, ② : Pipe of Branch ~ I/U

PCA001Z717

Item		Model	SRK125VSPZMX		
			Indoor unit SRK60ZMX-S (2 units)	Outdoor unit FDC125VS	
Power source			3 Phase 380-415V 50Hz / 380V 60Hz		
Operation data	Nominal cooling capacity (range)	kW	12.5 [5.0(Min.) ~ 14.0(Max.)]		
	Nominal heating capacity (range)	kW	14.0 [4.0(Min.) ~ 16.0(Max.)]		
	Power consumption	Cooling	kW	4.25	
		Heating		4.29	
	Max power consumption		5.58		
	Running current	Cooling	A	6.3 / 6.6	
		Heating		6.3 / 6.7	
	Inrush current, max current		5, 15		
	Power factor	Cooling	%	98	
		Heating		98	
	EER	Cooling	2.94		
	COP	Heating	3.26		
Sound power level	Cooling	dB(A)	64		
	Heating		72		
Sound pressure level	Cooling	Hi : 51 Me : 41 Lo : 29 ULo : 25			
	Heating	Hi : 48 Me : 41 Lo : 34 ULo : 27			
Silent mode sound pressure level		Cooling : 46 / Heating : 48			
Exterior dimensions (Height × Width × Depth)	mm	309 × 890 × 220			
Exterior appearance (Munsell color)		Fine snow (8.0Y 9.3 / 0.1) near equivalent			
Net weight	kg	15			
Compressor type & Q'ty		RMT5126MDE3×1			
Compressor motor (Starting method)	kW	Direct line start			
Refrigerant oil (Amount, type)	ℓ	0.9 M-MA68			
Refrigerant (Type, amount, pre-charge length)	kg	R410A 3.8kg (Pre-charged up to the piping length of 30m) Outdoor unit			
Heat exchanger		Louver fin & inner grooved tubing			
Refrigerant control		Electronic expansion valve			
Fan type & Q'ty		Tangential fan ×1			
Fan motor (Starting method)	W	27 < Direct line start >			
Air flow	Cooling	m³/min	Hi : 14.5 Me : 12.5 Lo : 8.5 ULo : 7.0		
	Heating		Hi : 17.5 Me : 15 Lo : 11 ULo : 8.5		
Available external static pressure	Pa	0			
Outside air intake		Not possible			
Air filter, Quality / Quantity		Polypropylene net (Washable) ×2			
Shock & vibration absorber		Rubber sleeve (for fan motor)			
Electric heater	W	20 (Crank case heater)			
Operation control	Remote control	(option) wired : RC-EX1A, RC-E5, RCH-E3 Interface kit : SC-BIKN-E			
	Room temperature control	Thermostat by electronics			
	Operation display	RUN: Green, TIMER: Yellow, HI POWER: Green, 3D AUTO: Green, ECONO: Blue			
Safety equipments		Internal thermostat for fan motor. Frost protection thermostat. Abnormal discharge temperature protection.			
Installation data	Refrigerant piping size (O.D.)	mm	Liquid line: I/U φ 6.35 (1/4") ② φ 9.52(3/8")×0.8 ① φ 9.52 (3/8")×0.8 O/U φ 9.52 (3/8") Gas line: I/U φ 12.7 (1/2") ② φ 12.7(1/2")×0.8 ① φ 15.88 (5/8")×1.0 O/U φ 15.88 (5/8")		
	Connecting method		Flare piping		
	Attached length of piping	m	—		
	Insulation for piping		Necessary (both Liquid & Gas lines)		
	Refrigerant line (one way) length	m	Max.50m		
	Vertical height diff. between O.U. and I.U.	m	Max.30m (Outdoor unit is higher) Max.15m (Outdoor unit is lower)		
Drain hose		Hose connectable with VP16 Holes size φ 20 × 3pcs			
Drain pump, max lift height	mm	—			
Recommended breaker size	A	—			
L.R.A. (Locked rotor ampere)	A	5.0			
Interconnecting wires	Size × Core number	φ 1.6mm×3 cores (+ earth cable 1.6mm) / Terminal block (Screw fixing type)			
IP number		IPX0			
Standard accessories		Mounting kit, Clean filter			
Option parts		—			

Note (1) The data are measured at the following conditions. The pipe length is 7.5m.

Item	Indoor air temperature		Outdoor air temperature		Standards
	DB	WB	DB	WB	
Cooling	27°C	19°C	35°C	24°C	ISO5151-T1
Heating	20°C	—	7°C	6°C	

- (2) This air-conditioner is manufactured and tested in conformity with the ISO.
- (3) Sound level indicates the value in an anechoic chamber. During operation these value are somewhat higher due to ambient conditions.
- (4) Select the breaker size according to the own national standard.
- (5) The operation data indicate when the air-conditioner is operated at 400V50Hz or 380V60Hz.
- (6) Indoor unit specifications for one unit. Capacity and operation data are two indoor units are combined and run together.
- (7) Branching pipe set "DIS-WA1"×1(option). ① : Pipe of O/U ~ Branch, ② : Pipe of Branch ~ I/U

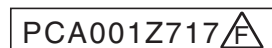

(b) Triple type

Item		Model		SRK140VNTZMX		
				Indoor unit SRK50ZMX-S (3 units)	Outdoor unit FDC140VN	
Power source				1 Phase 220-240V 50Hz / 220V 60Hz		
Operation data	Nominal cooling capacity (range)	kW		14.0 [5.0(Min.)~ 14.5(Max.)]		
	Nominal heating capacity (range)	kW		16.0 [4.0(Min.)~ 16.5(Max.)]		
	Power consumption	Cooling	kW		4.53	
		Heating	kW		4.05	
	Max power consumption			5.89		
	Running current	Cooling	A		19.9 / 20.8	
		Heating	A		17.8 / 18.6	
	Inrush current, max current			5, 24		
	Power factor	Cooling	%		99	
		Heating	%		99	
	EER	Cooling		3.09		
	COP	Heating		3.95		
	Sound power level	Cooling	dB(A)		60	
Heating		dB(A)		64		
Sound pressure level	Cooling	dB(A)		Hi : 47 Me : 40 Lo : 27 ULo : 25		
	Heating	dB(A)		Hi : 48 Me : 40 Lo : 33 ULo : 26		
Silent mode sound pressure level			-		Cooling : 47 / Heating : 50	
Exterior dimensions (Height × Width × Depth)	mm		309 × 890 × 220		845×970×370	
Exterior appearance (Munsell color)			Fine snow (8.0Y 9.3 / 0.1) near equivalent		Stucco White (4.2Y7.5/1.1) near equivalent	
Net weight	kg		15		81	
Compressor type & Q'ty			-		RMT5126MDE2×1	
Compressor motor (Starting method)	kW		-		Direct line start	
Refrigerant oil (Amount, type)	ℓ		-		0.9 M-MA68	
Refrigerant (Type, amount, pre-charge length)	kg		R410A 3.8kg (Pre-charged up to the piping length of 30m) Outdoor unit			
Heat exchanger			Louver fin & inner grooved tubing		Straight fin & inner grooved tubing	
Refrigerant control			Electronic expansion valve			
Fan type & Q'ty			Tangential fan ×1		Propeller fan ×1	
Fan motor (Starting method)	W		27 < Direct line start >		86 < Direct line start >	
Air flow	Cooling	m³/min		Hi : 13.5 Me : 11 Lo : 8 ULo : 7.0		
	Heating	m³/min		Hi : 17 Me : 14.5 Lo : 10.5 ULo : 8.0		
Available external static pressure	Pa		0			
Outside air intake			Not Possible			
Air filter, Quality / Quantity			Polypropylene net (washable) ×2			
Shock & vibration absorber			Rubber sleeve (for fan motor)		Rubber sleeve (for compressor)	
Electric heater	W		-		20 (Crank case heater)	
Operation control	Remote control			(option) wired : RC-EX1A, RC-E5, RCH-E3 Interface kit : SC-BIKN-E		
	Room temperature control			Thermostat by electronics		
	Operation display			RUN: Green, TIMER: Yellow, HI POWER: Green, 3D AUTO: Green, ECONO: Blue		
Safety equipments				Internal thermostat for fan motor. Frost protection thermostat. Abnormal discharge temperature protection.		
Installation data	Refrigerant piping size (O.D.)	mm		Liquid line: I/U φ 6.35 (1/4") ② φ 9.52(3/8")×0.8 ① φ 9.52 (3/8")×0.8 O/U φ 9.52 (3/8") Gas line: I/U φ 12.7 (1/2") ② φ 12.7(1/2")×0.8 ① φ 15.88 (5/8")×1.0 O/U φ 15.88 (5/8")		
	Connecting method			Flare piping		
	Attached length of piping	m		-		
	Insulation for piping			Necessary (both Liquid & Gas lines)		
	Refrigerant line (one way) length	m		Max.50m		
	Vertical height diff. between O.U. and I.U.	m		Max.30m (Outdoor unit is higher) Max.15m (Outdoor unit is lower)		
Drain hose			Hose connectable with VP16		Holes size φ 20 × 3pcs	
Drain pump, max lift height	mm		-			
Recommended breaker size	A		-			
L.R.A. (Locked rotor ampere)	A		5.0			
Interconnecting wires	Size × Core number		φ 1.6mm×3 cores (+ earth cable 1.6mm) / Terminal block (Screw fixing type)			
IP number			IPX0		IP24	
Standard accessories			Mounting kit, Clean filter		Edging	
Option parts			-			
Note (1) The data are measured at the following conditions. The pipe length is 7.5m.						
		Indoor air temperature		Outdoor air temperature		
Operation	DB	WB	DB	WB	Standards	
	Cooling	27°C	19°C	35°C		24°C
Heating	20°C	-	7°C	6°C	ISO5151-T1	
<p>(2) This air-conditioner is manufactured and tested in conformity with the ISO.</p> <p>(3) Sound level indicates the value in an anechoic chamber. During operation these value are somewhat higher due to ambient conditions.</p> <p>(4) Select the breaker size according to the own national standard.</p> <p>(5) The operation data indicate when the air-conditioner is operated at 230V50Hz or 220V60Hz.</p> <p>(6) Indoor unit specifications for one unit. Capacity and operation data are two indoor units are combined and run together.</p> <p>(7) Branching pipe set "DIS-TA1"×1(option). ① : Pipe of O/U ~ Branch, ② : Pipe of Branch ~ I/U</p>						

PCA001Z717 

Item		Model	SRK140VSTZMX		
			Indoor unit SRK50ZMX-S (3 units)	Outdoor unit FDC140VS	
Power source			3 Phase 380-415V 50Hz / 380V 60Hz		
Operation data	Nominal cooling capacity (range)	kW	14.0 [5.0(Min.) ~ 14.5(Max.)]		
	Nominal heating capacity (range)	kW	16.0 [4.0(Min.) ~ 16.5(Max.)]		
	Power consumption	Cooling	kW	4.53	
		Heating		4.05	
	Max power consumption		5.89		
	Running current	Cooling	A	6.7 / 7.0	
		Heating		6.0 / 6.3	
	Inrush current, max current		5, 15		
	Power factor	Cooling	%	98	
		Heating		98	
	EER	Cooling	3.09		
	COP	Heating	3.95		
	Sound power level	Cooling	dB(A)	60	
Heating		64			
Sound pressure level	Cooling	dB(A)	Hi : 47 Me : 40 Lo : 27 ULo : 25		
	Heating		Hi : 48 Me : 40 Lo : 33 ULo : 26		
Silent mode sound pressure level		-			
Exterior dimensions (Height × Width × Depth)		mm	309 × 890 × 220		
Exterior appearance (Munsell color)			Fine snow (8.0Y 9.3 / 0.1) near equivalent		
Net weight		kg	15		
Compressor type & Q'ty			-		
Compressor motor (Starting method)		kW	-		
Refrigerant oil (Amount, type)		ℓ	-		
Refrigerant (Type, amount, pre-charge length)		kg	R410A 3.8kg (Pre-charged up to the piping length of 30m) Outdoor unit		
Heat exchanger			Louver fin & inner grooved tubing		
Refrigerant control			Electronic expansion valve		
Fan type & Q'ty			Tangential fan ×1		
Fan motor (Starting method)		W	27 < Direct line start >		
Air flow	Cooling	m³/min	Hi : 13.5 Me : 11 Lo : 8 ULo : 7.0		
	Heating		Hi : 17 Me : 14.5 Lo : 10.5 ULo : 8.0		
Available external static pressure		Pa	0		
Outside air intake			Not possible		
Air filter, Quality / Quantity			Polypropylene net (Washable) ×2		
Shock & vibration absorber			Rubber sleeve (for fan motor)		
Electric heater		W	-		
Operation control	Remote control		(option) wired : RC-EX1A, RC-E5, RCH-E3 Interface kit : SC-BIKN-E		
	Room temperature control		Thermostat by electronics		
	Operation display		RUN: Green, TIMER: Yellow, HI POWER: Green, 3D AUTO: Green, ECONO: Blue		
Safety equipments			Internal thermostat for fan motor. Frost protection thermostat. Abnormal discharge temperature protection.		
Installation data	Refrigerant piping size (O.D.)	mm	Liquid line: I/U φ 6.35 (1/4") ② φ 9.52(3/8")×0.8 ① φ 9.52 (3/8")×0.8 O/U φ 9.52 (3/8") Gas line: I/U φ 12.7 (1/2") ② φ 12.7(1/2")×0.8 ① φ 15.88 (5/8")×1.0 O/U φ 15.88 (5/8")		
	Connecting method		Flare piping		
	Attached length of piping	m	-		
	Insulation for piping		Necessary (both Liquid & Gas lines)		
	Refrigerant line (one way) length	m	Max.50m		
	Vertical height diff. between O.U. and I.U.	m	Max.30m (Outdoor unit is higher) Max.15m (Outdoor unit is lower)		
Drain hose			Hose connectable with VP16 Holes size φ 20 × 3pcs		
Drain pump, max lift height		mm	-		
Recommended breaker size		A	-		
L.R.A. (Locked rotor ampere)		A	5.0		
Interconnecting wires Size × Core number			φ 1.6mm×3 cores (+ earth cable 1.6mm) / Terminal block (Screw fixing type)		
IP number			IPX0		
Standard accessories			Mounting kit, Clean filter		
Option parts			-		

Note (1) The data are measured at the following conditions. The pipe length is 7.5m.

Item	Indoor air temperature		Outdoor air temperature		Standards
	DB	WB	DB	WB	
Cooling	27°C	19°C	35°C	24°C	ISO5151-T1
Heating	20°C	-	7°C	6°C	

- (2) This air-conditioner is manufactured and tested in conformity with the ISO.
- (3) Sound level indicates the value in an anechoic chamber. During operation these value are somewhat higher due to ambient conditions.
- (4) Select the breaker size according to the own national standard.
- (5) The operation data indicate when the air-conditioner is operated at 400V50Hz or 380V60Hz.
- (6) Indoor unit specifications for one unit. Capacity and operation data are two indoor units are combined and run together.
- (7) Branching pipe set "DIS-TA1"×1(option). ① : Pipe of O/U ~ Branch, ② : Pipe of Branch ~ I/U

PCA001Z717 

1.2 EXTERIOR DIMENSIONS

(1) Indoor units
 (a) Ceiling cassette-4way type (FDT)
 Models FDT50VF, 60VF, 71VF1

Symbol	Content		
	Model	50,60	71
A	Gas piping	φ12.7 (1/2") (Flare)	φ15.88 (5/8") (Flare)
B	Liquid piping	φ6.35 (1/4") (Flare)	φ9.52 (3/8") (Flare)
C	Drain piping	VP25(O.D.32)	
D	Hole for wiring		
F	Suspension bolts	(M10 or M8)	
G	Outside air opening for ducting	(Knock out)	
H	Air outlet opening for ducting	(Knock out)	

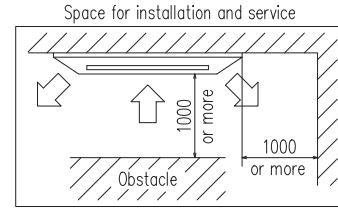

Make a space of 4000 or more between the units when installing more than one.

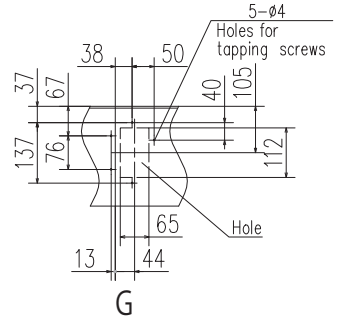
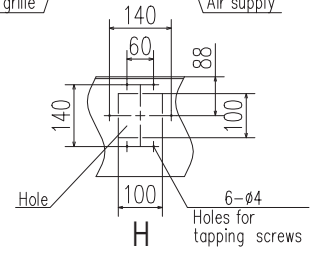
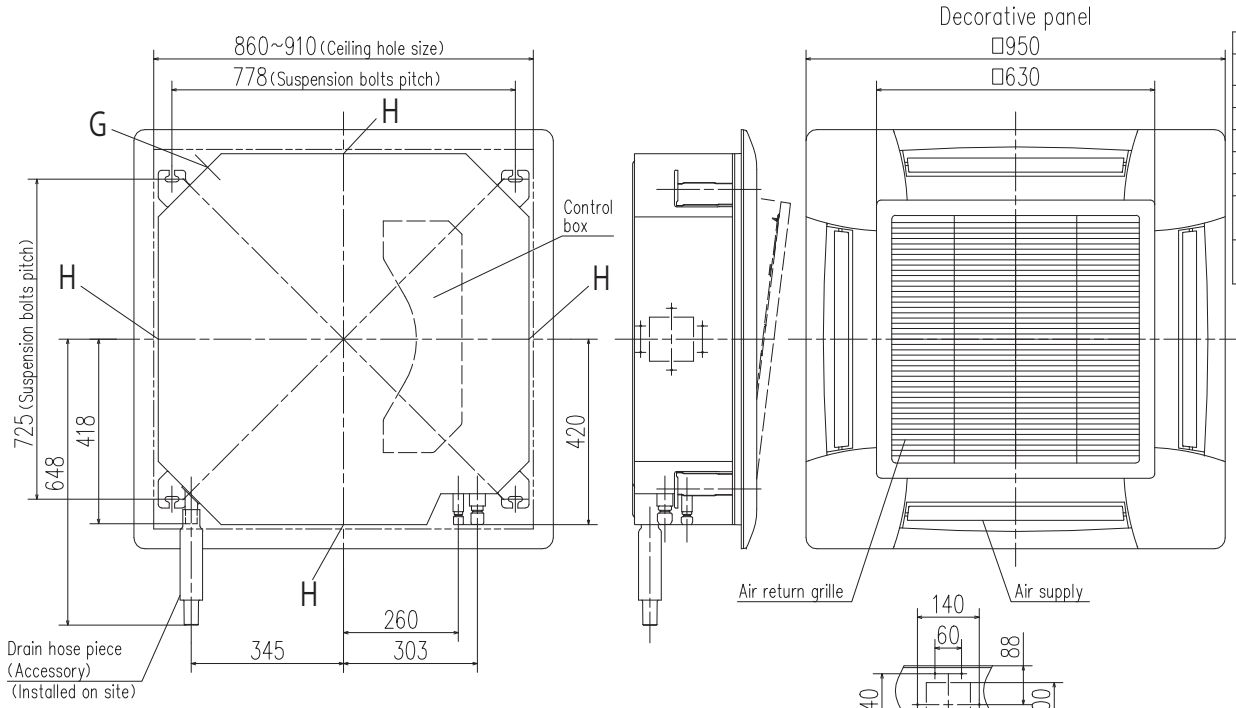

Note (1) The model name label is attached inside the air return grille.

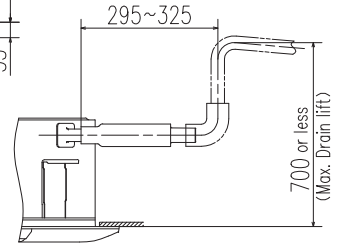
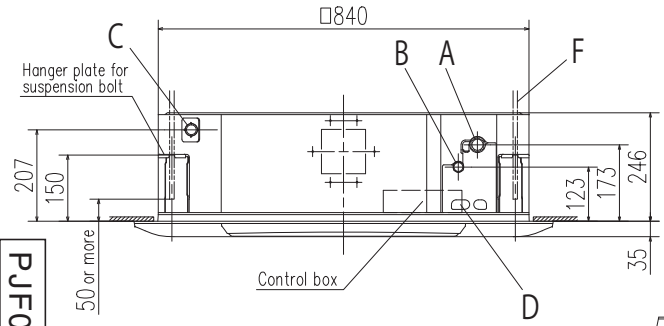

PJF000Z284

Unit:mm

PJF000Z285 

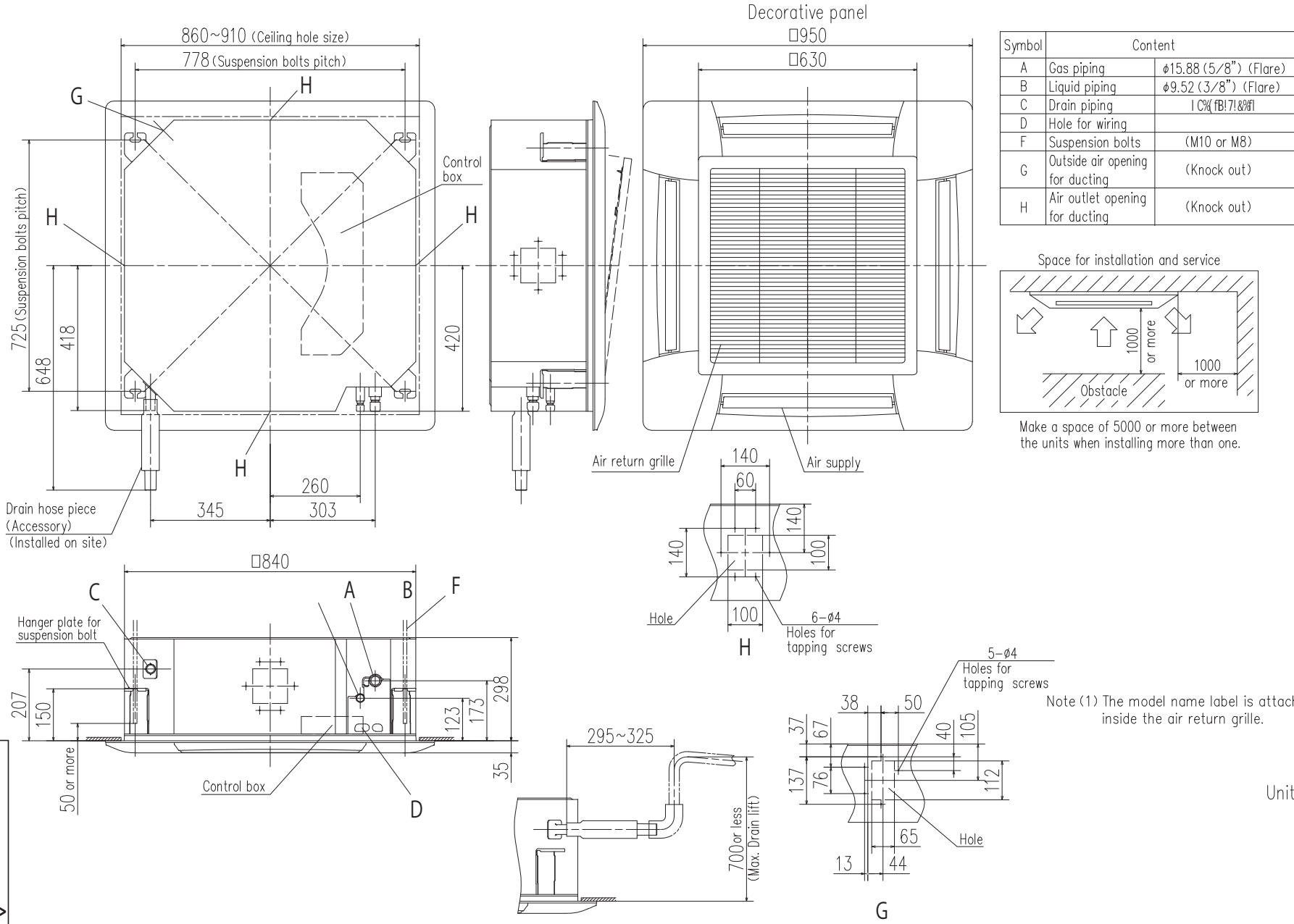

Models FDT100VF1, 125VF, 140VF, 100VF2

Unit: mm

PJA003Z338

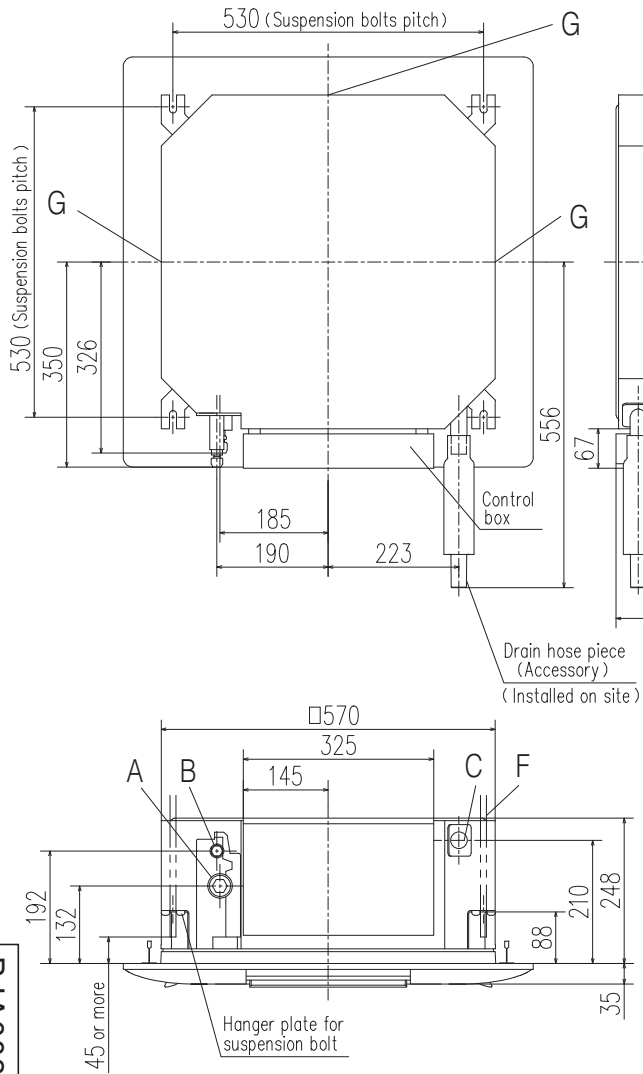

Notes (1) The model name label is attached on the control box lid.
 (2) Prepare the connecting socket (VP20) on site.
 (3) This unit is designed for 2x2 grid ceiling.
 If it is installed on a ceiling other than 2x2 grid ceiling,
 provide an inspection port on the control box side.

Decorative panel

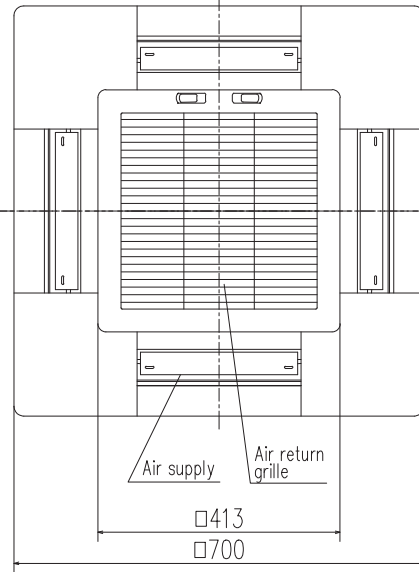

Symbol	Content	
A	Gas piping	φ12.7 (1/2") (Flare)
B	Liquid piping	φ6.35 (1/4") (Flare)
C	Drain piping	VP20 (I.D.20,O.D.26) Note (2)
D	Hole for wiring	φ25
F	Suspension bolts	(M10 or M8)
G	Air outlet opening for ducting	(Knock out)

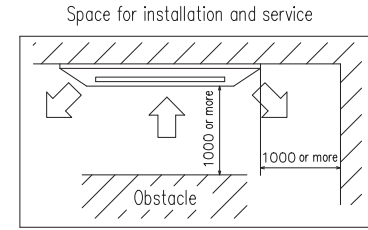

Make a space of 4000 or more between the units when installing more than one.

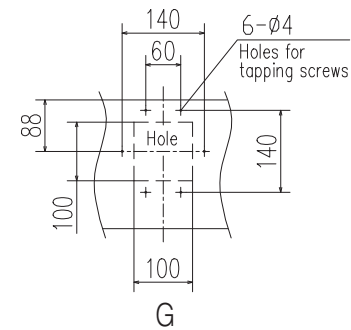
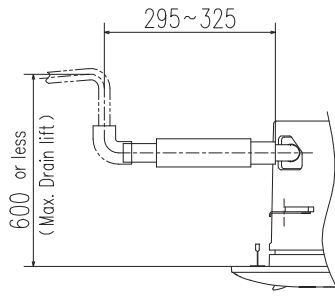

Unit: mm

(b) Ceiling cassette-4way compact type (FDTC)
 Models FDTC50VF, 60VF

Note (1) The model name label is attached on the fan casing inside the air return grille.

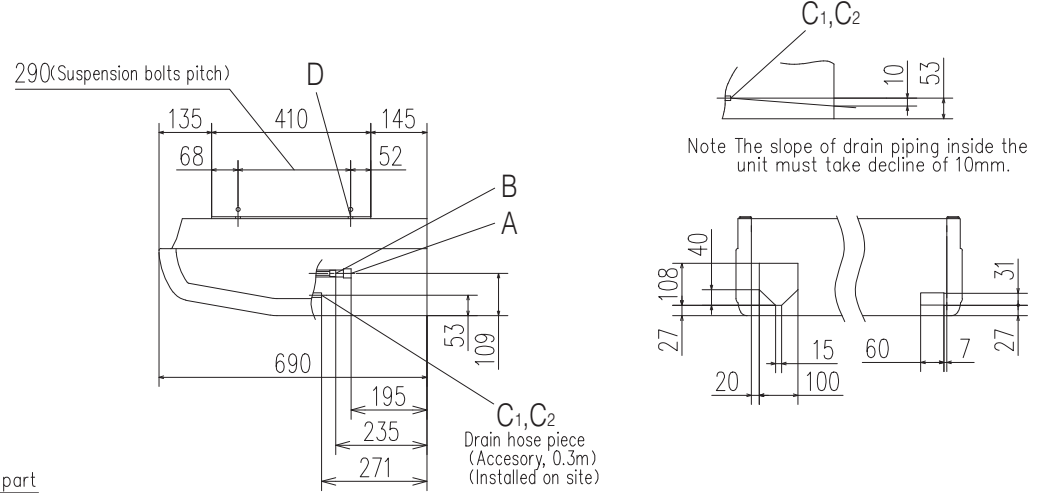
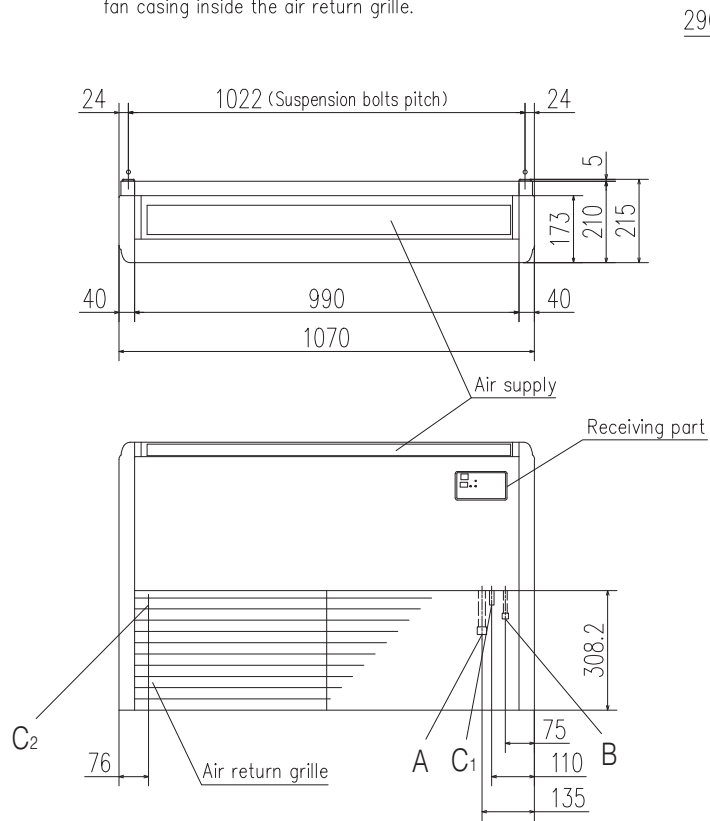

(c) Ceiling suspended type (FDEN)
Model FDEN50VF

Symbol	Content	
A	Gas piping	φ12.7 (1/2") (Flare)
B	Liquid piping	φ6.35 (1/4") (Flare)
C 1,2	Drain piping	VP20 (I.D.20, O.D.26)
D	Hole for suspension bolts	(M10 or M8)
E	Back cutout	PE cover
F	Top cutout	Plate cover
G	Drain piping (for left back)	(Knock out)

Unit: mm

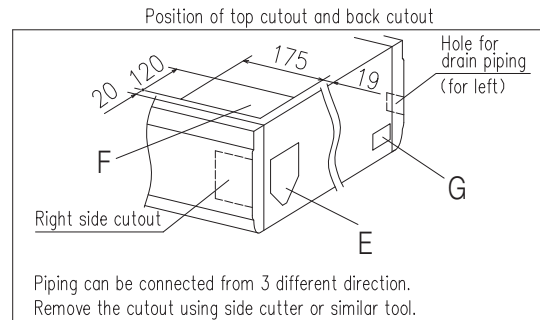
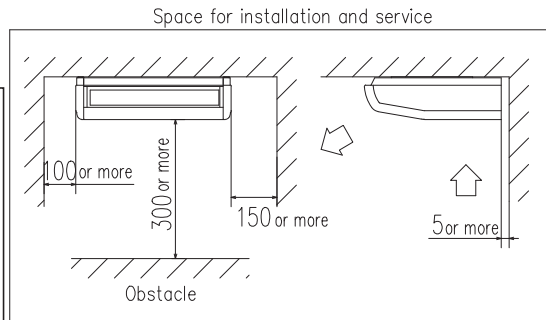

PFA003Z816

Note (1) The model name label is attached on the fan casing inside the air return grille.

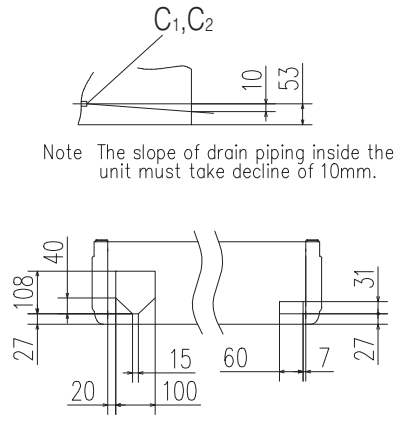
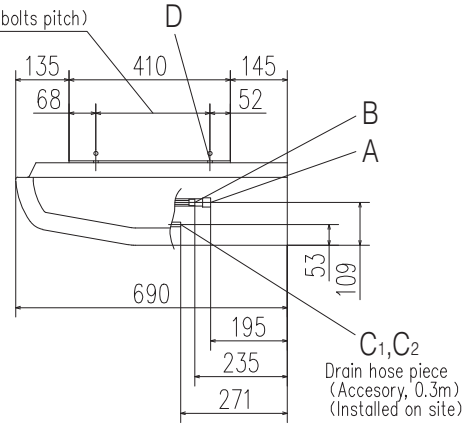
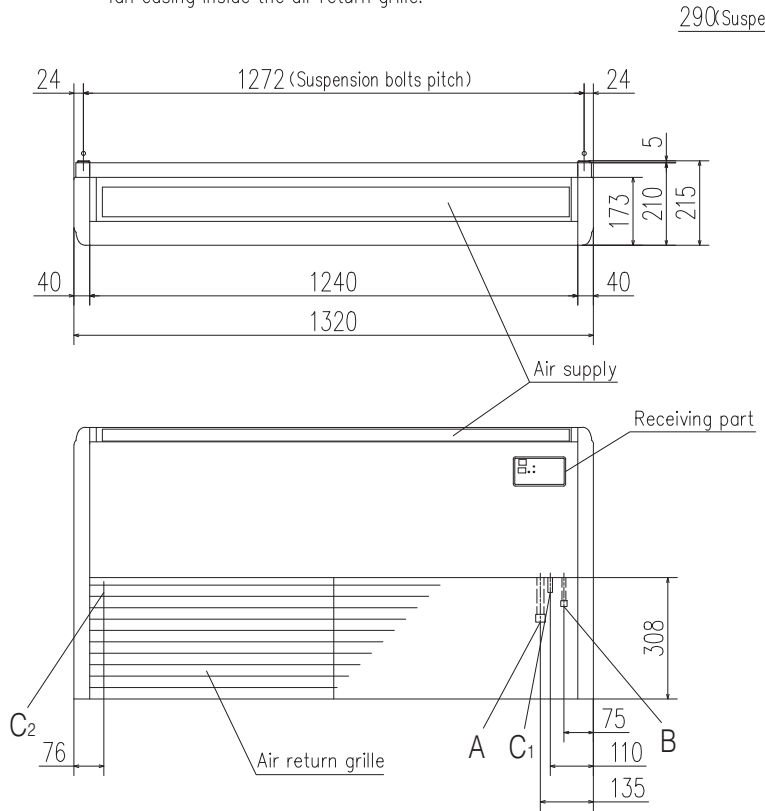

Symbol	Content	
	Model 60	71
A	Gas piping φ12.7 (1/2") (Flare)	φ15.88 (5/8") (Flare)
B	Liquid piping φ6.35 (1/4") (Flare)	φ9.52 (3/8") (Flare)
C 1,2	Drain piping VP20 (I.D.20, O.D.26)	
D	Hole for suspension bolts (M10 or M8)	
E	Back cutout PE cover	
F	Top cutout Plate cover	
G	Hole for drain piping (for left back) (Knock out)	

Unit:mm

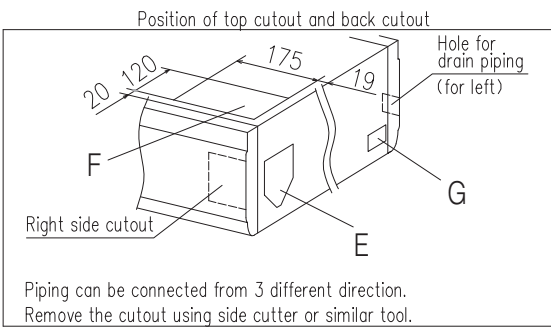
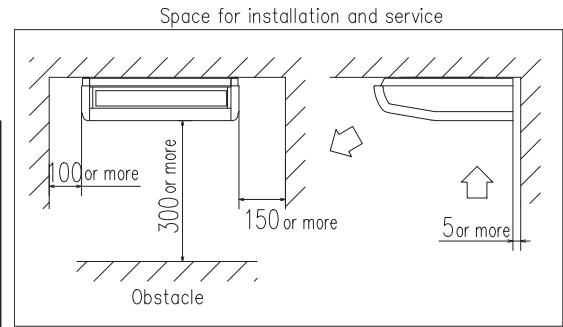

PFA003Z817

Make a space of 4500 or more between the units when installing more than one.

Note (1) The model name label is attached on the fan casing inside the air return grille.

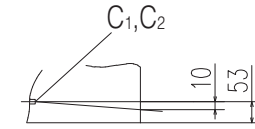
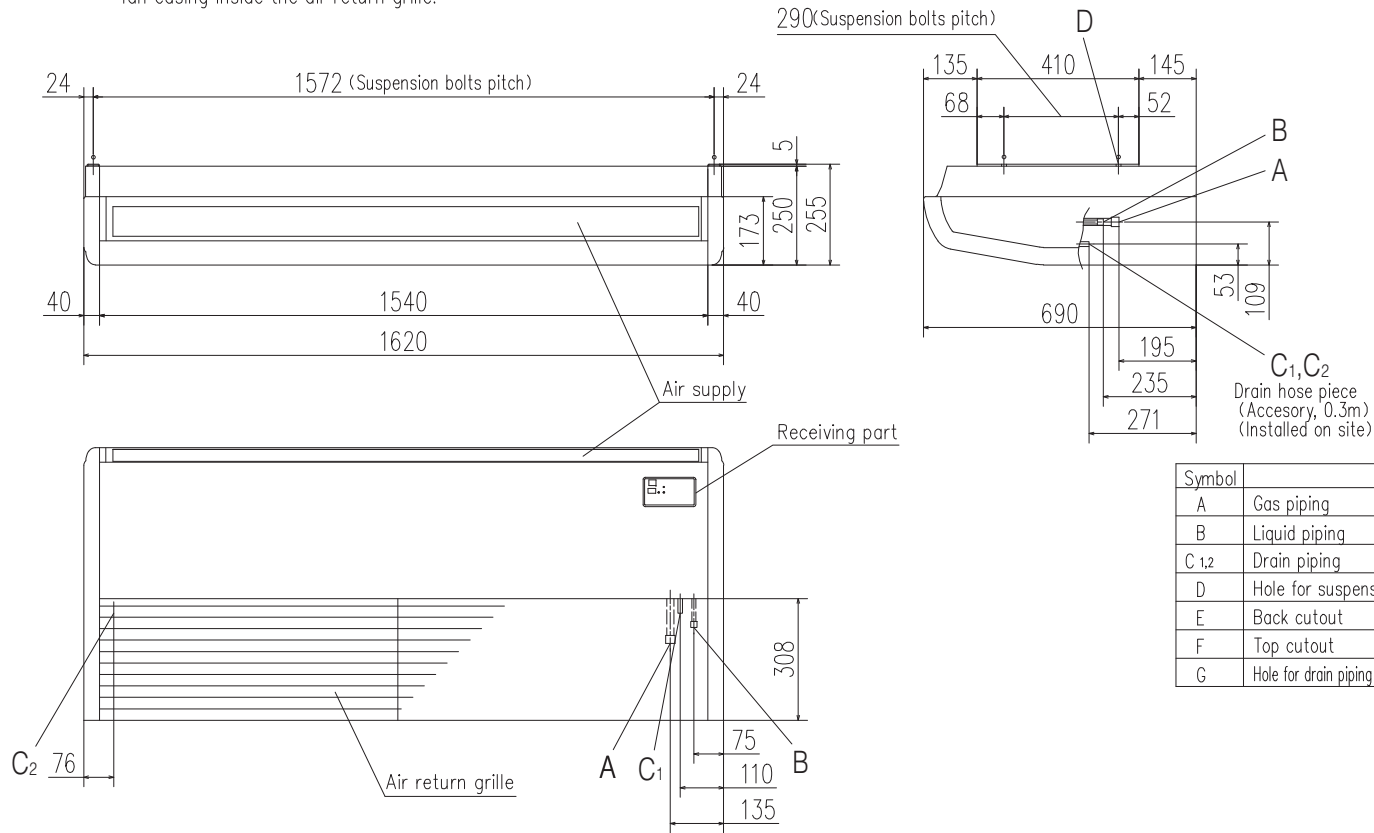

Note The slope of drain piping inside the unit must take decline of 10mm.

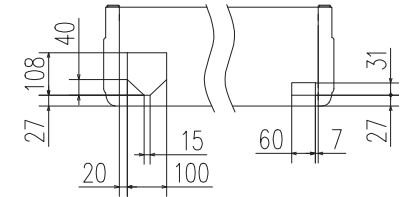

Symbol	Content	
A	Gas piping	φ15.88 (5/8") (Flare)
B	Liquid piping	φ9.52 (3/8") (Flare)
C _{1,2}	Drain piping	VP20 (I.D. 20, O.D. 26)
D	Hole for suspension bolt	(M10 or M8)
E	Back cutout	PE cover
F	Top cutout	Plate cover
G	Hole for drain piping (for left back)	(Knock out)

Unit:mm

Models FDEN100VF1, 125VF, 140VF

PFA003Z818

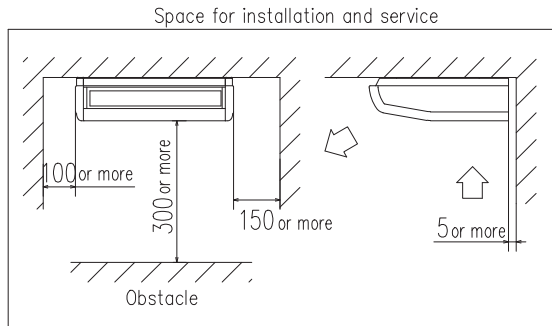

Make a space of 5000 or more between the units when installing more than one.

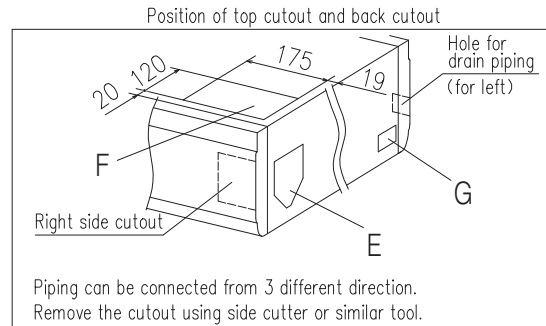

Piping can be connected from 3 different direction. Remove the cutout using side cutter or similar tool.

(d) Duct connected-High static pressure type (FDU)

Models FDU100VF1, 125VF, 140VF, 100VF2

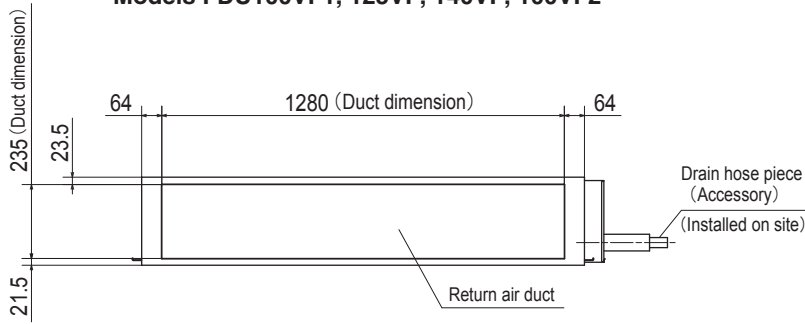

Symbol	Content	
A	Gas piping	ϕ 15.88 (5/8") (Flare)
B	Liquid piping	ϕ 9.52 (3/8") (Flare)
C1	Drain piping	VP25 (I.D.25,O.D.32)
C2	Drain piping (Gravity drainage)	VP20 (I.D.20,O.D.26)
D	Hole for wiring	
E	Suspension bolts	(M10)
F	Outside air opening for ducting	(Knock out)
G	Air outlet opening for ducting	(Knock out)
H	Inspection hole	(450X450)

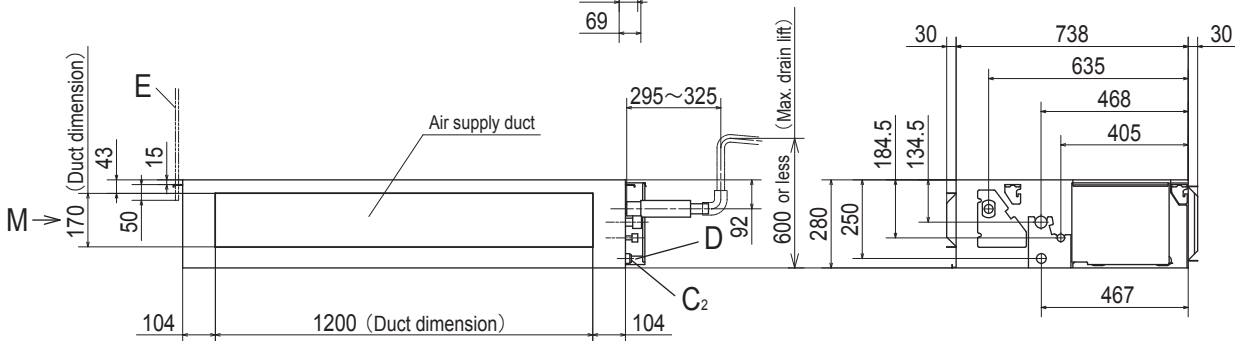
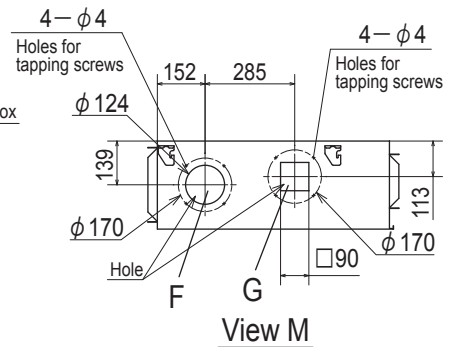
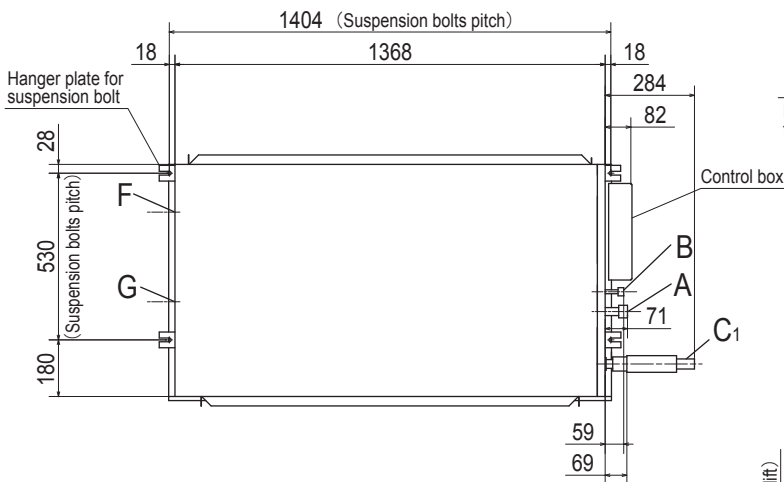

Unit:mm

Space for installation and service

Select either of two cases to keep space for installation and services.

(Case 1) From side of unit

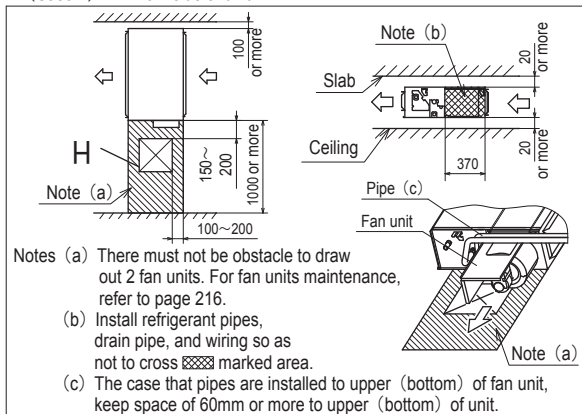

(Case 2) From bottom of unit

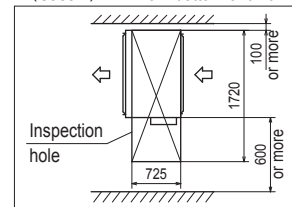

Notes (1) The model name label is attached on the lid of the control box.

PJG000Z048

Models FDU200VF, 250VF

Symbol	Model	Content	
		200	250
A	Gas piping	φ 25.4 (1") (Brazing)	
B	Liquid piping	φ 9.52 (3/8") (Brazing)	φ 12.7 (1/2") (Brazing)
C	Drain piping	VP25	
D	Hole for wiring	25	
E	Suspension bolts	(M10)	
F	Inspection hole	(600X600)	
G	Inspection hole	(900X1730)	

Note (1) The model name label is attached on the side plate of the control box.

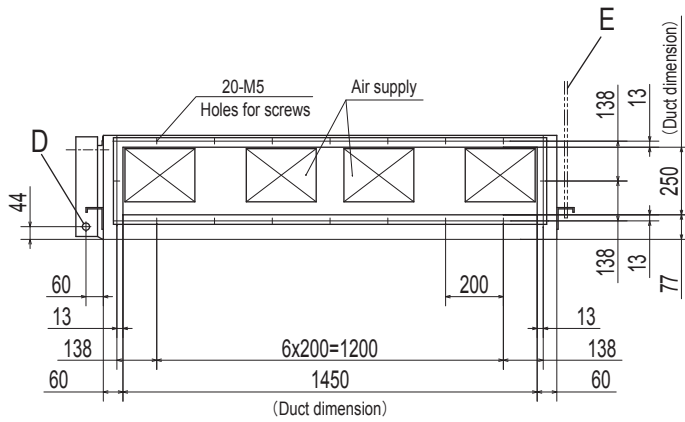
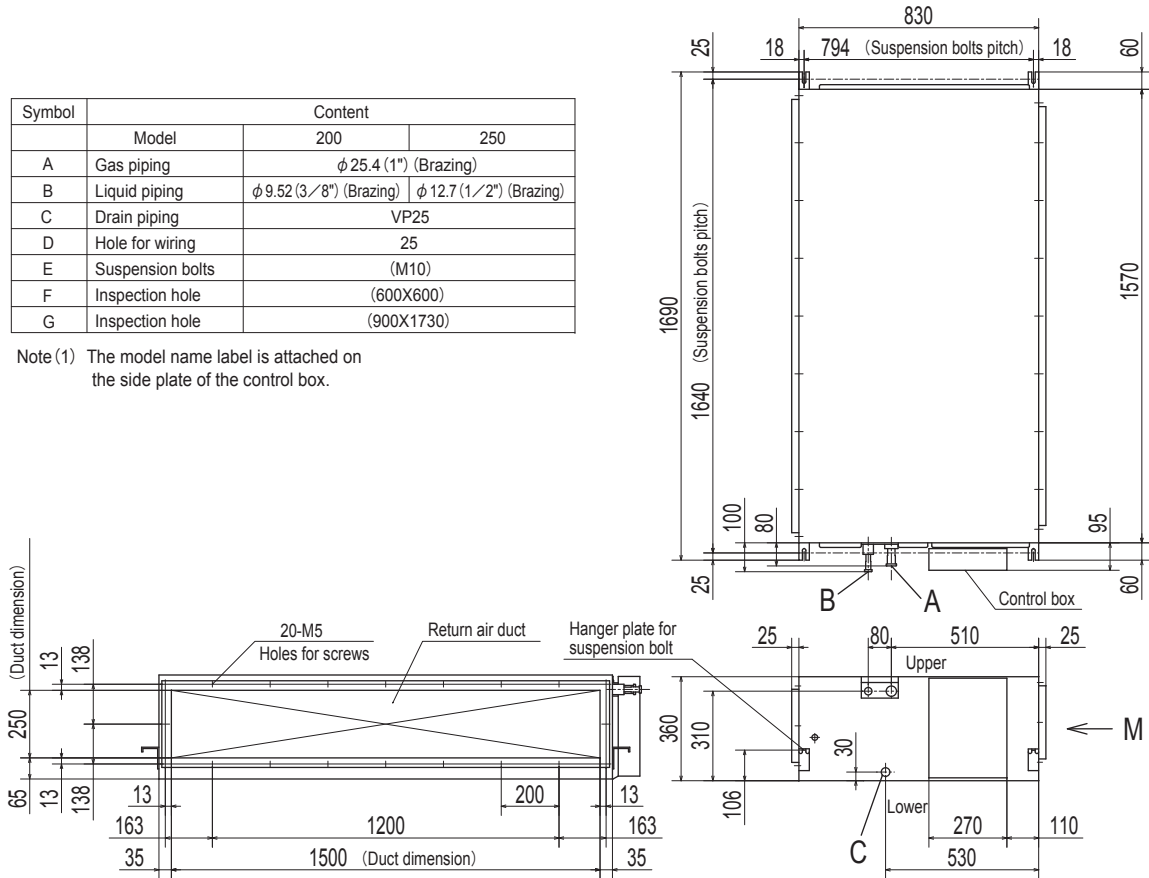

View M

Unit:mm

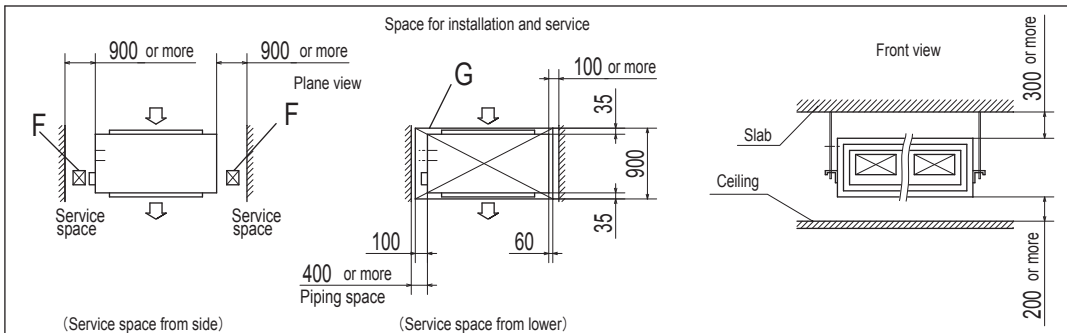

PJD001Z216

(e) Duct connected-Low / Middle static pressure type (FDUM)

Model FDUM50VF

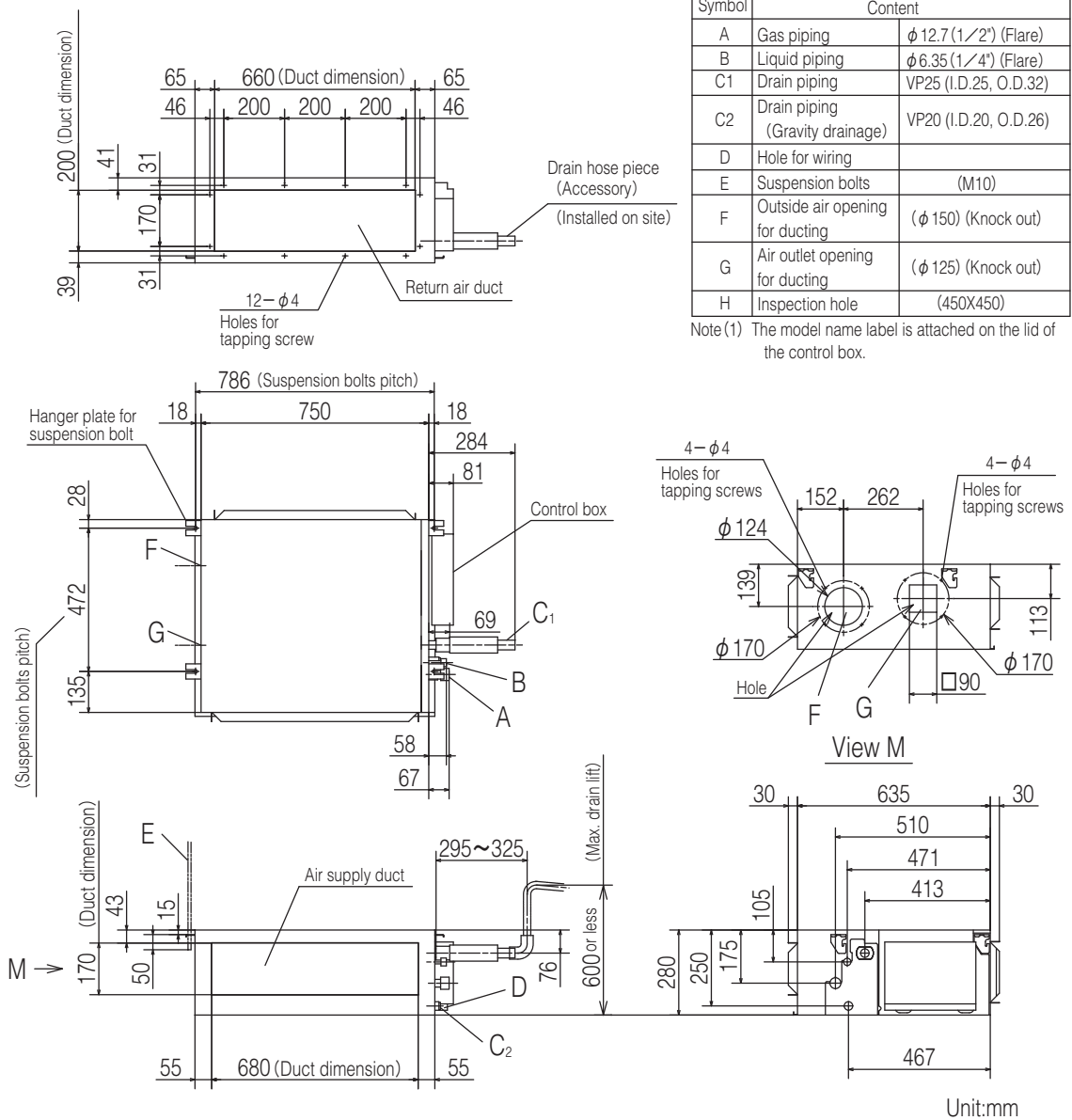

Space for installation and service

Select either of two cases to keep space for installation and services.

(Case 1) From side of unit

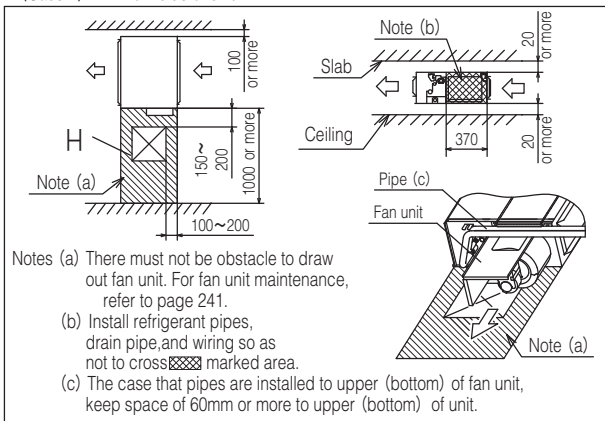

(Case 2) From bottom of unit

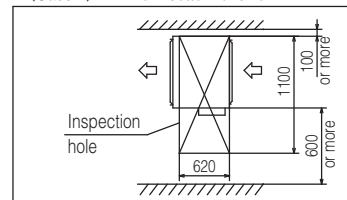

PJG000Z002

Model FDUM60VF

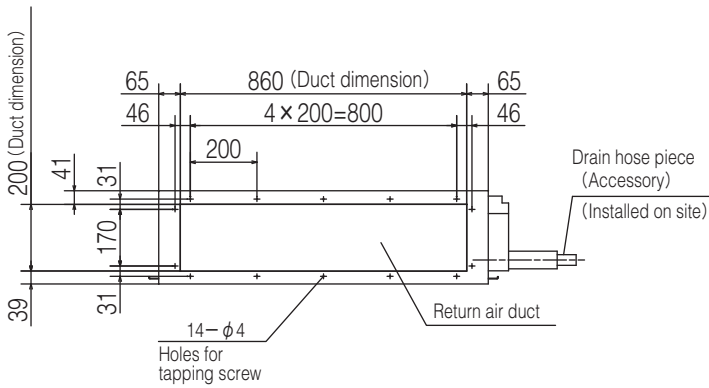

Symbol	Content	
A	Gas piping	φ 12.7 (1/2") (Flare)
B	Liquid piping	φ 6.35 (1/4") (Flare)
C1	Drain piping	VP25 (I.D.25, O.D.32)
C2	Drain piping (Gravity drainage)	VP20 (I.D.20, O.D.26)
D	Hole for wiring	
E	Suspension bolts	(M10)
F	Outside air opening for ducting	(φ 150) (Knock out)
G	Air outlet opening for ducting	(φ 125) (Knock out)
H	Inspection hole	(450X450)

Note(1) The model name label is attached on the lid of the control box.

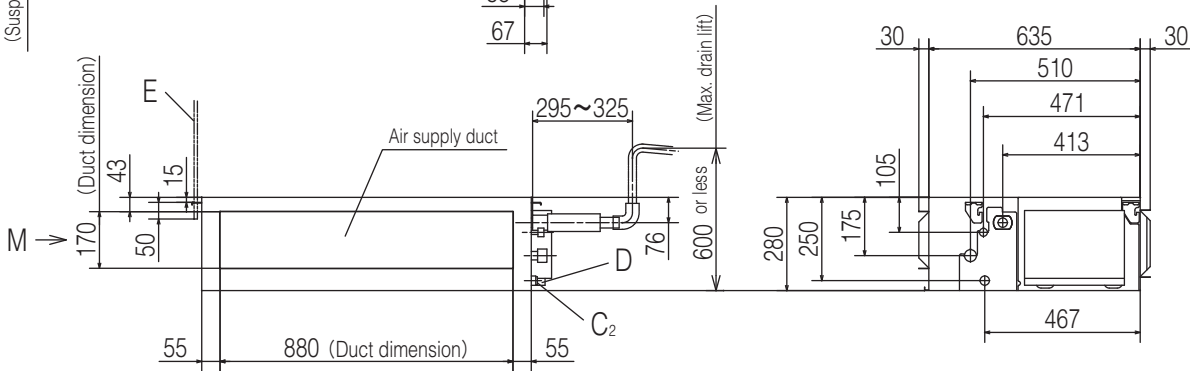
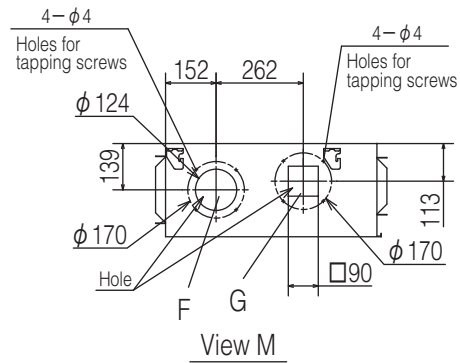
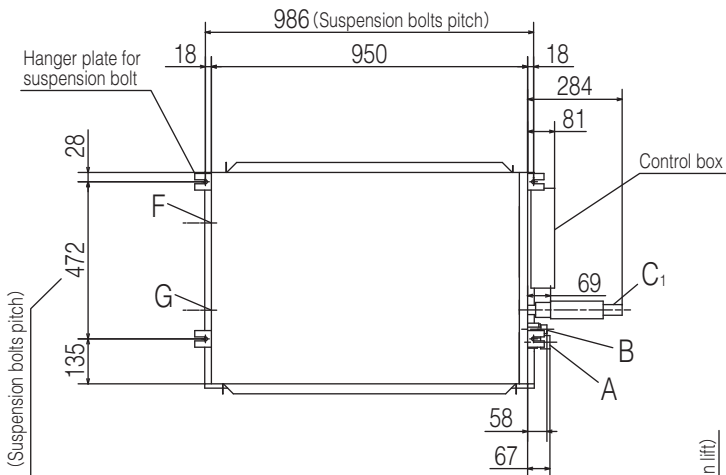

Space for installation and service

Select either of two cases to keep space for installation and services.

(Case 1) From side of unit

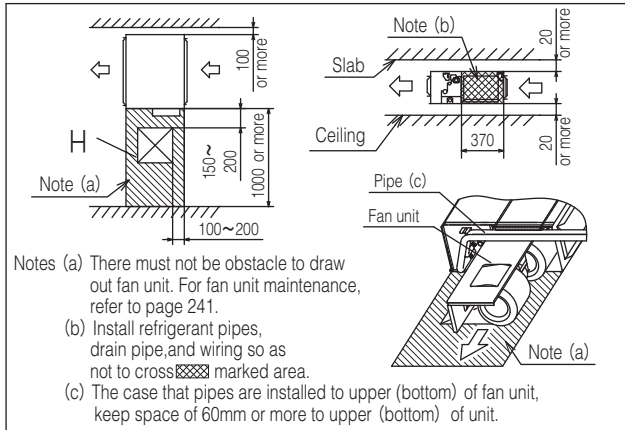

(Case 2) From bottom of unit

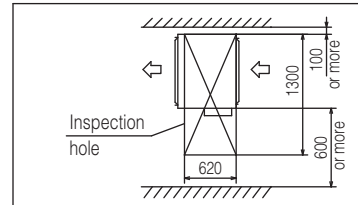

PJG000Z003

Model FDUM71VF1

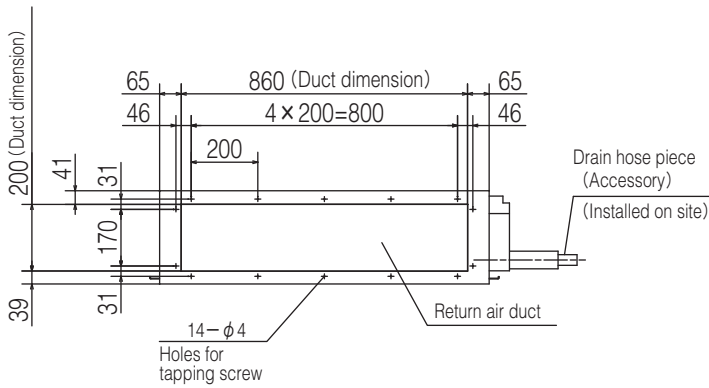

Symbol	Content	
A	Gas piping	φ 15.88 (5/8") (Flare)
B	Liquid piping	φ 9.52 (3/8") (Flare)
C1	Drain piping	VP25 (I.D.25, O.D.32)
C2	Drain piping (Gravity drainage)	VP20 (I.D.20, O.D.26)
D	Hole for wiring	
E	Suspension bolts	(M10)
F	Outside air opening for ducting	(φ 150) (Knock out)
G	Air outlet opening for ducting	(φ 125) (Knock out)
H	Inspection hole	(450X450)

Note (1) The model name label is attached on the lid of the control box.

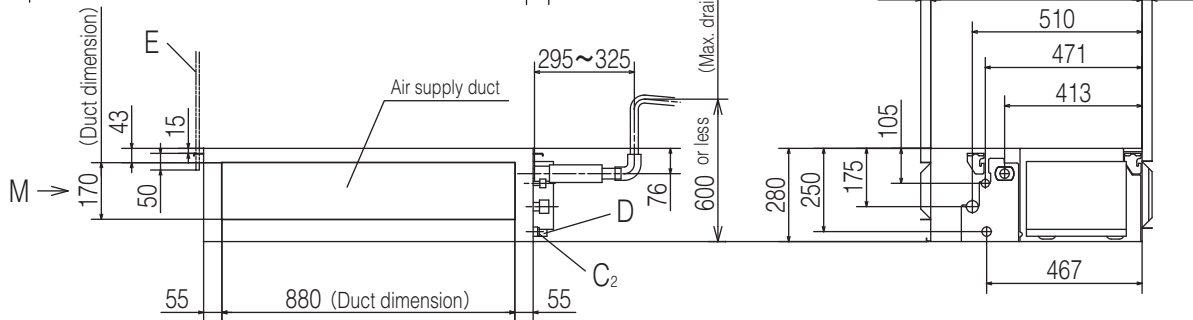
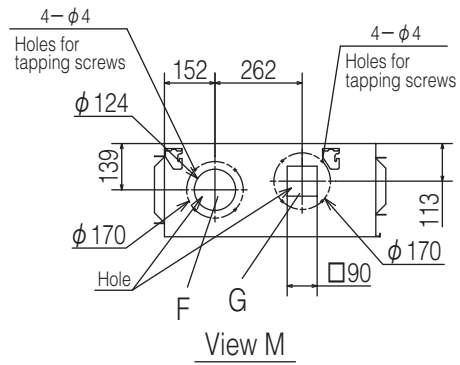
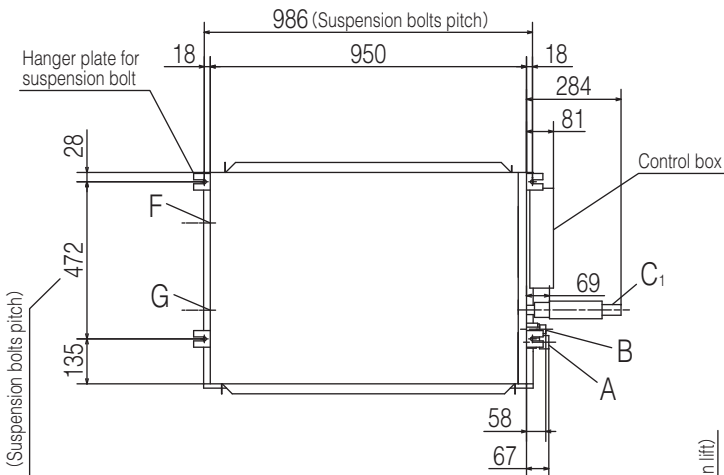

Space for installation and service

Select either of two cases to keep space for installation and services.

(Case 1) From side of unit

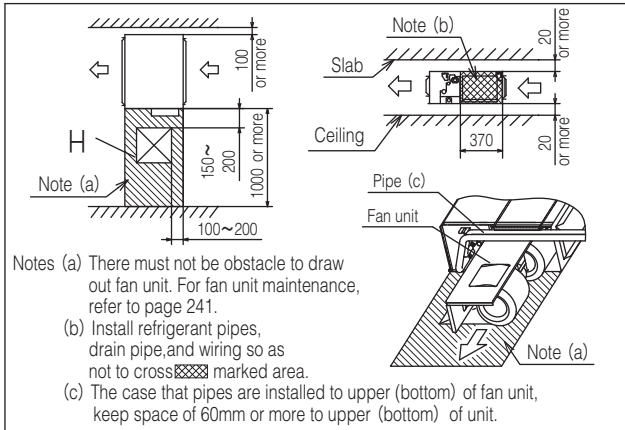

- Notes (a) There must not be obstacle to draw out fan unit. For fan unit maintenance, refer to page 241.
 (b) Install refrigerant pipes, drain pipe, and wiring so as not to cross marked area.
 (c) The case that pipes are installed to upper (bottom) of fan unit, keep space of 60mm or more to upper (bottom) of unit.

(Case 2) From bottom of unit

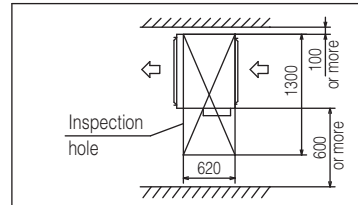

Models FDUM100VF1, 125VF, 140VF, 100VF2

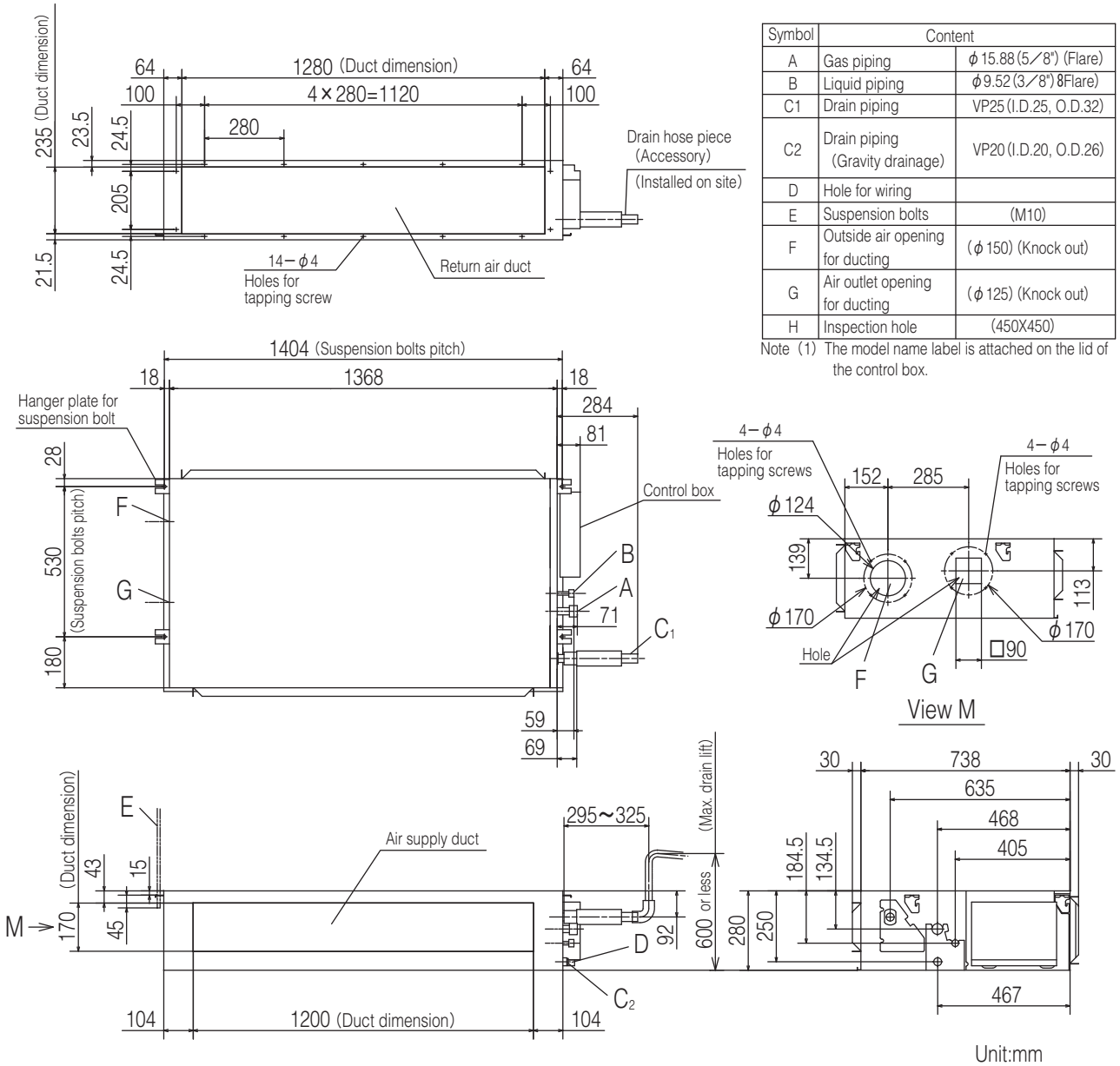

Space for installation and service

Select either of two cases to keep space for installation and services.
 (Case 1) From side of unit

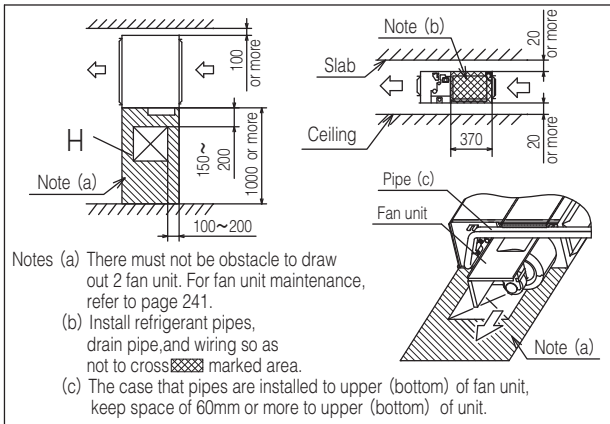

(Case 2) From bottom of unit

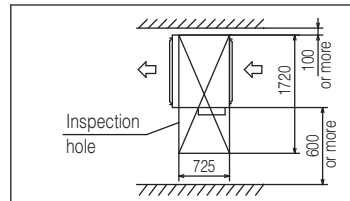

PJG000Z004

(f) Floor standing type (FDF)

Models FDF71VD1, 100VD1, 125VD, 140VD, 100VD2

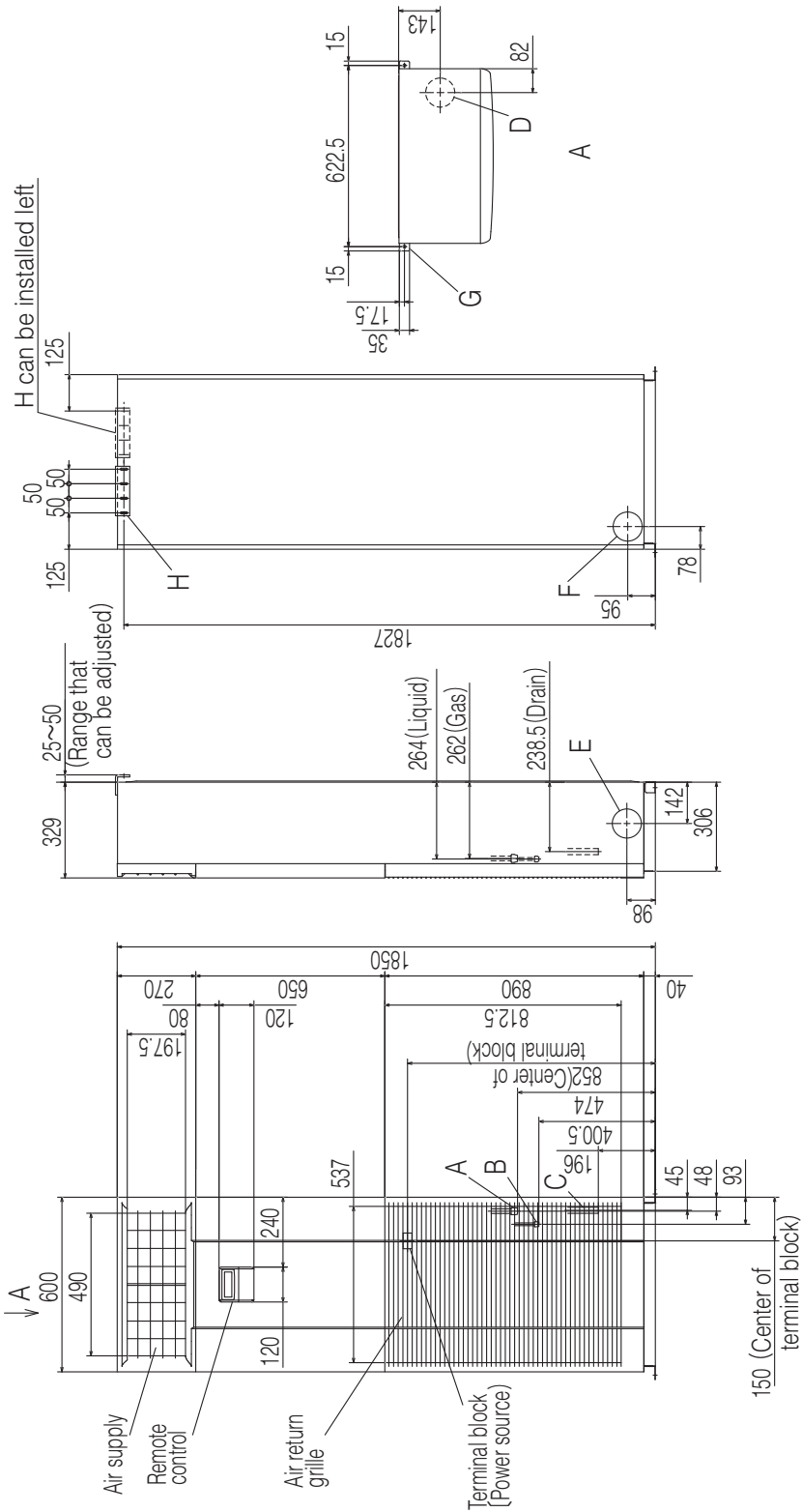

Space for installation and service

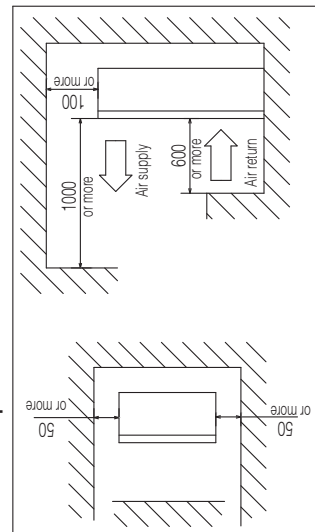

Symbol	Content
A	Gas piping φ15.88(5/8") (Flare)
B	Liquid piping φ9.52(3/8") (Flare)
C	Drain piping V20 (I.D. 20, O.D. 26)
D	Hole on wall for bottom piping φ100 (Resin cap having)
E	Hole on wall for side piping φ100 (Knock out)
F	Hole on wall for rear piping φ100 (Knock out)
G	Metal fittings to fix to floor face M8 (2 places)
H	Fall prevention metal fittings 4-7x25 (Slot)

Note (1) The model name label is attached on the left lower side panel inside the air return grille.

Unit:mm

PGA000Z801

RKY000Z058

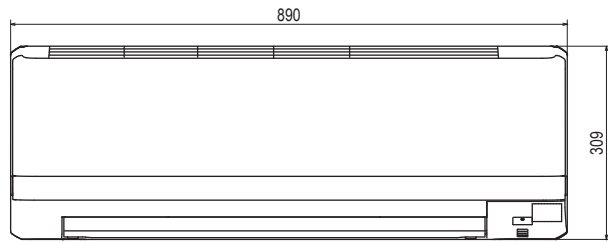
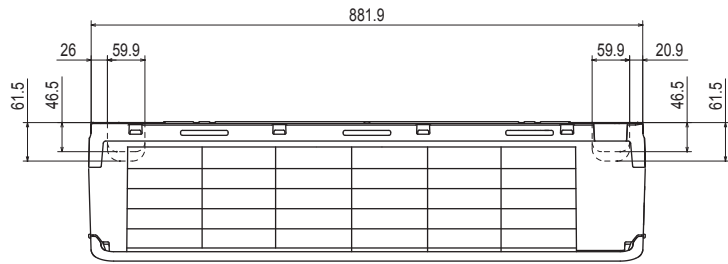

Outlet for down piping
(Refer to the above view)

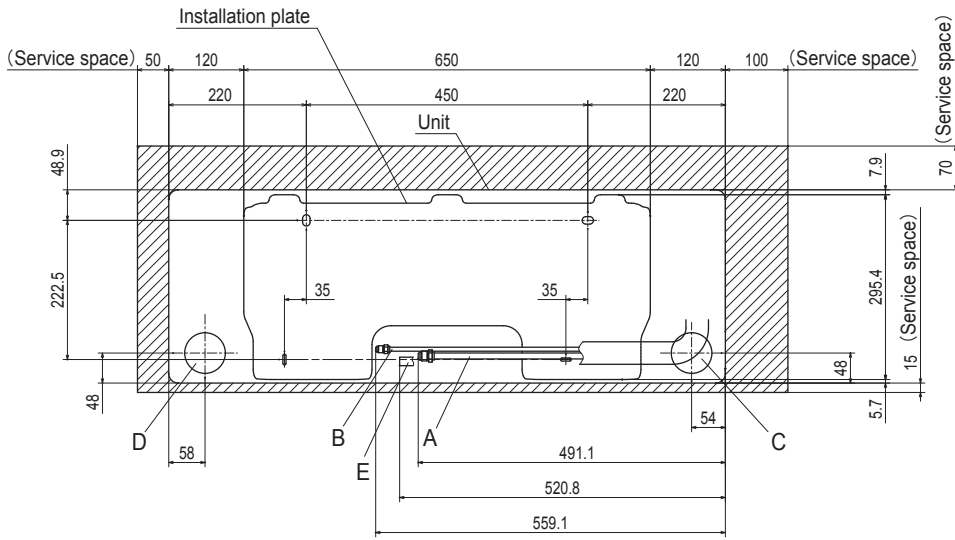

Space for installation and service when viewing from the front

Symbol	Content	
A	Gas piping	φ 12.7 (1/2") (Flare)
B	Liquid piping	φ 6.35 (1/4") (Flare)
C	Hole on wall for right rear piping	(φ 65)
D	Hole on wall for left rear piping	(φ 65)
E	Drain hose	VP16
F	Outlet for wiring	
G	Outlet for piping (on both side)	

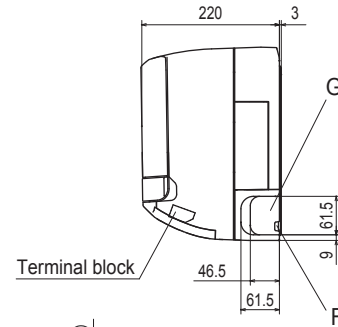

- Notes (1) The model name label is attached on the underside of the panel.
 (2) It takes the interface kit (SC-BIKN-E) to connect the wired remote control.

Unit:mm

(g) Wall mounted type (SRK)
 Models SRK50ZMX-S, 60ZMX-S

(2) Outdoor units

Models FDC100VN, 125VN, 140VN, 100VS, 125VS, 140VS (Service code Blank~/D)

Symbol	Content	
A	Service valve connection (gas side)	φ15.88(5/8") (Flare)
B	Service valve connection (liquid side)	φ9.52(3/8") (Flare)
C	Pipe / cable draw-out hole	
D	Drain discharge hole	φ20×3places
E	Anchor bolt hole	M10×4places
F	Cable draw-out hole	φ30×3places

Notes

- (1) It must not be surrounded by walls on the four sides.
- (2) The unit must be fixed with anchor bolts. An anchor bolt must not protrude more than 15mm.
- (3) Where the unit is subject to strong winds, lay it in such a direction that the blower outlet faces perpendicularly to the dominant wind direction.
- (4) Leave 1m or more space above the unit.
- (5) A wall in front of the blower outlet must not exceed the units height.
- (6) The model name label is attached on the lower right corner of the front panel.

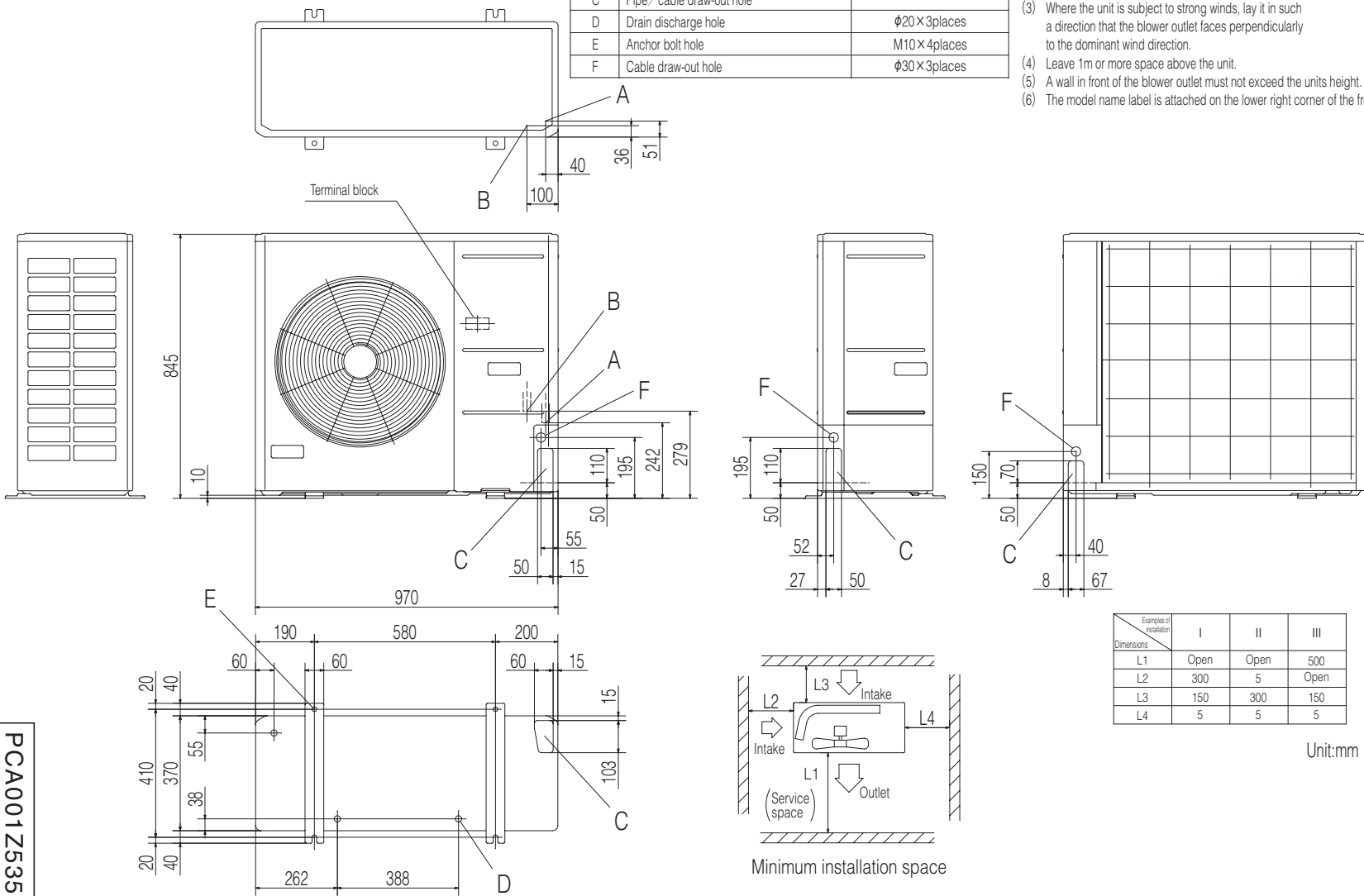

PCA001Z535

PCA001Z772

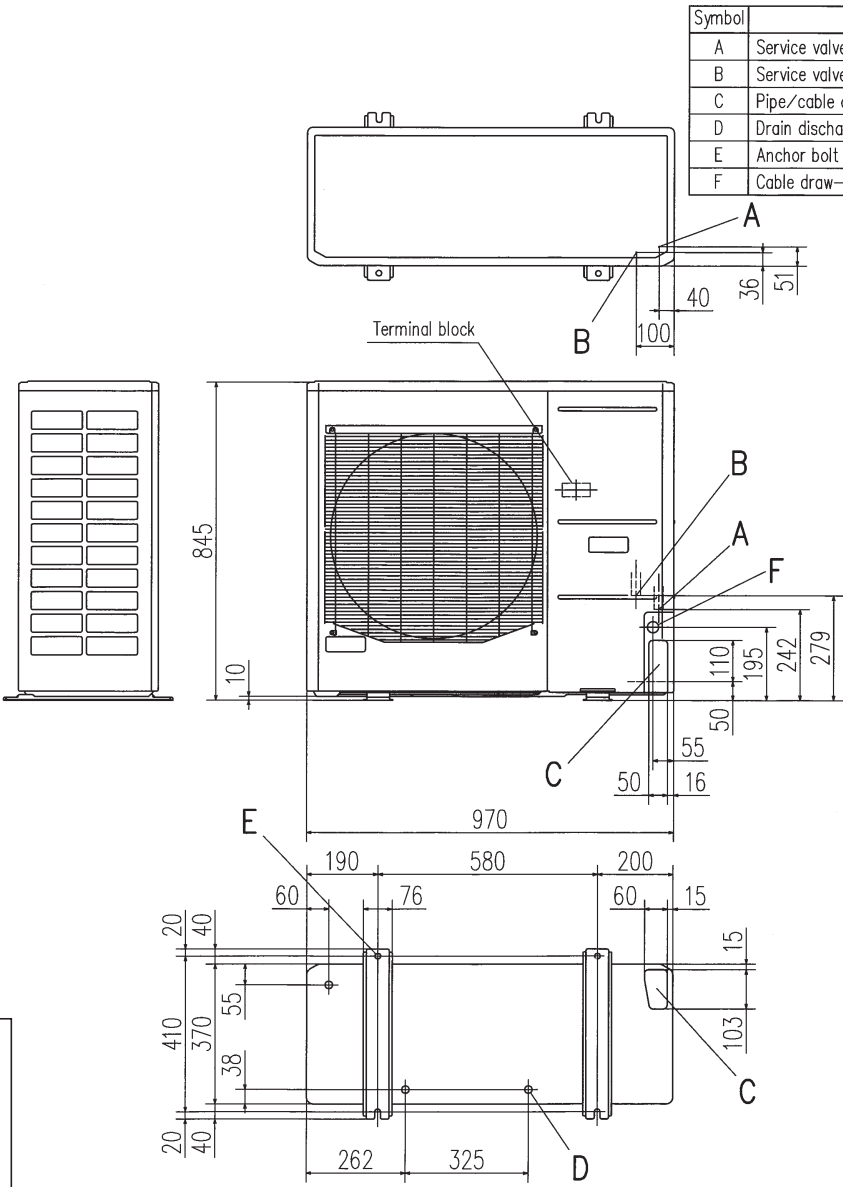

Symbol	Content	
A	Service valve connection (gas side)	φ15.88 (5/8") (Flare)
B	Service valve connection (liquid side)	φ9.52 (3/8") (Flare)
C	Pipe/cable draw-out hole	
D	Drain discharge hole	φ20×3places
E	Anchor bolt hole	M10×4places
F	Cable draw-out hole	φ30×3places

- Notes
- (1) It must not be surrounded by walls on the four sides.
 - (2) The unit must be fixed with anchor bolts. An anchor bolt must not protrude more than 15mm.
 - (3) Where the unit is subject to strong winds, lay it in such a direction that the blower outlet faces perpendicularly to the dominant wind direction.
 - (4) Leave 1m or more space above the unit.
 - (5) A wall in front of the blower outlet must not exceed the units height.
 - (6) The model name label is attached on the lower right corner of the front panel.

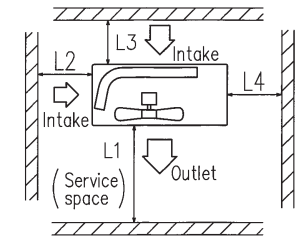
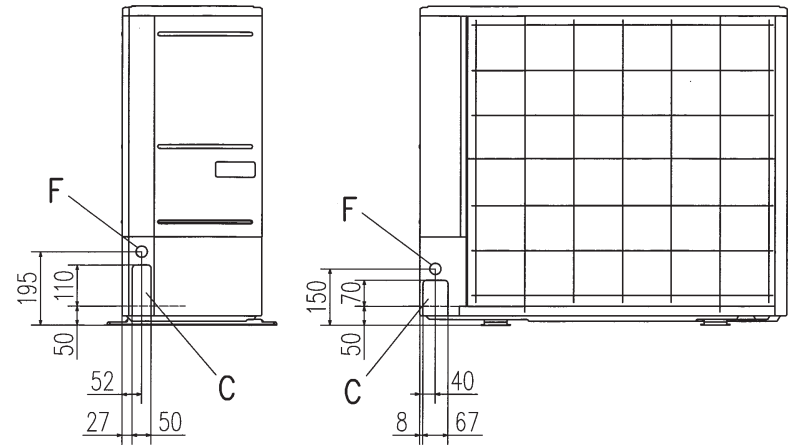

Minimum installation space

Examples of installation Dimensions	I	II	III
L1	Open	Open	500
L2	300	5	Open
L3	150	300	150
L4	5	5	5

Unit: mm

Models FDC100VN, 125VN, 140VN, 100VS, 125VS, 140VS (Service code /L, /M)

PCA001Z536 

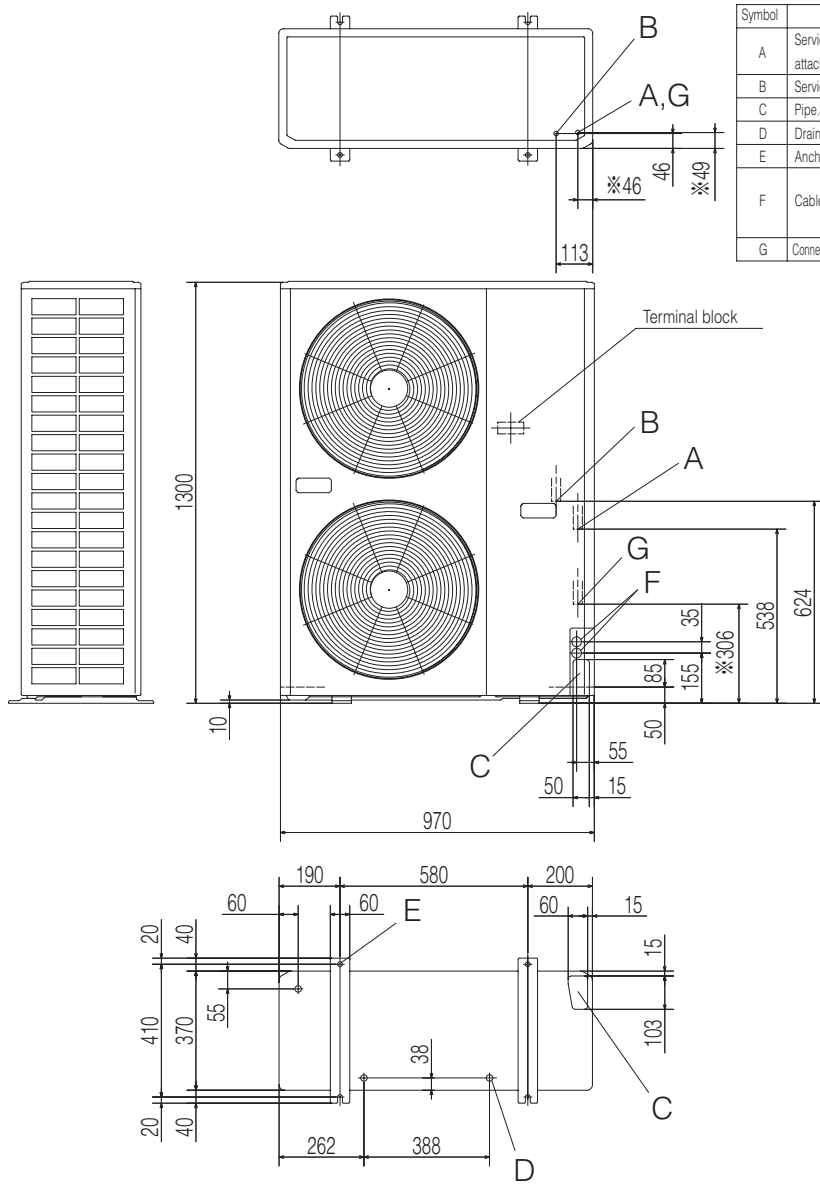

Symbol	Content	
A	Service valve connection of the attached connecting pipe (gas side)	φ19.05(3/4") (Flare)
B	Service valve connection (liquid side)	φ9.52(3/8") (Flare)
C	Pipe / cable draw-out hole	
D	Drain discharge hole	φ20×3places
E	Anchor bolt hole	M10×4places
F	Cable draw-out hole	φ30×2places (front) φ45 (side) φ50 (back)
G	Connecting position of the local pipe. (gas side)	φ22.22(7/8") (Brazing)

Notes

- (1) It must not be surrounded by walls on the four sides.
- (2) The unit must be fixed with anchor bolts. An anchor bolt must not protrude more than 15mm.
- (3) Where the unit is subject to strong winds, lay it in such a direction that the blower outlet faces perpendicularly to the dominant wind direction.
- (4) Leave 1m or more space above the unit.
- (5) A wall in front of the blower outlet must not exceed the units height.
- (6) The model name label is attached on the lower right corner of the front panel.
- (7) Connect the Service valve with local pipe by using the pipe of the attachment. (Gas side only)
- (8) Mark ※ shows the connecting position of the local pipe. (Gas side only)

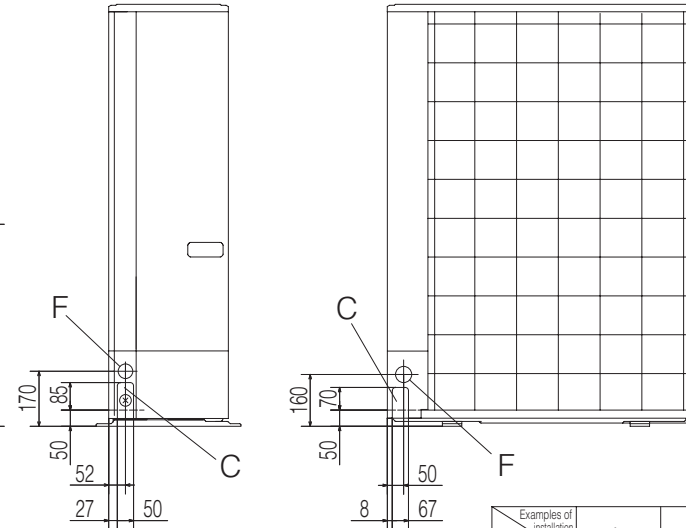

Examples of installation Dimensions	I	II	III
L1	Open	Open	500
L2	300	5	Open
L3	150	300	150
L4	5	5	5

Unit:mm

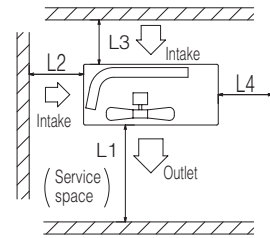

Minimum installation space

Model FDC200VS

PCA001Z537 

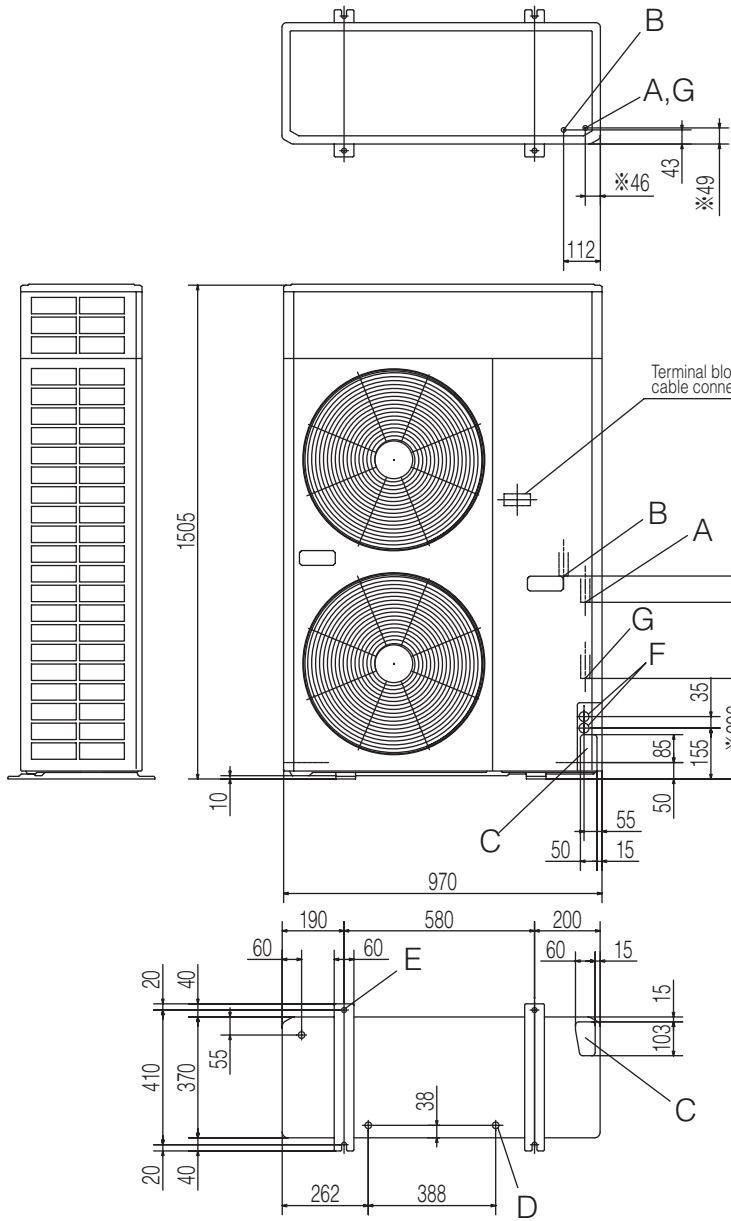

Symbol	Content	
A	Service valve connection of the attached connecting pipe (gas side)	$\phi 19.05 (3/4'')$ (Flare)
B	Service valve connection (liquid side)	$\phi 12.7 (1/2'')$ (Flare)
C	Pipe / cable draw-out hole	
D	Drain discharge hole	$\phi 20 \times 3$ places
E	Anchor bolt hole	M10 \times 4 places
F	Cable draw-out hole	$\phi 30 \times 2$ places (front) $\phi 45$ (side) $\phi 50$ (back)
G	Connecting position of the local pipe. (gas side)	$\phi 22.22 (7/8'')$ (Brazing)

Notes

- (1) It must not be surrounded by walls on the four sides.
- (2) The unit must be fixed with anchor bolts. An anchor bolt must not protrude more than 15mm.
- (3) Where the unit is subject to strong winds, lay it in such a direction that the blower outlet faces perpendicularly to the dominant wind direction.
- (4) Leave 1m or more space above the unit.
- (5) A wall in front of the blower outlet must not exceed the units height.
- (6) The model name label is attached on the lower right corner of the front panel.
- (7) Connect the Service valve with local pipe by using the pipe of the attachment. (Gas side only)
- (8) Mark * shows the connecting position of the local pipe (Gas side only)

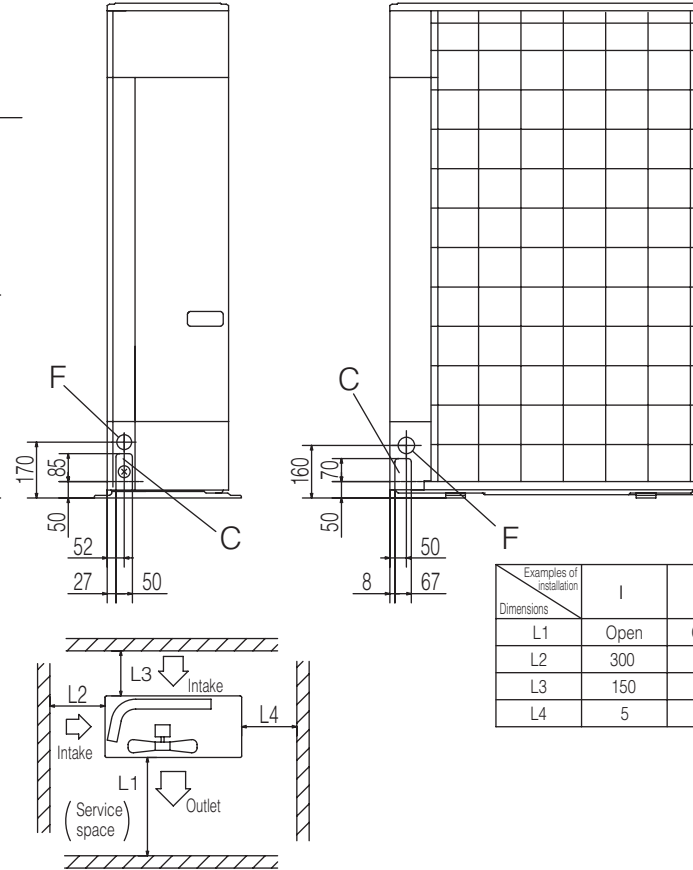

Minimum installation space

Dimensions	Examples of installation		
	I	II	III
L1	Open	Open	500
L2	300	5	Open
L3	150	300	150
L4	5	5	5

Unit:mm

Model FDC250VS

(3) Remote control (Option parts)

(a) Wired remote control

Model : RC-EX1A

Dimensions (Viewed from front)

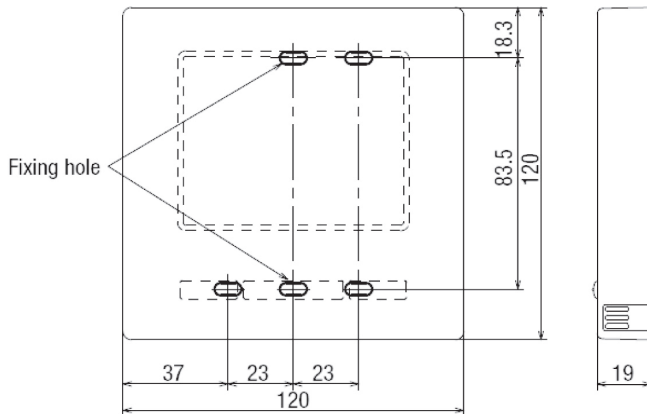

Exterior appearance (Munsell color)	Pearl White (N8.5) near equivalent
--	---------------------------------------

Installation space

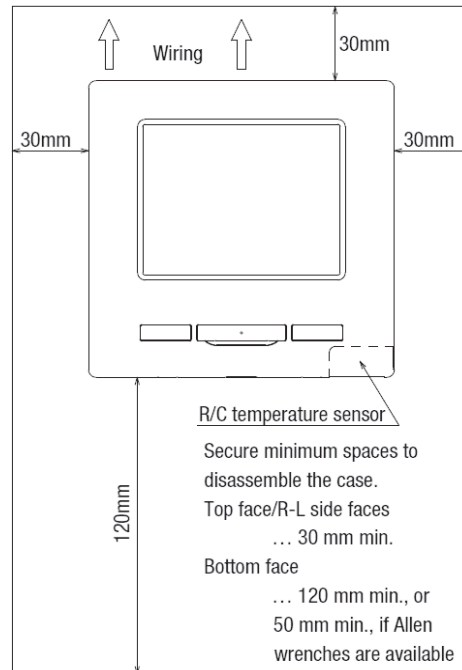

Cautions for selecting installation place

- (1) Installation surface must be flat and sufficiently strong.
R/C case must not be deformed.
- (2) Where the R/C can detect room temperatures accurately
This is a must when detecting room temperatures with the temperature sensor of R/C.
 - Install the R/C where it can detect the average temperature in the room.
 - Install the R/C sufficiently separated from a heat source.
 - Install the R/C where it will not be influenced by the turbulence of air when the door is opened or closed.
 Select a place where the R/C is not exposed to direct sunlight or blown by winds from the air conditioner or temperatures on the wall surface will not deviate largely from indoor air temperatures.

R/C cable: 0.3mm² × 2-core

When the cable length is longer than 100 m, the max size for wires used in the R/C case is 0.5 mm². Connect them to wires of larger size near the outside of R/C. When wires are connected, take measures to prevent water, etc. from entering inside.

< 200 m	0.5 mm ² x 2-core
< 300 m	0.75 mm ² x 2-core
< 400 m	1.25 mm ² x 2-core
< 600 m	2.0 mm ² x 2-core

Adapted to **RoHS** directive

PJZ000Z297

Model RC-E5

Exposed mounting

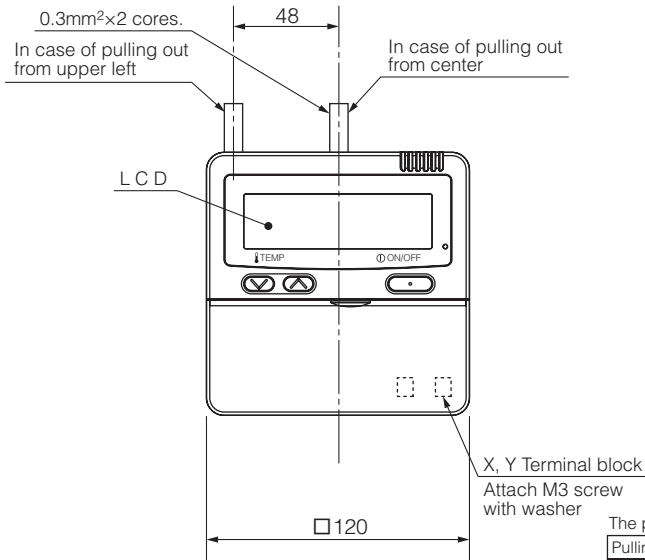

Exterior appearance (Munsell color)	Pearl White (N8.5) near equivalent
-------------------------------------	------------------------------------

Wiring outlet

Cut off the upper thin part of remote control lower case with a nipper or knife, and grind burrs with a file etc.

In case of pulling out from upper left In case of pulling out from center

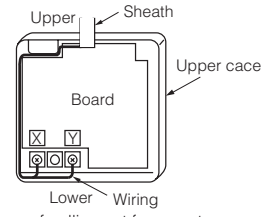
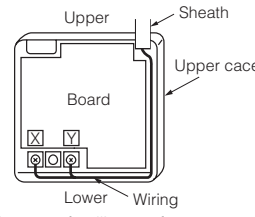
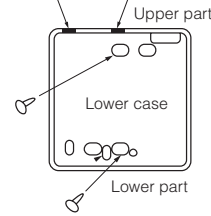

The peeling-off length of sheath	
Pulling out from upper left	Pulling out from center
X wiring : 215mm	X wiring : 170mm
Y wiring : 195mm	Y wiring : 190mm

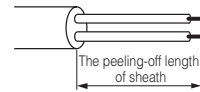

Embedded mounting

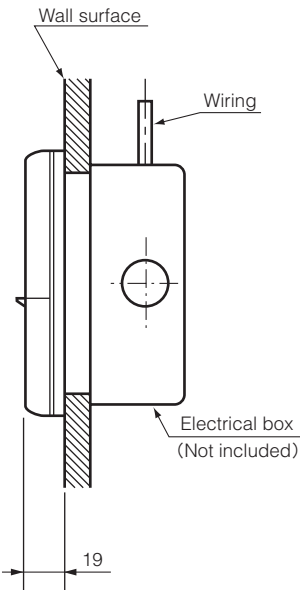

Remote control installation dimensions

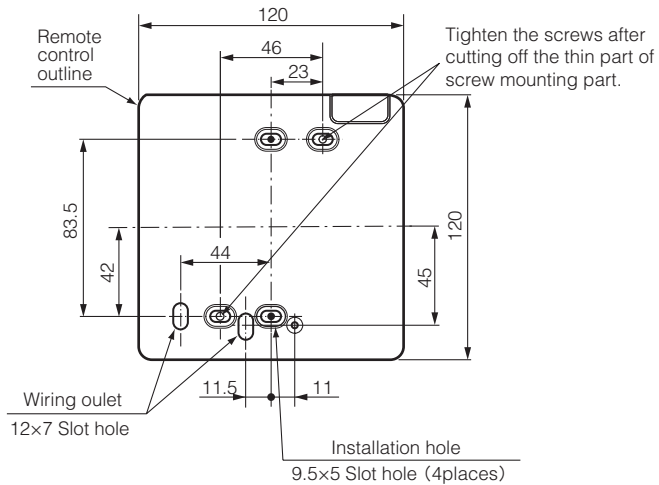

- (1) Installation screw for remote control M4 Screw (2 pieces)

Unit:mm

Wiring specifications

(1) If the prolongation is over 100m, change to the size below. But, wiring in the remote control case should be under 0.5mm². Change the wire size outside of the case according to wire connecting. Waterproof treatment is necessary at the wire connecting section. Be careful about contact failure.

Length	Wiring thickness
100 to 200m	0.5mm²×2 cores
Under 300m	0.75mm²×2 cores
Under 400m	1.25mm²×2 cores
Under 600m	2.0mm²×2 cores

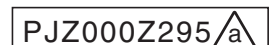

(b) Wireless remote control (RCN-E1R)

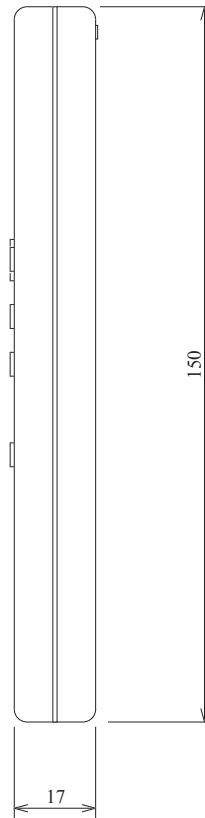
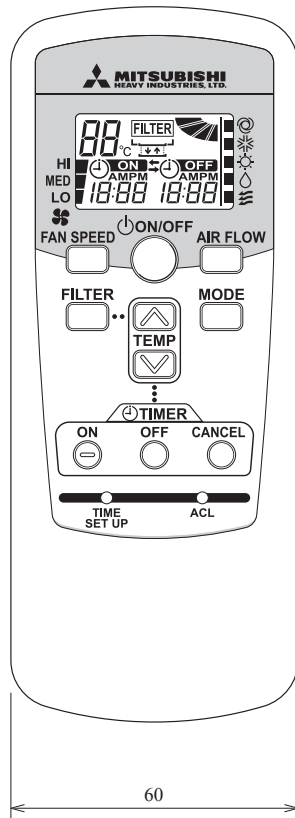

Unit: mm

1.3 ELECTRICAL WIRING

(1) Indoor units

(a) Ceiling cassette-4way type (FDT)

Models FDT50VF, 60VF, 71VF1, 100VF1, 125VF, 140VF, 100VF2

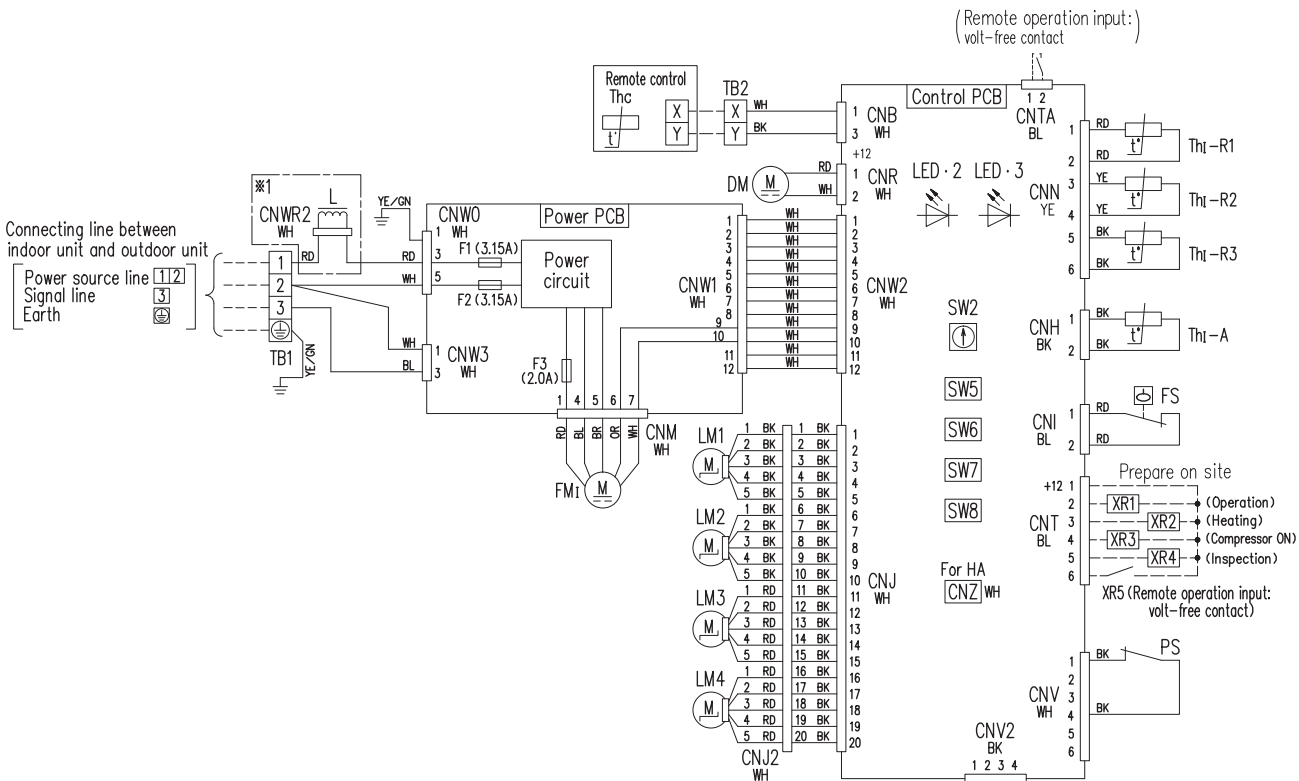

CNB~Z	Connector
DM	Drain motor
F1~3	Fuse
FMi	Fan motor
FS	Float switch
L	Reactor
LED · 2	Indication lamp (Green-Normal operation)
LED · 3	Indication lamp (Red-Inspection)
LM1~4	Louver motor
PS	Panel switch
SW2	Remote control communication address
SW5	Plural units Master/Slave setting
SW6	Model capacity setting
SW7-1	Operation check, Drain motor test run
SW7-3	Powerful mode Valid/Invalid
TB1	Terminal block (Power source) (□mark)
TB2	Terminal block (Signal line) (□mark)
Thc	Thermistor (Remote control)
ThI-A	Thermistor (Return air)
ThI-R1,2,3	Thermistor (Heat exchanger)

Color Marks

Mark	Color	Mark	Color
BK	Black	RD	Red
BL	Blue	WH	White
BR	Brown	YE	Yellow
OR	Orange	YE/GN	Yellow/Green

- Notes
1. ---- indicates wiring on site.
 2. See the wiring diagram of outside unit about the line between inside unit and outside unit.
 3. Use twin core cord (0.3mm²×2) at remote control line.
 4. Do not put remote control line alongside power source line.
 5. Section 1 (※1) is provided on the models 100 - 140 only.

PJF000Z286



CNB~Z	Connector
DM	Drain motor
F200~203	Fuse
FM1	Fan motor
FS	Float switch
LED-2	Indication lamp (Green-Normal operation)

LED-3	Indication lamp (Red-Inspection)
LM1~4	Louver motor
SW2	Remote control communication address
SW5	Plural units Master/Slave setting
SW6	Model capacity setting
SW7-1	Operation check, Drain motor test run

TB1	Terminal block (Power source) (□ mark)
TB2	Terminal block (Signal line) (□ mark)
Thc	Thermistor (Remote control)
Th-A	Thermistor (Return air)
Th-R1,2,3	Thermistor (Heat exchanger)
X4	Relay for DM
■ mark	Closed-end connector

Color Marks

Mark	Color
BK	Black
BL	Blue
BR	Brown
OR	Orange
RD	Red
WH	White
Y	Yellow
Y/GN	Yellow/Green

(b) Ceiling cassette-4 way compact type (FDTC)
Models FDTC50VF, 60VF

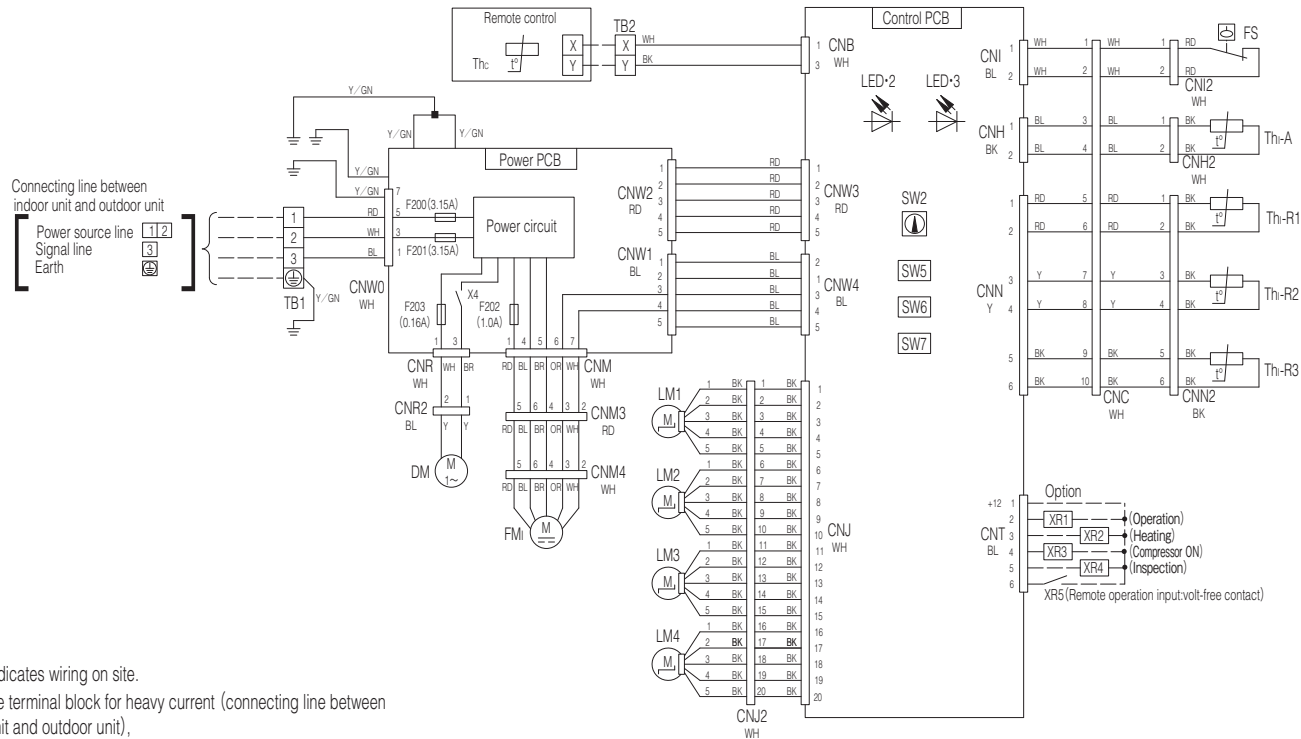

- Notes
1. — indicates wiring on site.
 2. TB1 is the terminal block for heavy current (connecting line between indoor unit and outdoor unit), and TB2 is the terminal block for weak current (remote control).
 3. See the wiring diagram of outside unit about the line between inside unit and outside unit.
 4. Use twin core cable (0.3mm²X2) at remote control line.
 5. Do not put remote control line alongside power source line.

PJA003Z340

(c) Ceiling suspended type (FDEN)
Model FDEN50VF

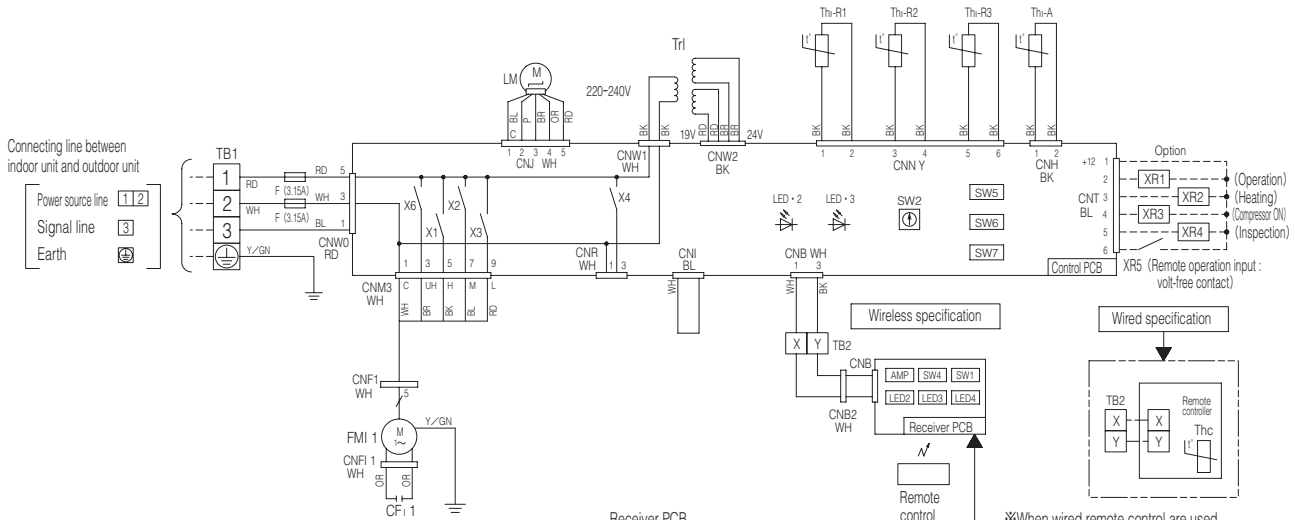

Receiver PCB	
LED2	Indication lamp (Green-Normal operation)
LED3	Indication lamp (Yellow-Timer / Inspection)
LED4	7-segment display
SW1	Switches for setting
SW4	Back-up switch (Operation / Stop)

※When wired remote control are used only (wireless type) It is necessary to remove the line that is connected to the receiver. Remove signal line connected to the receiver from primary side of terminal block (X, Y).

ATTENTION
① Insulate with tape the removed line.
② The LED of that removed connector will not be able to make any indication.

CF1 1	Capacitor for FMI
CNB~Z	Connector
F	Fuse
FMI 1	Fan motor (with thermostat)
LED・2	Indication lamp (Green-Normal operation)
LED・3	Indication lamp (Red-Inspection)
LM	Louver motor
SW2	Remote control communication address
SW5	Plural units Master / Slave setting
SW6	Model capacity setting
SW7-1	Operation check, Drain motor test run
TB1	Terminal block (Power source) (□mark)
TB2	Terminal block (Signal line) (□mark)
Thc	Thermistor (Remote control)
Thi-A	Thermistor (Return air)
Thi-R1,2,3	Thermistor (Heat exchanger)
X1~3,6	Relay for FM
X4	Relay for DM

Color Marks

Mark	Color	Mark	Color
BK	Black	RD	Red
BL	Blue	WH	White
BR	Brown	Y	Yellow
OR	Orange	Y/GN	Yellow / Green
P	Pink		

- Notes 1. --- indicates wiring on site.
2. See the wiring diagram of outside unit about the line between indoor unit and outdoor unit.
3. Use twin core cable (0.3mm²X2) at remote control line.
4. Do not put remote control line alongside power source line.

PFA003Z819/B

PFA003Z820/D

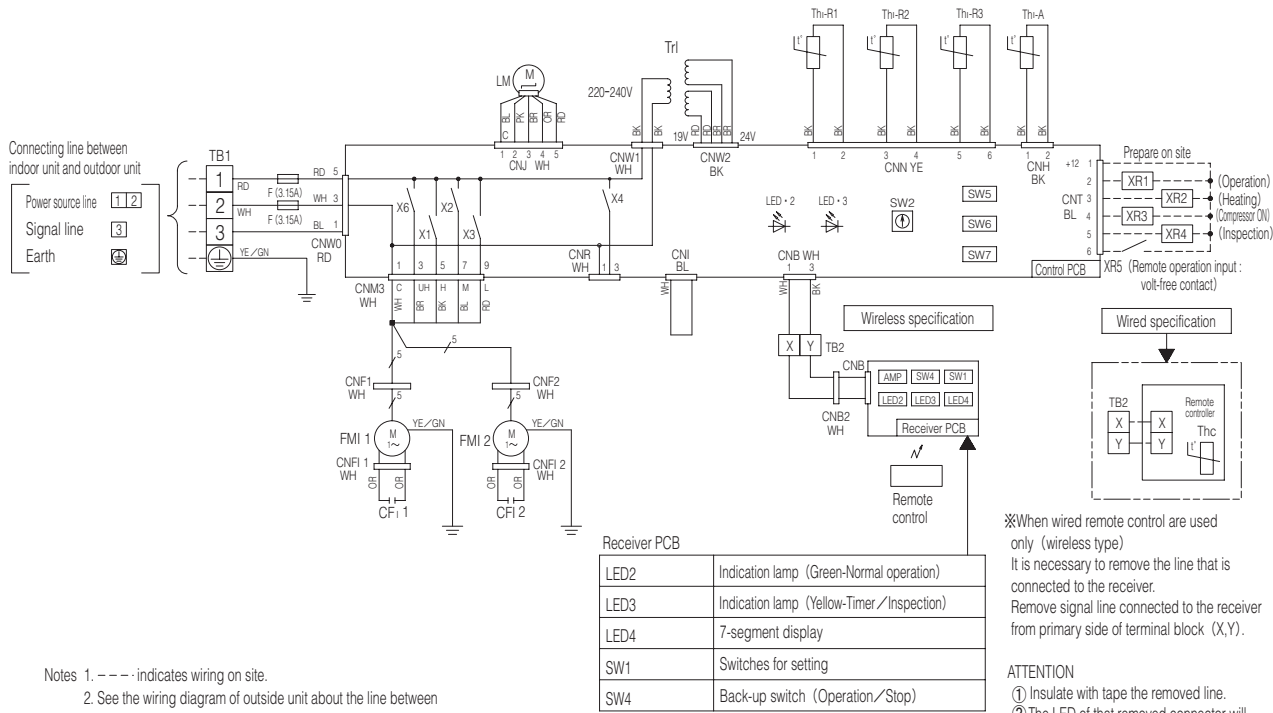

- Notes
1. - - - - indicates wiring on site.
 2. See the wiring diagram of outside unit about the line between indoor unit and outdoor unit.
 3. Use twin core cable (0.3mm²X2) at remote control line.
 4. Do not put remote control line alongside power source line.

※When wired remote control are used only (wireless type)
It is necessary to remove the line that is connected to the receiver.
Remove signal line connected to the receiver from primary side of terminal block (X,Y).

ATTENTION
① Insulate with tape the removed line.
② The LED of that removed connector will not be able to make any indication.

CF1 1,2	Capacitor for FMI
CNB~Z	Connector
F	Fuse
FMI 1,2	Fan motor (with thermistor)
LED・2	Indication lamp (Green-Normal operation)
LED・3	Indication lamp (Red-Inspection)
LM	Louver motor
SW2	Remote control communication address
SW5	Plural units Master/Slave setting
SW6	Model capacity setting
SW7-1	Operation check, Drain motor test run
TB1	Terminal block (Power source) (□mark)
TB2	Terminal block (Signal line) (□mark)
Thc	Thermistor (Remote control)
ThI-A	Thermistor (Return air)
ThI-R1,2,3	Thermistor (Heat exchanger)
Tr1	Transformer
X1~3,6	Relay for FM
X4	Relay for DM
■mark	Closed-end connector

Color Marks

Mark	Color	Mark	Color
BK	Black	RD	Red
BL	Blue	WH	White
BR	Brown	YE	Yellow
OR	Orange	YE/GN	Yellow/Green
PK	Pink		

Models PDEN60VF, 71VF1, 100VF1, 125VF, 140VF

Connecting line between indoor unit and outdoor unit

Power source line	1 2
Signal line	3
Earth	⊕

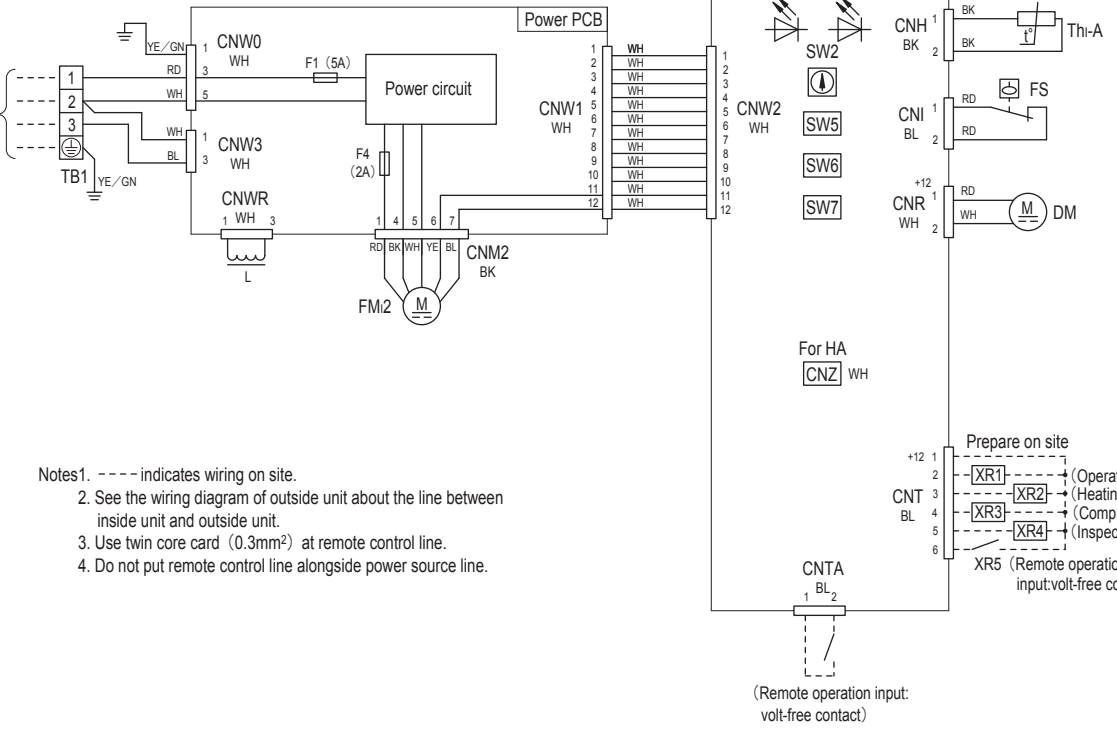

- Notes1. ---- indicates wiring on site.
 2. See the wiring diagram of outside unit about the line between inside unit and outside unit.
 3. Use twin core card (0.3mm²) at remote control line.
 4. Do not put remote control line alongside power source line.

CNB~Z	Connector
DM	Drain motor
F1,4	Fuse
FM2	Fan motor
FS	Float switch
L	Reactor
LED · 2	Indication lamp (Green-Normal operation)
LED · 3	Indication lamp (Red-Inspection)
SW2	Remote control communication address
SW5	Plural units Master/Slave setting
SW6	Model capacity setting
SW7-1	Operation check, Drain motor test run
SW7-3	Powerful mode Valid/Invalid
TB1	Terminal block (Power source) (□mark)
TB2	Terminal block (Signal line) (□mark)
Thc	Thermistor (Remote control)
Thi-A	Thermistor (Return air)
Thi-R1,2,3	Thermistor (Heat exchanger)

Color Marks

Mark	Color	Mark	Color
BK	Black	RD	Red
BL	Blue	WH	White
YE	Yellow	YE/GN	Yellow/Green

PJG000Z049

(c) Duct connected-High static pressure type (FDU)
 Model FDU71VF1

Connecting line between indoor unit and outdoor unit

Power source line 1,2
Signal line 3
Earth

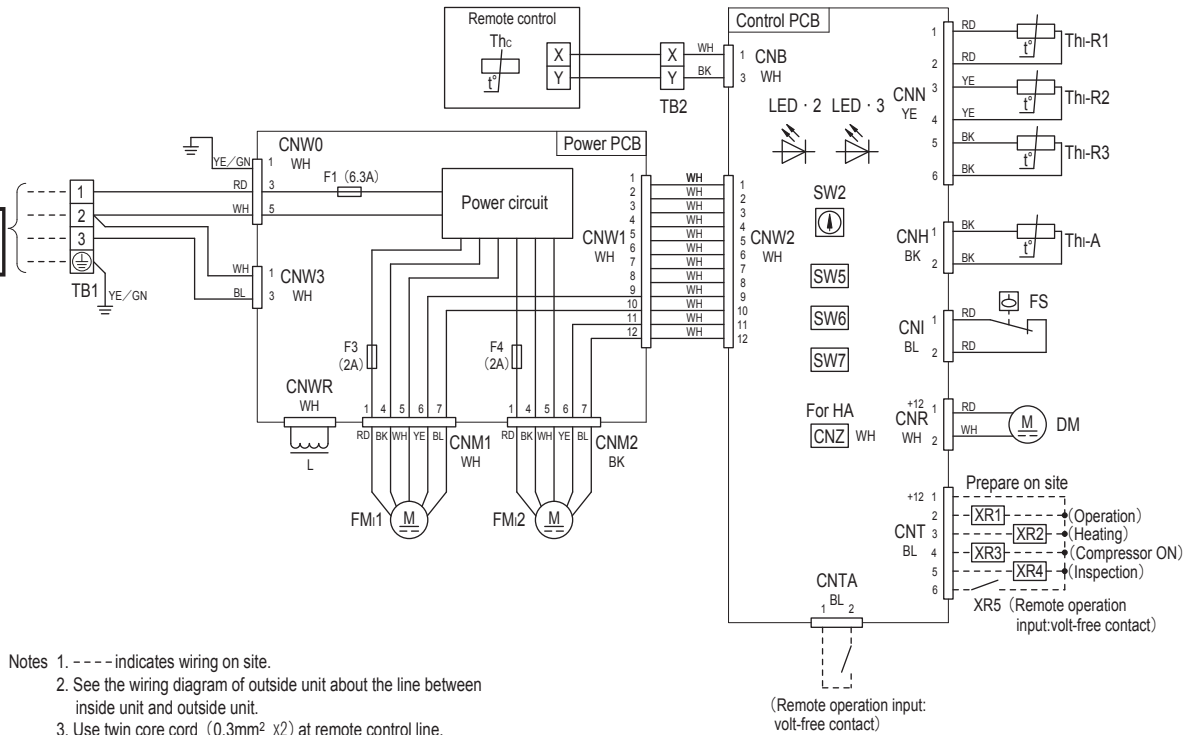

- Notes
1. --- indicates wiring on site.
 2. See the wiring diagram of outside unit about the line between inside unit and outside unit.
 3. Use twin core cord (0.3mm² x2) at remote control line.
 4. Do not put remote control line alongside power source line.

CNB~Z	Connector
DM	Drain motor
F1,3,4	Fuse
FM1,2	Fan motor (with thermostat)
FS	Float switch
L	Reactor
LED · 2	Indication lamp (Green-Normal operation)
LED · 3	Indication lamp (Red-Inspection)
SW2	Remote control communication address
SW5	Plural units Master/Slave setting
SW6	Model capacity setting
SW7-1	Operation check, Drain motor test run
SW7-3	Powerful mode Valid/Invalid
TB1	Terminal block (Power source) (□mark)
TB2	Terminal block (Signal line) (□mark)
Thc	Thermistor (Remote control)
Th-A	Thermistor (Return air)
Th-R1,2,3	Thermistor (Heat exchanger)

Color Marks

Mark	Color	Mark	Color
BK	Black	RD	Red
BL	Blue	WH	White
YE	Yellow	YE/GN	Yellow/Green

Models FDU100VF1, 125VF, 140VF, 100VF2



Color Marks

Mark	Color	Mark	Color
BK	Black	P	Pink
BL	Blue	RD	Red
BR	Brown	WH	White
GR	Gray	Y	Yellow
OR	Orange	Y/GN	Yellow / Green

Connecting line between indoor unit and outdoor unit

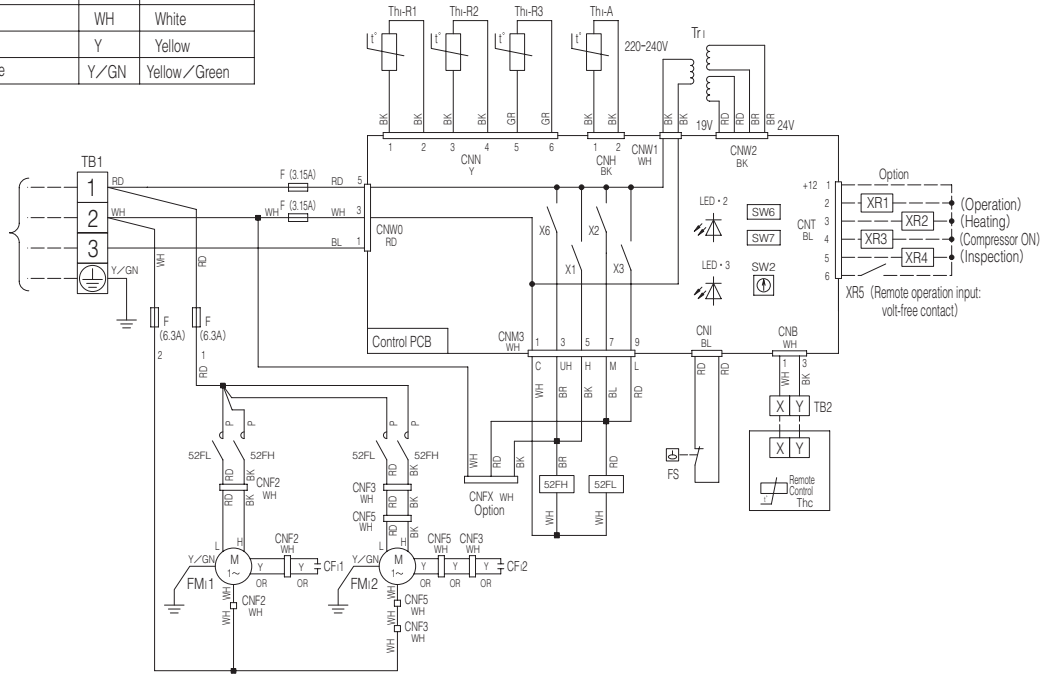
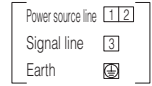

CF1,2	Capacitor for FMI
CNB~Z	Connector
F	Fuse
FC	Fan controller
FMI 1,2	Fan motor (with thermostat)
FS	Float switch
LED • 2	Indication lamp (Green-Normal operation)
LED • 3	Indication lamp (Red-Inspection)
SW2	Remote control communication address
SW6	Model capacity setting
SW7-1	Operation check, Drain motor test run
TB1	Terminal block (Power source) (□mark)
TB2	Terminal block (Signal line) (□mark)
Thc	Thermistor (Remote control)
Thl -A	Thermistor (Return air)
Thl -R1,2,3	Thermistor (Heat exchanger)
Tr1	Transformer
X1~3,6	Relay for FM
■mark	Closed-end connector
52FL_FH	Electromagnetic contactor for FMI

- Notes
- indicates wiring on site.
 - See the wiring diagram of outside unit about the line between inside unit and outside unit.
 - Use twin core cable (0.3mm²X2) at remote control line.
 - Do not put remote control line alongside power source line.

PJD001Z218



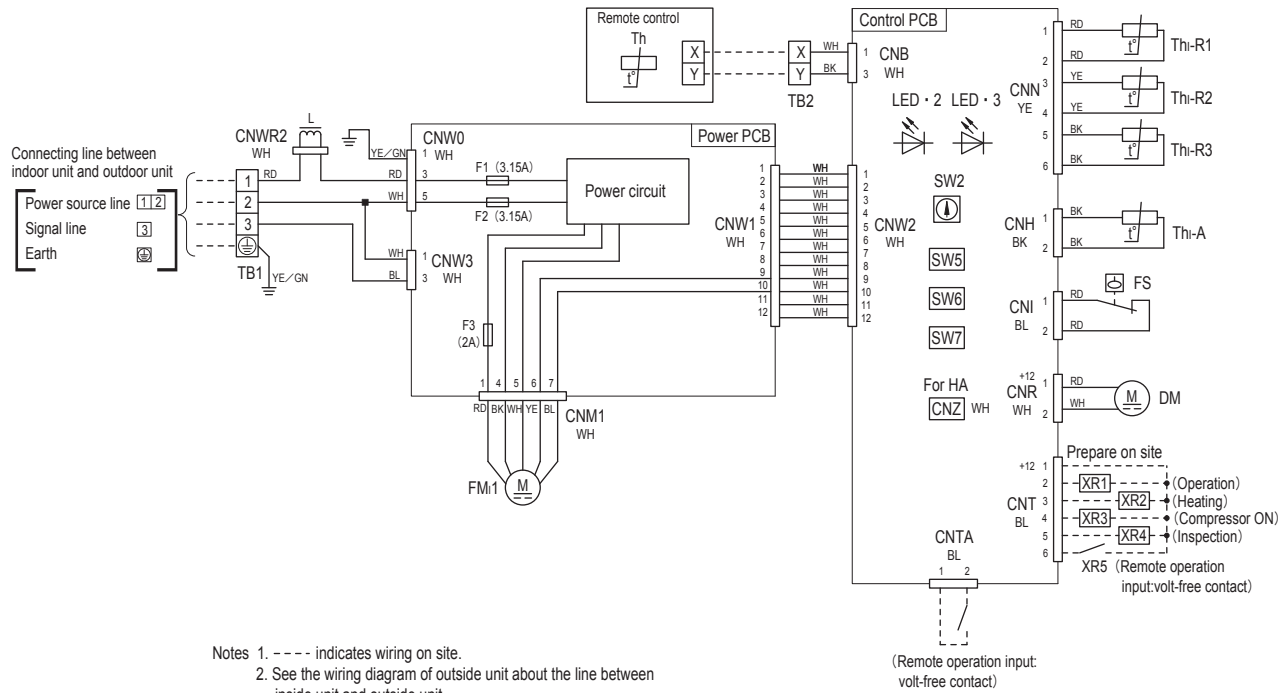

CNB~Z	Connector
DM	Drain motor
F1~3	Fuse
FM1	Fan motor (with thermostat)
FS	Float switch
L	Reactor
LED · 2	Indication lamp (Green-Normal operation)
LED · 3	Indication lamp (Red-Inspection)
SW2	Remote control communication address
SW5	Plural units Master/Slave setting
SW6	Model capacity setting
SW7-1	Operation check, Drain motor test run
SW7-3	Powerful mode Valid/Invalid
TB1	Terminal block [Power source] (□mark)
TB2	Terminal block [Signal line] (□mark)
Thc	Thermistor (Remote control)
Thi-A	Thermistor (Return air)
Thi-R1,2,3	Thermistor (Heat exchanger)
■mark	Closed-end connector

Color Marks

Mark	Color	Mark	Color
BK	Black	RD	Red
BL	Blue	WH	White
BR	Brown	YE	Yellow
OR	Orange	YE/GN	Yellow/Green

(e) Duct connected-Low / Middle static pressure type (FDUM)
Model FDUM50VF

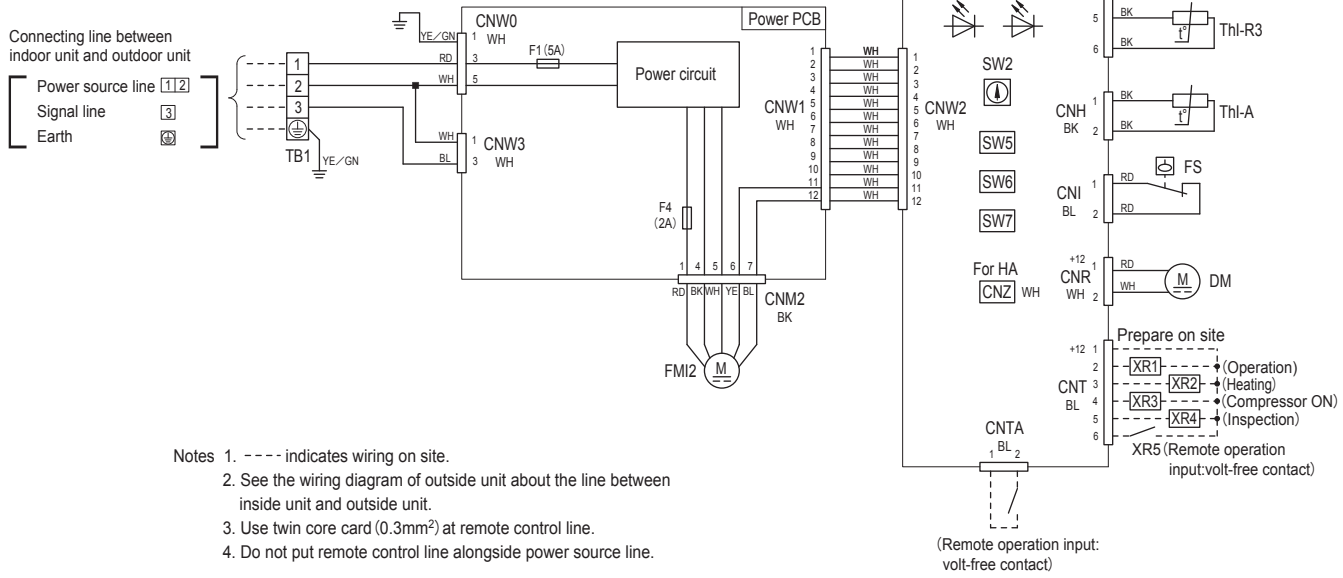

CNB~Z	Connector
DM	Drain motor
F1,4	Fuse
FMI2	Fan motor (with thermostat)
FS	Float switch
LED · 2	Indication lamp (Green-Normal operation)
LED · 3	Indication lamp (Red-Inspection)
SW2	Remote control communication address
SW5	Plural units Master/Slave setting
SW6	Model capacity setting
SW7-1	Operation check, Drain motor test run
SW7-3	Powerful mode Valid/Invalid
TB1	Terminal block (Power source) (□mark)
TB2	Terminal block (Signal line) (□mark)
Thc	Thermistor (Remote control)
Thl-A	Thermistor (Return air)
Thl-R1,2,3	Thermistor (Heat exchanger)
■ mark	Closed-end connector

Color Marks

Mark	Color	Mark	Color
BK	Black	RD	Red
BL	Blue	WH	White
BR	Brown	YE	Yellow
OR	Orange	YE/GN	Yellow/Green

Model FDUM71VF1

PJG000Z028 A

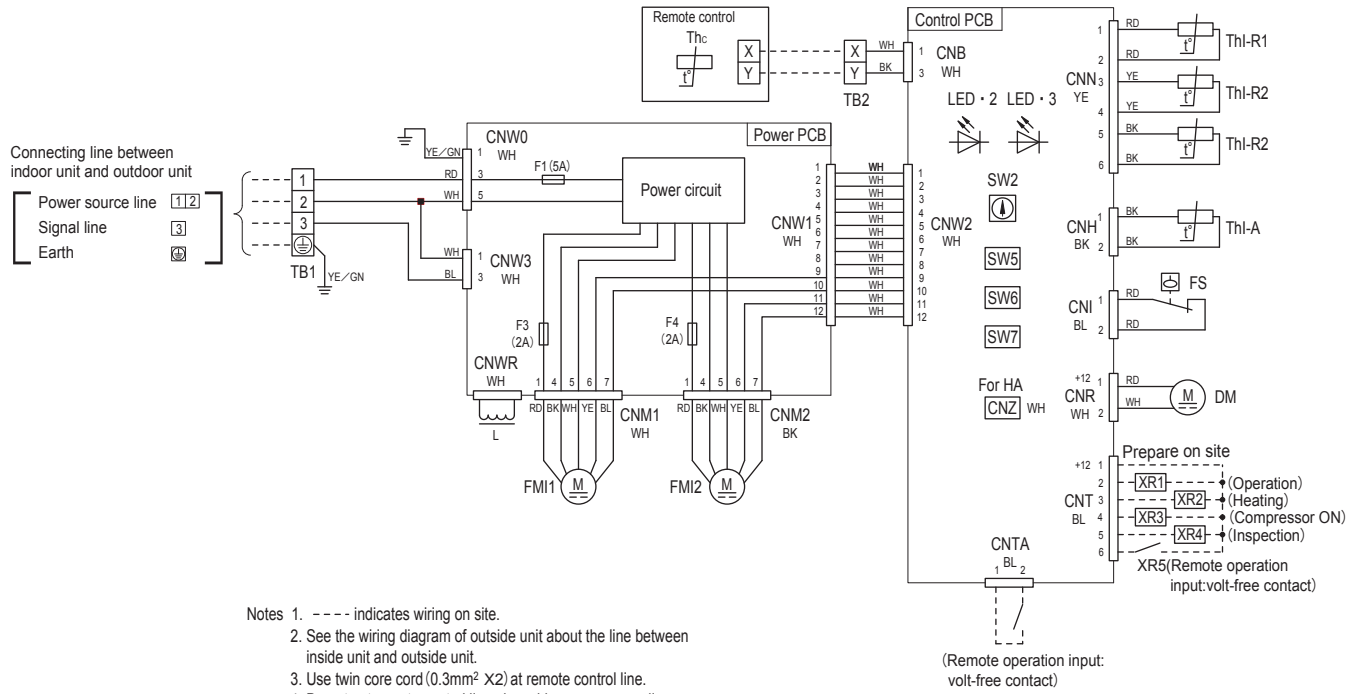

CNB~Z	Connector
DM	Drain motor
F1,3,4	Fuse
FM1,2	Fan motor (with thermostat)
FS	Float switch
L	Reactor
LED · 2	Indication lamp (Green-Normal operation)
LED · 3	Indication lamp (Red-Inspection)
SW2	Remote control communication address
SW5	Plural units Master/Slave setting
SW6	Model capacity setting
SW7-1	Operation check, Drain motor test run
SW7-3	Powerful mode Valid/Invalid
TB1	Terminal block (Power source) (□mark)
TB2	Terminal block (Signal line) (□mark)
Thc	Thermistor (Remote control)
Thi-A	Thermistor (Return air)
Thi-R1,2,3	Thermistor (Heat exchanger)
■mark	Closed-end connector

Color Marks

Mark	Color	Mark	Color
BK	Black	RD	Red
BL	Blue	WH	White
BR	Brown	YE	Yellow
OR	Orange	YE/GN	Yellow/Green

Color Marks

Mark	Color	Mark	Color	Mark	Color
BK	Black	GR	Gray	WH	White
BL	Blue	OR	Orange	YE	Yellow
BR	Brown	RD	Red	YE/GN	Yellow/Green

CNB~Z	Connector
F200~203	Fuse
FMI	Fan motor
L	Reactor
LED · 2	Indication lamp (Green-Normal operation)
LED · 3	Indication lamp (Red-Inspection)
LM	Louver motor
SW2	Remote control communication address

SW5	Plural units Master/Slave setting
SW6	Model capacity setting
SW7- 1	Operation check, Drain motor test run
TB1	Terminal block (Power source) (□ mark)
TB2	Terminal block (Signal line) (□ mark)
Thc	Thermistor (Remote control)
Thl-A	Thermistor (Return air)
Thl-R1,2,3	Thermistor (Heat exchanger)
X4	Relay for DM

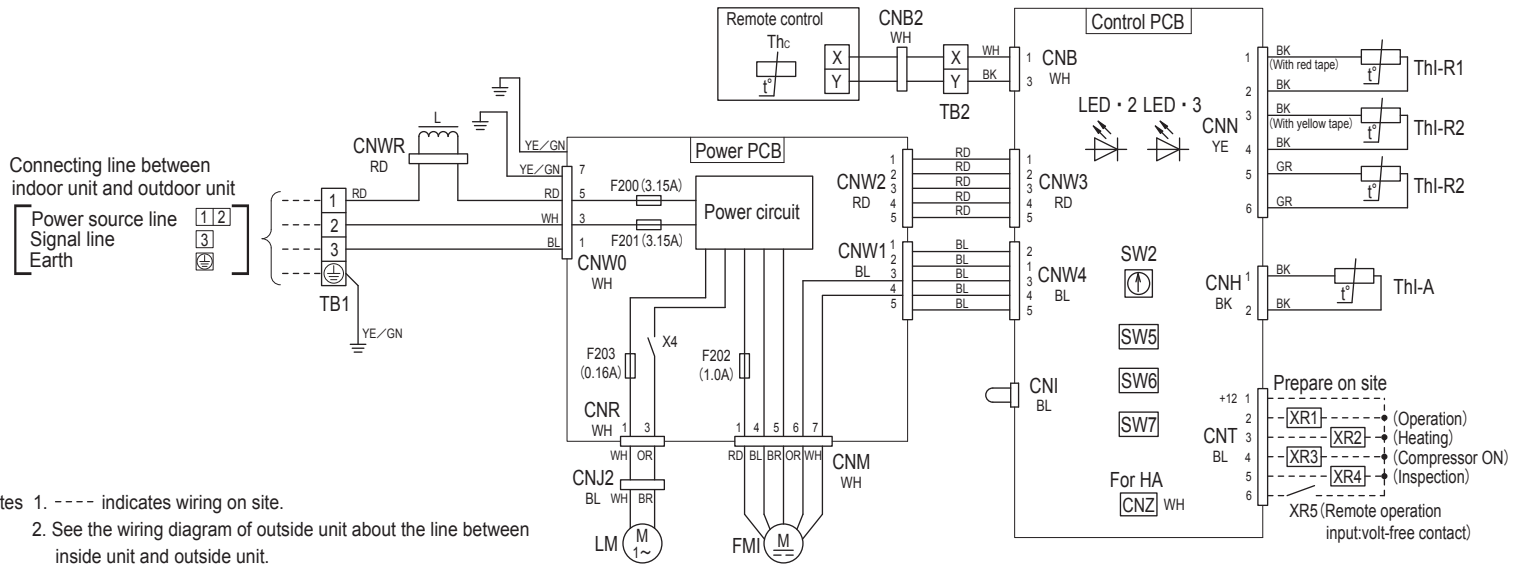

(f) Floor standing type (FDF)
Models FDF71VD1, 100VD1, 125VD, 140VD, 100VD2

RKY000Z058

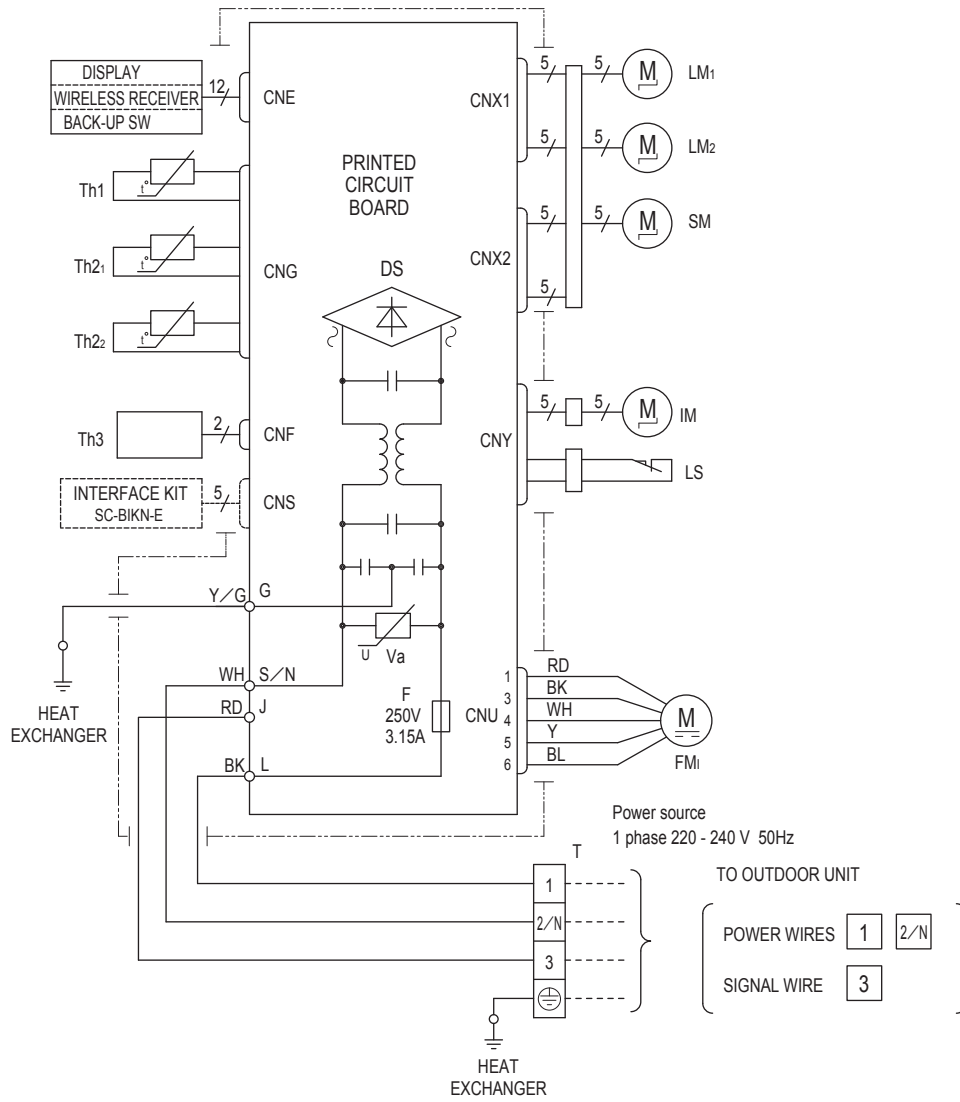

Item	Description
CNE-CNY	Connector
FM _i	Fan motor
SM	Flap motor
LM _{1,2}	Louver motor
IM	Inlet motor
Th1	Room temp. sensor
Th _{2,2}	Heat exch. sensor
Th3	Humidity sensor
LS	Limit switch
DS	Diode stack
F	Fuse
T	Terminal block
Va	Varistor

Color Marks

Mark	Color
BK	Black
BL	Blue
RD	Red
WH	White
Y	Yellow
Y/G	Yellow/Green

(g) Wall mounted type (SRK)
Models SRK50ZMX-S, 60ZMX-S

(2) Outdoor units
Models FDC100VN, 125VN, 140VN

POWER SOURCE 1~220-240V 50Hz / 1~220V 60Hz

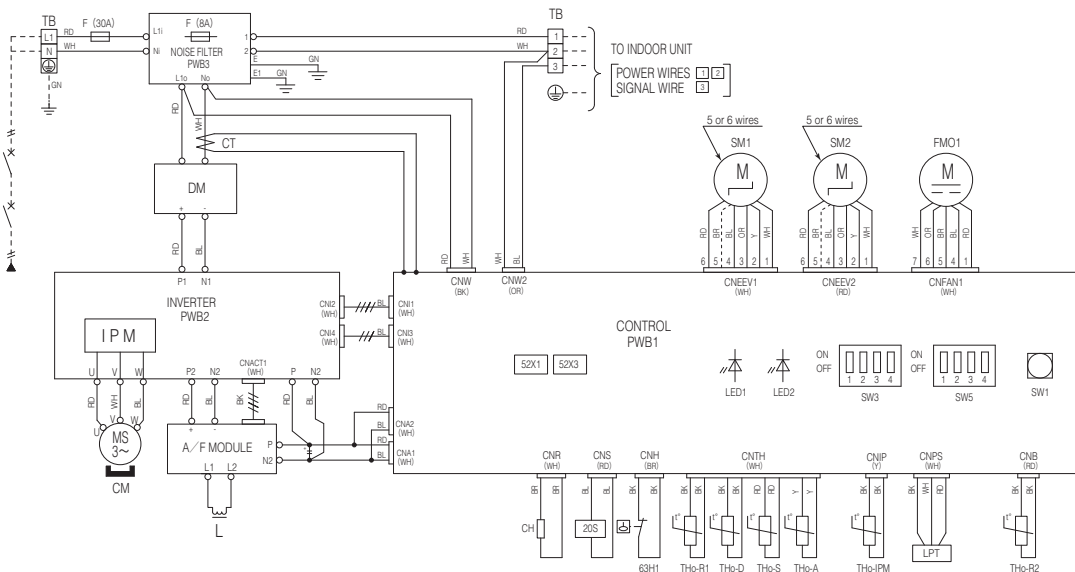

Mark	Color
BK	Black
BL	Blue
BR	Brown
GN	Green
GR	Gray
P	Pink
OR	Orange
RD	Red
WH	White
Y	Yellow
Y/GN	Yellow/Green

Item	Description
CnA~Z	Connector
CH	Crankcase heater
CM	Compressor motor
CT	Current sensor
DM	Diode module
F	Fuse
FMO1	Fan motor
IPM	Intelligent power module
L	Reactor
LED1	Indication lamp (GREEN)
LED2	Indication lamp (RED)
LPT	Low pressure sensor
SM1	Expansion valve for cooling
SM2	Expansion valve for heating
SW1	Pump down switch
SW3.5	Local setting switch
TB	Terminal block
THo-A	Thermistor (Outdoor air temp.)
THo-D	Thermistor (Discharge pipe temp.)
THo-IPM	Thermistor (IPM)
THo-R1,2	Thermistor (-Heat exchanger pipe temp.)
THo-S	Thermistor (Suction pipe temp.)
20S	Solenoid valve for 4 way valve
52X1	Auxilliary relay (for CH)
52X3	Auxilliary relay (for 20S)
63H1	High pressure switch

Power cable, indoor-outdoor connecting wires

Model	MAX over current (A)	Power cable size (mm ²)	Power cable length (m)	indoor-outdoor wire size x number	Earth wire size (mm)
100	24	5.5	25	φ 1.6mm x 3	φ 1.6
125					
140					

※At the connection with the duct type indoor unit.

Model	MAX over current (A)	Power cable size (mm ²)	Power cable length (m)	indoor-outdoor wire size x number	Earth wire size (mm)
100	25	5.5	24	φ 1.6mm x 3	φ 1.6
125	27		22		
140	28		8		

- The specifications shown in the above table are for units without heaters. For units with heaters, refer to the installation instructions or the construction instructions of the indoor unit.
- Switchgear of Circuit breaker capacity which is calculated from MAX. over current should be chosen along the regulations in each country.
- The cable specifications are based on the assumption that a metal or plastic conduit is used with no more than three cables contained in a conduit and a voltage drop is 2%. For an installation falling outside of these conditions, please follow the internal cabling regulations. Adapt it to the regulation in effect in each country.

Local setting switch SW3 (Set up at shipment OFF)

SW3-1	Defrost control change	The defrosting operation interval becomes shorter by turning ON this switch. This switch should be turned ON in the area where outside temperature becomes below the freezing point.
SW3-2	Snow guard fan control	When this switch is turned ON, the outdoor unit fan will run for 30 seconds in every 10 minutes, when outdoor temperature falls to 3°C or lower and the compressor is not running when the unit is used in a very snowy country, set this switch to ON.
SW3-3,4	Trial operation	Method of trial operation ① Trial operation can be performed by using SW3-3,4. ② Compressor will be in the operation when SW3-3 is ON. ③ Cooling trial operation will be performed when SW3-4 is OFF, and heating trial operation when SW3-4 is ON. ④ Be sure to turn OFF SW3-3 after the trial operation is finished.

PCA001Z539

POWER SOURCE 3N~380-415V 50Hz

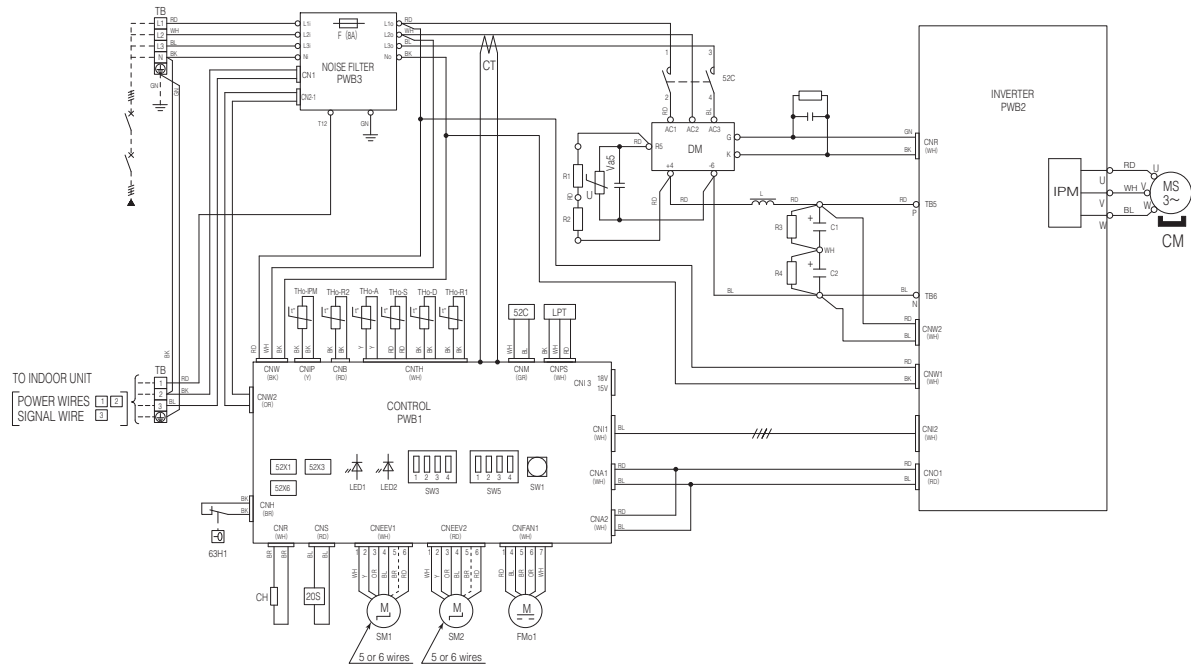

Mark	Color
BK	Black
BL	Blue
BR	Brown
GR	Gray
OR	Orange
RD	Red
WH	White
Y	Yellow
Y / GN	Yellow./ Green

Item	Description
CnA~Z	Connector
CH	Crankcase heater
CM	Compressor motor
CT	Current sensor
DM	Diode module
F	Fuse
FM01	Fan motor
IPM	Intelligent power module
L	Reactor
LED1	Indication lamp (GREEN)
LED2	Indication lamp (RED)
LPT	Low pressure sensor
SM1	Expansion valve for cooling
SM2	Expansion valve for heating
SW1	Pump down switch
SW3,5	Local setting switch
TB	Terminal block
THo-A	Thermistor (Outdoor air temp.)
THo-D	Thermistor (Discharger pipe temp.)
THo-IPM	Thermistor (IPM)
THo-R1,2	Thermistor (Heat exchanger pipe temp.)
THo-S	Thermistor (Suction pipe temp.)
20S	Solenoid valve for 4 way valve
52X1	Auxiliary relay (for CH)
52X3	Auxiliary relay (for 20S)
52X6	Auxiliary relay (for 52C)
63H1	High pressure switch

Power cable, indoor-outdoor connecting wires

Model	MAX over current (A)	Power cable size (mm ²)	Power cable length (m)	indoor-outdoor wire size x number	Earth wire size (mm)
100	15	3.5	27	φ 1.6mm x 3	φ 1.6
125					
140					

※At the connection with the duct type indoor unit.

Model	MAX over current (A)	Power cable size (mm ²)	Power cable length (m)	indoor-outdoor wire size x number	Earth wire size (mm)
100	16	3.5	26	φ 1.6mm x 3	φ 1.6
125	18		23		
140	19		21		

- The specifications shown in the above table are for units without heaters. For units with heaters, refer to the installation instructions or the construction instructions of the indoor unit.
- Switchgear of Circuit breaker capacity which is calculated from MAX. over current should be chosen along the regulations in each country.
- The cable specifications are based on the assumption that a metal or plastic conduit is used with no more than three cables contained in a conduit and a voltage drop is 2%. For an installation falling outside of these conditions, please follow the internal cabling regulations. Adapt it to the regulation in effect in each country.

Local setting switch SW3 (Set up at shipment OFF)

SW3-1	Defrost control change	The defrosting operation interval becomes shorter by turning ON this switch. This switch should be turned ON in the area where outside temperature becomes below the freezing point.
SW3-2	Snow guard fan control	When this switch is turned ON, the outdoor unit fan will run for 30 seconds in every 10 minutes, when outdoor temperature falls to 3°C or lower and the compressor is not running when the unit is used in a very snowy country, set this switch to ON.
SW3-3,4	Trial operation	Method of trial operation ① Trial operation can be performed by using SW3-3,4. ② Compressor will be in the operation when SW3-3 is ON. ③ Cooling trial operation will be performed when SW3-4 is OFF, and heating trial operation when SW3-4 is ON. ④ Be sure to turn OFF SW3-3 after the trial operation is finished.

PCA001Z540

Models FDC100VS, 125VS, 140VS

13 • PAC-T-198

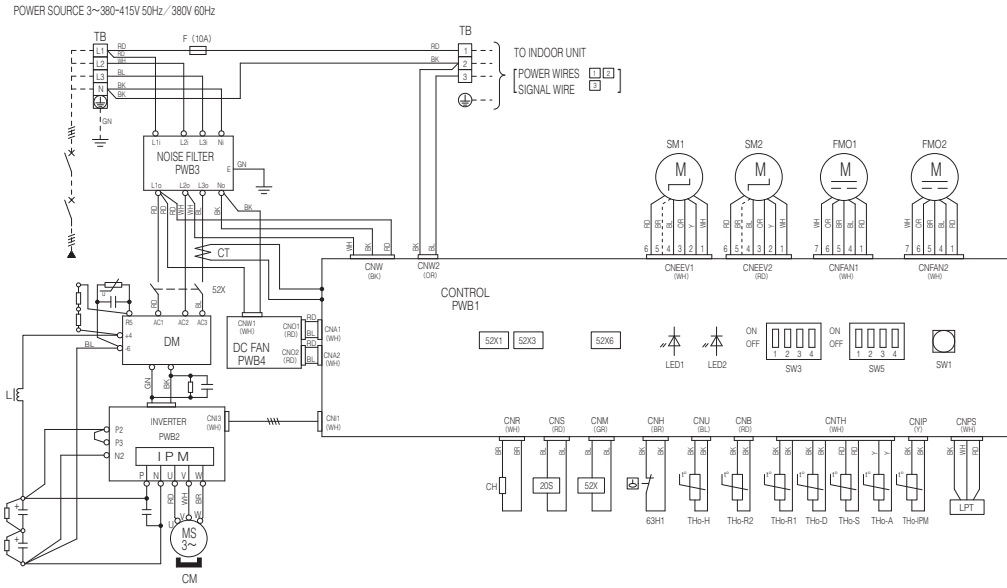

Mark	Color
BK	Black
BL	Blue
BR	Brown
GR	Gray
P	Pink
OR	Orange
RD	Red
WH	White
Y	Yellow
Y/GN	Yellow/Green

Item	Description
CnA~Z	Connector
CH	Crankcase heater
CM	Compressor motor
CT	Current sensor
DM	Diode module
F	Fuse
FM01,02	Fan motor
IPM	Intelligent power module
L	Reactor
LED1	Indication lamp (GREEN)
LED2	Indication lamp (RED)
LPT	Low pressure sensor
SM1	Expansion valve for cooling
SM2	Expansion valve for heating
SW1	Pump down switch
SW3.5	Local setting switch
TB	Terminal block
THo-A	Thermistor (Outdoor air temp.)
THo-D	Thermistor (Discharge pipe temp.)
THo-H	Thermistor (Comp.under-dome temp.)
THo-IPM	Thermistor (IPM)
THo-R1,2	Thermistor (Heat exchanger pipe temp.)
THo-S	Thermistor (Suction pipe temp.)
20S	Solenoid valve for 4 way valve
52X1	Auxiliary relay (for CH)
52X3	Auxiliary relay (for 20S)
52X6	Auxiliary relay (for 52X)
63H1	High pressure switch

Power cable, indoor-outdoor connecting wires

Model	MAX over current (A)	Power cable size (mm) ²	Power cable length (m)	indoor-outdoor wire size x number	Earth wire size (mm)
200	19	3.5	21	φ 1.6mm x 3	φ 1.6
250	22	5.5	31		

※At the connection with the duct type indoor unit.

Model	MAX over current (A)	Power cable size (mm) ²	Power cable length (m)	indoor-outdoor wire size x number	Earth wire size (mm)
200	24	5.5	29	φ 1.6mm x 3	φ 1.6
250	27		26		

- The specifications shown in the above table are for units without heaters. For units with heaters, refer to the installation instructions or the construction instructions of the indoor unit.
- Switchgear of Circuit breaker capacity which is calculated from MAX. over current should be chosen along the regulations in each country.
- The cable specifications are based on the assumption that a metal or plastic conduit is used with no more than three cables contained in a conduit and a voltage drop is 2%. For an installation falling outside of these conditions, please follow the internal cabling regulations. Adapt it to the regulation in effect in each country.

Local setting switch SW3 (Set up at shipment OFF)

SW3-1	Defrost control change	The defrosting operation interval becomes shorter by turning ON this switch. This switch should be turned ON in the area where outside temperature becomes below the freezing point.
SW3-2	Snow guard fan control	When this switch is turned ON, the outdoor unit fan will run for 30 seconds in every 10 minutes, when outdoor temperature falls to 3 or lower and the compressor is not running when the unit is used in a very snowy country, set this switch to ON.
SW3-3,4	Trial operation	Method of trial operation ① trial operation can be performed by using SW3-3,4. ② Compressor will be in the operation when SW3-3 is ON. ③ Cooling trial operation will be performed when SW3-4 is OFF, and heating trial operation when SW3-4 is ON. ④ Be sure to turn OFF SW3-3 after the trial operation is finished.

PCA001Z541



1.4 NOISE LEVEL

Notes (1) The data are based on the following conditions.

Ambient air temperature: Indoor unit 27°CWB. Outdoor unit 35°CDB.

(2) The data in the chart are measured in an anechoic room.

(3) The noise levels measured in the field are usually higher than the data because of reflection.

(1) Indoor units

(a) Ceiling cassette-4way compact type (FDT)

Measured based on JIS B 8616
Mike position as right

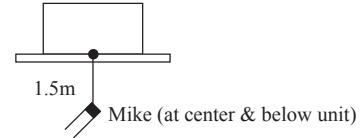

Model FDT50VF

Noise level 39 dB (A) at P-HIGH
33 dB (A) at HIGH
31 dB (A) at MEDIUM
30 dB (A) at LOW

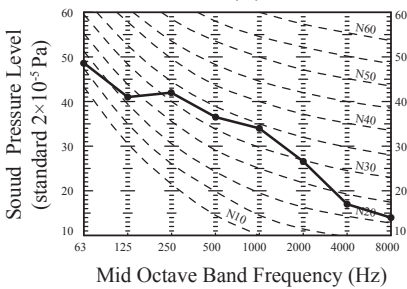

Model FDT60VF

Noise level 46 dB (A) at P-HIGH
33 dB (A) at HIGH
31 dB (A) at MEDIUM
30 dB (A) at LOW

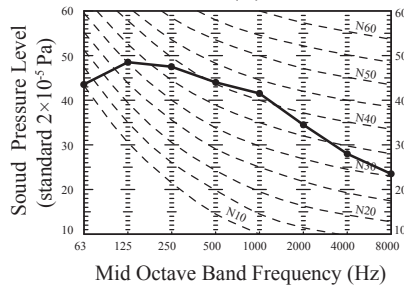

Model FDT71VF1

Noise level 46 dB (A) at P-HIGH
35 dB (A) at HIGH
33 dB (A) at MEDIUM
31 dB (A) at LOW

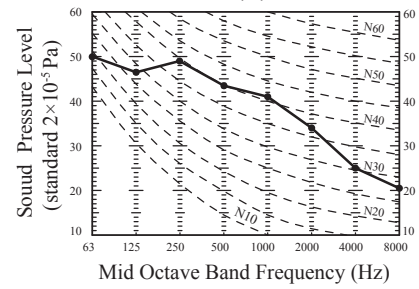

Model FDT100VF1, 100VF2

Noise level 51 dB (A) at P-HIGH
40 dB (A) at HIGH
37 dB (A) at MEDIUM
35 dB (A) at LOW

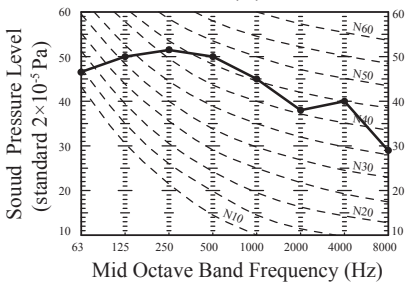

Model FDT125VF

Noise level 51 dB (A) at P-HIGH
42 dB (A) at HIGH
40 dB (A) at MEDIUM
37 dB (A) at LOW

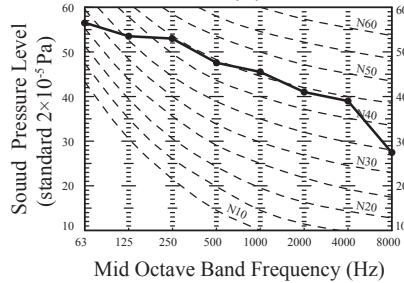

Model FDT140VF

Noise level 51 dB (A) at P-HIGH
43 dB (A) at HIGH
41 dB (A) at MEDIUM
38 dB (A) at LOW

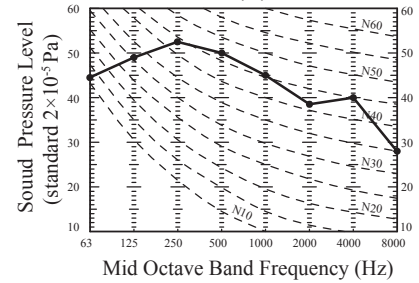

(b) Ceiling cassette-4way type (FDTC)

Measured based on JIS B 8616
Mike position as right

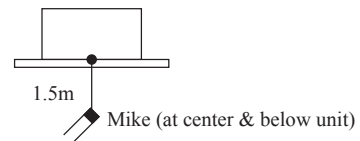

Model FDTC50VF

Cooling noise level 47 dB (A) at P-HIGH
42 dB (A) at HIGH
36 dB (A) at MEDIUM
30 dB (A) at LOW

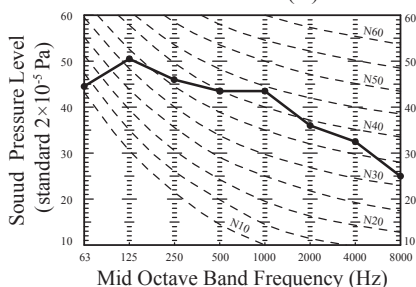

Heating noise level 47 dB (A) at P-HIGH
42 dB (A) at HIGH
36 dB (A) at MEDIUM
32 dB (A) at LOW

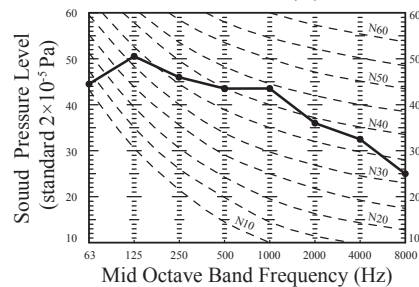

Model FDTC60VF

Cooling noise level 47 dB (A) at P-HIGH
 46 dB (A) at HIGH
 39 dB (A) at MEDIUM
 30 dB (A) at LOW

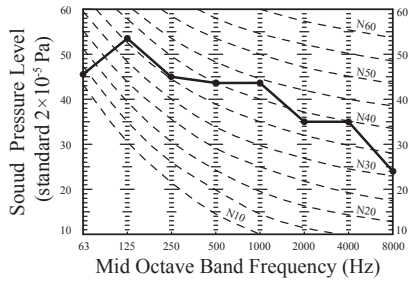

Heating noise level 47 dB (A) at P-HIGH
 46 dB (A) at HIGH
 39 dB (A) at MEDIUM
 32 dB (A) at LOW

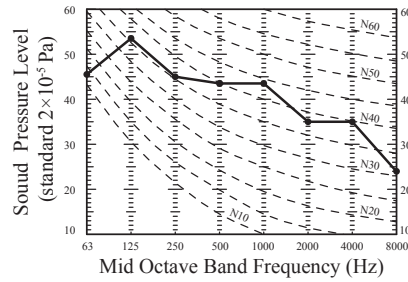

(c) Ceiling suspended type (FDEN)

Measured based on JIS B 8616
 Mike position as right

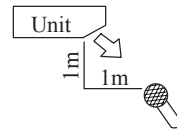

Mike (in front & below unit)

Model FDEN50VF

Noise level 46 dB (A) at P-HIGH
 39 dB (A) at HIGH
 38 dB (A) at MEDIUM
 37 dB (A) at LOW

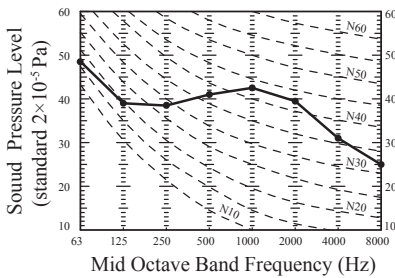

Model FDEN60VF

Noise level 48 dB (A) at P-HIGH
 41 dB (A) at HIGH
 39 dB (A) at MEDIUM
 38 dB (A) at LOW

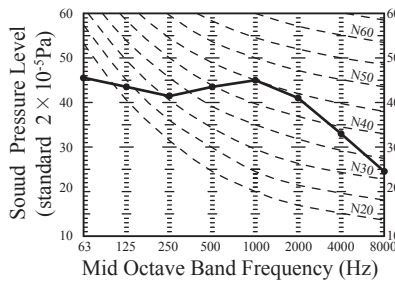

Model FDEN71VF1

Noise level 50 dB (A) at P-HIGH
 41 dB (A) at HIGH
 39 dB (A) at MEDIUM
 38 dB (A) at LOW

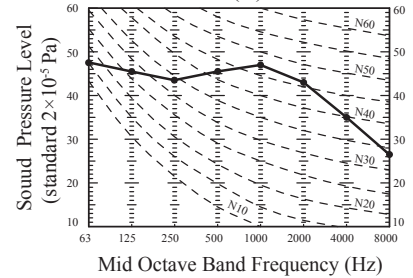

Models FDEN100VF1

Noise level 46 dB (A) at P-HIGH
 44 dB (A) at HIGH
 41 dB (A) at MEDIUM
 39 dB (A) at LOW

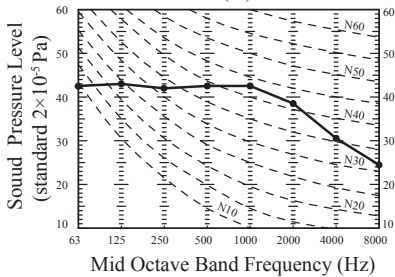

Models FDEN125VF,140VF

Noise level 50 dB (A) at P-HIGH
 46 dB (A) at HIGH
 44 dB (A) at MEDIUM
 43 dB (A) at LOW

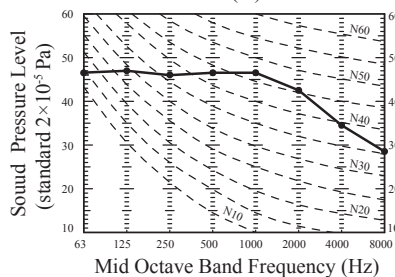

(d) Duct connected-High static pressure-type (FDU)

Measured based on JIS B 8616
Mike position as right

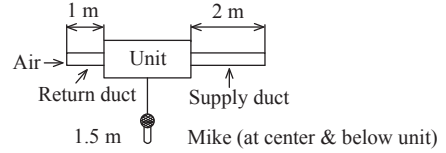

Model FDU100VF1, 100VF2

Noise level 44 dB (A) at P-HIGH
38 dB (A) at HIGH
36 dB (A) at MEDIUM
30 dB (A) at LOW

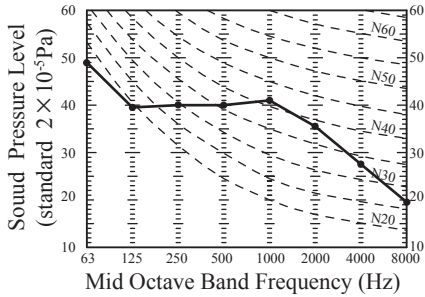

Model FDU125VF

Noise level 45 dB (A) at P-HIGH
40 dB (A) at HIGH
34 dB (A) at MEDIUM
29 dB (A) at LOW

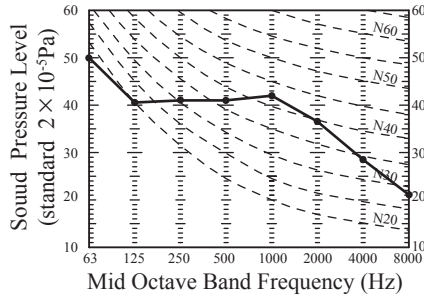

Model FDU140VF

Noise level 47 dB (A) at P-HIGH
40 dB (A) at HIGH
35 dB (A) at MEDIUM
30 dB (A) at LOW

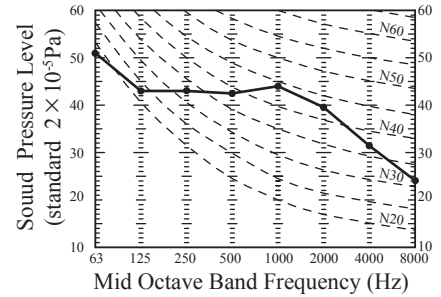

Model FDU200VF

Noise level 51 dB (A)

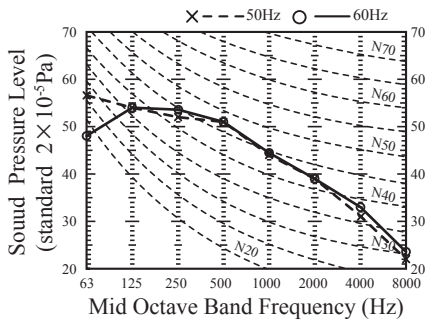

Model FDU250VF

Noise level 52 dB (A)

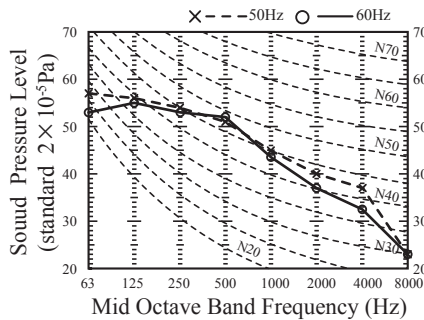

Power level

(Measurement conditions: JIS-B8616, measurement location: reverberation chamber)

Unit: dB

Model	Air supply side	Air return side
FDU200VF	75	64
FDU250VF	76	65

Note(1) Values are for external static pressure of 200Pa.

(e) Duct connected-Low / Middle static pressure type (FDUM)

Measured based on JIS B 8616
Mike position as right

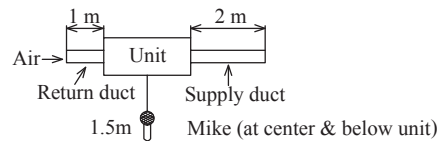

Model FDUM50VF

Noise level 37 dB (A) at P-HIGH
32 dB (A) at HIGH
29 dB (A) at MEDIUM
26 dB (A) at LOW

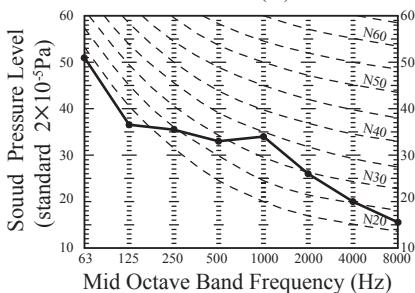

Model FDUM60VF

Noise level 36 dB (A) at P-HIGH
31 dB (A) at HIGH
28 dB (A) at MEDIUM
25 dB (A) at LOW

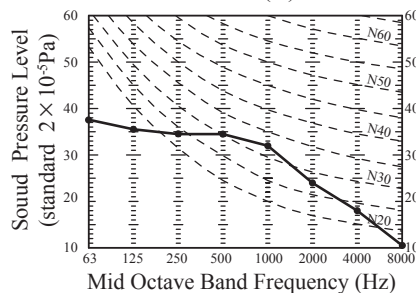

Model FDUM71VF1

Noise level 38 dB (A) at P-HIGH
33 dB (A) at HIGH
29 dB (A) at MEDIUM
25 dB (A) at LOW

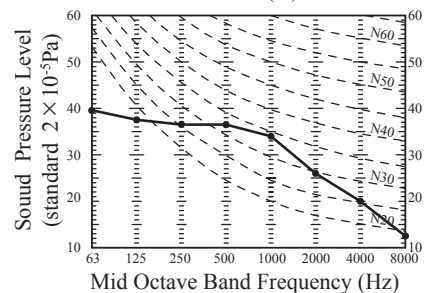

Model FDUM100VF1, 100VF2

Noise level 44 dB (A) at P-HIGH
 38 dB (A) at HIGH
 36 dB (A) at MEDIUM
 30 dB (A) at LOW

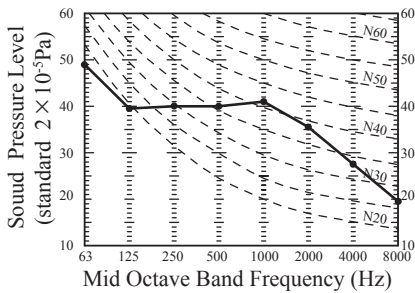

Model FDUM125VF

Noise level 45 dB (A) at P-HIGH
 40 dB (A) at HIGH
 34 dB (A) at MEDIUM
 29 dB (A) at LOW

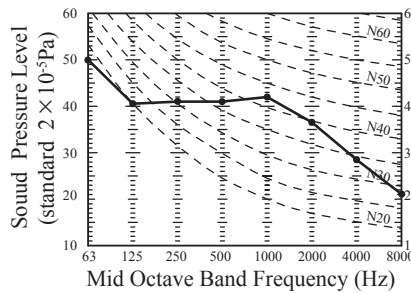

Model FDUM140VF

Noise level 47 dB (A) at P-HIGH
 40 dB (A) at HIGH
 35 dB (A) at MEDIUM
 30 dB (A) at LOW

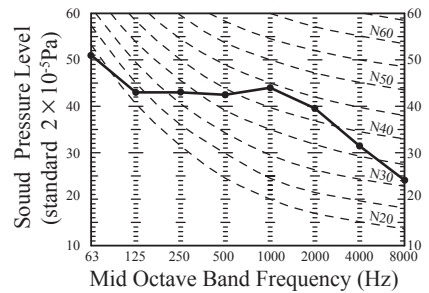

(f) Floor standing type (FDF)

Model FDF71VD1

Noise level 42 dB (A) at P-HIGH
 39 dB (A) at HIGH
 35 dB (A) at MEDIUM
 33 dB (A) at LOW

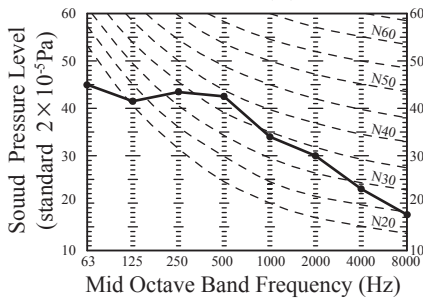

Models FDF100VD1, 125VD, 140VD, 100VD2

Noise level 54 dB (A) at P-HIGH
 50 dB (A) at HIGH
 48 dB (A) at MEDIUM
 44 dB (A) at LOW

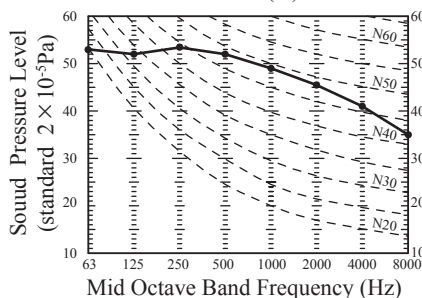

Measured based on JIS B 8616
 Mike position

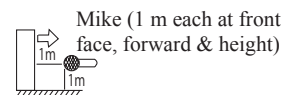

(g) Wall mounted type (SRK)

Model SRK50ZMX-S

Cooling noise level 47 dB (A) at HIGH
 40 dB (A) at MEDIUM
 27 dB (A) at LOW
 25 dB (A) at UL LOW

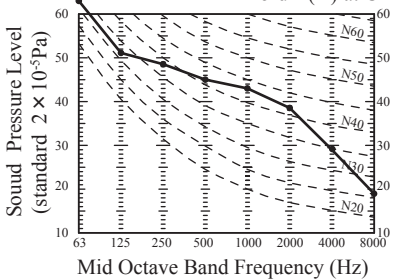

Heating noise level 48 dB (A) at HIGH
 40 dB (A) at MEDIUM
 33 dB (A) at LOW
 26 dB (A) at UL LOW

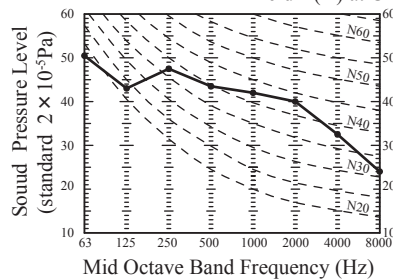

Measured based on JIS C 9612
 Mike position

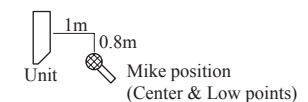

Model SRK60ZMX-S

Cooling noise level 51 dB (A) at HIGH
 41 dB (A) at MEDIUM
 29 dB (A) at LOW
 25 dB (A) at UL LOW

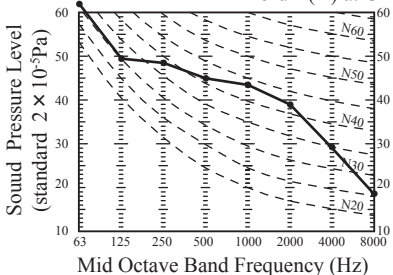

Heating noise level 48 dB (A) at HIGH
 41 dB (A) at MEDIUM
 34 dB (A) at LOW
 27 dB (A) at UL LOW

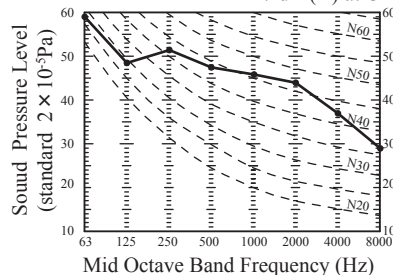

(2) Outdoor units

Measured based on JIS B 8616

Mike position: at highest noise level in position as mentioned below

Distance from front side 1m

Height 1m

Models FDC100VN,100VS

Noise level 49 dB (A)

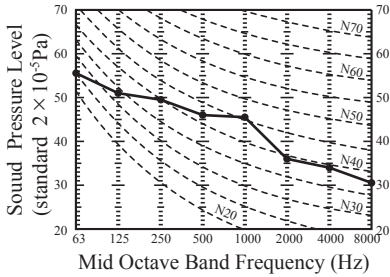

Models FDC125VN,125VS

Cooling noise level 50 dB (A)

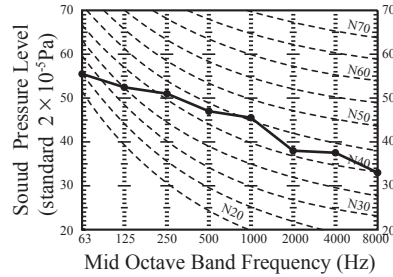

Heating noise level 51 dB (A)

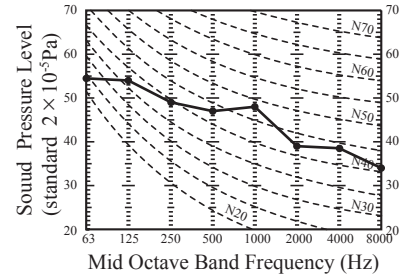

Models FDC140VN,140VS

Noiselevel 51 dB (A)

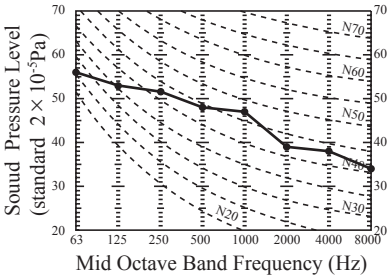

Model FDC200VS

Noise level 57 dB (A)

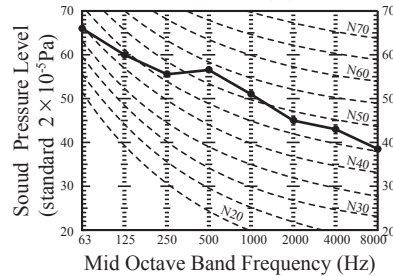

Model FDC250VS

Cooling noise level 57 dB(A)

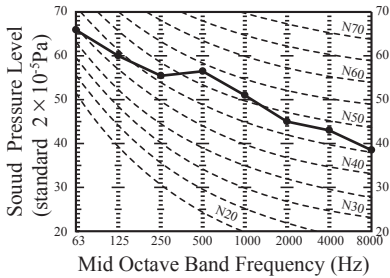

Heating noise level 58 dB (A)

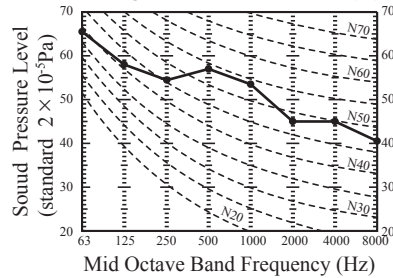

1.5 CHARACTERISTICS OF FAN

(1) Duct connected-High static static pressure type (FDU)

- Characteristic FAN (1) shows air flow vs. External Static Pressure (E.S.P.) range where settings of E.S.P. are maximum E.S.P. (SW8-4 OFF : 150Pa, SW8-4 ON : 200Pa), rated E.S.P., and minimum E.S.P. (SW8-4 OFF : 80Pa, SW8-4 ON : 10Pa)
- Characteristic FAN (2) shows air flow vs E.S.P. curve when set fan tap is set P-Hi with each setting of E.S.P. by remote control.
- External Static Pressure (E.S.P.) can be set by wired remote control.
- You can set required E.S.P. by wired remote control which calculate it with the set air flow rate and pressure loss of the duct connected.

Model FDU100VF1, 100VF2

■SW8-4 : OFF (Range of use limitation : Setting 80Pa-150Pa)

Characteristic FAN (1)

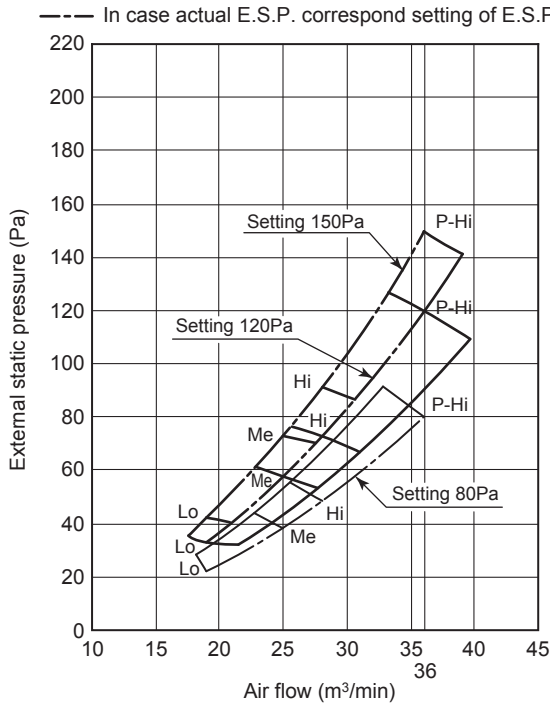

Characteristic FAN (2)

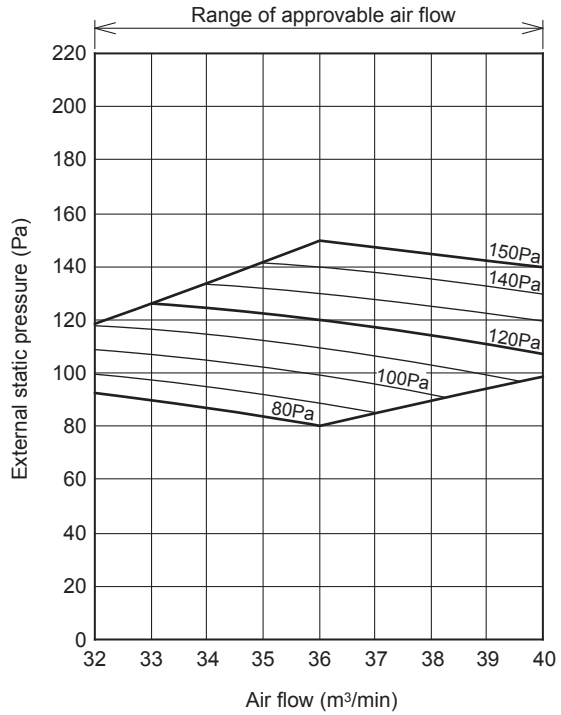

■SW8-4 : ON (Range of use limitation : Setting 10Pa-200Pa)

Characteristic FAN (1)

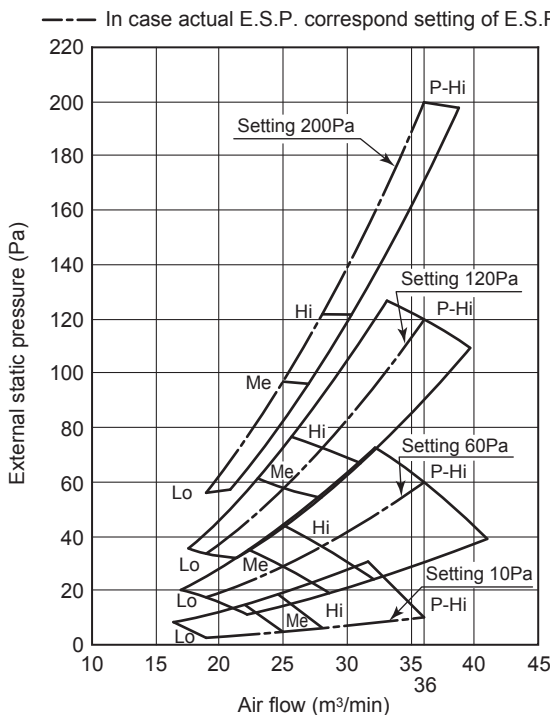

Characteristic FAN (2)

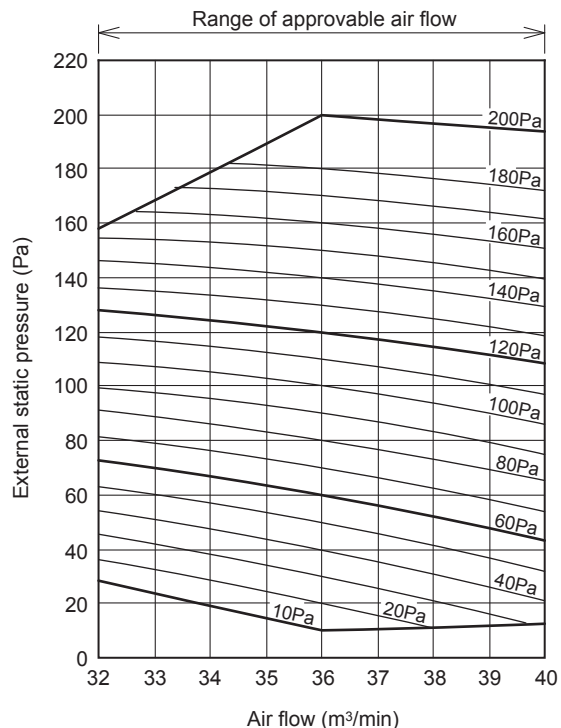

Model FDU125VF

■ SW8-4 : OFF (Range of use limitation : Setting 80Pa-150Pa)

Characteristic FAN (1)

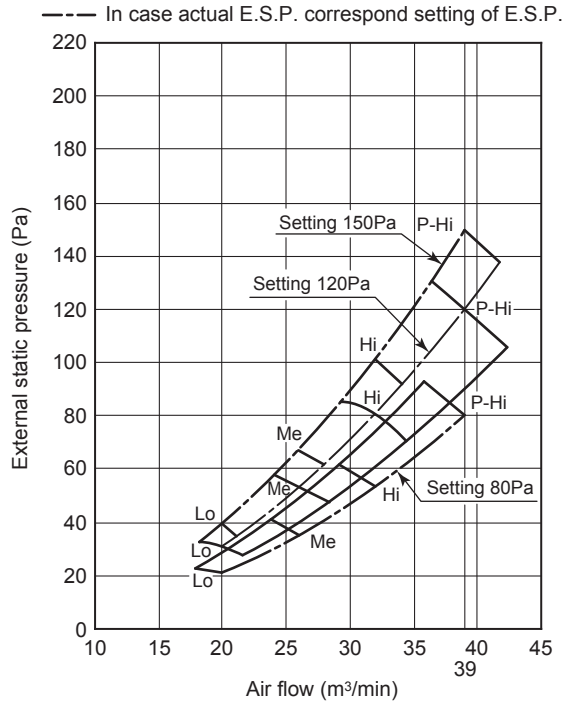

Characteristic FAN (2)

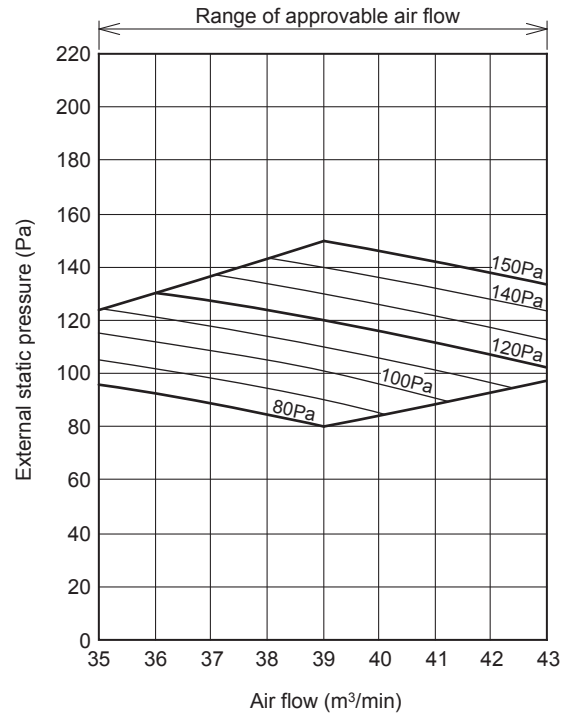

■ SW8-4 : ON (Range of use limitation : Setting 10Pa-200Pa)

Characteristic FAN (1)

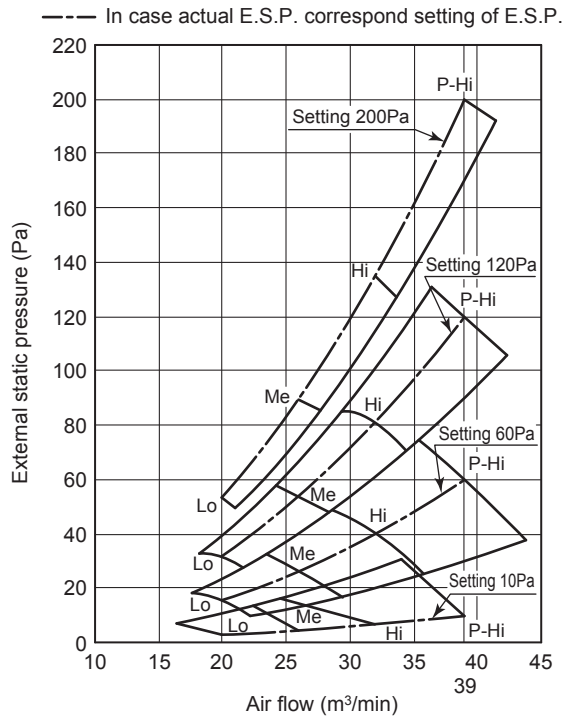

Characteristic FAN (2)

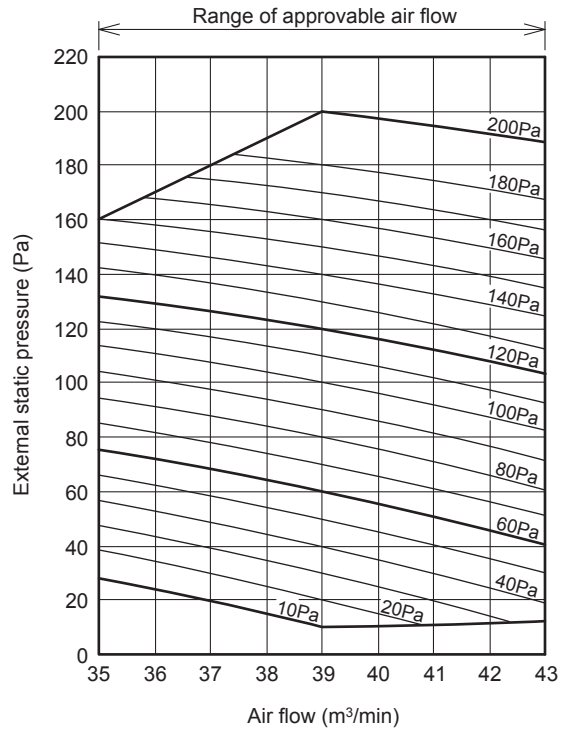

Model FDU140VF

■ SW8-4 : OFF (Range of use limitation : Setting 80Pa-150Pa)

Characteristic FAN (1)

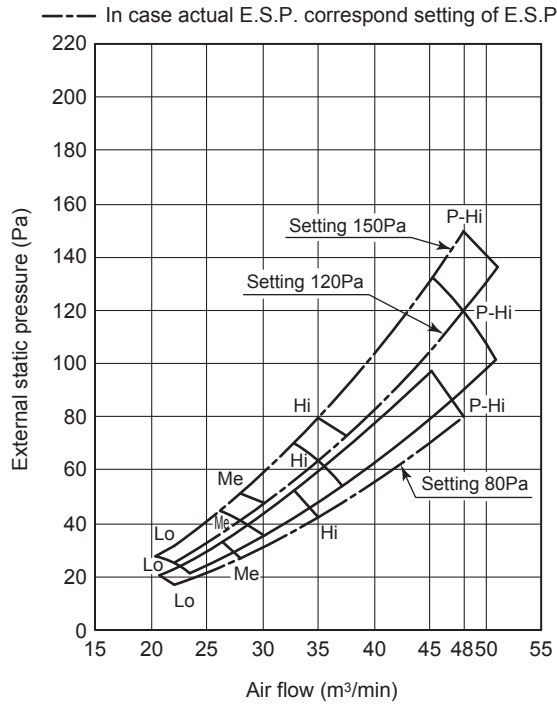

Characteristic FAN (2)

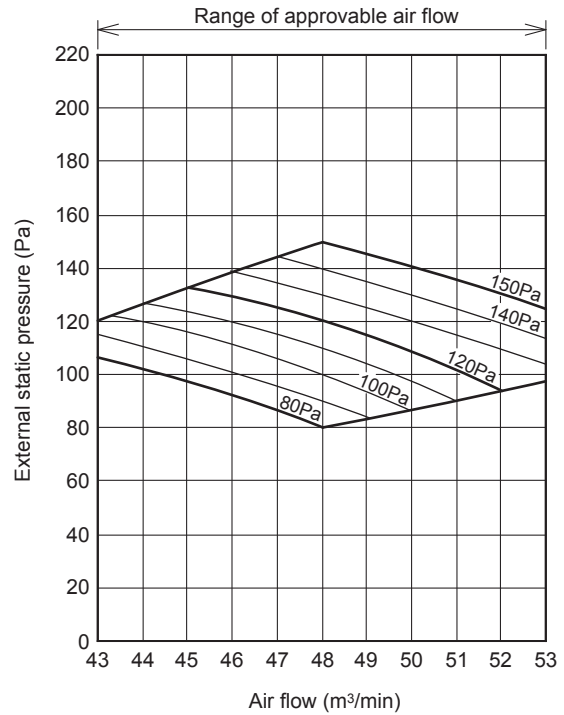

■ SW8-4 : ON (Range of use limitation : Setting 10Pa-200Pa)

Characteristic FAN (1)

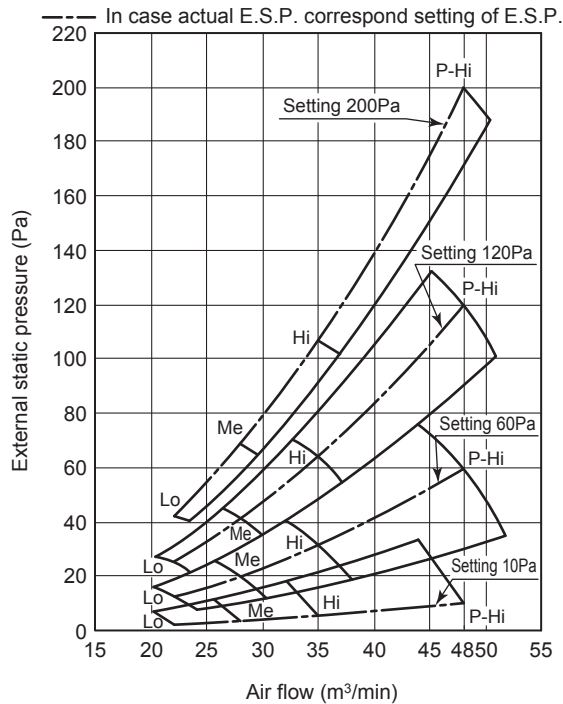

Characteristic FAN (2)

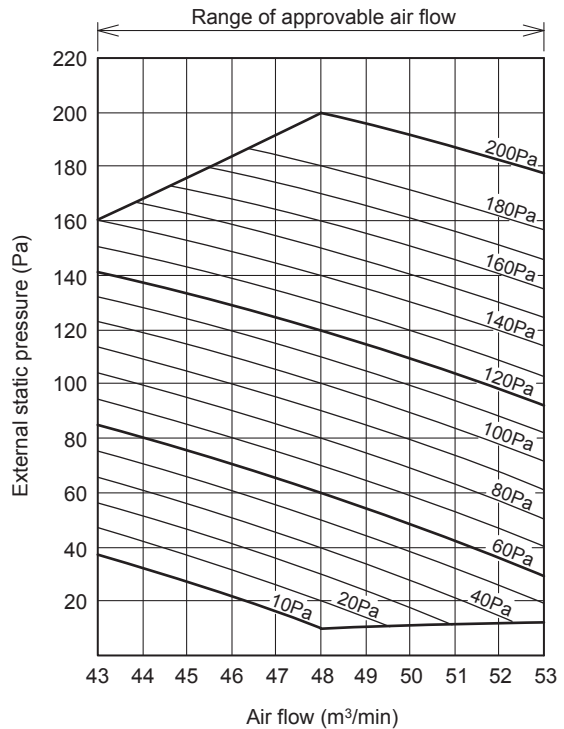

Model FDU200VF

■ Standard (Factory Settings)

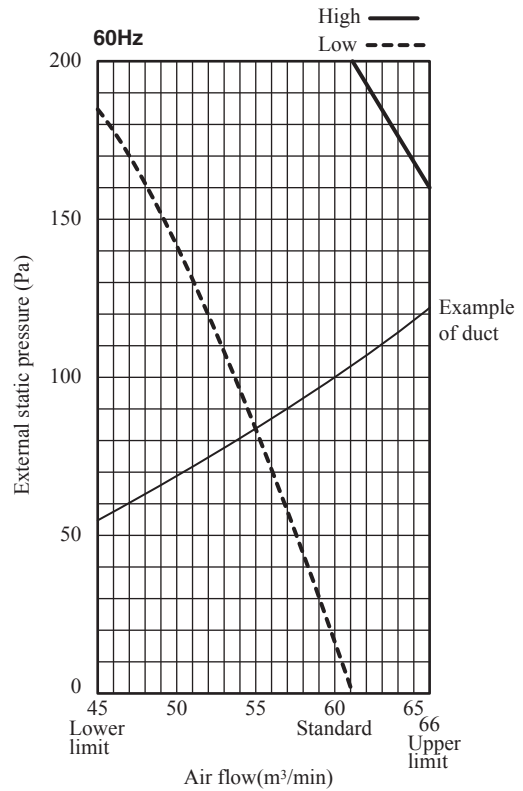
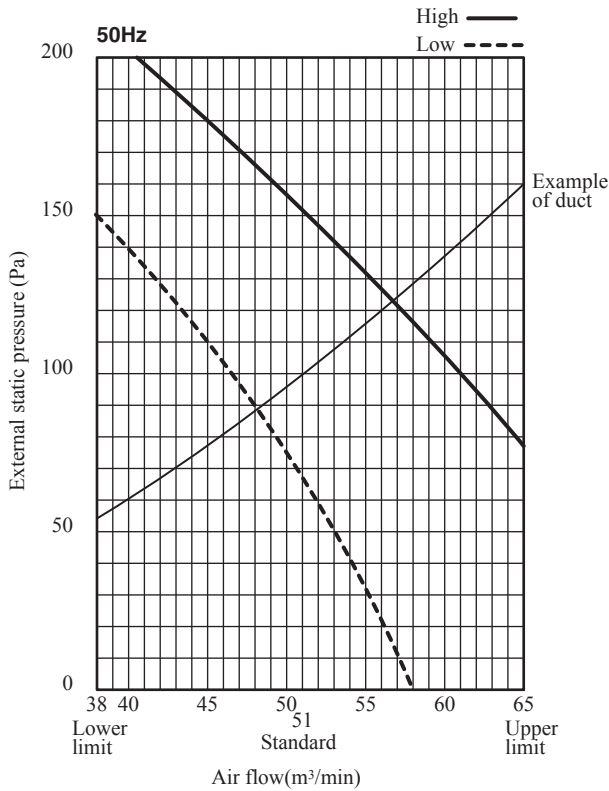

■ When the fan controller kit is used (Option : Refer to page 536)

•Standard rating point rated air volume at 100Pa

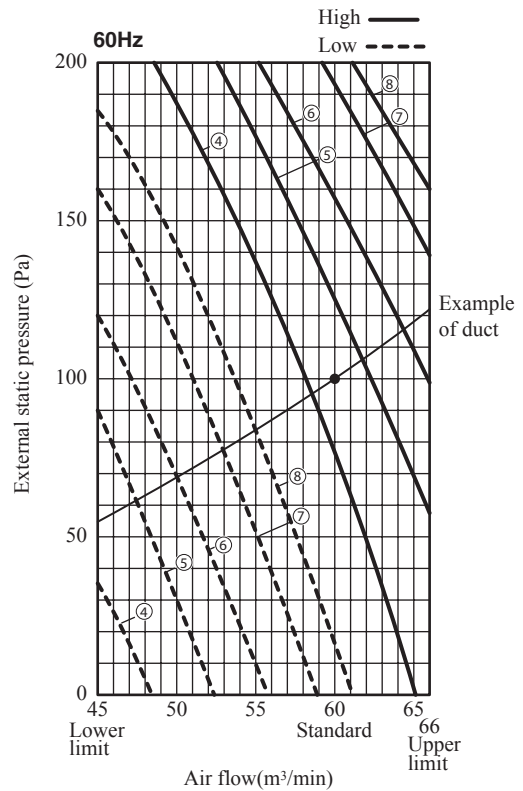
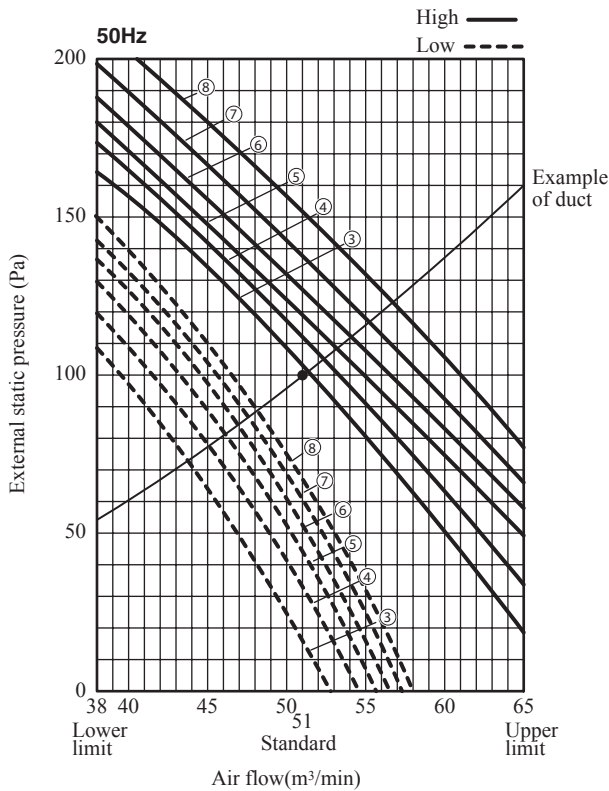

Note (1) Nos.②, ① of fan controller should not be used because the fan motor could produce electromagnetic noise.

Note (1) Nos.③, ② and ① of fan controller should not be used because the fan motor could produce electromagnetic noise.

Model FDU250VF

■ **Standard (Factory Settings)**

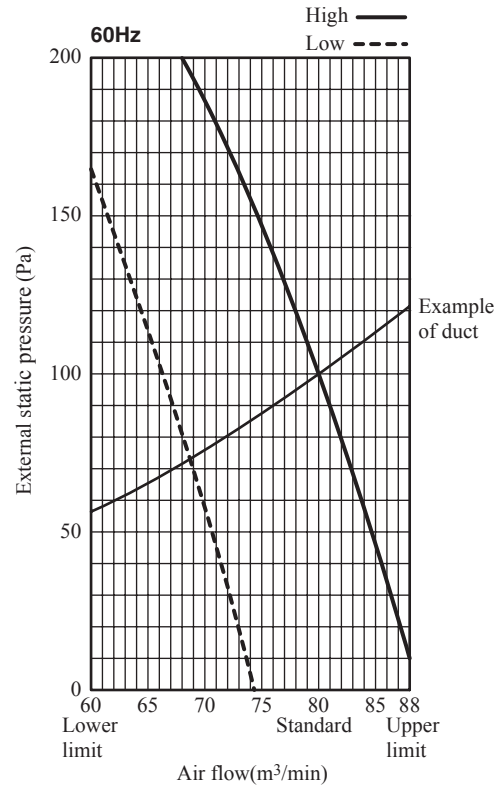
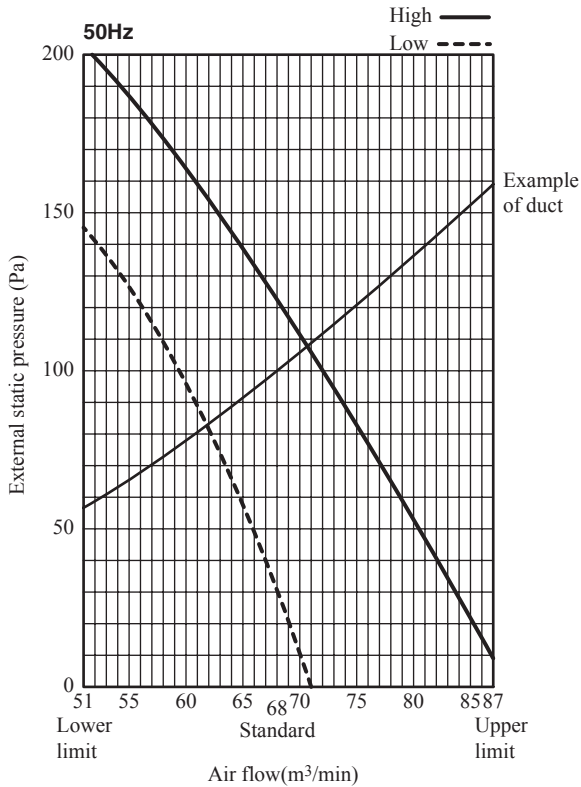

■ **When the fan controller kit is used (Option : Refer to page 536)**

• Standard rating point rated air volume at 100Pa

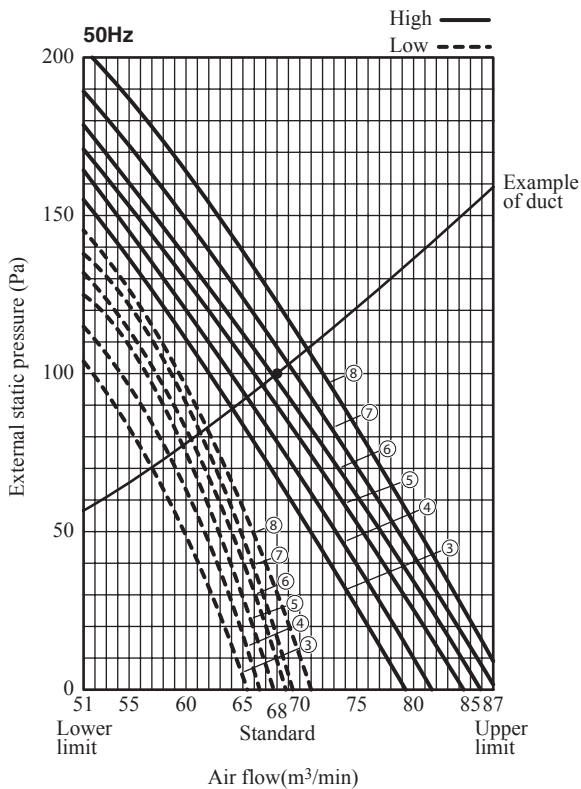

Note (1) Nos. ②, ① of fan controller should not be used because the fan motor could produce electromagnetic noise.

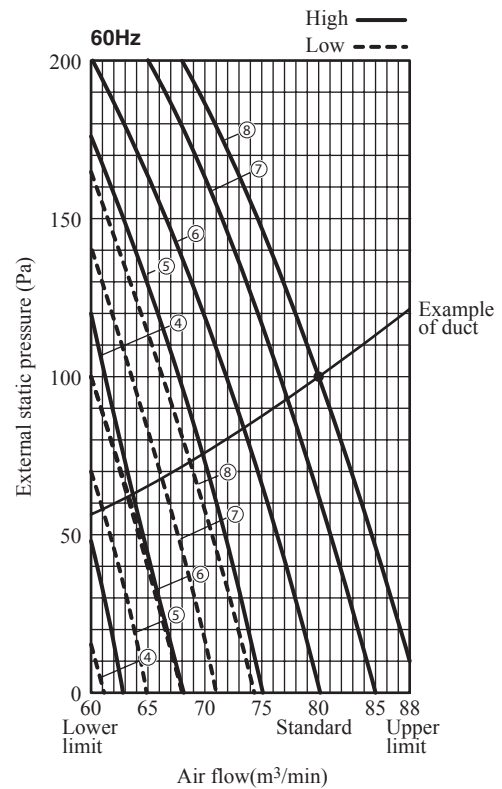

Note (1) Nos. ③, ② and ① of fan controller should not be used because the fan motor could produce electromagnetic noise.

(2) Duct connected-Low / Middle static pressure type (FDUM)

- Characteristic FAN (1) shows air flow vs. External Static Pressure (E.S.P.) range where settings of E.S.P. are maximum E.S.P. (100Pa), rated E.S.P., and minimum E.S.P. (10Pa)
- Characteristic FAN (2) shows air flow vs E.S.P. curve when set fan tap is set P-Hi with each setting of E.S.P by remote controller.
- External Static Pressure (E.S.P.) can be set by wired remote controller.
- You can set required E.S.P. by wired remote controller which calculate it with the set air flow rate and pressure loss of the duct connected.

Model FDUM50VF

Characteristic FAN(1)

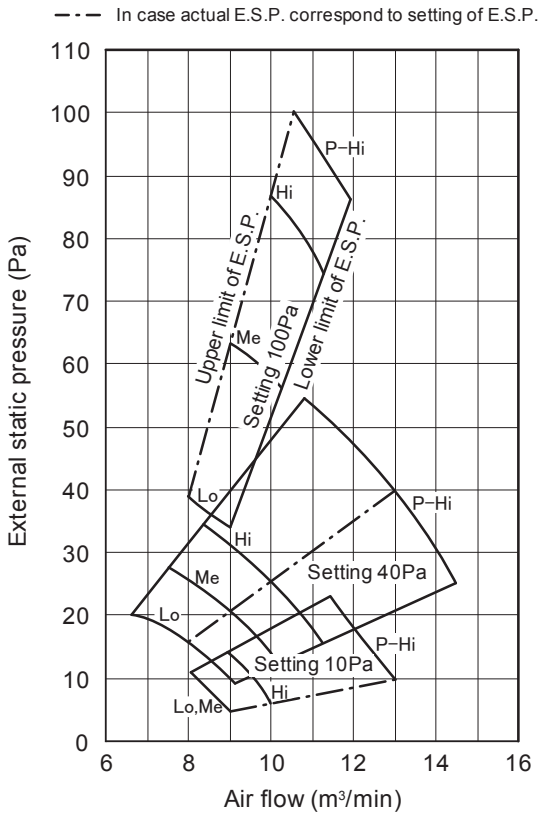

Characteristic FAN(2)

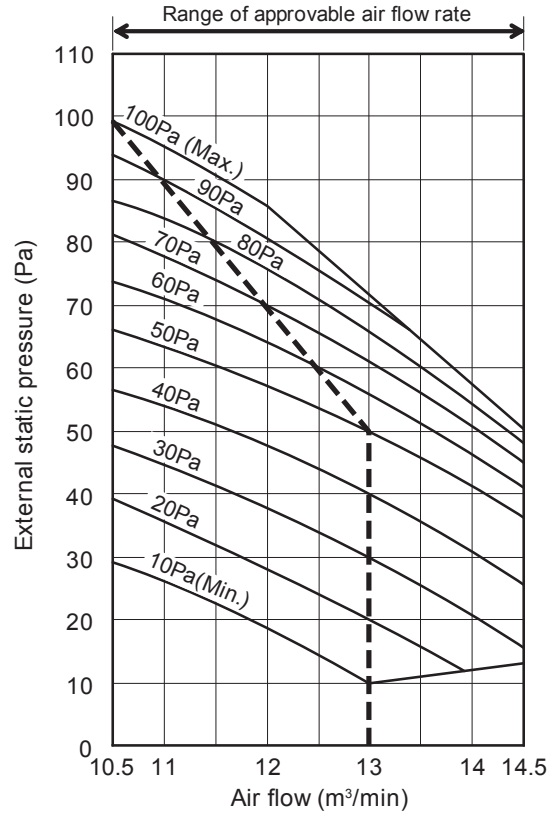

Model FDUM60VF

Characteristic FAN(1)

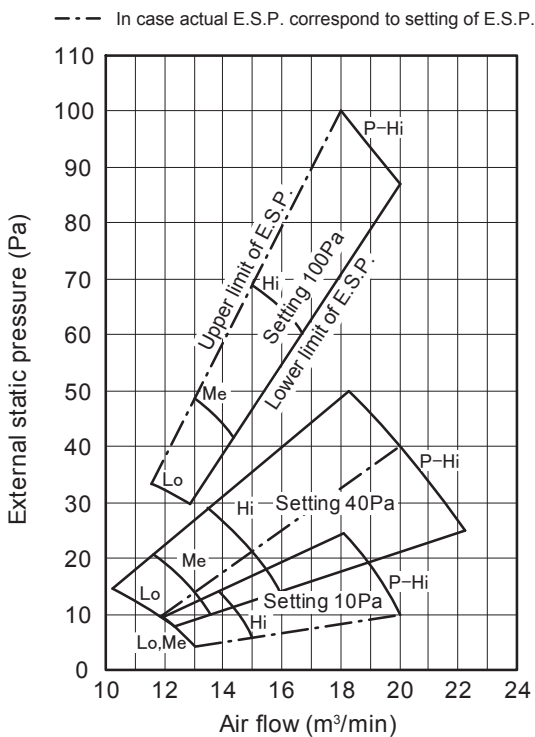

Characteristic FAN(2)

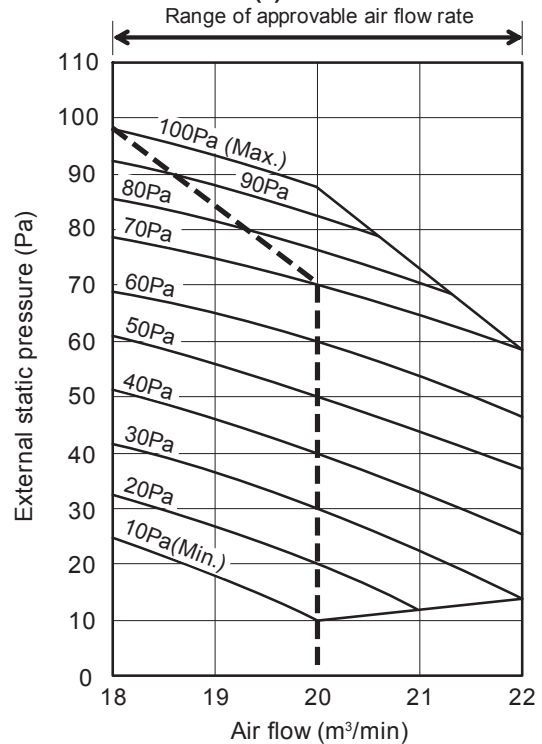

**Model FDUM71VF1
Characteristic FAN(1)**

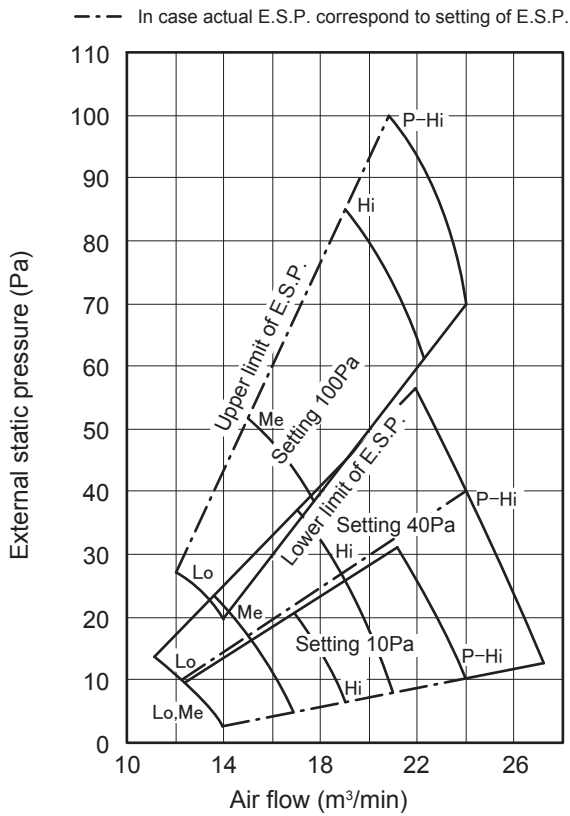

Characteristic FAN(2)

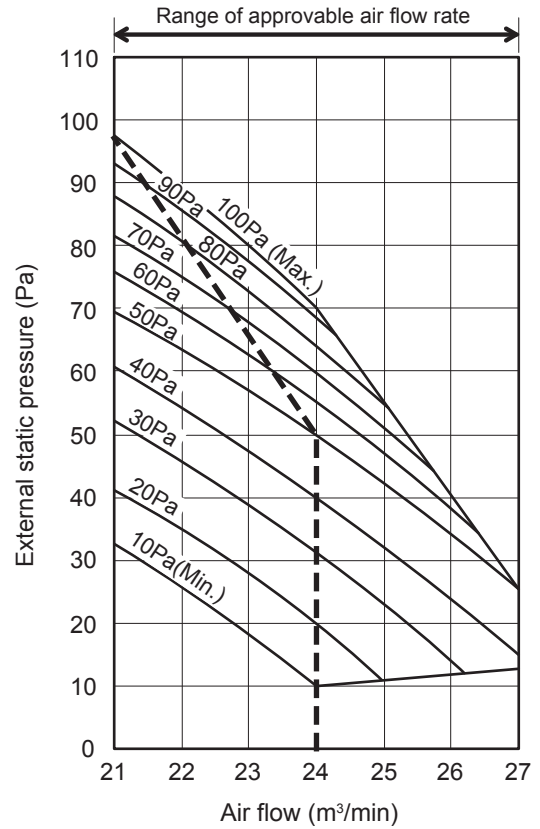

**Model FDUM100VF1, 100VF2
Characteristic FAN(1)**

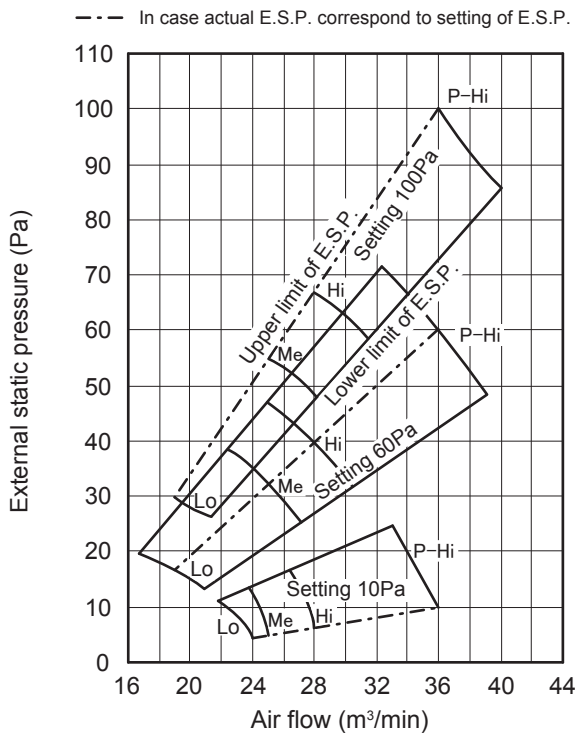

Characteristic FAN(2)

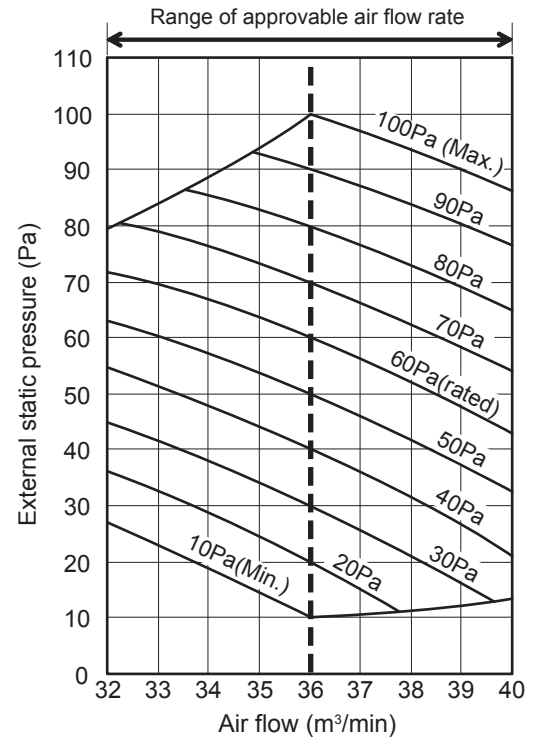

Model FDUM125VF
Characteristic FAN(1)

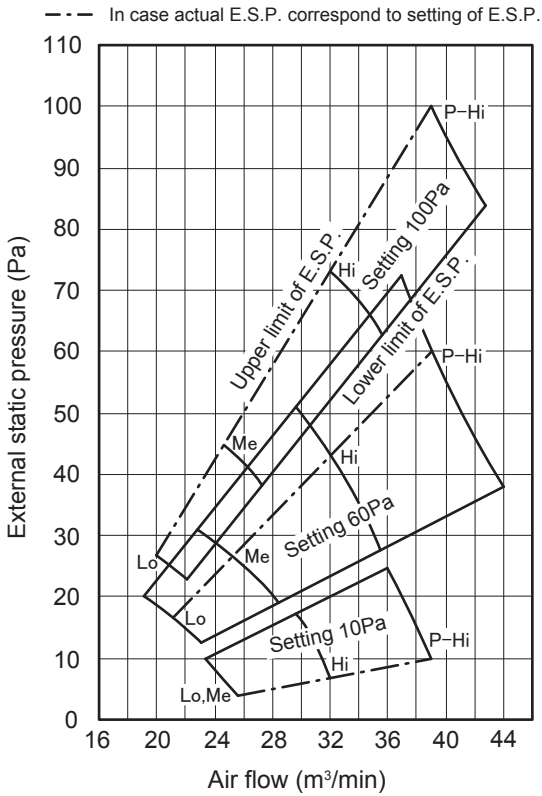

Characteristic FAN(2)

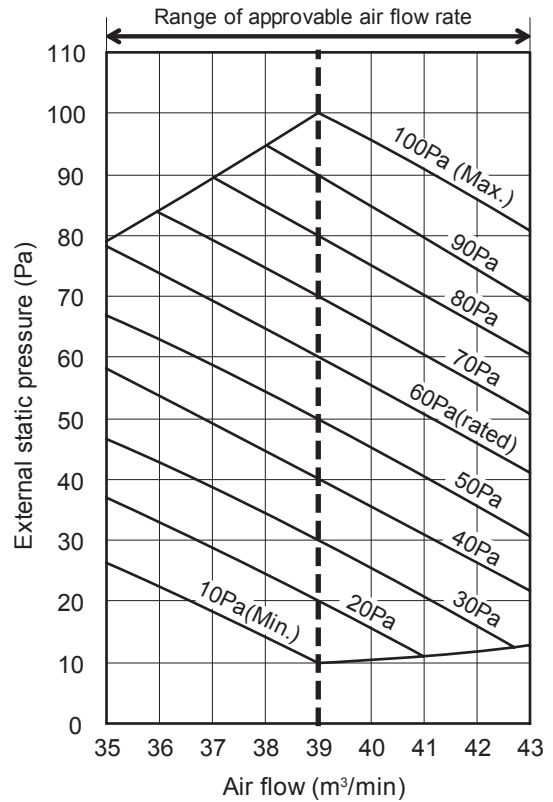

Model FDUM140VF
Characteristic FAN(1)

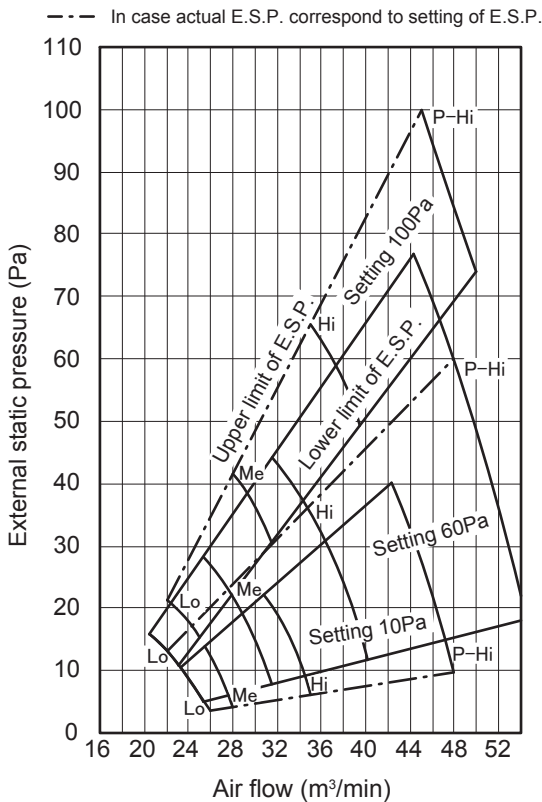

Characteristic FAN(2)

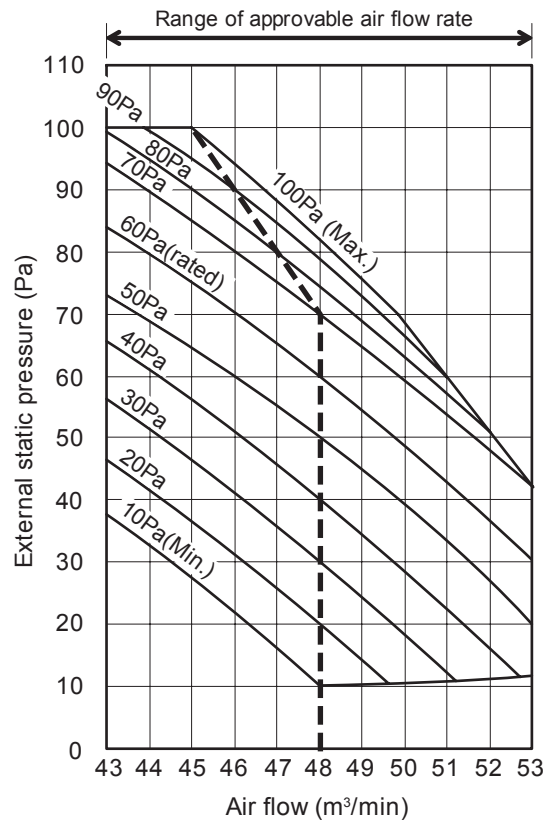

1.6 TEMPERATURE AND VELOCITY DISTRIBUTION

Indoor temperature

Cooling 27°CDB / 19°CWB

Heating 20°CDB

Note: These figures represent the typical main range of temperature and velocity distribution at the center of air outlet within the published conditions.

In the actual installation, they may differ from the typical figures under the influence of air temperature conditions, ceiling height, operation conditions and obstacles.

(1) Ceiling casset-4way type (FDT)

Model FDT50VF

Cooling Air flow : P-Hi

Louver position

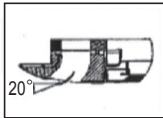

Temperature distribution

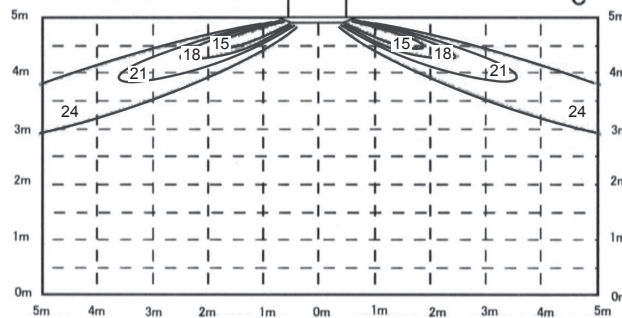

Velocity distribution

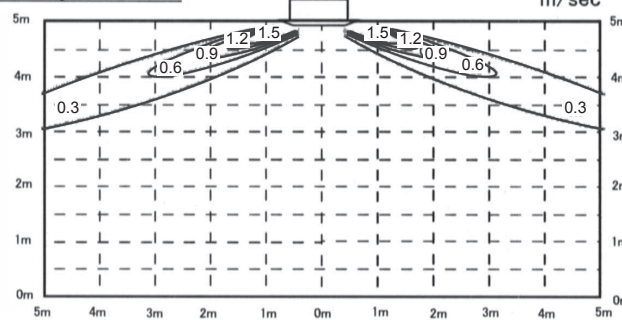

Heating Air flow : P-Hi

Louver position

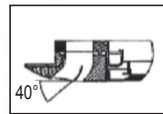

Temperature distribution

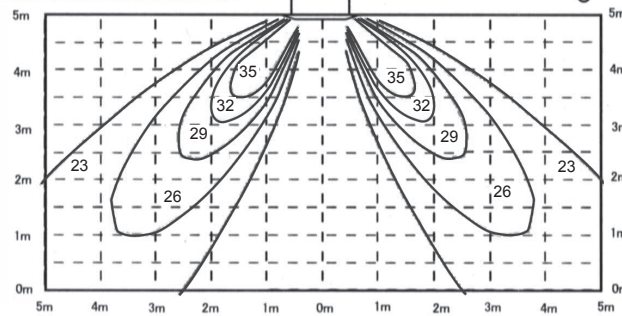

Velocity distribution

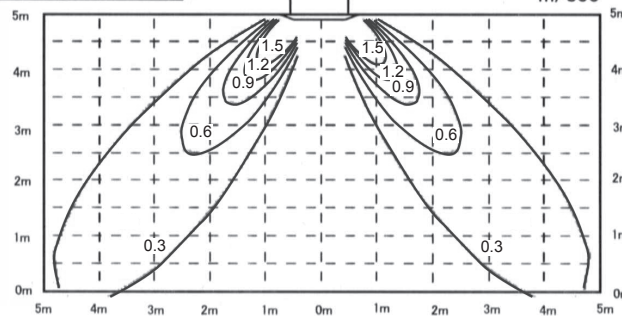

ISD09406

Models FDT60VF, 71VF1

Cooling Air flow : P-Hi

Louver position

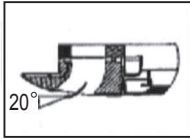

Temperature distribution

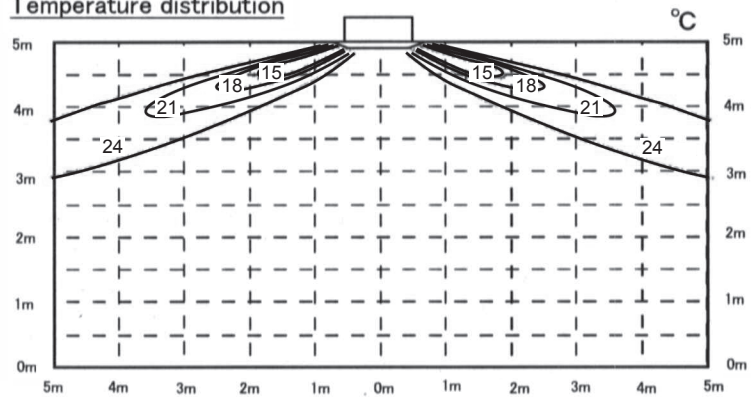

Velocity distribution

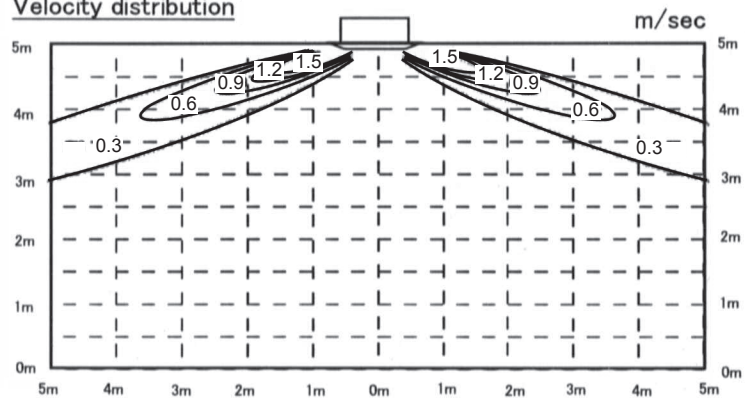

Heating Air flow : P-Hi

Louver position

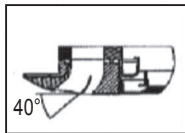

Temperature distribution

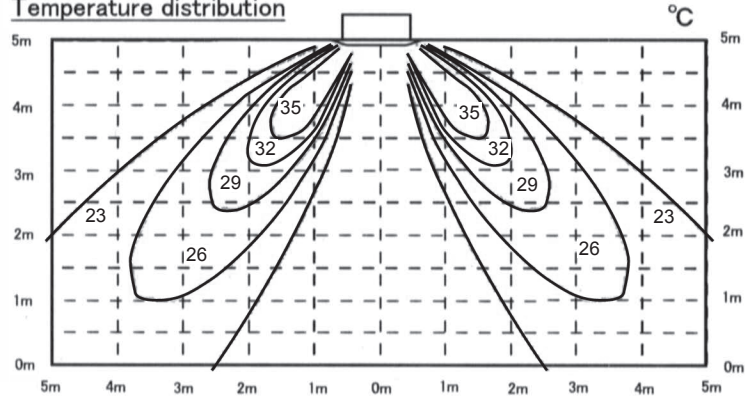

Velocity distribution

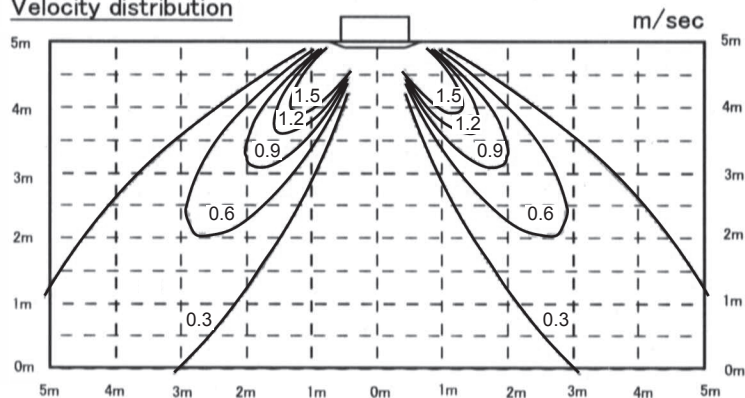

ISD09406

Models FDT100VF1, 125VF, 140VF, 100VF2

Cooling Air flow : P-Hi

Louver position

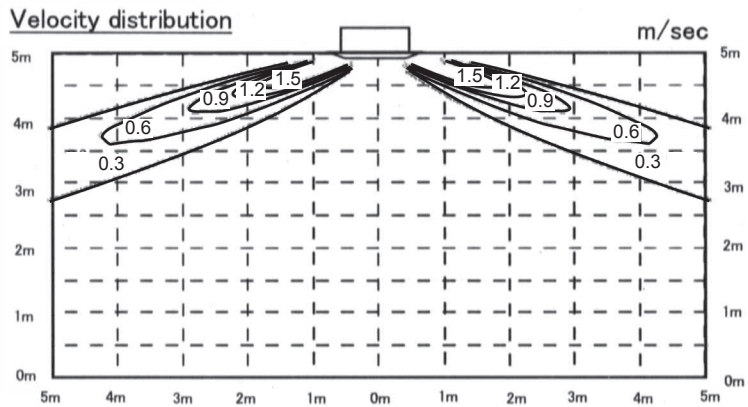
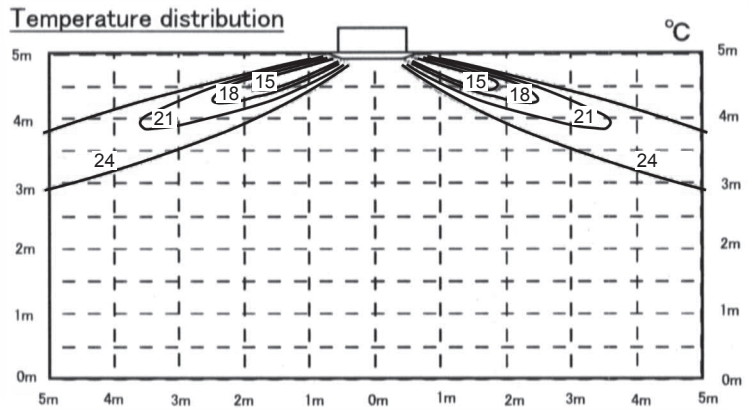
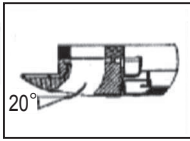

Heating Air flow : P-Hi

Louver position

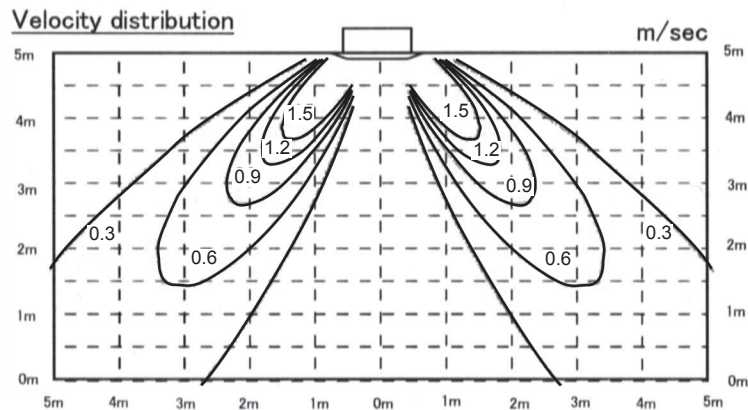
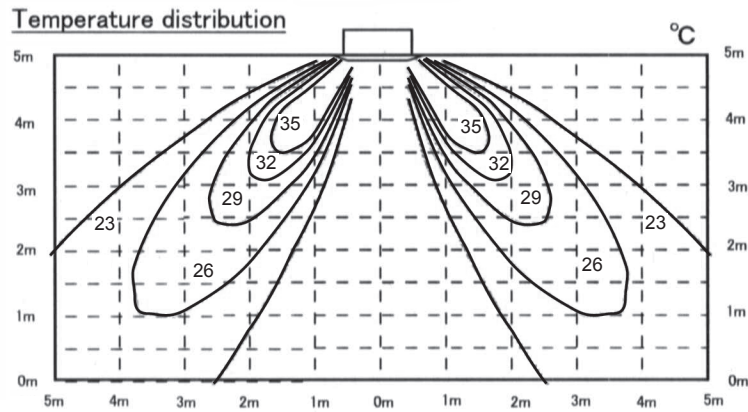
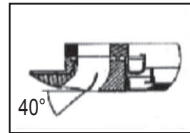

ISD09406

(2) Ceiling casset-4way compact type (FDTC)

Model FDTC50VF, 60VF

Cooling Air flow : P-Hi

Louver position

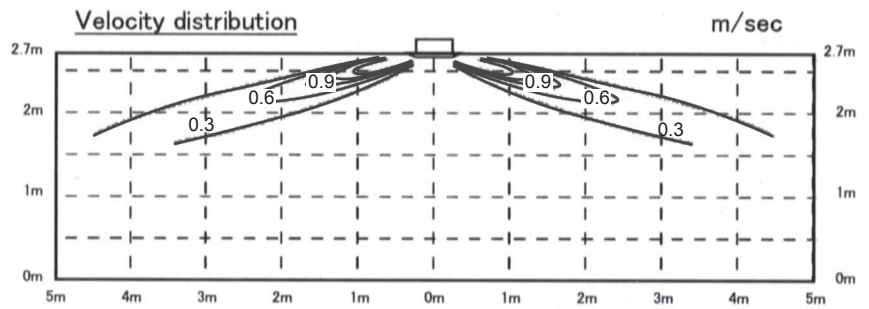
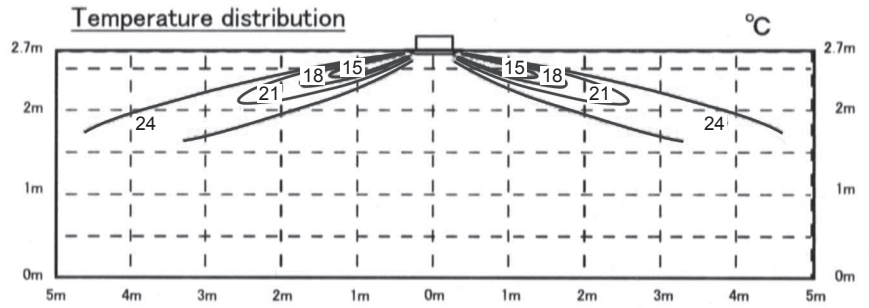
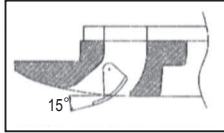

Heating Air flow : P-Hi

Louver position

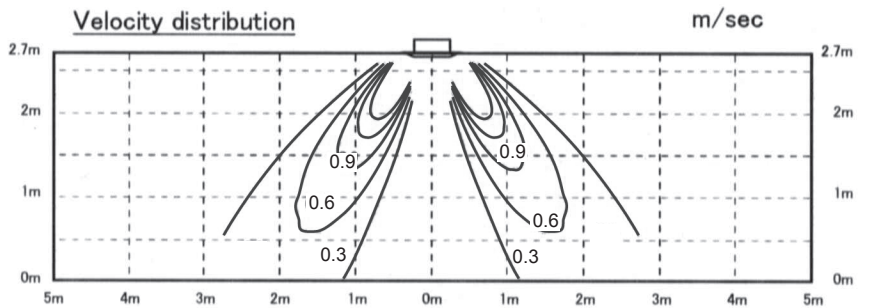
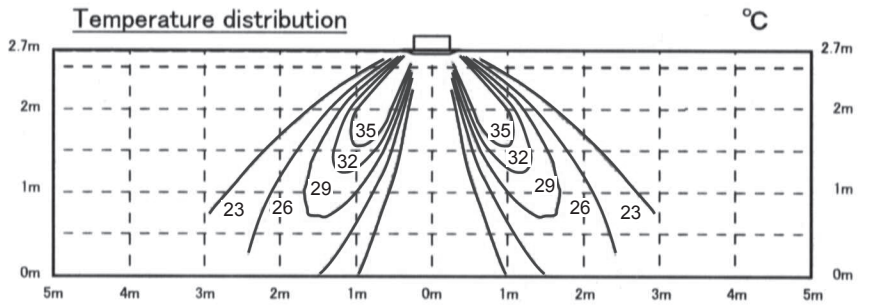
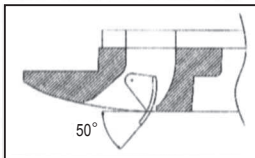

ISD09407

(3) Ceiling suspended type (FDEN)

Model FDEN50VF

Cooling Air flow : P-Hi

Louver position

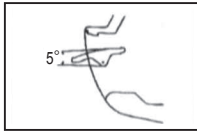

Temperature distribution

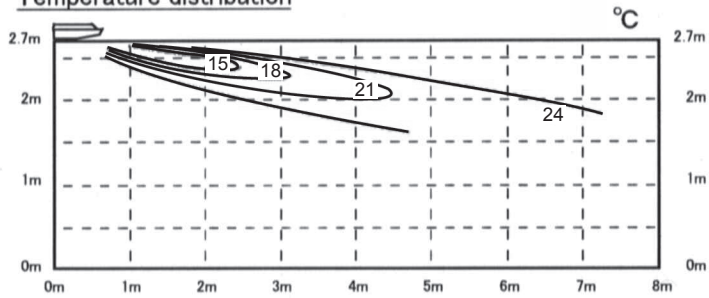

Velocity distribution

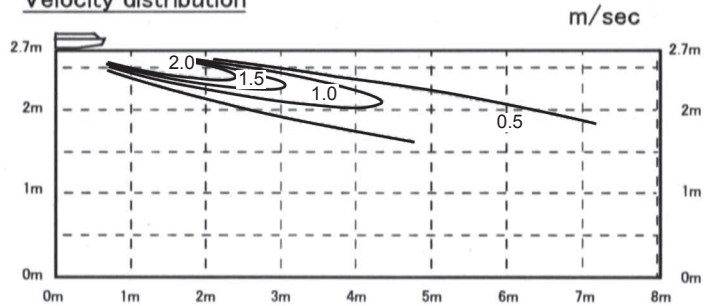

Heating Air flow : P-Hi

Louver position

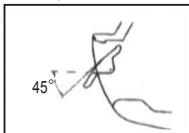

Temperature distribution

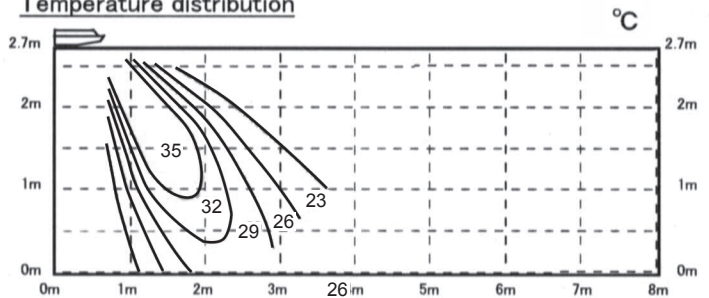

Velocity distribution

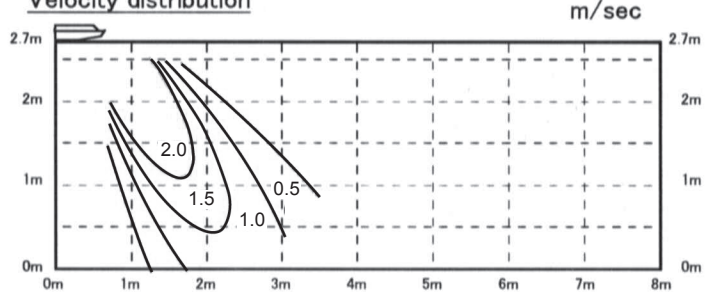

ISD09408

Models FDEN60VF, 71VF1

Cooling Air flow : P-Hi

Louver position

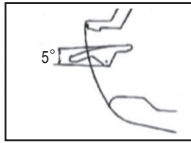

Temperature distribution

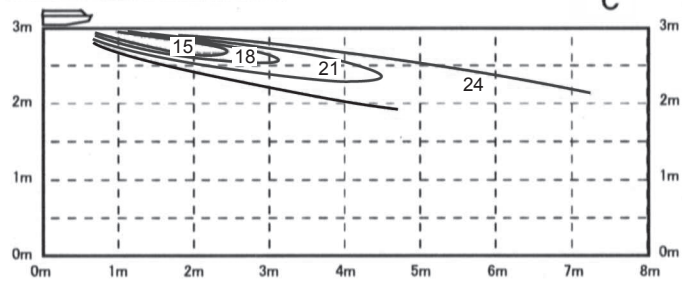

Velocity distribution

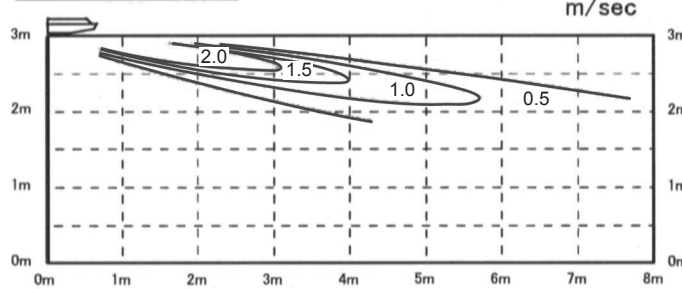

Heating Air flow : P-Hi

Louver position

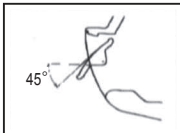

Temperature distribution

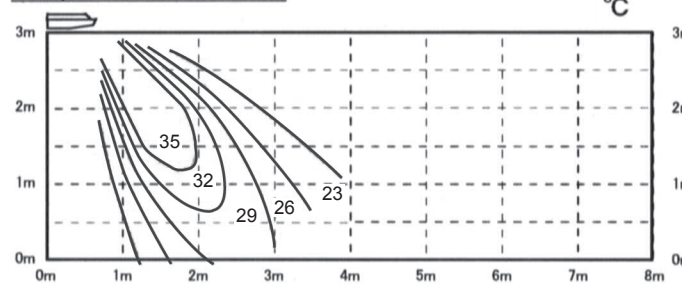

Velocity distribution

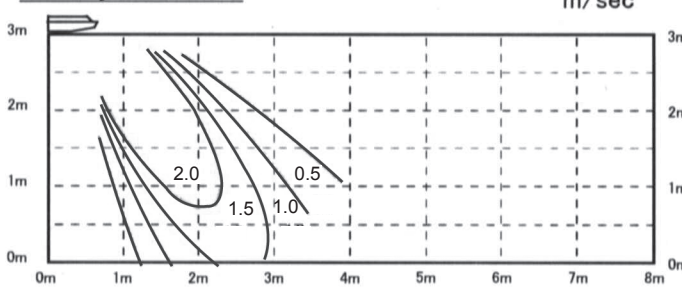

ISD09408

Models FDEN100VF1
Cooling Air flow : P-Hi

Louver position

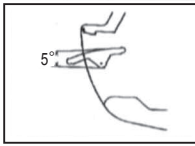

Temperature distribution

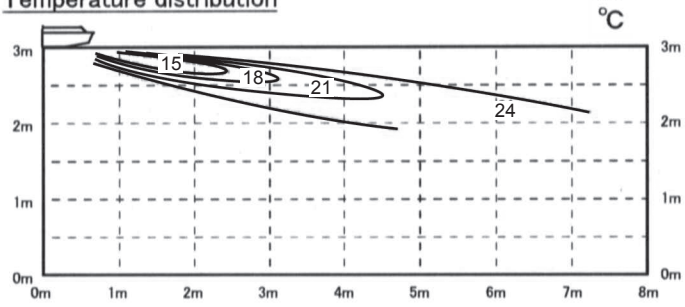

Velocity distribution

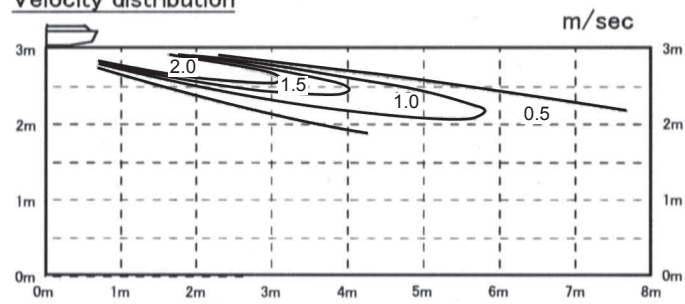

Heating Air flow : P-Hi

Louver position

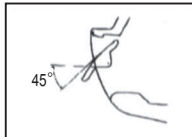

Temperature distribution

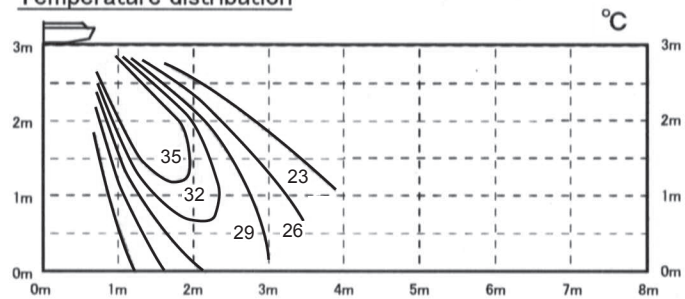

Velocity distribution

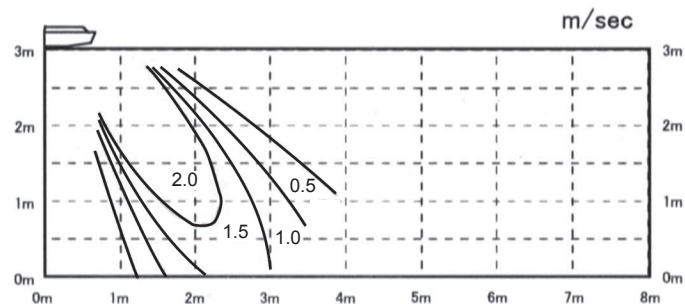

Models FDEN125VF, 140VF

Cooling Air flow : P-Hi

Louver position

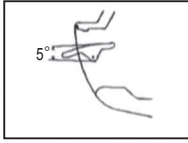

Temperature distribution

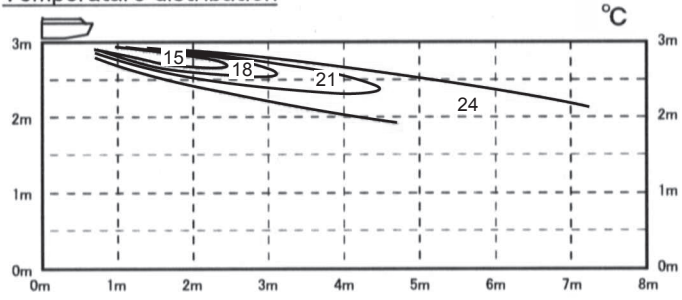

Velocity distribution

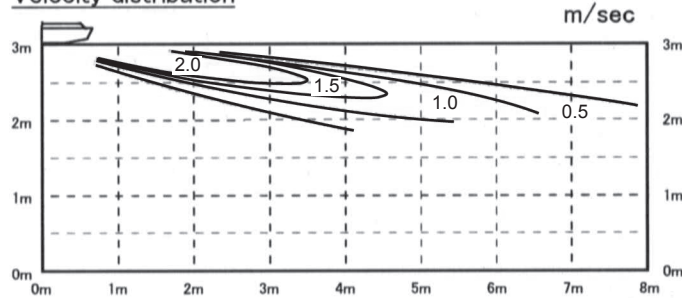

Heating Air flow : P-Hi

Louver position

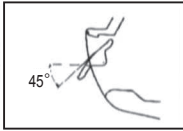

Temperature distribution

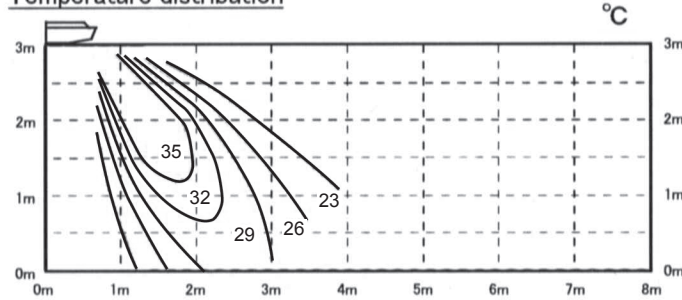

Velocity distribution

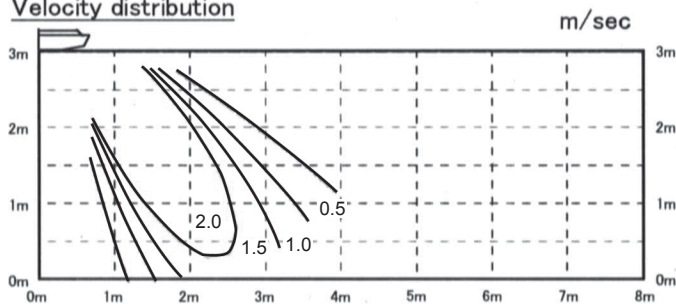

(4) Floor standing type (FDF)

Models FDF71VD1, 100VD1, 125VD, 140VD, 100VD2

(a) Cooling Air flow:Hi (Louver position:Horizontal)

Temperature distribution

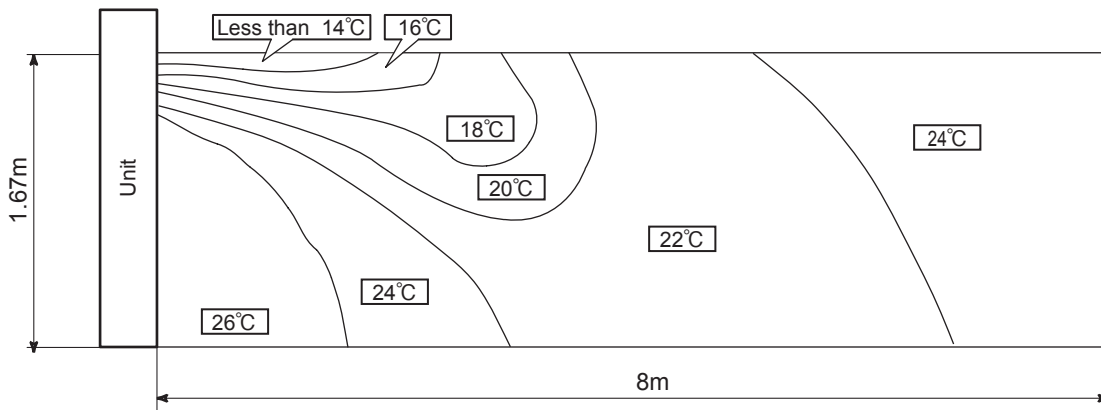

(b) Heating Air flow:Hi (Louver position:Horizontal)

Temperature distribution

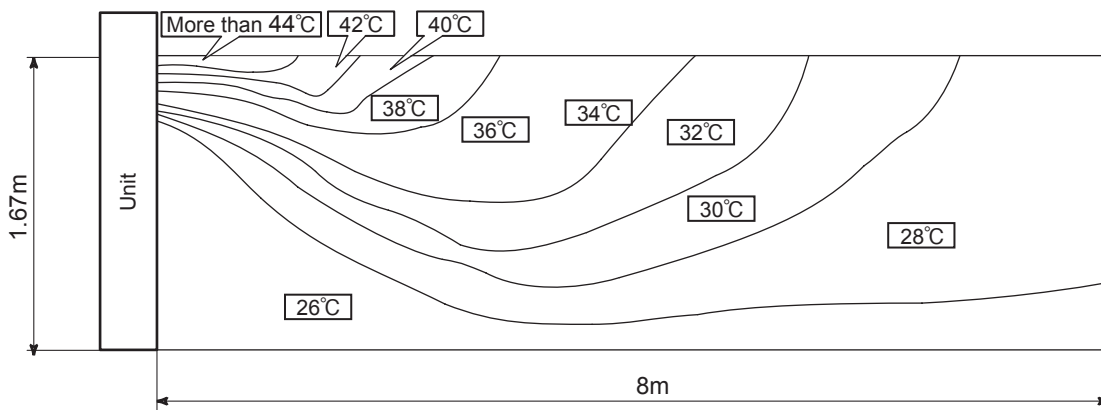

1.7 PIPING SYSTEM

(1) Single type Models 100, 125, 140

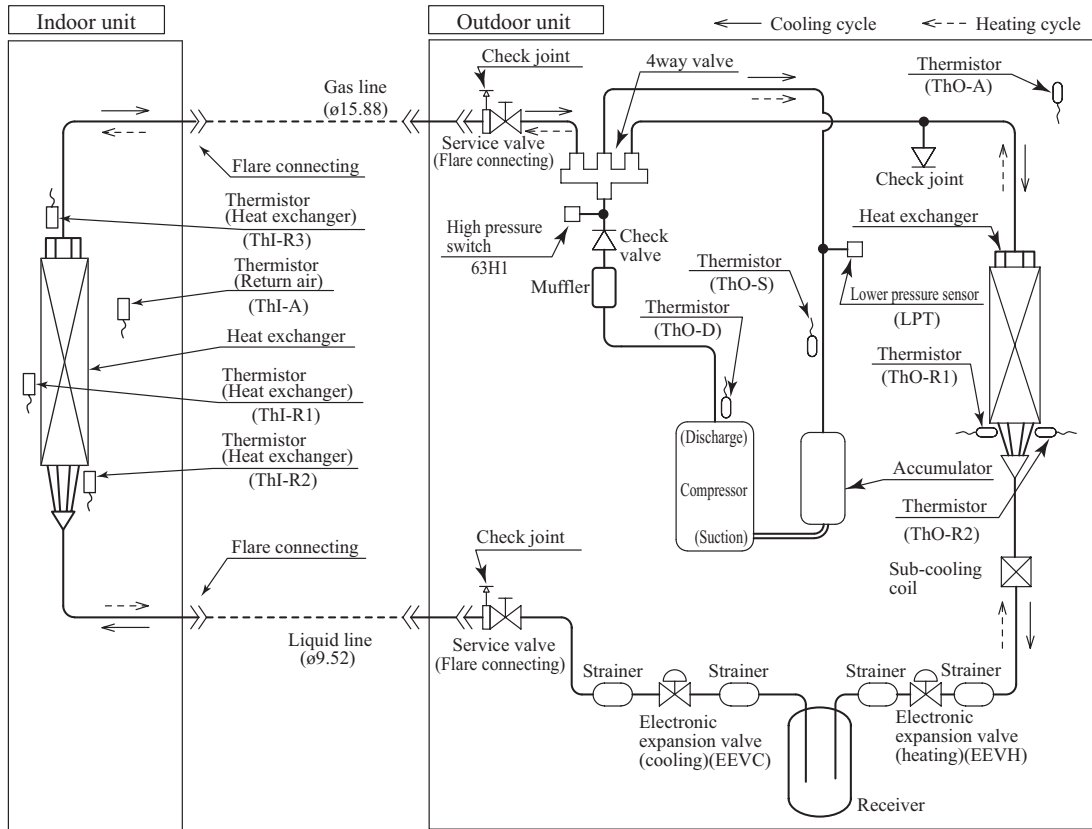

Models 200, 250

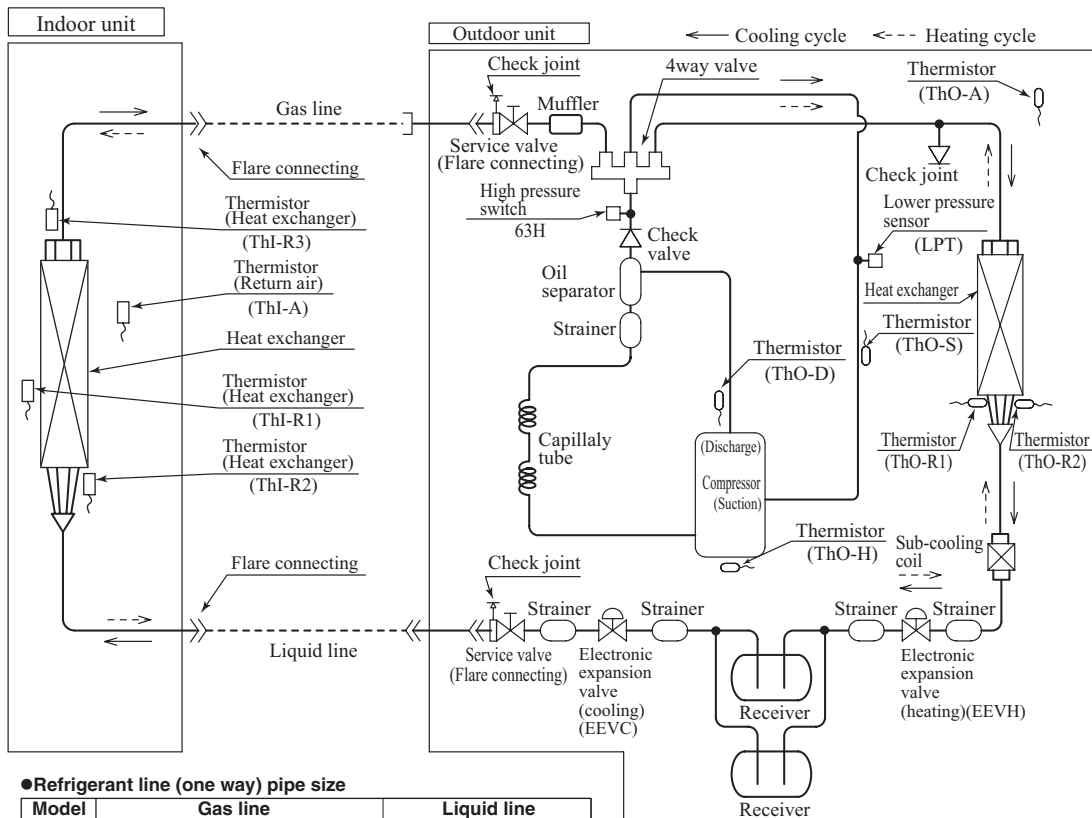

●Refrigerant line (one way) pipe size

Model	Gas line	Liquid line
200	In case of $\phi 22.22$: 35m	In case of $\phi 9.52$: 40m In case of $\phi 12.7$: 70m
250	In case of $\phi 25.4$ or $\phi 28.58$: 70m	In case of $\phi 12.7$: 70m

(2) Twin type

Models 100, 125, 140

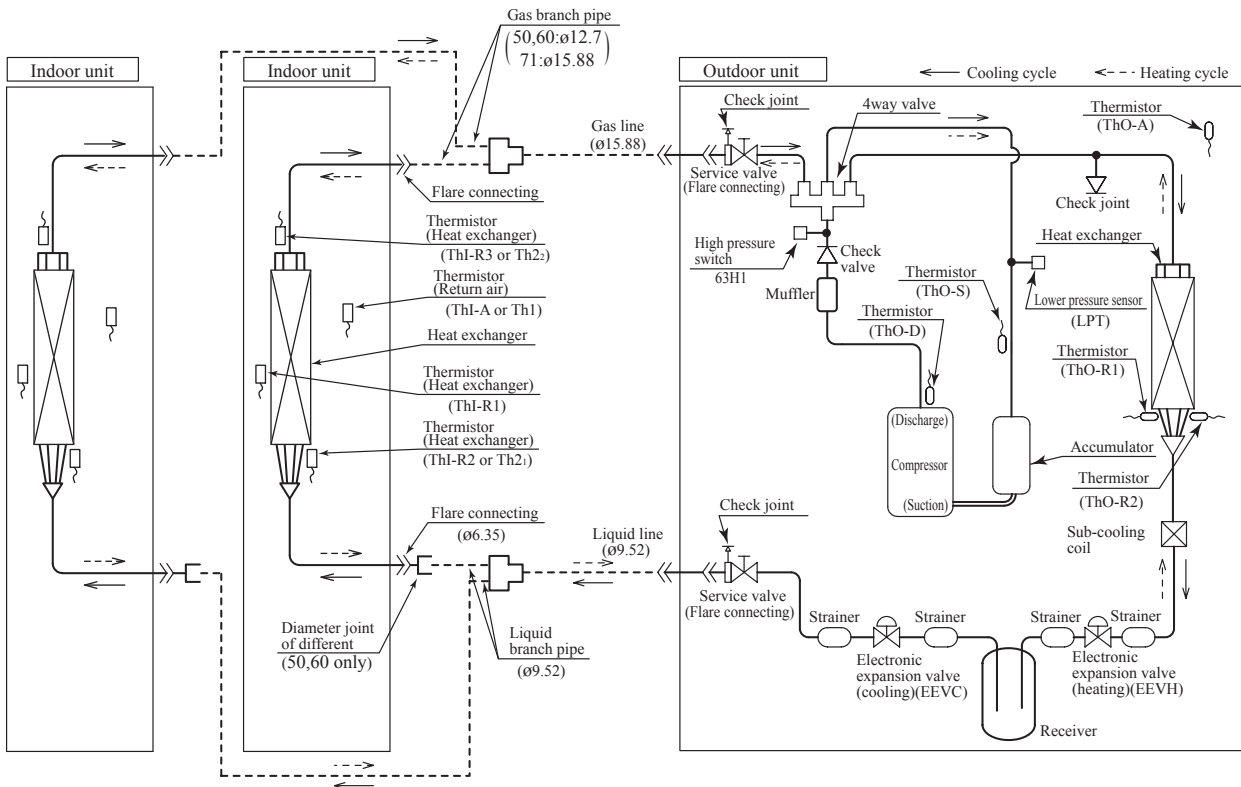

Models 200, 250

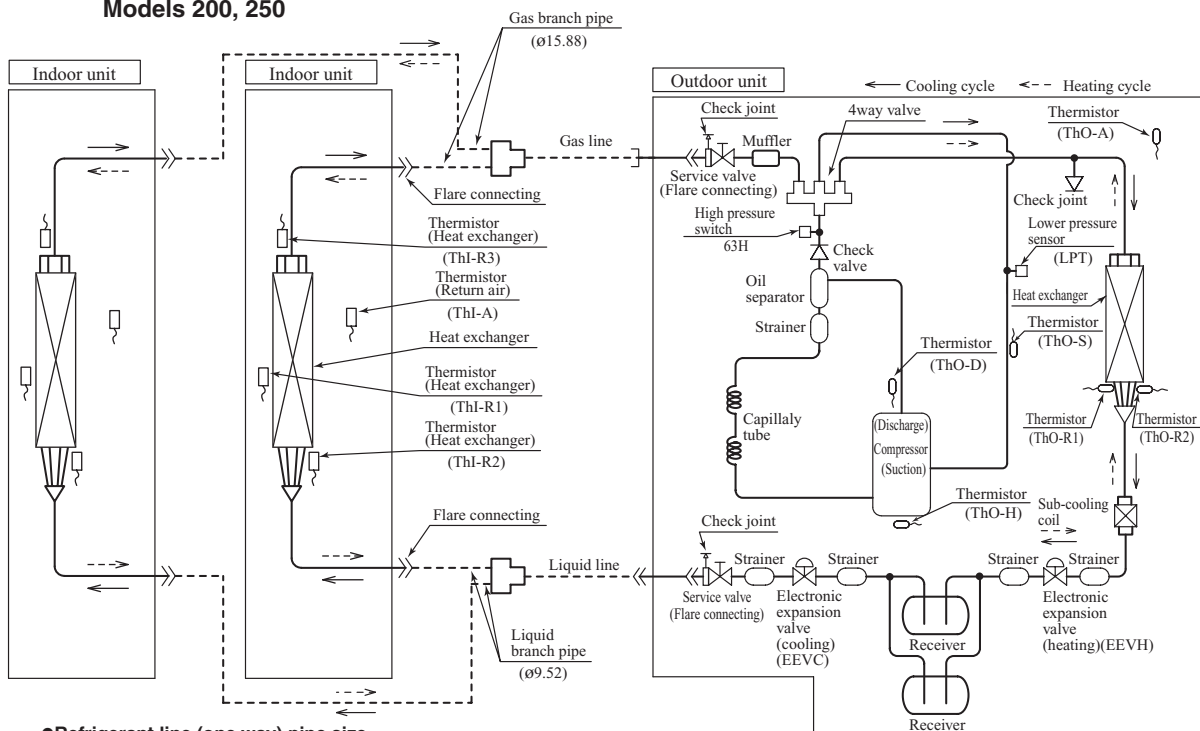

●Refrigerant line (one way) pipe size

Model	Gas line	Liquid line
200	In case of ø22.22 : 35m	In case of ø9.52 : 40m
	In case of ø25.4 or ø28.58 : 70m	In case of ø12.7 : 70m
250		In case of ø12.7 : 70m

**(3) Triple type
Model 140**

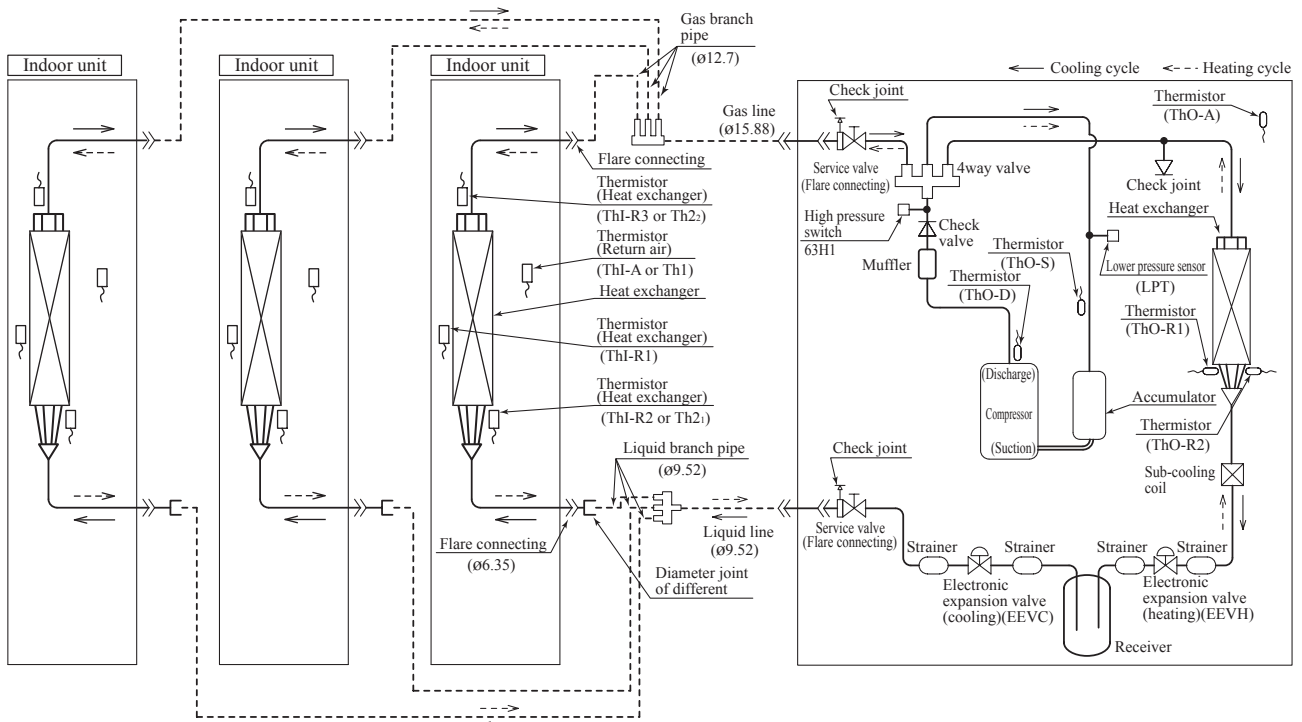

Model 200

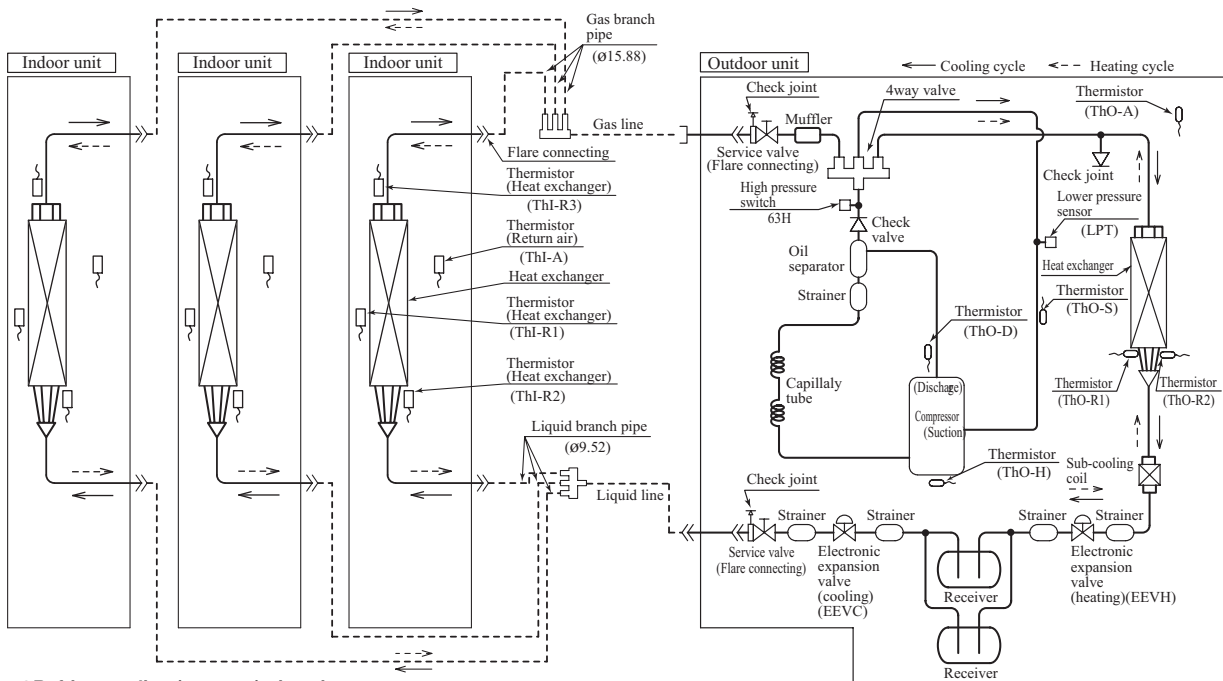

●Refrigerant line (one way) pipe size

Gas line	Liquid line
In case of $\phi 22.22$: 35m	In case of $\phi 9.52$: 40m
In case of $\phi 25.4$ or $\phi 28.58$: 70m	In case of $\phi 12.7$: 70m

(4) Double Twin type
Models 200, 250

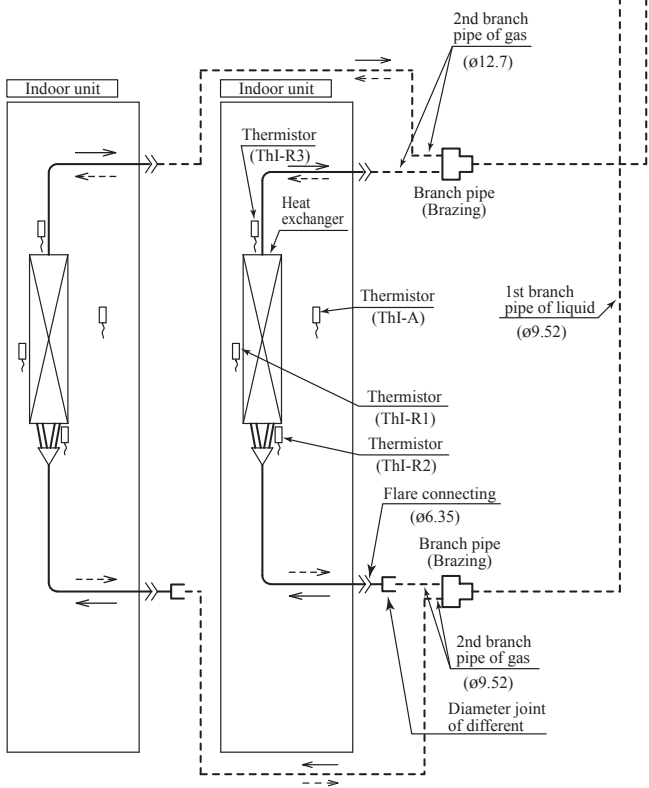
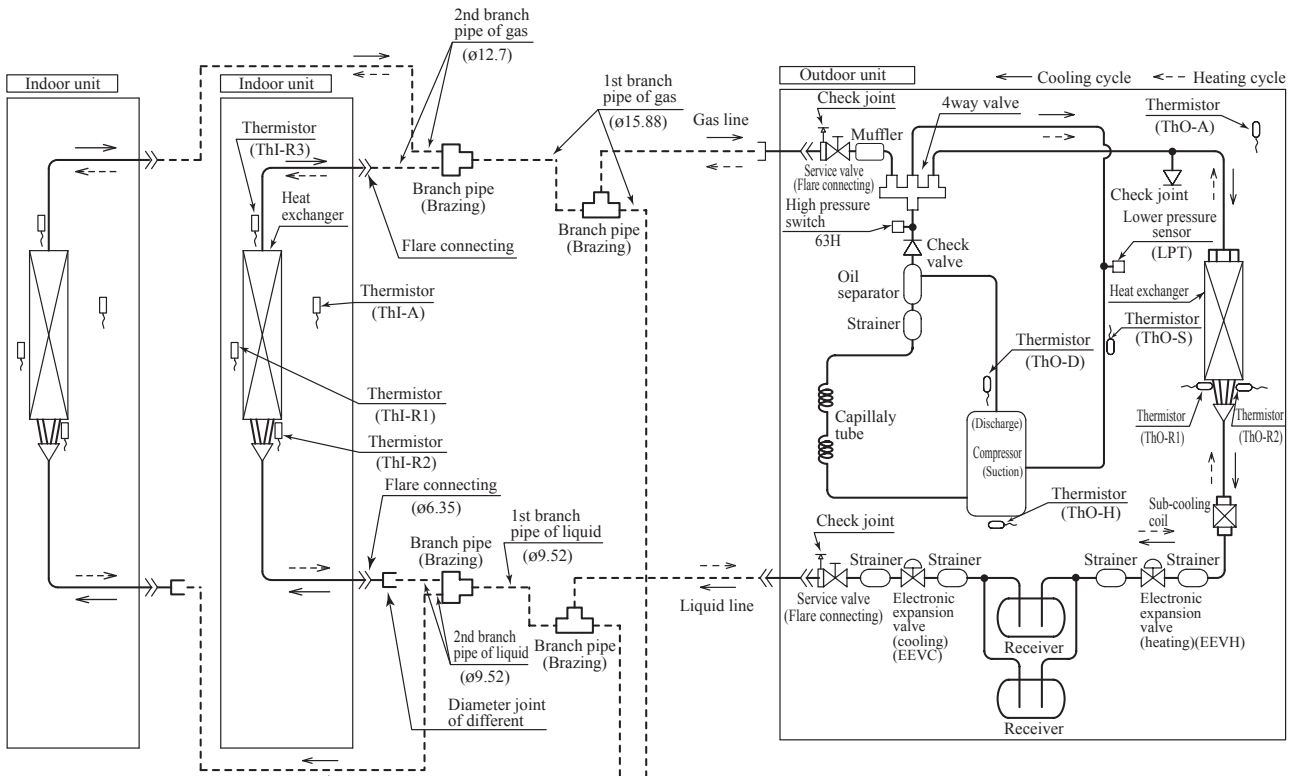

● Refrigerant line (one way) pipe size

Model	Gas line	Liquid line
200	In case of ø22.22 : 35m	In case of ø9.52 : 40m In case of ø12.7 : 70m
250	In case of ø25.4 or ø28.58 : 70m	In case of ø12.7 : 70m

Preset point of the protective devices

Parts name	Mark	Equipped unit	100, 125, 140 model	200, 250 model
Thermistor (for protection overloading in heating)	ThI-R (TH1)	Indoor unit	OFF 63°C (OFF 16°C) ON 56°C (ON 17°C)	
Thermistor (for frost prevention)	ThI-R (TH1)		OFF 63°C (OFF 8°C) ON 56°C (ON 2.5°C)	
Thermistor (for protection high pressure in cooling.)	Tho-R	Outdoor unit	OFF 51°C ON 65°C	
Thermistor (for detecting discharge pipe temp.)	Tho-D	Outdoor unit	OFF 115°C ON 85°C	OFF 135°C ON 90°C
High pressure switch (for protection)	63H1	Outdoor unit	OFF 4.15MPa ON 3.15MPa	
Low pressure sensor (for protection)	LPT	Outdoor unit	OFF 0.227MPa ON 0.079MPa	

Note (1) Values in () are for the SRK models.

1.8 RANGE OF USAGE & LIMITATIONS

Operating temperature range		See next page.
		When used below -5°C, install a snow hood (option).
Recommendable area to install		Considering to get sufficient heating capacity, the area where the averaged lowest ambient air temperature in day time during winter is above 0°C, and it has no accumulation of snow.
Installation site		The limitations of installation space are shown in the page for exterior dimensions. Install the indoor unit at least 2.5m higher than the floor surface.
Temperature and humidity conditions surrounding the indoor unit in the ceiling (Note 2)		Model FDE Dew point temperature : 23°C or less, relative humidity : 80% or less Other models Dew point temperature : 28°C or less, relative humidity : 80% or less
Limitations on unit and piping installation		See pages 157 and 158
Compressor ON-OFF cycling	Cycle Time	7 minutes or more (from OFF to OFF) or (from ON to ON)
	Stop Time	3 minutes or more
Power source	Voltage range	Rating ±10%
	Voltage drop at start-up	Min.85% of rating
	Phase-to-phase imbalance	3% or less

Note 1. Do not install the unit in places which :

- 1) Flammable gas may leak.
- 2) Carbon fiber, metal particles, powder, etc. are floating.
- 3) Cosmetic or special sprays are used frequently.
- 4) Exposed to oil splashes or steam (e.g. kitchen and machine plant).
- 5) Exposed to sea breeze (e.g. coastal area) or calcium chloride (e.g. snow melting agent).
- 6) Exposed to ammonia substance (e.g. organic fertilizer).
- 7) Matters affecting devices, such as sulfuric gas, chlorine gas, acid, alkali, etc. may generate or accumulate.
- 8) Chimney smoke is hanging.
- 9) Sucking the exhaust gas from heat exchanger.
- 10) Adjacent to equipment generating electromagnetic waves or high frequency waves.
- 11) There is light beams that affect the receiving device of indoor unit in case of the wireless specification.
- 12) Snow falls heavily.
- 13) At an elevation of 1000 meters or higher.
- 14) On mobile machine (e.g. vehicle, ship, etc.)
- 15) Splashed with water to indoor unit (e.g. laundry room).
- 16) Indoor units of twin, triple and double-twin specifications separately in a room with partition.

Note 2. If ambient temperature and humidity exceed the above conditions, add polyurethane foam insulation (10mm or thicker) on the outer plate of indoor unit.

Note 3. Both gas and liquid pipes need to be covered with 20mm or thicker heat insulation materials at the place where humidity exceeds 70%.

Operating temperature range

■ Cooling

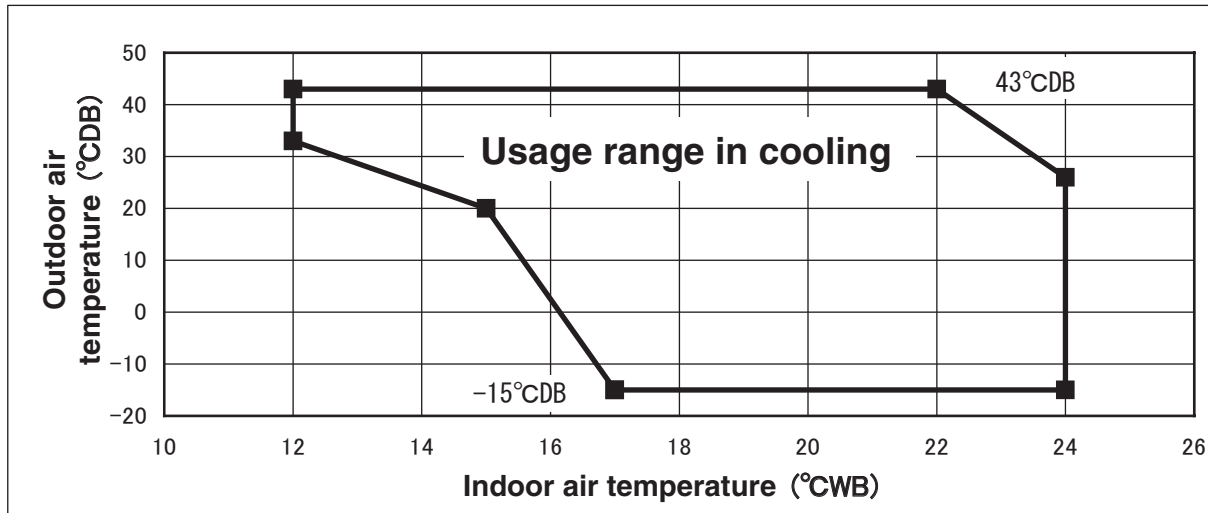

■ Heating

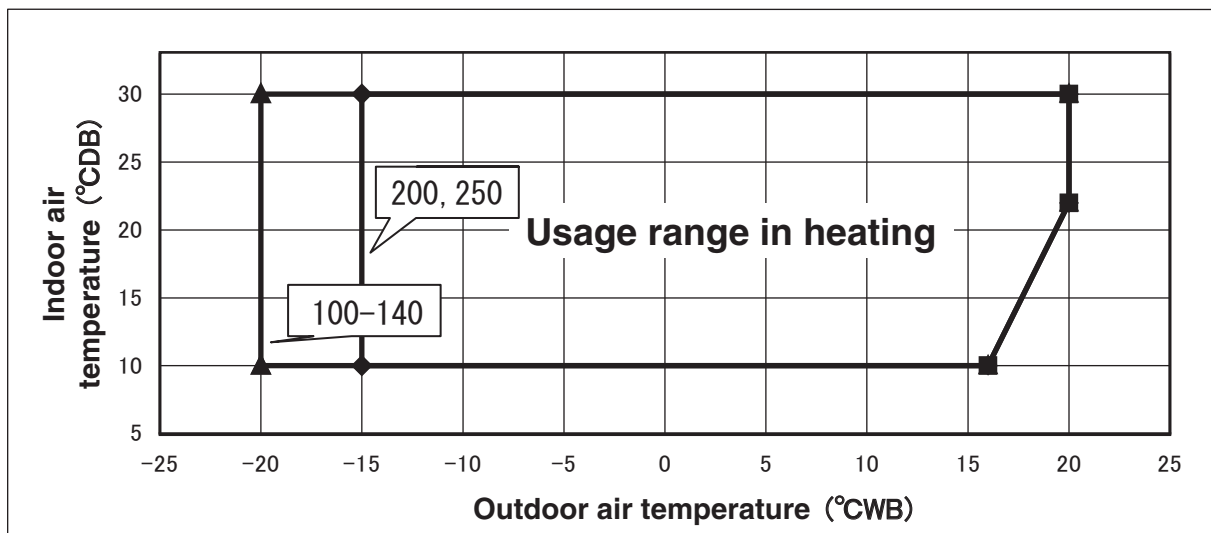

Decline in cooling and heating capacity or operation stop may occur when the outdoor unit is installed in places where natural wind can increase or decrease its design airflow rate.

PCA001Z561 

“CAUTION” Cooling operation under low outdoor air temperature conditions

PAC models can be operated in cooling mode at low outdoor air temperature condition within above temperature range. However in case of severely low temperature conditions if the following precaution is not observed, it may not be operated in spite of operable temperature range mentioned above and cooling capacity may not be established under certain conditions.

[Precaution]

In case of severely low temperature condition

- 1) Install the outdoor unit at the place where strong wind cannot blow directly into the outdoor unit.
- 2) If there is no installation place where can prevent strong wind from directly blowing into the outdoor unit, mount the flex flow adapter (prepared as option part) or like such devices onto the outdoor unit in order to divert the strong wind.

[Reason]

Under the low outdoor air temperature conditions of -5°C or lower, the outdoor fan is controlled at lower or lowest speed by outdoor fan control, but if strong wind directly blow into the outdoor unit, the outdoor heat exchanger temperature will drop more. This makes high and low pressures to drop as well. This low pressure drop makes the indoor heat exchanger temperature to drop and will activate anti-frost control at indoor heat exchanger at frequent intervals, that cooling operation may not be established for any given time.

Limitation on unit and piping installation - single,twin,Double twin.

Descriptions	Model for outdoor units		Dimensional limitations	Marks appearing in the drawing			
				Single type	Twin type	Double-Twin type	
One-way pipe length	100V · 125V · 140V		≦ 50m	L	L+L1+L2	L+La+L1 L+La+L2 L+Lb+L3 L+Lb+L4	
	200V	Liquid piping	φ 9.52				≦ 40m
		φ 12.7	≦ 70m				
	200V · 250V	Gas piping	φ 25.4 or φ 28.58				≦ 35m
φ 22.22							
Main pipe length	100V · 125V · 140V		≦ 50m	L	L		
	200V	Liquid piping	φ 9.52			≦ 40m	
		φ 12.7	≦ 70m				
	200V · 250V	Gas piping	φ 25.4 or φ 28.58			≦ 35m	
φ 22.22							
One-way pipe length after the first branching point	100V · 125V · 140V 200V · 250V		≦ 30m			La+L1, La+L2, Lb+L3, Lb+L4	
Difference of pipe length after the first branching point			≦ 10m		L1-L2 L2-L1	L1-L2, L2-L1, L3-L4, L4-L3 (L1+La)-(L3+Lb), (L1+La)-(L4+Lb) (L2+La)-(L3+Lb), (L2+La)-(L4+Lb)	
Total pipe length after the second branching point			≦ 15m			L1+L2, L3+L4	
Elevation difference between indoor and outdoor units	When the outdoor unit is positioned higher		≦ 30m	H	H	H	
	When the outdoor unit is positioned lower		≦ 15m				
Elevation difference among indoor units			≦ 0.5m		h	h1, h2, h3, h4, h5, h6	

Single type

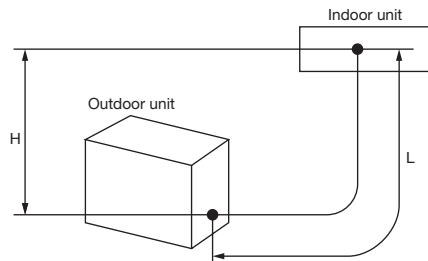

Twin type

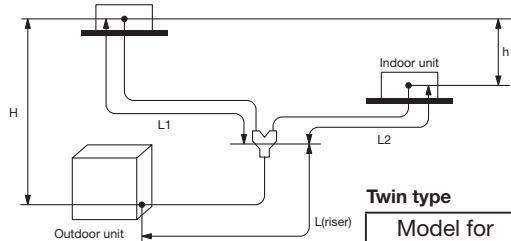

Twin type

Model for outdoor units	Branch piping set(option)
100V · 125V 140V	DIS-WA1
200V · 250V	DIS-WB1

Double-Twin type

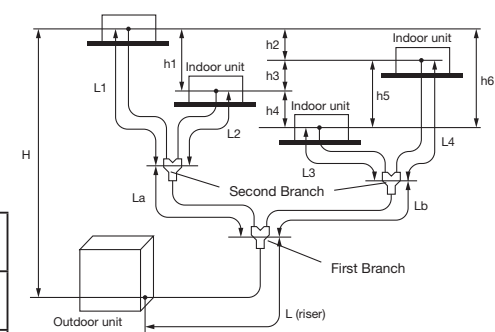

Double-Twin type

Model for outdoor units	Branch piping set(option)	
	First Branch	Second Branch
200V · 250V	DIS-WB1	DIS-WA1×2

(1) A riser pipe must be part of the main.

A branching pipe set should be installed horizontally at a point as close to an indoor unit as possible.

(2) Reduce refrigerant amount by according to table below from factory charge when refrigerant piping is shorter than 3m.

Model for outdoor units	refrigerant to be reduced
100V · 125V · 140V · 200V · 250V	-1.0kg

Limitation on unit and piping installation - triple.					Marks appearing in the drawing	
Triple type (In case of 140V・200V)	One-way pipe length difference from the first branching point to the indoor unit					
	Model for outdoor units		Dimensional limitations	< 3m	≥ 3m	
Descriptions				Triple type A	Triple type B	
One-way pipe length	140V	Liquid piping φ 9.52 φ 12.7	≤ 50m	L+L1, L+L2, L+L3	L+La+L1+L2+L3 ※ 1	
	200V		≤ 40m			
		Gas piping φ 25.4 or φ 28.58 φ 22.22	≤ 70m	L+L1, L+L2, L+L3	L+L1 ※ 1	
			≤ 35m			
Main pipe length	140V	Liquid piping φ 9.52 φ 12.7	≤ 50m	L	L	
	200V		≤ 40m			
		Gas piping φ 25.4 or φ 28.58 φ 22.22	≤ 70m			
			≤ 35m			
Piping length between the first branching point and the second branching point					La	
One-way pipe length between the first branching point and indoor units				L1, L2, L3	L1 ※ 1	
One-way pipe length from the first branching point to indoor units through the second branching point					La+L2, La+L3 ※ 1	
Piping length difference from the first branching point to indoor unit				< 3m	L1-L2, L1-L3, L2-L3	
				3m ≤ , ≤ 10m	L1-(La+L2), L1-(La+L3) ※ 1	
One-way pipe length difference from the second branching point to indoor unit				≤ 10m	L2-L3, L3-L2	
Elevation difference between indoor and outdoor units	When the outdoor unit is positioned higher		≤ 30m	H	H	
	When the outdoor unit is positioned lower		≤ 15m			
Elevation difference among indoor units				≤ 0.5m	h1, h2, h3	
Triple type (in case of 250V)					Marks appearing in the drawing	
Restrictions	One-way pipe length difference from the first branching point to the indoor unit					
	Model for outdoor units		Dimensional restrictions	< 3m	≥ 3m	
One-way pipe length		Gas piping φ 22.22 φ 25.4 or φ 28.58	≤ 35m	L+L1, L+La+L2, L+La+L3 ※ 2	Prohibition of use	
			≤ 70m			
Main pipe length		Gas piping φ 22.22 φ 25.4 or φ 28.58	≤ 35m	L	Prohibition of use	
			≤ 70m			
One-way pipe length between the first branching point from to the second branching point				La	Prohibition of use	
One-way pipe length between the first branching point and indoor units				L1, La+L2, La+L3 ※ 2		
Piping length difference from the first branching point to indoor unit				< 3m	L1-(La+L2), L1-(La+L3) L2-L3, L3-L2 ※ 2	
Elevation difference between indoor and outdoor units	When the outdoor unit is positioned higher		≤ 30m	H	Prohibition of use	
	When the outdoor unit is positioned lower		≤ 15m			
Elevation difference among indoor units				≤ 0.5m	h1, h2, h3	

Triple type A

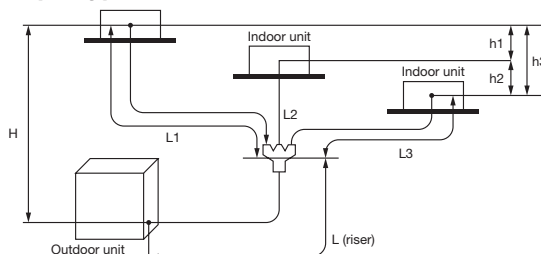

Triple type B

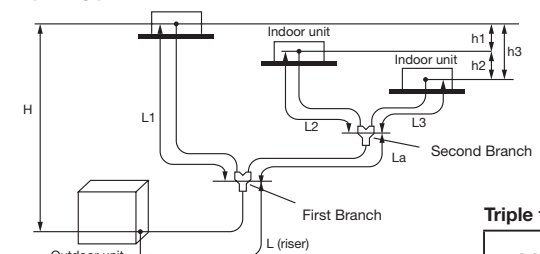

※ 1 Install the indoor units so that L+L1 becomes the longest one-way pipe. Keep the pipe length difference between L1 and (La+L2) or (La+L3) within 10m.

※ 2 Connect the unit that is the maximum capacity with L1.

Triple type Model for outdoor units	Branch piping set(option)		
	Type A	Type B	
	Branch pipe	First Branch	Second Branch
140V	DIS-TA1	DIS-WA1	DIS-WA1
200V・250V	DIS-TB1	DIS-WB1	DIS-WA1

(1) A riser pipe must be part of the main.
A branching pipe set should be installed horizontally at a point as close to an indoor unit as possible.

(2) Reduce refrigerant amount by 1.0kg from the factory charge when refrigerant piping is shorter than 3m.

1.9 SELECTION CHART

Correct the cooling and heating capacity in accordance with the operating conditions. The net cooling and heating capacity can be obtained in the following way.

Net capacity = Capacity shown in the capacity tables (1.9.1) × Correction factors shown in the table (1.9.2) (1.9.3) (1.9.4).

Caution: In case that the cooling operation during low outdoor air temperature below -5°C is expected, install the outdoor unit where it is not influenced by natural wind. Otherwise protection control by low pressure will be activated much more frequently and it will cause insufficient capacity or breakdown of the compressor in worst case.

1.9.1 Capacity tables

(1) Ceiling cassette-4way type (FDT) (a) Single type

Model Cool Mode	FDT100VNVF1,100VNVF2																Indoor unit 100VF1						Outdoor unit 100VF2						FDC100VN												
																			(kW)												Heat Mode:HC						(kW)				
Outdoor air temp.	Indoor air temperature																								Outdoor air temp.		Indoor air temperature														
	18 DB		21 DB		23 DB		26 DB		27 DB		28 DB		31 DB		33 DB		DB		DB																						
	12 WB	14 WB	16 WB	18 WB	19 WB	20 WB	22 WB	24 WB	DB	WB	16	18	20	22	24																										
DB	TC	SHC	TC	SHC	TC	SHC	TC	SHC	TC	SHC	TC	SHC	TC	SHC	TC	SHC	TC	SHC	TC	SHC	TC	SHC	TC	SHC	TC	SHC	TC	SHC													
11					8.12	7.72	8.59	8.42	8.82	8.36	9.07	8.28	9.56	8.83	10.06	8.64	-19.8	-20	5.64	5.62	5.60	5.58	5.56	-17.7	-18	5.97	5.95	5.92	5.90	5.87											
13					8.50	7.86	9.00	8.58	9.26	8.50	9.52	8.42	10.06	8.96	10.60	8.76	-15.7	-16	6.30	6.27	6.25	6.22	6.19	-13.5	-14	6.66	6.63	6.60	6.57	6.54											
15					8.88	7.99	9.42	8.72	9.69	8.64	9.98	8.55	10.56	9.09	11.14	8.89	-11.5	-12	7.03	6.99	6.96	6.93	6.90	-9.5	-10	7.39	7.36	7.32	7.29	7.25											
17					9.26	8.13	9.84	8.86	10.12	8.77	10.43	8.69	11.05	9.22	11.67	9.02	-7.5	-8	7.75	7.72	7.68	7.64	7.60	-5.5	-6	7.92	7.88	7.85	7.80	7.76											
19					9.46	8.21	10.05	8.93	10.34	8.84	10.65	8.76	11.29	9.29	11.92	9.08	-3.0	-4	8.10	8.05	8.01	7.97	7.92	-1.0	-2	8.27	8.22	8.18	8.13	8.08											
21					9.65	8.28	10.25	9.00	10.56	8.91	10.88	8.83	11.52	9.35	12.16	9.14	1.0	0	8.44	8.39	8.34	8.29	8.24	2.0	1	8.52	8.47	8.42	8.37	8.32											
23					9.65	8.28	10.28	9.01	10.59	8.92	10.91	8.84	11.56	9.36	12.21	9.15	3.0	2	9.08	9.03	8.98	8.94	8.90	4.0	3	9.16	9.11	9.06	9.01	8.96											
25				8.93	8.49	9.64	8.27	10.31	9.02	10.62	8.93	10.95	8.85	11.61	9.38	12.27	9.17	5.0	4	10.21	10.15	10.09	10.08	10.07	6.0	5	10.29	10.23	10.17	10.11	10.05										
27				8.86	8.46	9.64	8.27	10.34	9.03	10.65	8.94	10.96	8.85	11.57	9.37			7.0	6	11.33	11.27	11.20	11.22	11.23	8.0	7	11.38	11.31	11.24	11.17	11.10										
29				8.80	8.44	9.50	8.22	10.17	8.97	10.49	8.89	10.81	8.81	11.45	9.33			9.0	8	11.78	11.71	11.64	11.62	11.59	10.0	8	11.78	11.71	11.64	11.62	11.59										
31				8.73	8.41	9.35	8.17	9.99	8.91	10.32	8.84	10.66	8.76	11.32	9.30			11.5	10	12.23	12.16	12.09	12.02	11.94	11.5	10	12.23	12.16	12.09	12.02	11.94										
33	8.22	7.78	8.58	8.35	9.21	8.11	9.82	8.85	10.16	8.78	10.51	8.71	11.19	9.26			13.5	12	12.91	12.83	12.75	12.65	12.60	15.5	14	13.59	13.50	13.42	13.29	13.26											
35	8.05	7.71	8.44	8.27	9.06	8.06	9.64	8.79	10.00	8.73	10.36	8.67	11.07	9.23			16.5	16	13.93	13.84	13.75	13.61	13.59	16.5	16	13.93	13.84	13.75	13.61	13.59											
37	7.92	7.65	8.30	8.13	8.91	8.00	9.46	8.73	9.79	8.67	10.13	8.60	10.80	9.16																											
39	7.78	7.59	8.16	8.00	8.75	7.95	9.28	8.67	9.59	8.60	9.90	8.53	10.53	9.08																											
41	7.64	7.49	8.02	7.86	8.60	7.89	9.09	8.61	9.38	8.54	9.68	8.46	10.26	9.01																											
43	7.50	7.35	7.88	7.72	8.45	7.84	8.91	8.55	9.18	8.48	9.45	8.40	9.99	8.94																											

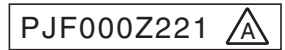

Model Cool Mode	FDT100VSVF1,100VSVF2																Indoor unit 100VF1						Outdoor unit 100VF2						FDC100VS												
																			(kW)												Heat Mode:HC						(kW)				
Outdoor air temp.	Indoor air temperature																								Outdoor air temp.		Indoor air temperature														
	18 DB		21 DB		23 DB		26 DB		27 DB		28 DB		31 DB		33 DB		DB		DB																						
	12 WB	14 WB	16 WB	18 WB	19 WB	20 WB	22 WB	24 WB	DB	WB	16	18	20	22	24																										
DB	TC	SHC	TC	SHC	TC	SHC	TC	SHC	TC	SHC	TC	SHC	TC	SHC	TC	SHC	TC	SHC	TC	SHC	TC	SHC	TC	SHC	TC	SHC	TC	SHC													
11					8.12	7.72	8.59	8.42	8.82	8.36	9.07	8.28	9.56	8.83	10.06	8.64	-19.8	-20	5.64	5.62	5.60	5.58	5.56	-17.7	-18	5.97	5.95	5.92	5.90	5.87											
13					8.50	7.86	9.00	8.58	9.26	8.50	9.52	8.42	10.06	8.96	10.60	8.76	-15.7	-16	6.30	6.27	6.25	6.22	6.19	-13.5	-14	6.66	6.63	6.60	6.57	6.54											
15					8.88	7.99	9.42	8.72	9.69	8.64	9.98	8.55	10.56	9.09	11.14	8.89	-11.5	-12	7.03	6.99	6.96	6.93	6.90	-9.5	-10	7.39	7.36	7.32	7.29	7.25											
17					9.26	8.13	9.84	8.86	10.12	8.77	10.43	8.69	11.05	9.22	11.67	9.02	-7.5	-8	7.75	7.72	7.68	7.64	7.60	-5.5	-6	7.92	7.88	7.85	7.80	7.76											
19					9.46	8.21	10.05	8.93	10.34	8.84	10.65	8.76	11.29	9.29	11.92	9.08	-3.0	-4	8.10	8.05	8.01	7.97	7.92	-1.0	-2	8.27	8.22	8.18	8.13	8.08											
21					9.65	8.28	10.25	9.00	10.56	8.91	10.88	8.83	11.52	9.35	12.16	9.14	1.0	0	8.44	8.39	8.34	8.29	8.24	2.0	1	8.52	8.47	8.42	8.37	8.32											
23					9.65	8.28	10.28	9.01	10.59	8.92	10.91	8.84	11.56	9.36	12.21	9.15	3.0	2	9.08	9.03	8.98	8.94	8.90	4.0	3	9.16	9.11	9.06	9.01	8.96											
25				8.93	8.49	9.64	8.27	10.31	9.02	10.62	8.93	10.95	8.85	11.61	9.38	12.27	9.17	5.0	4	10.21	10.15	10.09	10.08	10.07	6.0	5	10.29	10.23	10.17	10.11	10.05										
27				8.86	8.46	9.64	8.27	10.34	9.03	10.65	8.94	10.96	8.85	11.57	9.37			7.0	6	11.33	11.27	11.20	11.22	11.23	8.0	7	11.38	11.31	11.24	11.17	11.10										
29				8.80	8.44	9.50	8.22	10.17	8.97	10.49	8.89	10.81	8.81	11.45	9.33			9.0	8	11.78	11.71	11.64	11.62	11.59	10.0	8	11.78	11.71	11.64	11.62	11.59										
31				8.73	8.41	9.35	8.17	9.99	8.91	10.32	8.84	10.66	8.76	11.32	9.30			11.5	10	12.23	12.16	12.09	12.02	11.94	11.5	10	12.23	12.16	12.09	12.02	11.94										
33	8.22	7.78	8.58	8.35	9.21	8.11	9.82	8.85	10.16	8.78	10.51	8.71	11.19	9.26			13.5	12	12.91	12.83	12.75	12.65	12.60	15.5	14	13.59	13.50	13.42	13.29	13.26											
35	8.05	7.71	8.44	8.27	9.06	8.06	9.64	8.79	10.00	8.73	10.36	8.67	11.07	9.23			16.5	16	13.93	13.84	13.75	13.61	13.59	16.5	16	13.93	13.84	13.75	13.61	13.59											
37	7.92	7.65	8.30	8.13	8.91	8.00	9.46	8.73	9.79	8.67	10.13	8.60	10.80	9.16																											
39	7.78	7.59	8.16	8.00	8.75	7.95	9.28	8.67	9.59	8.60	9.90	8.53	10.53	9.08																											
41	7.64	7.49	8.02	7.86	8.60	7.89	9.09	8.61	9.38	8.54	9.68	8.46	10.26	9.01																											
43	7.50	7.35	7.88	7.72	8.45	7.84	8.91	8.55	9.18	8.48	9.45	8.40	9.99	8.94																											

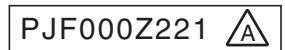

Note(1) These data show average statuses.
Depending on the system control, there may be ranges where the operation is not conducted continuously.
These data show the case where the operation frequency of a compressor is fixed.

(2) Capacities are based on the following conditions.
Corresponding refrigerant piping length :7.5m
Level difference of Zero.

(3) Symbols are as follows.
TC : Total cooling capacity (kW)
SHC : Sensible heat capacity (kW)
HC : Heating capacity (kW)

Model FDT125VNVF Indoor unit FDT125VF Outdoor unit FDC125VN
 Cool Mode

(kW) Heat Mode:HC (kW)

Outdoor air temp.	Indoor air temperature															
	18 DB		21 DB		23 DB		26 DB		27 DB		28 DB		31 DB		33 DB	
	12 WB		14 WB		16 WB		18 WB		19 WB		20 WB		22 WB		24 WB	
DB	TC	SHC	TC	SHC	TC	SHC	TC	SHC	TC	SHC	TC	SHC	TC	SHC	TC	SHC
11					10.15	8.86	10.74	9.60	11.03	9.53	11.34	9.46	11.96	10.01	12.57	9.83
13					10.63	9.06	11.26	9.80	11.57	9.72	11.91	9.65	12.58	10.21	13.25	10.03
15					11.10	9.25	11.78	10.00	12.11	9.92	12.47	9.85	13.20	10.41	13.92	10.23
17					11.58	9.45	12.29	10.20	12.65	10.13	13.04	10.06	13.82	10.62	14.59	10.43
19					11.82	9.55	12.56	10.30	12.92	10.23	13.32	10.16	14.11	10.71	14.90	10.52
21					12.06	9.66	12.82	10.41	13.19	10.33	13.60	10.26	14.40	10.81	15.20	10.61
23					12.06	9.66	12.85	10.42	13.23	10.35	13.64	10.28	14.45	10.83	15.27	10.64
25			11.16	9.82	12.06	9.66	12.89	10.44	13.27	10.36	13.68	10.29	14.51	10.85	15.34	10.66
27			11.08	9.78	12.05	9.65	12.92	10.45	13.31	10.38	13.69	10.29	14.47	10.83		
29			11.00	9.74	11.87	9.58	12.71	10.36	13.11	10.30	13.51	10.23	14.31	10.78		
31			10.92	9.71	11.69	9.50	12.49	10.28	12.90	10.22	13.32	10.16	14.15	10.73		
33	10.27	9.05	10.72	9.62	11.51	9.42	12.27	10.19	12.70	10.15	13.13	10.09	13.99	10.67		
35	10.07	8.95	10.55	9.54	11.33	9.35	12.06	10.11	12.50	10.07	12.94	10.02	13.83	10.62		
37	9.90	8.87	10.38	9.46	11.13	9.26	11.83	10.02	12.24	9.97	12.66	9.92	13.50	10.51		
39	9.72	8.78	10.20	9.38	10.94	9.18	11.60	9.93	11.99	9.88	12.38	9.82	13.16	10.40		
41	9.55	8.70	10.02	9.30	10.75	9.10	11.37	9.84	11.73	9.78	12.09	9.72	12.82	10.29		
43	9.38	8.62	9.85	9.23	10.56	9.03	11.14	9.75	11.47	9.69	11.81	9.62	12.48	10.18		

Outdoor air temp.	Indoor air temperature					
	DB					
DB	WB	16	18	20	22	24
-19.8	-20	7.06	7.03	7.00	6.97	6.95
-17.7	-18	7.46	7.43	7.41	7.37	7.34
-15.7	-16	7.87	7.84	7.81	7.77	7.74
-13.5	-14	8.33	8.29	8.26	8.22	8.18
-11.5	-12	8.78	8.74	8.70	8.66	8.62
-9.5	-10	9.24	9.19	9.15	9.11	9.06
-7.5	-8	9.69	9.65	9.60	9.55	9.50
-5.5	-6	9.91	9.86	9.81	9.75	9.70
-3.0	-4	10.12	10.07	10.01	9.96	9.90
-1.0	-2	10.33	10.28	10.22	10.16	10.10
1.0	0	10.55	10.49	10.43	10.36	10.30
2.0	1	10.65	10.59	10.53	10.47	10.40
3.0	2	11.36	11.29	11.22	11.18	11.13
5.0	4	12.76	12.69	12.61	12.60	12.58
7.0	6	14.16	14.08	14.00	14.02	14.04
9.0	8	14.72	14.64	14.56	14.52	14.49
11.5	10	15.28	15.20	15.11	15.02	14.93
13.5	12	16.13	16.04	15.94	15.82	15.75
15.5	14	16.98	16.88	16.77	16.62	16.58
16.5	16	17.41	17.30	17.19	17.02	16.99

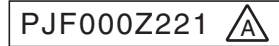

Model FDT125VSFV Indoor unit FDT125VF Outdoor unit FDC125VS
 Cool Mode

(kW) Heat Mode:HC (kW)

Outdoor air temp.	Indoor air temperature															
	18 DB		21 DB		23 DB		26 DB		27 DB		28 DB		31 DB		33 DB	
	12 WB		14 WB		16 WB		18 WB		19 WB		20 WB		22 WB		24 WB	
DB	TC	SHC	TC	SHC	TC	SHC	TC	SHC	TC	SHC	TC	SHC	TC	SHC	TC	SHC
11					10.15	8.86	10.74	9.60	11.03	9.53	11.34	9.46	11.96	10.01	12.57	9.83
13					10.63	9.06	11.26	9.80	11.57	9.72	11.91	9.65	12.58	10.21	13.25	10.03
15					11.10	9.25	11.78	10.00	12.11	9.92	12.47	9.85	13.20	10.41	13.92	10.23
17					11.58	9.45	12.29	10.20	12.65	10.13	13.04	10.06	13.82	10.62	14.59	10.43
19					11.82	9.55	12.56	10.30	12.92	10.23	13.32	10.16	14.11	10.71	14.90	10.52
21					12.06	9.66	12.82	10.41	13.19	10.33	13.60	10.26	14.40	10.81	15.20	10.61
23					12.06	9.66	12.85	10.42	13.23	10.35	13.64	10.28	14.45	10.83	15.27	10.64
25			11.16	9.82	12.06	9.66	12.89	10.44	13.27	10.36	13.68	10.29	14.51	10.85	15.34	10.66
27			11.08	9.78	12.05	9.65	12.92	10.45	13.31	10.38	13.69	10.29	14.47	10.83		
29			11.00	9.74	11.87	9.58	12.71	10.36	13.11	10.30	13.51	10.23	14.31	10.78		
31			10.92	9.71	11.69	9.50	12.49	10.28	12.90	10.22	13.32	10.16	14.15	10.73		
33	10.27	9.05	10.72	9.62	11.51	9.42	12.27	10.19	12.70	10.15	13.13	10.09	13.99	10.67		
35	10.07	8.95	10.55	9.54	11.33	9.35	12.06	10.11	12.50	10.07	12.94	10.02	13.83	10.62		
37	9.90	8.87	10.38	9.46	11.13	9.26	11.83	10.02	12.24	9.97	12.66	9.92	13.50	10.51		
39	9.72	8.78	10.20	9.38	10.94	9.18	11.60	9.93	11.99	9.88	12.38	9.82	13.16	10.40		
41	9.55	8.70	10.02	9.30	10.75	9.10	11.37	9.84	11.73	9.78	12.09	9.72	12.82	10.29		
43	9.38	8.62	9.85	9.23	10.56	9.03	11.14	9.75	11.47	9.69	11.81	9.62	12.48	10.18		

Outdoor air temp.	Indoor air temperature					
	DB					
DB	WB	16	18	20	22	24
-19.8	-20	7.06	7.03	7.00	6.97	6.95
-17.7	-18	7.46	7.43	7.41	7.37	7.34
-15.7	-16	7.87	7.84	7.81	7.77	7.74
-13.5	-14	8.33	8.29	8.26	8.22	8.18
-11.5	-12	8.78	8.74	8.70	8.66	8.62
-9.5	-10	9.24	9.19	9.15	9.11	9.06
-7.5	-8	9.69	9.65	9.60	9.55	9.50
-5.5	-6	9.91	9.86	9.81	9.75	9.70
-3.0	-4	10.12	10.07	10.01	9.96	9.90
-1.0	-2	10.33	10.28	10.22	10.16	10.10
1.0	0	10.55	10.49	10.43	10.36	10.30
2.0	1	10.65	10.59	10.53	10.47	10.40
3.0	2	11.36	11.29	11.22	11.18	11.13
5.0	4	12.76	12.69	12.61	12.60	12.58
7.0	6	14.16	14.08	14.00	14.02	14.04
9.0	8	14.72	14.64	14.56	14.52	14.49
11.5	10	15.28	15.20	15.11	15.02	14.93
13.5	12	16.13	16.04	15.94	15.82	15.75
15.5	14	16.98	16.88	16.77	16.62	16.58
16.5	16	17.41	17.30	17.19	17.02	16.99

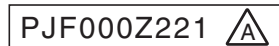

Note(1) These data show average statuses.
 Depending on the system control, there may be ranges where the operation is not conducted continuously.
 These data show the case where the operation frequency of a compressor is fixed.
 (2) Capacities are based on the following conditions.
 Corresponding refrigerant piping length :7.5m
 Level difference of Zero.
 (3) Symbols are as follows.
 TC : Total cooling capacity (kW)
 SHC : Sensible heat capacity (kW)
 HC : Heating capacity (kW)

Model **FDT140VNVF** Indoor unit FDT140VF Outdoor unit FDC140VN
Cool Mode (kW)

Outdoor air temp.	Indoor air temperature															
	18 DB		21 DB		23 DB		26 DB		27 DB		28 DB		31 DB		33 DB	
	12 WB	14 WB	16 WB	18 WB	19 WB	20 WB	22 WB	24 WB								
DB	TC	SHC	TC	SHC	TC	SHC	TC	SHC	TC	SHC	TC	SHC	TC	SHC		
11					11.37	9.30	12.02	10.02	12.35	9.93	12.70	9.85	13.39	10.38	14.08	10.17
13					11.90	9.52	12.61	10.25	12.96	10.16	13.33	10.07	14.09	10.61	14.84	10.40
15					12.43	9.74	13.19	10.47	13.57	10.39	13.97	10.31	14.78	10.84	15.59	10.62
17					12.96	9.97	13.77	10.70	14.17	10.62	14.61	10.54	15.48	11.07	16.34	10.85
19					13.24	10.09	14.06	10.82	14.48	10.74	14.92	10.65	15.80	11.18	16.68	10.96
21					13.51	10.21	14.36	10.94	14.78	10.85	15.23	10.77	16.12	11.29	17.02	11.06
23					13.51	10.21	14.40	10.96	14.82	10.87	15.28	10.79	16.19	11.31	17.10	11.09
25			12.50	10.37	13.50	10.20	14.43	10.97	14.86	10.88	15.33	10.81	16.25	11.33	17.18	11.11
27			12.41	10.33	13.50	10.20	14.47	10.99	14.91	10.90	15.34	10.81	16.20	11.32		
29			12.32	10.29	13.29	10.11	14.23	10.89	14.68	10.81	15.13	10.73	16.02	11.25		
31			12.23	10.24	13.09	10.03	13.99	10.79	14.45	10.73	14.92	10.65	15.85	11.20		
33	11.51	9.60	12.01	10.14	12.89	9.94	13.75	10.69	14.23	10.64	14.71	10.58	15.67	11.13		
35	11.28	9.48	11.82	10.05	12.68	9.85	13.50	10.60	14.00	10.55	14.50	10.50	15.49	11.07		
37	11.08	9.39	11.62	9.96	12.47	9.76	13.25	10.50	13.71	10.44	14.18	10.38	15.12	10.95		
39	10.89	9.29	11.43	9.88	12.26	9.67	12.99	10.39	13.43	10.34	13.86	10.27	14.74	10.82		
41	10.70	9.20	11.23	9.78	12.04	9.58	12.73	10.29	13.14	10.23	13.55	10.15	14.36	10.70		
43	10.51	9.11	11.03	9.69	11.83	9.49	12.47	10.19	12.85	10.12	13.23	10.04	13.98	10.57		

(kW) Heat Mode:HC (kW)

Outdoor air temp.		Indoor air temperature					
		DB					
DB	WB	16	18	20	22	24	
-19.8	-20	8.06	8.03	8.00	7.97	7.94	
-17.7	-18	8.53	8.50	8.46	8.43	8.39	
-15.7	-16	9.00	8.96	8.92	8.88	8.85	
-13.5	-14	9.52	9.48	9.43	9.39	9.35	
-11.5	-12	10.04	9.99	9.95	9.90	9.85	
-9.5	-10	10.56	10.51	10.46	10.41	10.36	
-7.5	-8	11.08	11.02	10.97	10.91	10.86	
-5.5	-6	11.32	11.26	11.21	11.15	11.09	
-3.0	-4	11.56	11.50	11.44	11.38	11.31	
-1.0	-2	11.81	11.75	11.68	11.61	11.54	
1.0	0	12.05	11.99	11.92	11.84	11.77	
2.0	1	12.18	12.11	12.04	11.96	11.89	
3.0	2	12.98	12.90	12.83	12.77	12.72	
5.0	4	14.58	14.50	14.41	14.40	14.38	
7.0	6	16.19	16.09	16.00	16.02	16.05	
9.0	8	16.83	16.73	16.63	16.59	16.55	
11.5	10	17.46	17.37	17.27	17.17	17.06	
13.5	12	18.44	18.33	18.22	18.08	18.00	
15.5	14	19.41	19.29	19.17	18.99	18.95	
16.5	16	19.90	19.77	19.64	19.45	19.42	

PJF000Z221 

Model **FDT140VSVF** Indoor unit FDT140VF Outdoor unit FDC140VS
Cool Mode (kW)

Outdoor air temp.	Indoor air temperature															
	18 DB		21 DB		23 DB		26 DB		27 DB		28 DB		31 DB		33 DB	
	12 WB	14 WB	16 WB	18 WB	19 WB	20 WB	22 WB	24 WB								
DB	TC	SHC	TC	SHC	TC	SHC	TC	SHC	TC	SHC	TC	SHC	TC	SHC		
11					11.37	9.30	12.02	10.02	12.35	9.93	12.70	9.85	13.39	10.38	14.08	10.17
13					11.90	9.52	12.61	10.25	12.96	10.16	13.33	10.07	14.09	10.61	14.84	10.40
15					12.43	9.74	13.19	10.47	13.57	10.39	13.97	10.31	14.78	10.84	15.59	10.62
17					12.96	9.97	13.77	10.70	14.17	10.62	14.61	10.54	15.48	11.07	16.34	10.85
19					13.24	10.09	14.06	10.82	14.48	10.74	14.92	10.65	15.80	11.18	16.68	10.96
21					13.51	10.21	14.36	10.94	14.78	10.85	15.23	10.77	16.12	11.29	17.02	11.06
23					13.51	10.21	14.40	10.96	14.82	10.87	15.28	10.79	16.19	11.31	17.10	11.09
25			12.50	10.37	13.50	10.20	14.43	10.97	14.86	10.88	15.33	10.81	16.25	11.33	17.18	11.11
27			12.41	10.33	13.50	10.20	14.47	10.99	14.91	10.90	15.34	10.81	16.20	11.32		
29			12.32	10.29	13.29	10.11	14.23	10.89	14.68	10.81	15.13	10.73	16.02	11.25		
31			12.23	10.24	13.09	10.03	13.99	10.79	14.45	10.73	14.92	10.65	15.85	11.20		
33	11.51	9.60	12.01	10.14	12.89	9.94	13.75	10.69	14.23	10.64	14.71	10.58	15.67	11.13		
35	11.28	9.48	11.82	10.05	12.68	9.85	13.50	10.60	14.00	10.55	14.50	10.50	15.49	11.07		
37	11.08	9.39	11.62	9.96	12.47	9.76	13.25	10.50	13.71	10.44	14.18	10.38	15.12	10.95		
39	10.89	9.29	11.43	9.88	12.26	9.67	12.99	10.39	13.43	10.34	13.86	10.27	14.74	10.82		
41	10.70	9.20	11.23	9.78	12.04	9.58	12.73	10.29	13.14	10.23	13.55	10.15	14.36	10.70		
43	10.51	9.11	11.03	9.69	11.83	9.49	12.47	10.19	12.85	10.12	13.23	10.04	13.98	10.57		

(kW) Heat Mode:HC (kW)

Outdoor air temp.		Indoor air temperature					
		DB					
DB	WB	16	18	20	22	24	
-19.8	-20	8.06	8.03	8.00	7.97	7.94	
-17.7	-18	8.53	8.50	8.46	8.43	8.39	
-15.7	-16	9.00	8.96	8.92	8.88	8.85	
-13.5	-14	9.52	9.48	9.43	9.39	9.35	
-11.5	-12	10.04	9.99	9.95	9.90	9.85	
-9.5	-10	10.56	10.51	10.46	10.41	10.36	
-7.5	-8	11.08	11.02	10.97	10.91	10.86	
-5.5	-6	11.32	11.26	11.21	11.15	11.09	
-3.0	-4	11.56	11.50	11.44	11.38	11.31	
-1.0	-2	11.81	11.75	11.68	11.61	11.54	
1.0	0	12.05	11.99	11.92	11.84	11.77	
2.0	1	12.18	12.11	12.04	11.96	11.89	
3.0	2	12.98	12.90	12.83	12.77	12.72	
5.0	4	14.58	14.50	14.41	14.40	14.38	
7.0	6	16.19	16.09	16.00	16.02	16.05	
9.0	8	16.83	16.73	16.63	16.59	16.55	
11.5	10	17.46	17.37	17.27	17.17	17.06	
13.5	12	18.44	18.33	18.22	18.08	18.00	
15.5	14	19.41	19.29	19.17	18.99	18.95	
16.5	16	19.90	19.77	19.64	19.45	19.42	

PJF000Z221 

Note(1) These data show average statuses.

Depending on the system control, there may be ranges where the operation is not conducted continuously. These data show the case where the operation frequency of a compressor is fixed.

(2) Capacities are based on the following conditions.

Corresponding refrigerant piping length :7.5m

Level difference of Zero.

(3) Symbols are as follows.

TC : Total cooling capacity (kW)

SHC : Sensible heat capacity (kW)

HC : Heating capacity (kW)

(b) Twin type

Model FDT100VNPVF Indoor unit FDT50VF (2 units) Outdoor unit FDC100VN

Cool Mode

(kW)

Heat Mode:HC

(kW)

Outdoor air temp.	Indoor air temperature															
	18 DB		21 DB		23 DB		26 DB		27 DB		28 DB		31 DB		33 DB	
	12 WB	14 WB	16 WB	18 WB	19 WB	20 WB	22 WB	24 WB	TC	SHC	TC	SHC	TC	SHC	TC	SHC
DB	TC	SHC	TC	SHC	TC	SHC	TC	SHC	TC	SHC	TC	SHC	TC	SHC	TC	SHC
11					8.12	7.94	8.59	8.42	8.82	8.62	9.07	8.53	9.56	9.11	10.06	8.89
13					8.50	8.07	9.00	8.82	9.26	8.75	9.52	8.65	10.06	9.22	10.60	9.01
15					8.88	8.19	9.42	8.97	9.69	8.87	9.98	8.78	10.56	9.35	11.14	9.12
17					9.26	8.32	9.84	9.09	10.12	9.00	10.43	8.90	11.05	9.46	11.67	9.23
19					9.46	8.39	10.05	9.16	10.34	9.06	10.65	8.96	11.29	9.52	11.92	9.29
21					9.65	8.46	10.25	9.22	10.56	9.13	10.88	9.03	11.52	9.58	12.16	9.34
23					9.65	8.46	10.28	9.23	10.59	9.13	10.91	9.03	11.56	9.59	12.21	9.35
25		8.93	8.71		9.64	8.46	10.31	9.24	10.62	9.14	10.95	9.04	11.61	9.60	12.27	9.36
27		8.86	8.68		9.64	8.46	10.34	9.25	10.65	9.15	10.96	9.05	11.57	9.59		
29		8.80	8.62		9.50	8.41	10.17	9.20	10.49	9.10	10.81	9.01	11.45	9.56		
31		8.73	8.56		9.35	8.35	9.99	9.14	10.32	9.05	10.66	8.96	11.32	9.53		
33	8.22	7.97	8.58	8.41	9.21	8.31	9.82	9.09	10.16	9.01	10.51	8.92	11.19	9.50		
35	8.05	7.89	8.44	8.27	9.06	8.26	9.64	9.03	10.00	8.96	10.36	8.88	11.07	9.47		
37	7.92	7.76	8.30	8.13	8.91	8.20	9.46	8.98	9.79	8.90	10.13	8.82	10.80	9.40		
39	7.78	7.62	8.16	8.00	8.75	8.15	9.28	8.92	9.59	8.84	9.90	8.75	10.53	9.34		
41	7.64	7.49	8.02	7.86	8.60	8.10	9.09	8.86	9.38	8.78	9.68	8.69	10.26	9.27		
43	7.50	7.35	7.88	7.72	8.45	8.05	8.91	8.73	9.18	8.72	9.45	8.63	9.99	9.21		

Outdoor air temp.		Indoor air temperature					
DB	WB	DB					
-19.8	-20	5.64	5.62	5.60	5.58	5.56	
-17.7	-18	5.97	5.95	5.92	5.90	5.87	
-15.7	-16	6.30	6.27	6.25	6.22	6.19	
-13.5	-14	6.66	6.63	6.60	6.57	6.54	
-11.5	-12	7.03	6.99	6.96	6.93	6.90	
-9.5	-10	7.39	7.36	7.32	7.29	7.25	
-7.5	-8	7.75	7.72	7.68	7.64	7.60	
-5.5	-6	7.92	7.88	7.85	7.80	7.76	
-3.0	-4	8.10	8.05	8.01	7.97	7.92	
-1.0	-2	8.27	8.22	8.18	8.13	8.08	
1.0	0	8.44	8.39	8.34	8.29	8.24	
2.0	1	8.52	8.47	8.42	8.37	8.32	
3.0	2	9.08	9.03	8.98	8.94	8.90	
5.0	4	10.21	10.15	10.09	10.08	10.07	
7.0	6	11.33	11.27	11.20	11.22	11.23	
9.0	8	11.78	11.71	11.64	11.62	11.59	
11.5	10	12.23	12.16	12.09	12.02	11.94	
13.5	12	12.91	12.83	12.75	12.65	12.60	
15.5	14	13.59	13.50	13.42	13.29	13.26	
16.5	16	13.93	13.84	13.75	13.61	13.59	

PJF000Z221

Model FDT100VSPVF Indoor unit FDT50VF (2 units) Outdoor unit FDC100VS

Cool Mode

(kW)

Heat Mode:HC

(kW)

Outdoor air temp.	Indoor air temperature															
	18 DB		21 DB		23 DB		26 DB		27 DB		28 DB		31 DB		33 DB	
	12 WB	14 WB	16 WB	18 WB	19 WB	20 WB	22 WB	24 WB	TC	SHC	TC	SHC	TC	SHC	TC	SHC
DB	TC	SHC	TC	SHC	TC	SHC	TC	SHC	TC	SHC	TC	SHC	TC	SHC	TC	SHC
11					8.12	7.94	8.59	8.42	8.82	8.62	9.07	8.53	9.56	9.11	10.06	8.89
13					8.50	8.07	9.00	8.82	9.26	8.75	9.52	8.65	10.06	9.22	10.60	9.01
15					8.88	8.19	9.42	8.97	9.69	8.87	9.98	8.78	10.56	9.35	11.14	9.12
17					9.26	8.32	9.84	9.09	10.12	9.00	10.43	8.90	11.05	9.46	11.67	9.23
19					9.46	8.39	10.05	9.16	10.34	9.06	10.65	8.96	11.29	9.52	11.92	9.29
21					9.65	8.46	10.25	9.22	10.56	9.13	10.88	9.03	11.52	9.58	12.16	9.34
23					9.65	8.46	10.28	9.23	10.59	9.13	10.91	9.03	11.56	9.59	12.21	9.35
25		8.93	8.71		9.64	8.46	10.31	9.24	10.62	9.14	10.95	9.04	11.61	9.60	12.27	9.36
27		8.86	8.68		9.64	8.46	10.34	9.25	10.65	9.15	10.96	9.05	11.57	9.59		
29		8.80	8.62		9.50	8.41	10.17	9.20	10.49	9.10	10.81	9.01	11.45	9.56		
31		8.73	8.56		9.35	8.35	9.99	9.14	10.32	9.05	10.66	8.96	11.32	9.53		
33	8.22	7.97	8.58	8.41	9.21	8.31	9.82	9.09	10.16	9.01	10.51	8.92	11.19	9.50		
35	8.05	7.89	8.44	8.27	9.06	8.26	9.64	9.03	10.00	8.96	10.36	8.88	11.07	9.47		
37	7.92	7.76	8.30	8.13	8.91	8.20	9.46	8.98	9.79	8.90	10.13	8.82	10.80	9.40		
39	7.78	7.62	8.16	8.00	8.75	8.15	9.28	8.92	9.59	8.84	9.90	8.75	10.53	9.34		
41	7.64	7.49	8.02	7.86	8.60	8.10	9.09	8.86	9.38	8.78	9.68	8.69	10.26	9.27		
43	7.50	7.35	7.88	7.72	8.45	8.05	8.91	8.73	9.18	8.72	9.45	8.63	9.99	9.21		

Outdoor air temp.		Indoor air temperature					
DB	WB	DB					
-19.8	-20	5.64	5.62	5.60	5.58	5.56	
-17.7	-18	5.97	5.95	5.92	5.90	5.87	
-15.7	-16	6.30	6.27	6.25	6.22	6.19	
-13.5	-14	6.66	6.63	6.60	6.57	6.54	
-11.5	-12	7.03	6.99	6.96	6.93	6.90	
-9.5	-10	7.39	7.36	7.32	7.29	7.25	
-7.5	-8	7.75	7.72	7.68	7.64	7.60	
-5.5	-6	7.92	7.88	7.85	7.80	7.76	
-3.0	-4	8.10	8.05	8.01	7.97	7.92	
-1.0	-2	8.27	8.22	8.18	8.13	8.08	
1.0	0	8.44	8.39	8.34	8.29	8.24	
2.0	1	8.52	8.47	8.42	8.37	8.32	
3.0	2	9.08	9.03	8.98	8.94	8.90	
5.0	4	10.21	10.15	10.09	10.08	10.07	
7.0	6	11.33	11.27	11.20	11.22	11.23	
9.0	8	11.78	11.71	11.64	11.62	11.59	
11.5	10	12.23	12.16	12.09	12.02	11.94	
13.5	12	12.91	12.83	12.75	12.65	12.60	
15.5	14	13.59	13.50	13.42	13.29	13.26	
16.5	16	13.93	13.84	13.75	13.61	13.59	

PJF000Z221

Note(1) These data show average statuses.

Depending on the system control, there may be ranges where the operation is not conducted continuously.

These data show the case where the operation frequency of a compressor is fixed.

(2) Capacities are based on the following conditions.

Corresponding refrigerant piping length : 7.5m

Level difference of Zero.

(3) Symbols are as follows.

TC : Total cooling capacity (kW)

SHC : Sensible heat capacity (kW)

HC : Heating capacity (kW)

Model **FDT125VNPVF** Indoor unit **FDT60VF (2 units)** Outdoor unit **FDC125VN**

Cool Mode

Outdoor air temp.	Indoor air temperature																(kW)							
	18 DB		21 DB		23 DB		26 DB		27 DB		28 DB		31 DB		33 DB									
	12 WB		14 WB		16 WB		18 WB		19 WB		20 WB		22 WB		24 WB									
DB	TC	SHC	TC	SHC	TC	SHC	TC	SHC	TC	SHC	TC	SHC	TC	SHC	TC	SHC	Heat Mode:HC	(kW)						
																			-19.8	-20	7.06	7.03	7.00	6.97
11																	-17.7	-18	7.46	7.43	7.41	7.37	7.34	
13																	-15.7	-16	7.87	7.84	7.81	7.77	7.74	
15																	-13.5	-14	8.33	8.29	8.26	8.22	8.18	
17																	-11.5	-12	8.78	8.74	8.70	8.66	8.62	
19																	-9.5	-10	9.24	9.19	9.15	9.11	9.06	
21																	-7.5	-8	9.69	9.65	9.60	9.55	9.50	
23																	-5.5	-6	9.91	9.86	9.81	9.75	9.70	
25				11.16	10.81	12.06	10.34	12.89	11.33	13.27	11.14	13.68	10.95	14.51	11.63	15.34	11.19	-3.0	-4	10.12	10.07	10.01	9.96	9.90
27				11.08	10.79	12.05	10.34	12.92	11.34	13.31	11.15	13.69	10.96	14.47	11.62			-1.0	-2	10.33	10.28	10.22	10.16	10.10
29				11.00	10.76	11.87	10.29	12.71	11.29	13.11	11.11	13.51	10.92	14.31	11.60			1.0	0	10.55	10.49	10.43	10.36	10.30
31				10.92	10.70	11.69	10.24	12.49	11.24	12.90	11.07	13.32	10.89	14.15	11.58			2.0	1	10.65	10.59	10.53	10.47	10.40
33	10.27	9.88	10.72	10.51	11.51	10.20	12.27	11.19	12.70	11.03	13.13	10.85	13.99	11.55			3.0	2	11.36	11.29	11.22	11.18	11.13	
35	10.07	9.82	10.55	10.34	11.33	10.15	12.06	11.15	12.50	10.99	12.94	10.81	13.83	11.53			5.0	4	12.76	12.69	12.61	12.60	12.58	
37	9.90	9.70	10.38	10.17	11.13	10.10	11.83	11.10	12.24	10.93	12.66	10.76	13.50	11.48			7.0	6	14.16	14.08	14.00	14.02	14.04	
39	9.72	9.53	10.20	10.00	10.94	10.05	11.60	11.05	11.99	10.88	12.38	10.71	13.16	11.43			9.0	8	14.72	14.64	14.56	14.52	14.49	
41	9.55	9.36	10.02	9.82	10.75	10.00	11.37	11.00	11.73	10.83	12.09	10.66	12.82	11.38			11.5	10	15.28	15.20	15.11	15.02	14.93	
43	9.38	9.19	9.85	9.65	10.56	9.95	11.14	10.92	11.47	10.78	11.81	10.61	12.48	11.33			13.5	12	16.13	16.04	15.94	15.82	15.75	
																	15.5	14	16.98	16.88	16.77	16.62	16.58	
																	16.5	16	17.41	17.30	17.19	17.02	16.99	

PJF000Z221 

Model **FDT125VSPVF** Indoor unit **FDT60VF (2 units)** Outdoor unit **FDC125VS**

Cool Mode

Outdoor air temp.	Indoor air temperature																(kW)							
	18 DB		21 DB		23 DB		26 DB		27 DB		28 DB		31 DB		33 DB									
	12 WB		14 WB		16 WB		18 WB		19 WB		20 WB		22 WB		24 WB									
DB	TC	SHC	TC	SHC	TC	SHC	TC	SHC	TC	SHC	TC	SHC	TC	SHC	TC	SHC	Heat Mode:HC	(kW)						
																			-19.8	-20	7.06	7.03	7.00	6.97
11																	-17.7	-18	7.46	7.43	7.41	7.37	7.34	
13																	-15.7	-16	7.87	7.84	7.81	7.77	7.74	
15																	-13.5	-14	8.33	8.29	8.26	8.22	8.18	
17																	-11.5	-12	8.78	8.74	8.70	8.66	8.62	
19																	-9.5	-10	9.24	9.19	9.15	9.11	9.06	
21																	-7.5	-8	9.69	9.65	9.60	9.55	9.50	
23																	-5.5	-6	9.91	9.86	9.81	9.75	9.70	
25				11.16	10.81	12.06	10.34	12.89	11.33	13.27	11.14	13.68	10.95	14.51	11.63	15.34	11.19	-3.0	-4	10.12	10.07	10.01	9.96	9.90
27				11.08	10.79	12.05	10.34	12.92	11.34	13.31	11.15	13.69	10.96	14.47	11.62			-1.0	-2	10.33	10.28	10.22	10.16	10.10
29				11.00	10.76	11.87	10.29	12.71	11.29	13.11	11.11	13.51	10.92	14.31	11.60			1.0	0	10.55	10.49	10.43	10.36	10.30
31				10.92	10.70	11.69	10.24	12.49	11.24	12.90	11.07	13.32	10.89	14.15	11.58			2.0	1	10.65	10.59	10.53	10.47	10.40
33	10.27	9.88	10.72	10.51	11.51	10.20	12.27	11.19	12.70	11.03	13.13	10.85	13.99	11.55			3.0	2	11.36	11.29	11.22	11.18	11.13	
35	10.07	9.82	10.55	10.34	11.33	10.15	12.06	11.15	12.50	10.99	12.94	10.81	13.83	11.53			5.0	4	12.76	12.69	12.61	12.60	12.58	
37	9.90	9.70	10.38	10.17	11.13	10.10	11.83	11.10	12.24	10.93	12.66	10.76	13.50	11.48			7.0	6	14.16	14.08	14.00	14.02	14.04	
39	9.72	9.53	10.20	10.00	10.94	10.05	11.60	11.05	11.99	10.88	12.38	10.71	13.16	11.43			9.0	8	14.72	14.64	14.56	14.52	14.49	
41	9.55	9.36	10.02	9.82	10.75	10.00	11.37	11.00	11.73	10.83	12.09	10.66	12.82	11.38			11.5	10	15.28	15.20	15.11	15.02	14.93	
43	9.38	9.19	9.85	9.65	10.56	9.95	11.14	10.92	11.47	10.78	11.81	10.61	12.48	11.33			13.5	12	16.13	16.04	15.94	15.82	15.75	
																	15.5	14	16.98	16.88	16.77	16.62	16.58	
																	16.5	16	17.41	17.30	17.19	17.02	16.99	

Note(1) These data show average statuses.
Depending on the system control, there may be ranges where the operation is not conducted continuously.
These data show the case where the operation frequency of a compressor is fixed.

(2) Capacities are based on the following conditions.
Corresponding refrigerant piping length :7.5m
Level difference of Zero.

(3) Symbols are as follows.
TC : Total cooling capacity (kW)
SHC : Sensible heat capacity (kW)
HC : Heating capacity (kW)

PJF000Z221 

Model **FDT140VNPVF1** Indoor unit FDT71VF1 (2 units) Outdoor unit FDC140VN
 Cool Mode (kW)

Outdoor air temp.	Indoor air temperature															
	18 DB		21 DB		23 DB		26 DB		27 DB		28 DB		31 DB		33 DB	
	12 WB		14 WB		16 WB		18 WB		19 WB		20 WB		22 WB		24 WB	
DB	TC	SHC	TC	SHC	TC	SHC	TC	SHC	TC	SHC	TC	SHC	TC	SHC	TC	SHC
11					11.37	11.14	12.02	11.78	12.35	12.10	12.70	12.04	13.39	12.85	14.08	12.56
13					11.90	11.37	12.61	12.36	12.96	12.34	13.33	12.21	14.09	13.02	14.84	12.73
15					12.43	11.55	13.19	12.64	13.57	12.52	13.97	12.39	14.78	13.20	15.59	12.89
17					12.96	11.74	13.77	12.83	14.17	12.70	14.61	12.57	15.48	13.37	16.34	13.06
19					13.24	11.84	14.06	12.92	14.48	12.79	14.92	12.66	15.80	13.45	16.68	13.13
21					13.51	11.93	14.36	13.01	14.78	12.88	15.23	12.75	16.12	13.53	17.02	13.21
23					13.51	11.93	14.40	13.03	14.82	12.89	15.28	12.76	16.19	13.55	17.10	13.23
25			12.50	12.25	13.50	11.93	14.43	13.04	14.86	12.90	15.33	12.77	16.25	13.57	17.18	13.24
27			12.41	12.16	13.50	11.93	14.47	13.05	14.91	12.92	15.34	12.78	16.20	13.55		
29			12.32	12.07	13.29	11.85	14.23	12.97	14.68	12.85	15.13	12.72	16.02	13.51		
31			12.23	11.99	13.09	11.78	13.99	12.90	14.45	12.78	14.92	12.66	15.85	13.46		
33	11.51	11.23	12.01	11.77	12.89	11.71	13.75	12.82	14.23	12.71	14.71	12.60	15.67	13.42		
35	11.28	11.05	11.82	11.58	12.68	11.64	13.50	12.74	14.00	12.65	14.50	12.54	15.49	13.37		
37	11.08	10.86	11.62	11.39	12.47	11.57	13.25	12.66	13.71	12.56	14.18	12.45	15.12	13.28		
39	10.89	10.67	11.43	11.20	12.26	11.50	12.99	12.58	13.43	12.48	13.86	12.36	14.74	13.19		
41	10.70	10.49	11.23	11.01	12.04	11.42	12.73	12.48	13.14	12.39	13.55	12.27	14.36	13.09		
43	10.51	10.30	11.03	10.81	11.83	11.35	12.47	12.22	12.85	12.31	13.23	12.18	13.98	13.00		

Heat Mode:HC (kW)

Outdoor air temp.		Indoor air temperature					
DB	WB	DB					
		16	18	20	22	24	
-19.8	-20	8.06	8.03	8.00	7.97	7.94	
-17.7	-18	8.53	8.50	8.46	8.43	8.39	
-15.7	-16	9.00	8.96	8.92	8.88	8.85	
-13.5	-14	9.52	9.48	9.43	9.39	9.35	
-11.5	-12	10.04	9.99	9.95	9.90	9.85	
-9.5	-10	10.56	10.51	10.46	10.41	10.36	
-7.5	-8	11.08	11.02	10.97	10.91	10.86	
-5.5	-6	11.32	11.26	11.21	11.15	11.09	
-3.0	-4	11.56	11.50	11.44	11.38	11.31	
-1.0	-2	11.81	11.75	11.68	11.61	11.54	
1.0	0	12.05	11.99	11.92	11.84	11.77	
2.0	1	12.18	12.11	12.04	11.96	11.89	
3.0	2	12.98	12.90	12.83	12.77	12.72	
5.0	4	14.58	14.50	14.41	14.40	14.38	
7.0	6	16.19	16.09	16.00	16.02	16.05	
9.0	8	16.83	16.73	16.63	16.59	16.55	
11.5	10	17.46	17.37	17.27	17.17	17.06	
13.5	12	18.44	18.33	18.22	18.08	18.00	
15.5	14	19.41	19.29	19.17	18.99	18.95	
16.5	16	19.90	19.77	19.64	19.45	19.42	

PJF000Z221 

Model **FDT140VSPVF1** Indoor unit FDT71VF1 (2 units) Outdoor unit FDC140VS
 Cool Mode (kW)

Outdoor air temp.	Indoor air temperature															
	18 DB		21 DB		23 DB		26 DB		27 DB		28 DB		31 DB		33 DB	
	12 WB		14 WB		16 WB		18 WB		19 WB		20 WB		22 WB		24 WB	
DB	TC	SHC	TC	SHC	TC	SHC	TC	SHC	TC	SHC	TC	SHC	TC	SHC	TC	SHC
11					11.37	11.14	12.02	11.78	12.35	12.10	12.70	12.04	13.39	12.85	14.08	12.56
13					11.90	11.37	12.61	12.36	12.96	12.34	13.33	12.21	14.09	13.02	14.84	12.73
15					12.43	11.55	13.19	12.64	13.57	12.52	13.97	12.39	14.78	13.20	15.59	12.89
17					12.96	11.74	13.77	12.83	14.17	12.70	14.61	12.57	15.48	13.37	16.34	13.06
19					13.24	11.84	14.06	12.92	14.48	12.79	14.92	12.66	15.80	13.45	16.68	13.13
21					13.51	11.93	14.36	13.01	14.78	12.88	15.23	12.75	16.12	13.53	17.02	13.21
23					13.51	11.93	14.40	13.03	14.82	12.89	15.28	12.76	16.19	13.55	17.10	13.23
25			12.50	12.25	13.50	11.93	14.43	13.04	14.86	12.90	15.33	12.77	16.25	13.57	17.18	13.24
27			12.41	12.16	13.50	11.93	14.47	13.05	14.91	12.92	15.34	12.78	16.20	13.55		
29			12.32	12.07	13.29	11.85	14.23	12.97	14.68	12.85	15.13	12.72	16.02	13.51		
31			12.23	11.99	13.09	11.78	13.99	12.90	14.45	12.78	14.92	12.66	15.85	13.46		
33	11.51	11.23	12.01	11.77	12.89	11.71	13.75	12.82	14.23	12.71	14.71	12.60	15.67	13.42		
35	11.28	11.05	11.82	11.58	12.68	11.64	13.50	12.74	14.00	12.65	14.50	12.54	15.49	13.37		
37	11.08	10.86	11.62	11.39	12.47	11.57	13.25	12.66	13.71	12.56	14.18	12.45	15.12	13.28		
39	10.89	10.67	11.43	11.20	12.26	11.50	12.99	12.58	13.43	12.48	13.86	12.36	14.74	13.19		
41	10.70	10.49	11.23	11.01	12.04	11.42	12.73	12.48	13.14	12.39	13.55	12.27	14.36	13.09		
43	10.51	10.30	11.03	10.81	11.83	11.35	12.47	12.22	12.85	12.31	13.23	12.18	13.98	13.00		

Heat Mode:HC (kW)

Outdoor air temp.		Indoor air temperature					
DB	WB	DB					
		16	18	20	22	24	
-19.8	-20	8.06	8.03	8.00	7.97	7.94	
-17.7	-18	8.53	8.50	8.46	8.43	8.39	
-15.7	-16	9.00	8.96	8.92	8.88	8.85	
-13.5	-14	9.52	9.48	9.43	9.39	9.35	
-11.5	-12	10.04	9.99	9.95	9.90	9.85	
-9.5	-10	10.56	10.51	10.46	10.41	10.36	
-7.5	-8	11.08	11.02	10.97	10.91	10.86	
-5.5	-6	11.32	11.26	11.21	11.15	11.09	
-3.0	-4	11.56	11.50	11.44	11.38	11.31	
-1.0	-2	11.81	11.75	11.68	11.61	11.54	
1.0	0	12.05	11.99	11.92	11.84	11.77	
2.0	1	12.18	12.11	12.04	11.96	11.89	
3.0	2	12.98	12.90	12.83	12.77	12.72	
5.0	4	14.58	14.50	14.41	14.40	14.38	
7.0	6	16.19	16.09	16.00	16.02	16.05	
9.0	8	16.83	16.73	16.63	16.59	16.55	
11.5	10	17.46	17.37	17.27	17.17	17.06	
13.5	12	18.44	18.33	18.22	18.08	18.00	
15.5	14	19.41	19.29	19.17	18.99	18.95	
16.5	16	19.90	19.77	19.64	19.45	19.42	

PJF000Z221 

Note(1) These data show average statuses.
 Depending on the system control, there may be ranges where the operation is not conducted continuously.
 These data show the case where the operation frequency of a compressor is fixed.
 (2) Capacities are based on the following conditions.
 Corresponding refrigerant piping length :7.5m
 Level difference of Zero.
 (3) Symbols are as follows.
 TC : Total cooling capacity (kW)
 SHC : Sensible heat capacity (kW)
 HC : Heating capacity (kW)

Model FDT200VSPVF1 Indoor unit FDT100VF1 (2 units) Outdoor unit FDC200VS
 Cool Mode

Outdoor air temp.	Indoor air temperature (kW)															
	18 DB		21 DB		23 DB		26 DB		27 DB		28 DB		31 DB		33 DB	
	12 WB	14 WB	16 WB	18 WB	19 WB	20 WB	22 WB	24 WB								
DB	TC	SHC	TC	SHC	TC	SHC	TC	SHC	TC	SHC	TC	SHC	TC	SHC	TC	SHC
11					17.37	15.85	18.41	17.29	18.94	17.13	19.50	16.97	20.63	18.05	21.76	17.66
13					17.90	16.04	18.99	17.49	19.54	17.32	20.13	17.16	21.31	18.23	22.49	17.84
15					18.43	16.23	19.57	17.68	20.14	17.51	20.75	17.35	21.98	18.42	23.21	18.01
17					18.96	16.43	20.14	17.87	20.73	17.70	21.38	17.54	22.66	18.60	23.94	18.19
19					19.35	16.57	20.56	18.01	21.16	17.84	21.81	17.67	23.12	18.73	24.42	18.31
21					19.41	16.59	20.98	18.16	21.59	17.98	22.25	17.81	23.57	18.85	24.89	18.42
23					19.31	16.56	20.86	18.12	21.47	17.94	22.12	17.77	23.43	18.82	24.73	18.38
25			17.35	16.78	19.20	16.52	20.74	18.07	21.35	17.90	21.99	17.73	23.28	18.77	24.57	18.34
27			17.28	16.75	19.10	16.48	20.62	18.03	21.22	17.86	21.83	17.68	23.04	18.71		
29			17.14	16.69	18.85	16.39	20.31	17.93	20.92	17.76	21.53	17.58	22.75	18.63		
31			16.99	16.63	18.59	16.29	20.00	17.82	20.61	17.66	21.22	17.49	22.45	18.54		
33	16.46	15.57	17.03	16.65	18.33	16.20	19.69	17.72	20.31	17.57	20.92	17.40	22.15	18.46		
35	16.14	15.43	16.76	16.42	18.08	16.10	19.38	17.62	20.00	17.47	20.62	17.31	21.85	18.38		
37	15.86	15.31	16.50	16.17	17.76	15.99	18.98	17.48	19.57	17.33	20.17	17.17	21.35	18.25		
39	15.59	15.19	16.23	15.91	17.44	15.87	18.58	17.35	19.15	17.20	19.71	17.03	20.85	18.11		
41	15.32	15.01	15.97	15.65	17.13	15.76	18.17	17.22	18.72	17.06	19.26	16.90	20.35	17.98		
43	15.04	14.74	15.70	15.39	16.81	15.64	17.77	17.08	18.29	16.93	18.81	16.77	19.85	17.84		

Outdoor air temp.	Indoor air temperature (kW)					
	Outdoor air temp.		Indoor air temperature DB			
	DB	WB	16	18	20	22
-19.8	-20					
-17.7	-18					
-15.7	-16					
-13.5	-14	13.21	13.18	13.14	13.11	13.08
-11.5	-12	13.91	13.87	13.83	13.79	13.76
-9.5	-10	14.61	14.57	14.52	14.47	14.43
-7.5	-8	15.31	15.26	15.21	15.16	15.10
-5.5	-6	15.64	15.58	15.52	15.46	15.40
-3.0	-4	15.96	15.89	15.82	15.76	15.69
-1.0	-2	16.29	16.21	16.13	16.06	15.98
1.0	0	16.61	16.53	16.44	16.36	16.28
2.0	1	16.78	16.69	16.59	16.51	16.42
3.0	2	17.96	17.86	17.76	17.66	17.56
5.0	4	20.33	20.21	20.08	19.96	19.84
7.0	6	22.71	22.55	22.40	22.26	22.12
9.0	8	23.43	23.28	23.13	22.88	22.63
11.5	10	24.14	24.00	23.86	23.50	23.13
13.5	12	25.41	25.24	25.07	24.77	24.43
15.5	14	26.67	26.47	26.27	26.05	25.72
16.5	16	27.30	27.09	26.87	26.69	26.37

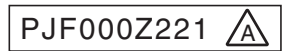

Model FDT250VSPVF Indoor unit FDT125VF (2 units) Outdoor unit FDC250VS
 Cool Mode

Outdoor air temp.	Indoor air temperature (kW)															
	18 DB		21 DB		23 DB		26 DB		27 DB		28 DB		31 DB		33 DB	
	12 WB	14 WB	16 WB	18 WB	19 WB	20 WB	22 WB	24 WB								
DB	TC	SHC	TC	SHC	TC	SHC	TC	SHC	TC	SHC	TC	SHC	TC	SHC	TC	SHC
11					21.71	18.30	23.02	19.79	23.67	19.64	24.38	19.51	25.79	20.62	27.21	20.27
13					22.38	18.58	23.74	20.07	24.42	19.92	25.16	19.79	26.63	20.90	28.11	20.53
15					23.04	18.85	24.46	20.35	25.17	20.20	25.94	20.07	27.48	21.18	29.02	20.81
17					23.70	19.13	25.18	20.63	25.92	20.49	26.72	20.35	28.32	21.46	29.92	21.08
19					24.19	19.34	25.70	20.84	26.45	20.69	27.27	20.55	28.89	21.65	30.52	21.27
21					24.26	19.37	26.22	21.05	26.99	20.89	27.82	20.75	29.47	21.84	31.12	21.45
23					24.13	19.32	26.07	20.99	26.84	20.84	27.65	20.69	29.28	21.78	30.91	21.39
25			21.69	19.35	24.00	19.26	25.92	20.93	26.68	20.78	27.49	20.63	29.10	21.72	30.71	21.32
27			21.60	19.30	23.88	19.21	25.77	20.87	26.53	20.72	27.29	20.56	28.80	21.62		
29			21.42	19.22	23.56	19.07	25.39	20.72	26.15	20.57	26.91	20.42	28.43	21.50		
31			21.24	19.14	23.24	18.94	25.00	20.56	25.77	20.43	26.53	20.28	28.06	21.37		
33	20.58	18.11	21.29	19.16	22.92	18.80	24.61	20.41	25.38	20.28	26.15	20.14	27.69	21.25		
35	20.17	17.91	20.96	19.01	22.60	18.67	24.23	20.26	25.00	20.14	25.77	20.00	27.31	21.12		
37	19.83	17.75	20.62	18.86	22.20	18.50	23.73	20.07	24.47	19.94	25.21	19.80	26.69	20.92		
39	19.49	17.58	20.29	18.71	21.80	18.33	23.22	19.87	23.93	19.74	24.64	19.60	26.06	20.71		
41	19.15	17.42	19.96	18.57	21.41	18.17	22.72	19.68	23.40	19.55	24.08	19.40	25.43	20.51		
43	18.81	17.26	19.63	18.42	21.01	18.01	22.22	19.49	22.86	19.35	23.51	19.20	24.81	20.31		

Outdoor air temp.	Indoor air temperature (kW)					
	Outdoor air temp.		Indoor air temperature DB			
	DB	WB	16	18	20	22
-19.8	-20					
-17.7	-18					
-15.7	-16					
-13.5	-14	16.52	16.47	16.43	16.39	16.35
-11.5	-12	17.39	17.34	17.29	17.24	17.19
-9.5	-10	18.26	18.21	18.15	18.09	18.04
-7.5	-8	19.14	19.07	19.01	18.94	18.88
-5.5	-6	19.55	19.47	19.40	19.32	19.24
-3.0	-4	19.95	19.87	19.78	19.70	19.61
-1.0	-2	20.36	20.26	20.17	20.07	19.98
1.0	0	20.77	20.66	20.55	20.45	20.35
2.0	1	20.97	20.86	20.74	20.64	20.53
3.0	2	22.45	22.32	22.19	22.07	21.95
5.0	4	25.42	25.26	25.10	24.95	24.80
7.0	6	28.38	28.19	28.00	27.82	27.65
9.0	8	29.28	29.10	28.91	28.60	28.28
11.5	10	30.18	30.00	29.83	29.37	28.91
13.5	12	31.76	31.55	31.33	30.97	30.53
15.5	14	33.34	33.09	32.84	32.57	32.15
16.5	16	34.13	33.86	33.59	33.37	32.96

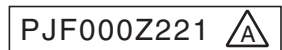

Note(1) These data show average statuses.
 Depending on the system control, there may be ranges where the operation is not conducted continuously.
 These data show the case where the operation frequency of a compressor is fixed.

(2) Capacities are based on the following conditions.
 Corresponding refrigerant piping length :7.5m
 Level difference of Zero.

(3) Symbols are as follows.
 TC : Total cooling capacity (kW)
 SHC : Sensible heat capacity (kW)
 HC : Heating capacity (kW)

(c) Triple type

Model FDT140VNTVF Indoor unit FDT50VF (3 units) Outdoor unit FDC140VN

Cool Mode

(kW)

Heat Mode:HC

(kW)

Outdoor air temp.	Indoor air temperature															
	18 DB		21 DB		23 DB		26 DB		27 DB		28 DB		31 DB		33 DB	
	12 WB		14 WB		16 WB		18 WB		19 WB		20 WB		22 WB		24 WB	
DB	TC	SHC	TC	SHC	TC	SHC	TC	SHC	TC	SHC	TC	SHC	TC	SHC	TC	SHC
11					11.37	11.14	12.02	11.78	12.35	12.10	12.70	12.45	13.39	13.12	14.08	13.14
13					11.90	11.66	12.61	12.36	12.96	12.70	13.33	12.72	14.09	13.60	14.84	13.29
15					12.43	11.99	13.19	12.93	13.57	13.03	13.97	12.89	14.78	13.76	15.59	13.44
17					12.96	12.17	13.77	13.34	14.17	13.20	14.61	13.07	15.48	13.93	16.34	13.60
19					13.24	12.26	14.06	13.43	14.48	13.29	14.92	13.15	15.80	14.01	16.68	13.67
21					13.51	12.36	14.36	13.52	14.78	13.38	15.23	13.24	16.12	14.09	17.02	13.74
23					13.51	12.36	14.40	13.53	14.82	13.39	15.28	13.25	16.19	14.10	17.10	13.76
25			12.50	12.25	13.50	12.35	14.43	13.54	14.86	13.40	15.33	13.26	16.25	14.12	17.18	13.78
27			12.41	12.16	13.50	12.35	14.47	13.55	14.91	13.41	15.34	13.27	16.20	14.10		
29			12.32	12.07	13.29	12.28	14.23	13.48	14.68	13.35	15.13	13.21	16.02	14.06		
31			12.23	11.99	13.09	12.21	13.99	13.41	14.45	13.28	14.92	13.15	15.85	14.02		
33	11.51	11.28	12.01	11.77	12.89	12.15	13.75	13.33	14.23	13.22	14.71	13.09	15.67	13.98		
35	11.28	11.05	11.82	11.58	12.68	12.08	13.50	13.23	14.00	13.15	14.50	13.04	15.49	13.93		
37	11.08	10.86	11.62	11.39	12.47	12.01	13.25	12.99	13.71	13.07	14.18	12.95	15.12	13.84		
39	10.89	10.67	11.43	11.20	12.26	11.94	12.99	12.73	13.43	12.99	13.86	12.86	14.74	13.75		
41	10.70	10.49	11.23	11.01	12.04	11.80	12.73	12.48	13.14	12.88	13.55	12.78	14.36	13.66		
43	10.51	10.30	11.03	10.81	11.83	11.59	12.47	12.22	12.85	12.59	13.23	12.70	13.98	13.58		

Outdoor air temp.		Indoor air temperature					
DB	WB	16	18	20	22	24	
-19.8	-20	8.06	8.03	8.00	7.97	7.94	
-17.7	-18	8.53	8.50	8.46	8.43	8.39	
-15.7	-16	9.00	8.96	8.92	8.88	8.85	
-13.5	-14	9.52	9.48	9.43	9.39	9.35	
-11.5	-12	10.04	9.99	9.95	9.90	9.85	
-9.5	-10	10.56	10.51	10.46	10.41	10.36	
-7.5	-8	11.08	11.02	10.97	10.91	10.86	
-5.5	-6	11.32	11.26	11.21	11.15	11.09	
-3.0	-4	11.56	11.50	11.44	11.38	11.31	
-1.0	-2	11.81	11.75	11.68	11.61	11.54	
1.0	0	12.05	11.99	11.92	11.84	11.77	
2.0	1	12.18	12.11	12.04	11.96	11.89	
3.0	2	12.98	12.90	12.83	12.77	12.72	
5.0	4	14.58	14.50	14.41	14.40	14.38	
7.0	6	16.19	16.09	16.00	16.02	16.05	
9.0	8	16.83	16.73	16.63	16.59	16.55	
11.5	10	17.46	17.37	17.27	17.17	17.06	
13.5	12	18.44	18.33	18.22	18.08	18.00	
15.5	14	19.41	19.29	19.17	18.99	18.95	
16.5	16	19.90	19.77	19.64	19.45	19.42	

PJF000Z221 

Model FDT140VSTVF Indoor unit FDT50VF (3 units) Outdoor unit FDC140VS

Cool Mode

(kW)

Heat Mode:HC

(kW)

Outdoor air temp.	Indoor air temperature															
	18 DB		21 DB		23 DB		26 DB		27 DB		28 DB		31 DB		33 DB	
	12 WB		14 WB		16 WB		18 WB		19 WB		20 WB		22 WB		24 WB	
DB	TC	SHC	TC	SHC	TC	SHC	TC	SHC	TC	SHC	TC	SHC	TC	SHC	TC	SHC
11					11.37	11.14	12.02	11.78	12.35	12.10	12.70	12.45	13.39	13.12	14.08	13.14
13					11.90	11.66	12.61	12.36	12.96	12.70	13.33	12.72	14.09	13.60	14.84	13.29
15					12.43	11.99	13.19	12.93	13.57	13.03	13.97	12.89	14.78	13.76	15.59	13.44
17					12.96	12.17	13.77	13.34	14.17	13.20	14.61	13.07	15.48	13.93	16.34	13.60
19					13.24	12.26	14.06	13.43	14.48	13.29	14.92	13.15	15.80	14.01	16.68	13.67
21					13.51	12.36	14.36	13.52	14.78	13.38	15.23	13.24	16.12	14.09	17.02	13.74
23					13.51	12.36	14.40	13.53	14.82	13.39	15.28	13.25	16.19	14.10	17.10	13.76
25			12.50	12.25	13.50	12.35	14.43	13.54	14.86	13.40	15.33	13.26	16.25	14.12	17.18	13.78
27			12.41	12.16	13.50	12.35	14.47	13.55	14.91	13.41	15.34	13.27	16.20	14.10		
29			12.32	12.07	13.29	12.28	14.23	13.48	14.68	13.35	15.13	13.21	16.02	14.06		
31			12.23	11.99	13.09	12.21	13.99	13.41	14.45	13.28	14.92	13.15	15.85	14.02		
33	11.51	11.28	12.01	11.77	12.89	12.15	13.75	13.33	14.23	13.22	14.71	13.09	15.67	13.98		
35	11.28	11.05	11.82	11.58	12.68	12.08	13.50	13.23	14.00	13.15	14.50	13.04	15.49	13.93		
37	11.08	10.86	11.62	11.39	12.47	12.01	13.25	12.99	13.71	13.07	14.18	12.95	15.12	13.84		
39	10.89	10.67	11.43	11.20	12.26	11.94	12.99	12.73	13.43	12.99	13.86	12.86	14.74	13.75		
41	10.70	10.49	11.23	11.01	12.04	11.80	12.73	12.48	13.14	12.88	13.55	12.78	14.36	13.66		
43	10.51	10.30	11.03	10.81	11.83	11.59	12.47	12.22	12.85	12.59	13.23	12.70	13.98	13.58		

Outdoor air temp.		Indoor air temperature					
DB	WB	16	18	20	22	24	
-19.8	-20	8.06	8.03	8.00	7.97	7.94	
-17.7	-18	8.53	8.50	8.46	8.43	8.39	
-15.7	-16	9.00	8.96	8.92	8.88	8.85	
-13.5	-14	9.52	9.48	9.43	9.39	9.35	
-11.5	-12	10.04	9.99	9.95	9.90	9.85	
-9.5	-10	10.56	10.51	10.46	10.41	10.36	
-7.5	-8	11.08	11.02	10.97	10.91	10.86	
-5.5	-6	11.32	11.26	11.21	11.15	11.09	
-3.0	-4	11.56	11.50	11.44	11.38	11.31	
-1.0	-2	11.81	11.75	11.68	11.61	11.54	
1.0	0	12.05	11.99	11.92	11.84	11.77	
2.0	1	12.18	12.11	12.04	11.96	11.89	
3.0	2	12.98	12.90	12.83	12.77	12.72	
5.0	4	14.58	14.50	14.41	14.40	14.38	
7.0	6	16.19	16.09	16.00	16.02	16.05	
9.0	8	16.83	16.73	16.63	16.59	16.55	
11.5	10	17.46	17.37	17.27	17.17	17.06	
13.5	12	18.44	18.33	18.22	18.08	18.00	
15.5	14	19.41	19.29	19.17	18.99	18.95	
16.5	16	19.90	19.77	19.64	19.45	19.42	

PJF000Z221 

Note(1) These data show average statuses. Depending on the system control, there may be ranges where the operation is not conducted continuously.

These data show the case where the operation frequency of a compressor is fixed.

(2) Capacities are based on the following conditions.

Corresponding refrigerant piping length :7.5m

Level difference of Zero.

(3) Symbols are as follows.

TC : Total cooling capacity (kW)

SHC : Sensible heat capacity (kW)

HC : Heating capacity (kW)

Model **FDT200VSTVF1** Indoor unit FDT71VF1 (3 units) Outdoor unit FDC200VS
Cool Mode (kW)

Outdoor air temp.	Indoor air temperature															
	18 DB		21 DB		23 DB		26 DB		27 DB		28 DB		31 DB		33 DB	
	12 WB	14 WB	16 WB	18 WB	19 WB	20 WB	22 WB	24 WB	DB	WB	16	18	20	22	24	
DB	TC	SHC	TC	SHC	TC	SHC	TC	SHC	TC	SHC	TC	SHC	TC	SHC	TC	SHC
11					17.37	16.90	18.41	18.04	18.94	18.36	19.50	18.18	20.63	19.41	21.76	18.98
13					17.90	17.08	18.99	18.61	19.54	18.54	20.13	18.35	21.31	19.58	22.49	19.14
15					18.43	17.26	19.57	18.90	20.14	18.71	20.75	18.53	21.98	19.75	23.21	19.30
17					18.96	17.44	20.14	19.08	20.73	18.89	21.38	18.70	22.66	19.92	23.94	19.46
19					19.35	17.58	20.56	19.21	21.16	19.02	21.81	18.82	23.12	20.03	24.42	19.56
21					19.41	17.60	20.98	19.34	21.59	19.14	22.25	18.95	23.57	20.14	24.89	19.67
23					19.31	17.56	20.86	19.30	21.47	19.11	22.12	18.91	23.43	20.11	24.73	19.63
25			17.35	17.00	19.20	17.52	20.74	19.27	21.35	19.07	21.99	18.87	23.28	20.07	24.57	19.60
27			17.28	16.93	19.10	17.49	20.62	19.23	21.22	19.03	21.83	18.83	23.04	20.01		
29			17.14	16.80	18.85	17.40	20.31	19.13	20.92	18.94	21.53	18.74	22.75	19.94		
31			16.99	16.65	18.59	17.31	20.00	19.03	20.61	18.85	21.22	18.66	22.45	19.86		
33	16.46	16.13	17.03	16.69	18.33	17.22	19.69	18.94	20.31	18.76	20.92	18.57	22.15	19.79		
35	16.14	15.82	16.76	16.42	18.08	17.14	19.38	18.84	20.00	18.67	20.62	18.49	21.85	19.71		
37	15.86	15.54	16.50	16.17	17.76	17.03	18.98	18.60	19.57	18.54	20.17	18.36	21.35	19.59		
39	15.59	15.28	16.23	15.91	17.44	16.92	18.58	18.21	19.15	18.42	19.71	18.24	20.85	19.47		
41	15.32	15.01	15.97	15.65	17.13	16.79	18.17	17.81	18.72	18.30	19.26	18.11	20.35	19.35		
43	15.04	14.74	15.70	15.39	16.81	16.47	17.77	17.41	18.29	17.92	18.81	17.99	19.85	19.22		

Heat Mode:HC (kW)

Outdoor air temp.	Indoor air temperature						
	DB	WB	16	18	20	22	24
-19.8	-20						
-17.7	-18						
-15.7	-16						
-13.5	-14	13.21	13.18	13.14	13.11	13.08	
-11.5	-12	13.91	13.87	13.83	13.79	13.76	
-9.5	-10	14.61	14.57	14.52	14.47	14.43	
-7.5	-8	15.31	15.26	15.21	15.16	15.10	
-5.5	-6	15.64	15.58	15.52	15.46	15.40	
-3.0	-4	15.96	15.89	15.82	15.76	15.69	
-1.0	-2	16.29	16.21	16.13	16.06	15.98	
1.0	0	16.61	16.53	16.44	16.36	16.28	
2.0	1	16.78	16.69	16.59	16.51	16.42	
3.0	2	17.96	17.86	17.76	17.66	17.56	
5.0	4	20.33	20.21	20.08	19.96	19.84	
7.0	6	22.71	22.55	22.40	22.26	22.12	
9.0	8	23.43	23.28	23.13	22.88	22.63	
11.5	10	24.14	24.00	23.86	23.50	23.13	
13.5	12	25.41	25.24	25.07	24.77	24.43	
15.5	14	26.67	26.47	26.27	26.05	25.72	
16.5	16	27.30	27.09	26.87	26.69	26.37	

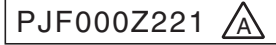

(d) Double twin type

Model **FDT200VSDVF** Indoor unit FDT50VF (4 units) Outdoor unit FDC200VS
Cool Mode (kW)

Outdoor air temp.	Indoor air temperature															
	18 DB		21 DB		23 DB		26 DB		27 DB		28 DB		31 DB		33 DB	
	12 WB	14 WB	16 WB	18 WB	19 WB	20 WB	22 WB	24 WB	DB	WB	16	18	20	22	24	
DB	TC	SHC	TC	SHC	TC	SHC	TC	SHC	TC	SHC	TC	SHC	TC	SHC	TC	SHC
11					17.37	16.26	18.41	17.80	18.94	17.61	19.50	17.43	20.63	18.57	21.76	18.13
13					17.90	16.44	18.99	17.98	19.54	17.79	20.13	17.60	21.31	18.74	22.49	18.28
15					18.43	16.62	19.57	18.16	20.14	17.96	20.75	17.77	21.98	18.90	23.21	18.44
17					18.96	16.80	20.14	18.33	20.73	18.14	21.38	17.94	22.66	19.07	23.94	18.59
19					19.35	16.93	20.56	18.46	21.16	18.26	21.81	18.06	23.12	19.18	24.42	18.70
21					19.41	16.96	20.98	18.60	21.59	18.39	22.25	18.19	23.57	19.29	24.89	18.80
23					19.31	16.92	20.86	18.56	21.47	18.35	22.12	18.15	23.43	19.26	24.73	18.77
25			17.35	17.00	19.20	16.88	20.74	18.52	21.35	18.32	21.99	18.12	23.28	19.22	24.57	18.73
27			17.28	16.93	19.10	16.85	20.62	18.48	21.22	18.28	21.83	18.07	23.04	19.16		
29			17.14	16.80	18.85	16.76	20.31	18.39	20.92	18.19	21.53	17.99	22.75	19.09		
31			16.99	16.65	18.59	16.67	20.00	18.29	20.61	18.10	21.22	17.90	22.45	19.01		
33	16.46	15.95	17.03	16.69	18.33	16.58	19.69	18.19	20.31	18.01	20.92	17.82	22.15	18.94		
35	16.14	15.82	16.76	16.42	18.08	16.50	19.38	18.10	20.00	17.92	20.62	17.73	21.85	18.87		
37	15.86	15.54	16.50	16.17	17.76	16.39	18.98	17.97	19.57	17.80	20.17	17.61	21.35	18.75		
39	15.59	15.28	16.23	15.91	17.44	16.28	18.58	17.85	19.15	17.67	19.71	17.48	20.85	18.62		
41	15.32	15.01	15.97	15.65	17.13	16.18	18.17	17.73	18.72	17.55	19.26	17.36	20.35	18.50		
43	15.04	14.74	15.70	15.39	16.81	16.07	17.77	17.41	18.29	17.43	18.81	17.24	19.85	18.39		

Heat Mode:HC (kW)

Outdoor air temp.	Indoor air temperature						
	DB	WB	16	18	20	22	24
-19.8	-20						
-17.7	-18						
-15.7	-16						
-13.5	-14	13.21	13.18	13.14	13.11	13.08	
-11.5	-12	13.91	13.87	13.83	13.79	13.76	
-9.5	-10	14.61	14.57	14.52	14.47	14.43	
-7.5	-8	15.31	15.26	15.21	15.16	15.10	
-5.5	-6	15.64	15.58	15.52	15.46	15.40	
-3.0	-4	15.96	15.89	15.82	15.76	15.69	
-1.0	-2	16.29	16.21	16.13	16.06	15.98	
1.0	0	16.61	16.53	16.44	16.36	16.28	
2.0	1	16.78	16.69	16.59	16.51	16.42	
3.0	2	17.96	17.86	17.76	17.66	17.56	
5.0	4	20.33	20.21	20.08	19.96	19.84	
7.0	6	22.71	22.55	22.40	22.26	22.12	
9.0	8	23.43	23.28	23.13	22.88	22.63	
11.5	10	24.14	24.00	23.86	23.50	23.13	
13.5	12	25.41	25.24	25.07	24.77	24.43	
15.5	14	26.67	26.47	26.27	26.05	25.72	
16.5	16	27.30	27.09	26.87	26.69	26.37	

Note(1) These data show average statuses.
Depending on the system control, there may be ranges where the operation is not conducted continuously.
These data show the case where the operation frequency of a compressor is fixed.

- (2) Capacities are based on the following conditions.
Corresponding refrigerant piping length :7.5m
Level difference of Zero.
- (3) Symbols are as follows.

TC : Total cooling capacity (kW)
SHC : Sensible heat capacity (kW)
HC : Heating capacity (kW)

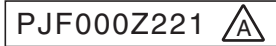

Model **FDT250VSDVF** Indoor unit FDT60VF (4 units) Outdoor unit FDC250VS
 Cool Mode (kW)

Outdoor air temp.	Indoor air temperature															
	18 DB		21 DB		23 DB		26 DB		27 DB		28 DB		31 DB		33 DB	
	12 WB	14 WB	16 WB	18 WB	19 WB	20 WB	22 WB	24 WB	TC	SHC	TC	SHC	TC	SHC	TC	SHC
DB	TC	SHC	TC	SHC	TC	SHC	TC	SHC	TC	SHC	TC	SHC	TC	SHC	TC	SHC
11					21.71	20.06	23.02	22.05	23.67	21.71	24.38	21.36	25.79	22.78	27.21	21.98
13					22.38	20.23	23.74	22.21	24.42	21.86	25.16	21.50	26.63	22.90	28.11	22.08
15					23.04	20.40	24.46	22.37	25.17	22.01	25.94	21.64	27.48	23.03	29.02	22.18
17					23.70	20.57	25.18	22.53	25.92	22.16	26.72	21.79	28.32	23.15	29.92	22.29
19					24.19	20.70	25.70	22.65	26.45	22.27	27.27	21.89	28.89	23.24	30.52	22.36
21					24.26	20.72	26.22	22.77	26.99	22.38	27.82	22.00	29.47	23.33	31.12	22.43
23					24.13	20.69	26.07	22.73	26.84	22.35	27.65	21.96	29.28	23.30	30.91	22.41
25			21.69	21.26	24.00	20.65	25.92	22.70	26.68	22.32	27.49	21.93	29.10	23.27	30.71	22.38
27			21.60	21.17	23.88	20.62	25.77	22.66	26.53	22.29	27.29	21.89	28.80	23.23		
29			21.42	20.99	23.56	20.54	25.39	22.58	26.15	22.21	26.91	21.82	28.43	23.17		
31			21.24	20.82	23.24	20.45	25.00	22.49	25.77	22.13	26.53	21.75	28.06	23.11		
33	20.58	19.78	21.29	20.86	22.92	20.37	24.61	22.40	25.38	22.05	26.15	21.68	27.69	23.06		
35	20.17	19.64	20.96	20.54	22.60	20.29	24.23	22.32	25.00	21.97	25.77	21.61	27.31	23.00		
37	19.83	19.43	20.62	20.21	22.20	20.18	23.73	22.21	24.47	21.87	25.21	21.51	26.69	22.91		
39	19.49	19.10	20.29	19.88	21.80	20.08	23.22	22.10	23.93	21.76	24.64	21.40	26.06	22.82		
41	19.15	18.77	19.96	19.56	21.41	19.98	22.72	21.99	23.40	21.65	24.08	21.30	25.43	22.73		
43	18.81	18.43	19.63	19.24	21.01	19.88	22.22	21.78	22.86	21.55	23.51	21.20	24.81	22.64		

Heat Mode: HC (kW)

Outdoor air temp.		Indoor air temperature					
DB	WB	16	18	20	22	24	
-19.8	-20						
-17.7	-18						
-15.7	-16						
-13.5	-14	16.52	16.47	16.43	16.39	16.35	
-11.5	-12	17.39	17.34	17.29	17.24	17.19	
-9.5	-10	18.26	18.21	18.15	18.09	18.04	
-7.5	-8	19.14	19.07	19.01	18.94	18.88	
-5.5	-6	19.55	19.47	19.40	19.32	19.24	
-3.0	-4	19.95	19.87	19.78	19.70	19.61	
-1.0	-2	20.36	20.26	20.17	20.07	19.98	
1.0	0	20.77	20.66	20.55	20.45	20.35	
2.0	1	20.97	20.86	20.74	20.64	20.53	
3.0	2	22.45	22.32	22.19	22.07	21.95	
5.0	4	25.42	25.26	25.10	24.95	24.80	
7.0	6	28.38	28.19	28.00	27.82	27.65	
9.0	8	29.28	29.10	28.91	28.60	28.28	
11.5	10	30.18	30.00	29.83	29.37	28.91	
13.5	12	31.76	31.55	31.33	30.97	30.53	
15.5	14	33.34	33.09	32.84	32.57	32.15	
16.5	16	34.13	33.86	33.59	33.37	32.96	

Note(1) These data show average statuses.
 Depending on the system control, there may be ranges where the operation is not conducted continuously.
 These data show the case where the operation frequency of a compressor is fixed.

(2) Capacities are based on the following conditions.
 Corresponding refrigerant piping length : 7.5m
 Level difference of Zero.

(3) Symbols are as follows.
 TC : Total cooling capacity (kW)
 SHC : Sensible heat capacity (kW)
 HC : Heating capacity (kW)

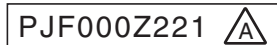

(2) Ceiling cassette-4way compact type (FDTC)
(a) Twin type

Model **FDTC100VNPVF** Indoor unit FDT50VF (2 units) Outdoor unit FDC100VN
Cool Mode (kW) Heat Mode:HC (kW)

Outdoor air temp.	Indoor air temperature															
	18 DB		21 DB		23 DB		26 DB		27 DB		28 DB		31 DB		33 DB	
	12 WB		14 WB		16 WB		18 WB		19 WB		20 WB		22 WB		24 WB	
DB	TC	SHC	TC	SHC	TC	SHC	TC	SHC	TC	SHC	TC	SHC	TC	SHC	TC	SHC
11					8.12	6.48	8.59	6.95	8.82	6.90	9.07	6.85	9.56	7.20	10.06	7.07
13					8.50	6.64	9.00	7.12	9.26	7.08	9.52	7.02	10.06	7.38	10.60	7.25
15					8.88	6.81	9.42	7.30	9.69	7.25	9.98	7.20	10.56	7.55	11.14	7.42
17					9.26	6.99	9.84	7.48	10.12	7.42	10.43	7.38	11.05	7.73	11.67	7.60
19					9.46	7.08	10.05	7.57	10.34	7.51	10.65	7.46	11.29	7.82	11.92	7.68
21					9.65	7.17	10.25	7.65	10.56	7.60	10.88	7.56	11.52	7.90	12.16	7.77
23					9.65	7.17	10.28	7.66	10.59	7.62	10.91	7.57	11.56	7.92	12.21	7.78
25			8.93	7.25	9.64	7.16	10.31	7.68	10.62	7.63	10.95	7.58	11.61	7.94	12.27	7.80
27			8.86	7.21	9.64	7.16	10.34	7.69	10.65	7.64	10.96	7.59	11.57	7.92		
29			8.80	7.18	9.50	7.10	10.17	7.62	10.49	7.58	10.81	7.53	11.45	7.88		
31			8.73	7.15	9.35	7.03	9.99	7.54	10.32	7.51	10.66	7.47	11.32	7.83		
33	8.22	6.72	8.58	7.08	9.21	6.96	9.82	7.47	10.16	7.44	10.51	7.41	11.19	7.78		
35	8.05	6.63	8.44	7.01	9.06	6.90	9.64	7.39	10.00	7.37	10.36	7.35	11.07	7.74		
37	7.92	6.57	8.30	6.94	8.91	6.83	9.46	7.32	9.79	7.29	10.13	7.26	10.80	7.64		
39	7.78	6.49	8.16	6.87	8.75	6.76	9.28	7.24	9.59	7.21	9.90	7.17	10.53	7.54		
41	7.64	6.42	8.02	6.81	8.60	6.69	9.09	7.16	9.38	7.12	9.68	7.08	10.26	7.45		
43	7.50	6.35	7.88	6.74	8.45	6.62	8.91	7.09	9.18	7.04	9.45	7.00	9.99	7.35		

Outdoor air temp.		Indoor air temperature					
		DB					
DB	WB	16	18	20	22	24	
-19.8	-20	5.64	5.62	5.60	5.58	5.56	
-17.7	-18	5.97	5.95	5.92	5.90	5.87	
-15.7	-16	6.30	6.27	6.25	6.22	6.19	
-13.5	-14	6.66	6.63	6.60	6.57	6.54	
-11.5	-12	7.03	6.99	6.96	6.93	6.90	
-9.5	-10	7.39	7.36	7.32	7.29	7.25	
-7.5	-8	7.75	7.72	7.68	7.64	7.60	
-5.5	-6	7.92	7.88	7.85	7.80	7.76	
-3.0	-4	8.10	8.05	8.01	7.97	7.92	
-1.0	-2	8.27	8.22	8.18	8.13	8.08	
1.0	0	8.44	8.39	8.34	8.29	8.24	
2.0	1	8.52	8.47	8.42	8.37	8.32	
3.0	2	9.08	9.03	8.98	8.94	8.90	
5.0	4	10.21	10.15	10.09	10.08	10.07	
7.0	6	11.33	11.27	11.20	11.22	11.23	
9.0	8	11.78	11.71	11.64	11.62	11.59	
11.5	10	12.23	12.16	12.09	12.02	11.94	
13.5	12	12.91	12.83	12.75	12.65	12.60	
15.5	14	13.59	13.50	13.42	13.29	13.26	
16.5	16	13.93	13.84	13.75	13.61	13.59	

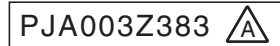

Model **FDTC100VSPVF** Indoor unit FDT50VF (2 units) Outdoor unit FDC100VS
Cool Mode (kW) Heat Mode:HC (kW)

Outdoor air temp.	Indoor air temperature															
	18 DB		21 DB		23 DB		26 DB		27 DB		28 DB		31 DB		33 DB	
	12 WB		14 WB		16 WB		18 WB		19 WB		20 WB		22 WB		24 WB	
DB	TC	SHC	TC	SHC	TC	SHC	TC	SHC	TC	SHC	TC	SHC	TC	SHC	TC	SHC
11					8.12	6.48	8.59	6.95	8.82	6.90	9.07	6.85	9.56	7.20	10.06	7.07
13					8.50	6.64	9.00	7.12	9.26	7.08	9.52	7.02	10.06	7.38	10.60	7.25
15					8.88	6.81	9.42	7.30	9.69	7.25	9.98	7.20	10.56	7.55	11.14	7.42
17					9.26	6.99	9.84	7.48	10.12	7.42	10.43	7.38	11.05	7.73	11.67	7.60
19					9.46	7.08	10.05	7.57	10.34	7.51	10.65	7.46	11.29	7.82	11.92	7.68
21					9.65	7.17	10.25	7.65	10.56	7.60	10.88	7.56	11.52	7.90	12.16	7.77
23					9.65	7.17	10.28	7.66	10.59	7.62	10.91	7.57	11.56	7.92	12.21	7.78
25			8.93	7.25	9.64	7.16	10.31	7.68	10.62	7.63	10.95	7.58	11.61	7.94	12.27	7.80
27			8.86	7.21	9.64	7.16	10.34	7.69	10.65	7.64	10.96	7.59	11.57	7.92		
29			8.80	7.18	9.50	7.10	10.17	7.62	10.49	7.58	10.81	7.53	11.45	7.88		
31			8.73	7.15	9.35	7.03	9.99	7.54	10.32	7.51	10.66	7.47	11.32	7.83		
33	8.22	6.72	8.58	7.08	9.21	6.96	9.82	7.47	10.16	7.44	10.51	7.41	11.19	7.78		
35	8.05	6.63	8.44	7.01	9.06	6.90	9.64	7.39	10.00	7.37	10.36	7.35	11.07	7.74		
37	7.92	6.57	8.30	6.94	8.91	6.83	9.46	7.32	9.79	7.29	10.13	7.26	10.80	7.64		
39	7.78	6.49	8.16	6.87	8.75	6.76	9.28	7.24	9.59	7.21	9.90	7.17	10.53	7.54		
41	7.64	6.42	8.02	6.81	8.60	6.69	9.09	7.16	9.38	7.12	9.68	7.08	10.26	7.45		
43	7.50	6.35	7.88	6.74	8.45	6.62	8.91	7.09	9.18	7.04	9.45	7.00	9.99	7.35		

Outdoor air temp.		Indoor air temperature					
		DB					
DB	WB	16	18	20	22	24	
-19.8	-20	5.64	5.62	5.60	5.58	5.56	
-17.7	-18	5.97	5.95	5.92	5.90	5.87	
-15.7	-16	6.30	6.27	6.25	6.22	6.19	
-13.5	-14	6.66	6.63	6.60	6.57	6.54	
-11.5	-12	7.03	6.99	6.96	6.93	6.90	
-9.5	-10	7.39	7.36	7.32	7.29	7.25	
-7.5	-8	7.75	7.72	7.68	7.64	7.60	
-5.5	-6	7.92	7.88	7.85	7.80	7.76	
-3.0	-4	8.10	8.05	8.01	7.97	7.92	
-1.0	-2	8.27	8.22	8.18	8.13	8.08	
1.0	0	8.44	8.39	8.34	8.29	8.24	
2.0	1	8.52	8.47	8.42	8.37	8.32	
3.0	2	9.08	9.03	8.98	8.94	8.90	
5.0	4	10.21	10.15	10.09	10.08	10.07	
7.0	6	11.33	11.27	11.20	11.22	11.23	
9.0	8	11.78	11.71	11.64	11.62	11.59	
11.5	10	12.23	12.16	12.09	12.02	11.94	
13.5	12	12.91	12.83	12.75	12.65	12.60	
15.5	14	13.59	13.50	13.42	13.29	13.26	
16.5	16	13.93	13.84	13.75	13.61	13.59	

Note(1) These data show average statuses.
Depending on the system control, there may be ranges where the operation is not conducted continuously.
These data show the case where the operation frequency of a compressor is fixed.

(2) Capacities are based on the following conditions.
Corresponding refrigerant piping length :7.5m
Level difference of Zero.

(3) Symbols are as follows.
TC : Total cooling capacity (kW)
SHC : Sensible heat capacity (kW)
HC : Heating capacity (kW)

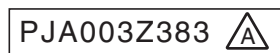

Model **FDTC125VNPVF** Indoor unit **FDT60VF (2 units)** Outdoor unit **FDC125VN**
 Cool Mode (kW)

Outdoor air temp.	Indoor air temperature															
	18 DB		21 DB		23 DB		26 DB		27 DB		28 DB		31 DB		33 DB	
	12 WB	14 WB	16 WB	18 WB	19 WB	20 WB	22 WB	24 WB								
DB	TC	SHC	TC	SHC	TC	SHC	TC	SHC	TC	SHC	TC	SHC	TC	SHC	TC	SHC
11					10.15	7.28	10.74	7.76	11.03	7.67	11.34	7.57	11.96	7.89	12.57	7.67
13					10.63	7.48	11.26	7.96	11.57	7.87	11.91	7.78	12.58	8.09	13.25	7.86
15					11.10	7.69	11.78	8.17	12.11	8.07	12.47	7.98	13.20	8.30	13.92	8.06
17					11.58	7.90	12.29	8.37	12.65	8.28	13.04	8.19	13.82	8.51	14.59	8.26
19					11.82	8.01	12.56	8.48	12.92	8.39	13.32	8.30	14.11	8.61	14.90	8.36
21					12.06	8.11	12.82	8.59	13.19	8.49	13.60	8.40	14.40	8.71	15.20	8.45
23					12.06	8.11	12.85	8.61	13.23	8.51	13.64	8.42	14.45	8.72	15.27	8.48
25			11.16	8.26	12.06	8.11	12.89	8.62	13.27	8.53	13.68	8.43	14.51	8.74	15.34	8.50
27			11.08	8.22	12.05	8.11	12.92	8.63	13.31	8.54	13.69	8.44	14.47	8.73		
29			11.00	8.18	11.87	8.03	12.71	8.55	13.11	8.46	13.51	8.37	14.31	8.67		
31			10.92	8.15	11.69	7.95	12.49	8.46	12.90	8.38	13.32	8.30	14.15	8.62		
33	10.27	7.71	10.72	8.05	11.51	7.87	12.27	8.37	12.70	8.30	13.13	8.22	13.99	8.56		
35	10.07	7.61	10.55	7.97	11.33	7.79	12.06	8.28	12.50	8.22	12.94	8.15	13.83	8.51		
37	9.90	7.52	10.38	7.89	11.13	7.70	11.83	8.19	12.24	8.12	12.66	8.05	13.50	8.40		
39	9.72	7.43	10.20	7.81	10.94	7.62	11.60	8.09	11.99	8.03	12.38	7.95	13.16	8.28		
41	9.55	7.35	10.02	7.72	10.75	7.54	11.37	8.00	11.73	7.93	12.09	7.84	12.82	8.17		
43	9.38	7.26	9.85	7.64	10.56	7.45	11.14	7.91	11.47	7.83	11.81	7.74	12.48	8.06		

Heat Mode:HC (kW)

Outdoor air temp.	Indoor air temperature					
	DB					
DB	WB	16	18	20	22	24
-19.8	-20	7.06	7.03	7.00	6.97	6.95
-17.7	-18	7.46	7.43	7.41	7.37	7.34
-15.7	-16	7.87	7.84	7.81	7.77	7.74
-13.5	-14	8.33	8.29	8.26	8.22	8.18
-11.5	-12	8.78	8.74	8.70	8.66	8.62
-9.5	-10	9.24	9.19	9.15	9.11	9.06
-7.5	-8	9.69	9.65	9.60	9.55	9.50
-5.5	-6	9.91	9.86	9.81	9.75	9.70
-3.0	-4	10.12	10.07	10.01	9.96	9.90
-1.0	-2	10.33	10.28	10.22	10.16	10.10
1.0	0	10.55	10.49	10.43	10.36	10.30
2.0	1	10.65	10.59	10.53	10.47	10.40
3.0	2	11.36	11.29	11.22	11.18	11.13
5.0	4	12.76	12.69	12.61	12.60	12.58
7.0	6	14.16	14.08	14.00	14.02	14.04
9.0	8	14.72	14.64	14.56	14.52	14.49
11.5	10	15.28	15.20	15.11	15.02	14.93
13.5	12	16.13	16.04	15.94	15.82	15.75
15.5	14	16.98	16.88	16.77	16.62	16.58
16.5	16	17.41	17.30	17.19	17.02	16.99

PJA003Z383 

Model **FDTC125VSPVF** Indoor unit **FDT60VF (2 units)** Outdoor unit **FDC125VS**
 Cool Mode (kW)

Outdoor air temp.	Indoor air temperature															
	18 DB		21 DB		23 DB		26 DB		27 DB		28 DB		31 DB		33 DB	
	12 WB	14 WB	16 WB	18 WB	19 WB	20 WB	22 WB	24 WB								
DB	TC	SHC	TC	SHC	TC	SHC	TC	SHC	TC	SHC	TC	SHC	TC	SHC	TC	SHC
11					10.15	7.28	10.74	7.76	11.03	7.67	11.34	7.57	11.96	7.89	12.57	7.67
13					10.63	7.48	11.26	7.96	11.57	7.87	11.91	7.78	12.58	8.09	13.25	7.86
15					11.10	7.69	11.78	8.17	12.11	8.07	12.47	7.98	13.20	8.30	13.92	8.06
17					11.58	7.90	12.29	8.37	12.65	8.28	13.04	8.19	13.82	8.51	14.59	8.26
19					11.82	8.01	12.56	8.48	12.92	8.39	13.32	8.30	14.11	8.61	14.90	8.36
21					12.06	8.11	12.82	8.59	13.19	8.49	13.60	8.40	14.40	8.71	15.20	8.45
23					12.06	8.11	12.85	8.61	13.23	8.51	13.64	8.42	14.45	8.72	15.27	8.48
25			11.16	8.26	12.06	8.11	12.89	8.62	13.27	8.53	13.68	8.43	14.51	8.74	15.34	8.50
27			11.08	8.22	12.05	8.11	12.92	8.63	13.31	8.54	13.69	8.44	14.47	8.73		
29			11.00	8.18	11.87	8.03	12.71	8.55	13.11	8.46	13.51	8.37	14.31	8.67		
31			10.92	8.15	11.69	7.95	12.49	8.46	12.90	8.38	13.32	8.30	14.15	8.62		
33	10.27	7.71	10.72	8.05	11.51	7.87	12.27	8.37	12.70	8.30	13.13	8.22	13.99	8.56		
35	10.07	7.61	10.55	7.97	11.33	7.79	12.06	8.28	12.50	8.22	12.94	8.15	13.83	8.51		
37	9.90	7.52	10.38	7.89	11.13	7.70	11.83	8.19	12.24	8.12	12.66	8.05	13.50	8.40		
39	9.72	7.43	10.20	7.81	10.94	7.62	11.60	8.09	11.99	8.03	12.38	7.95	13.16	8.28		
41	9.55	7.35	10.02	7.72	10.75	7.54	11.37	8.00	11.73	7.93	12.09	7.84	12.82	8.17		
43	9.38	7.26	9.85	7.64	10.56	7.45	11.14	7.91	11.47	7.83	11.81	7.74	12.48	8.06		

Heat Mode:HC (kW)

Outdoor air temp.	Indoor air temperature					
	DB					
DB	WB	16	18	20	22	24
-19.8	-20	7.06	7.03	7.00	6.97	6.95
-17.7	-18	7.46	7.43	7.41	7.37	7.34
-15.7	-16	7.87	7.84	7.81	7.77	7.74
-13.5	-14	8.33	8.29	8.26	8.22	8.18
-11.5	-12	8.78	8.74	8.70	8.66	8.62
-9.5	-10	9.24	9.19	9.15	9.11	9.06
-7.5	-8	9.69	9.65	9.60	9.55	9.50
-5.5	-6	9.91	9.86	9.81	9.75	9.70
-3.0	-4	10.12	10.07	10.01	9.96	9.90
-1.0	-2	10.33	10.28	10.22	10.16	10.10
1.0	0	10.55	10.49	10.43	10.36	10.30
2.0	1	10.65	10.59	10.53	10.47	10.40
3.0	2	11.36	11.29	11.22	11.18	11.13
5.0	4	12.76	12.69	12.61	12.60	12.58
7.0	6	14.16	14.08	14.00	14.02	14.04
9.0	8	14.72	14.64	14.56	14.52	14.49
11.5	10	15.28	15.20	15.11	15.02	14.93
13.5	12	16.13	16.04	15.94	15.82	15.75
15.5	14	16.98	16.88	16.77	16.62	16.58
16.5	16	17.41	17.30	17.19	17.02	16.99

PJA003Z383 

Note(1) These data show average statuses.

Depending on the system control, there may be ranges where the operation is not conducted continuously.

These data show the case where the operation frequency of a compressor is fixed.

(2) Capacities are based on the following conditions.

Corresponding refrigerant piping length :7.5m

Level difference of Zero.

(3) Symbols are as follows.

TC : Total cooling capacity (kW)

SHC : Sensible heat capacity (kW)

HC : Heating capacity (kW)

(c) Triple type

Model FDTFC140VNTVF Indoor unit FDT50VF (3 units) Outdoor unit FDC140VN
Cool Mode

Outdoor air temp.	Indoor air temperature															Heat Mode:HC							
	18 DB		21 DB		23 DB		26 DB		27 DB		28 DB		31 DB		33 DB		Outdoor air temp.		Indoor air temperature				
	12 WB		14 WB		16 WB		18 WB		19 WB		20 WB		22 WB		24 WB		DB	WB	16	18	20	22	24
DB	TC	SHC	TC	SHC	TC	SHC	TC	SHC	TC	SHC	TC	SHC	TC	SHC	TC	SHC	TC	SHC	TC	SHC	TC	SHC	
11					11.37	9.36	12.02	10.08	12.35	10.01	12.70	9.94	13.39	10.47	14.08	10.29	-19.8	-20	8.06	8.03	8.00	7.97	7.94
13					11.90	9.59	12.61	10.32	12.96	10.25	13.33	10.17	14.09	10.71	14.84	10.53	-17.7	-18	8.53	8.50	8.46	8.43	8.39
15					12.43	9.82	13.19	10.56	13.57	10.49	13.97	10.42	14.78	10.96	15.59	10.77	-15.7	-16	9.00	8.96	8.92	8.88	8.85
17					12.96	10.06	13.77	10.80	14.17	10.73	14.61	10.66	15.48	11.20	16.34	11.01	-13.5	-14	9.52	9.48	9.43	9.39	9.35
19					13.24	10.19	14.06	10.92	14.48	10.85	14.92	10.78	15.80	11.32	16.68	11.13	-11.5	-12	10.04	9.99	9.95	9.90	9.85
21					13.51	10.31	14.36	11.04	14.78	10.97	15.23	10.90	16.12	11.43	17.02	11.24	-9.5	-10	10.56	10.51	10.46	10.41	10.36
23					13.51	10.31	14.40	11.06	14.82	10.99	15.28	10.92	16.19	11.46	17.10	11.27	-7.5	-8	11.08	11.02	10.97	10.91	10.86
25			12.50	10.44	13.50	10.30	14.43	11.07	14.86	11.00	15.33	10.94	16.25	11.48	17.18	11.29	-5.5	-6	11.32	11.26	11.21	11.15	11.09
27			12.41	10.39	13.50	10.30	14.47	11.09	14.91	11.02	15.34	10.95	16.20	11.46			-3.0	-4	11.56	11.50	11.44	11.38	11.31
29			12.32	10.35	13.29	10.21	14.23	10.99	14.68	10.93	15.13	10.86	16.02	11.40			-1.0	-2	11.81	11.75	11.68	11.61	11.54
31			12.23	10.31	13.09	10.12	13.99	10.89	14.45	10.84	14.92	10.78	15.85	11.34			1.0	0	12.05	11.99	11.92	11.84	11.77
33	11.51	9.66	12.01	10.20	12.89	10.03	13.75	10.79	14.23	10.75	14.71	10.70	15.67	11.27			2.0	1	12.18	12.11	12.04	11.96	11.89
35	11.28	9.54	11.82	10.11	12.68	9.94	13.50	10.68	14.00	10.66	14.50	10.62	15.49	11.21			3.0	2	12.98	12.90	12.83	12.77	12.72
37	11.08	9.44	11.62	10.02	12.47	9.84	13.25	10.58	13.71	10.54	14.18	10.50	15.12	11.08			4.0	1	14.58	14.50	14.41	14.40	14.38
39	10.89	9.34	11.43	9.93	12.26	9.75	12.99	10.47	13.43	10.43	13.86	10.37	14.74	10.94			5.0	2	16.19	16.09	16.00	16.02	16.05
41	10.70	9.25	11.23	9.83	12.04	9.65	12.73	10.37	13.14	10.32	13.55	10.26	14.36	10.81			6.0	1	16.83	16.73	16.63	16.59	16.55
43	10.51	9.15	11.03	9.74	11.83	9.56	12.47	10.26	12.85	10.20	13.23	10.14	13.98	10.68			7.0	2	17.46	17.37	17.27	17.17	17.06
																	8.0	1	18.44	18.33	18.22	18.08	18.00
																	9.0	2	19.41	19.29	19.17	18.99	18.95
																	10.0	1	19.90	19.77	19.64	19.45	19.42
																	11.0	2					
																	12.0	1					
																	13.0	2					
																	14.0	1					
																	15.0	2					
																	16.0	1					

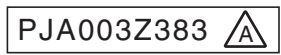

Model FDTFC140VSTVF Indoor unit FDT50VF (3 units) Outdoor unit FDC140VS
Cool Mode

Outdoor air temp.	Indoor air temperature															Heat Mode:HC							
	18 DB		21 DB		23 DB		26 DB		27 DB		28 DB		31 DB		33 DB		Outdoor air temp.		Indoor air temperature				
	12 WB		14 WB		16 WB		18 WB		19 WB		20 WB		22 WB		24 WB		DB	WB	16	18	20	22	24
DB	TC	SHC	TC	SHC	TC	SHC	TC	SHC	TC	SHC	TC	SHC	TC	SHC	TC	SHC	TC	SHC	TC	SHC	TC	SHC	
11					11.37	9.36	12.02	10.08	12.35	10.01	12.70	9.94	13.39	10.47	14.08	10.29	-19.8	-20	8.06	8.03	8.00	7.97	7.94
13					11.90	9.59	12.61	10.32	12.96	10.25	13.33	10.17	14.09	10.71	14.84	10.53	-17.7	-18	8.53	8.50	8.46	8.43	8.39
15					12.43	9.82	13.19	10.56	13.57	10.49	13.97	10.42	14.78	10.96	15.59	10.77	-15.7	-16	9.00	8.96	8.92	8.88	8.85
17					12.96	10.06	13.77	10.80	14.17	10.73	14.61	10.66	15.48	11.20	16.34	11.01	-13.5	-14	9.52	9.48	9.43	9.39	9.35
19					13.24	10.19	14.06	10.92	14.48	10.85	14.92	10.78	15.80	11.32	16.68	11.13	-11.5	-12	10.04	9.99	9.95	9.90	9.85
21					13.51	10.31	14.36	11.04	14.78	10.97	15.23	10.90	16.12	11.43	17.02	11.24	-9.5	-10	10.56	10.51	10.46	10.41	10.36
23					13.51	10.31	14.40	11.06	14.82	10.99	15.28	10.92	16.19	11.46	17.10	11.27	-7.5	-8	11.08	11.02	10.97	10.91	10.86
25			12.50	10.44	13.50	10.30	14.43	11.07	14.86	11.00	15.33	10.94	16.25	11.48	17.18	11.29	-5.5	-6	11.32	11.26	11.21	11.15	11.09
27			12.41	10.39	13.50	10.30	14.47	11.09	14.91	11.02	15.34	10.95	16.20	11.46			-3.0	-4	11.56	11.50	11.44	11.38	11.31
29			12.32	10.35	13.29	10.21	14.23	10.99	14.68	10.93	15.13	10.86	16.02	11.40			-1.0	-2	11.81	11.75	11.68	11.61	11.54
31			12.23	10.31	13.09	10.12	13.99	10.89	14.45	10.84	14.92	10.78	15.85	11.34			1.0	0	12.05	11.99	11.92	11.84	11.77
33	11.51	9.66	12.01	10.20	12.89	10.03	13.75	10.79	14.23	10.75	14.71	10.70	15.67	11.27			2.0	1	12.18	12.11	12.04	11.96	11.89
35	11.28	9.54	11.82	10.11	12.68	9.94	13.50	10.68	14.00	10.66	14.50	10.62	15.49	11.21			3.0	2	12.98	12.90	12.83	12.77	12.72
37	11.08	9.44	11.62	10.02	12.47	9.84	13.25	10.58	13.71	10.54	14.18	10.50	15.12	11.08			4.0	1	14.58	14.50	14.41	14.40	14.38
39	10.89	9.34	11.43	9.93	12.26	9.75	12.99	10.47	13.43	10.43	13.86	10.37	14.74	10.94			5.0	2	16.19	16.09	16.00	16.02	16.05
41	10.70	9.25	11.23	9.83	12.04	9.65	12.73	10.37	13.14	10.32	13.55	10.26	14.36	10.81			6.0	1	16.83	16.73	16.63	16.59	16.55
43	10.51	9.15	11.03	9.74	11.83	9.56	12.47	10.26	12.85	10.20	13.23	10.14	13.98	10.68			7.0	2	17.46	17.37	17.27	17.17	17.06
																	8.0	1	18.44	18.33	18.22	18.08	18.00
																	9.0	2	19.41	19.29	19.17	18.99	18.95
																	10.0	1	19.90	19.77	19.64	19.45	19.42
																	11.0	2					
																	12.0	1					
																	13.0	2					
																	14.0	1					
																	15.0	2					
																	16.0	1					

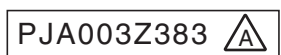

Note(1) These data show average statuses.
Depending on the system control, there may be ranges where the operation is not conducted continuously.
These data show the case where the operation frequency of a compressor is fixed.
(2) Capacities are based on the following conditions.
Corresponding refrigerant piping length :7.5m
Level difference of Zero.
(3) Symbols are as follows.
TC : Total cooling capacity (kW)
SHC : Sensible heat capacity (kW)
HC : Heating capacity (kW)

(c) Double twin type

Model **FDTC200VSDVF** Indoor unit **FDT50VF (4 units)** Outdoor unit **FDC200VS**
Cool Mode (kW) Heat Mode:HC (kW)

Outdoor air temp.	Indoor air temperature															
	18 DB		21 DB		23 DB		26 DB		27 DB		28 DB		31 DB		33 DB	
	12 WB	14 WB	16 WB	18 WB	19 WB	20 WB	22 WB	24 WB	TC	SHC	TC	SHC	TC	SHC	TC	SHC
DB	TC	SHC	TC	SHC	TC	SHC	TC	SHC	TC	SHC	TC	SHC	TC	SHC	TC	SHC
11					17.37	13.45	18.41	14.42	18.94	14.32	19.50	14.22	20.63	14.93	21.76	14.68
13					17.90	13.69	18.99	14.66	19.54	14.56	20.13	14.47	21.31	15.18	22.49	14.92
15					18.43	13.93	19.57	14.90	20.14	14.81	20.75	14.71	21.98	15.42	23.21	15.16
17					18.96	14.18	20.14	15.15	20.73	15.05	21.38	14.96	22.66	15.67	23.94	15.40
19					19.35	14.36	20.56	15.33	21.16	15.23	21.81	15.13	23.12	15.84	24.42	15.57
21					19.41	14.38	20.98	15.51	21.59	15.41	22.25	15.31	23.57	16.01	24.89	15.73
23					19.31	14.34	20.86	15.46	21.47	15.36	22.12	15.26	23.43	15.95	24.73	15.67
25			17.35	14.25	19.20	14.29	20.74	15.41	21.35	15.31	21.99	15.20	23.28	15.90	24.57	15.62
27			17.28	14.21	19.10	14.24	20.62	15.35	21.22	15.25	21.83	15.14	23.04	15.81		
29			17.14	14.14	18.85	14.13	20.31	15.22	20.92	15.13	21.53	15.02	22.75	15.70		
31			16.99	14.07	18.59	14.01	20.00	15.09	20.61	15.00	21.22	14.90	22.45	15.59		
33	16.46	13.45	17.03	14.09	18.33	13.89	19.69	14.96	20.31	14.88	20.92	14.78	22.15	15.48		
35	16.14	13.29	16.76	13.96	18.08	13.77	19.38	14.82	20.00	14.75	20.62	14.66	21.85	15.37		
37	15.86	13.14	16.50	13.83	17.76	13.63	18.98	14.66	19.57	14.57	20.17	14.48	21.35	15.19		
39	15.59	13.00	16.23	13.71	17.44	13.49	18.58	14.49	19.15	14.40	19.71	14.30	20.85	15.01		
41	15.32	12.86	15.97	13.58	17.13	13.35	18.17	14.32	18.72	14.23	19.26	14.13	20.35	14.83		
43	15.04	12.72	15.70	13.45	16.81	13.20	17.77	14.15	18.29	14.06	18.81	13.96	19.85	14.66		

Outdoor air temp.		Indoor air temperature					
DB	WB	DB					
		16	18	20	22	24	
-19.8	-20						
-17.7	-18						
-15.7	-16						
-13.5	-14	13.21	13.18	13.14	13.11	13.08	
-11.5	-12	13.91	13.87	13.83	13.79	13.76	
-9.5	-10	14.61	14.57	14.52	14.47	14.43	
-7.5	-8	15.31	15.26	15.21	15.16	15.10	
-5.5	-6	15.64	15.58	15.52	15.46	15.40	
-3.0	-4	15.96	15.89	15.82	15.76	15.69	
-1.0	-2	16.29	16.21	16.13	16.06	15.98	
1.0	0	16.61	16.53	16.44	16.36	16.28	
2.0	1	16.78	16.69	16.59	16.51	16.42	
3.0	2	17.96	17.86	17.76	17.66	17.56	
5.0	4	20.33	20.21	20.08	19.96	19.84	
7.0	6	22.71	22.55	22.40	22.26	22.12	
9.0	8	23.43	23.28	23.13	22.88	22.63	
11.5	10	24.14	24.00	23.86	23.50	23.13	
13.5	12	25.41	25.24	25.07	24.77	24.43	
15.5	14	26.67	26.47	26.27	26.05	25.72	
16.5	16	27.30	27.09	26.87	26.69	26.37	

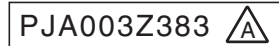

Model **FDTC250VSDVF** Indoor unit **FDT60VF (4 units)** Outdoor unit **FDC250VS**
Cool Mode (kW) Heat Mode:HC (kW)

Outdoor air temp.	Indoor air temperature															
	18 DB		21 DB		23 DB		26 DB		27 DB		28 DB		31 DB		33 DB	
	12 WB	14 WB	16 WB	18 WB	19 WB	20 WB	22 WB	24 WB	TC	SHC	TC	SHC	TC	SHC	TC	SHC
DB	TC	SHC	TC	SHC	TC	SHC	TC	SHC	TC	SHC	TC	SHC	TC	SHC	TC	SHC
11					21.71	15.16	23.02	16.12	23.67	15.93	24.38	15.75	25.79	16.39	27.21	15.94
13					22.38	15.45	23.74	16.41	24.42	16.22	25.16	16.04	26.63	16.67	28.11	16.20
15					23.04	15.75	24.46	16.70	25.17	16.51	25.94	16.33	27.48	16.96	29.02	16.48
17					23.70	16.04	25.18	16.99	25.92	16.81	26.72	16.62	28.32	17.25	29.92	16.76
19					24.19	16.26	25.70	17.21	26.45	17.02	27.27	16.83	28.89	17.44	30.52	16.94
21					24.26	16.29	26.22	17.43	26.99	17.23	27.82	17.04	29.47	17.65	31.12	17.13
23					24.13	16.23	26.07	17.37	26.84	17.17	27.65	16.98	29.28	17.58	30.91	17.07
25			21.69	16.22	24.00	16.17	25.92	17.30	26.68	17.11	27.49	16.92	29.10	17.52	30.71	17.00
27			21.60	16.18	23.88	16.12	25.77	17.24	26.53	17.05	27.29	16.84	28.80	17.41		
29			21.42	16.09	23.56	15.98	25.39	17.08	26.15	16.90	26.91	16.69	28.43	17.28		
31			21.24	16.01	23.24	15.83	25.00	16.92	25.77	16.75	26.53	16.55	28.06	17.16		
33	20.58	15.44	21.29	16.03	22.92	15.69	24.61	16.76	25.38	16.59	26.15	16.41	27.69	17.03		
35	20.17	15.23	20.96	15.87	22.60	15.55	24.23	16.60	25.00	16.44	25.77	16.26	27.31	16.90		
37	19.83	15.06	20.62	15.71	22.20	15.38	23.73	16.40	24.47	16.24	25.21	16.06	26.69	16.69		
39	19.49	14.89	20.29	15.56	21.80	15.20	23.22	16.20	23.93	16.03	24.64	15.85	26.06	16.48		
41	19.15	14.72	19.96	15.41	21.41	15.03	22.72	16.00	23.40	15.83	24.08	15.65	25.43	16.28		
43	18.81	14.55	19.63	15.26	21.01	14.86	22.22	15.80	22.86	15.63	23.51	15.44	24.81	16.07		

Outdoor air temp.		Indoor air temperature					
DB	WB	DB					
		16	18	20	22	24	
-19.8	-20						
-17.7	-18						
-15.7	-16						
-13.5	-14	16.52	16.47	16.43	16.39	16.35	
-11.5	-12	17.39	17.34	17.29	17.24	17.19	
-9.5	-10	18.26	18.21	18.15	18.09	18.04	
-7.5	-8	19.14	19.07	19.01	18.94	18.88	
-5.5	-6	19.55	19.47	19.40	19.32	19.24	
-3.0	-4	19.95	19.87	19.78	19.70	19.61	
-1.0	-2	20.36	20.26	20.17	20.07	19.98	
1.0	0	20.77	20.66	20.55	20.45	20.35	
2.0	1	20.97	20.86	20.74	20.64	20.53	
3.0	2	22.45	22.32	22.19	22.07	21.95	
5.0	4	25.42	25.26	25.10	24.95	24.80	
7.0	6	28.38	28.19	28.00	27.82	27.65	
9.0	8	29.28	29.10	28.91	28.60	28.28	
11.5	10	30.18	30.00	29.83	29.37	28.91	
13.5	12	31.76	31.55	31.33	30.97	30.53	
15.5	14	33.34	33.09	32.84	32.57	32.15	
16.5	16	34.13	33.86	33.59	33.37	32.96	

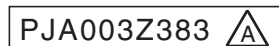

- Note(1) These data show average statuses.
 Depending on the system control, there may be ranges where the operation is not conducted continuously.
 These data show the case where the operation frequency of a compressor is fixed.
- (2) Capacities are based on the following conditions.
 Corresponding refrigerant piping length :7.5m
 Level difference of Zero.
- (3) Symbols are as follows.
 TC : Total cooling capacity (kW)
 SHC : Sensible heat capacity (kW)
 HC : Heating capacity (kW)

(3) Ceiling suspended type (FDEN)

(a) Single type

Model FDEN100VNVF1 Indoor unit FDEN100VF1 Outdoor unit FDC100VN
Cool Mode

(kW)

Heat Mode:HC

(kW)

Outdoor air temp.	Indoor air temperature															
	18 DB		21 DB		23 DB		26 DB		27 DB		28 DB		31 DB		33 DB	
	12 WB		14 WB		16 WB		18 WB		19 WB		20 WB		22 WB		24 WB	
DB	TC	SHC	TC	SHC	TC	SHC	TC	SHC	TC	SHC	TC	SHC	TC	SHC	TC	SHC
11					8.12	6.86	8.59	7.42	8.82	7.35	9.07	7.30	9.56	7.71	10.06	7.56
13					8.50	7.02	9.00	7.57	9.26	7.52	9.52	7.45	10.06	7.87	10.60	7.72
15					8.88	7.18	9.42	7.74	9.69	7.68	9.98	7.62	10.56	8.03	11.14	7.88
17					9.26	7.34	9.84	7.90	10.12	7.84	10.43	7.78	11.05	8.19	11.67	8.04
19					9.46	7.42	10.05	7.98	10.34	7.92	10.65	7.86	11.29	8.27	11.92	8.12
21					9.65	7.51	10.25	8.06	10.56	8.01	10.88	7.95	11.52	8.35	12.16	8.19
23					9.65	7.51	10.28	8.08	10.59	8.02	10.91	7.96	11.56	8.37	12.21	8.21
25			8.93	7.63	9.64	7.50	10.31	8.09	10.62	8.03	10.95	7.97	11.61	8.38	12.27	8.23
27			8.86	7.59	9.64	7.50	10.34	8.10	10.65	8.04	10.96	7.98	11.57	8.37		
29			8.80	7.57	9.50	7.44	10.17	8.03	10.49	7.98	10.81	7.92	11.45	8.33		
31			8.73	7.53	9.35	7.38	9.99	7.96	10.32	7.91	10.66	7.87	11.32	8.28		
33	8.22	7.04	8.58	7.47	9.21	7.32	9.82	7.89	10.16	7.85	10.51	7.81	11.19	8.24		
35	8.05	6.96	8.44	7.40	9.06	7.25	9.64	7.82	10.00	7.79	10.36	7.76	11.07	8.20		
37	7.92	6.90	8.30	7.34	8.91	7.19	9.46	7.75	9.79	7.71	10.13	7.67	10.80	8.11		
39	7.78	6.83	8.16	7.28	8.75	7.12	9.28	7.68	9.59	7.64	9.90	7.59	10.53	8.02		
41	7.64	6.76	8.02	7.21	8.60	7.06	9.09	7.61	9.38	7.56	9.68	7.51	10.26	7.93		
43	7.50	6.69	7.88	7.15	8.45	7.00	8.91	7.54	9.18	7.49	9.45	7.43	9.99	7.84		

Outdoor air temp.		Indoor air temperature					
DB	WB	DB					
		16	18	20	22	24	
-19.8	-20	5.64	5.62	5.60	5.58	5.56	
-17.7	-18	5.97	5.95	5.92	5.90	5.87	
-15.7	-16	6.30	6.27	6.25	6.22	6.19	
-13.5	-14	6.66	6.63	6.60	6.57	6.54	
-11.5	-12	7.03	6.99	6.96	6.93	6.90	
-9.5	-10	7.39	7.36	7.32	7.29	7.25	
-7.5	-8	7.75	7.72	7.68	7.64	7.60	
-5.5	-6	7.92	7.88	7.85	7.80	7.76	
-3.0	-4	8.10	8.05	8.01	7.97	7.92	
-1.0	-2	8.27	8.22	8.18	8.13	8.08	
1.0	0	8.44	8.39	8.34	8.29	8.24	
2.0	1	8.52	8.47	8.42	8.37	8.32	
3.0	2	9.08	9.03	8.98	8.94	8.90	
5.0	4	10.21	10.15	10.09	10.08	10.07	
7.0	6	11.33	11.27	11.20	11.22	11.23	
9.0	8	11.78	11.71	11.64	11.62	11.59	
11.5	10	12.23	12.16	12.09	12.02	11.94	
13.5	12	12.91	12.83	12.75	12.65	12.60	
15.5	14	13.59	13.50	13.42	13.29	13.26	
16.5	16	13.93	13.84	13.75	13.61	13.59	

PFA003Z924 

Model FDEN100VSVF1 Indoor unit FDEN100VF1 Outdoor unit FDC100VS
Cool Mode

(kW)

Heat Mode:HC

(kW)

Outdoor air temp.	Indoor air temperature															
	18 DB		21 DB		23 DB		26 DB		27 DB		28 DB		31 DB		33 DB	
	12 WB		14 WB		16 WB		18 WB		19 WB		20 WB		22 WB		24 WB	
DB	TC	SHC	TC	SHC	TC	SHC	TC	SHC	TC	SHC	TC	SHC	TC	SHC	TC	SHC
11					8.12	6.86	8.59	7.42	8.82	7.35	9.07	7.30	9.56	7.71	10.06	7.56
13					8.50	7.02	9.00	7.57	9.26	7.52	9.52	7.45	10.06	7.87	10.60	7.72
15					8.88	7.18	9.42	7.74	9.69	7.68	9.98	7.62	10.56	8.03	11.14	7.88
17					9.26	7.34	9.84	7.90	10.12	7.84	10.43	7.78	11.05	8.19	11.67	8.04
19					9.46	7.42	10.05	7.98	10.34	7.92	10.65	7.86	11.29	8.27	11.92	8.12
21					9.65	7.51	10.25	8.06	10.56	8.01	10.88	7.95	11.52	8.35	12.16	8.19
23					9.65	7.51	10.28	8.08	10.59	8.02	10.91	7.96	11.56	8.37	12.21	8.21
25			8.93	7.63	9.64	7.50	10.31	8.09	10.62	8.03	10.95	7.97	11.61	8.38	12.27	8.23
27			8.86	7.59	9.64	7.50	10.34	8.10	10.65	8.04	10.96	7.98	11.57	8.37		
29			8.80	7.57	9.50	7.44	10.17	8.03	10.49	7.98	10.81	7.92	11.45	8.33		
31			8.73	7.53	9.35	7.38	9.99	7.96	10.32	7.91	10.66	7.87	11.32	8.28		
33	8.22	7.04	8.58	7.47	9.21	7.32	9.82	7.89	10.16	7.85	10.51	7.81	11.19	8.24		
35	8.05	6.96	8.44	7.40	9.06	7.25	9.64	7.82	10.00	7.79	10.36	7.76	11.07	8.20		
37	7.92	6.90	8.30	7.34	8.91	7.19	9.46	7.75	9.79	7.71	10.13	7.67	10.80	8.11		
39	7.78	6.83	8.16	7.28	8.75	7.12	9.28	7.68	9.59	7.64	9.90	7.59	10.53	8.02		
41	7.64	6.76	8.02	7.21	8.60	7.06	9.09	7.61	9.38	7.56	9.68	7.51	10.26	7.93		
43	7.50	6.69	7.88	7.15	8.45	7.00	8.91	7.54	9.18	7.49	9.45	7.43	9.99	7.84		

Outdoor air temp.		Indoor air temperature					
DB	WB	DB					
		16	18	20	22	24	
-19.8	-20	5.64	5.62	5.60	5.58	5.56	
-17.7	-18	5.97	5.95	5.92	5.90	5.87	
-15.7	-16	6.30	6.27	6.25	6.22	6.19	
-13.5	-14	6.66	6.63	6.60	6.57	6.54	
-11.5	-12	7.03	6.99	6.96	6.93	6.90	
-9.5	-10	7.39	7.36	7.32	7.29	7.25	
-7.5	-8	7.75	7.72	7.68	7.64	7.60	
-5.5	-6	7.92	7.88	7.85	7.80	7.76	
-3.0	-4	8.10	8.05	8.01	7.97	7.92	
-1.0	-2	8.27	8.22	8.18	8.13	8.08	
1.0	0	8.44	8.39	8.34	8.29	8.24	
2.0	1	8.52	8.47	8.42	8.37	8.32	
3.0	2	9.08	9.03	8.98	8.94	8.90	
5.0	4	10.21	10.15	10.09	10.08	10.07	
7.0	6	11.33	11.27	11.20	11.22	11.23	
9.0	8	11.78	11.71	11.64	11.62	11.59	
11.5	10	12.23	12.16	12.09	12.02	11.94	
13.5	12	12.91	12.83	12.75	12.65	12.60	
15.5	14	13.59	13.50	13.42	13.29	13.26	
16.5	16	13.93	13.84	13.75	13.61	13.59	

Note(1) These data show average statuses.
Depending on the system control, there may be ranges where the operation is not conducted continuously.
These data show the case where the operation frequency of a compressor is fixed.

(2) Capacities are based on the following conditions.
Corresponding refrigerant piping length :7.5m
Level difference of Zero.

(3) Symbols are as follows.
TC : Total cooling capacity (kW)
SHC : Sensible heat capacity (kW)
HC : Heating capacity (kW)

PFA003Z924 

Model **FDEN125VNVF** Indoor unit **FDEN125VF** Outdoor unit **FDC125VN**

Cool Mode

(kW)

Heat Mode:HC

(kW)

Outdoor air temp.	Indoor air temperature															
	18 DB		21 DB		23 DB		26 DB		27 DB		28 DB		31 DB		33 DB	
	12 WB		14 WB		16 WB		18 WB		19 WB		20 WB		22 WB		24 WB	
DB	TC	SHC	TC	SHC	TC	SHC	TC	SHC	TC	SHC	TC	SHC	TC	SHC	TC	SHC
11					10.15	7.66	10.74	8.23	11.03	8.12	11.34	8.01	11.96	8.40	12.57	8.15
13					10.63	7.85	11.26	8.41	11.57	8.30	11.91	8.19	12.58	8.58	13.25	8.31
15					11.10	8.03	11.78	8.59	12.11	8.48	12.47	8.37	13.20	8.75	13.92	8.48
17					11.58	8.22	12.29	8.78	12.65	8.67	13.04	8.56	13.82	8.93	14.59	8.66
19					11.82	8.32	12.56	8.88	12.92	8.76	13.32	8.65	14.11	9.02	14.90	8.74
21					12.06	8.41	12.82	8.97	13.19	8.86	13.60	8.74	14.40	9.11	15.20	8.82
23					12.06	8.41	12.85	8.98	13.23	8.87	13.64	8.76	14.45	9.12	15.27	8.84
25			11.16	8.63	12.06	8.41	12.89	9.00	13.27	8.88	13.68	8.77	14.51	9.14	15.34	8.86
27			11.08	8.59	12.05	8.41	12.92	9.01	13.31	8.90	13.69	8.77	14.47	9.13		
29			11.00	8.56	11.87	8.34	12.71	8.93	13.11	8.83	13.51	8.71	14.31	9.08		
31			10.92	8.52	11.69	8.26	12.49	8.85	12.90	8.75	13.32	8.65	14.15	9.03		
33	10.27	8.02	10.72	8.43	11.51	8.19	12.27	8.77	12.70	8.68	13.13	8.59	13.99	8.98		
35	10.07	7.92	10.55	8.36	11.33	8.12	12.06	8.69	12.50	8.61	12.94	8.52	13.83	8.94		
37	9.90	7.84	10.38	8.29	11.13	8.04	11.83	8.61	12.24	8.53	12.66	8.43	13.50	8.84		
39	9.72	7.76	10.20	8.21	10.94	7.97	11.60	8.53	11.99	8.44	12.38	8.34	13.16	8.74		
41	9.55	7.68	10.02	8.13	10.75	7.89	11.37	8.45	11.73	8.35	12.09	8.25	12.82	8.64		
43	9.38	7.60	9.85	8.06	10.56	7.82	11.14	8.37	11.47	8.27	11.81	8.16	12.48	8.55		

Outdoor air temp.		Indoor air temperature					
DB	WB	16	18	20	22	24	
-19.8	-20	7.06	7.03	7.00	6.97	6.95	
-17.7	-18	7.46	7.43	7.41	7.37	7.34	
-15.7	-16	7.87	7.84	7.81	7.77	7.74	
-13.5	-14	8.33	8.29	8.26	8.22	8.18	
-11.5	-12	8.78	8.74	8.70	8.66	8.62	
-9.5	-10	9.24	9.19	9.15	9.11	9.06	
-7.5	-8	9.69	9.65	9.60	9.55	9.50	
-5.5	-6	9.91	9.86	9.81	9.75	9.70	
-3.0	-4	10.12	10.07	10.01	9.96	9.90	
-1.0	-2	10.33	10.28	10.22	10.16	10.10	
1.0	0	10.55	10.49	10.43	10.36	10.30	
2.0	1	10.65	10.59	10.53	10.47	10.40	
3.0	2	11.36	11.29	11.22	11.18	11.13	
5.0	4	12.76	12.69	12.61	12.60	12.58	
7.0	6	14.16	14.08	14.00	14.02	14.04	
9.0	8	14.72	14.64	14.56	14.52	14.49	
11.5	10	15.28	15.20	15.11	15.02	14.93	
13.5	12	16.13	16.04	15.94	15.82	15.75	
15.5	14	16.98	16.88	16.77	16.62	16.58	
16.5	16	17.41	17.30	17.19	17.02	16.99	

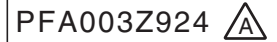

Model **FDEN125VSVF** Indoor unit **FDEN125VF** Outdoor unit **FDC125VS**

Cool Mode

(kW)

Heat Mode:HC

(kW)

Outdoor air temp.	Indoor air temperature															
	18 DB		21 DB		23 DB		26 DB		27 DB		28 DB		31 DB		33 DB	
	12 WB		14 WB		16 WB		18 WB		19 WB		20 WB		22 WB		24 WB	
DB	TC	SHC	TC	SHC	TC	SHC	TC	SHC	TC	SHC	TC	SHC	TC	SHC	TC	SHC
11					10.15	7.66	10.74	8.23	11.03	8.12	11.34	8.01	11.96	8.40	12.57	8.15
13					10.63	7.85	11.26	8.41	11.57	8.30	11.91	8.19	12.58	8.58	13.25	8.31
15					11.10	8.03	11.78	8.59	12.11	8.48	12.47	8.37	13.20	8.75	13.92	8.48
17					11.58	8.22	12.29	8.78	12.65	8.67	13.04	8.56	13.82	8.93	14.59	8.66
19					11.82	8.32	12.56	8.88	12.92	8.76	13.32	8.65	14.11	9.02	14.90	8.74
21					12.06	8.41	12.82	8.97	13.19	8.86	13.60	8.74	14.40	9.11	15.20	8.82
23					12.06	8.41	12.85	8.98	13.23	8.87	13.64	8.76	14.45	9.12	15.27	8.84
25			11.16	8.63	12.06	8.41	12.89	9.00	13.27	8.88	13.68	8.77	14.51	9.14	15.34	8.86
27			11.08	8.59	12.05	8.41	12.92	9.01	13.31	8.90	13.69	8.77	14.47	9.13		
29			11.00	8.56	11.87	8.34	12.71	8.93	13.11	8.83	13.51	8.71	14.31	9.08		
31			10.92	8.52	11.69	8.26	12.49	8.85	12.90	8.75	13.32	8.65	14.15	9.03		
33	10.27	8.02	10.72	8.43	11.51	8.19	12.27	8.77	12.70	8.68	13.13	8.59	13.99	8.98		
35	10.07	7.92	10.55	8.36	11.33	8.12	12.06	8.69	12.50	8.61	12.94	8.52	13.83	8.94		
37	9.90	7.84	10.38	8.29	11.13	8.04	11.83	8.61	12.24	8.53	12.66	8.43	13.50	8.84		
39	9.72	7.76	10.20	8.21	10.94	7.97	11.60	8.53	11.99	8.44	12.38	8.34	13.16	8.74		
41	9.55	7.68	10.02	8.13	10.75	7.89	11.37	8.45	11.73	8.35	12.09	8.25	12.82	8.64		
43	9.38	7.60	9.85	8.06	10.56	7.82	11.14	8.37	11.47	8.27	11.81	8.16	12.48	8.55		

Outdoor air temp.		Indoor air temperature					
DB	WB	16	18	20	22	24	
-19.8	-20	7.06	7.03	7.00	6.97	6.95	
-17.7	-18	7.46	7.43	7.41	7.37	7.34	
-15.7	-16	7.87	7.84	7.81	7.77	7.74	
-13.5	-14	8.33	8.29	8.26	8.22	8.18	
-11.5	-12	8.78	8.74	8.70	8.66	8.62	
-9.5	-10	9.24	9.19	9.15	9.11	9.06	
-7.5	-8	9.69	9.65	9.60	9.55	9.50	
-5.5	-6	9.91	9.86	9.81	9.75	9.70	
-3.0	-4	10.12	10.07	10.01	9.96	9.90	
-1.0	-2	10.33	10.28	10.22	10.16	10.10	
1.0	0	10.55	10.49	10.43	10.36	10.30	
2.0	1	10.65	10.59	10.53	10.47	10.40	
3.0	2	11.36	11.29	11.22	11.18	11.13	
5.0	4	12.76	12.69	12.61	12.60	12.58	
7.0	6	14.16	14.08	14.00	14.02	14.04	
9.0	8	14.72	14.64	14.56	14.52	14.49	
11.5	10	15.28	15.20	15.11	15.02	14.93	
13.5	12	16.13	16.04	15.94	15.82	15.75	
15.5	14	16.98	16.88	16.77	16.62	16.58	
16.5	16	17.41	17.30	17.19	17.02	16.99	

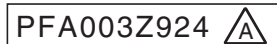

Note(1) These data show average statuses.
 Depending on the system control, there may be ranges where the operation is not conducted continuously.
 These data show the case where the operation frequency of a compressor is fixed.
 (2) Capacities are based on the following conditions.
 Corresponding refrigerant piping length :7.5m
 Level difference of Zero.
 (3) Symbols are as follows.
 TC : Total cooling capacity (kW)
 SHC : Sensible heat capacity (kW)
 HC : Heating capacity (kW)

Model FDEN140VNVF Indoor unit FDEN140VF Outdoor unit FDC140VN

Outdoor air temp.	Indoor air temperature														Heat Mode:HC (kW)									
	18 DB		21 DB		23 DB		26 DB		27 DB		28 DB		31 DB		33 DB		Outdoor air temp.		Indoor air temperature					
	12 WB		14 WB		16 WB		18 WB		19 WB		20 WB		22 WB		24 WB				DB					
DB	TC	SHC	TC	SHC	TC	SHC	TC	SHC	TC	SHC	TC	SHC	TC	SHC	TC	SHC	DB	WB	16	18	20	22	24	
11					11.37	8.30	12.02	8.87	12.35	8.76	12.70	8.66	13.39	9.04	14.08	8.78	-19.8	-20	8.06	8.03	8.00	7.97	7.94	
13					11.90	8.52	12.61	9.09	12.96	8.98	13.33	8.87	14.09	9.26	14.84	8.99	-17.7	-18	8.53	8.50	8.46	8.43	8.39	
15					12.43	8.74	13.19	9.31	13.57	9.20	13.97	9.09	14.78	9.47	15.59	9.20	-15.7	-16	9.00	8.96	8.92	8.88	8.85	
17					12.96	8.97	13.77	9.54	14.17	9.43	14.61	9.32	15.48	9.70	16.34	9.42	-13.5	-14	9.52	9.48	9.43	9.39	9.35	
19					13.24	9.09	14.06	9.65	14.48	9.55	14.92	9.44	15.80	9.80	16.68	9.52	-11.5	-12	10.04	9.99	9.95	9.90	9.85	
21					13.51	9.21	14.36	9.77	14.78	9.66	15.23	9.55	16.12	9.91	17.02	9.62	-9.5	-10	10.56	10.51	10.46	10.41	10.36	
23					13.51	9.21	14.40	9.79	14.82	9.68	15.28	9.57	16.19	9.93	17.10	9.64	-7.5	-8	11.08	11.02	10.97	10.91	10.86	
25			12.50	9.39	13.50	9.20	14.43	9.80	14.86	9.69	15.33	9.59	16.25	9.95	17.18	9.67	-5.5	-6	11.32	11.26	11.21	11.15	11.09	
27			12.41	9.35	13.50	9.20	14.47	9.82	14.91	9.71	15.34	9.59	16.20	9.94			-3.0	-4	11.56	11.50	11.44	11.38	11.31	
29			12.32	9.31	13.29	9.11	14.23	9.72	14.68	9.62	15.13	9.51	16.02	9.88			-1.0	-2	11.81	11.75	11.68	11.61	11.54	
31			12.23	9.27	13.09	9.03	13.99	9.63	14.45	9.53	14.92	9.44	15.85	9.82			1.0	0	12.05	11.99	11.92	11.84	11.77	
33	11.51	8.76	12.01	9.17	12.89	8.94	13.75	9.53	14.23	9.45	14.71	9.36	15.67	9.76			2.0	1	12.18	12.11	12.04	11.96	11.89	
35	11.28	8.64	11.82	9.08	12.68	8.85	13.50	9.43	14.00	9.36	14.50	9.28	15.49	9.70			3.0	2	12.98	12.90	12.83	12.77	12.72	
37	11.08	8.54	11.62	8.99	12.47	8.76	13.25	9.33	13.71	9.26	14.18	9.17	15.12	9.58			5.0	4	14.58	14.50	14.41	14.40	14.38	
39	10.89	8.45	11.43	8.90	12.26	8.67	12.99	9.23	13.43	9.15	13.86	9.06	14.74	9.46			7.0	6	16.19	16.09	16.00	16.02	16.05	
41	10.70	8.36	11.23	8.81	12.04	8.58	12.73	9.13	13.14	9.05	13.55	8.95	14.36	9.34			9.0	8	16.83	16.73	16.63	16.59	16.55	
43	10.51	8.27	11.03	8.72	11.83	8.49	12.47	9.04	12.85	8.94	13.23	8.84	13.98	9.22			11.5	10	17.46	17.37	17.27	17.17	17.06	
																	13.5	12	18.44	18.33	18.22	18.08	18.00	
																	15.5	14	19.41	19.29	19.17	18.99	18.95	
																	16.5	16	19.90	19.77	19.64	19.45	19.42	

PFA003Z924

Model FDEN140VSVF Indoor unit FDEN140VF Outdoor unit FDC140VS

Outdoor air temp.	Indoor air temperature														Heat Mode:HC (kW)									
	18 DB		21 DB		23 DB		26 DB		27 DB		28 DB		31 DB		33 DB		Outdoor air temp.		Indoor air temperature					
	12 WB		14 WB		16 WB		18 WB		19 WB		20 WB		22 WB		24 WB				DB					
DB	TC	SHC	TC	SHC	TC	SHC	TC	SHC	TC	SHC	TC	SHC	TC	SHC	TC	SHC	DB	WB	16	18	20	22	24	
11					11.37	8.30	12.02	8.87	12.35	8.76	12.70	8.66	13.39	9.04	14.08	8.78	-19.8	-20	8.06	8.03	8.00	7.97	7.94	
13					11.90	8.52	12.61	9.09	12.96	8.98	13.33	8.87	14.09	9.26	14.84	8.99	-17.7	-18	8.53	8.50	8.46	8.43	8.39	
15					12.43	8.74	13.19	9.31	13.57	9.20	13.97	9.09	14.78	9.47	15.59	9.20	-15.7	-16	9.00	8.96	8.92	8.88	8.85	
17					12.96	8.97	13.77	9.54	14.17	9.43	14.61	9.32	15.48	9.70	16.34	9.42	-13.5	-14	9.52	9.48	9.43	9.39	9.35	
19					13.24	9.09	14.06	9.65	14.48	9.55	14.92	9.44	15.80	9.80	16.68	9.52	-11.5	-12	10.04	9.99	9.95	9.90	9.85	
21					13.51	9.21	14.36	9.77	14.78	9.66	15.23	9.55	16.12	9.91	17.02	9.62	-9.5	-10	10.56	10.51	10.46	10.41	10.36	
23					13.51	9.21	14.40	9.79	14.82	9.68	15.28	9.57	16.19	9.93	17.10	9.64	-7.5	-8	11.08	11.02	10.97	10.91	10.86	
25			12.50	9.39	13.50	9.20	14.43	9.80	14.86	9.69	15.33	9.59	16.25	9.95	17.18	9.67	-5.5	-6	11.32	11.26	11.21	11.15	11.09	
27			12.41	9.35	13.50	9.20	14.47	9.82	14.91	9.71	15.34	9.59	16.20	9.94			-3.0	-4	11.56	11.50	11.44	11.38	11.31	
29			12.32	9.31	13.29	9.11	14.23	9.72	14.68	9.62	15.13	9.51	16.02	9.88			-1.0	-2	11.81	11.75	11.68	11.61	11.54	
31			12.23	9.27	13.09	9.03	13.99	9.63	14.45	9.53	14.92	9.44	15.85	9.82			1.0	0	12.05	11.99	11.92	11.84	11.77	
33	11.51	8.76	12.01	9.17	12.89	8.94	13.75	9.53	14.23	9.45	14.71	9.36	15.67	9.76			2.0	1	12.18	12.11	12.04	11.96	11.89	
35	11.28	8.64	11.82	9.08	12.68	8.85	13.50	9.43	14.00	9.36	14.50	9.28	15.49	9.70			3.0	2	12.98	12.90	12.83	12.77	12.72	
37	11.08	8.54	11.62	8.99	12.47	8.76	13.25	9.33	13.71	9.26	14.18	9.17	15.12	9.58			5.0	4	14.58	14.50	14.41	14.40	14.38	
39	10.89	8.45	11.43	8.90	12.26	8.67	12.99	9.23	13.43	9.15	13.86	9.06	14.74	9.46			7.0	6	16.19	16.09	16.00	16.02	16.05	
41	10.70	8.36	11.23	8.81	12.04	8.58	12.73	9.13	13.14	9.05	13.55	8.95	14.36	9.34			9.0	8	16.83	16.73	16.63	16.59	16.55	
43	10.51	8.27	11.03	8.72	11.83	8.49	12.47	9.04	12.85	8.94	13.23	8.84	13.98	9.22			11.5	10	17.46	17.37	17.27	17.17	17.06	
																	13.5	12	18.44	18.33	18.22	18.08	18.00	
																	15.5	14	19.41	19.29	19.17	18.99	18.95	
																	16.5	16	19.90	19.77	19.64	19.45	19.42	

Note(1) These data show average statuses.
 Depending on the system control, there may be ranges where the operation is not conducted continuously.
 These data show the case where the operation frequency of a compressor is fixed.

(2) Capacities are based on the following conditions.
 Corresponding refrigerant piping length :7.5m
 Level difference of Zero.

(3) Symbols are as follows.
 TC : Total cooling capacity (kW)
 SHC : Sensible heat capacity (kW)
 HC : Heating capacity (kW)

PFA003Z924

(b) Twin type

Model **FDEN100VNPVF** Indoor unit **FDEN50VF (2 units)** Outdoor unit **FDC100VN**
Cool Mode

(kW) Heat Mode:HC (kW)

Outdoor air temp.	Indoor air temperature																Outdoor air temp.		Indoor air temperature				
	18 DB		21 DB		23 DB		26 DB		27 DB		28 DB		31 DB		33 DB		DB	WB	DB				
	12 WB		14 WB		16 WB		18 WB		19 WB		20 WB		22 WB		24 WB				16	18	20	22	24
DB	TC	SHC	TC	SHC	TC	SHC	TC	SHC	TC	SHC	TC	SHC	TC	SHC	TC	SHC	TC	SHC	TC	SHC	TC	SHC	
					8.12	6.22	8.59	6.66	8.82	6.60	9.07	6.55	9.56	6.86	10.06	6.74	-19.8	-20	5.64	5.62	5.60	5.58	5.56
11																	-17.7	-18	5.97	5.95	5.92	5.90	5.87
13					8.50	6.40	9.00	6.83	9.26	6.78	9.52	6.73	10.06	7.04	10.60	6.91	-15.7	-16	6.30	6.27	6.25	6.22	6.19
15					8.88	6.57	9.42	7.01	9.69	6.96	9.98	6.91	10.56	7.23	11.14	7.09	-13.5	-14	6.66	6.63	6.60	6.57	6.54
17					9.26	6.75	9.84	7.19	10.12	7.14	10.43	7.09	11.05	7.41	11.67	7.27	-11.5	-12	7.03	6.99	6.96	6.93	6.90
19					9.46	6.84	10.05	7.28	10.34	7.23	10.65	7.18	11.29	7.50	11.92	7.36	-9.5	-10	7.39	7.36	7.32	7.29	7.25
21					9.65	6.93	10.25	7.37	10.56	7.32	10.88	7.28	11.52	7.58	12.16	7.44	-7.5	-8	7.75	7.72	7.68	7.64	7.60
23					9.65	6.93	10.28	7.38	10.59	7.34	10.91	7.29	11.56	7.60	12.21	7.46	-5.5	-6	7.92	7.88	7.85	7.80	7.76
25			8.93	7.00	9.64	6.93	10.31	7.40	10.62	7.35	10.95	7.30	11.61	7.62	12.27	7.48	-3.0	-4	8.10	8.05	8.01	7.97	7.92
27			8.86	6.97	9.64	6.93	10.34	7.41	10.65	7.36	10.96	7.31	11.57	7.60			-1.0	-2	8.27	8.22	8.18	8.13	8.08
29			8.80	6.94	9.50	6.86	10.17	7.34	10.49	7.29	10.81	7.25	11.45	7.56			1.0	0	8.44	8.39	8.34	8.29	8.24
31			8.73	6.90	9.35	6.79	9.99	7.26	10.32	7.22	10.66	7.19	11.32	7.51			2.0	1	8.52	8.47	8.42	8.37	8.32
33	8.22	6.51	8.58	6.83	9.21	6.72	9.82	7.18	10.16	7.15	10.51	7.12	11.19	7.46			3.0	2	9.08	9.03	8.98	8.94	8.90
35	8.05	6.42	8.44	6.76	9.06	6.65	9.64	7.10	10.00	7.09	10.36	7.06	11.07	7.41			5.0	4	10.21	10.15	10.09	10.08	10.07
37	7.92	6.35	8.30	6.69	8.91	6.58	9.46	7.03	9.79	7.00	10.13	6.97	10.80	7.31			7.0	6	11.33	11.27	11.20	11.22	11.23
39	7.78	6.28	8.16	6.62	8.75	6.51	9.28	6.95	9.59	6.92	9.90	6.88	10.53	7.21			9.0	8	11.78	11.71	11.64	11.62	11.59
41	7.64	6.20	8.02	6.55	8.60	6.44	9.09	6.87	9.38	6.83	9.68	6.79	10.26	7.12			11.5	10	12.23	12.16	12.09	12.02	11.94
43	7.50	6.13	7.88	6.48	8.45	6.37	8.91	6.79	9.18	6.75	9.45	6.70	9.99	7.02			13.5	12	12.91	12.83	12.75	12.65	12.60
																	15.5	14	13.59	13.50	13.42	13.29	13.26
																	16.5	16	13.93	13.84	13.75	13.61	13.59

PFA003Z924 

Model **FDEN100VSPVF** Indoor unit **FDEN50VF (2 units)** Outdoor unit **FDC100VS**
Cool Mode

(kW) Heat Mode:HC (kW)

Outdoor air temp.	Indoor air temperature																Outdoor air temp.		Indoor air temperature				
	18 DB		21 DB		23 DB		26 DB		27 DB		28 DB		31 DB		33 DB		DB	WB	DB				
	12 WB		14 WB		16 WB		18 WB		19 WB		20 WB		22 WB		24 WB				16	18	20	22	24
DB	TC	SHC	TC	SHC	TC	SHC	TC	SHC	TC	SHC	TC	SHC	TC	SHC	TC	SHC	TC	SHC	TC	SHC	TC	SHC	
					8.12	6.22	8.59	6.66	8.82	6.60	9.07	6.55	9.56	6.86	10.06	6.74	-19.8	-20	5.64	5.62	5.60	5.58	5.56
11																	-17.7	-18	5.97	5.95	5.92	5.90	5.87
13					8.50	6.40	9.00	6.83	9.26	6.78	9.52	6.73	10.06	7.04	10.60	6.91	-15.7	-16	6.30	6.27	6.25	6.22	6.19
15					8.88	6.57	9.42	7.01	9.69	6.96	9.98	6.91	10.56	7.23	11.14	7.09	-13.5	-14	6.66	6.63	6.60	6.57	6.54
17					9.26	6.75	9.84	7.19	10.12	7.14	10.43	7.09	11.05	7.41	11.67	7.27	-11.5	-12	7.03	6.99	6.96	6.93	6.90
19					9.46	6.84	10.05	7.28	10.34	7.23	10.65	7.18	11.29	7.50	11.92	7.36	-9.5	-10	7.39	7.36	7.32	7.29	7.25
21					9.65	6.93	10.25	7.37	10.56	7.32	10.88	7.28	11.52	7.58	12.16	7.44	-7.5	-8	7.75	7.72	7.68	7.64	7.60
23					9.65	6.93	10.28	7.38	10.59	7.34	10.91	7.29	11.56	7.60	12.21	7.46	-5.5	-6	7.92	7.88	7.85	7.80	7.76
25			8.93	7.00	9.64	6.93	10.31	7.40	10.62	7.35	10.95	7.30	11.61	7.62	12.27	7.48	-3.0	-4	8.10	8.05	8.01	7.97	7.92
27			8.86	6.97	9.64	6.93	10.34	7.41	10.65	7.36	10.96	7.31	11.57	7.60			-1.0	-2	8.27	8.22	8.18	8.13	8.08
29			8.80	6.94	9.50	6.86	10.17	7.34	10.49	7.29	10.81	7.25	11.45	7.56			1.0	0	8.44	8.39	8.34	8.29	8.24
31			8.73	6.90	9.35	6.79	9.99	7.26	10.32	7.22	10.66	7.19	11.32	7.51			2.0	1	8.52	8.47	8.42	8.37	8.32
33	8.22	6.51	8.58	6.83	9.21	6.72	9.82	7.18	10.16	7.15	10.51	7.12	11.19	7.46			3.0	2	9.08	9.03	8.98	8.94	8.90
35	8.05	6.42	8.44	6.76	9.06	6.65	9.64	7.10	10.00	7.09	10.36	7.06	11.07	7.41			5.0	4	10.21	10.15	10.09	10.08	10.07
37	7.92	6.35	8.30	6.69	8.91	6.58	9.46	7.03	9.79	7.00	10.13	6.97	10.80	7.31			7.0	6	11.33	11.27	11.20	11.22	11.23
39	7.78	6.28	8.16	6.62	8.75	6.51	9.28	6.95	9.59	6.92	9.90	6.88	10.53	7.21			9.0	8	11.78	11.71	11.64	11.62	11.59
41	7.64	6.20	8.02	6.55	8.60	6.44	9.09	6.87	9.38	6.83	9.68	6.79	10.26	7.12			11.5	10	12.23	12.16	12.09	12.02	11.94
43	7.50	6.13	7.88	6.48	8.45	6.37	8.91	6.79	9.18	6.75	9.45	6.70	9.99	7.02			13.5	12	12.91	12.83	12.75	12.65	12.60
																	15.5	14	13.59	13.50	13.42	13.29	13.26
																	16.5	16	13.93	13.84	13.75	13.61	13.59

Note(1) These data show average statuses.
Depending on the system control, there may be ranges where the operation is not conducted continuously.
These data show the case where the operation frequency of a compressor is fixed.

(2) Capacities are based on the following conditions.
Corresponding refrigerant piping length : 7.5m
Level difference of Zero.

(3) Symbols are as follows.
TC : Total cooling capacity (kW)
SHC : Sensible heat capacity (kW)
HC : Heating capacity (kW)

PFA003Z924 

Model **FDEN125VNPVF** Indoor unit FDEN60VF (2 units) Outdoor unit FDC125VN
Cool Mode

(kW) Heat Mode:HC (kW)

Outdoor air temp.	Indoor air temperature															
	18 DB		21 DB		23 DB		26 DB		27 DB		28 DB		31 DB		33 DB	
	12 WB		14 WB		16 WB		18 WB		19 WB		20 WB		22 WB		24 WB	
DB	TC	SHC	TC	SHC	TC	SHC	TC	SHC	TC	SHC	TC	SHC	TC	SHC	TC	SHC
11					10.15	8.18	10.74	8.84	11.03	8.73	11.34	8.62	11.96	9.09	12.57	8.83
13					10.63	8.35	11.26	9.01	11.57	8.90	11.91	8.79	12.58	9.26	13.25	9.00
15					11.10	8.53	11.78	9.19	12.11	9.08	12.47	8.97	13.20	9.43	13.92	9.16
17					11.58	8.71	12.29	9.36	12.65	9.25	13.04	9.14	13.82	9.60	14.59	9.32
19					11.82	8.81	12.56	9.46	12.92	9.34	13.32	9.23	14.11	9.68	14.90	9.40
21					12.06	8.90	12.82	9.55	13.19	9.43	13.60	9.32	14.40	9.76	15.20	9.48
23					12.06	8.90	12.85	9.56	13.23	9.45	13.64	9.34	14.45	9.78	15.27	9.50
25			11.16	9.13	12.06	8.90	12.89	9.58	13.27	9.46	13.68	9.35	14.51	9.80	15.34	9.51
27			11.08	9.10	12.05	8.90	12.92	9.59	13.31	9.47	13.69	9.35	14.47	9.78		
29			11.00	9.06	11.87	8.83	12.71	9.51	13.11	9.41	13.51	9.29	14.31	9.74		
31			10.92	9.03	11.69	8.76	12.49	9.43	12.90	9.34	13.32	9.23	14.15	9.69		
33	10.27	8.45	10.72	8.95	11.51	8.69	12.27	9.36	12.70	9.27	13.13	9.17	13.99	9.65		
35	10.07	8.36	10.55	8.88	11.33	8.62	12.06	9.28	12.50	9.20	12.94	9.11	13.83	9.60		
37	9.90	8.29	10.38	8.81	11.13	8.54	11.83	9.20	12.24	9.12	12.66	9.03	13.50	9.51		
39	9.72	8.20	10.20	8.73	10.94	8.47	11.60	9.13	11.99	9.04	12.38	8.94	13.16	9.41		
41	9.55	8.13	10.02	8.66	10.75	8.40	11.37	9.05	11.73	8.95	12.09	8.85	12.82	9.32		
43	9.38	8.05	9.85	8.59	10.56	8.33	11.14	8.97	11.47	8.87	11.81	8.76	12.48	9.23		

Outdoor air temp.		Indoor air temperature					
DB	WB	16	18	20	22	24	
-19.8	-20	7.06	7.03	7.00	6.97	6.95	
-17.7	-18	7.46	7.43	7.41	7.37	7.34	
-15.7	-16	7.87	7.84	7.81	7.77	7.74	
-13.5	-14	8.33	8.29	8.26	8.22	8.18	
-11.5	-12	8.78	8.74	8.70	8.66	8.62	
-9.5	-10	9.24	9.19	9.15	9.11	9.06	
-7.5	-8	9.69	9.65	9.60	9.55	9.50	
-5.5	-6	9.91	9.86	9.81	9.75	9.70	
-3.0	-4	10.12	10.07	10.01	9.96	9.90	
-1.0	-2	10.33	10.28	10.22	10.16	10.10	
1.0	0	10.55	10.49	10.43	10.36	10.30	
2.0	1	10.65	10.59	10.53	10.47	10.40	
3.0	2	11.36	11.29	11.22	11.18	11.13	
5.0	4	12.76	12.69	12.61	12.60	12.58	
7.0	6	14.16	14.08	14.00	14.02	14.04	
9.0	8	14.72	14.64	14.56	14.52	14.49	
11.5	10	15.28	15.20	15.11	15.02	14.93	
13.5	12	16.13	16.04	15.94	15.82	15.75	
15.5	14	16.98	16.88	16.77	16.62	16.58	
16.5	16	17.41	17.30	17.19	17.02	16.99	

PFA003Z924

Model **FDEN125VSPVF** Indoor unit FDEN60VF (2 units) Outdoor unit FDC125VS
Cool Mode

(kW) Heat Mode:HC (kW)

Outdoor air temp.	Indoor air temperature															
	18 DB		21 DB		23 DB		26 DB		27 DB		28 DB		31 DB		33 DB	
	12 WB		14 WB		16 WB		18 WB		19 WB		20 WB		22 WB		24 WB	
DB	TC	SHC	TC	SHC	TC	SHC	TC	SHC	TC	SHC	TC	SHC	TC	SHC	TC	SHC
11					10.15	8.18	10.74	8.84	11.03	8.73	11.34	8.62	11.96	9.09	12.57	8.83
13					10.63	8.35	11.26	9.01	11.57	8.90	11.91	8.79	12.58	9.26	13.25	9.00
15					11.10	8.53	11.78	9.19	12.11	9.08	12.47	8.97	13.20	9.43	13.92	9.16
17					11.58	8.71	12.29	9.36	12.65	9.25	13.04	9.14	13.82	9.60	14.59	9.32
19					11.82	8.81	12.56	9.46	12.92	9.34	13.32	9.23	14.11	9.68	14.90	9.40
21					12.06	8.90	12.82	9.55	13.19	9.43	13.60	9.32	14.40	9.76	15.20	9.48
23					12.06	8.90	12.85	9.56	13.23	9.45	13.64	9.34	14.45	9.78	15.27	9.50
25			11.16	9.13	12.06	8.90	12.89	9.58	13.27	9.46	13.68	9.35	14.51	9.80	15.34	9.51
27			11.08	9.10	12.05	8.90	12.92	9.59	13.31	9.47	13.69	9.35	14.47	9.78		
29			11.00	9.06	11.87	8.83	12.71	9.51	13.11	9.41	13.51	9.29	14.31	9.74		
31			10.92	9.03	11.69	8.76	12.49	9.43	12.90	9.34	13.32	9.23	14.15	9.69		
33	10.27	8.45	10.72	8.95	11.51	8.69	12.27	9.36	12.70	9.27	13.13	9.17	13.99	9.65		
35	10.07	8.36	10.55	8.88	11.33	8.62	12.06	9.28	12.50	9.20	12.94	9.11	13.83	9.60		
37	9.90	8.29	10.38	8.81	11.13	8.54	11.83	9.20	12.24	9.12	12.66	9.03	13.50	9.51		
39	9.72	8.20	10.20	8.73	10.94	8.47	11.60	9.13	11.99	9.04	12.38	8.94	13.16	9.41		
41	9.55	8.13	10.02	8.66	10.75	8.40	11.37	9.05	11.73	8.95	12.09	8.85	12.82	9.32		
43	9.38	8.05	9.85	8.59	10.56	8.33	11.14	8.97	11.47	8.87	11.81	8.76	12.48	9.23		

Outdoor air temp.		Indoor air temperature					
DB	WB	16	18	20	22	24	
-19.8	-20	7.06	7.03	7.00	6.97	6.95	
-17.7	-18	7.46	7.43	7.41	7.37	7.34	
-15.7	-16	7.87	7.84	7.81	7.77	7.74	
-13.5	-14	8.33	8.29	8.26	8.22	8.18	
-11.5	-12	8.78	8.74	8.70	8.66	8.62	
-9.5	-10	9.24	9.19	9.15	9.11	9.06	
-7.5	-8	9.69	9.65	9.60	9.55	9.50	
-5.5	-6	9.91	9.86	9.81	9.75	9.70	
-3.0	-4	10.12	10.07	10.01	9.96	9.90	
-1.0	-2	10.33	10.28	10.22	10.16	10.10	
1.0	0	10.55	10.49	10.43	10.36	10.30	
2.0	1	10.65	10.59	10.53	10.47	10.40	
3.0	2	11.36	11.29	11.22	11.18	11.13	
5.0	4	12.76	12.69	12.61	12.60	12.58	
7.0	6	14.16	14.08	14.00	14.02	14.04	
9.0	8	14.72	14.64	14.56	14.52	14.49	
11.5	10	15.28	15.20	15.11	15.02	14.93	
13.5	12	16.13	16.04	15.94	15.82	15.75	
15.5	14	16.98	16.88	16.77	16.62	16.58	
16.5	16	17.41	17.30	17.19	17.02	16.99	

PFA003Z924

- Note(1) These data show average statuses.
Depending on the system control, there may be ranges where the operation is not conducted continuously.
These data show the case where the operation frequency of a compressor is fixed.
- (2) Capacities are based on the following conditions.
Corresponding refrigerant piping length :7.5m
Level difference of Zero.
- (3) Symbols are as follows.
TC : Total cooling capacity (kW)
SHC : Sensible heat capacity (kW)
HC : Heating capacity (kW)

Model **FDEN140VNPVF1** Indoor unit FDEN71VF1 (2 units) Outdoor unit FDC140VN
Cool Mode (kW) Heat Mode:HC (kW)

Outdoor air temp.	Indoor air temperature															
	18 DB		21 DB		23 DB		26 DB		27 DB		28 DB		31 DB		33 DB	
	12 WB	14 WB	16 WB	18 WB	19 WB	20 WB	22 WB	24 WB	TC	SHC	TC	SHC	TC	SHC	TC	SHC
DB	TC	SHC	TC	SHC	TC	SHC	TC	SHC	TC	SHC	TC	SHC	TC	SHC	TC	SHC
11					11.37	9.49	12.02	10.26	12.35	10.16	12.70	10.07	13.39	10.63	14.08	10.40
13					11.90	9.70	12.61	10.47	12.96	10.38	13.33	10.28	14.09	10.84	14.84	10.60
15					12.43	9.91	13.19	10.69	13.57	10.59	13.97	10.49	14.78	11.05	15.59	10.81
17					12.96	10.13	13.77	10.91	14.17	10.81	14.61	10.71	15.48	11.27	16.34	11.02
19					13.24	10.24	14.06	11.02	14.48	10.92	14.92	10.82	15.80	11.37	16.68	11.12
21					13.51	10.36	14.36	11.13	14.78	11.03	15.23	10.93	16.12	11.47	17.02	11.22
23					13.51	10.36	14.40	11.15	14.82	11.04	15.28	10.95	16.19	11.50	17.10	11.24
25			12.50	10.56	13.50	10.35	14.43	11.16	14.86	11.06	15.33	10.96	16.25	11.52	17.18	11.26
27			12.41	10.52	13.50	10.35	14.47	11.17	14.91	11.08	15.34	10.97	16.20	11.50		
29			12.32	10.48	13.29	10.27	14.23	11.08	14.68	10.99	15.13	10.89	16.02	11.44		
31			12.23	10.44	13.09	10.18	13.99	10.99	14.45	10.91	14.92	10.82	15.85	11.39		
33	11.51	9.76	12.01	10.34	12.89	10.10	13.75	10.90	14.23	10.83	14.71	10.75	15.67	11.33		
35	11.28	9.65	11.82	10.26	12.68	10.02	13.50	10.80	14.00	10.75	14.50	10.68	15.49	11.28		
37	11.08	9.56	11.62	10.17	12.47	9.93	13.25	10.71	13.71	10.64	14.18	10.57	15.12	11.16		
39	10.89	9.47	11.43	10.09	12.26	9.84	12.99	10.61	13.43	10.54	13.86	10.46	14.74	11.04		
41	10.70	9.38	11.23	10.00	12.04	9.76	12.73	10.52	13.14	10.44	13.55	10.35	14.36	10.93		
43	10.51	9.29	11.03	9.92	11.83	9.67	12.47	10.42	12.85	10.34	13.23	10.24	13.98	10.81		

Outdoor air temp.		Indoor air temperature					
DB	WB	DB					
		16	18	20	22	24	
-19.8	-20	8.06	8.03	8.00	7.97	7.94	
-17.7	-18	8.53	8.50	8.46	8.43	8.39	
-15.7	-16	9.00	8.96	8.92	8.88	8.85	
-13.5	-14	9.52	9.48	9.43	9.39	9.35	
-11.5	-12	10.04	9.99	9.95	9.90	9.85	
-9.5	-10	10.56	10.51	10.46	10.41	10.36	
-7.5	-8	11.08	11.02	10.97	10.91	10.86	
-5.5	-6	11.32	11.26	11.21	11.15	11.09	
-3.0	-4	11.56	11.50	11.44	11.38	11.31	
-1.0	-2	11.81	11.75	11.68	11.61	11.54	
1.0	0	12.05	11.99	11.92	11.84	11.77	
2.0	1	12.18	12.11	12.04	11.96	11.89	
3.0	2	12.98	12.90	12.83	12.77	12.72	
5.0	4	14.58	14.50	14.41	14.40	14.38	
7.0	6	16.19	16.09	16.00	16.02	16.05	
9.0	8	16.83	16.73	16.63	16.59	16.55	
11.5	10	17.46	17.37	17.27	17.17	17.06	
13.5	12	18.44	18.33	18.22	18.08	18.00	
15.5	14	19.41	19.29	19.17	18.99	18.95	
16.5	16	19.90	19.77	19.64	19.45	19.42	

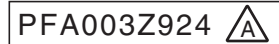

Model **FDEN140VSPVF1** Indoor unit FDEN71VF1 (2 units) Outdoor unit FDC140VS
Cool Mode (kW) Heat Mode:HC (kW)

Outdoor air temp.	Indoor air temperature															
	18 DB		21 DB		23 DB		26 DB		27 DB		28 DB		31 DB		33 DB	
	12 WB	14 WB	16 WB	18 WB	19 WB	20 WB	22 WB	24 WB	TC	SHC	TC	SHC	TC	SHC	TC	SHC
DB	TC	SHC	TC	SHC	TC	SHC	TC	SHC	TC	SHC	TC	SHC	TC	SHC	TC	SHC
11					11.37	9.49	12.02	10.26	12.35	10.16	12.70	10.07	13.39	10.63	14.08	10.40
13					11.90	9.70	12.61	10.47	12.96	10.38	13.33	10.28	14.09	10.84	14.84	10.60
15					12.43	9.91	13.19	10.69	13.57	10.59	13.97	10.49	14.78	11.05	15.59	10.81
17					12.96	10.13	13.77	10.91	14.17	10.81	14.61	10.71	15.48	11.27	16.34	11.02
19					13.24	10.24	14.06	11.02	14.48	10.92	14.92	10.82	15.80	11.37	16.68	11.12
21					13.51	10.36	14.36	11.13	14.78	11.03	15.23	10.93	16.12	11.47	17.02	11.22
23					13.51	10.36	14.40	11.15	14.82	11.04	15.28	10.95	16.19	11.50	17.10	11.24
25			12.50	10.56	13.50	10.35	14.43	11.16	14.86	11.06	15.33	10.96	16.25	11.52	17.18	11.26
27			12.41	10.52	13.50	10.35	14.47	11.17	14.91	11.08	15.34	10.97	16.20	11.50		
29			12.32	10.48	13.29	10.27	14.23	11.08	14.68	10.99	15.13	10.89	16.02	11.44		
31			12.23	10.44	13.09	10.18	13.99	10.99	14.45	10.91	14.92	10.82	15.85	11.39		
33	11.51	9.76	12.01	10.34	12.89	10.10	13.75	10.90	14.23	10.83	14.71	10.75	15.67	11.33		
35	11.28	9.65	11.82	10.26	12.68	10.02	13.50	10.80	14.00	10.75	14.50	10.68	15.49	11.28		
37	11.08	9.56	11.62	10.17	12.47	9.93	13.25	10.71	13.71	10.64	14.18	10.57	15.12	11.16		
39	10.89	9.47	11.43	10.09	12.26	9.84	12.99	10.61	13.43	10.54	13.86	10.46	14.74	11.04		
41	10.70	9.38	11.23	10.00	12.04	9.76	12.73	10.52	13.14	10.44	13.55	10.35	14.36	10.93		
43	10.51	9.29	11.03	9.92	11.83	9.67	12.47	10.42	12.85	10.34	13.23	10.24	13.98	10.81		

Outdoor air temp.		Indoor air temperature					
DB	WB	DB					
		16	18	20	22	24	
-19.8	-20	8.06	8.03	8.00	7.97	7.94	
-17.7	-18	8.53	8.50	8.46	8.43	8.39	
-15.7	-16	9.00	8.96	8.92	8.88	8.85	
-13.5	-14	9.52	9.48	9.43	9.39	9.35	
-11.5	-12	10.04	9.99	9.95	9.90	9.85	
-9.5	-10	10.56	10.51	10.46	10.41	10.36	
-7.5	-8	11.08	11.02	10.97	10.91	10.86	
-5.5	-6	11.32	11.26	11.21	11.15	11.09	
-3.0	-4	11.56	11.50	11.44	11.38	11.31	
-1.0	-2	11.81	11.75	11.68	11.61	11.54	
1.0	0	12.05	11.99	11.92	11.84	11.77	
2.0	1	12.18	12.11	12.04	11.96	11.89	
3.0	2	12.98	12.90	12.83	12.77	12.72	
5.0	4	14.58	14.50	14.41	14.40	14.38	
7.0	6	16.19	16.09	16.00	16.02	16.05	
9.0	8	16.83	16.73	16.63	16.59	16.55	
11.5	10	17.46	17.37	17.27	17.17	17.06	
13.5	12	18.44	18.33	18.22	18.08	18.00	
15.5	14	19.41	19.29	19.17	18.99	18.95	
16.5	16	19.90	19.77	19.64	19.45	19.42	

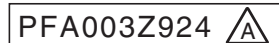

Note(1) These data show average statuses.
Depending on the system control, there may be ranges where the operation is not conducted continuously.
These data show the case where the operation frequency of a compressor is fixed.
(2) Capacities are based on the following conditions.
Corresponding refrigerant piping length :7.5m
Level difference of Zero.
(3) Symbols are as follows.
TC : Total cooling capacity (kW)
SHC : Sensible heat capacity (kW)
HC : Heating capacity (kW)

Model **FDEN200VSPVF1** Indoor unit **FDEN100VF1** (2 units) Outdoor unit **FDC200VS**
Cool Mode (kW) Heat Mode:HC (kW)

Outdoor air temp.	Indoor air temperature															
	18 DB		21 DB		23 DB		26 DB		27 DB		28 DB		31 DB		33 DB	
	12 WB	14 WB	16 WB	18 WB	19 WB	20 WB	22 WB	24 WB	TC	SHC	TC	SHC	TC	SHC	TC	SHC
DB	TC	SHC	TC	SHC	TC	SHC	TC	SHC	TC	SHC	TC	SHC	TC	SHC	TC	SHC
11					17.37	12.84	18.41	13.80	18.94	13.60	19.50	13.40	20.63	14.04	21.76	13.56
13					17.90	13.03	18.99	13.99	19.54	13.78	20.13	13.58	21.31	14.21	22.49	13.72
15					18.43	13.23	19.57	14.18	20.14	13.97	20.75	13.76	21.98	14.39	23.21	13.88
17					18.96	13.42	20.14	14.37	20.73	14.15	21.38	13.95	22.66	14.57	23.94	14.05
19					19.35	13.57	20.56	14.51	21.16	14.29	21.81	14.08	23.12	14.69	24.42	14.16
21					19.41	13.59	20.98	14.65	21.59	14.43	22.25	14.21	23.57	14.81	24.89	14.27
23					19.31	13.55	20.86	14.61	21.47	14.39	22.12	14.17	23.43	14.77	24.73	14.23
25			17.35	13.77	19.20	13.51	20.74	14.57	21.35	14.35	21.99	14.13	23.28	14.73	24.57	14.19
27			17.28	13.74	19.10	13.48	20.62	14.53	21.22	14.31	21.83	14.08	23.04	14.67		
29			17.14	13.68	18.85	13.38	20.31	14.42	20.92	14.21	21.53	13.99	22.75	14.59		
31			16.99	13.62	18.59	13.29	20.00	14.32	20.61	14.12	21.22	13.90	22.45	14.51		
33	16.46	12.98	17.03	13.64	18.33	13.19	19.69	14.22	20.31	14.02	20.92	13.81	22.15	14.43		
35	16.14	12.84	16.76	13.53	18.08	13.10	19.38	14.11	20.00	13.92	20.62	13.72	21.85	14.35		
37	15.86	12.72	16.50	13.43	17.76	12.98	18.98	13.98	19.57	13.79	20.17	13.59	21.35	14.22		
39	15.59	12.60	16.23	13.32	17.44	12.87	18.58	13.85	19.15	13.66	19.71	13.46	20.85	14.10		
41	15.32	12.49	15.97	13.22	17.13	12.76	18.17	13.72	18.72	13.53	19.26	13.33	20.35	13.97		
43	15.04	12.37	15.70	13.11	16.81	12.64	17.77	13.59	18.29	13.40	18.81	13.20	19.85	13.85		

Outdoor air temp.	Indoor air temperature						
	DB	WB	16	18	20	22	24
-19.8	-20						
-17.7	-18						
-15.7	-16						
-13.5	-14	13.21	13.18	13.14	13.11	13.08	
-11.5	-12	13.91	13.87	13.83	13.79	13.76	
-9.5	-10	14.61	14.57	14.52	14.47	14.43	
-7.5	-8	15.31	15.26	15.21	15.16	15.10	
-5.5	-6	15.64	15.58	15.52	15.46	15.40	
-3.0	-4	15.96	15.89	15.82	15.76	15.69	
-1.0	-2	16.29	16.21	16.13	16.06	15.98	
1.0	0	16.61	16.53	16.44	16.36	16.28	
2.0	1	16.78	16.69	16.59	16.51	16.42	
3.0	2	17.96	17.86	17.76	17.66	17.56	
5.0	4	20.33	20.21	20.08	19.96	19.84	
7.0	6	22.71	22.55	22.40	22.26	22.12	
9.0	8	23.43	23.28	23.13	22.88	22.63	
11.5	10	24.14	24.00	23.86	23.50	23.13	
13.5	12	25.41	25.24	25.07	24.77	24.43	
15.5	14	26.67	26.47	26.27	26.05	25.72	
16.5	16	27.30	27.09	26.87	26.69	26.37	

PFA003Z924 

Model **FDEN250VSPVF** Indoor unit **FDEN125VF** (2 units) Outdoor unit **FDC250VS**
Cool Mode (kW) Heat Mode:HC (kW)

Outdoor air temp.	Indoor air temperature															
	18 DB		21 DB		23 DB		26 DB		27 DB		28 DB		31 DB		33 DB	
	12 WB	14 WB	16 WB	18 WB	19 WB	20 WB	22 WB	24 WB	TC	SHC	TC	SHC	TC	SHC	TC	SHC
DB	TC	SHC	TC	SHC	TC	SHC	TC	SHC	TC	SHC	TC	SHC	TC	SHC	TC	SHC
11					21.71	15.36	23.02	16.42	23.67	16.17	24.38	15.92	25.79	16.62	27.21	16.02
13					22.38	15.61	23.74	16.66	24.42	16.41	25.16	16.16	26.63	16.84	28.11	16.23
15					23.04	15.86	24.46	16.91	25.17	16.65	25.94	16.40	27.48	17.07	29.02	16.44
17					23.70	16.11	25.18	17.16	25.92	16.90	26.72	16.64	28.32	17.30	29.92	16.66
19					24.19	16.30	25.70	17.34	26.45	17.08	27.27	16.81	28.89	17.46	30.52	16.81
21					24.26	16.33	26.22	17.53	26.99	17.26	27.82	16.99	29.47	17.63	31.12	16.96
23					24.13	16.28	26.07	17.48	26.84	17.21	27.65	16.94	29.28	17.57	30.91	16.90
25			21.69	16.50	24.00	16.23	25.92	17.42	26.68	17.16	27.49	16.88	29.10	17.52	30.71	16.85
27			21.60	16.46	23.88	16.18	25.77	17.37	26.53	17.10	27.29	16.82	28.80	17.44		
29			21.42	16.39	23.56	16.06	25.39	17.23	26.15	16.98	26.91	16.70	28.43	17.33		
31			21.24	16.31	23.24	15.93	25.00	17.10	25.77	16.85	26.53	16.58	28.06	17.23		
33	20.58	15.64	21.29	16.33	22.92	15.81	24.61	16.96	25.38	16.72	26.15	16.46	27.69	17.13		
35	20.17	15.45	20.96	16.20	22.60	15.69	24.23	16.83	25.00	16.60	25.77	16.34	27.31	17.03		
37	19.83	15.29	20.62	16.06	22.20	15.54	23.73	16.66	24.47	16.42	25.21	16.17	26.69	16.86		
39	19.49	15.14	20.29	15.92	21.80	15.39	23.22	16.49	23.93	16.25	24.64	16.00	26.06	16.69		
41	19.15	14.99	19.96	15.79	21.41	15.24	22.72	16.32	23.40	16.08	24.08	15.83	25.43	16.52		
43	18.81	14.84	19.63	15.65	21.01	15.10	22.22	16.15	22.86	15.91	23.51	15.66	24.81	16.36		

Outdoor air temp.	Indoor air temperature						
	DB	WB	16	18	20	22	24
-19.8	-20						
-17.7	-18						
-15.7	-16						
-13.5	-14	16.52	16.47	16.43	16.39	16.35	
-11.5	-12	17.39	17.34	17.29	17.24	17.19	
-9.5	-10	18.26	18.21	18.15	18.09	18.04	
-7.5	-8	19.14	19.07	19.01	18.94	18.88	
-5.5	-6	19.55	19.47	19.40	19.32	19.24	
-3.0	-4	19.95	19.87	19.78	19.70	19.61	
-1.0	-2	20.36	20.26	20.17	20.07	19.98	
1.0	0	20.77	20.66	20.55	20.45	20.35	
2.0	1	20.97	20.86	20.74	20.64	20.53	
3.0	2	22.45	22.32	22.19	22.07	21.95	
5.0	4	25.42	25.26	25.10	24.95	24.80	
7.0	6	28.38	28.19	28.00	27.82	27.65	
9.0	8	29.28	29.10	28.91	28.60	28.28	
11.5	10	30.18	30.00	29.83	29.37	28.91	
13.5	12	31.76	31.55	31.33	30.97	30.53	
15.5	14	33.34	33.09	32.84	32.57	32.15	
16.5	16	34.13	33.86	33.59	33.37	32.96	

PFA003Z924 

Note(1) These data show average statuses.
Depending on the system control, there may be ranges where the operation is not conducted continuously.
These data show the case where the operation frequency of a compressor is fixed.
(2) Capacities are based on the following conditions.
Corresponding refrigerant piping length :7.5m
Level difference of Zero.
(3) Symbols are as follows.
TC : Total cooling capacity (kW)
SHC : Sensible heat capacity (kW)
HC : Heating capacity (kW)

(c) Triple type

Model **FDEN140VNTVF** Indoor unit FDEN50VF (3 units) Outdoor unit FDC140VN
Cool Mode

Outdoor air temp.	Indoor air temperature (kW)															
	18 DB		21 DB		23 DB		26 DB		27 DB		28 DB		31 DB		33 DB	
	12 WB	14 WB	16 WB	18 WB	19 WB	20 WB	22 WB	24 WB	TC	SHC	TC	SHC	TC	SHC	TC	SHC
DB	TC	SHC	TC	SHC	TC	SHC	TC	SHC	TC	SHC	TC	SHC	TC	SHC	TC	SHC
11					11.37	8.98	12.02	9.63	12.35	9.55	12.70	9.48	13.39	9.96	14.08	9.78
13					11.90	9.21	12.61	9.87	12.96	9.80	13.33	9.72	14.09	10.21	14.84	10.02
15					12.43	9.45	13.19	10.11	13.57	10.04	13.97	9.97	14.78	10.45	15.59	10.27
17					12.96	9.69	13.77	10.36	14.17	10.29	14.61	10.22	15.48	10.71	16.34	10.52
19					13.24	9.82	14.06	10.48	14.48	10.41	14.92	10.35	15.80	10.82	16.68	10.63
21					13.51	9.94	14.36	10.61	14.78	10.54	15.23	10.47	16.12	10.94	17.02	10.75
23					13.51	9.94	14.40	10.63	14.82	10.56	15.28	10.49	16.19	10.97	17.10	10.77
25			12.50	10.06	13.50	9.94	14.43	10.64	14.86	10.57	15.33	10.51	16.25	10.99	17.18	10.80
27			12.41	10.01	13.50	9.94	14.47	10.66	14.91	10.59	15.34	10.51	16.20	10.97		
29			12.32	9.97	13.29	9.84	14.23	10.56	14.68	10.50	15.13	10.43	16.02	10.90		
31			12.23	9.92	13.09	9.75	13.99	10.45	14.45	10.40	14.92	10.35	15.85	10.84		
33	11.51	9.33	12.01	9.82	12.89	9.66	13.75	10.35	14.23	10.31	14.71	10.26	15.67	10.78		
35	11.28	9.21	11.82	9.72	12.68	9.56	13.50	10.24	14.00	10.22	14.50	10.18	15.49	10.71		
37	11.08	9.11	11.62	9.63	12.47	9.47	13.25	10.14	13.71	10.10	14.18	10.05	15.12	10.58		
39	10.89	9.01	11.43	9.53	12.26	9.37	12.99	10.03	13.43	9.98	13.86	9.93	14.74	10.44		
41	10.70	8.91	11.23	9.44	12.04	9.27	12.73	9.92	13.14	9.87	13.55	9.81	14.36	10.30		
43	10.51	8.82	11.03	9.34	11.83	9.18	12.47	9.81	12.85	9.75	13.23	9.69	13.98	10.17		

Heat Mode:HC (kW)

Outdoor air temp.	Indoor air temperature (kW)						
	DB	WB	16	18	20	22	24
-19.8	-20	8.06	8.03	8.00	7.97	7.94	
-17.7	-18	8.53	8.50	8.46	8.43	8.39	
-15.7	-16	9.00	8.96	8.92	8.88	8.85	
-13.5	-14	9.52	9.48	9.43	9.39	9.35	
-11.5	-12	10.04	9.99	9.95	9.90	9.85	
-9.5	-10	10.56	10.51	10.46	10.41	10.36	
-7.5	-8	11.08	11.02	10.97	10.91	10.86	
-5.5	-6	11.32	11.26	11.21	11.15	11.09	
-3.0	-4	11.56	11.50	11.44	11.38	11.31	
-1.0	-2	11.81	11.75	11.68	11.61	11.54	
1.0	0	12.05	11.99	11.92	11.84	11.77	
2.0	1	12.18	12.11	12.04	11.96	11.89	
3.0	2	12.98	12.90	12.83	12.77	12.72	
5.0	4	14.58	14.50	14.41	14.40	14.38	
7.0	6	16.19	16.09	16.00	16.02	16.05	
9.0	8	16.83	16.73	16.63	16.59	16.55	
11.5	10	17.46	17.37	17.27	17.17	17.06	
13.5	12	18.44	18.33	18.22	18.08	18.00	
15.5	14	19.41	19.29	19.17	18.99	18.95	
16.5	16	19.90	19.77	19.64	19.45	19.42	



Model **FDEN140VSTVF** Indoor unit FDEN50VF (3 units) Outdoor unit FDC140VS
Cool Mode

Outdoor air temp.	Indoor air temperature (kW)															
	18 DB		21 DB		23 DB		26 DB		27 DB		28 DB		31 DB		33 DB	
	12 WB	14 WB	16 WB	18 WB	19 WB	20 WB	22 WB	24 WB	TC	SHC	TC	SHC	TC	SHC	TC	SHC
DB	TC	SHC	TC	SHC	TC	SHC	TC	SHC	TC	SHC	TC	SHC	TC	SHC	TC	SHC
11					11.37	8.98	12.02	9.63	12.35	9.55	12.70	9.48	13.39	9.96	14.08	9.78
13					11.90	9.21	12.61	9.87	12.96	9.80	13.33	9.72	14.09	10.21	14.84	10.02
15					12.43	9.45	13.19	10.11	13.57	10.04	13.97	9.97	14.78	10.45	15.59	10.27
17					12.96	9.69	13.77	10.36	14.17	10.29	14.61	10.22	15.48	10.71	16.34	10.52
19					13.24	9.82	14.06	10.48	14.48	10.41	14.92	10.35	15.80	10.82	16.68	10.63
21					13.51	9.94	14.36	10.61	14.78	10.54	15.23	10.47	16.12	10.94	17.02	10.75
23					13.51	9.94	14.40	10.63	14.82	10.56	15.28	10.49	16.19	10.97	17.10	10.77
25			12.50	10.06	13.50	9.94	14.43	10.64	14.86	10.57	15.33	10.51	16.25	10.99	17.18	10.80
27			12.41	10.01	13.50	9.94	14.47	10.66	14.91	10.59	15.34	10.51	16.20	10.97		
29			12.32	9.97	13.29	9.84	14.23	10.56	14.68	10.50	15.13	10.43	16.02	10.90		
31			12.23	9.92	13.09	9.75	13.99	10.45	14.45	10.40	14.92	10.35	15.85	10.84		
33	11.51	9.33	12.01	9.82	12.89	9.66	13.75	10.35	14.23	10.31	14.71	10.26	15.67	10.78		
35	11.28	9.21	11.82	9.72	12.68	9.56	13.50	10.24	14.00	10.22	14.50	10.18	15.49	10.71		
37	11.08	9.11	11.62	9.63	12.47	9.47	13.25	10.14	13.71	10.10	14.18	10.05	15.12	10.58		
39	10.89	9.01	11.43	9.53	12.26	9.37	12.99	10.03	13.43	9.98	13.86	9.93	14.74	10.44		
41	10.70	8.91	11.23	9.44	12.04	9.27	12.73	9.92	13.14	9.87	13.55	9.81	14.36	10.30		
43	10.51	8.82	11.03	9.34	11.83	9.18	12.47	9.81	12.85	9.75	13.23	9.69	13.98	10.17		

Heat Mode:HC (kW)

Outdoor air temp.	Indoor air temperature (kW)						
	DB	WB	16	18	20	22	24
-19.8	-20	8.06	8.03	8.00	7.97	7.94	
-17.7	-18	8.53	8.50	8.46	8.43	8.39	
-15.7	-16	9.00	8.96	8.92	8.88	8.85	
-13.5	-14	9.52	9.48	9.43	9.39	9.35	
-11.5	-12	10.04	9.99	9.95	9.90	9.85	
-9.5	-10	10.56	10.51	10.46	10.41	10.36	
-7.5	-8	11.08	11.02	10.97	10.91	10.86	
-5.5	-6	11.32	11.26	11.21	11.15	11.09	
-3.0	-4	11.56	11.50	11.44	11.38	11.31	
-1.0	-2	11.81	11.75	11.68	11.61	11.54	
1.0	0	12.05	11.99	11.92	11.84	11.77	
2.0	1	12.18	12.11	12.04	11.96	11.89	
3.0	2	12.98	12.90	12.83	12.77	12.72	
5.0	4	14.58	14.50	14.41	14.40	14.38	
7.0	6	16.19	16.09	16.00	16.02	16.05	
9.0	8	16.83	16.73	16.63	16.59	16.55	
11.5	10	17.46	17.37	17.27	17.17	17.06	
13.5	12	18.44	18.33	18.22	18.08	18.00	
15.5	14	19.41	19.29	19.17	18.99	18.95	
16.5	16	19.90	19.77	19.64	19.45	19.42	

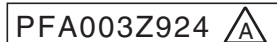

Note(1) These data show average statuses.
Depending on the system control, there may be ranges where the operation is not conducted continuously.
These data show the case where the operation frequency of a compressor is fixed.
(2) Capacities are based on the following conditions.
Corresponding refrigerant piping length :7.5m
Level difference of Zero.
(3) Symbols are as follows.
TC : Total cooling capacity (kW)
SHC : Sensible heat capacity (kW)
HC : Heating capacity (kW)

Model **FDEN200VSTVF1** Indoor unit **FDEN71VF1 (3 units)** Outdoor unit **FDC200VS**
Cool Mode (kW) Heat Mode:HC (kW)

Outdoor air temp.	Indoor air temperature																
	18 DB		21 DB		23 DB		26 DB		27 DB		28 DB		31 DB		33 DB		
	12 WB		14 WB		16 WB		18 WB		19 WB		20 WB		22 WB		24 WB		
DB	TC	SHC	TC	SHC	TC	SHC	TC	SHC	TC	SHC	TC	SHC	TC	SHC	TC	SHC	
11					17.37	14.36	18.41	15.53	18.94	15.39	19.50	15.25	20.63	16.11	21.76	15.77	
13					17.90	14.57	18.99	15.74	19.54	15.60	20.13	15.46	21.31	16.32	22.49	15.97	
15					18.43	14.78	19.57	15.95	20.14	15.81	20.75	15.67	21.98	16.52	23.21	16.17	
17					18.96	15.00	20.14	16.17	20.73	16.02	21.38	15.89	22.66	16.73	23.94	16.37	
19					19.35	15.16	20.56	16.32	21.16	16.18	21.81	16.03	23.12	16.88	24.42	16.51	
21					19.41	15.18	20.98	16.48	21.59	16.33	22.25	16.19	23.57	17.02	24.89	16.64	
23					19.31	15.14	20.86	16.44	21.47	16.29	22.12	16.14	23.43	16.97	24.73	16.60	
25				17.35	15.22	19.20	15.10	20.74	16.39	21.35	16.24	21.99	16.10	23.28	16.93	24.57	16.55
27				17.28	15.19	19.10	15.06	20.62	16.35	21.22	16.20	21.83	16.04	23.04	16.85		
29				17.14	15.13	18.85	14.95	20.31	16.23	20.92	16.09	21.53	15.94	22.75	16.76		
31				16.99	15.07	18.59	14.85	20.00	16.11	20.61	15.98	21.22	15.83	22.45	16.67		
33	16.46	14.26	17.03	15.08	18.33	14.74	19.69	16.00	20.31	15.87	20.92	15.73	22.15	16.58			
35	16.14	14.11	16.76	14.97	18.08	14.64	19.38	15.88	20.00	15.76	20.62	15.63	21.85	16.48			
37	15.86	13.98	16.50	14.86	17.76	14.51	18.98	15.73	19.57	15.61	20.17	15.48	21.35	16.33			
39	15.59	13.85	16.23	14.74	17.44	14.39	18.58	15.59	19.15	15.46	19.71	15.32	20.85	16.18			
41	15.32	13.73	15.97	14.63	17.13	14.26	18.17	15.44	18.72	15.31	19.26	15.17	20.35	16.03			
43	15.04	13.60	15.70	14.51	16.81	14.14	17.77	15.29	18.29	15.16	18.81	15.02	19.85	15.88			

Outdoor air temp.	Indoor air temperature											
	DB		16		18		20		22		24	
	DB	WB	16	18	20	22	24					
-19.8	-20											
-17.7	-18											
-15.7	-16											
-13.5	-14	13.21	13.18	13.14	13.11	13.08						
-11.5	-12	13.91	13.87	13.83	13.79	13.76						
-9.5	-10	14.61	14.57	14.52	14.47	14.43						
-7.5	-8	15.31	15.26	15.21	15.16	15.10						
-5.5	-6	15.64	15.58	15.52	15.46	15.40						
-3.0	-4	15.96	15.89	15.82	15.76	15.69						
-1.0	-2	16.29	16.21	16.13	16.06	15.98						
1.0	0	16.61	16.53	16.44	16.36	16.28						
2.0	1	16.78	16.69	16.59	16.51	16.42						
3.0	2	17.96	17.86	17.76	17.66	17.56						
5.0	4	20.33	20.21	20.08	19.96	19.84						
7.0	6	22.71	22.55	22.40	22.26	22.12						
9.0	8	23.43	23.28	23.13	22.88	22.63						
11.5	10	24.14	24.00	23.86	23.50	23.13						
13.5	12	25.41	25.24	25.07	24.77	24.43						
15.5	14	26.67	26.47	26.27	26.05	25.72						
16.5	16	27.30	27.09	26.87	26.69	26.37						

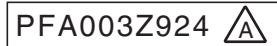

(d) Double twin type

Model **FDEN200VSDVF** Indoor unit **FDEN50VF (4 units)** Outdoor unit **FDC200VS**
Cool Mode (kW) Heat Mode:HC (kW)

Outdoor air temp.	Indoor air temperature																
	18 DB		21 DB		23 DB		26 DB		27 DB		28 DB		31 DB		33 DB		
	12 WB		14 WB		16 WB		18 WB		19 WB		20 WB		22 WB		24 WB		
DB	TC	SHC	TC	SHC	TC	SHC	TC	SHC	TC	SHC	TC	SHC	TC	SHC	TC	SHC	
11					17.37	12.96	18.41	13.83	18.94	13.73	19.50	13.64	20.63	14.27	21.76	14.01	
13					17.90	13.21	18.99	14.08	19.54	13.98	20.13	13.89	21.31	14.52	22.49	14.26	
15					18.43	13.45	19.57	14.33	20.14	14.23	20.75	14.14	21.98	14.77	23.21	14.50	
17					18.96	13.70	20.14	14.58	20.73	14.48	21.38	14.40	22.66	15.03	23.94	14.76	
19					19.35	13.89	20.56	14.77	21.16	14.67	21.81	14.57	23.12	15.20	24.42	14.92	
21					19.41	13.92	20.98	14.96	21.59	14.85	22.25	14.75	23.57	15.37	24.89	15.09	
23					19.31	13.87	20.86	14.90	21.47	14.80	22.12	14.70	23.43	15.32	24.73	15.03	
25				17.35	13.75	19.20	13.82	20.74	14.85	21.35	14.75	21.99	14.65	23.28	15.26	24.57	14.98
27				17.28	13.71	19.10	13.77	20.62	14.80	21.22	14.69	21.83	14.58	23.04	15.17		
29				17.14	13.64	18.85	13.65	20.31	14.66	20.92	14.56	21.53	14.46	22.75	15.06		
31				16.99	13.57	18.59	13.53	20.00	14.52	20.61	14.43	21.22	14.33	22.45	14.95		
33	16.46	13.03	17.03	13.59	18.33	13.41	19.69	14.38	20.31	14.31	20.92	14.21	22.15	14.83			
35	16.14	12.86	16.76	13.45	18.08	13.29	19.38	14.25	20.00	14.17	20.62	14.09	21.85	14.72			
37	15.86	12.71	16.50	13.33	17.76	13.14	18.98	14.08	19.57	14.00	20.17	13.91	21.35	14.54			
39	15.59	12.57	16.23	13.19	17.44	12.99	18.58	13.90	19.15	13.82	19.71	13.72	20.85	14.35			
41	15.32	12.43	15.97	13.07	17.13	12.85	18.17	13.73	18.72	13.64	19.26	13.54	20.35	14.17			
43	15.04	12.28	15.70	12.94	16.81	12.71	17.77	13.56	18.29	13.47	18.81	13.37	19.85	13.99			

Outdoor air temp.	Indoor air temperature											
	DB		16		18		20		22		24	
	DB	WB	16	18	20	22	24					
-19.8	-20											
-17.7	-18											
-15.7	-16											
-13.5	-14	13.21	13.18	13.14	13.11	13.08						
-11.5	-12	13.91	13.87	13.83	13.79	13.76						
-9.5	-10	14.61	14.57	14.52	14.47	14.43						
-7.5	-8	15.31	15.26	15.21	15.16	15.10						
-5.5	-6	15.64	15.58	15.52	15.46	15.40						
-3.0	-4	15.96	15.89	15.82	15.76	15.69						
-1.0	-2	16.29	16.21	16.13	16.06	15.98						
1.0	0	16.61	16.53	16.44	16.36	16.28						
2.0	1	16.78	16.69	16.59	16.51	16.42						
3.0	2	17.96	17.86	17.76	17.66	17.56						
5.0	4	20.33	20.21	20.08	19.96	19.84						
7.0	6	22.71	22.55	22.40	22.26	22.12						
9.0	8	23.43	23.28	23.13	22.88	22.63						
11.5	10	24.14	24.00	23.86	23.50	23.13						
13.5	12	25.41	25.24	25.07	24.77	24.43						
15.5	14	26.67	26.47	26.27	26.05	25.72						
16.5	16	27.30	27.09	26.87	26.69	26.37						

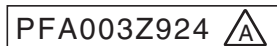

Note(1) These data show average statuses.
Depending on the system control, there may be ranges where the operation is not conducted continuously.
These data show the case where the operation frequency of a compressor is fixed.
(2) Capacities are based on the following conditions.
Corresponding refrigerant piping length :7.5m
Level difference of Zero.
(3) Symbols are as follows.
TC : Total cooling capacity (kW)
SHC : Sensible heat capacity (kW)
HC : Heating capacity (kW)

Model **FDEN250VSDVF** Indoor unit **FDEN60VF (4 units)** Outdoor unit **FDC250VS**
 Cool Mode

(kW)

Heat Mode:HC

(kW)

Outdoor air temp.	Indoor air temperature															
	18 DB		21 DB		23 DB		26 DB		27 DB		28 DB		31 DB		33 DB	
	12 WB	14 WB	16 WB	18 WB	19 WB	20 WB	22 WB	24 WB	TC	SHC	TC	SHC	TC	SHC	TC	SHC
DB	TC	SHC	TC	SHC	TC	SHC	TC	SHC	TC	SHC	TC	SHC	TC	SHC	TC	SHC
11					21.71	16.88	23.02	18.19	23.67	17.97	24.38	17.76	25.79	18.68	27.21	18.16
13					22.38	17.13	23.74	18.44	24.42	18.22	25.16	18.00	26.63	18.91	28.11	18.38
15					23.04	17.38	24.46	18.69	25.17	18.46	25.94	18.24	27.48	19.15	29.02	18.61
17					23.70	17.64	25.18	18.94	25.92	18.71	26.72	18.49	28.32	19.39	29.92	18.83
19					24.19	17.83	25.70	19.12	26.45	18.89	27.27	18.67	28.89	19.55	30.52	18.99
21					24.26	17.85	26.22	19.31	26.99	19.08	27.82	18.84	29.47	19.72	31.12	19.14
23					24.13	17.80	26.07	19.25	26.84	19.02	27.65	18.79	29.28	19.67	30.91	19.09
25			21.69	18.00	24.00	17.75	25.92	19.20	26.68	18.97	27.49	18.74	29.10	19.61	30.71	19.04
27			21.60	17.96	23.88	17.71	25.77	19.15	26.53	18.92	27.29	18.67	28.80	19.53		
29			21.42	17.89	23.56	17.58	25.39	19.01	26.15	18.79	26.91	18.55	28.43	19.42		
31			21.24	17.81	23.24	17.46	25.00	18.87	25.77	18.66	26.53	18.43	28.06	19.32		
33	20.58	16.92	21.29	17.83	22.92	17.34	24.61	18.74	25.38	18.53	26.15	18.31	27.69	19.21		
35	20.17	16.74	20.96	17.70	22.60	17.21	24.23	18.61	25.00	18.41	25.77	18.19	27.31	19.10		
37	19.83	16.58	20.62	17.56	22.20	17.06	23.73	18.43	24.47	18.23	25.21	18.02	26.69	18.93		
39	19.49	16.43	20.29	17.42	21.80	16.91	23.22	18.26	23.93	18.06	24.64	17.84	26.06	18.76		
41	19.15	16.28	19.96	17.28	21.41	16.76	22.72	18.09	23.40	17.88	24.08	17.67	25.43	18.58		
43	18.81	16.13	19.63	17.15	21.01	16.62	22.22	17.92	22.86	17.71	23.51	17.49	24.81	18.42		

Outdoor air temp.		Indoor air temperature					
DB	WB	DB					
		16	18	20	22	24	
-19.8	-20						
-17.7	-18						
-15.7	-16						
-13.5	-14	16.52	16.47	16.43	16.39	16.35	
-11.5	-12	17.39	17.34	17.29	17.24	17.19	
-9.5	-10	18.26	18.21	18.15	18.09	18.04	
-7.5	-8	19.14	19.07	19.01	18.94	18.88	
-5.5	-6	19.55	19.47	19.40	19.32	19.24	
-3.0	-4	19.95	19.87	19.78	19.70	19.61	
-1.0	-2	20.36	20.26	20.17	20.07	19.98	
1.0	0	20.77	20.66	20.55	20.45	20.35	
2.0	1	20.97	20.86	20.74	20.64	20.53	
3.0	2	22.45	22.32	22.19	22.07	21.95	
5.0	4	25.42	25.26	25.10	24.95	24.80	
7.0	6	28.38	28.19	28.00	27.82	27.65	
9.0	8	29.28	29.10	28.91	28.60	28.28	
11.5	10	30.18	30.00	29.83	29.37	28.91	
13.5	12	31.76	31.55	31.33	30.97	30.53	
15.5	14	33.34	33.09	32.84	32.57	32.15	
16.5	16	34.13	33.86	33.59	33.37	32.96	

- Note(1) These data show average statuses.
 Depending on the system control, there may be ranges where the operation is not conducted continuously.
 These data show the case where the operation frequency of a compressor is fixed.
- (2) Capacities are based on the following conditions.
 Corresponding refrigerant piping length :7.5m
 Level difference of Zero.
- (3) Symbols are as follows.
 TC : Total cooling capacity (kW)
 SHC : Sensible heat capacity (kW)
 HC : Heating capacity (kW)

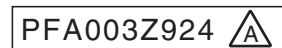

(4) Duct connected-High static pressure type (FDU)

Model **FDU100VNVF1, 100VNVF2** Indoor unit FDU100VF1 Outdoor unit FDC100VN
Cool Mode 100VF2 (kW) Heat Mode:HC (kW)

Outdoor air temp.	Indoor air temperature															
	18°CDB		21°CDB		23°CDB		26°CDB		27°CDB		28°CDB		31°CDB		33°CDB	
	12°CWB	14°CWB	16°CWB	18°CWB	19°CWB	20°CWB	22°CWB	24°CWB	TC	SHC	TC	SHC	TC	SHC	TC	SHC
11					8.12	6.88	8.59	7.50	8.82	7.38	9.07	7.26	9.56	7.69	10.06	7.42
13					8.50	6.99	9.00	7.61	9.26	7.48	9.52	7.36	10.06	7.78	10.60	7.49
15					8.88	7.10	9.42	7.71	9.69	7.58	9.98	7.45	10.56	7.87	11.14	7.57
17					9.26	7.21	9.84	7.82	10.12	7.69	10.43	7.56	11.05	7.96	11.67	7.65
19					9.46	7.27	10.05	7.88	10.34	7.74	10.65	7.60	11.29	8.01	11.92	7.69
21					9.65	7.33	10.25	7.93	10.56	7.80	10.88	7.66	11.52	8.06	12.16	7.73
23					9.65	7.33	10.28	7.94	10.59	7.80	10.91	7.66	11.56	8.06	12.21	7.74
25			8.93	7.64	9.64	7.33	10.31	7.95	10.62	7.81	10.95	7.67	11.61	8.07	12.27	7.75
27			8.86	7.62	9.64	7.33	10.34	7.95	10.65	7.82	10.96	7.68	11.57	8.06		
29			8.80	7.59	9.50	7.29	10.17	7.91	10.49	7.78	10.81	7.64	11.45	8.04		
31			8.73	7.57	9.35	7.24	9.99	7.86	10.32	7.74	10.66	7.61	11.32	8.02		
33	8.22	7.04	8.58	7.52	9.21	7.20	9.82	7.82	10.16	7.70	10.51	7.57	11.19	7.99		
35	8.05	6.98	8.44	7.47	9.06	7.15	9.64	7.77	10.00	7.66	10.36	7.54	11.07	7.97		
37	7.92	6.93	8.30	7.43	8.91	7.11	9.46	7.72	9.79	7.61	10.13	7.49	10.80	7.92		
39	7.78	6.88	8.16	7.38	8.75	7.06	9.28	7.68	9.59	7.56	9.90	7.44	10.53	7.87		
41	7.64	6.83	8.02	7.33	8.60	7.02	9.09	7.63	9.38	7.51	9.68	7.39	10.26	7.82		
43	7.50	6.77	7.88	7.29	8.45	6.97	8.91	7.58	9.18	7.46	9.45	7.34	9.99	7.77		

Outdoor air temp.	°CDB	°CWB	Indoor air temperature				
			16	18	20	22	24
-19.8	-20		5.64	5.62	5.60	5.58	5.56
-17.7	-18		5.97	5.95	5.92	5.90	5.87
-15.7	-16		6.30	6.27	6.25	6.22	6.19
-13.5	-14		6.66	6.63	6.60	6.57	6.54
-11.5	-12		7.03	6.99	6.96	6.93	6.90
-9.5	-10		7.39	7.36	7.32	7.29	7.25
-7.5	-8		7.75	7.72	7.68	7.64	7.60
-5.5	-6		7.92	7.88	7.85	7.80	7.76
-3.0	-4		8.10	8.05	8.01	7.97	7.92
1.0	0		8.44	8.39	8.34	8.29	8.24
2.0	1		8.52	8.47	8.42	8.37	8.32
3.0	2		9.08	9.03	8.98	8.94	8.90
5.0	4		10.21	10.15	10.09	10.08	10.07
7.0	6		11.33	11.27	11.20	11.22	11.23
9.0	8		11.78	11.71	11.64	11.62	11.59
11.5	10		12.23	12.16	12.09	12.02	11.94
13.5	12		12.91	12.83	12.75	12.65	12.60
15.5	14		13.59	13.50	13.42	13.29	13.26
16.5	16		13.93	13.84	13.75	13.61	13.59

PJG000Z046 

Model **FDU100VSF1, 100VSF2** Indoor unit FDU100VF1 Outdoor unit FDC100VS
Cool Mode 100VF2 (kW) Heat Mode:HC (kW)

Outdoor air temp.	Indoor air temperature															
	18°CDB		21°CDB		23°CDB		26°CDB		27°CDB		28°CDB		31°CDB		33°CDB	
	12°CWB	14°CWB	16°CWB	18°CWB	19°CWB	20°CWB	22°CWB	24°CWB	TC	SHC	TC	SHC	TC	SHC	TC	SHC
11					8.12	6.88	8.59	7.50	8.82	7.38	9.07	7.26	9.56	7.69	10.06	7.42
13					8.50	6.99	9.00	7.61	9.26	7.48	9.52	7.36	10.06	7.78	10.60	7.49
15					8.88	7.10	9.42	7.71	9.69	7.58	9.98	7.45	10.56	7.87	11.14	7.57
17					9.26	7.21	9.84	7.82	10.12	7.69	10.43	7.56	11.05	7.96	11.67	7.65
19					9.46	7.27	10.05	7.88	10.34	7.74	10.65	7.60	11.29	8.01	11.92	7.69
21					9.65	7.33	10.25	7.93	10.56	7.80	10.88	7.66	11.52	8.06	12.16	7.73
23					9.65	7.33	10.28	7.94	10.59	7.80	10.91	7.66	11.56	8.06	12.21	7.74
25			8.93	7.64	9.64	7.33	10.31	7.95	10.62	7.81	10.95	7.67	11.61	8.07	12.27	7.75
27			8.86	7.62	9.64	7.33	10.34	7.95	10.65	7.82	10.96	7.68	11.57	8.06		
29			8.80	7.59	9.50	7.29	10.17	7.91	10.49	7.78	10.81	7.64	11.45	8.04		
31			8.73	7.57	9.35	7.24	9.99	7.86	10.32	7.74	10.66	7.61	11.32	8.02		
33	8.22	7.04	8.58	7.52	9.21	7.20	9.82	7.82	10.16	7.70	10.51	7.57	11.19	7.99		
35	8.05	6.98	8.44	7.47	9.06	7.15	9.64	7.77	10.00	7.66	10.36	7.54	11.07	7.97		
37	7.92	6.93	8.30	7.43	8.91	7.11	9.46	7.72	9.79	7.61	10.13	7.49	10.80	7.92		
39	7.78	6.88	8.16	7.38	8.75	7.06	9.28	7.68	9.59	7.56	9.90	7.44	10.53	7.87		
41	7.64	6.83	8.02	7.33	8.60	7.02	9.09	7.63	9.38	7.51	9.68	7.39	10.26	7.82		
43	7.50	6.77	7.88	7.29	8.45	6.97	8.91	7.58	9.18	7.46	9.45	7.34	9.99	7.77		

Outdoor air temp.	°CDB	°CWB	Indoor air temperature				
			16	18	20	22	24
-19.8	-20		5.64	5.62	5.60	5.58	5.56
-17.7	-18		5.97	5.95	5.92	5.90	5.87
-15.7	-16		6.30	6.27	6.25	6.22	6.19
-13.5	-14		6.66	6.63	6.60	6.57	6.54
-11.5	-12		7.03	6.99	6.96	6.93	6.90
-9.5	-10		7.39	7.36	7.32	7.29	7.25
-7.5	-8		7.75	7.72	7.68	7.64	7.60
-5.5	-6		7.92	7.88	7.85	7.80	7.76
-3.0	-4		8.10	8.05	8.01	7.97	7.92
1.0	0		8.44	8.39	8.34	8.29	8.24
2.0	1		8.52	8.47	8.42	8.37	8.32
3.0	2		9.08	9.03	8.98	8.94	8.90
5.0	4		10.21	10.15	10.09	10.08	10.07
7.0	6		11.33	11.27	11.20	11.22	11.23
9.0	8		11.78	11.71	11.64	11.62	11.59
11.5	10		12.23	12.16	12.09	12.02	11.94
13.5	12		12.91	12.83	12.75	12.65	12.60
15.5	14		13.59	13.50	13.42	13.29	13.26
16.5	16		13.93	13.84	13.75	13.61	13.59

PJG000Z046 

- Note(1) These data show average statuses.
Depending on the system control, there may be ranges where the operation is not conducted continuously.
These data show the case where the operation frequency of a compressor is fixed.
- (2) Capacities are based on the following conditions.
Corresponding refrigerant piping length :7.5m
Level difference of Zero.
- (3) Symbols are as follows.
TC : Total cooling capacity (kW)
SHC : Sensible heat capacity (kW)
HC : Heating capacity (kW)

Model **FDU125VNVF** Indoor unit FDU125VF Outdoor unit FDC125VN
Cool Mode

Outdoor air temp.	Indoor air temperature															
	18°CDB		21°CDB		23°CDB		26°CDB		27°CDB		28°CDB		31°CDB		33°CDB	
	12°CWB	14°CWB	16°CWB		18°CWB		19°CWB		20°CWB		22°CWB		24°CWB			
°CDB	TC	SHC	TC	SHC	TC	SHC	TC	SHC	TC	SHC	TC	SHC	TC	SHC	TC	SHC
11					10.15	9.23	10.74	10.04	11.03	9.97	11.34	9.90	11.96	10.51	12.57	10.34
13					10.63	9.44	11.26	10.24	11.57	10.17	11.91	10.11	12.58	10.72	13.25	10.55
15					11.10	9.63	11.78	10.44	12.11	10.37	12.47	10.31	13.20	10.92	13.92	10.75
17					11.58	9.84	12.29	10.64	12.65	10.58	13.04	10.52	13.82	11.13	14.59	10.96
19					11.82	9.94	12.56	10.75	12.92	10.68	13.32	10.62	14.11	11.23	14.90	11.06
21					12.06	10.04	12.82	10.86	13.19	10.79	13.60	10.73	14.40	11.33	15.20	11.15
23					12.06	10.04	12.85	10.87	13.23	10.80	13.64	10.74	14.45	11.35	15.27	11.17
25			11.16	10.20	12.06	10.04	12.89	10.88	13.27	10.82	13.68	10.76	14.51	11.37	15.34	11.20
27			11.08	10.16	12.05	10.04	12.92	10.90	13.31	10.83	13.69	10.76	14.47	11.35		
29			11.00	10.12	11.87	9.96	12.71	10.81	13.11	10.76	13.51	10.69	14.31	11.30		
31			10.92	10.09	11.69	9.88	12.49	10.72	12.90	10.67	13.32	10.62	14.15	11.24		
33	10.27	9.37	10.72	9.99	11.51	9.81	12.27	10.64	12.70	10.60	13.13	10.55	13.99	11.19		
35	10.07	9.28	10.55	9.92	11.33	9.73	12.06	10.55	12.50	10.52	12.94	10.48	13.83	11.14		
37	9.90	9.19	10.38	9.84	11.13	9.65	11.83	10.46	12.24	10.42	12.66	10.38	13.50	11.02		
39	9.72	9.11	10.20	9.76	10.94	9.57	11.60	10.37	11.99	10.33	12.38	10.28	13.16	10.91		
41	9.55	9.02	10.02	9.68	10.75	9.49	11.37	10.28	11.73	10.23	12.09	10.17	12.82	10.80		
43	9.38	8.94	9.85	9.60	10.56	9.41	11.14	10.19	11.47	10.13	11.81	10.07	12.48	10.68		

(kW) Heat Mode:HC (kW)

Outdoor air temp.	Indoor air temperature					
	°CDB					
	°CDB	°CWB	16	18	20	22
-19.8	-20	7.06	7.03	7.00	6.97	6.95
-17.7	-18	7.46	7.43	7.41	7.37	7.34
-15.7	-16	7.87	7.84	7.81	7.77	7.74
-13.5	-14	8.33	8.29	8.26	8.22	8.18
-11.5	-12	8.78	8.74	8.70	8.66	8.62
-9.5	-10	9.24	9.19	9.15	9.11	9.06
-7.5	-8	9.69	9.65	9.60	9.55	9.50
-5.5	-6	9.91	9.86	9.81	9.75	9.70
-3.0	-4	10.12	10.07	10.01	9.96	9.90
-1.0	-2	10.33	10.28	10.22	10.16	10.10
1.0	0	10.55	10.49	10.43	10.36	10.30
2.0	1	10.65	10.59	10.53	10.47	10.40
3.0	2	11.36	11.29	11.22	11.18	11.13
5.0	4	12.76	12.69	12.61	12.60	12.58
7.0	6	14.16	14.08	14.00	14.02	14.04
9.0	8	14.72	14.64	14.56	14.52	14.49
11.5	10	15.28	15.20	15.11	15.02	14.93
13.5	12	16.13	16.04	15.94	15.82	15.75
15.5	14	16.98	16.88	16.77	16.62	16.58
16.5	16	17.41	17.30	17.19	17.02	16.99



Model **FDU125SVF** Indoor unit FDU125VF Outdoor unit FDC125VS
Cool Mode

Outdoor air temp.	Indoor air temperature															
	18°CDB		21°CDB		23°CDB		26°CDB		27°CDB		28°CDB		31°CDB		33°CDB	
	12°CWB	14°CWB	16°CWB		18°CWB		19°CWB		20°CWB		22°CWB		24°CWB			
°CDB	TC	SHC	TC	SHC	TC	SHC	TC	SHC	TC	SHC	TC	SHC	TC	SHC	TC	SHC
11					10.15	9.23	10.74	10.04	11.03	9.97	11.34	9.90	11.96	10.51	12.57	10.34
13					10.63	9.44	11.26	10.24	11.57	10.17	11.91	10.11	12.58	10.72	13.25	10.55
15					11.10	9.63	11.78	10.44	12.11	10.37	12.47	10.31	13.20	10.92	13.92	10.75
17					11.58	9.84	12.29	10.64	12.65	10.58	13.04	10.52	13.82	11.13	14.59	10.96
19					11.82	9.94	12.56	10.75	12.92	10.68	13.32	10.62	14.11	11.23	14.90	11.06
21					12.06	10.04	12.82	10.86	13.19	10.79	13.60	10.73	14.40	11.33	15.20	11.15
23					12.06	10.04	12.85	10.87	13.23	10.80	13.64	10.74	14.45	11.35	15.27	11.17
25			11.16	10.20	12.06	10.04	12.89	10.88	13.27	10.82	13.68	10.76	14.51	11.37	15.34	11.20
27			11.08	10.16	12.05	10.04	12.92	10.90	13.31	10.83	13.69	10.76	14.47	11.35		
29			11.00	10.12	11.87	9.96	12.71	10.81	13.11	10.76	13.51	10.69	14.31	11.30		
31			10.92	10.09	11.69	9.88	12.49	10.72	12.90	10.67	13.32	10.62	14.15	11.24		
33	10.27	9.37	10.72	9.99	11.51	9.81	12.27	10.64	12.70	10.60	13.13	10.55	13.99	11.19		
35	10.07	9.28	10.55	9.92	11.33	9.73	12.06	10.55	12.50	10.52	12.94	10.48	13.83	11.14		
37	9.90	9.19	10.38	9.84	11.13	9.65	11.83	10.46	12.24	10.42	12.66	10.38	13.50	11.02		
39	9.72	9.11	10.20	9.76	10.94	9.57	11.60	10.37	11.99	10.33	12.38	10.28	13.16	10.91		
41	9.55	9.02	10.02	9.68	10.75	9.49	11.37	10.28	11.73	10.23	12.09	10.17	12.82	10.80		
43	9.38	8.94	9.85	9.60	10.56	9.41	11.14	10.19	11.47	10.13	11.81	10.07	12.48	10.68		

(kW) Heat Mode:HC (kW)

Outdoor air temp.	Indoor air temperature					
	°CDB					
	°CDB	°CWB	16	18	20	22
-19.8	-20	7.06	7.03	7.00	6.97	6.95
-17.7	-18	7.46	7.43	7.41	7.37	7.34
-15.7	-16	7.87	7.84	7.81	7.77	7.74
-13.5	-14	8.33	8.29	8.26	8.22	8.18
-11.5	-12	8.78	8.74	8.70	8.66	8.62
-9.5	-10	9.24	9.19	9.15	9.11	9.06
-7.5	-8	9.69	9.65	9.60	9.55	9.50
-5.5	-6	9.91	9.86	9.81	9.75	9.70
-3.0	-4	10.12	10.07	10.01	9.96	9.90
-1.0	-2	10.33	10.28	10.22	10.16	10.10
1.0	0	10.55	10.49	10.43	10.36	10.30
2.0	1	10.65	10.59	10.53	10.47	10.40
3.0	2	11.36	11.29	11.22	11.18	11.13
5.0	4	12.76	12.69	12.61	12.60	12.58
7.0	6	14.16	14.08	14.00	14.02	14.04
9.0	8	14.72	14.64	14.56	14.52	14.49
11.5	10	15.28	15.20	15.11	15.02	14.93
13.5	12	16.13	16.04	15.94	15.82	15.75
15.5	14	16.98	16.88	16.77	16.62	16.58
16.5	16	17.41	17.30	17.19	17.02	16.99



Note(1) These data show average statuses.

Depending on the system control, there may be ranges where the operation is not conducted continuously.

These data show the case where the operation frequency of a compressor is fixed. (Cooling only)

(2) Capacities are based on the following conditions.

Corresponding refrigerant piping length :7.5m

Level difference of Zero.

(3) Symbols are as follows.

TC : Total cooling capacity (kW)

SHC : Sensible heat capacity (kW)

HC : Heating capacity (kW)

Model FDU140NVF Indoor unit FDU140VF Outdoor unit FDC140VN
Cool Mode

Outdoor air temp.	Indoor air temperature (kW)															
	18°CDB		21°CDB		23°CDB		26°CDB		27°CDB		28°CDB		31°CDB		33°CDB	
	12°CWB	14°CWB	16°CWB	18°CWB	19°CWB	20°CWB	22°CWB	24°CWB	TC	SHC	TC	SHC	TC	SHC	TC	SHC
°CDB	TC	SHC	TC	SHC	TC	SHC	TC	SHC	TC	SHC	TC	SHC	TC	SHC	TC	SHC
11					11.37	9.97	12.02	10.86	12.35	10.73	12.70	10.60	13.39	11.24	14.08	10.93
13					11.90	10.15	12.61	11.04	12.96	10.90	13.33	10.77	14.09	11.41	14.84	11.09
15					12.43	10.33	13.19	11.22	13.57	11.08	13.97	10.94	14.78	11.57	15.59	11.25
17					12.96	10.51	13.77	11.40	14.17	11.26	14.61	11.12	15.48	11.75	16.34	11.41
19					13.24	10.61	14.06	11.49	14.48	11.35	14.92	11.21	15.80	11.83	16.68	11.48
21					13.51	10.71	14.36	11.59	14.78	11.44	15.23	11.30	16.12	11.91	17.02	11.56
23					13.51	10.71	14.40	11.60	14.82	11.45	15.28	11.31	16.19	11.93	17.10	11.58
25			12.50	11.04	13.50	10.71	14.43	11.61	14.86	11.47	15.33	11.33	16.25	11.94	17.18	11.59
27			12.41	11.00	13.50	10.71	14.47	11.62	14.91	11.48	15.34	11.33	16.20	11.93		
29			12.32	10.97	13.29	10.63	14.23	11.54	14.68	11.41	15.13	11.27	16.02	11.88		
31			12.23	10.93	13.09	10.56	13.99	11.47	14.45	11.34	14.92	11.21	15.85	11.84		
33	11.51	10.16	12.01	10.85	12.89	10.49	13.75	11.39	14.23	11.28	14.71	11.15	15.67	11.79		
35	11.28	10.06	11.82	10.77	12.68	10.42	13.50	11.31	14.00	11.21	14.50	11.09	15.49	11.75		
37	11.08	9.98	11.62	10.70	12.47	10.34	13.25	11.23	13.71	11.12	14.18	11.00	15.12	11.66		
39	10.89	9.90	11.43	10.62	12.26	10.27	12.99	11.15	13.43	11.04	13.86	10.91	14.74	11.56		
41	10.70	9.82	11.23	10.55	12.04	10.20	12.73	11.07	13.14	10.95	13.55	10.83	14.36	11.47		
43	10.51	9.74	11.03	10.47	11.83	10.12	12.47	10.99	12.85	10.87	13.23	10.74	13.98	11.38		

Outdoor air temp.	Indoor air temperature (kW)					
	°CDB		°CDB			
	°CDB	°CWB	16	18	20	22
-19.8	-20	8.06	8.03	8.00	7.97	7.94
-17.7	-18	8.53	8.50	8.46	8.43	8.39
-15.7	-16	9.00	8.96	8.92	8.88	8.85
-13.5	-14	9.52	9.48	9.43	9.39	9.35
-11.5	-12	10.04	9.99	9.95	9.90	9.85
-9.5	-10	10.56	10.51	10.46	10.41	10.36
-7.5	-8	11.08	11.02	10.97	10.91	10.86
-5.5	-6	11.32	11.26	11.21	11.15	11.09
-3.0	-4	11.56	11.50	11.44	11.38	11.31
-1.0	-2	11.81	11.75	11.68	11.61	11.54
1.0	0	12.05	11.99	11.92	11.84	11.77
2.0	1	12.18	12.11	12.04	11.96	11.89
3.0	2	12.98	12.90	12.83	12.77	12.72
5.0	4	14.58	14.50	14.41	14.40	14.38
7.0	6	16.19	16.09	16.00	16.02	16.05
9.0	8	16.83	16.73	16.63	16.59	16.55
11.5	10	17.46	17.37	17.27	17.17	17.06
13.5	12	18.44	18.33	18.22	18.08	18.00
15.5	14	19.41	19.29	19.17	18.99	18.95
16.5	16	19.90	19.77	19.64	19.45	19.42

PJG000Z046

Model FDU140VSVF Indoor unit FDU140VF Outdoor unit FDC140VS
Cool Mode

Outdoor air temp.	Indoor air temperature (kW)															
	18°CDB		21°CDB		23°CDB		26°CDB		27°CDB		28°CDB		31°CDB		33°CDB	
	12°CWB	14°CWB	16°CWB	18°CWB	19°CWB	20°CWB	22°CWB	24°CWB	TC	SHC	TC	SHC	TC	SHC	TC	SHC
°CDB	TC	SHC	TC	SHC	TC	SHC	TC	SHC	TC	SHC	TC	SHC	TC	SHC	TC	SHC
11					11.37	9.97	12.02	10.86	12.35	10.73	12.70	10.60	13.39	11.24	14.08	10.93
13					11.90	10.15	12.61	11.04	12.96	10.90	13.33	10.77	14.09	11.41	14.84	11.09
15					12.43	10.33	13.19	11.22	13.57	11.08	13.97	10.94	14.78	11.57	15.59	11.25
17					12.96	10.51	13.77	11.40	14.17	11.26	14.61	11.12	15.48	11.75	16.34	11.41
19					13.24	10.61	14.06	11.49	14.48	11.35	14.92	11.21	15.80	11.83	16.68	11.48
21					13.51	10.71	14.36	11.59	14.78	11.44	15.23	11.30	16.12	11.91	17.02	11.56
23					13.51	10.71	14.40	11.60	14.82	11.45	15.28	11.31	16.19	11.93	17.10	11.58
25			12.50	11.04	13.50	10.71	14.43	11.61	14.86	11.47	15.33	11.33	16.25	11.94	17.18	11.59
27			12.41	11.00	13.50	10.71	14.47	11.62	14.91	11.48	15.34	11.33	16.20	11.93		
29			12.32	10.97	13.29	10.63	14.23	11.54	14.68	11.41	15.13	11.27	16.02	11.88		
31			12.23	10.93	13.09	10.56	13.99	11.47	14.45	11.34	14.92	11.21	15.85	11.84		
33	11.51	10.16	12.01	10.85	12.89	10.49	13.75	11.39	14.23	11.28	14.71	11.15	15.67	11.79		
35	11.28	10.06	11.82	10.77	12.68	10.42	13.50	11.31	14.00	11.21	14.50	11.09	15.49	11.75		
37	11.08	9.98	11.62	10.70	12.47	10.34	13.25	11.23	13.71	11.12	14.18	11.00	15.12	11.66		
39	10.89	9.90	11.43	10.62	12.26	10.27	12.99	11.15	13.43	11.04	13.86	10.91	14.74	11.56		
41	10.70	9.82	11.23	10.55	12.04	10.20	12.73	11.07	13.14	10.95	13.55	10.83	14.36	11.47		
43	10.51	9.74	11.03	10.47	11.83	10.12	12.47	10.99	12.85	10.87	13.23	10.74	13.98	11.38		

Outdoor air temp.	Indoor air temperature (kW)					
	°CDB		°CDB			
	°CDB	°CWB	16	18	20	22
-19.8	-20	8.06	8.03	8.00	7.97	7.94
-17.7	-18	8.53	8.50	8.46	8.43	8.39
-15.7	-16	9.00	8.96	8.92	8.88	8.85
-13.5	-14	9.52	9.48	9.43	9.39	9.35
-11.5	-12	10.04	9.99	9.95	9.90	9.85
-9.5	-10	10.56	10.51	10.46	10.41	10.36
-7.5	-8	11.08	11.02	10.97	10.91	10.86
-5.5	-6	11.32	11.26	11.21	11.15	11.09
-3.0	-4	11.56	11.50	11.44	11.38	11.31
-1.0	-2	11.81	11.75	11.68	11.61	11.54
1.0	0	12.05	11.99	11.92	11.84	11.77
2.0	1	12.18	12.11	12.04	11.96	11.89
3.0	2	12.98	12.90	12.83	12.77	12.72
5.0	4	14.58	14.50	14.41	14.40	14.38
7.0	6	16.19	16.09	16.00	16.02	16.05
9.0	8	16.83	16.73	16.63	16.59	16.55
11.5	10	17.46	17.37	17.27	17.17	17.06
13.5	12	18.44	18.33	18.22	18.08	18.00
15.5	14	19.41	19.29	19.17	18.99	18.95
16.5	16	19.90	19.77	19.64	19.45	19.42

PJG000Z046

Note(1) These data show average statuses.
Depending on the system control, there may be ranges where the operation is not conducted continuously.
These data show the case where the operation frequency of a compressor is fixed. (Cooling only)
(2) Capacities are based on the following conditions.
Corresponding refrigerant piping length :7.5m
Level difference of Zero.
(3) Symbols are as follows.
TC : Total cooling capacity (kW)
SHC : Sensible heat capacity (kW)
HC : Heating capacity (kW)

Model FDU200VSVF Indoor unit FDU200VF Outdoor unit FDC200VS
Cool Mode

Outdoor air temp.	Indoor air temperature															
	18 DB		21 DB		23 DB		26 DB		27 DB		28 DB		31 DB		33 DB	
	12 WB	14 WB	16 WB	18 WB	19 WB	20 WB	22 WB	24 WB	TC	SHC	TC	SHC	TC	SHC	TC	SHC
DB	TC	SHC	TC	SHC	TC	SHC	TC	SHC	TC	SHC	TC	SHC	TC	SHC	TC	SHC
11					17.37	13.32	18.41	14.29	18.94	14.16	19.50	14.03	20.63	14.73	21.76	14.40
13					17.90	13.54	18.99	14.51	19.54	14.38	20.13	14.25	21.31	14.95	22.49	14.62
15					18.43	13.77	19.57	14.74	20.14	14.61	20.75	14.48	21.98	15.17	23.21	14.83
17					18.96	13.99	20.14	14.97	20.73	14.83	21.38	14.71	22.66	15.40	23.94	15.05
19					19.35	14.16	20.56	15.14	21.16	15.00	21.81	14.86	23.12	15.55	24.42	15.20
21					19.41	14.19	20.98	15.30	21.59	15.16	22.25	15.03	23.57	15.70	24.89	15.34
23					19.31	14.15	20.86	15.26	21.47	15.12	22.12	14.98	23.43	15.65	24.73	15.29
25			17.35	14.15	19.20	14.10	20.74	15.21	21.35	15.07	21.99	14.93	23.28	15.60	24.57	15.24
27			17.28	14.12	19.10	14.05	20.62	15.16	21.22	15.02	21.83	14.87	23.04	15.52		
29			17.14	14.06	18.85	13.95	20.31	15.04	20.92	14.91	21.53	14.76	22.75	15.43		
31			16.99	13.99	18.59	13.84	20.00	14.91	20.61	14.79	21.22	14.65	22.45	15.33		
33	16.46	13.35	17.03	14.01	18.33	13.72	19.69	14.79	20.31	14.67	20.92	14.54	22.15	15.23		
35	16.14	13.20	16.76	13.88	18.08	13.62	19.38	14.67	20.00	14.56	20.62	14.43	21.85	15.13		
37	15.86	13.06	16.50	13.77	17.76	13.48	18.98	14.51	19.57	14.39	20.17	14.27	21.35	14.96		
39	15.59	12.93	16.23	13.64	17.44	13.35	18.58	14.36	19.15	14.24	19.71	14.11	20.85	14.80		
41	15.32	12.80	15.97	13.53	17.13	13.22	18.17	14.20	18.72	14.08	19.26	13.95	20.35	14.64		
43	15.04	12.66	15.70	13.41	16.81	13.09	17.77	14.04	18.29	13.92	18.81	13.79	19.85	14.48		

(kW) Heat Mode:HC (kW)

Outdoor air temp.		Indoor air temperature					
DB	WB	16	18	20	22	24	
-19.8	-20						
-17.7	-18						
-15.7	-16						
-13.5	-14	13.21	13.18	13.14	13.11	13.08	
-11.5	-12	13.91	13.87	13.83	13.79	13.76	
-9.5	-10	14.61	14.57	14.52	14.47	14.43	
-7.5	-8	15.31	15.26	15.21	15.16	15.10	
-5.5	-6	15.64	15.58	15.52	15.46	15.40	
-3.0	-4	15.96	15.89	15.82	15.76	15.69	
-1.0	-2	16.29	16.21	16.13	16.06	15.98	
1.0	0	16.61	16.53	16.44	16.36	16.28	
2.0	1	16.78	16.69	16.59	16.51	16.42	
3.0	2	17.96	17.86	17.76	17.66	17.56	
5.0	4	20.33	20.21	20.08	19.96	19.84	
7.0	6	22.71	22.55	22.40	22.26	22.12	
9.0	8	23.43	23.28	23.13	22.88	22.63	
11.5	10	24.14	24.00	23.86	23.50	23.13	
13.5	12	25.41	25.24	25.07	24.77	24.43	
15.5	14	26.67	26.47	26.27	26.05	25.72	
16.5	16	27.30	27.09	26.87	26.69	26.37	

PJD001Z325

Model FDU250VSVF Indoor unit FDU250VF Outdoor unit FDC250VS
Cool Mode

Outdoor air temp.	Indoor air temperature															
	18 DB		21 DB		23 DB		26 DB		27 DB		28 DB		31 DB		33 DB	
	12 WB	14 WB	16 WB	18 WB	19 WB	20 WB	22 WB	24 WB	TC	SHC	TC	SHC	TC	SHC	TC	SHC
DB	TC	SHC	TC	SHC	TC	SHC	TC	SHC	TC	SHC	TC	SHC	TC	SHC	TC	SHC
11					21.71	18.50	23.02	20.07	23.67	19.89	24.38	19.71	25.79	20.87	27.21	20.43
13					22.38	18.76	23.74	20.33	24.42	20.14	25.16	19.97	26.63	21.12	28.11	20.67
15					23.04	19.02	24.46	20.59	25.17	20.40	25.94	20.22	27.48	21.37	29.02	20.92
17					23.70	19.28	25.18	20.85	25.92	20.66	26.72	20.48	28.32	21.62	29.92	21.16
19					24.19	19.48	25.70	21.04	26.45	20.85	27.27	20.66	28.89	21.79	30.52	21.32
21					24.26	19.51	26.22	21.23	26.99	21.04	27.82	20.85	29.47	21.97	31.12	21.49
23					24.13	19.46	26.07	21.17	26.84	20.98	27.65	20.79	29.28	21.91	30.91	21.43
25			21.69	19.61	24.00	19.40	25.92	21.12	26.68	20.93	27.49	20.74	29.10	21.86	30.71	21.37
27			21.60	19.57	23.88	19.36	25.77	21.06	26.53	20.87	27.29	20.67	28.80	21.77		
29			21.42	19.49	23.56	19.23	25.39	20.92	26.15	20.74	26.91	20.54	28.43	21.66		
31			21.24	19.42	23.24	19.10	25.00	20.78	25.77	20.61	26.53	20.42	28.06	21.54		
33	20.58	18.31	21.29	19.44	22.92	18.98	24.61	20.64	25.38	20.47	26.15	20.29	27.69	21.43		
35	20.17	18.13	20.96	19.30	22.60	18.85	24.23	20.50	25.00	20.34	25.77	20.17	27.31	21.32		
37	19.83	17.97	20.62	19.15	22.20	18.69	23.73	20.32	24.47	20.16	25.21	19.98	26.69	21.13		
39	19.49	17.81	20.29	19.01	21.80	18.54	23.22	20.14	23.93	19.98	24.64	19.80	26.06	20.95		
41	19.15	17.66	19.96	18.88	21.41	18.39	22.72	19.96	23.40	19.80	24.08	19.62	25.43	20.76		
43	18.81	17.51	19.63	18.74	21.01	18.23	22.22	19.79	22.86	19.61	23.51	19.43	24.81	20.58		

(kW) Heat Mode:HC (kW)

Outdoor air temp.		Indoor air temperature					
DB	WB	16	18	20	22	24	
-19.8	-20						
-17.7	-18						
-15.7	-16						
-13.5	-14	16.52	16.47	16.43	16.39	16.35	
-11.5	-12	17.39	17.34	17.29	17.24	17.19	
-9.5	-10	18.26	18.21	18.15	18.09	18.04	
-7.5	-8	19.14	19.07	19.01	18.94	18.88	
-5.5	-6	19.55	19.47	19.40	19.32	19.24	
-3.0	-4	19.95	19.87	19.78	19.70	19.61	
-1.0	-2	20.36	20.26	20.17	20.07	19.98	
1.0	0	20.77	20.66	20.55	20.45	20.35	
2.0	1	20.97	20.86	20.74	20.64	20.53	
3.0	2	22.45	22.32	22.19	22.07	21.95	
5.0	4	25.42	25.26	25.10	24.95	24.80	
7.0	6	28.38	28.19	28.00	27.82	27.65	
9.0	8	29.28	29.10	28.91	28.60	28.28	
11.5	10	30.18	30.00	29.83	29.37	28.91	
13.5	12	31.76	31.55	31.33	30.97	30.53	
15.5	14	33.34	33.09	32.84	32.57	32.15	
16.5	16	34.13	33.86	33.59	33.37	32.96	

PJD001Z325

- Note(1) These data show average statuses.
Depending on the system control, there may be ranges where the operation is not conducted continuously.
These data show the case where the operation frequency of a compressor is fixed.
- (2) Capacities are based on the following conditions.
Corresponding refrigerant piping length : 7.5m
Level difference of Zero.
- (3) Symbols are as follows.
TC : Total cooling capacity (kW)
SHC : Sensible heat capacity (kW)
HC : Heating capacity (kW)

(5) Duct connected-Low / Middle static pressure type (FDUM)
(a) Single type

Model **FDUM100VNVF1, 100VNVF2** Indoor unit **FDUM100VF1** Outdoor unit **FDC100VN**
 Cooling Mode **100VF2** (kW) Heating Mode : **HC** (kW)

Outdoor air temp.	Indoor air temperature															
	18°CDB		21°CDB		23°CDB		26°CDB		27°CDB		28°CDB		31°CDB		33°CDB	
	12°CWB		14°CWB		16°CWB		18°CWB		19°CWB		20°CWB		22°CWB		24°CWB	
°CDB	TC	SHC	TC	SHC	TC	SHC	TC	SHC	TC	SHC	TC	SHC	TC	SHC	TC	SHC
11					8.12	6.88	8.59	7.50	8.82	7.38	9.07	7.26	9.56	7.69	10.06	7.42
13					8.50	6.99	9.00	7.61	9.26	7.48	9.52	7.36	10.06	7.78	10.60	7.49
15					8.88	7.10	9.42	7.71	9.69	7.58	9.98	7.45	10.56	7.87	11.14	7.57
17					9.26	7.21	9.84	7.82	10.12	7.69	10.43	7.56	11.05	7.96	11.67	7.65
19					9.46	7.27	10.05	7.88	10.34	7.74	10.65	7.60	11.29	8.01	11.92	7.69
21					9.65	7.33	10.25	7.93	10.56	7.80	10.88	7.66	11.52	8.06	12.16	7.73
23					9.65	7.33	10.28	7.94	10.59	7.80	10.91	7.66	11.56	8.06	12.21	7.74
25			8.93	7.64	9.64	7.33	10.31	7.95	10.62	7.81	10.95	7.67	11.61	8.07	12.27	7.75
27			8.86	7.62	9.64	7.33	10.34	7.95	10.65	7.82	10.96	7.68	11.57	8.06		
29			8.80	7.59	9.50	7.29	10.17	7.91	10.49	7.78	10.81	7.64	11.45	8.04		
31			8.73	7.57	9.35	7.24	9.99	7.86	10.32	7.74	10.66	7.61	11.32	8.02		
33	8.22	7.04	8.58	7.52	9.21	7.20	9.82	7.82	10.16	7.70	10.51	7.57	11.19	7.99		
35	8.05	6.98	8.44	7.47	9.06	7.15	9.64	7.77	10.00	7.66	10.36	7.54	11.07	7.97		
37	7.92	6.93	8.30	7.43	8.91	7.11	9.46	7.72	9.79	7.61	10.13	7.49	10.80	7.92		
39	7.78	6.88	8.16	7.38	8.75	7.06	9.28	7.68	9.59	7.56	9.90	7.44	10.53	7.87		
41	7.64	6.83	8.02	7.33	8.60	7.02	9.09	7.63	9.38	7.51	9.68	7.39	10.26	7.82		
43	7.50	6.77	7.88	7.29	8.45	6.97	8.91	7.58	9.18	7.46	9.45	7.34	9.99	7.77		

Outdoor air temp.		Indoor air temperature					
°CDB	°CWB	°CDB					
		16	18	20	22	24	
-19.8	-20	5.64	5.62	5.60	5.58	5.56	
-17.7	-18	5.97	5.95	5.92	5.90	5.87	
-15.7	-16	6.30	6.27	6.25	6.22	6.19	
-13.5	-14	6.66	6.63	6.60	6.57	6.54	
-11.5	-12	7.03	6.99	6.96	6.93	6.90	
-9.5	-10	7.39	7.36	7.32	7.29	7.25	
-7.5	-8	7.75	7.72	7.68	7.64	7.60	
-5.5	-6	7.92	7.88	7.85	7.80	7.76	
-3.0	-4	8.10	8.05	8.01	7.97	7.92	
-1.0	-2	8.27	8.22	8.18	8.13	8.08	
1.0	0	8.44	8.39	8.34	8.29	8.24	
2.0	1	8.52	8.47	8.42	8.37	8.32	
3.0	2	9.08	9.03	8.98	8.94	8.90	
5.0	4	10.21	10.15	10.09	10.08	10.07	
7.0	6	11.33	11.27	11.20	11.22	11.23	
9.0	8	11.78	11.71	11.64	11.62	11.59	
11.5	10	12.23	12.16	12.09	12.02	11.94	
13.5	12	12.91	12.83	12.75	12.65	12.60	
15.5	14	13.59	13.50	13.42	13.29	13.26	
16.5	16	13.93	13.84	13.75	13.61	13.59	

PJG000Z013

Model **FDUM100VSVF1, 100VSVF2** Indoor unit **FDUM100VF1** Outdoor unit **FDC100VS**
 Cooling Mode **100VF2** (kW) Heating Mode : **HC** (kW)

Outdoor air temp.	Indoor air temperature															
	18°CDB		21°CDB		23°CDB		26°CDB		27°CDB		28°CDB		31°CDB		33°CDB	
	12°CWB		14°CWB		16°CWB		18°CWB		19°CWB		20°CWB		22°CWB		24°CWB	
°CDB	TC	SHC	TC	SHC	TC	SHC	TC	SHC	TC	SHC	TC	SHC	TC	SHC	TC	SHC
11					8.12	6.88	8.59	7.50	8.82	7.38	9.07	7.26	9.56	7.69	10.06	7.42
13					8.50	6.99	9.00	7.61	9.26	7.48	9.52	7.36	10.06	7.78	10.60	7.49
15					8.88	7.10	9.42	7.71	9.69	7.58	9.98	7.45	10.56	7.87	11.14	7.57
17					9.26	7.21	9.84	7.82	10.12	7.69	10.43	7.56	11.05	7.96	11.67	7.65
19					9.46	7.27	10.05	7.88	10.34	7.74	10.65	7.60	11.29	8.01	11.92	7.69
21					9.65	7.33	10.25	7.93	10.56	7.80	10.88	7.66	11.52	8.06	12.16	7.73
23					9.65	7.33	10.28	7.94	10.59	7.80	10.91	7.66	11.56	8.06	12.21	7.74
25			8.93	7.64	9.64	7.33	10.31	7.95	10.62	7.81	10.95	7.67	11.61	8.07	12.27	7.75
27			8.86	7.62	9.64	7.33	10.34	7.95	10.65	7.82	10.96	7.68	11.57	8.06		
29			8.80	7.59	9.50	7.29	10.17	7.91	10.49	7.78	10.81	7.64	11.45	8.04		
31			8.73	7.57	9.35	7.24	9.99	7.86	10.32	7.74	10.66	7.61	11.32	8.02		
33	8.22	7.04	8.58	7.52	9.21	7.20	9.82	7.82	10.16	7.70	10.51	7.57	11.19	7.99		
35	8.05	6.98	8.44	7.47	9.06	7.15	9.64	7.77	10.00	7.66	10.36	7.54	11.07	7.97		
37	7.92	6.93	8.30	7.43	8.91	7.11	9.46	7.72	9.79	7.61	10.13	7.49	10.80	7.92		
39	7.78	6.88	8.16	7.38	8.75	7.06	9.28	7.68	9.59	7.56	9.90	7.44	10.53	7.87		
41	7.64	6.83	8.02	7.33	8.60	7.02	9.09	7.63	9.38	7.51	9.68	7.39	10.26	7.82		
43	7.50	6.77	7.88	7.29	8.45	6.97	8.91	7.58	9.18	7.46	9.45	7.34	9.99	7.77		

Outdoor air temp.		Indoor air temperature					
°CDB	°CWB	°CDB					
		16	18	20	22	24	
-19.8	-20	5.64	5.62	5.60	5.58	5.56	
-17.7	-18	5.97	5.95	5.92	5.90	5.87	
-15.7	-16	6.30	6.27	6.25	6.22	6.19	
-13.5	-14	6.66	6.63	6.60	6.57	6.54	
-11.5	-12	7.03	6.99	6.96	6.93	6.90	
-9.5	-10	7.39	7.36	7.32	7.29	7.25	
-7.5	-8	7.75	7.72	7.68	7.64	7.60	
-5.5	-6	7.92	7.88	7.85	7.80	7.76	
-3.0	-4	8.10	8.05	8.01	7.97	7.92	
-1.0	-2	8.27	8.22	8.18	8.13	8.08	
1.0	0	8.44	8.39	8.34	8.29	8.24	
2.0	1	8.52	8.47	8.42	8.37	8.32	
3.0	2	9.08	9.03	8.98	8.94	8.90	
5.0	4	10.21	10.15	10.09	10.08	10.07	
7.0	6	11.33	11.27	11.20	11.22	11.23	
9.0	8	11.78	11.71	11.64	11.62	11.59	
11.5	10	12.23	12.16	12.09	12.02	11.94	
13.5	12	12.91	12.83	12.75	12.65	12.60	
15.5	14	13.59	13.50	13.42	13.29	13.26	
16.5	16	13.93	13.84	13.75	13.61	13.59	

PJG000Z013

- Note(1) These data show average statuses.
 Depending on the system control, there may be ranges where the operation is not conducted continuously.
 These data show the case where the operation frequency of a compressor is fixed.
- (2) Capacities are based on the following conditions.
 Corresponding refrigerant piping length : 7.5m
 Level difference of Zero.
- (3) Symbols are as follows.
 TC : Total cooling capacity (kW)
 SHC : Sensible heat capacity (kW)
 HC : Heating capacity (kW)

Model FDUM125VNVF Indoor unit FDUM125VF Outdoor unit FDC125VN
Cooling Mode

Outdoor air temp.	Indoor air temperature (kW)															
	18°CDB		21°CDB		23°CDB		26°CDB		27°CDB		28°CDB		31°CDB		33°CDB	
	12°CWB	14°CWB	16°CWB	18°CWB	19°CWB	20°CWB	22°CWB	24°CWB	TC	SHC	TC	SHC	TC	SHC	TC	SHC
11					10.15	9.23	10.74	10.04	11.03	9.97	11.34	9.90	11.96	10.51	12.57	10.34
13					10.63	9.44	11.26	10.24	11.57	10.17	11.91	10.11	12.58	10.72	13.25	10.55
15					11.10	9.63	11.78	10.44	12.11	10.37	12.47	10.31	13.20	10.92	13.92	10.75
17					11.58	9.84	12.29	10.64	12.65	10.58	13.04	10.52	13.82	11.13	14.59	10.96
19					11.82	9.94	12.56	10.75	12.92	10.68	13.32	10.62	14.11	11.23	14.90	11.06
21					12.06	10.04	12.82	10.86	13.19	10.79	13.60	10.73	14.40	11.33	15.20	11.15
23					12.06	10.04	12.85	10.87	13.23	10.80	13.64	10.74	14.45	11.35	15.27	11.17
25			11.16	10.20	12.06	10.04	12.89	10.88	13.27	10.82	13.68	10.76	14.51	11.37	15.34	11.20
27			11.08	10.16	12.05	10.04	12.92	10.90	13.31	10.83	13.69	10.76	14.47	11.35		
29			11.00	10.12	11.87	9.96	12.71	10.81	13.11	10.76	13.51	10.69	14.31	11.30		
31			10.92	10.09	11.69	9.88	12.49	10.72	12.90	10.67	13.32	10.62	14.15	11.24		
33	10.27	9.37	10.72	9.99	11.51	9.81	12.27	10.64	12.70	10.60	13.13	10.55	13.99	11.19		
35	10.07	9.28	10.55	9.92	11.33	9.73	12.06	10.55	12.50	10.52	12.94	10.48	13.83	11.14		
37	9.90	9.19	10.38	9.84	11.13	9.65	11.83	10.46	12.24	10.42	12.66	10.38	13.50	11.02		
39	9.72	9.11	10.20	9.76	10.94	9.57	11.60	10.37	11.99	10.33	12.38	10.28	13.16	10.91		
41	9.55	9.02	10.02	9.68	10.75	9.49	11.37	10.28	11.73	10.23	12.09	10.17	12.82	10.80		
43	9.38	8.94	9.85	9.60	10.56	9.41	11.14	10.19	11.47	10.13	11.81	10.07	12.48	10.68		

Heating Mode : HC (kW)

Outdoor air temp.	Indoor air temperature (kW)					
	°CDB		°CWB		°CDB	
	16	18	20	22	24	24
-19.8	-20	7.06	7.03	7.00	6.97	6.95
-17.7	-18	7.46	7.43	7.41	7.37	7.34
-15.7	-16	7.87	7.84	7.81	7.77	7.74
-13.5	-14	8.33	8.29	8.26	8.22	8.18
-11.5	-12	8.78	8.74	8.70	8.66	8.62
-9.5	-10	9.24	9.19	9.15	9.11	9.06
-7.5	-8	9.69	9.65	9.60	9.55	9.50
-5.5	-6	9.91	9.86	9.81	9.75	9.70
-3.0	-4	10.12	10.07	10.01	9.96	9.90
-1.0	-2	10.33	10.28	10.22	10.16	10.10
1.0	0	10.55	10.49	10.43	10.36	10.30
2.0	1	10.65	10.59	10.53	10.47	10.40
3.0	2	11.36	11.29	11.22	11.18	11.13
5.0	4	12.76	12.69	12.61	12.60	12.58
7.0	6	14.16	14.08	14.00	14.02	14.04
9.0	8	14.72	14.64	14.56	14.52	14.49
11.5	10	15.28	15.20	15.11	15.02	14.93
13.5	12	16.13	16.04	15.94	15.82	15.75
15.5	14	16.98	16.88	16.77	16.62	16.58
16.5	16	17.41	17.30	17.19	17.02	16.99

PJG000Z013

Model FDUM125VSVF Indoor unit FDUM125VF Outdoor unit FDC125VS
Cooling Mode

Outdoor air temp.	Indoor air temperature (kW)															
	18°CDB		21°CDB		23°CDB		26°CDB		27°CDB		28°CDB		31°CDB		33°CDB	
	12°CWB	14°CWB	16°CWB	18°CWB	19°CWB	20°CWB	22°CWB	24°CWB	TC	SHC	TC	SHC	TC	SHC	TC	SHC
11					10.15	9.23	10.74	10.04	11.03	9.97	11.34	9.90	11.96	10.51	12.57	10.34
13					10.63	9.44	11.26	10.24	11.57	10.17	11.91	10.11	12.58	10.72	13.25	10.55
15					11.10	9.63	11.78	10.44	12.11	10.37	12.47	10.31	13.20	10.92	13.92	10.75
17					11.58	9.84	12.29	10.64	12.65	10.58	13.04	10.52	13.82	11.13	14.59	10.96
19					11.82	9.94	12.56	10.75	12.92	10.68	13.32	10.62	14.11	11.23	14.90	11.06
21					12.06	10.04	12.82	10.86	13.19	10.79	13.60	10.73	14.40	11.33	15.20	11.15
23					12.06	10.04	12.85	10.87	13.23	10.80	13.64	10.74	14.45	11.35	15.27	11.17
25			11.16	10.20	12.06	10.04	12.89	10.88	13.27	10.82	13.68	10.76	14.51	11.37	15.34	11.20
27			11.08	10.16	12.05	10.04	12.92	10.90	13.31	10.83	13.69	10.76	14.47	11.35		
29			11.00	10.12	11.87	9.96	12.71	10.81	13.11	10.76	13.51	10.69	14.31	11.30		
31			10.92	10.09	11.69	9.88	12.49	10.72	12.90	10.67	13.32	10.62	14.15	11.24		
33	10.27	9.37	10.72	9.99	11.51	9.81	12.27	10.64	12.70	10.60	13.13	10.55	13.99	11.19		
35	10.07	9.28	10.55	9.92	11.33	9.73	12.06	10.55	12.50	10.52	12.94	10.48	13.83	11.14		
37	9.90	9.19	10.38	9.84	11.13	9.65	11.83	10.46	12.24	10.42	12.66	10.38	13.50	11.02		
39	9.72	9.11	10.20	9.76	10.94	9.57	11.60	10.37	11.99	10.33	12.38	10.28	13.16	10.91		
41	9.55	9.02	10.02	9.68	10.75	9.49	11.37	10.28	11.73	10.23	12.09	10.17	12.82	10.80		
43	9.38	8.94	9.85	9.60	10.56	9.41	11.14	10.19	11.47	10.13	11.81	10.07	12.48	10.68		

Heating Mode : HC (kW)

Outdoor air temp.	Indoor air temperature (kW)					
	°CDB		°CWB		°CDB	
	16	18	20	22	24	24
-19.8	-20	7.06	7.03	7.00	6.97	6.95
-17.7	-18	7.46	7.43	7.41	7.37	7.34
-15.7	-16	7.87	7.84	7.81	7.77	7.74
-13.5	-14	8.33	8.29	8.26	8.22	8.18
-11.5	-12	8.78	8.74	8.70	8.66	8.62
-9.5	-10	9.24	9.19	9.15	9.11	9.06
-7.5	-8	9.69	9.65	9.60	9.55	9.50
-5.5	-6	9.91	9.86	9.81	9.75	9.70
-3.0	-4	10.12	10.07	10.01	9.96	9.90
-1.0	-2	10.33	10.28	10.22	10.16	10.10
1.0	0	10.55	10.49	10.43	10.36	10.30
2.0	1	10.65	10.59	10.53	10.47	10.40
3.0	2	11.36	11.29	11.22	11.18	11.13
5.0	4	12.76	12.69	12.61	12.60	12.58
7.0	6	14.16	14.08	14.00	14.02	14.04
9.0	8	14.72	14.64	14.56	14.52	14.49
11.5	10	15.28	15.20	15.11	15.02	14.93
13.5	12	16.13	16.04	15.94	15.82	15.75
15.5	14	16.98	16.88	16.77	16.62	16.58
16.5	16	17.41	17.30	17.19	17.02	16.99

PJG000Z013

Note(1) These data show average statuses.
Depending on the system control, there may be ranges where the operation is not conducted continuously.
These data show the case where the operation frequency of a compressor is fixed.
(2) Capacities are based on the following conditions.
Corresponding refrigerant piping length : 7.5m
Level difference of Zero.
(3) Symbols are as follows.
TC : Total cooling capacity (kW)
SHC : Sensible heat capacity (kW)
HC : Heating capacity (kW)

Model FDUM140VNVF Indoor unit FDUM140VF Outdoor unit FDC140VN
 Cooling Mode (kW)

Outdoor air temp.	Indoor air temperature															
	18°CDB		21°CDB		23°CDB		26°CDB		27°CDB		28°CDB		31°CDB		33°CDB	
	12°CWB	14°CWB	16°CWB	18°CWB	19°CWB	20°CWB	22°CWB	24°CWB	TC	SHC	TC	SHC	TC	SHC	TC	SHC
11					11.37	9.97	12.02	10.86	12.35	10.73	12.70	10.60	13.39	11.24	14.08	10.93
13					11.90	10.15	12.61	11.04	12.96	10.90	13.33	10.77	14.09	11.41	14.84	11.09
15					12.43	10.33	13.19	11.22	13.57	11.08	13.97	10.94	14.78	11.57	15.59	11.25
17					12.96	10.51	13.77	11.40	14.17	11.26	14.61	11.12	15.48	11.75	16.34	11.41
19					13.24	10.61	14.06	11.49	14.48	11.35	14.92	11.21	15.80	11.83	16.68	11.48
21					13.51	10.71	14.36	11.59	14.78	11.44	15.23	11.30	16.12	11.91	17.02	11.56
23					13.51	10.71	14.40	11.60	14.82	11.45	15.28	11.31	16.19	11.93	17.10	11.58
25			12.50	11.04	13.50	10.71	14.43	11.61	14.86	11.47	15.33	11.33	16.25	11.94	17.18	11.59
27			12.41	11.00	13.50	10.71	14.47	11.62	14.91	11.48	15.34	11.33	16.20	11.93		
29			12.32	10.97	13.29	10.63	14.23	11.54	14.68	11.41	15.13	11.27	16.02	11.88		
31			12.23	10.93	13.09	10.56	13.99	11.47	14.45	11.34	14.92	11.21	15.85	11.84		
33	11.51	10.16	12.01	10.85	12.89	10.49	13.75	11.39	14.23	11.28	14.71	11.15	15.67	11.79		
35	11.28	10.06	11.82	10.77	12.68	10.42	13.50	11.31	14.00	11.21	14.50	11.09	15.49	11.75		
37	11.08	9.98	11.62	10.70	12.47	10.34	13.25	11.23	13.71	11.12	14.18	11.00	15.12	11.66		
39	10.89	9.90	11.43	10.62	12.26	10.27	12.99	11.15	13.43	11.04	13.86	10.91	14.74	11.56		
41	10.70	9.82	11.23	10.55	12.04	10.20	12.73	11.07	13.14	10.95	13.55	10.83	14.36	11.47		
43	10.51	9.74	11.03	10.47	11.83	10.12	12.47	10.99	12.85	10.87	13.23	10.74	13.98	11.38		

Heating Mode : HC (kW)

Outdoor air temp.	Indoor air temperature					
	°CDB					
	°CDB	°CWB	16	18	20	22
-19.8	-20	8.06	8.03	8.00	7.97	7.94
-17.7	-18	8.53	8.50	8.46	8.43	8.39
-15.7	-16	9.00	8.96	8.92	8.88	8.85
-13.5	-14	9.52	9.48	9.43	9.39	9.35
-11.5	-12	10.04	9.99	9.95	9.90	9.85
-9.5	-10	10.56	10.51	10.46	10.41	10.36
-7.5	-8	11.08	11.02	10.97	10.91	10.86
-5.5	-6	11.32	11.26	11.21	11.15	11.09
-3.0	-4	11.56	11.50	11.44	11.38	11.31
-1.0	-2	11.81	11.75	11.68	11.61	11.54
1.0	0	12.05	11.99	11.92	11.84	11.77
2.0	1	12.18	12.11	12.04	11.96	11.89
3.0	2	12.98	12.90	12.83	12.77	12.72
5.0	4	14.58	14.50	14.41	14.40	14.38
7.0	6	16.19	16.09	16.00	16.02	16.05
9.0	8	16.83	16.73	16.63	16.59	16.55
11.5	10	17.46	17.37	17.27	17.17	17.06
13.5	12	18.44	18.33	18.22	18.08	18.00
15.5	14	19.41	19.29	19.17	18.99	18.95
16.5	16	19.90	19.77	19.64	19.45	19.42

PJG000Z013

Model FDUM140VSVF Indoor unit FDUM140VF Outdoor unit FDC140VS
 Cooling Mode (kW)

Outdoor air temp.	Indoor air temperature															
	18°CDB		21°CDB		23°CDB		26°CDB		27°CDB		28°CDB		31°CDB		33°CDB	
	12°CWB	14°CWB	16°CWB	18°CWB	19°CWB	20°CWB	22°CWB	24°CWB	TC	SHC	TC	SHC	TC	SHC	TC	SHC
11					11.37	9.97	12.02	10.86	12.35	10.73	12.70	10.60	13.39	11.24	14.08	10.93
13					11.90	10.15	12.61	11.04	12.96	10.90	13.33	10.77	14.09	11.41	14.84	11.09
15					12.43	10.33	13.19	11.22	13.57	11.08	13.97	10.94	14.78	11.57	15.59	11.25
17					12.96	10.51	13.77	11.40	14.17	11.26	14.61	11.12	15.48	11.83	16.34	11.41
19					13.24	10.61	14.06	11.49	14.48	11.35	14.92	11.21	15.80	11.85	16.68	11.48
21					13.51	10.71	14.36	11.59	14.78	11.44	15.23	11.30	16.12	11.91	17.02	11.56
23					13.51	10.71	14.40	11.60	14.82	11.45	15.28	11.31	16.19	11.93	17.10	11.58
25			12.50	11.04	13.50	10.71	14.43	11.61	14.86	11.47	15.33	11.33	16.25	11.94	17.18	11.59
27			12.41	11.00	13.50	10.71	14.47	11.62	14.91	11.48	15.34	11.33	16.20	11.93		
29			12.32	10.97	13.29	10.63	14.23	11.54	14.68	11.41	15.13	11.27	16.02	11.88		
31			12.23	10.93	13.09	10.56	13.99	11.47	14.45	11.34	14.92	11.21	15.85	11.84		
33	11.51	10.16	12.01	10.85	12.89	10.49	13.75	11.39	14.23	11.28	14.71	11.15	15.67	11.79		
35	11.28	10.06	11.82	10.77	12.68	10.42	13.50	11.31	14.00	11.21	14.50	11.09	15.49	11.75		
37	11.08	9.98	11.62	10.70	12.47	10.34	13.25	11.23	13.71	11.12	14.18	11.00	15.12	11.66		
39	10.89	9.90	11.43	10.62	12.26	10.27	12.99	11.15	13.43	11.04	13.86	10.91	14.74	11.56		
41	10.70	9.82	11.23	10.55	12.04	10.20	12.73	11.07	13.14	10.95	13.55	10.83	14.36	11.47		
43	10.51	9.74	11.03	10.47	11.83	10.12	12.47	10.99	12.85	10.87	13.23	10.74	13.98	11.38		

Heating Mode : HC (kW)

Outdoor air temp.	Indoor air temperature					
	°CDB					
	°CDB	°CWB	16	18	20	22
-19.8	-20	8.06	8.03	8.00	7.97	7.94
-17.7	-18	8.53	8.50	8.46	8.43	8.39
-15.7	-16	9.00	8.96	8.92	8.88	8.85
-13.5	-14	9.52	9.48	9.43	9.39	9.35
-11.5	-12	10.04	9.99	9.95	9.90	9.85
-9.5	-10	10.56	10.51	10.46	10.41	10.36
-7.5	-8	11.08	11.02	10.97	10.91	10.86
-5.5	-6	11.32	11.26	11.21	11.15	11.09
-3.0	-4	11.56	11.50	11.44	11.38	11.31
-1.0	-2	11.81	11.75	11.68	11.61	11.54
1.0	0	12.05	11.99	11.92	11.84	11.77
2.0	1	12.18	12.11	12.04	11.96	11.89
3.0	2	12.98	12.90	12.83	12.77	12.72
5.0	4	14.58	14.50	14.41	14.40	14.38
7.0	6	16.19	16.09	16.00	16.02	16.05
9.0	8	16.83	16.73	16.63	16.59	16.55
11.5	10	17.46	17.37	17.27	17.17	17.06
13.5	12	18.44	18.33	18.22	18.08	18.00
15.5	14	19.41	19.29	19.17	18.99	18.95
16.5	16	19.90	19.77	19.64	19.45	19.42

PJG000Z013

Note(1) These data show average statuses.
 Depending on the system control, there may be ranges where the operation is not conducted continuously.
 These data show the case where the operation frequency of a compressor is fixed.
 (2) Capacities are based on the following conditions.
 Corresponding refrigerant piping length : 7.5m
 Level difference of Zero.
 (3) Symbols are as follows.
 TC : Total cooling capacity (kW)
 SHC : Sensible heat capacity (kW)
 HC : Heating capacity (kW)

(b) Twin type

Model **FDUM100VNPVF** Indoor unit FDUM50VF (2 units) Outdoor unit FDC100VN
 Cooling Mode (kW)

Outdoor air temp.	Indoor air temperature															
	18°CDB		21°CDB		23°CDB		26°CDB		27°CDB		28°CDB		31°CDB		33°CDB	
	12°CWB	14°CWB	16°CWB		18°CWB		19°CWB		20°CWB		22°CWB		24°CWB			
°CDB	TC	SHC	TC	SHC	TC	SHC	TC	SHC	TC	SHC	TC	SHC	TC	SHC	TC	SHC
11					8.12	6.73	8.59	7.25	8.82	7.20	9.07	7.15	9.56	7.54	10.06	7.41
13					8.50	6.90	9.00	7.42	9.26	7.37	9.52	7.32	10.06	7.71	10.60	7.58
15					8.88	7.06	9.42	7.59	9.69	7.54	9.98	7.49	10.56	7.89	11.14	7.76
17					9.26	7.23	9.84	7.77	10.12	7.71	10.43	7.67	11.05	8.06	11.67	7.93
19					9.64	7.32	10.05	7.85	10.34	7.80	10.65	7.75	11.29	8.15	11.92	8.01
21					9.65	7.41	10.25	7.94	10.56	7.89	10.88	7.84	11.52	8.23	12.16	8.09
23					9.65	7.41	10.28	7.95	10.59	7.90	10.91	7.85	11.56	8.24	12.21	8.11
25			8.93	7.50	9.64	7.40	10.31	7.96	10.62	7.91	10.95	7.87	11.61	8.26	12.27	8.13
27			8.86	7.47	9.64	7.40	10.34	7.98	10.65	7.93	10.96	7.87	11.57	8.25		
29			8.80	7.44	9.50	7.34	10.17	7.90	10.49	7.86	10.81	7.81	11.45	8.20		
31			8.73	7.40	9.35	7.27	9.99	7.83	10.32	7.79	10.66	7.76	11.32	8.16		
33	8.22	6.94	8.58	7.33	9.21	7.21	9.82	7.76	10.16	7.73	10.51	7.70	11.19	8.11		
35	8.05	6.85	8.44	7.27	9.06	7.14	9.64	7.68	10.00	7.66	10.36	7.64	11.07	8.07		
37	7.92	6.78	8.30	7.20	8.91	7.08	9.46	7.61	9.79	7.58	10.13	7.55	10.80	7.97		
39	7.78	6.71	8.16	7.13	8.75	7.00	9.28	7.53	9.59	7.50	9.90	7.46	10.53	7.88		
41	7.64	6.64	8.02	7.07	8.60	6.94	9.09	7.46	9.38	7.42	9.68	7.38	10.26	7.78		
43	7.50	6.57	7.88	7.00	8.45	6.87	8.91	7.38	9.18	7.34	9.45	7.29	9.99	7.69		

Heating Mode : HC (kW)

Outdoor air temp.	Indoor air temperature					
	°CDB		°CDB			
	°CDB	°CWB	16	18	20	22
-19.8	-20	5.64	5.62	5.60	5.58	5.56
-17.7	-18	5.97	5.95	5.92	5.90	5.87
-15.7	-16	6.30	6.27	6.25	6.22	6.19
-13.5	-14	6.66	6.63	6.60	6.57	6.54
-11.5	-12	7.03	6.99	6.96	6.93	6.90
-9.5	-10	7.39	7.36	7.32	7.29	7.25
-7.5	-8	7.75	7.72	7.68	7.64	7.60
-5.5	-6	7.92	7.88	7.85	7.80	7.76
-3.0	-4	8.10	8.05	8.01	7.97	7.92
-1.0	-2	8.27	8.22	8.18	8.13	8.08
1.0	0	8.44	8.39	8.34	8.29	8.24
2.0	1	8.52	8.47	8.42	8.37	8.32
3.0	2	9.08	9.03	8.98	8.94	8.90
5.0	4	10.21	10.15	10.09	10.08	10.07
7.0	6	11.33	11.27	11.20	11.22	11.23
9.0	8	11.78	11.71	11.64	11.62	11.59
11.5	10	12.23	12.16	12.09	12.02	11.94
13.5	12	12.91	12.83	12.75	12.65	12.60
15.5	14	13.59	13.50	13.42	13.29	13.26
16.5	16	13.93	13.84	13.75	13.61	13.59

PJG000Z013

Model **FDUM100VSPVF** Indoor unit FDUM50VF (2 units) Outdoor unit FDC100VS
 Cooling Mode (kW)

Outdoor air temp.	Indoor air temperature															
	18°CDB		21°CDB		23°CDB		26°CDB		27°CDB		28°CDB		31°CDB		33°CDB	
	12°CWB	14°CWB	16°CWB		18°CWB		19°CWB		20°CWB		22°CWB		24°CWB			
°CDB	TC	SHC	TC	SHC	TC	SHC	TC	SHC	TC	SHC	TC	SHC	TC	SHC	TC	SHC
11					8.12	6.73	8.59	7.25	8.82	7.20	9.07	7.15	9.56	7.54	10.06	7.41
13					8.50	6.90	9.00	7.42	9.26	7.37	9.52	7.32	10.06	7.71	10.60	7.58
15					8.88	7.06	9.42	7.59	9.69	7.54	9.98	7.49	10.56	7.89	11.14	7.76
17					9.26	7.23	9.84	7.77	10.12	7.71	10.43	7.67	11.05	8.06	11.67	7.93
19					9.64	7.32	10.05	7.85	10.34	7.80	10.65	7.75	11.29	8.15	11.92	8.01
21					9.65	7.41	10.25	7.94	10.56	7.89	10.88	7.84	11.52	8.23	12.16	8.09
23					9.65	7.41	10.28	7.95	10.59	7.90	10.91	7.85	11.56	8.24	12.21	8.11
25			8.93	7.50	9.64	7.40	10.31	7.96	10.62	7.91	10.95	7.87	11.61	8.26	12.27	8.13
27			8.86	7.47	9.64	7.40	10.34	7.98	10.65	7.93	10.96	7.87	11.57	8.25		
29			8.80	7.44	9.50	7.34	10.17	7.90	10.49	7.86	10.81	7.81	11.45	8.20		
31			8.73	7.40	9.35	7.27	9.99	7.83	10.32	7.79	10.66	7.76	11.32	8.16		
33	8.22	6.94	8.58	7.33	9.21	7.21	9.82	7.76	10.16	7.73	10.51	7.70	11.19	8.11		
35	8.05	6.85	8.44	7.27	9.06	7.14	9.64	7.68	10.00	7.66	10.36	7.64	11.07	8.07		
37	7.92	6.78	8.30	7.20	8.91	7.08	9.46	7.61	9.79	7.58	10.13	7.55	10.80	7.97		
39	7.78	6.71	8.16	7.13	8.75	7.00	9.28	7.53	9.59	7.50	9.90	7.46	10.53	7.88		
41	7.64	6.64	8.02	7.07	8.60	6.94	9.09	7.46	9.38	7.42	9.68	7.38	10.26	7.78		
43	7.50	6.57	7.88	7.00	8.45	6.87	8.91	7.38	9.18	7.34	9.45	7.29	9.99	7.69		

Heating Mode : HC (kW)

Outdoor air temp.	Indoor air temperature					
	°CDB		°CDB			
	°CDB	°CWB	16	18	20	22
-19.8	-20	5.64	5.62	5.60	5.58	5.56
-17.7	-18	5.97	5.95	5.92	5.90	5.87
-15.7	-16	6.30	6.27	6.25	6.22	6.19
-13.5	-14	6.66	6.63	6.60	6.57	6.54
-11.5	-12	7.03	6.99	6.96	6.93	6.90
-9.5	-10	7.39	7.36	7.32	7.29	7.25
-7.5	-8	7.75	7.72	7.68	7.64	7.60
-5.5	-6	7.92	7.88	7.85	7.80	7.76
-3.0	-4	8.10	8.05	8.01	7.97	7.92
-1.0	-2	8.27	8.22	8.18	8.13	8.08
1.0	0	8.44	8.39	8.34	8.29	8.24
2.0	1	8.52	8.47	8.42	8.37	8.32
3.0	2	9.08	9.03	8.98	8.94	8.90
5.0	4	10.21	10.15	10.09	10.08	10.07
7.0	6	11.33	11.27	11.20	11.22	11.23
9.0	8	11.78	11.71	11.64	11.62	11.59
11.5	10	12.23	12.16	12.09	12.02	11.94
13.5	12	12.91	12.83	12.75	12.65	12.60
15.5	14	13.59	13.50	13.42	13.29	13.26
16.5	16	13.93	13.84	13.75	13.61	13.59

PJG000Z013

- Note(1) These data show average statuses.
 Depending on the system control, there may be ranges where the operation is not conducted continuously.
 These data show the case where the operation frequency of a compressor is fixed.
 (2) Capacities are based on the following conditions.
 Corresponding refrigerant piping length : 7.5m
 Level difference of Zero.
 (3) Symbols are as follows.
 TC : Total cooling capacity (kW)
 SHC : Sensible heat capacity (kW)
 HC : Heating capacity (kW)

Model **FDUM125VNPVF** Indoor unit **FDUM60VF (2 units)** Outdoor unit **FDC125VN**
 Cooling Mode

Outdoor air temp. °CDB	Indoor air temperature (kW)															
	18°CDB		21°CDB		23°CDB		26°CDB		27°CDB		28°CDB		31°CDB		33°CDB	
	TC	SHC	TC	SHC	TC	SHC	TC	SHC	TC	SHC	TC	SHC	TC	SHC	TC	SHC
11					10.15	8.91	10.74	9.69	11.03	9.59	11.34	9.50	11.96	10.07	12.57	9.84
13					10.63	9.09	11.26	9.87	11.57	9.77	11.91	9.68	12.58	10.25	13.25	10.02
15					11.10	9.27	11.78	10.05	12.11	9.95	12.47	9.86	13.20	10.42	13.92	10.19
17					11.58	9.46	12.29	10.23	12.65	10.13	13.04	10.04	13.82	10.60	14.59	10.36
19					11.82	9.55	12.56	10.33	12.92	10.23	13.32	10.13	14.11	10.69	14.90	10.45
21					12.06	9.65	12.82	10.42	13.19	10.32	13.60	10.22	14.40	10.77	15.20	10.52
23					12.06	9.65	12.85	10.43	13.23	10.33	13.64	10.24	14.45	10.79	15.27	10.54
25			11.16	9.87	12.06	9.65	12.89	10.44	13.27	10.35	13.68	10.25	14.51	10.81	15.34	10.56
27			11.08	9.84	12.05	9.64	12.92	10.46	13.31	10.36	13.69	10.25	14.47	10.80		
29			11.00	9.80	11.87	9.57	12.71	10.38	13.11	10.29	13.51	10.19	14.31	10.75		
31			10.92	9.77	11.69	9.50	12.49	10.30	12.90	10.22	13.32	10.13	14.15	10.70		
33	10.27	9.09	10.72	9.68	11.51	9.43	12.27	10.22	12.70	10.15	13.13	10.07	13.99	10.65		
35	10.07	9.00	10.55	9.61	11.33	9.36	12.06	10.15	12.50	10.08	12.94	10.01	13.83	10.61		
37	9.90	8.92	10.38	9.54	11.13	9.29	11.83	10.07	12.24	9.99	12.66	9.92	13.50	10.51		
39	9.72	8.84	10.20	9.47	10.94	9.21	11.60	9.99	11.99	9.91	12.38	9.83	13.16	10.41		
41	9.55	8.76	10.02	9.39	10.75	9.14	11.37	9.91	11.73	9.82	12.09	9.74	12.82	10.31		
43	9.38	8.69	9.85	9.32	10.56	9.07	11.14	9.83	11.47	9.74	11.81	9.65	12.48	10.22		

Heating Mode : HC (kW)

Outdoor air temp.		Indoor air temperature °CDB					
°CDB	°CWB	16	18	20	22	24	
-19.8	-20	7.06	7.03	7.00	6.97	6.95	
-17.7	-18	7.46	7.43	7.41	7.37	7.34	
-15.7	-16	7.87	7.84	7.81	7.77	7.74	
-13.5	-14	8.33	8.29	8.26	8.22	8.18	
-11.5	-12	8.78	8.74	8.70	8.66	8.62	
-9.5	-10	9.24	9.19	9.15	9.11	9.06	
-7.5	-8	9.69	9.65	9.60	9.55	9.50	
-5.5	-6	9.91	9.86	9.81	9.75	9.70	
-3.0	-4	10.12	10.07	10.01	9.96	9.90	
-1.0	-2	10.33	10.28	10.22	10.16	10.10	
1.0	0	10.55	10.49	10.43	10.36	10.30	
2.0	1	10.65	10.59	10.53	10.47	10.40	
3.0	2	11.36	11.29	11.22	11.18	11.13	
5.0	4	12.76	12.69	12.61	12.60	12.58	
7.0	6	14.16	14.08	14.00	14.02	14.04	
9.0	8	14.72	14.64	14.56	14.52	14.49	
11.5	10	15.28	15.20	15.11	15.02	14.93	
13.5	12	16.13	16.04	15.94	15.82	15.75	
15.5	14	16.98	16.88	16.77	16.62	16.58	
16.5	16	17.41	17.30	17.19	17.02	16.99	

PJG00Z013

Model **FDUM125VSPVF** Indoor unit **FDUM60VF (2 units)** Outdoor unit **FDC125VS**
 Cooling Mode

Outdoor air temp. °CDB	Indoor air temperature (kW)															
	18°CDB		21°CDB		23°CDB		26°CDB		27°CDB		28°CDB		31°CDB		33°CDB	
	TC	SHC	TC	SHC	TC	SHC	TC	SHC	TC	SHC	TC	SHC	TC	SHC	TC	SHC
11					10.15	8.91	10.74	9.69	11.03	9.59	11.34	9.50	11.96	10.07	12.57	9.84
13					10.63	9.09	11.26	9.87	11.57	9.77	11.91	9.68	12.58	10.25	13.25	10.02
15					11.10	9.27	11.78	10.05	12.11	9.95	12.47	9.86	13.20	10.42	13.92	10.19
17					11.58	9.46	12.29	10.23	12.65	10.13	13.04	10.04	13.82	10.60	14.59	10.36
19					11.82	9.55	12.56	10.33	12.92	10.23	13.32	10.13	14.11	10.69	14.90	10.45
21					12.06	9.65	12.82	10.42	13.19	10.32	13.60	10.22	14.40	10.77	15.20	10.52
23					12.06	9.65	12.85	10.43	13.23	10.33	13.64	10.24	14.45	10.79	15.27	10.54
25			11.16	9.87	12.06	9.65	12.89	10.44	13.27	10.35	13.68	10.25	14.51	10.81	15.34	10.56
27			11.08	9.84	12.05	9.64	12.92	10.46	13.31	10.36	13.69	10.25	14.47	10.80		
29			11.00	9.80	11.87	9.57	12.71	10.38	13.11	10.29	13.51	10.19	14.31	10.75		
31			10.92	9.77	11.69	9.50	12.49	10.30	12.90	10.22	13.32	10.13	14.15	10.70		
33	10.27	9.09	10.72	9.68	11.51	9.43	12.27	10.22	12.70	10.15	13.13	10.07	13.99	10.65		
35	10.07	9.00	10.55	9.61	11.33	9.36	12.06	10.15	12.50	10.08	12.94	10.01	13.83	10.61		
37	9.90	8.92	10.38	9.54	11.13	9.29	11.83	10.07	12.24	9.99	12.66	9.92	13.50	10.51		
39	9.72	8.84	10.20	9.47	10.94	9.21	11.60	9.99	11.99	9.91	12.38	9.83	13.16	10.41		
41	9.55	8.76	10.02	9.39	10.75	9.14	11.37	9.91	11.73	9.82	12.09	9.74	12.82	10.31		
43	9.38	8.69	9.85	9.32	10.56	9.07	11.14	9.83	11.47	9.74	11.81	9.65	12.48	10.22		

Heating Mode : HC (kW)

Outdoor air temp.		Indoor air temperature °CDB					
°CDB	°CWB	16	18	20	22	24	
-19.8	-20	7.06	7.03	7.00	6.97	6.95	
-17.7	-18	7.46	7.43	7.41	7.37	7.34	
-15.7	-16	7.87	7.84	7.81	7.77	7.74	
-13.5	-14	8.33	8.29	8.26	8.22	8.18	
-11.5	-12	8.78	8.74	8.70	8.66	8.62	
-9.5	-10	9.24	9.19	9.15	9.11	9.06	
-7.5	-8	9.69	9.65	9.60	9.55	9.50	
-5.5	-6	9.91	9.86	9.81	9.75	9.70	
-3.0	-4	10.12	10.07	10.01	9.96	9.90	
-1.0	-2	10.33	10.28	10.22	10.16	10.10	
1.0	0	10.55	10.49	10.43	10.36	10.30	
2.0	1	10.65	10.59	10.53	10.47	10.40	
3.0	2	11.36	11.29	11.22	11.18	11.13	
5.0	4	12.76	12.69	12.61	12.60	12.58	
7.0	6	14.16	14.08	14.00	14.02	14.04	
9.0	8	14.72	14.64	14.56	14.52	14.49	
11.5	10	15.28	15.20	15.11	15.02	14.93	
13.5	12	16.13	16.04	15.94	15.82	15.75	
15.5	14	16.98	16.88	16.77	16.62	16.58	
16.5	16	17.41	17.30	17.19	17.02	16.99	

PJG00Z013

- Note(1) These data show average statuses.
 Depending on the system control, there may be ranges where the operation is not conducted continuously.
 These data show the case where the operation frequency of a compressor is fixed.
- (2) Capacities are based on the following conditions.
 Corresponding refrigerant piping length : 7.5m
 Level difference of Zero.
- (3) Symbols are as follows.
 TC : Total cooling capacity (kW)
 SHC : Sensible heat capacity (kW)
 HC : Heating capacity (kW)

Model FDUM140VNPVF1 Indoor unit FDUM71VF1 (2 units) Outdoor unit FDC140VN
 Cooling Mode (kW)

Outdoor air temp.	Indoor air temperature															
	18°CDB		21°CDB		23°CDB		26°CDB		27°CDB		28°CDB		31°CDB		33°CDB	
	12°CWB	14°CWB	16°CWB	18°CWB	19°CWB	20°CWB	22°CWB	24°CWB	TC	SHC	TC	SHC	TC	SHC	TC	SHC
°CDB	TC	SHC	TC	SHC	TC	SHC	TC	SHC	TC	SHC	TC	SHC	TC	SHC	TC	SHC
11					11.37	10.27	12.02	11.20	12.35	11.08	12.70	10.97	13.39	11.65	14.08	11.38
13					11.90	10.46	12.61	11.39	12.96	11.27	13.33	11.16	14.09	11.84	14.84	11.56
15					12.43	10.66	13.19	11.58	13.57	11.47	13.97	11.35	14.78	12.03	15.59	11.74
17					12.96	10.85	13.77	11.78	14.17	11.66	14.61	11.55	15.48	12.22	16.34	11.93
19					13.24	10.96	14.06	11.88	14.48	11.76	14.92	11.64	15.80	12.31	16.68	12.01
21					13.51	11.06	14.36	11.98	14.78	11.86	15.23	11.74	16.12	12.39	17.02	12.09
23					13.51	11.06	14.40	11.99	14.82	11.87	15.28	11.75	16.19	12.41	17.10	12.11
25			12.50	11.34	13.50	11.06	14.43	12.00	14.86	11.88	15.33	11.77	16.25	12.43	17.18	12.13
27			12.41	11.31	13.50	11.06	14.47	12.02	14.91	11.90	15.34	11.77	16.20	12.42		
29			12.32	11.27	13.29	10.98	14.23	11.94	14.68	11.83	15.13	11.71	16.02	12.37		
31			12.23	11.23	13.09	10.90	13.99	11.85	14.45	11.75	14.92	11.64	15.85	12.32		
33	11.51	10.43	12.01	11.14	12.89	10.83	13.75	11.77	14.23	11.68	14.71	11.58	15.67	12.27		
35	11.28	10.33	11.82	11.07	12.68	10.75	13.50	11.69	14.00	11.60	14.50	11.51	15.49	12.22		
37	11.08	10.24	11.62	10.99	12.47	10.67	13.25	11.60	13.71	11.51	14.18	11.41	15.12	12.12		
39	10.89	10.16	11.43	10.91	12.26	10.60	12.99	11.52	13.43	11.42	13.86	11.32	14.74	12.01		
41	10.70	10.07	11.23	10.83	12.04	10.52	12.73	11.43	13.14	11.33	13.55	11.22	14.36	11.91		
43	10.51	9.99	11.03	10.75	11.83	10.44	12.47	11.34	12.85	11.24	13.23	11.13	13.98	11.81		

Heating Mode : HC (kW)

Outdoor air temp.	Indoor air temperature						
	°CDB						
	°CDB	°CWB	16	18	20	22	24
-19.8	-20	8.06	8.03	8.00	7.97	7.94	
-17.7	-18	8.53	8.50	8.46	8.43	8.39	
-15.7	-16	9.00	8.96	8.92	8.88	8.85	
-13.5	-14	9.52	9.48	9.43	9.39	9.35	
-11.5	-12	10.04	9.99	9.95	9.90	9.85	
-9.5	-10	10.56	10.51	10.46	10.41	10.36	
-7.5	-8	11.08	11.02	10.97	10.91	10.86	
-5.5	-6	11.32	11.26	11.21	11.15	11.09	
-3.0	-4	11.56	11.50	11.44	11.38	11.31	
-1.0	-2	11.81	11.75	11.68	11.61	11.54	
1.0	0	12.05	11.99	11.92	11.84	11.77	
2.0	1	12.18	12.11	12.04	11.96	11.89	
3.0	2	12.98	12.90	12.83	12.77	12.72	
5.0	4	14.58	14.50	14.41	14.40	14.38	
7.0	6	16.19	16.09	16.00	16.02	16.05	
9.0	8	16.83	16.73	16.63	16.59	16.55	
11.5	10	17.46	17.37	17.27	17.17	17.06	
13.5	12	18.44	18.33	18.22	18.08	18.00	
15.5	14	19.41	19.29	19.17	18.99	18.95	
16.5	16	19.90	19.77	19.64	19.45	19.42	

PJG000Z013

Model FDUM140VSPVF1 Indoor unit FDUM71VF1 (2 units) Outdoor unit FDC140VS
 Cooling Mode (kW)

Outdoor air temp.	Indoor air temperature															
	18°CDB		21°CDB		23°CDB		26°CDB		27°CDB		28°CDB		31°CDB		33°CDB	
	12°CWB	14°CWB	16°CWB	18°CWB	19°CWB	20°CWB	22°CWB	24°CWB	TC	SHC	TC	SHC	TC	SHC	TC	SHC
°CDB	TC	SHC	TC	SHC	TC	SHC	TC	SHC	TC	SHC	TC	SHC	TC	SHC	TC	SHC
11					11.37	10.27	12.02	11.20	12.35	11.08	12.70	10.97	13.39	11.65	14.08	11.38
13					11.90	10.46	12.61	11.39	12.96	11.27	13.33	11.16	14.09	11.84	14.84	11.56
15					12.43	10.66	13.19	11.58	13.57	11.47	13.97	11.35	14.78	12.03	15.59	11.74
17					12.96	10.85	13.77	11.78	14.17	11.66	14.61	11.55	15.48	12.22	16.34	11.93
19					13.24	10.96	14.06	11.88	14.48	11.76	14.92	11.64	15.80	12.31	16.68	12.01
21					13.51	11.06	14.36	11.98	14.78	11.86	15.23	11.74	16.12	12.39	17.02	12.09
23					13.51	11.06	14.40	11.99	14.82	11.87	15.28	11.75	16.19	12.41	17.10	12.11
25			12.50	11.34	13.50	11.06	14.43	12.00	14.86	11.88	15.33	11.77	16.25	12.43	17.18	12.13
27			12.41	11.31	13.50	11.06	14.47	12.02	14.91	11.90	15.34	11.77	16.20	12.42		
29			12.32	11.27	13.29	10.98	14.23	11.94	14.68	11.83	15.13	11.71	16.02	12.37		
31			12.23	11.23	13.09	10.90	13.99	11.85	14.45	11.75	14.92	11.64	15.85	12.32		
33	11.51	10.43	12.01	11.14	12.89	10.83	13.75	11.77	14.23	11.68	14.71	11.58	15.67	12.27		
35	11.28	10.33	11.82	11.07	12.68	10.75	13.50	11.69	14.00	11.60	14.50	11.51	15.49	12.22		
37	11.08	10.24	11.62	10.99	12.47	10.67	13.25	11.60	13.71	11.51	14.18	11.41	15.12	12.12		
39	10.89	10.16	11.43	10.91	12.26	10.60	12.99	11.52	13.43	11.42	13.86	11.32	14.74	12.01		
41	10.70	10.07	11.23	10.83	12.04	10.52	12.73	11.43	13.14	11.33	13.55	11.22	14.36	11.91		
43	10.51	9.99	11.03	10.75	11.83	10.44	12.47	11.34	12.85	11.24	13.23	11.13	13.98	11.81		

Heating Mode : HC (kW)

Outdoor air temp.	Indoor air temperature						
	°CDB						
	°CDB	°CWB	16	18	20	22	24
-19.8	-20	8.06	8.03	8.00	7.97	7.94	
-17.7	-18	8.53	8.50	8.46	8.43	8.39	
-15.7	-16	9.00	8.96	8.92	8.88	8.85	
-13.5	-14	9.52	9.48	9.43	9.39	9.35	
-11.5	-12	10.04	9.99	9.95	9.90	9.85	
-9.5	-10	10.56	10.51	10.46	10.41	10.36	
-7.5	-8	11.08	11.02	10.97	10.91	10.86	
-5.5	-6	11.32	11.26	11.21	11.15	11.09	
-3.0	-4	11.56	11.50	11.44	11.38	11.31	
-1.0	-2	11.81	11.75	11.68	11.61	11.54	
1.0	0	12.05	11.99	11.92	11.84	11.77	
2.0	1	12.18	12.11	12.04	11.96	11.89	
3.0	2	12.98	12.90	12.83	12.77	12.72	
5.0	4	14.58	14.50	14.41	14.40	14.38	
7.0	6	16.19	16.09	16.00	16.02	16.05	
9.0	8	16.83	16.73	16.63	16.59	16.55	
11.5	10	17.46	17.37	17.27	17.17	17.06	
13.5	12	18.44	18.33	18.22	18.08	18.00	
15.5	14	19.41	19.29	19.17	18.99	18.95	
16.5	16	19.90	19.77	19.64	19.45	19.42	

PJG000Z013

Note(1) These data show average statuses.

Depending on the system control, there may be ranges where the operation is not conducted continuously.

These data show the case where the operation frequency of a compressor is fixed.

(2) Capacities are based on the following conditions.

Corresponding refrigerant piping length :7.5m

Level difference of Zero.

(3) Symbols are as follows.

TC : Total cooling capacity (kW)

SHC : Sensible heat capacity (kW)

HC : Heating capacity (kW)

Model FDUM200VSPVF1 Indoor unit FDUM100VF1 (2 units) Outdoor unit FDC200VS
Cooling Mode (kW)

Outdoor air temp.	Indoor air temperature															
	18°CDB		21°CDB		23°CDB		26°CDB		27°CDB		28°CDB		31°CDB		33°CDB	
	12°CWB	14°CWB	16°CWB	18°CWB	19°CWB	20°CWB	22°CWB	24°CWB	TC	SHC	TC	SHC	TC	SHC	TC	SHC
°CDB	TC	SHC	TC	SHC	TC	SHC	TC	SHC	TC	SHC	TC	SHC	TC	SHC	TC	SHC
11					17.37	14.09	18.41	15.32	18.94	15.07	19.50	14.81	20.63	15.66	21.76	15.07
13					17.90	14.24	18.99	15.46	19.54	15.21	20.13	14.95	21.31	15.78	22.49	15.18
15					18.43	14.40	19.57	15.61	20.14	15.35	20.75	15.09	21.98	15.91	23.21	15.29
17					18.96	14.56	20.14	15.76	20.73	15.50	21.38	15.23	22.66	16.04	23.94	15.40
19					19.35	14.68	20.56	15.88	21.16	15.60	21.81	15.33	23.12	16.13	24.42	15.48
21					19.41	14.70	20.98	15.99	21.59	15.71	22.25	15.43	23.57	16.21	24.89	15.55
23					19.31	14.66	20.86	15.96	21.47	15.68	22.12	15.40	23.43	16.19	24.73	15.53
25			17.35	15.11	19.20	14.63	20.74	15.93	21.35	15.65	21.99	15.37	23.28	16.16	24.57	15.50
27			17.28	15.08	19.10	14.60	20.62	15.89	21.22	15.62	21.83	15.33	23.04	16.11		
29			17.14	15.03	18.85	14.53	20.31	15.81	20.92	15.54	21.53	15.26	22.75	16.05		
31			16.99	14.98	18.59	14.45	20.00	15.73	20.61	15.47	21.22	15.19	22.45	16.00		
33	16.46	14.09	17.03	15.00	18.33	14.37	19.69	15.65	20.31	15.39	20.92	15.12	22.15	15.94		
35	16.14	13.97	16.76	14.91	18.08	14.29	19.38	15.57	20.00	15.32	20.62	15.06	21.85	15.88		
37	15.86	13.87	16.50	14.82	17.76	14.20	18.98	15.46	19.57	15.21	20.17	14.96	21.35	15.79		
39	15.59	13.77	16.23	14.73	17.44	14.11	18.58	15.36	19.15	15.11	19.71	14.86	20.85	15.70		
41	15.32	13.67	15.97	14.65	17.13	14.02	18.17	15.26	18.72	15.01	19.26	14.76	20.35	15.61		
43	15.04	13.56	15.70	14.56	16.81	13.92	17.77	15.15	18.29	14.91	18.81	14.66	19.85	15.52		

Heating Mode : HC (kW)

Outdoor air temp.	Indoor air temperature					
	°CDB		°CWB		°CDB	
	16	18	20	22	24	
-19.8	-20	11.27	11.26	11.25	11.24	11.23
-17.7	-18	11.89	11.87	11.85	11.84	11.82
-15.7	-16	12.51	12.49	12.46	12.43	12.41
-13.5	-14	13.21	13.18	13.14	13.11	13.08
-11.5	-12	13.91	13.87	13.83	13.79	13.76
-9.5	-10	14.61	14.57	14.52	14.47	14.43
-7.5	-8	15.31	15.26	15.21	15.16	15.10
-5.5	-6	15.64	15.58	15.52	15.46	15.40
-3.0	-4	15.96	15.89	15.82	15.76	15.69
-1.0	-2	16.29	16.21	16.13	16.06	15.98
1.0	0	16.61	16.53	16.44	16.36	16.28
2.0	1	16.78	16.69	16.59	16.51	16.42
3.0	2	17.96	17.86	17.76	17.66	17.56
5.0	4	20.33	20.21	20.08	19.96	19.84
7.0	6	22.71	22.55	22.40	22.26	22.12
9.0	8	23.43	23.28	23.13	22.88	22.63
11.5	10	24.14	24.00	23.86	23.50	23.13
13.5	12	25.41	25.24	25.07	24.77	24.43
15.5	14	26.67	26.47	26.27	26.05	25.72
16.5	16	27.30	27.09	26.87	26.69	26.37

PJG000Z013

Model FDUM250VSPVF Indoor unit FDUM125VF (2 units) Outdoor unit FDC250VS
Cooling Mode (kW)

Outdoor air temp.	Indoor air temperature															
	18°CDB		21°CDB		23°CDB		26°CDB		27°CDB		28°CDB		31°CDB		33°CDB	
	12°CWB	14°CWB	16°CWB	18°CWB	19°CWB	20°CWB	22°CWB	24°CWB	TC	SHC	TC	SHC	TC	SHC	TC	SHC
11					21.71	19.06	23.02	20.67	23.67	20.54	24.38	20.42	25.79	21.64	27.21	21.32
13					22.38	19.34	23.74	20.96	24.42	20.82	25.16	20.70	26.63	21.92	28.11	21.59
15					23.04	19.62	24.46	21.24	25.17	21.11	25.94	20.99	27.48	22.21	29.02	21.87
17					23.70	19.91	25.18	21.53	25.92	21.40	26.72	21.27	28.32	22.50	29.92	22.16
19					24.19	20.12	25.70	21.74	26.45	21.60	27.27	21.48	28.89	22.69	30.52	22.34
21					24.26	20.15	26.22	21.94	26.99	21.81	27.82	21.68	29.47	22.89	31.12	22.53
23					24.13	20.09	26.07	21.88	26.84	21.75	27.65	21.62	29.28	22.82	30.91	22.47
25			21.69	20.10	24.00	20.03	25.92	21.82	26.68	21.69	27.49	21.56	29.10	22.76	30.71	22.40
27			21.60	20.06	23.88	19.98	25.77	21.76	26.53	21.63	27.29	21.48	28.80	22.66		
29			21.42	19.98	23.56	19.85	25.39	21.61	26.15	21.48	26.91	21.34	28.43	22.53		
31			21.24	19.90	23.24	19.71	25.00	21.46	25.77	21.34	26.53	21.20	28.06	22.41		
33	20.58	18.77	21.29	19.92	22.92	19.57	24.61	21.30	25.38	21.19	26.15	21.06	27.69	22.28		
35	20.17	18.57	20.96	19.77	22.60	19.44	24.23	21.15	25.00	21.04	25.77	20.92	27.31	22.15		
37	19.83	18.40	20.62	19.62	22.20	19.27	23.73	20.95	24.47	20.84	25.21	20.72	26.69	21.94		
39	19.49	18.24	20.29	19.47	21.80	19.10	23.22	20.75	23.93	20.64	24.64	20.51	26.06	21.73		
41	19.15	18.07	19.96	19.32	21.41	18.93	22.72	20.56	23.40	20.44	24.08	20.31	25.43	21.52		
43	18.81	17.91	19.63	19.17	21.01	18.77	22.22	20.36	22.86	20.24	23.51	20.11	24.81	21.32		

Heating Mode : HC (kW)

Outdoor air temp.	Indoor air temperature					
	°CDB		°CWB		°CDB	
	16	18	20	22	24	
-19.8	-20	14.09	14.07	14.06	14.05	14.04
-17.7	-18	14.87	14.84	14.81	14.79	14.77
-15.7	-16	15.64	15.61	15.57	15.54	15.51
-13.5	-14	16.52	16.47	16.43	16.39	16.35
-11.5	-12	17.39	17.34	17.29	17.24	17.19
-9.5	-10	18.26	18.21	18.15	18.09	18.04
-7.5	-8	19.14	19.07	19.01	18.94	18.88
-5.5	-6	19.55	19.47	19.40	19.32	19.24
-3.0	-4	19.95	19.87	19.78	19.70	19.61
-1.0	-2	20.36	20.26	20.17	20.07	19.98
1.0	0	20.77	20.66	20.55	20.45	20.35
2.0	1	20.97	20.86	20.74	20.64	20.53
3.0	2	22.45	22.32	22.19	22.07	21.95
5.0	4	25.42	25.26	25.10	24.95	24.80
7.0	6	28.38	28.19	28.00	27.82	27.65
9.0	8	29.28	29.10	28.91	28.60	28.28
11.5	10	30.18	30.00	29.83	29.37	28.91
13.5	12	31.76	31.55	31.33	30.97	30.53
15.5	14	33.34	33.09	32.84	32.57	32.15
16.5	16	34.13	33.86	33.59	33.37	32.96

PJG000Z013

Note(1) These data show average statuses.

Depending on the system control, there may be ranges where the operation is not conducted continuously.

These data show the case where the operation frequency of a compressor is fixed.

(2) Capacities are based on the following conditions.

Corresponding refrigerant piping length :7.5m

Level difference of Zero.

(3) Symbols are as follows.

TC : Total cooling capacity (kW)

SHC : Sensible heat capacity (kW)

HC : Heating capacity (kW)

(c) Triple type

Model FDUM140VNTVF Indoor unit FDUM50VF (3 units) Outdoor unit FDC140VN
Cooling Mode (kW)

Outdoor air temp.	Indoor air temperature															
	18°CDB		21°CDB		23°CDB		26°CDB		27°CDB		28°CDB		31°CDB		33°CDB	
	12°CWB	14°CWB	16°CWB	18°CWB	19°CWB	20°CWB	22°CWB	24°CWB	TC	SHC	TC	SHC	TC	SHC	TC	SHC
11					11.37	9.75	12.02	10.54	12.35	10.47	12.70	10.39	13.39	10.99	14.08	10.80
13					11.90	9.97	12.61	10.77	12.96	10.70	13.33	10.63	14.09	11.22	14.84	11.04
15					12.43	10.20	13.19	11.00	13.57	10.93	13.97	10.86	14.78	11.46	15.59	11.28
17					12.96	10.43	13.77	11.24	14.17	11.17	14.61	11.10	15.48	11.70	16.34	11.51
19					13.24	10.56	14.06	11.36	14.48	11.29	14.92	11.22	15.80	11.81	16.68	11.62
21					13.51	10.68	14.36	11.48	14.78	11.41	15.23	11.34	16.12	11.93	17.02	11.73
23					13.51	10.68	14.40	11.50	14.82	11.43	15.28	11.36	16.19	11.95	17.10	11.76
25			12.50	10.82	13.50	10.67	14.43	11.51	14.86	11.44	15.33	11.38	16.25	11.97	17.18	11.79
27			12.41	10.78	13.50	10.67	14.47	11.53	14.91	11.46	15.34	11.38	16.20	11.96		
29			12.32	10.74	13.29	10.58	14.23	11.43	14.68	11.37	15.13	11.30	16.02	11.89		
31			12.23	10.69	13.09	10.49	13.99	11.33	14.45	11.28	14.92	11.22	15.85	11.83		
33	11.51	9.99	12.01	10.59	12.89	10.40	13.75	11.23	14.23	11.19	14.71	11.14	15.67	11.77		
35	11.28	9.87	11.82	10.50	12.68	10.31	13.50	11.13	14.00	11.10	14.50	11.06	15.49	11.71		
37	11.08	9.77	11.62	10.41	12.47	10.22	13.25	11.03	13.71	10.99	14.18	10.94	15.12	11.58		
39	10.89	9.68	11.43	10.32	12.26	10.13	12.99	10.92	13.43	10.88	13.86	10.82	14.74	11.45		
41	10.70	9.59	11.23	10.23	12.04	10.03	12.73	10.82	13.14	10.77	13.55	10.71	14.36	11.32		
43	10.51	9.49	11.03	10.14	11.83	9.94	12.47	10.72	12.85	10.66	13.23	10.59	13.98	11.19		

Heating Mode : HC (kW)

Outdoor air temp.	Indoor air temperature					
	°CDB					
	°CDB	°CWB	16	18	20	22
-19.8	-20	8.06	8.03	8.00	7.97	7.94
-17.7	-18	8.53	8.50	8.46	8.43	8.39
-15.7	-16	9.00	8.96	8.92	8.88	8.85
-13.5	-14	9.52	9.48	9.43	9.39	9.35
-11.5	-12	10.04	9.99	9.95	9.90	9.85
-9.5	-10	10.56	10.51	10.46	10.41	10.36
-7.5	-8	11.08	11.02	10.97	10.91	10.86
-5.5	-6	11.32	11.26	11.21	11.15	11.09
-3.0	-4	11.56	11.50	11.44	11.38	11.31
-1.0	-2	11.81	11.75	11.68	11.61	11.54
1.0	0	12.05	11.99	11.92	11.84	11.77
2.0	1	12.18	12.11	12.04	11.96	11.89
3.0	2	12.98	12.90	12.83	12.77	12.72
5.0	4	14.58	14.50	14.41	14.40	14.38
7.0	6	16.19	16.09	16.00	16.02	16.05
9.0	8	16.83	16.73	16.63	16.59	16.55
11.5	10	17.46	17.37	17.27	17.17	17.06
13.5	12	18.44	18.33	18.22	18.08	18.00
15.5	14	19.41	19.29	19.17	18.99	18.95
16.5	16	19.90	19.77	19.64	19.45	19.42

PJG000Z013

Model FDUM140VSTVF Indoor unit FDUM50VF (3 units) Outdoor unit FDC140VS
Cooling Mode (kW)

Outdoor air temp.	Indoor air temperature															
	18°CDB		21°CDB		23°CDB		26°CDB		27°CDB		28°CDB		31°CDB		33°CDB	
	12°CWB	14°CWB	16°CWB	18°CWB	19°CWB	20°CWB	22°CWB	24°CWB	TC	SHC	TC	SHC	TC	SHC	TC	SHC
11					11.37	9.75	12.02	10.54	12.35	10.47	12.70	10.39	13.39	10.99	14.08	10.80
13					11.90	9.97	12.61	10.77	12.96	10.70	13.33	10.63	14.09	11.22	14.84	11.04
15					12.43	10.20	13.19	11.00	13.57	10.93	13.97	10.86	14.78	11.46	15.59	11.28
17					12.96	10.43	13.77	11.24	14.17	11.17	14.61	11.10	15.48	11.70	16.34	11.51
19					13.24	10.56	14.06	11.36	14.48	11.29	14.92	11.22	15.80	11.81	16.68	11.62
21					13.51	10.68	14.36	11.48	14.78	11.41	15.23	11.34	16.12	11.93	17.02	11.73
23					13.51	10.68	14.40	11.50	14.82	11.43	15.28	11.36	16.19	11.95	17.10	11.76
25			12.50	10.82	13.50	10.67	14.43	11.51	14.86	11.44	15.33	11.38	16.25	11.97	17.18	11.79
27			12.41	10.78	13.50	10.67	14.47	11.53	14.91	11.46	15.34	11.38	16.20	11.96		
29			12.32	10.74	13.29	10.58	14.23	11.43	14.68	11.37	15.13	11.30	16.02	11.89		
31			12.23	10.69	13.09	10.49	13.99	11.33	14.45	11.28	14.92	11.22	15.85	11.83		
33	11.51	9.99	12.01	10.59	12.89	10.40	13.75	11.23	14.23	11.19	14.71	11.14	15.67	11.77		
35	11.28	9.87	11.82	10.50	12.68	10.31	13.50	11.13	14.00	11.10	14.50	11.06	15.49	11.71		
37	11.08	9.77	11.62	10.41	12.47	10.22	13.25	11.03	13.71	10.99	14.18	10.94	15.12	11.58		
39	10.89	9.68	11.43	10.32	12.26	10.13	12.99	10.92	13.43	10.88	13.86	10.82	14.74	11.45		
41	10.70	9.59	11.23	10.23	12.04	10.03	12.73	10.82	13.14	10.77	13.55	10.71	14.36	11.32		
43	10.51	9.49	11.03	10.14	11.83	9.94	12.47	10.72	12.85	10.66	13.23	10.59	13.98	11.19		

Heating Mode : HC (kW)

Outdoor air temp.	Indoor air temperature					
	°CDB					
	°CDB	°CWB	16	18	20	22
-19.8	-20	8.06	8.03	8.00	7.97	7.94
-17.7	-18	8.53	8.50	8.46	8.43	8.39
-15.7	-16	9.00	8.96	8.92	8.88	8.85
-13.5	-14	9.52	9.48	9.43	9.39	9.35
-11.5	-12	10.04	9.99	9.95	9.90	9.85
-9.5	-10	10.56	10.51	10.46	10.41	10.36
-7.5	-8	11.08	11.02	10.97	10.91	10.86
-5.5	-6	11.32	11.26	11.21	11.15	11.09
-3.0	-4	11.56	11.50	11.44	11.38	11.31
-1.0	-2	11.81	11.75	11.68	11.61	11.54
1.0	0	12.05	11.99	11.92	11.84	11.77
2.0	1	12.18	12.11	12.04	11.96	11.89
3.0	2	12.98	12.90	12.83	12.77	12.72
5.0	4	14.58	14.50	14.41	14.40	14.38
7.0	6	16.19	16.09	16.00	16.02	16.05
9.0	8	16.83	16.73	16.63	16.59	16.55
11.5	10	17.46	17.37	17.27	17.17	17.06
13.5	12	18.44	18.33	18.22	18.08	18.00
15.5	14	19.41	19.29	19.17	18.99	18.95
16.5	16	19.90	19.77	19.64	19.45	19.42

PJG000Z013

- Note(1) These data show average statuses.
 Depending on the system control, there may be ranges where the operation is not conducted continuously.
 These data show the case where the operation frequency of a compressor is fixed.
 (2) Capacities are based on the following conditions.
 Corresponding refrigerant piping length :7.5m
 Level difference of Zero.
 (3) Symbols are as follows.
 TC : Total cooling capacity (kW)
 SHC : Sensible heat capacity (kW)
 HC : Heating capacity (kW)

Model **FDUM200VSTVF1** Indoor unit **FDUM71VF1 (3 units)** Outdoor unit **FDC200VS**
 Cooling Mode (kW)

Heating Mode : HC (kW)

Outdoor air temp.	Indoor air temperature															
	18°CDB		21°CDB		23°CDB		26°CDB		27°CDB		28°CDB		31°CDB		33°CDB	
	TC	SHC	TC	SHC	TC	SHC	TC	SHC	TC	SHC	TC	SHC	TC	SHC	TC	SHC
11					17.37	15.52	18.41	16.92	18.94	16.75	19.50	16.59	20.63	17.62	21.76	17.23
13					17.90	15.71	18.99	17.11	19.54	16.94	20.13	16.78	21.31	17.81	22.49	17.40
15					18.43	15.91	19.57	17.30	20.14	17.13	20.75	16.96	21.98	17.99	23.21	17.57
17					18.96	16.10	20.14	17.49	20.73	17.32	21.38	17.15	22.66	18.17	23.94	17.75
19					19.35	16.25	20.56	17.64	21.16	17.46	21.81	17.29	23.12	18.30	24.42	17.87
21					19.41	16.27	20.98	17.78	21.59	17.60	22.25	17.42	23.57	18.42	24.89	17.98
23					19.31	16.23	20.86	17.74	21.47	17.56	22.12	17.38	23.43	18.38	24.73	17.94
25			17.35	16.45	19.20	16.19	20.74	17.70	21.35	17.52	21.99	17.34	23.28	18.34	24.57	17.90
27			17.28	16.42	19.10	16.16	20.62	17.66	21.22	17.48	21.83	17.29	23.04	18.28		
29			17.14	16.36	18.85	16.06	20.31	17.55	20.92	17.38	21.53	17.20	22.75	18.20		
31			16.99	16.30	18.59	15.97	20.00	17.45	20.61	17.28	21.22	17.11	22.45	18.11		
33	16.46	15.29	17.03	16.32	18.33	15.87	19.69	17.34	20.31	17.19	20.92	17.01	22.15	18.03		
35	16.14	15.15	16.76	16.21	18.08	15.78	19.38	17.24	20.00	17.09	20.62	16.92	21.85	17.95		
37	15.86	15.03	16.50	16.11	17.76	15.66	18.98	17.11	19.57	16.95	20.17	16.79	21.35	17.82		
39	15.59	14.91	16.23	15.91	17.44	15.55	18.58	16.97	19.15	16.82	19.71	16.65	20.85	17.68		
41	15.32	14.80	15.97	15.65	17.13	15.44	18.17	16.84	18.72	16.69	19.26	16.52	20.35	17.55		
43	15.04	14.68	15.70	15.39	16.81	15.32	17.77	16.71	18.29	16.55	18.81	16.38	19.85	17.42		

Outdoor air temp.	Indoor air temperature					
	°CDB		°CWB			
°CDB	°CWB	16	18	20	22	24
-19.8	-20	11.27	11.26	11.25	11.24	11.23
-17.7	-18	11.89	11.87	11.85	11.84	11.82
-15.7	-16	12.51	12.49	12.46	12.43	12.41
-13.5	-14	13.21	13.18	13.14	13.11	13.08
-11.5	-12	13.91	13.87	13.83	13.79	13.76
-9.5	-10	14.61	14.57	14.52	14.47	14.43
-7.5	-8	15.31	15.26	15.21	15.16	15.10
-5.5	-6	15.64	15.58	15.52	15.46	15.40
-3.0	-4	15.96	15.89	15.82	15.76	15.69
-1.0	-2	16.29	16.21	16.13	16.06	15.98
1.0	0	16.61	16.53	16.44	16.36	16.28
2.0	1	16.78	16.69	16.59	16.51	16.42
3.0	2	17.96	17.86	17.76	17.66	17.56
5.0	4	20.33	20.21	20.08	19.96	19.84
7.0	6	22.71	22.55	22.40	22.26	22.12
9.0	8	23.43	23.28	23.13	22.88	22.63
11.5	10	24.14	24.00	23.86	23.50	23.13
13.5	12	25.41	25.24	25.07	24.77	24.43
15.5	14	26.67	26.47	26.27	26.05	25.72
16.5	16	27.30	27.09	26.87	26.69	26.37

- Note(1) These data show average statuses.
 Depending on the system control, there may be ranges where the operation is not conducted continuously.
 These data show the case where the operation frequency of a compressor is fixed.
- (2) Capacities are based on the following conditions.
 Corresponding refrigerant piping length : 7.5m
 Level difference of Zero.
- (3) Symbols are as follows.
 TC : Total cooling capacity (kW)
 SHC : Sensible heat capacity (kW)
 HC : Heating capacity (kW)

PJG000Z013

(6) Floor standing type (FDF)
(a) Single type

Model FDF100VNVD1, 100VNVD2 Indoor unit FDF100VD1 Outdoor unit FDC100VN
Cool Mode 100VD2 (kW)

Heat Mode:HC (kW)

Table with 18 columns: Outdoor air temp., Indoor air temperature (18°CDB to 33°CDB), and sub-columns for TC and SHC.

Table with 7 columns: Outdoor air temp., Indoor air temperature (°CDB), and sub-columns for °CDB and °CWB.

PGA000Z772

Model FDF100VSVD1, 100VSVD2 Indoor unit FDF100VD1 Outdoor unit FDC100VS
Cool Mode 100VD2 (kW)

Heat Mode:HC (kW)

Table with 18 columns: Outdoor air temp., Indoor air temperature (18°CDB to 33°CDB), and sub-columns for TC and SHC.

Table with 7 columns: Outdoor air temp., Indoor air temperature (°CDB), and sub-columns for °CDB and °CWB.

Note(1) These data show average status. Depending on the system control, there may be ranges where the operation is not conducted continuously. These data show the case where the operation frequency of a compressor is fixed.
(2) Capacities are based on the following conditions. Corresponding refrigerant piping length :7.5m Level difference of Zero.
(3) Symbols are as follows TC :Total cooling capacity (kW) SHC :Sensible heat capacity (kW) HC :Heating capacity (kW)

PGA000Z772

Model **FD125VNV D** Indoor unit FDF125VD Outdoor unit FDC125VN (kW) Heat Mode:HC (kW)
Cool Mode

Outdoor air temp. °CDB	Indoor air temperature															
	18°CDB		21°CDB		23°CDB		26°CDB		27°CDB		28°CDB		31°CDB		33°CDB	
	12°CWB		14°CWB		16°CWB		18°CWB		19°CWB		20°CWB		22°CWB		24°CWB	
	TC	SHC	TC	SHC	TC	SHC	TC	SHC	TC	SHC	TC	SHC	TC	SHC	TC	SHC
11					10.15	7.89	10.74	8.45	11.03	8.38	11.34	8.32	11.96	8.72	12.57	8.55
13					10.63	8.10	11.26	8.67	11.57	8.60	11.91	8.53	12.58	8.94	13.25	8.76
15					11.10	8.31	11.78	8.88	12.11	8.81	12.47	8.75	13.20	9.16	13.92	8.98
17					11.58	8.53	12.29	9.10	12.65	9.03	13.04	8.97	13.82	9.38	14.59	9.20
19					11.82	8.64	12.56	9.21	12.92	9.14	13.32	9.08	14.11	9.49	14.90	9.30
21					12.06	8.75	12.82	9.32	13.19	9.25	13.60	9.19	14.40	9.59	15.20	9.40
23					12.06	8.75	12.85	9.34	13.23	9.27	13.64	9.20	14.45	9.61	15.27	9.43
25			11.16	8.86	12.06	8.75	12.89	9.35	13.27	9.28	13.68	9.22	14.51	9.63	15.34	9.45
27			11.08	8.82	12.05	8.74	12.92	9.37	13.31	9.30	13.69	9.22	14.47	9.62		
29			11.00	8.78	11.87	8.66	12.71	9.28	13.11	9.22	13.51	9.15	14.31	9.56		
31			10.92	8.74	11.69	8.58	12.49	9.18	12.90	9.13	13.32	9.08	14.15	9.50		
33	10.27	8.22	10.72	8.64	11.51	8.49	12.27	9.09	12.70	9.05	13.13	9.00	13.99	9.44		
35	10.07	8.12	10.55	8.56	11.33	8.41	12.06	9.00	12.50	8.97	12.94	8.93	13.83	9.38		
37	9.90	8.03	10.38	8.48	11.13	8.32	11.83	8.90	12.24	8.86	12.66	8.82	13.50	9.26		
39	9.72	7.94	10.20	8.39	10.94	8.24	11.60	8.81	11.99	8.76	12.38	8.71	13.16	9.14		
41	9.55	7.85	10.02	8.30	10.75	8.15	11.37	8.71	11.73	8.66	12.09	8.60	12.82	9.02		
43	9.38	7.76	9.85	8.22	10.56	8.07	11.14	8.62	11.47	8.56	11.81	8.49	12.48	8.90		

Outdoor air temp. °CDB	°CWB	Indoor air temperature °CDB				
		16	18	20	22	24
-19.8	-20	7.06	7.03	7.00	6.97	6.95
-17.7	-18	7.46	7.43	7.41	7.37	7.34
-15.7	-16	7.87	7.84	7.81	7.77	7.74
-13.5	-14	8.33	8.29	8.26	8.22	8.18
-11.5	-12	8.78	8.74	8.70	8.66	8.62
-9.5	-10	9.24	9.19	9.15	9.11	9.06
-7.5	-8	9.69	9.65	9.60	9.55	9.50
-5.5	-6	9.91	9.86	9.81	9.75	9.70
-3.0	-4	10.12	10.07	10.01	9.96	9.90
-1.0	-2	10.33	10.28	10.22	10.16	10.10
1.0	0	10.55	10.49	10.43	10.36	10.30
2.0	1	10.65	10.59	10.53	10.47	10.40
3.0	2	11.36	11.29	11.22	11.18	11.13
5.0	4	12.76	12.69	12.61	12.60	12.58
7.0	6	14.16	14.08	14.00	14.02	14.04
9.0	8	14.72	14.64	14.56	14.52	14.49
11.5	10	15.28	15.20	15.11	15.02	14.93
13.5	12	16.13	16.04	15.94	15.82	15.75
15.5	14	16.98	16.88	16.77	16.62	16.58
16.5	16	17.41	17.30	17.19	17.02	16.99

PGA000Z772

Model **FD125VSVD** Indoor unit FDF125VD Outdoor unit FDC125VS (kW) Heat Mode:HC (kW)
Cool Mode

Outdoor air temp. °CDB	Indoor air temperature															
	18°CDB		21°CDB		23°CDB		26°CDB		27°CDB		28°CDB		31°CDB		33°CDB	
	12°CWB		14°CWB		16°CWB		18°CWB		19°CWB		20°CWB		22°CWB		24°CWB	
	TC	SHC	TC	SHC	TC	SHC	TC	SHC	TC	SHC	TC	SHC	TC	SHC	TC	SHC
11					10.15	7.89	10.74	8.45	11.03	8.38	11.34	8.32	11.96	8.72	12.57	8.55
13					10.63	8.10	11.26	8.67	11.57	8.60	11.91	8.53	12.58	8.94	13.25	8.76
15					11.10	8.31	11.78	8.88	12.11	8.81	12.47	8.75	13.20	9.16	13.92	8.98
17					11.58	8.53	12.29	9.10	12.65	9.03	13.04	8.97	13.82	9.38	14.59	9.20
19					11.82	8.64	12.56	9.21	12.92	9.14	13.32	9.08	14.11	9.49	14.90	9.30
21					12.06	8.75	12.82	9.32	13.19	9.25	13.60	9.19	14.40	9.59	15.20	9.40
23					12.06	8.75	12.85	9.34	13.23	9.27	13.64	9.20	14.45	9.61	15.27	9.43
25			11.16	8.86	12.06	8.75	12.89	9.35	13.27	9.28	13.68	9.22	14.51	9.63	15.34	9.45
27			11.08	8.82	12.05	8.74	12.92	9.37	13.31	9.30	13.69	9.22	14.47	9.62		
29			11.00	8.78	11.87	8.66	12.71	9.28	13.11	9.22	13.51	9.15	14.31	9.56		
31			10.92	8.74	11.69	8.58	12.49	9.18	12.90	9.13	13.32	9.08	14.15	9.50		
33	10.27	8.22	10.72	8.64	11.51	8.49	12.27	9.09	12.70	9.05	13.13	9.00	13.99	9.44		
35	10.07	8.12	10.55	8.56	11.33	8.41	12.06	9.00	12.50	8.97	12.94	8.93	13.83	9.38		
37	9.90	8.03	10.38	8.48	11.13	8.32	11.83	8.90	12.24	8.86	12.66	8.82	13.50	9.26		
39	9.72	7.94	10.20	8.39	10.94	8.24	11.60	8.81	11.99	8.76	12.38	8.71	13.16	9.14		
41	9.55	7.85	10.02	8.30	10.75	8.15	11.37	8.71	11.73	8.66	12.09	8.60	12.82	9.02		
43	9.38	7.76	9.85	8.22	10.56	8.07	11.14	8.62	11.47	8.56	11.81	8.49	12.48	8.90		

Outdoor air temp. °CDB	°CWB	Indoor air temperature °CDB				
		16	18	20	22	24
-19.8	-20	7.06	7.03	7.00	6.97	6.95
-17.7	-18	7.46	7.43	7.41	7.37	7.34
-15.7	-16	7.87	7.84	7.81	7.77	7.74
-13.5	-14	8.33	8.29	8.26	8.22	8.18
-11.5	-12	8.78	8.74	8.70	8.66	8.62
-9.5	-10	9.24	9.19	9.15	9.11	9.06
-7.5	-8	9.69	9.65	9.60	9.55	9.50
-5.5	-6	9.91	9.86	9.81	9.75	9.70
-3.0	-4	10.12	10.07	10.01	9.96	9.90
-1.0	-2	10.33	10.28	10.22	10.16	10.10
1.0	0	10.55	10.49	10.43	10.36	10.30
2.0	1	10.65	10.59	10.53	10.47	10.40
3.0	2	11.36	11.29	11.22	11.18	11.13
5.0	4	12.76	12.69	12.61	12.60	12.58
7.0	6	14.16	14.08	14.00	14.02	14.04
9.0	8	14.72	14.64	14.56	14.52	14.49
11.5	10	15.28	15.20	15.11	15.02	14.93
13.5	12	16.13	16.04	15.94	15.82	15.75
15.5	14	16.98	16.88	16.77	16.62	16.58
16.5	16	17.41	17.30	17.19	17.02	16.99

Note(1) These data show average status.

Depending on the system control, there may be ranges where the operation is not conducted continuously.

These data show the case where the operation frequency of a compressor is fixed.

(2) Capacities are based on the following conditions.

Corresponding refrigerant piping length :7.5m

Level difference of Zero.

(3) Symbols are as follows

TC :Total cooling capacity (kW)

SHC :Sensible heat capacity (kW)

HC :Heating capacity (kW)

PGA000Z772

Model **FD140VNVD** Indoor unit FDF140VD Outdoor unit FDC140VN
Cool Mode

(kW) Heat Mode:HC (kW)

Outdoor air temp. °CDB	Indoor air temperature															
	18°CDB		21°CDB		23°CDB		26°CDB		27°CDB		28°CDB		31°CDB		33°CDB	
	12°CWB		14°CWB		16°CWB		18°CWB		19°CWB		20°CWB		22°CWB		24°CWB	
	TC	SHC	TC	SHC	TC	SHC	TC	SHC	TC	SHC	TC	SHC	TC	SHC	TC	SHC
11					11.37	8.43	12.02	8.98	12.35	8.91	12.70	8.83	13.39	9.23	14.08	9.03
13					11.90	8.67	12.61	9.23	12.96	9.16	13.33	9.08	14.09	9.48	14.84	9.28
15					12.43	8.92	13.19	9.48	13.57	9.41	13.97	9.34	14.78	9.73	15.59	9.54
17					12.96	9.17	13.77	9.74	14.17	9.66	14.61	9.60	15.48	9.99	16.34	9.79
19					13.24	9.30	14.06	9.87	14.48	9.80	14.92	9.72	15.80	10.12	16.68	9.91
21					13.51	9.43	14.36	10.00	14.78	9.93	15.23	9.85	16.12	10.24	17.02	10.03
23					13.51	9.43	14.40	10.02	14.82	9.94	15.28	9.87	16.19	10.26	17.10	10.06
25			12.50	9.53	13.50	9.43	14.43	10.03	14.86	9.96	15.33	9.89	16.25	10.29	17.18	10.09
27			12.41	9.48	13.50	9.43	14.47	10.05	14.91	9.98	15.34	9.90	16.20	10.27		
29			12.32	9.44	13.29	9.33	14.23	9.94	14.68	9.88	15.13	9.81	16.02	10.20		
31			12.23	9.39	13.09	9.23	13.99	9.84	14.45	9.78	14.92	9.72	15.85	10.13		
33	11.51	8.88	12.01	9.28	12.89	9.14	13.75	9.73	14.23	9.69	14.71	9.64	15.67	10.07		
35	11.28	8.76	11.82	9.18	12.68	9.04	13.50	9.62	14.00	9.59	14.50	9.55	15.49	10.00		
37	11.08	8.65	11.62	9.08	12.47	8.94	13.25	9.51	13.71	9.47	14.18	9.42	15.12	9.86		
39	10.89	8.55	11.43	8.99	12.26	8.84	12.99	9.40	13.43	9.35	13.86	9.29	14.74	9.72		
41	10.70	8.45	11.23	8.89	12.04	8.74	12.73	9.28	13.14	9.23	13.55	9.17	14.36	9.58		
43	10.51	8.35	11.03	8.79	11.83	8.64	12.47	9.17	12.85	9.11	13.23	9.04	13.98	9.44		

Outdoor air temp. °CDB		Indoor air temperature °CDB				
°CDB	°CWB	16	18	20	22	24
-19.8	-20	8.06	8.03	8.00	7.97	7.94
-17.7	-18	8.53	8.50	8.46	8.43	8.39
-15.7	-16	9.00	8.96	8.92	8.88	8.85
-13.5	-14	9.52	9.48	9.43	9.39	9.35
-11.5	-12	10.04	9.99	9.95	9.90	9.85
-9.5	-10	10.56	10.51	10.46	10.41	10.36
-7.5	-8	11.08	11.02	10.97	10.91	10.86
-5.5	-6	11.32	11.26	11.21	11.15	11.09
-3.0	-4	11.56	11.50	11.44	11.38	11.31
-1.0	-2	11.81	11.75	11.68	11.61	11.54
1.0	0	12.05	11.99	11.92	11.84	11.77
2.0	1	12.18	12.11	12.04	11.96	11.89
3.0	2	12.98	12.90	12.83	12.77	12.72
5.0	4	14.58	14.50	14.41	14.40	14.38
7.0	6	16.19	16.09	16.00	16.02	16.05
9.0	8	16.83	16.73	16.63	16.59	16.55
11.5	10	17.46	17.37	17.27	17.17	17.06
13.5	12	18.44	18.33	18.22	18.08	18.00
15.5	14	19.41	19.29	19.17	18.99	18.95
16.5	16	19.90	19.77	19.64	19.45	19.42

PGA000Z772

Model **FD140VSVD** Indoor unit FDF140VD Outdoor unit FDC140VS
Cool Mode

(kW) Heat Mode:HC (kW)

Outdoor air temp. °CDB	Indoor air temperature															
	18°CDB		21°CDB		23°CDB		26°CDB		27°CDB		28°CDB		31°CDB		33°CDB	
	12°CWB		14°CWB		16°CWB		18°CWB		19°CWB		20°CWB		22°CWB		24°CWB	
	TC	SHC	TC	SHC	TC	SHC	TC	SHC	TC	SHC	TC	SHC	TC	SHC	TC	SHC
11					11.37	8.43	12.02	8.98	12.35	8.91	12.70	8.83	13.39	9.23	14.08	9.03
13					11.90	8.67	12.61	9.23	12.96	9.16	13.33	9.08	14.09	9.48	14.84	9.28
15					12.43	8.92	13.19	9.48	13.57	9.41	13.97	9.34	14.78	9.73	15.59	9.54
17					12.96	9.17	13.77	9.74	14.17	9.66	14.61	9.60	15.48	9.99	16.34	9.79
19					13.24	9.30	14.06	9.87	14.48	9.80	14.92	9.72	15.80	10.12	16.68	9.91
21					13.51	9.43	14.36	10.00	14.78	9.93	15.23	9.85	16.12	10.24	17.02	10.03
23					13.51	9.43	14.40	10.02	14.82	9.94	15.28	9.87	16.19	10.26	17.10	10.06
25			12.50	9.53	13.50	9.43	14.43	10.03	14.86	9.96	15.33	9.89	16.25	10.29	17.18	10.09
27			12.41	9.48	13.50	9.43	14.47	10.05	14.91	9.98	15.34	9.90	16.20	10.27		
29			12.32	9.44	13.29	9.33	14.23	9.94	14.68	9.88	15.13	9.81	16.02	10.20		
31			12.23	9.39	13.09	9.23	13.99	9.84	14.45	9.78	14.92	9.72	15.85	10.13		
33	11.51	8.88	12.01	9.28	12.89	9.14	13.75	9.73	14.23	9.69	14.71	9.64	15.67	10.07		
35	11.28	8.76	11.82	9.18	12.68	9.04	13.50	9.62	14.00	9.59	14.50	9.55	15.49	10.00		
37	11.08	8.65	11.62	9.08	12.47	8.94	13.25	9.51	13.71	9.47	14.18	9.42	15.12	9.86		
39	10.89	8.55	11.43	8.99	12.26	8.84	12.99	9.40	13.43	9.35	13.86	9.29	14.74	9.72		
41	10.70	8.45	11.23	8.89	12.04	8.74	12.73	9.28	13.14	9.23	13.55	9.17	14.36	9.58		
43	10.51	8.35	11.03	8.79	11.83	8.64	12.47	9.17	12.85	9.11	13.23	9.04	13.98	9.44		

Outdoor air temp. °CDB		Indoor air temperature °CDB				
°CDB	°CWB	16	18	20	22	24
-19.8	-20	8.06	8.03	8.00	7.97	7.94
-17.7	-18	8.53	8.50	8.46	8.43	8.39
-15.7	-16	9.00	8.96	8.92	8.88	8.85
-13.5	-14	9.52	9.48	9.43	9.39	9.35
-11.5	-12	10.04	9.99	9.95	9.90	9.85
-9.5	-10	10.56	10.51	10.46	10.41	10.36
-7.5	-8	11.08	11.02	10.97	10.91	10.86
-5.5	-6	11.32	11.26	11.21	11.15	11.09
-3.0	-4	11.56	11.50	11.44	11.38	11.31
-1.0	-2	11.81	11.75	11.68	11.61	11.54
1.0	0	12.05	11.99	11.92	11.84	11.77
2.0	1	12.18	12.11	12.04	11.96	11.89
3.0	2	12.98	12.90	12.83	12.77	12.72
5.0	4	14.58	14.50	14.41	14.40	14.38
7.0	6	16.19	16.09	16.00	16.02	16.05
9.0	8	16.83	16.73	16.63	16.59	16.55
11.5	10	17.46	17.37	17.27	17.17	17.06
13.5	12	18.44	18.33	18.22	18.08	18.00
15.5	14	19.41	19.29	19.17	18.99	18.95
16.5	16	19.90	19.77	19.64	19.45	19.42

Note(1) These data show average status.
Depending on the system control, there may be ranges where the operation is not conducted continuously.
These data show the case where the operation frequency of a compressor is fixed.

(2) Capacities are based on the following conditions.
Corresponding refrigerant piping length :7.5m
Level difference of Zero.

(3) Symbols are as follows
TC :Total cooling capacity (kW)
SHC :Sensible heat capacity (kW)
HC :Heating capacity (kW)

PGA000Z772

(b) Twin type

Model **FD140VNPVD1** Indoor unit FDF71VD1 (2 units) Outdoor unit FDC140VN
Cool Mode (kW)

Heat Mode:HC (kW)

Outdoor air temp. °CDB	Indoor air temperature															
	18°CDB		21°CDB		23°CDB		26°CDB		27°CDB		28°CDB		31°CDB		33°CDB	
	12°CWB	14°CWB	16°CWB	18°CWB	19°CWB	20°CWB	22°CWB	24°CWB	TC	SHC	TC	SHC	TC	SHC	TC	SHC
11					11.37	9.05	12.02	9.77	12.35	9.65	12.70	9.53	13.39	10.04	14.08	9.75
13					11.90	9.25	12.61	9.97	12.96	9.84	13.33	9.72	14.09	10.22	14.84	9.92
15					12.43	9.45	13.19	10.16	13.57	10.04	13.97	9.91	14.78	10.41	15.59	10.10
17					12.96	9.65	13.77	10.36	14.17	10.23	14.61	10.11	15.48	10.60	16.34	10.28
19					13.24	9.75	14.06	10.46	14.48	10.34	14.92	10.20	15.80	10.69	16.68	10.37
21					13.51	9.86	14.36	10.57	14.78	10.44	15.23	10.30	16.12	10.78	17.02	10.45
23					13.51	9.86	14.40	10.58	14.82	10.45	15.28	10.32	16.19	10.80	17.10	10.47
25			12.50	10.12	13.50	9.85	14.43	10.59	14.86	10.46	15.33	10.33	16.25	10.82	17.18	10.49
27			12.41	10.09	13.50	9.85	14.47	10.61	14.91	10.48	15.34	10.34	16.20	10.80		
29			12.32	10.05	13.29	9.77	14.23	10.52	14.68	10.40	15.13	10.27	16.02	10.75		
31			12.23	10.01	13.09	9.70	13.99	10.44	14.45	10.33	14.92	10.20	15.85	10.70		
33	11.51	9.38	12.01	9.92	12.89	9.62	13.75	10.36	14.23	10.25	14.71	10.14	15.67	10.65		
35	11.28	9.28	11.82	9.84	12.68	9.54	13.50	10.27	14.00	10.18	14.50	10.07	15.49	10.60		
37	11.08	9.19	11.62	9.76	12.47	9.46	13.25	10.18	13.71	10.08	14.18	9.97	15.12	10.50		
39	10.89	9.10	11.43	9.68	12.26	9.38	12.99	10.10	13.43	9.99	13.86	9.88	14.74	10.40		
41	10.70	9.02	11.23	9.60	12.04	9.30	12.73	10.01	13.14	9.90	13.55	9.78	14.36	10.29		
43	10.51	8.93	11.03	9.52	11.83	9.22	12.47	9.92	12.85	9.81	13.23	9.69	13.98	10.19		

Outdoor air temp. °CDB	°CWB	Indoor air temperature °CDB				
		16	18	20	22	24
-19.8	-20	8.06	8.03	8.00	7.97	7.94
-17.7	-18	8.53	8.50	8.46	8.43	8.39
-15.7	-16	9.00	8.96	8.92	8.88	8.85
-13.5	-14	9.52	9.48	9.43	9.39	9.35
-11.5	-12	10.04	9.99	9.95	9.90	9.85
-9.5	-10	10.56	10.51	10.46	10.41	10.36
-7.5	-8	11.08	11.02	10.97	10.91	10.86
-5.5	-6	11.32	11.26	11.21	11.15	11.09
-3.0	-4	11.56	11.50	11.44	11.38	11.31
-1.0	-2	11.81	11.75	11.68	11.61	11.54
1.0	0	12.05	11.99	11.92	11.84	11.77
2.0	1	12.18	12.11	12.04	11.96	11.89
3.0	2	12.98	12.90	12.83	12.77	12.72
5.0	4	14.58	14.50	14.41	14.40	14.38
7.0	6	16.19	16.09	16.00	16.02	16.05
9.0	8	16.83	16.73	16.63	16.59	16.55
11.5	10	17.46	17.37	17.27	17.17	17.06
13.5	12	18.44	18.33	18.22	18.08	18.00
15.5	14	19.41	19.29	19.17	18.99	18.95
16.5	16	19.90	19.77	19.64	19.45	19.42

PGA000Z772

Model **FD140VSPVD1** Indoor unit FDF71VD1 (2 units) Outdoor unit FDC140VS
Cool Mode (kW)

Heat Mode:HC (kW)

Outdoor air temp. °CDB	Indoor air temperature															
	18°CDB		21°CDB		23°CDB		26°CDB		27°CDB		28°CDB		31°CDB		33°CDB	
	12°CWB	14°CWB	16°CWB	18°CWB	19°CWB	20°CWB	22°CWB	24°CWB	TC	SHC	TC	SHC	TC	SHC	TC	SHC
11					11.37	9.05	12.02	9.77	12.35	9.65	12.70	9.53	13.39	10.04	14.08	9.75
13					11.90	9.25	12.61	9.97	12.96	9.84	13.33	9.72	14.09	10.22	14.84	9.92
15					12.43	9.45	13.19	10.16	13.57	10.04	13.97	9.91	14.78	10.41	15.59	10.10
17					12.96	9.65	13.77	10.36	14.17	10.23	14.61	10.11	15.48	10.60	16.34	10.28
19					13.24	9.75	14.06	10.46	14.48	10.34	14.92	10.20	15.80	10.69	16.68	10.37
21					13.51	9.86	14.36	10.57	14.78	10.44	15.23	10.30	16.12	10.78	17.02	10.45
23					13.51	9.86	14.40	10.58	14.82	10.45	15.28	10.32	16.19	10.80	17.10	10.47
25			12.50	10.12	13.50	9.85	14.43	10.59	14.86	10.46	15.33	10.33	16.25	10.82	17.18	10.49
27			12.41	10.09	13.50	9.85	14.47	10.61	14.91	10.48	15.34	10.34	16.20	10.80		
29			12.32	10.05	13.29	9.77	14.23	10.52	14.68	10.40	15.13	10.27	16.02	10.75		
31			12.23	10.01	13.09	9.70	13.99	10.44	14.45	10.33	14.92	10.20	15.85	10.70		
33	11.51	9.38	12.01	9.92	12.89	9.62	13.75	10.36	14.23	10.25	14.71	10.14	15.67	10.65		
35	11.28	9.28	11.82	9.84	12.68	9.54	13.50	10.27	14.00	10.18	14.50	10.07	15.49	10.60		
37	11.08	9.19	11.62	9.76	12.47	9.46	13.25	10.18	13.71	10.08	14.18	9.97	15.12	10.50		
39	10.89	9.10	11.43	9.68	12.26	9.38	12.99	10.10	13.43	9.99	13.86	9.88	14.74	10.40		
41	10.70	9.02	11.23	9.60	12.04	9.30	12.73	10.01	13.14	9.90	13.55	9.78	14.36	10.29		
43	10.51	8.93	11.03	9.52	11.83	9.22	12.47	9.92	12.85	9.81	13.23	9.69	13.98	10.19		

Outdoor air temp. °CDB	°CWB	Indoor air temperature °CDB				
		16	18	20	22	24
-19.8	-20	8.06	8.03	8.00	7.97	7.94
-17.7	-18	8.53	8.50	8.46	8.43	8.39
-15.7	-16	9.00	8.96	8.92	8.88	8.85
-13.5	-14	9.52	9.48	9.43	9.39	9.35
-11.5	-12	10.04	9.99	9.95	9.90	9.85
-9.5	-10	10.56	10.51	10.46	10.41	10.36
-7.5	-8	11.08	11.02	10.97	10.91	10.86
-5.5	-6	11.32	11.26	11.21	11.15	11.09
-3.0	-4	11.56	11.50	11.44	11.38	11.31
-1.0	-2	11.81	11.75	11.68	11.61	11.54
1.0	0	12.05	11.99	11.92	11.84	11.77
2.0	1	12.18	12.11	12.04	11.96	11.89
3.0	2	12.98	12.90	12.83	12.77	12.72
5.0	4	14.58	14.50	14.41	14.40	14.38
7.0	6	16.19	16.09	16.00	16.02	16.05
9.0	8	16.83	16.73	16.63	16.59	16.55
11.5	10	17.46	17.37	17.27	17.17	17.06
13.5	12	18.44	18.33	18.22	18.08	18.00
15.5	14	19.41	19.29	19.17	18.99	18.95
16.5	16	19.90	19.77	19.64	19.45	19.42

Note(1) These data show average status.

Depending on the system control, there may be ranges where the operation is not conducted continuously.

These data show the case where the operation frequency of a compressor is fixed.

(2) Capacities are based on the following conditions.

Corresponding refrigerant piping length :7.5m

Level difference of Zero.

(3) Symbols are as follows

TC : Total cooling capacity (kW)

SHC :Sensible heat capacity (kW)

HC :Heating capacity (kW)

PGA000Z772

Model **FD200VSPVD1** Indoor unit FDF100VD1 (2 units) Outdoor unit FDC200VS
 Cool Mode (kW) Heat Mode:HC (kW)

Outdoor air temp.	Indoor air temperature															
	18°CDB		21°CDB		23°CDB		26°CDB		27°CDB		28°CDB		31°CDB		33°CDB	
	12°CWB		14°CWB		16°CWB		18°CWB		19°CWB		20°CWB		22°CWB		24°CWB	
°CDB	TC	SHC	TC	SHC	TC	SHC	TC	SHC	TC	SHC	TC	SHC	TC	SHC	TC	SHC
11					17.37	14.52	18.41	15.69	18.94	15.58	19.50	15.47	20.63	16.34	21.76	16.06
13					17.90	14.74	18.99	15.92	19.54	15.80	20.13	15.69	21.31	16.57	22.49	16.28
15					18.43	14.97	19.57	16.14	20.14	16.03	20.75	15.92	21.98	16.79	23.21	16.50
17					18.96	15.19	20.14	16.37	20.73	16.25	21.38	16.15	22.66	17.02	23.94	16.72
19					19.35	15.36	20.56	16.54	21.16	16.42	21.81	16.31	23.12	17.18	24.42	16.87
21					19.41	15.39	20.98	16.71	21.59	16.59	22.25	16.47	23.57	17.33	24.89	17.02
23					19.31	15.35	20.86	16.66	21.47	16.54	22.12	16.42	23.43	17.28	24.73	16.97
25			17.35	15.35	19.20	15.30	20.74	16.61	21.35	16.49	21.99	16.38	23.28	17.23	24.57	16.92
27			17.28	15.32	19.10	15.25	20.62	16.56	21.22	16.44	21.83	16.32	23.04	17.15		
29			17.14	15.25	18.85	15.15	20.31	16.44	20.92	16.33	21.53	16.21	22.75	17.05		
31			16.99	15.19	18.59	15.04	20.00	16.31	20.61	16.21	21.22	16.09	22.45	16.95		
33	16.46	14.38	17.03	15.20	18.33	14.93	19.69	16.19	20.31	16.09	20.92	15.98	22.15	16.85		
35	16.14	14.23	16.76	15.08	18.08	14.82	19.38	16.07	20.00	15.98	20.62	15.87	21.85	16.75		
37	15.86	14.09	16.50	14.96	17.76	14.68	18.98	15.91	19.57	15.81	20.17	15.71	21.35	16.58		
39	15.59	13.96	16.23	14.84	17.44	14.55	18.58	15.76	19.15	15.66	19.71	15.54	20.85	16.42		
41	15.32	13.83	15.97	14.73	17.13	14.42	18.17	15.60	18.72	15.50	19.26	15.38	20.35	16.25		
43	15.04	13.69	15.70	14.60	16.81	14.29	17.77	15.44	18.29	15.34	18.81	15.22	19.85	16.09		

Outdoor air temp.		Indoor air temperature °CDB				
°CDB	°CWB	16	18	20	22	24
-19.8	-20					
-17.7	-18					
-15.7	-16					
-13.5	-14	13.21	13.18	13.14	13.11	13.08
-11.5	-12	13.91	13.87	13.83	13.79	13.76
-9.5	-10	14.61	14.57	14.52	14.47	14.43
-7.5	-8	15.31	15.26	15.21	15.16	15.10
-5.5	-6	15.64	15.58	15.52	15.46	15.40
-3.0	-4	15.96	15.89	15.82	15.76	15.69
-1.0	-2	16.29	16.21	16.13	16.06	15.98
1.0	0	16.61	16.53	16.44	16.36	16.28
2.0	1	16.78	16.69	16.59	16.51	16.42
3.0	2	17.96	17.86	17.76	17.66	17.56
5.0	4	20.33	20.21	20.08	19.96	19.84
7.0	6	22.71	22.55	22.40	22.26	22.12
9.0	8	23.43	23.28	23.13	22.88	22.63
11.5	10	24.14	24.00	23.86	23.50	23.13
13.5	12	25.41	25.24	25.07	24.77	24.43
15.5	14	26.67	26.47	26.27	26.05	25.72
16.5	16	27.30	27.09	26.87	26.69	26.37

PGA000Z772

Model **FD250VSPVD** Indoor unit FDF125VD (2 units) Outdoor unit FDC250VS
 Cool Mode (kW) Heat Mode:HC (kW)

Outdoor air temp.	Indoor air temperature															
	18°CDB		21°CDB		23°CDB		26°CDB		27°CDB		28°CDB		31°CDB		33°CDB	
	12°CWB		14°CWB		16°CWB		18°CWB		19°CWB		20°CWB		22°CWB		24°CWB	
°CDB	TC	SHC	TC	SHC	TC	SHC	TC	SHC	TC	SHC	TC	SHC	TC	SHC	TC	SHC
11					21.71	16.40	23.02	17.54	23.67	17.40	24.38	17.28	25.79	18.10	27.21	17.76
13					22.38	16.70	23.74	17.84	24.42	17.70	25.16	17.58	26.63	18.40	28.11	18.05
15					23.04	17.00	24.46	18.14	25.17	18.01	25.94	17.88	27.48	18.70	29.02	18.35
17					23.70	17.30	25.18	18.45	25.92	18.31	26.72	18.19	28.32	19.01	29.92	18.65
19					24.19	17.53	25.70	18.67	26.45	18.53	27.27	18.40	28.89	19.22	30.52	18.85
21					24.26	17.56	26.22	18.90	26.99	18.76	27.82	18.63	29.47	19.43	31.12	19.05
23					24.13	17.50	26.07	18.83	26.84	18.69	27.65	18.56	29.28	19.36	30.91	18.98
25			21.69	17.40	24.00	17.44	25.92	18.77	26.68	18.63	27.49	18.49	29.10	19.29	30.71	18.91
27			21.60	17.36	23.88	17.38	25.77	18.70	26.53	18.57	27.29	18.41	28.80	19.18		
29			21.42	17.27	23.56	17.24	25.39	18.54	26.15	18.41	26.91	18.26	28.43	19.05		
31			21.24	17.18	23.24	17.09	25.00	18.37	25.77	18.25	26.53	18.11	28.06	18.91		
33	20.58	16.47	21.29	17.21	22.92	16.94	24.61	18.21	25.38	18.09	26.15	17.96	27.69	18.78		
35	20.17	16.25	20.96	17.05	22.60	16.80	24.23	18.05	25.00	17.94	25.77	17.81	27.31	18.64		
37	19.83	16.08	20.62	16.88	22.20	16.62	23.73	17.84	24.47	17.72	25.21	17.60	26.69	18.42		
39	19.49	15.90	20.29	16.73	21.80	16.44	23.22	17.62	23.93	17.51	24.64	17.38	26.06	18.20		
41	19.15	15.73	19.96	16.57	21.41	16.27	22.72	17.42	23.40	17.29	24.08	17.16	25.43	17.97		
43	18.81	15.56	19.63	16.41	21.01	16.09	22.22	17.21	22.86	17.08	23.51	16.94	24.81	17.76		

Outdoor air temp.		Indoor air temperature °CDB				
°CDB	°CWB	16	18	20	22	24
-19.8	-20					
-17.7	-18					
-15.7	-16					
-13.5	-14	16.52	16.47	16.43	16.39	16.35
-11.5	-12	17.39	17.34	17.29	17.24	17.19
-9.5	-10	18.26	18.21	18.15	18.09	18.04
-7.5	-8	19.14	19.07	19.01	18.94	18.88
-5.5	-6	19.55	19.47	19.40	19.32	19.24
-3.0	-4	19.95	19.87	19.78	19.70	19.61
-1.0	-2	20.36	20.26	20.17	20.07	19.98
1.0	0	20.77	20.66	20.55	20.45	20.35
2.0	1	20.97	20.86	20.74	20.64	20.53
3.0	2	22.45	22.32	22.19	22.07	21.95
5.0	4	25.42	25.26	25.10	24.95	24.80
7.0	6	28.38	28.19	28.00	27.82	27.65
9.0	8	29.28	29.10	28.91	28.60	28.28
11.5	10	30.18	30.00	29.83	29.37	28.91
13.5	12	31.76	31.55	31.33	30.97	30.53
15.5	14	33.34	33.09	32.84	32.57	32.15
16.5	16	34.13	33.86	33.59	33.37	32.96

PGA000Z772

Note(1) These data show average status.
 Depending on the system control, there may be ranges where the operation is not conducted continuously.
 These data show the case where the operation frequency of a compressor is fixed.
 (2) Capacities are based on the following conditions.
 Corresponding refrigerant piping length :7.5m
 Level difference of Zero.
 (3) Symbols are as follows
 TC :Total cooling capacity (kW)
 SHC :Sensible heat capacity (kW)
 HC :Heating capacity (kW)

(7) Wall mounted type (SRK)

(a) Twin type

Model **SRK100VNPZMX** Indoor unit SRK50ZMX-S (2 units) Outdoor unit FDC100VN

Cool Mode (kW)

Heat Mode:HC (kW)

Outdoor air temp.	Indoor air temperature															
	18 DB		21 DB		23 DB		26 DB		27 DB		28 DB		31 DB		33 DB	
	12 WB		14 WB		16 WB		18 WB		19 WB		20 WB		22 WB		24 WB	
DB	TC	SHC	TC	SHC	TC	SHC	TC	SHC	TC	SHC	TC	SHC	TC	SHC	TC	SHC
11					8.12	6.78	8.59	7.32	8.82	7.26	9.07	7.21	9.56	7.61	10.06	7.47
13					8.50	6.94	9.00	7.48	9.26	7.43	9.52	7.37	10.06	7.77	10.60	7.63
15					8.88	7.11	9.42	7.65	9.69	7.59	9.98	7.54	10.56	7.94	11.14	7.80
17					9.26	7.27	9.84	7.82	10.12	7.76	10.43	7.71	11.05	8.11	11.67	7.97
19					9.46	7.36	10.05	7.90	10.34	7.85	10.65	7.79	11.29	8.19	11.92	8.04
21					9.65	7.44	10.25	7.99	10.56	7.93	10.88	7.88	11.52	8.27	12.16	8.12
23					9.65	7.44	10.28	8.00	10.59	7.94	10.91	7.89	11.56	8.29	12.21	8.14
25			8.93	7.55	9.64	7.44	10.31	8.01	10.62	7.96	10.95	7.90	11.61	8.30	12.27	8.16
27			8.86	7.52	9.64	7.44	10.34	8.02	10.65	7.97	10.96	7.91	11.57	8.29		
29			8.80	7.49	9.50	7.38	10.17	7.95	10.49	7.91	10.81	7.85	11.45	8.25		
31			8.73	7.46	9.35	7.31	9.99	7.88	10.32	7.84	10.66	7.79	11.32	8.20		
33	8.22	6.98	8.58	7.39	9.21	7.25	9.82	7.81	10.16	7.78	10.51	7.74	11.19	8.16		
35	8.05	6.89	8.44	7.32	9.06	7.18	9.64	7.74	10.00	7.71	10.36	7.68	11.07	8.12		
37	7.92	6.83	8.30	7.26	8.91	7.12	9.46	7.67	9.79	7.63	10.13	7.60	10.80	8.02		
39	7.78	6.76	8.16	7.19	8.75	7.05	9.28	7.59	9.59	7.56	9.90	7.51	10.53	7.93		
41	7.64	6.69	8.02	7.13	8.60	6.99	9.09	7.52	9.38	7.48	9.68	7.43	10.26	7.84		
43	7.50	6.62	7.88	7.07	8.45	6.92	8.91	7.45	9.18	7.40	9.45	7.35	9.99	7.75		

Outdoor air temp.	Indoor air temperature											
	DB		16		18		20		22		24	
	DB	WB	16	18	20	22	24					
-19.8	-20	5.64	5.62	5.60	5.58	5.56						
-17.7	-18	5.97	5.95	5.92	5.90	5.87						
-15.7	-16	6.30	6.27	6.25	6.22	6.19						
-13.5	-14	6.66	6.63	6.60	6.57	6.54						
-11.5	-12	7.03	6.99	6.96	6.93	6.90						
-9.5	-10	7.39	7.36	7.32	7.29	7.25						
-7.5	-8	7.75	7.72	7.68	7.64	7.60						
-5.5	-6	7.92	7.88	7.85	7.80	7.76						
-3.0	-4	8.10	8.05	8.01	7.97	7.92						
-1.0	-2	8.27	8.22	8.18	8.13	8.08						
1.0	0	8.44	8.39	8.34	8.29	8.24						
2.0	1	8.52	8.47	8.42	8.37	8.32						
3.0	2	9.08	9.03	8.98	8.94	8.90						
5.0	4	10.21	10.15	10.09	10.08	10.07						
7.0	6	11.33	11.27	11.20	11.22	11.23						
9.0	8	11.78	11.71	11.64	11.62	11.59						
11.5	10	12.23	12.16	12.09	12.02	11.94						
13.5	12	12.91	12.83	12.75	12.65	12.60						
15.5	14	13.59	13.50	13.42	13.29	13.26						
16.5	16	13.93	13.84	13.75	13.61	13.59						

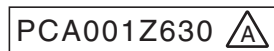

Model **SRK100VSPZMX** Indoor unit SRK50ZMX-S (2 units) Outdoor unit FDC100VS

Cool Mode (kW)

Heat Mode:HC (kW)

Outdoor air temp.	Indoor air temperature															
	18 DB		21 DB		23 DB		26 DB		27 DB		28 DB		31 DB		33 DB	
	12 WB		14 WB		16 WB		18 WB		19 WB		20 WB		22 WB		24 WB	
DB	TC	SHC	TC	SHC	TC	SHC	TC	SHC	TC	SHC	TC	SHC	TC	SHC	TC	SHC
11					8.12	6.78	8.59	7.32	8.82	7.26	9.07	7.21	9.56	7.61	10.06	7.47
13					8.50	6.94	9.00	7.48	9.26	7.43	9.52	7.37	10.06	7.77	10.60	7.63
15					8.88	7.11	9.42	7.65	9.69	7.59	9.98	7.54	10.56	7.94	11.14	7.80
17					9.26	7.27	9.84	7.82	10.12	7.76	10.43	7.71	11.05	8.11	11.67	7.97
19					9.46	7.36	10.05	7.90	10.34	7.85	10.65	7.79	11.29	8.19	11.92	8.04
21					9.65	7.44	10.25	7.99	10.56	7.93	10.88	7.88	11.52	8.27	12.16	8.12
23					9.65	7.44	10.28	8.00	10.59	7.94	10.91	7.89	11.56	8.29	12.21	8.14
25			8.93	7.55	9.64	7.44	10.31	8.01	10.62	7.96	10.95	7.90	11.61	8.30	12.27	8.16
27			8.86	7.52	9.64	7.44	10.34	8.02	10.65	7.97	10.96	7.91	11.57	8.29		
29			8.80	7.49	9.50	7.38	10.17	7.95	10.49	7.91	10.81	7.85	11.45	8.25		
31			8.73	7.46	9.35	7.31	9.99	7.88	10.32	7.84	10.66	7.79	11.32	8.20		
33	8.22	6.98	8.58	7.39	9.21	7.25	9.82	7.81	10.16	7.78	10.51	7.74	11.19	8.16		
35	8.05	6.89	8.44	7.32	9.06	7.18	9.64	7.74	10.00	7.71	10.36	7.68	11.07	8.12		
37	7.92	6.83	8.30	7.26	8.91	7.12	9.46	7.67	9.79	7.63	10.13	7.60	10.80	8.02		
39	7.78	6.76	8.16	7.19	8.75	7.05	9.28	7.59	9.59	7.56	9.90	7.51	10.53	7.93		
41	7.64	6.69	8.02	7.13	8.60	6.99	9.09	7.52	9.38	7.48	9.68	7.43	10.26	7.84		
43	7.50	6.62	7.88	7.07	8.45	6.92	8.91	7.45	9.18	7.40	9.45	7.35	9.99	7.75		

Outdoor air temp.	Indoor air temperature											
	DB		16		18		20		22		24	
	DB	WB	16	18	20	22	24					
-19.8	-20	5.64	5.62	5.60	5.58	5.56						
-17.7	-18	5.97	5.95	5.92	5.90	5.87						
-15.7	-16	6.30	6.27	6.25	6.22	6.19						
-13.5	-14	6.66	6.63	6.60	6.57	6.54						
-11.5	-12	7.03	6.99	6.96	6.93	6.90						
-9.5	-10	7.39	7.36	7.32	7.29	7.25						
-7.5	-8	7.75	7.72	7.68	7.64	7.60						
-5.5	-6	7.92	7.88	7.85	7.80	7.76						
-3.0	-4	8.10	8.05	8.01	7.97	7.92						
-1.0	-2	8.27	8.22	8.18	8.13	8.08						
1.0	0	8.44	8.39	8.34	8.29	8.24						
2.0	1	8.52	8.47	8.42	8.37	8.32						
3.0	2	9.08	9.03	8.98	8.94	8.90						
5.0	4	10.21	10.15	10.09	10.08	10.07						
7.0	6	11.33	11.27	11.20	11.22	11.23						
9.0	8	11.78	11.71	11.64	11.62	11.59						
11.5	10	12.23	12.16	12.09	12.02	11.94						
13.5	12	12.91	12.83	12.75	12.65	12.60						
15.5	14	13.59	13.50	13.42	13.29	13.26						
16.5	16	13.93	13.84	13.75	13.61	13.59						

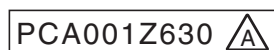

Note(1) These data show average statuses.
Depending on the system control, there may be ranges where the operation is not conducted continuously.
These data show the case where the operation frequency of a compressor is fixed.

(2) Capacities are based on the following conditions.
Corresponding refrigerant piping length :7.5m
Level difference of Zero.

(3) Symbols are as follows.
TC : Total cooling capacity (kW)
SHC : Sensible heat capacity (kW)
HC : Heating capacity (kW)

Model **SRK125VNPZMX** Indoor unit SRK60ZMX-S (2 units) Outdoor unit FDC125VN
Cool Mode

(kW) Heat Mode:HC (kW)

Outdoor air temp.	Indoor air temperature															
	18 DB		21 DB		23 DB		26 DB		27 DB		28 DB		31 DB		33 DB	
	12 WB	14 WB	16 WB	18 WB	19 WB	20 WB	22 WB	24 WB	TC	SHC	TC	SHC	TC	SHC	TC	SHC
DB	TC	SHC	TC	SHC	TC	SHC	TC	SHC	TC	SHC	TC	SHC	TC	SHC	TC	SHC
11					10.15	7.69	10.74	8.24	11.03	8.16	11.34	8.08	11.96	8.46	12.57	8.26
13					10.63	7.90	11.26	8.44	11.57	8.36	11.91	8.28	12.58	8.66	13.25	8.46
15					11.10	8.10	11.78	8.65	12.11	8.57	12.47	8.49	13.20	8.87	13.92	8.66
17					11.58	8.31	12.29	8.86	12.65	8.78	13.04	8.70	13.82	9.08	14.59	8.87
19					11.82	8.42	12.56	8.97	12.92	8.88	13.32	8.80	14.11	9.18	14.90	8.97
21					12.06	8.53	12.82	9.08	13.19	8.99	13.60	8.91	14.40	9.28	15.20	9.06
23					12.06	8.53	12.85	9.09	13.23	9.01	13.64	8.93	14.45	9.30	15.27	9.08
25			11.16	8.66	12.06	8.53	12.89	9.11	13.27	9.02	13.68	8.94	14.51	9.32	15.34	9.11
27			11.08	8.62	12.05	8.52	12.92	9.12	13.31	9.04	13.69	8.95	14.47	9.31		
29			11.00	8.59	11.87	8.44	12.71	9.03	13.11	8.96	13.51	8.88	14.31	9.25		
31			10.92	8.55	11.69	8.36	12.49	8.94	12.90	8.87	13.32	8.80	14.15	9.20		
33	10.27	8.06	10.72	8.45	11.51	8.28	12.27	8.85	12.70	8.80	13.13	8.73	13.99	9.14		
35	10.07	7.95	10.55	8.37	11.33	8.20	12.06	8.76	12.50	8.72	12.94	8.66	13.83	9.08		
37	9.90	7.87	10.38	8.29	11.13	8.12	11.83	8.67	12.24	8.62	12.66	8.56	13.50	8.97		
39	9.72	7.78	10.20	8.21	10.94	8.03	11.60	8.58	11.99	8.52	12.38	8.45	13.16	8.86		
41	9.55	7.69	10.02	8.13	10.75	7.95	11.37	8.49	11.73	8.42	12.09	8.35	12.82	8.74		
43	9.38	7.61	9.85	8.05	10.56	7.87	11.14	8.39	11.47	8.32	11.81	8.24	12.48	8.63		

Outdoor air temp.		Indoor air temperature					
DB	WB	16	18	20	22	24	
-19.8	-20	7.06	7.03	7.00	6.97	6.95	
-17.7	-18	7.46	7.43	7.41	7.37	7.34	
-15.7	-16	7.87	7.84	7.81	7.77	7.74	
-13.5	-14	8.33	8.29	8.26	8.22	8.18	
-11.5	-12	8.78	8.74	8.70	8.66	8.62	
-9.5	-10	9.24	9.19	9.15	9.11	9.06	
-7.5	-8	9.69	9.65	9.60	9.55	9.50	
-5.5	-6	9.91	9.86	9.81	9.75	9.70	
-3.0	-4	10.12	10.07	10.01	9.96	9.90	
-1.0	-2	10.33	10.28	10.22	10.16	10.10	
1.0	0	10.55	10.49	10.43	10.36	10.30	
2.0	1	10.65	10.59	10.53	10.47	10.40	
3.0	2	11.36	11.29	11.22	11.18	11.13	
5.0	4	12.76	12.69	12.61	12.60	12.58	
7.0	6	14.16	14.08	14.00	14.02	14.04	
9.0	8	14.72	14.64	14.56	14.52	14.49	
11.5	10	15.28	15.20	15.11	15.02	14.93	
13.5	12	16.13	16.04	15.94	15.82	15.75	
15.5	14	16.98	16.88	16.77	16.62	16.58	
16.5	16	17.41	17.30	17.19	17.02	16.99	

PCA001Z630 

Model **SRK125VSPZMX** Indoor unit SRK60ZMX-S (2 units) Outdoor unit FDC125VS
Cool Mode

(kW) Heat Mode:HC (kW)

Outdoor air temp.	Indoor air temperature															
	18 DB		21 DB		23 DB		26 DB		27 DB		28 DB		31 DB		33 DB	
	12 WB	14 WB	16 WB	18 WB	19 WB	20 WB	22 WB	24 WB	TC	SHC	TC	SHC	TC	SHC	TC	SHC
DB	TC	SHC	TC	SHC	TC	SHC	TC	SHC	TC	SHC	TC	SHC	TC	SHC	TC	SHC
11					10.15	7.69	10.74	8.24	11.03	8.16	11.34	8.08	11.96	8.46	12.57	8.26
13					10.63	7.90	11.26	8.44	11.57	8.36	11.91	8.28	12.58	8.66	13.25	8.46
15					11.10	8.10	11.78	8.65	12.11	8.57	12.47	8.49	13.20	8.87	13.92	8.66
17					11.58	8.31	12.29	8.86	12.65	8.78	13.04	8.70	13.82	9.08	14.59	8.87
19					11.82	8.42	12.56	8.97	12.92	8.88	13.32	8.80	14.11	9.18	14.90	8.97
21					12.06	8.53	12.82	9.08	13.19	8.99	13.60	8.91	14.40	9.28	15.20	9.06
23					12.06	8.53	12.85	9.09	13.23	9.01	13.64	8.93	14.45	9.30	15.27	9.08
25			11.16	8.66	12.06	8.53	12.89	9.11	13.27	9.02	13.68	8.94	14.51	9.32	15.34	9.11
27			11.08	8.62	12.05	8.52	12.92	9.12	13.31	9.04	13.69	8.95	14.47	9.31		
29			11.00	8.59	11.87	8.44	12.71	9.03	13.11	8.96	13.51	8.88	14.31	9.25		
31			10.92	8.55	11.69	8.36	12.49	8.94	12.90	8.87	13.32	8.80	14.15	9.20		
33	10.27	8.06	10.72	8.45	11.51	8.28	12.27	8.85	12.70	8.80	13.13	8.73	13.99	9.14		
35	10.07	7.95	10.55	8.37	11.33	8.20	12.06	8.76	12.50	8.72	12.94	8.66	13.83	9.08		
37	9.90	7.87	10.38	8.29	11.13	8.12	11.83	8.67	12.24	8.62	12.66	8.56	13.50	8.97		
39	9.72	7.78	10.20	8.21	10.94	8.03	11.60	8.58	11.99	8.52	12.38	8.45	13.16	8.86		
41	9.55	7.69	10.02	8.13	10.75	7.95	11.37	8.49	11.73	8.42	12.09	8.35	12.82	8.74		
43	9.38	7.61	9.85	8.05	10.56	7.87	11.14	8.39	11.47	8.32	11.81	8.24	12.48	8.63		

Outdoor air temp.		Indoor air temperature					
DB	WB	16	18	20	22	24	
-19.8	-20	7.06	7.03	7.00	6.97	6.95	
-17.7	-18	7.46	7.43	7.41	7.37	7.34	
-15.7	-16	7.87	7.84	7.81	7.77	7.74	
-13.5	-14	8.33	8.29	8.26	8.22	8.18	
-11.5	-12	8.78	8.74	8.70	8.66	8.62	
-9.5	-10	9.24	9.19	9.15	9.11	9.06	
-7.5	-8	9.69	9.65	9.60	9.55	9.50	
-5.5	-6	9.91	9.86	9.81	9.75	9.70	
-3.0	-4	10.12	10.07	10.01	9.96	9.90	
-1.0	-2	10.33	10.28	10.22	10.16	10.10	
1.0	0	10.55	10.49	10.43	10.36	10.30	
2.0	1	10.65	10.59	10.53	10.47	10.40	
3.0	2	11.36	11.29	11.22	11.18	11.13	
5.0	4	12.76	12.69	12.61	12.60	12.58	
7.0	6	14.16	14.08	14.00	14.02	14.04	
9.0	8	14.72	14.64	14.56	14.52	14.49	
11.5	10	15.28	15.20	15.11	15.02	14.93	
13.5	12	16.13	16.04	15.94	15.82	15.75	
15.5	14	16.98	16.88	16.77	16.62	16.58	
16.5	16	17.41	17.30	17.19	17.02	16.99	

PCA001Z630 

Note(1) These data show average statuses.
Depending on the system control, there may be ranges where the operation is not conducted continuously.
These data show the case where the operation frequency of a compressor is fixed.
(2) Capacities are based on the following conditions.
Corresponding refrigerant piping length : 7.5m
Level difference of Zero.
(3) Symbols are as follows.
TC : Total cooling capacity (kW)
SHC : Sensible heat capacity (kW)
HC : Heating capacity (kW)

(b) Triple type

Model **SRK140VNTZMX** Indoor unit SRK50ZMX-S (3 units) Outdoor unit FDC140VN
Cool Mode (kW) Heat Mode:HC (kW)

Outdoor air temp.	Indoor air temperature															
	18 DB		21 DB		23 DB		26 DB		27 DB		28 DB		31 DB		33 DB	
	12 WB	14 WB	16 WB	18 WB	19 WB	20 WB	22 WB	24 WB	TC	SHC	TC	SHC	TC	SHC	TC	SHC
DB	TC	SHC	TC	SHC	TC	SHC	TC	SHC	TC	SHC	TC	SHC	TC	SHC	TC	SHC
11					11.37	9.84	12.02	10.65	12.35	10.57	12.70	10.49	13.39	11.10	14.08	10.90
13					11.90	10.06	12.61	10.88	12.96	10.80	13.33	10.72	14.09	11.33	14.84	11.13
15					12.43	10.28	13.19	11.10	13.57	11.02	13.97	10.95	14.78	11.56	15.59	11.36
17					12.96	10.51	13.77	11.33	14.17	11.25	14.61	11.18	15.48	11.79	16.34	11.59
19					13.24	10.63	14.06	11.45	14.48	11.37	14.92	11.29	15.80	11.90	16.68	11.69
21					13.51	10.74	14.36	11.57	14.78	11.49	15.23	11.41	16.12	12.01	17.02	11.80
23					13.51	10.74	14.40	11.58	14.82	11.50	15.28	11.43	16.19	12.03	17.10	11.82
25			12.50	10.91	13.50	10.74	14.43	11.59	14.86	11.52	15.33	11.44	16.25	12.05	17.18	11.85
27			12.41	10.87	13.50	10.74	14.47	11.61	14.91	11.54	15.34	11.45	16.20	12.03		
29			12.32	10.83	13.29	10.65	14.23	11.51	14.68	11.45	15.13	11.37	16.02	11.97		
31			12.23	10.79	13.09	10.56	13.99	11.42	14.45	11.36	14.92	11.29	15.85	11.92		
33	11.51	10.06	12.01	10.68	12.89	10.48	13.75	11.32	14.23	11.27	14.71	11.22	15.67	11.85		
35	11.28	9.95	11.82	10.60	12.68	10.39	13.50	11.22	14.00	11.19	14.50	11.14	15.49	11.79		
37	11.08	9.85	11.62	10.51	12.47	10.30	13.25	11.13	13.71	11.08	14.18	11.02	15.12	11.67		
39	10.89	9.76	11.43	10.42	12.26	10.21	12.99	11.02	13.43	10.97	13.86	10.91	14.74	11.54		
41	10.70	9.67	11.23	10.33	12.04	10.12	12.73	10.92	13.14	10.86	13.55	10.79	14.36	11.42		
43	10.51	9.58	11.03	10.24	11.83	10.03	12.47	10.82	12.85	10.75	13.23	10.68	13.98	11.29		

Outdoor air temp.	Indoor air temperature					
	DB					
	16	18	20	22	24	
DB	WB	16	18	20	22	24
-19.8	-20	8.06	8.03	8.00	7.97	7.94
-17.7	-18	8.53	8.50	8.46	8.43	8.39
-15.7	-16	9.00	8.96	8.92	8.88	8.85
-13.5	-14	9.52	9.48	9.43	9.39	9.35
-11.5	-12	10.04	9.99	9.95	9.90	9.85
-9.5	-10	10.56	10.51	10.46	10.41	10.36
-7.5	-8	11.08	11.02	10.97	10.91	10.86
-5.5	-6	11.32	11.26	11.21	11.15	11.09
-3.0	-4	11.56	11.50	11.44	11.38	11.31
-1.0	-2	11.81	11.75	11.68	11.61	11.54
1.0	0	12.05	11.99	11.92	11.84	11.77
2.0	1	12.18	12.11	12.04	11.96	11.89
3.0	2	12.98	12.90	12.83	12.77	12.72
5.0	4	14.58	14.50	14.41	14.40	14.38
7.0	6	16.19	16.09	16.00	16.02	16.05
9.0	8	16.83	16.73	16.63	16.59	16.55
11.5	10	17.46	17.37	17.27	17.17	17.06
13.5	12	18.44	18.33	18.22	18.08	18.00
15.5	14	19.41	19.29	19.17	18.99	18.95
16.5	16	19.90	19.77	19.64	19.45	19.42

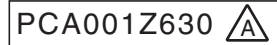

Model **SRK140VSTZMX** Indoor unit SRK50ZMX-S (3 units) Outdoor unit FDC140VS
Cool Mode (kW) Heat Mode:HC (kW)

Outdoor air temp.	Indoor air temperature															
	18 DB		21 DB		23 DB		26 DB		27 DB		28 DB		31 DB		33 DB	
	12 WB	14 WB	16 WB	18 WB	19 WB	20 WB	22 WB	24 WB	TC	SHC	TC	SHC	TC	SHC	TC	SHC
DB	TC	SHC	TC	SHC	TC	SHC	TC	SHC	TC	SHC	TC	SHC	TC	SHC	TC	SHC
11					11.37	9.84	12.02	10.65	12.35	10.57	12.70	10.49	13.39	11.10	14.08	10.90
13					11.90	10.06	12.61	10.88	12.96	10.80	13.33	10.72	14.09	11.33	14.84	11.13
15					12.43	10.28	13.19	11.10	13.57	11.02	13.97	10.95	14.78	11.56	15.59	11.36
17					12.96	10.51	13.77	11.33	14.17	11.25	14.61	11.18	15.48	11.79	16.34	11.59
19					13.24	10.63	14.06	11.45	14.48	11.37	14.92	11.29	15.80	11.90	16.68	11.69
21					13.51	10.74	14.36	11.57	14.78	11.49	15.23	11.41	16.12	12.01	17.02	11.80
23					13.51	10.74	14.40	11.58	14.82	11.50	15.28	11.43	16.19	12.03	17.10	11.82
25			12.50	10.91	13.50	10.74	14.43	11.59	14.86	11.52	15.33	11.44	16.25	12.05	17.18	11.85
27			12.41	10.87	13.50	10.74	14.47	11.61	14.91	11.54	15.34	11.45	16.20	12.03		
29			12.32	10.83	13.29	10.65	14.23	11.51	14.68	11.45	15.13	11.37	16.02	11.97		
31			12.23	10.79	13.09	10.56	13.99	11.42	14.45	11.36	14.92	11.29	15.85	11.92		
33	11.51	10.06	12.01	10.68	12.89	10.48	13.75	11.32	14.23	11.27	14.71	11.22	15.67	11.85		
35	11.28	9.95	11.82	10.60	12.68	10.39	13.50	11.22	14.00	11.19	14.50	11.14	15.49	11.79		
37	11.08	9.85	11.62	10.51	12.47	10.30	13.25	11.13	13.71	11.08	14.18	11.02	15.12	11.67		
39	10.89	9.76	11.43	10.42	12.26	10.21	12.99	11.02	13.43	10.97	13.86	10.91	14.74	11.54		
41	10.70	9.67	11.23	10.33	12.04	10.12	12.73	10.92	13.14	10.86	13.55	10.79	14.36	11.42		
43	10.51	9.58	11.03	10.24	11.83	10.03	12.47	10.82	12.85	10.75	13.23	10.68	13.98	11.29		

Outdoor air temp.	Indoor air temperature					
	DB					
	16	18	20	22	24	
DB	WB	16	18	20	22	24
-19.8	-20	8.06	8.03	8.00	7.97	7.94
-17.7	-18	8.53	8.50	8.46	8.43	8.39
-15.7	-16	9.00	8.96	8.92	8.88	8.85
-13.5	-14	9.52	9.48	9.43	9.39	9.35
-11.5	-12	10.04	9.99	9.95	9.90	9.85
-9.5	-10	10.56	10.51	10.46	10.41	10.36
-7.5	-8	11.08	11.02	10.97	10.91	10.86
-5.5	-6	11.32	11.26	11.21	11.15	11.09
-3.0	-4	11.56	11.50	11.44	11.38	11.31
-1.0	-2	11.81	11.75	11.68	11.61	11.54
1.0	0	12.05	11.99	11.92	11.84	11.77
2.0	1	12.18	12.11	12.04	11.96	11.89
3.0	2	12.98	12.90	12.83	12.77	12.72
5.0	4	14.58	14.50	14.41	14.40	14.38
7.0	6	16.19	16.09	16.00	16.02	16.05
9.0	8	16.83	16.73	16.63	16.59	16.55
11.5	10	17.46	17.37	17.27	17.17	17.06
13.5	12	18.44	18.33	18.22	18.08	18.00
15.5	14	19.41	19.29	19.17	18.99	18.95
16.5	16	19.90	19.77	19.64	19.45	19.42

Note(1) These data show average statuses.
Depending on the system control, there may be ranges where the operation is not conducted continuously.
These data show the case where the operation frequency of a compressor is fixed.
(2) Capacities are based on the following conditions.
Corresponding refrigerant piping length : 7.5m
Level difference of Zero.
(3) Symbols are as follows.
TC : Total cooling capacity (kW)
SHC : Sensible heat capacity (kW)
HC : Heating capacity (kW)

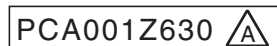

[References data]

Capacity variation against outdoor and indoor temperature at rated capacity condition.

(I) Models FDC100, 125, 140VN, 100, 125, 140VS

① Cooling

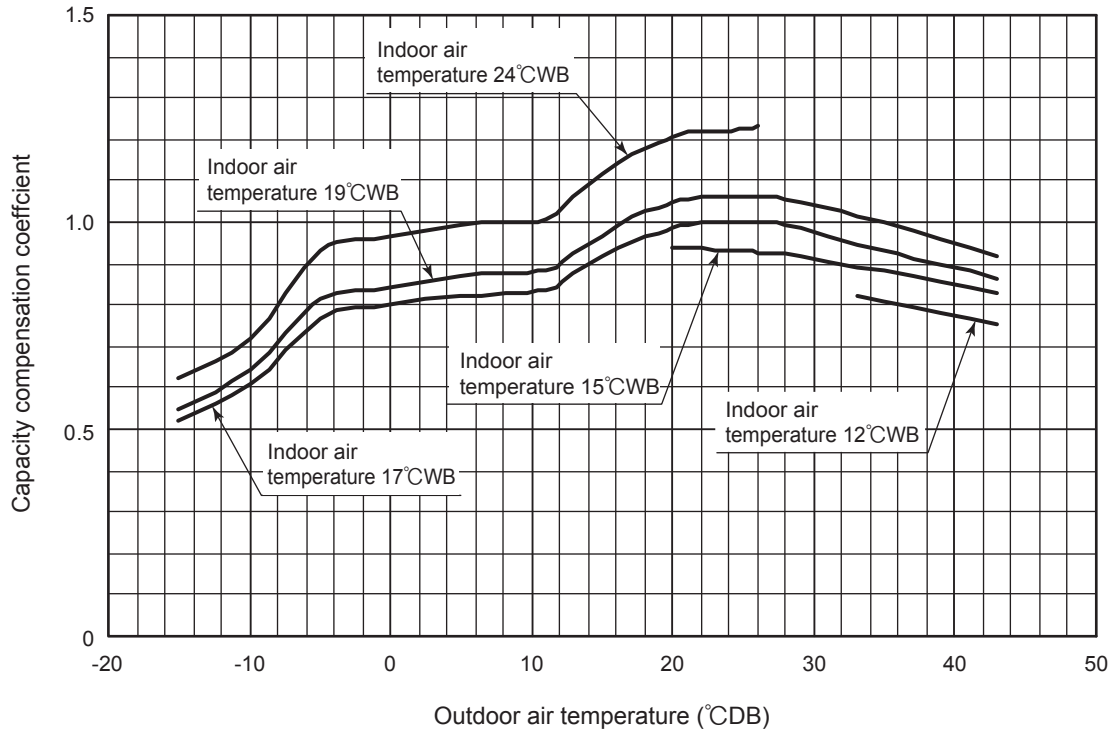

② Heating

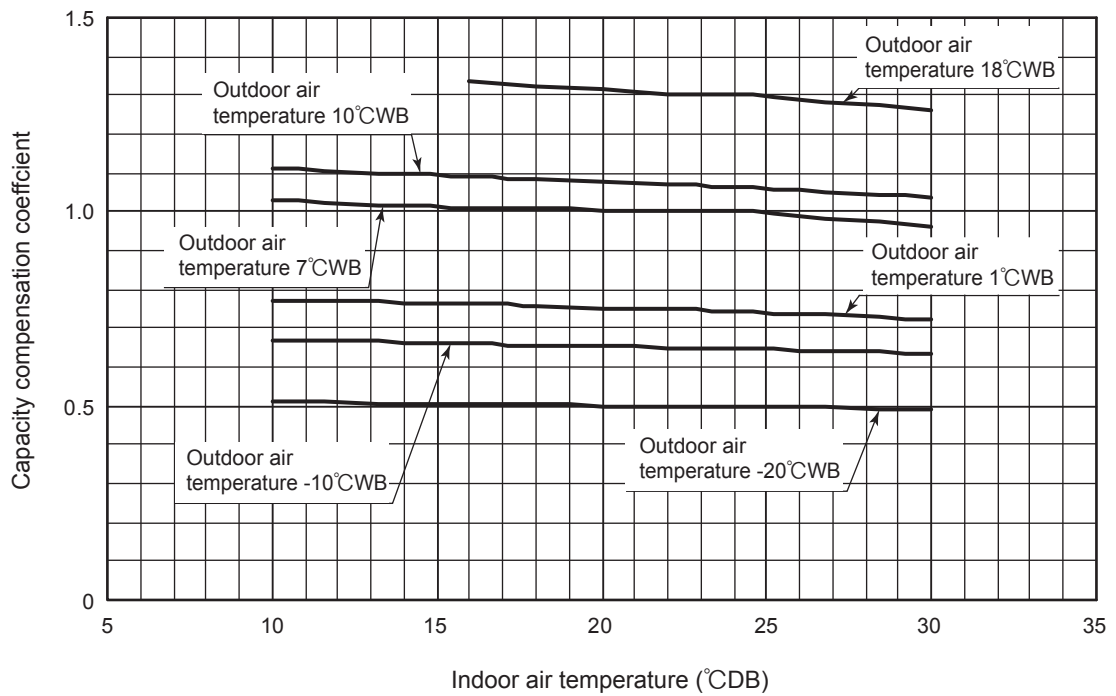

(II) Model FDC200VS

① Cooling

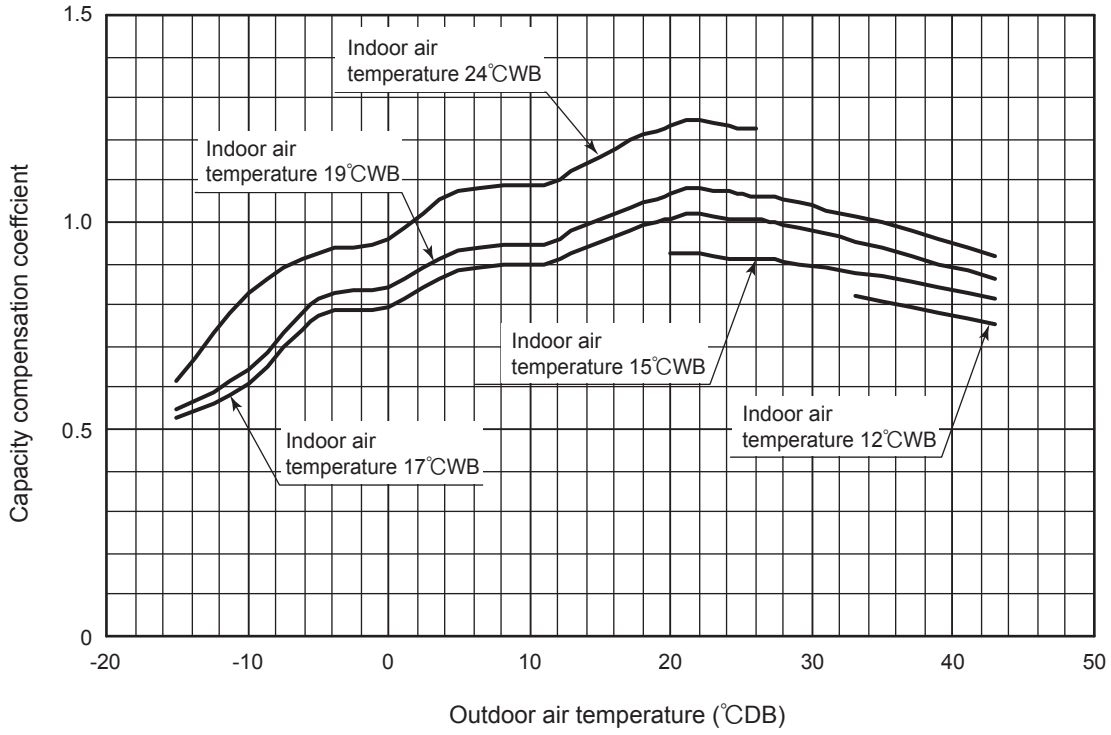

② Heating

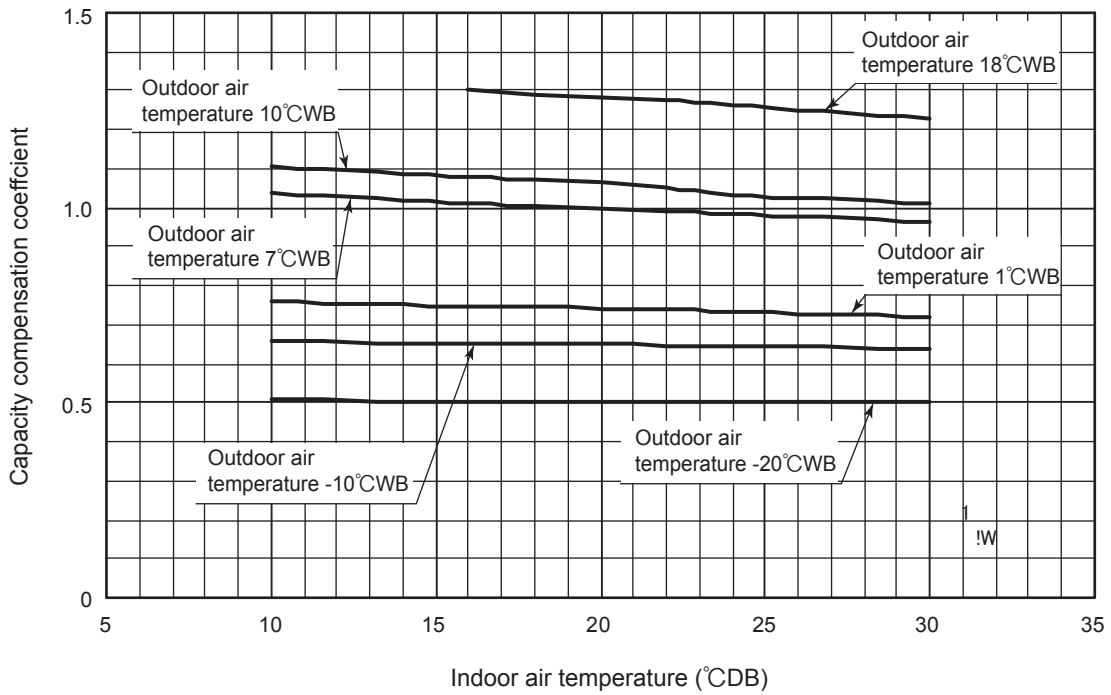

III) Model FDC250VS

① Cooling

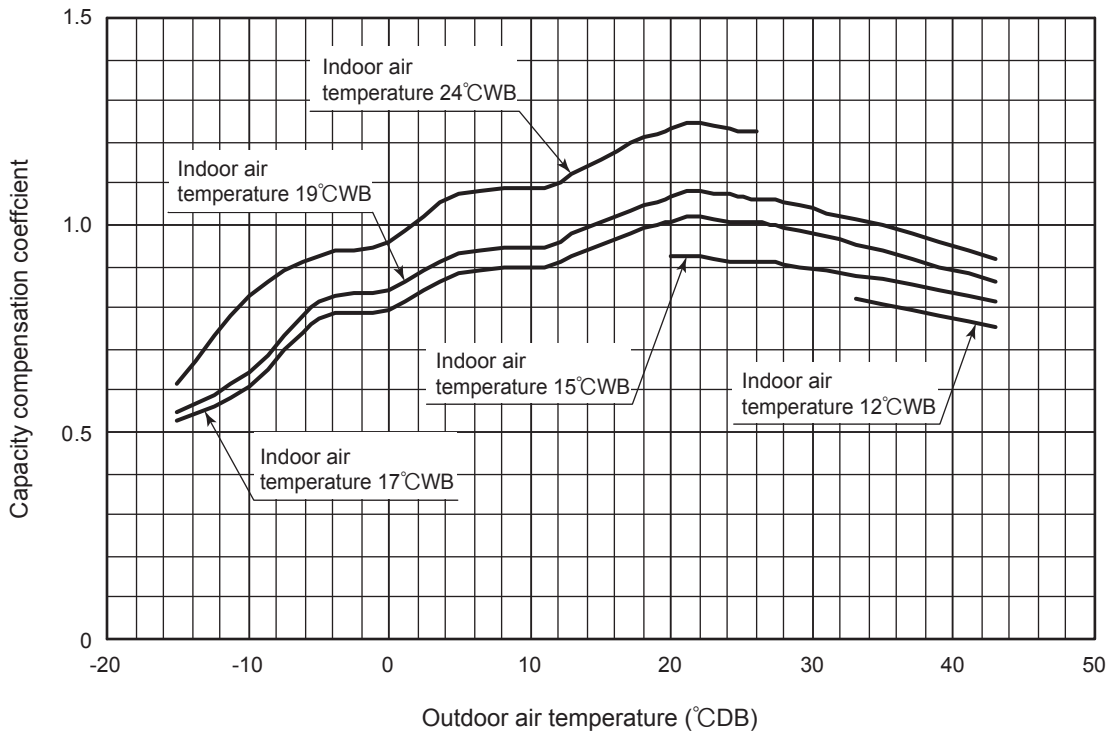

② Heating

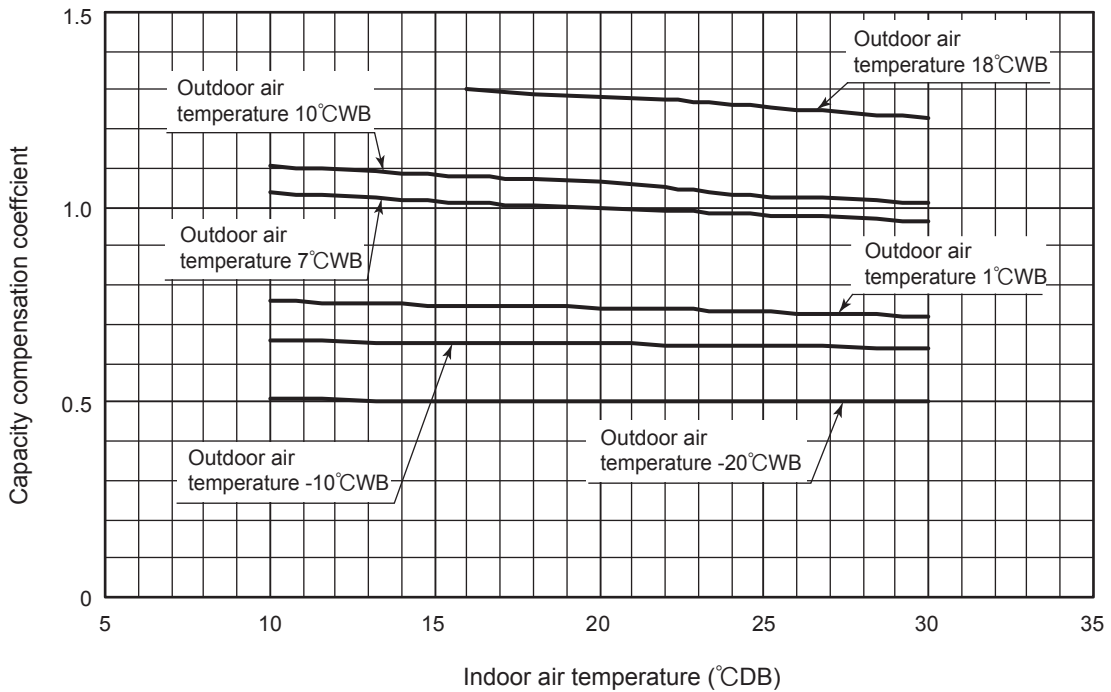

1.9.2 Correction of cooling and heating capacity in relation to air flow rate control (fan speed)

Fan speed	P-Hi or Hi ⁽¹⁾	Me	Lo
Coefficient	1.00	0.97	0.95

Note (1) FDU 200, 250 and SRK models only

1.9.3 Correction of cooling and heating capacity in relation to one way length of refrigerant piping

It is necessary to correct the cooling and heating capacity in relation to the one way equivalent piping length between the indoor and outdoor units.

Models 100 ~ 140

Equivalent piping length ⁽¹⁾ (m)		7.5	10	15	20	25	30	35	40	45	50	55	
Heating		1	1	1	1	1	0.998	0.998	0.993	0.993	0.988	0.988	
Cooling	100 model	φ 15.88	1	0.991	0.978	0.964	0.951	0.937	0.924	0.910	0.897	0.883	0.870
	125 model		1	0.986	0.968	0.950	0.932	0.914	0.896	0.878	0.860	0.842	0.824
	140 model		1	0.985	0.966	0.946	0.927	0.907	0.888	0.868	0.849	0.829	0.810
	100 model	φ 19.05	1.016	1.013	1.007	1.002	0.996	0.991	0.985	0.980	0.974	0.969	0.963
	125 model		1.022	1.018	1.009	1.001	0.992	0.984	0.975	0.967	0.958	0.950	0.941
	140 model		1.026	1.021	1.011	1.002	0.992	0.983	0.973	0.964	0.954	0.945	0.935

Note (1) Calculate the equivalent length using the following formula.

However, install the piping so that the piping length is within +5 m of the limit length (actual length) for the respective types.

Models 200, 250

Equivalent piping length ⁽¹⁾ (m)		7.5	10	15	20	25	30	35	40	45	50	55	60	65	70	75	
Heating		1	0.998	0.995	0.991	0.988	0.984	0.981	0.977	0.974	0.970	0.967	0.963	0.960	0.956	0.953	
Cooling	200 model	φ 25.4	1.007	1.005	1.002	0.998	0.995	0.991	0.988	0.984	0.981	0.977	0.974	0.970	0.967	0.963	0.960
	250 model		1.012	1.008	1.002	0.996	0.990	0.984	0.978	0.972	0.966	0.960	0.953	0.947	0.941	0.935	0.929
	200 model	φ 22.22	1	0.997	0.991	0.984	0.978	0.971	0.965	-	-	-	-	-	-	-	-
	250 model		1	0.995	0.985	0.975	0.965	0.954	0.944	-	-	-	-	-	-	-	-
	200 model	φ 28.58	1.010	1.009	1.007	1.005	1.003	1.001	0.999	0.997	0.995	0.993	0.991	0.989	0.987	0.985	0.983
	250 model		1.016	1.015	1.011	1.008	1.004	1.001	0.997	0.994	0.990	0.987	0.983	0.980	0.976	0.973	0.969

Note (1) Calculate the equivalent length using the following formula.

However, install the piping so that the piping length is within +5 m of the limit length (actual length) for the respective types.

- Equivalent length = Actual length + (Equivalent bend length x number of bends in the piping.)
Equivalent length per bend.

Gas pipe diameter (mm)	φ 12.7	φ 15.88	φ 19.05	φ 22.22	φ 25.4	φ 28.58
Equivalent bend length	0.20	0.25	0.30	0.35	0.40	0.45

1.9.4 Height difference between the indoor unit and outdoor unit

When the outdoor unit is located below indoor units in cooling mode, or when the outdoor unit is located above indoor units in heating mode, the correction coefficient mentioned in the below table should be subtracted from the value in the above table.

Height difference between the indoor unit and outdoor unit in the vertical height difference	5m	10m	15m	20m	25m	30m
Adjustment coefficient	0.99	0.98	0.97	0.96	0.95	0.94

Piping length limitations

Item	Model	100, 125, 140	200, 250
Max. one way piping length		50m	70m
Max. vertical height difference		Outdoor unit is higher 30m Outdoor unit is lower 15m	

Note (1) Values in the table indicate the one way piping length between the indoor and outdoor units.

How to obtain the cooling and heating capacity

Example : The net cooling capacity of the model FDUM100VNVF1 with the air flow “P-High”, the piping length of 15m, the outdoor unit located 5m lower than the indoor unit, indoor wet-bulb temperature at 19.0°C and outdoor dry-bulb temperature 35°C is

$$\text{Net cooling capacity} = \frac{10.0}{\uparrow} \times \frac{1.00}{\uparrow} \times \frac{0.978}{\uparrow} \times \frac{0.99}{\uparrow} \approx 9.7\text{kW}$$

Net cooling total capacity
of FDUM100VNVF1
(Outdoor temp. : 35°CDB
Indoor temp. : 19°CWB)
shown in table 1.9.1

Air flow : P-Hi
shown in table 1.9.2

Piping length :15m
(Gas pipe size is φ15.88)
shown in table 1.9.3

Height diff. :5m
(Outdoor unit : below)
shown in table 1.9.4

1.10 APPLICATION DATA

1.10.1 Installation of indoor unit

(1) Ceiling cassette-4way type (FDT)



This manual is for the installation of an indoor unit.
For electrical wiring work (Indoor), refer to page 251. For remote control installation, refer to page 263. For wireless kit installation, refer to page 515. For electrical wiring work (Outdoor) and refrigerant pipe work installation for outdoor unit, refer to page 277. This unit always be used with the panel.

SAFETY PRECAUTIONS

- Read the "SAFETY PRECAUTIONS" carefully first of all and then strictly follow it during the installation work in order to protect yourself.
- The precautionary items mentioned below are distinguished into two levels, **[WARNING]** and **[CAUTION]**.
[WARNING]: Wrong installation would cause serious consequences such as injuries or death.
[CAUTION]: Wrong installation might cause serious consequences depending on circumstances. Both mentions the important items to protect your health and safety so strictly follow them by any means.
- The meanings of "Marks" used here are as shown on the right:
⊠ Never do it under any circumstances. ⊡ Always do it according to the instruction.
- After completing the installation, do commissioning to confirm there are no abnormalities, and explain to the customers about "SAFETY PRECAUTIONS", correct operation method and maintenance method (air filter cleaning, operation method and temperature setting method) with user's manual of this unit. Ask your customers to keep this installation manual together with the user's manual. Also, ask them to hand over the user's manual to the new user when the owner is changed.

⚠ WARNING

- **Installation should be performed by the specialist.**
If you install the unit by yourself, it may lead to serious trouble such as water leakage, electric shock, fire, and injury due to overturn of the unit. ⊠
- **Install the system correctly according to these installation manuals.**
Improper installation may cause explosion, injury, water leakage, electric shock, and fire. ⊠
- **Check the density referred by the formula (accordance with ISO5149).**
If the density exceeds the limit density, please consult the dealer and installate the ventilation system. ⊠
- **Use the genuine accessories and the specified parts for installation.**
If parts unspecified by our company are used it could cause water leakage, electric shock, fire, and injury due to overturn of the unit. ⊠
- **Ventilate the working area well in case the refrigerant leaks during installation.**
If the refrigerant contacts the fire, toxic gas is produced. ⊠
- **Install the unit in a location that can hold heavy weight.**
Improper installation may cause the unit to fall leading to accidents. ⊠
- **Install the unit properly in order to be able to withstand strong winds such as typhoons, and earthquakes.**
Improper installation may cause the unit to fall leading to accidents. ⊠
- **Do not mix air in to the cooling cycle on installation or removal of the air conditioner.**
If air is mixed in, the pressure in the cooling cycle will rise abnormally and may cause explosion and injuries. ⊘
- **Be sure to have the electrical wiring work done by qualified electrical installer, and use exclusive circuit.**
Power source with insufficient capacity and improper work can cause electric shock and fire. ⊠
- **Use specified wire for electrical wiring, fasten the wiring to the terminal securely, and hold the cable securely in order not to apply unexpected stress on the terminal.**
Loose connections or hold could result in abnormal heat generation or fire. ⊠
- **Arrange the electrical wires in the control box properly to prevent them from rising. Fit the lid of the services panel properly.**
Improper fitting may cause abnormal heat and fire. ⊠
- **Check for refrigerant gas leakage after installation is completed.**
If the refrigerant gas leaks into the house and comes in contact with a fan heater, a stove, or an oven, toxic gas is produced. ⊠
- **Use the specified pipe, flare nut, and tools for R410A.**
Using existing parts (R22) could cause the unit failure and serious accident due to explosion of the cooling cycle. ⊠
- **Tighten the flare nut according to the specified method by with torque wrench.**
If the flare nut were tightened with excess torque, it could cause burst and refrigerant leakage after a long period. ⊠
- **Do not put the drainage pipe directly into drainage channels where poisonous gases such as sulfide gas can occur.**
Poisonous gases will flow into the room through drainage pipe and seriously affect the user's health and safety. This can also cause the corrosion of the indoor unit and a resultant unit failure or refrigerant leak. ⊘
- **Connect the pipes for refrigeration circuit securely in installation work before compressor is operated.**
If the compressor is operated when the service valve is open without connecting the pipes, it could cause explosion and injuries due to abnormal high pressure in the system. ⊠
- **Stop the compressor before removing the pipe after shutting the service valve on pump down work.**
If the pipe is removed when the compressor is in operation with the service valve open, air would be mixed in the refrigeration circuit and it could cause explosion and injuries due to abnormal high pressure in the cooling cycle. ⊠
- **Only use prescribed optional parts. The installation must be carried out by the qualified installer.**
If you install the system by yourself, it can cause serious trouble such as water leaks, electric shocks, fire. ⊠
- **Do not repair by yourself. And consult with the dealer about repair.**
Improper repair may cause water leakage, electric shock or fire. ⊘
- **Consult the dealer or a specialist about removal of the air conditioner.**
Improper installation may cause water leakage, electric shock or fire. ⊠
- **Turn off the power source during servicing or inspection work.**
If the power is supplied during servicing or inspection work, it could cause electric shock and injury by the operating fan. ⊠
- **Do not run the unit when the panel or protection guard are taken off.**
Touching the rotating equipment, hot surface, or high voltage section could cause an injury to be caught in the machine, to get burned, or electric shock. ⊘
- **Shut off the power before electrical wiring work.**
It could cause electric shock, unit failure and improper running. ⊠

⚠ CAUTION

- **Perform earth wiring surely.**
Do not connect the earth wiring to the gas pipe, water pipe, lightning rod and telephone earth wiring. Improper earth could cause unit failure and electric shock due to a short circuit. ⊠
- **Earth leakage breaker must be installed.**
If the earth leakage breaker is not installed, it can cause electric shocks. ⊠
- **Use the circuit breaker of correct capacity. Circuit breaker should be the one that disconnect all poles under over current.**
Using the incorrect one could cause the system failure and fire. ⊠
- **Do not use any materials other than a fuse of correct capacity where a fuse should be used.**
Connecting the circuit by wire or copper wire could cause unit failure and fire. ⊘
- **Do not install the indoor unit near the location where there is possibility of flammable gas leakages.**
If the gas leaks and gathers around the unit, it could cause fire. ⊘
- **Do not install and use the unit where corrosive gas (such as sulfurous acid gas etc.) or flammable gas (such as thinner, petroleum etc.) may be generated or accumulated, or volatile flammable substances are handled.**
It could cause the corrosion of heat exchanger, breakage of plastic parts etc. And inflammable gas could cause fire. ⊘
- **Secure a space for installation, inspection and maintenance specified in the manual.**
Insufficient space can result in accident such as personal injury due to falling from the installation place. ⊠
- **Do not use the indoor unit at the place where water splashes such as laundry.**
Indoor unit is not waterproof. It could cause electric shock and fire. ⊘
- **Do not install the indoor unit for a special purpose such as food storage, cooling for precision instrument, preservation of animals, plants, and a work of art.**
It could cause the damage of the items. ⊘
- **Do not install nor use the system near equipments which generate electromagnetic wave or high harmonics.**
Equipments like inverter equipment, private power generator, high-frequency medical equipment, or telecommunication equipment might influence the air conditioner and cause a malfunction and breakdown. Or the air conditioner might influence medical equipments or telecommunication equipments, and obstruct their medical activity or cause jamming. ⊘
- **Do not install the remote control at the direct sunlight.**
It could cause breakdown or deformation of the remote control. ⊘
- **Do not install the indoor unit at the place listed below.**
 - Places where flammable gas could leak.
 - Places where carbon fiber, metal powder or any powder is floated.
 - Place where the substances which affect the air conditioner are generated such as sulfide gas, chloride gas, acid, alkali or ammoniac atmospheres.
 - Places exposed to oil mist or steam directly.
 - On vehicles and ships
 - Places where machinery which generates high harmonics is used.
 - Places where cosmetics or special sprays are frequently used.
 - Highly salted area such as beach.
 - Heavy snow area
 - Places where the system is affected by smoke from a chimney.
 - Altitude over 1000m⊘
- **Do not install the indoor unit in the locations listed below (Be sure to install the indoor unit according to the installation manual for each model because each indoor unit has each limitation)**
 - Locations with any obstacles which can prevent inlet and outlet air of the unit
 - Locations where vibration can be amplified due to insufficient strength of structure.
 - Locations where the infrared receiver is exposed to the direct sunlight or the strong light beam. (in case of the infrared specification unit)
 - Locations where an equipment affected by high harmonics is placed. (TV set or radio receiver is placed within 5m)
 - Locations where drainage cannot run off safely.
 It can affect performance or function and etc.. ⊘
- **Do not put any valuables which will break down by getting wet under the air conditioner.**
Condensation could drop when the relative humidity is higher than 80% or drain pipe is clogged, and it damages user's belongings. ⊘
- **Do not use the base frame for the outdoor unit which is corroded or damaged after a long period of use.**
It could cause the unit falling down and injury. ⊘
- **Pay attention not to damage the drain pan by weld sputter when brazing work is done near the unit.**
If sputter entered into the unit during brazing work, it could cause damage (pinhole) of drain pan and leakage of water. To avoid damaging, keep the indoor unit packed or cover the indoor unit. ⊠
- **Install the drain pipe to drain the water surely according to the installation manual.**
Improper connection of the drain pipe may cause dropping water into room and damaging user's belongings. ⊠
- **Do not share the drain pipe for indoor unit and GHP (Gas Heat Pump system) outdoor unit.**
Toxic exhaust gas would flow into room and it might cause serious damage (some poisoning or deficiency of oxygen) to user's health and safety. ⊘
- **Be sure to perform air tightness test by pressurizing with nitrogen gas after completed refrigerant piping work.**
If the density of refrigerant exceeds the limit in the event of refrigerant leakage in the small room, lack of oxygen can occur, which can cause serious accidents. ⊠
- **For drain pipe installation, be sure to make descending slope of greater than 1/100, not to make traps, and not to make air-bleeding.**
Check if the drainage is correctly done during commissioning and ensure the space for inspection and maintenance. ⊠
- **Ensure the insulation on the pipes for refrigeration circuit so as not to condense water.**
Incomplete insulation could cause condensation and it would wet ceiling, floor, and any other valuables. ⊠
- **Do not install the outdoor unit where is likely to be a nest for insects and small animals.**
Insects and small animals could come into the electronic components and cause breakdown and fire. Instruct the user to keep the surroundings clean. ⊘
- **Pay extra attention, carrying the unit by hand.**
Carry the unit with 2 people if it is heavier than 20kg. Do not use the plastic straps but the grabbing place, moving the unit by hand. Use protective gloves in order to avoid injury by the aluminum fin. ⊠
- **Make sure to dispose of the packaging material.**
Leaving the materials may cause injury as metals like nail and woods are used in the package. ⊠
- **Do not operate the system without the air filter.**
It may cause the breakdown of the system due to clogging of the heat exchanger. ⊘
- **Do not touch any button with wet hands.**
It could cause electric shock. ⊘
- **Do not touch the refrigerant piping with bare hands when in operation.**
The pipe during operation would become very hot or cold according to the operating condition, and it could cause a burn or frostbite. ⊘
- **Do not clean up the air conditioner with water.**
It could cause electric shock. ⊘
- **Do not turn off the power source immediately after stopping the operation.**
Be sure to wait for more than 5 minutes. Otherwise it could cause water leakage or breakdown. ⊘
- **Do not control the operation with the circuit breaker.**
It could cause fire or water leakage. In addition, the fan may start operation unexpectedly and it may cause injury. ⊘

① Before installation

- Install correctly according to the installation manual.
- Confirm the following points:
 - Unit type/Power supply specification
 - Pipes/Wires/Small parts
 - Accessory items

Accessory item

For unit hanging		For refrigerant pipe			For drain pipe			
Flat washer (M10)	Level gauge	Pipe cover(big)	Pipe cover (small)	Strap	Pipe cover(big)	Pipe cover(small)	Drain hose	Hose clamp
8	1	1	1	4	1	1	1	1
For unit hanging	For unit hanging and adjustment	For heat insulation of gas pipe	For heat insulation of liquid tube	For pipe cover fixing	For heat insulation of drain socket	For heat insulation of drain socket	For drain pipe connecting	For drain hose mounting

② Selection of installation location for the indoor unit

- Select the suitable areas to install the unit under approval of the user.
 - Areas where the indoor unit can deliver hot and cold wind sufficiently. Suggest to the user to use a circulator if the ceiling height is over 3m to avoid warm air being accumulated on the ceiling.
 - Areas where there is enough space to install and service.
 - Areas where it can be drained properly. Areas where drain pipe descending slope can be taken.
 - Areas where there is no obstruction of airflow on both air return grille and air supply port.
 - Areas where fire alarm will not be accidentally activated by the air conditioner.
 - Areas where the supply air does not short-circuit.
 - Areas where it is not influenced by draft air.
 - Areas not exposed to direct sunlight.
 - Areas where dew point is lower than around 28°C and relative humidity is lower than 80%.
- This indoor unit is tested under the condition of JIS (Japan Industrial Standard) high humidity condition and confirmed there is no problem. However, there is some risk of condensation drop if the air conditioner is operated under the severer condition than mentioned above.
- If there is a possibility to use it under such a condition, attach additional insulation of 10 to 20mm thick for entire surface of indoor unit, refrigeration pipe and drain pipe.
- Areas where TV and radio stays away more than 1m. (It could cause jamming and noise.)
 - Areas where any items which will be damaged by getting wet are not placed such as food, table wares, server, or medical equipment under the unit.
 - Areas where there is no influence by the heat which cookware generates.
 - Areas where not exposed to oil mist, powder and/or steam directly such as above fryer.
 - Areas where lighting device such as fluorescent light or incandescent light doesn't affect the operation.
- (A beam from lighting device sometimes affects the infrared receiver for the wireless remote control and the air conditioner might not work properly.)

- Check if the place where the air conditioner is installed can hold the weight of the unit. If it is not able to hold, reinforce the structure with boards and beams strong enough to hold it. If the strength is not enough, it could cause injury due to unit falling.
- If there are 2 units of wireless type, keep them away for more than 6m to avoid malfunction due to cross communication.
- When plural indoor units are installed nearby, keep them away for more than 4 to 5m.

Space for installation and service

- When it is not possible to keep enough space between indoor unit and wall or between indoor units, close the air supply port where it is not possible to keep space and confirm there is no short circuit of airflow.
- Install the indoor unit at a height of more than 2.5m above the floor.

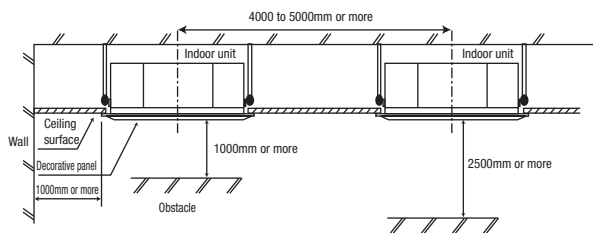

Set blow-out pattern

- Select the most proper number of blow-out air supply port direction from 4 way, 3 way or 2 way according to the shape of the room and installation position. (1 way is not available.)
- If it is necessary to change the number of air supply port, prepare the covering materials.
- Instruct the user not to use low fan speed when 2way or 3way air supply is used.
- Do not use 2way air supply port under high temperature and humidity environment. (Otherwise it could cause condensation and leakage of water.)
- It is possible to set the airflow direction port by port independently. Refer to the user's manual for details.

Where there are pipe joints on the way of embedded piping, provide adequate openings for inspection of the joints.

③ Preparation before installation

- If suspension bolt becomes longer, do reinforcement of earthquake resistant.
 - For grid ceiling
 - When suspension bolt length is over 500mm, or the gap between the ceiling and roof is over 700mm, apply earthquake resistant brace to the bolt.
 - In case the unit is hanged directly from the slab and is installed on the ceiling plane which has enough strength.
 - When suspension bolt length is over 1000mm, apply the earthquake resistant brace to the bolt.
- Prepare four (4) sets of suspension bolt, nut and spring washer (M10 or M8) on site.

Ceiling opening, Suspension bolts pitch, Pipe position

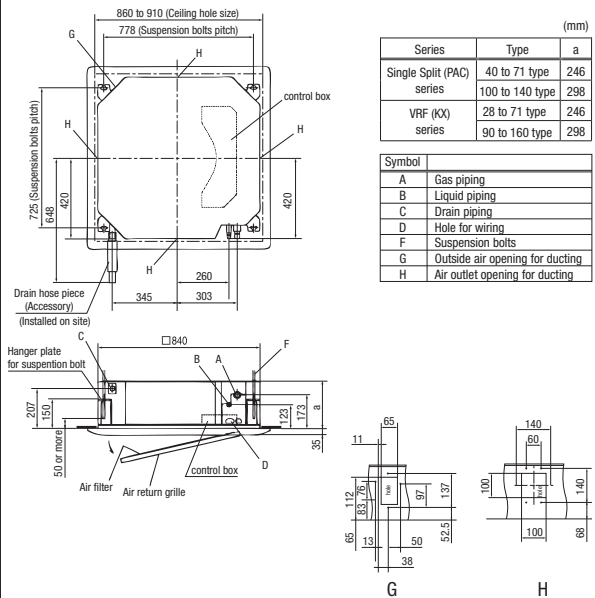

④ Installation of indoor unit

Work procedure

- Prepare a ceiling hole with the size of from 860mm × 860mm to 910mm × 910mm referring to the template attached in the package.
- Arrange the suspension bolt at the right position (725mm × 778mm).
- Make sure to use four suspension bolts and fix them so as to be able to hold 500N load.
- Ensure that the lower end of the suspension bolt should be 50mm above the ceiling plane. Temporarily put the four lower nuts 150mm above the ceiling plane and the upper nuts on distant place from the lower nuts in order not to obstruct hanging the indoor unit or adjust the indoor unit position, and then hang the indoor unit.
- Adjust the indoor unit position after hanging it by inserting the level gauge attached on the package into the air supply port and checking if the gap between the ceiling plane and the indoor unit is appropriate. In order to adjust the indoor unit position, adjust the lower nuts while the upper nuts are put on distant place. Confirm there is no backlash between the hanger plate for suspension bolt and the lower nut and washer.

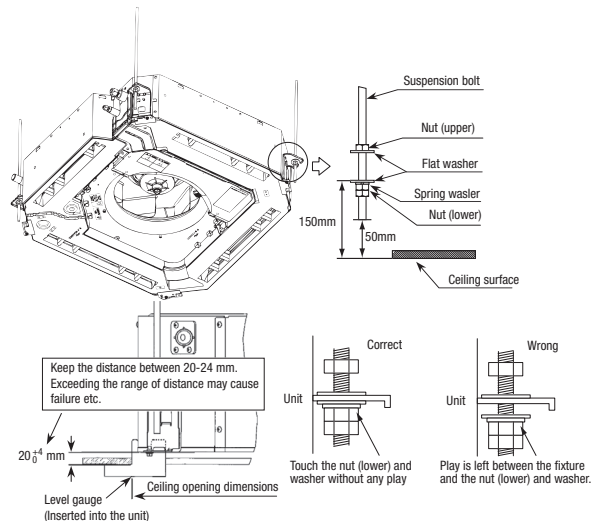

④ Installation of indoor unit (continued)

- Make sure to install the indoor unit horizontally. Confirm the levelness of the indoor unit with a level gauge or transparent hose filled with water. Keep the height difference at both ends of the indoor unit within 3mm.
- Tighten four upper nuts and fix the unit after height and levelness adjustment.

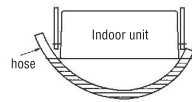

Caution

- Do not adjust the height by adjusting upper nuts. It will cause unexpected stress on the indoor unit and it will lead to deformation of the unit, failure of attaching a panel, and generating noise from the fan.
- Make sure to install the indoor unit horizontally and set the gap between the unit underside and the ceiling plane properly. Improper installation may cause air leakage, dew condensation, water leakage and noise.
- Even after decorative panel attached, still the unit height can be adjusted finely. Refer to the installation manual for decorative panel for details.
- Make sure there is no gap between decoration panel and ceiling surface, and between decoration panel and the indoor unit. The gap may cause air leakage, dew condensation and water leakage.
- In case decorative panel is not installed at the same time, or ceiling material is installed after the unit installed, put the cardboard template for installation attached on the package (packing material of cardboard box) on the bottom of the unit in order to avoid dust coming into the indoor unit.

⑤ Refrigerant pipe

Caution

- Be sure to use new pipes for the refrigerant pipes. Use the flare nut attached to the product or a nut compatible with JIS B 8607, Class 2. Regarding whether existing pipes can be reused or not, and the washing method, refer to the instruction manual of the outdoor unit, catalogue or technical data.
- In case of reuse: Do not use old flare nut, but use the one attached to the unit or compatible with JIS B 8607, Class 2.
- In case of reuse: Flare the end of pipe replaced partially for R410A.

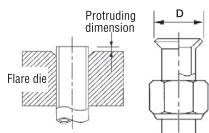

Pipe dia. d mm	Min. pipe wall thickness mm	Protruding dimension for flare, mm		Flare O.D. D mm	Flare nut tightening torque N·m
		Rigid (Clutch type) For R410A	Conventional tool		
6.35	0.8	0 ~ 0.5	0.7 ~ 1.3	8.9 ~ 9.1	14 ~ 18
9.52	0.8			12.8 ~ 13.2	32 ~ 42
12.7	0.8			16.2 ~ 16.6	49 ~ 61
15.88	1			19.3 ~ 19.7	68 ~ 72
19.05	1.2			23.6 ~ 24.0	100 ~ 120

- Use phosphorus deoxidized copper alloy seamless pipe (C1220T specified in JIS H3300) for refrigeration pipe installation. In addition, make sure there is no damage both inside and outside of the pipe, and no harmful substances such as sulfur, oxide, dust or a contaminant stuck on the pipes.
- Do not use any refrigerant other than R410A. Using other refrigerant except R410A (R22 etc.) may degrade inside refrigeration oil. And air getting into refrigeration circuit may cause over-pressure and resultant it may result in bursting, etc.
- Store the copper pipes indoors and seal the both end of them until they are brazed in order to avoid any dust, dirt or water getting into pipe. Otherwise it will cause degradation of refrigeration oil and compressor breakdown, etc.
- Use special tools for R410A refrigerant.

Work procedure

- Remove the flare nut and blind flanges on the pipe of the indoor unit.
 - Make sure to loosen the flare nut with holding the nut on pipe side with a spanner and giving torque to the nut with another spanner in order to avoid unexpected stress to the copper pipe, and then remove them. (Gas may come out at this time, but it is not abnormal.)
 - Pay attention whether the flare nut pops out. (as the indoor unit is sometimes pressured.)
- Make a flare on liquid pipe and gas pipe, and connect the refrigeration pipes on the indoor unit.
 - Bend radius of pipe must be 4D or larger. Once a pipe is bent, do not readjust the bending. Do not twist a pipe or collapse to 2/3D or smaller.
 - Do a flare connection as follows:
 - Make sure to loosen the flare nut with holding the nut on pipe side with a spanner and giving torque to the nut with another spanner in order to avoid unexpected stress to the copper pipe, and then remove them.
 - When fastening the flare nut, align the refrigeration pipe with the center of flare nut, screw the nut for 3-4 times by hand and then tighten it by spanner with the specified torque mentioned in the table below. Make sure to hold the pipe on the indoor unit securely by a spanner when tightening the nut in order to avoid unexpected stress on the copper pipe.
- Cover the flare connection part of the indoor unit with attached insulation material after a gas leakage inspection, and tighten both ends with attached straps.
 - Make sure to insulate both gas pipes and liquid pipes completely.
 - Incomplete insulation may cause dew condensation or water dropping.
- Refrigerant is charged in the outdoor unit.
 - As for the additional refrigerant charge for the indoor unit and piping, refer to the installation manual attached to the outdoor unit.

⑤ Refrigerant pipe (continued)

Caution:
Refrigerating machine oil should not be applied to the threads of union or external surface of flare. It is because, even if the same tightening torque is applied, the oil is likely to decrease the slide friction force on the threads and increase, in turn, the axial component force so that it could crack the flare by the stress corrosion. Refrigerating machine oil may be applied to the internal surface of flare only.

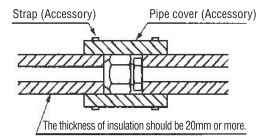

⑥ Drain pipe

Caution

- Install the drain pipe according to the installation manual in order to drain properly. Imperfection in draining may cause flood indoors and wetting the household goods, etc.
- Do not put the drain pipe directly into the ditch where toxic gas such as sulfur, the other harmful and inflammable gas is generated. Toxic gas would flow into the room and it would cause serious damage to user's health and safety (some poisoning or deficiency of oxygen). In addition, it may cause corrosion of heat exchanger and bad smell.
- Connect the pipe securely to avoid water leakage from the joint.
- Insulate the pipe properly to avoid condensation drop.
- Check if the water can flow out properly from both the drain outlet on the indoor unit and the end of the drain pipe after installation.
- Make sure to make descending slope of greater than 1/100 and do not make up-down bend and/or trap in the midway. In addition, do not put air vent on the drain pipe. Check if water is drained out properly from the pipe during commissioning. Also, keep sufficient space for inspection and maintenance.

Work procedure

- Make sure to insert the drain hose (the end mode of soft PVC) to the end of the step part of drain socket. Attach the hose clamp to the drain hose around 10mm from the end, and fasten the screw within 5mm left to the nut.
 - Do not apply adhesives on this end.

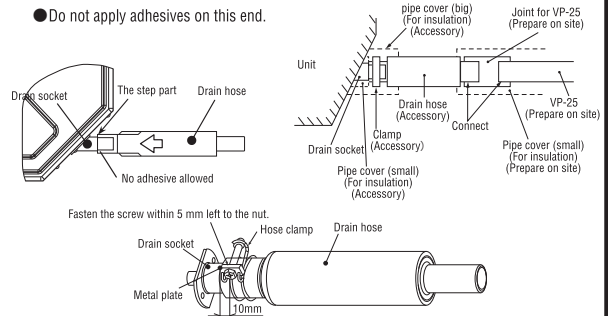

- Prepare a joint for connecting VP-25 pipe, adhere and connect the joint to the drain hose (the end made of rigid PVC), and adhere and connect VP-25 pipe (prepare on site).
 - As for drain pipe, apply VP-25 made of rigid PVC which is on the market.
 - Make sure that the adhesive will not get into the supplied drain hose. It may cause the flexible part broken after the adhesive is dried up and gets rigid.
 - The flexible drain hose is intended to absorb a small difference at installation of the unit or drain pipes. Intentional bending, expanding may cause the flexible hose broken and water leakage.

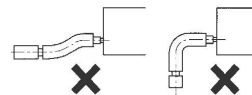

- Make sure to make descending slope of greater than 1/100 and do not make up-down bend and/or trap in the midway.
 - Pay attention not to give stress on the pipe on the indoor unit side, and support and fix the pipe as close place to the unit as possible when connecting the drain pipe.
 - Do not set up air vent.

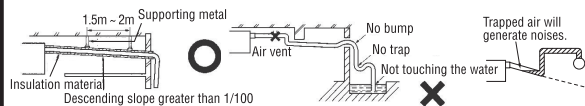

- When sharing a drain pipe for more than one unit, lay the main pipe 100mm below the drain outlet of the unit. In addition, select VP-30 or bigger size for main drain pipe.

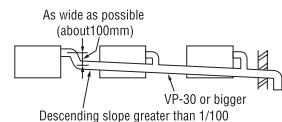

- Insulate the drain pipe.
 - Be sure to insulate the drain socket and rigid PVC pipe installed indoors otherwise it may cause dew condensation and water leakage.
 - After drainage test implementation, cover the drain socket part with pipe cover (small size), then use the pipe cover (big size) to cover the pipe cover (small size), clamps and part of the drain hose, and fix and wrap it with tapes to wrap and make joint part gapless.

⑥ Drain pipe (continued)

Drain up

- The position for drain pipe outlet can be raised up to 700mm above the ceiling. Use elbows for installation to avoid obstacles inside ceiling. If the horizontal drain pipe is too long before vertical pipe, the backflow of water will increase when the unit is stopped, and it may cause overflow of water from the drain pan on the indoor unit. In order to avoid overflow, keep the horizontal pipe length and offset of the pipe within the limit shown in the figure below.

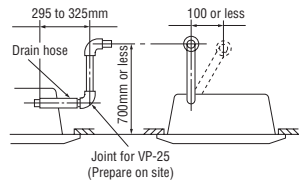

Drain test

- After installation of drain pipe, make sure that drain system work in good condition and no water leakage from joint and drain pan. Check if the motor sound of drain pump is normal or not.
 - Do drain test even if installation of heating season.
 - For new building cases, make sure to complete the test before hanging the ceiling.
1. Fill water of approx. 1,000 cc in the drain pan of the main unit. Take care not to wet electrical equipment such as the drain pump, etc. Inject water through the blow outlet using a feed water pump, or the like, or through the refrigerant pipe joint.
 - When injecting water through the blow outlet
 - When removing the lid to inject water through the refrigerant joint
 - (1) Remove screws at 2 places.
 - (2) While pressing the lid in the direction ①, pull and remove the lid in the direction ②.
 (Remove the lid by releasing the catches from the hooks in the figure.)

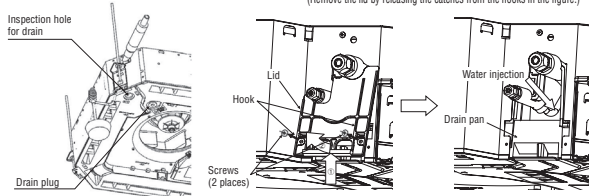

2. Make sure that water is drained out properly and there is no water leakage from any joints of the drain pipe at the test. Confirm that the water is properly drained out while the drain motor is operating. At the drain socket (transparent), it is possible to check if the water is drained out properly.
3. Unplug the drain plug on the indoor unit to remove remaining water on the drain pan after the test, and re-plug it. And insulate the drain pipe properly finally.

Drain pump operation

- In case electrical wiring work finished
Drain pump can be operated by remote control (wired). For the operation method, refer to [Operation for drain pump] in the installation manual for wiring work.
- In case electrical wiring work not finished
Drain pump will run continuously when the dip switch "SW7-1" on the indoor unit PCB is turned ON, the Connector CNB is disconnected, and then the power supply (230VAC on the terminal block ① and ②) is turned ON. Make sure to turn OFF "SW7-1" and reconnect the Connector CNB after the test.

⑦ Wiring-out position and wiring connection

- Electrical installation work must be performed according to the installation manual by an electrical installation service provider qualified by a power provider of the country, and be executed according to the technical standards and other regulations applicable to electrical installation in the country.
- Be sure to use an exclusive circuit.
- Use specified cord, fasten the wiring to the terminal securely, and hold the cord securely in order not to apply unexpected stress on the terminal.
- Do not put both power source line and signal line on the same route. It may cause miscommunication and malfunction.
- Be sure to do D type earth work.
- For the details of electrical wiring work, see attached instruction manual for electrical wiring work.

1. Remove a lid of the control box (3 screws) and the wiring cover (2 screws).
2. Hold each wiring inside the unit and fasten them to terminal block securely.
3. Fix the wiring with clamps.
4. Install the removed parts back to original place.

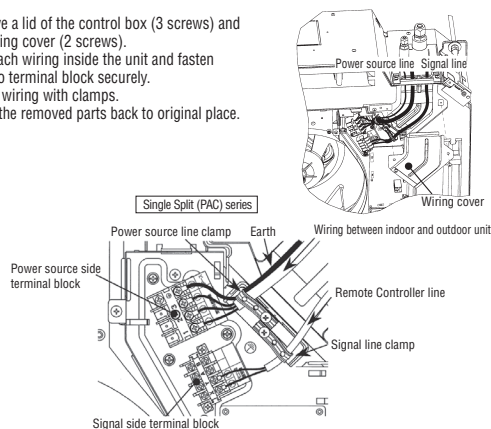

⑦ Wiring-out position and wiring connection (continued)

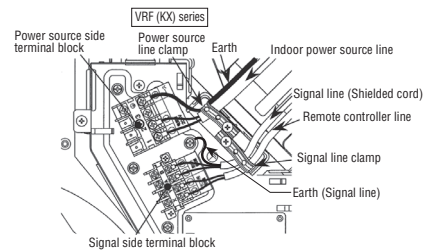

⑧ Panel installation

- Attach the panel on the indoor unit after electrical wiring work.
- Refer to attached manual for panel installation for details.

⑨ Check list after installation

- Check the following items after all installation work completed.

Check if:	Expected trouble	Check
The indoor and outdoor units are fixed securely?	Falling, vibration, noise	
Inspection for leakage is done?	Insufficient capacity	
Insulation work is properly done?	Water leakage	
Water is drained properly?	Water leakage	
Supply voltage is same as mentioned in the model name plate?	PCB burnt out, not working at all	
There is mis-wiring or mis-connection of piping?	PCB burnt out, not working at all	
Earth wiring is connected properly?	Electric shock	
Cable size comply with specified size?	PCB burnt out, not working at all	
Any obstacle blocks airflow on air inlet and outlet?	Insufficient capacity	

⑩ How to check the dirt of drain pan (Maintenance)

The method of checking the dirt of drain pan

- It is possible to check the dirt for inlet of drain pan without detaching the panel. (Inspection is not possible when the high efficient filter and option spacer is installed.)
1. Open the air return grille and remove the panel corner cover on drain pan side.
 2. Remove the cover of inspection window. (1screw)
 3. Check the drain pan from the inspection window.
If the drain pan is very dirty, remove the drain pan and clean it.
 4. After checking of the dirty of drain pan, restore the cover of the inspection window securely. Improper restoration of the cover may cause dew condensation and water leakage.

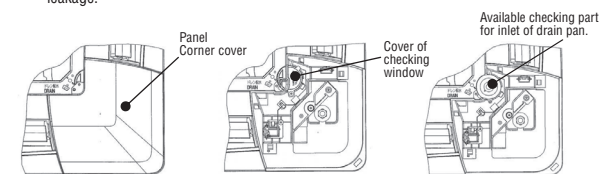

Attention for removing drain pan

- The fixing components have been attached the with drain pan. Pay attention to these components during installation and removing. Take off the hanging hook after removing four screws. During the installation of drain pan, fix the drain pan firmly by using four screws after hanging it up with the fixing hook.

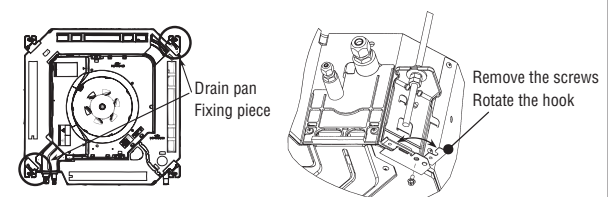



PANEL INSTALLATION MANUAL

PJF012D003C 



Read this manual together with the indoor unit's installation manual.

⚠ WARNING

- Fasten the wiring to the terminal securely and hold the cable securely so as not to apply unexpected stress on the terminal. Loose connection or hold will cause abnormal heat generation or fire. 
- Make sure the power supply is turned off when electric wiring work. Otherwise, electric shock, malfunction and improper running may occur. 

① Before installation

- Follow installation manual carefully, and install the panel properly.
- Check the following items.
 - Accessories

Accessories			
	4 pieces	For panel installation	
	4 pieces	For avoiding the corner panel from falling	
	4 pieces	For fixing the corner panel	

Note: Accessories are laid in the position removing the corner panel.

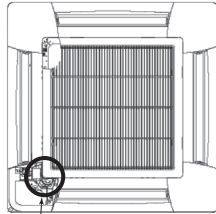

② Checking the indoor unit installation position

- Read this manual together with the air conditioner installation manual carefully.
- Check if the opening size for the indoor unit is correct with the level gauge supplied in the indoor unit.
- Check if the gap between the ceiling plane and the indoor unit is correct by inserting the level gauge into the air outlet port of the indoor unit. (See below drawing)
- Adjust the installation elevation if necessary.

Caution

If there is a height difference beyond the design limit between the installation level of the indoor unit and the ceiling plane, the panel may be subject to excessive stress during installation, it may cause distortion and damage.

- The installation level of the indoor unit can be adjusted finely from the opening provided on the corner, even after panel is attached. (Refer to ⑥ Attaching the panel for details.)

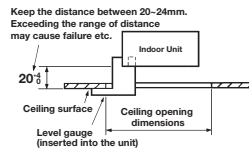

③ Removing the air return grille

1. Hold the stoppers on the air return grille (2 places) toward OPEN direction, open the air return grille.
2. Remove the hooks of the air return grille from the decorative panel while it is in the open position.

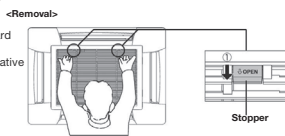

④ Removing a corner panel

- Pull the corner panel toward the direction indicated by the arrow and remove it. (Same way for all four corner panels)

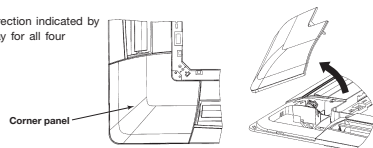

⑤ Orientation of the panel installation

- Take note that there is an orientation to install the panel.
- Attach the panel with the orientation shown on the right.
- Align the "PIPE SIDE" mark (on the panel) with the refrigerant pipes on the indoor unit.
- Align the "DRAIN" mark (on the panel) with the drain pipe on the indoor unit.

CAUTION

In case the orientation of the panel is not correct, it will lead to air leakage and also it is not possible to connect the lower motor wiring.

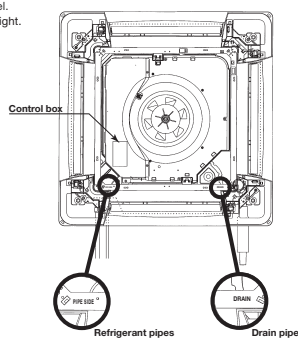

⑥ Attaching the panel

1. Temporary attaching
 - Lift up the hanger (2 places) on the panel for temporary support.
 - Hang the panel on the hook on the indoor unit.

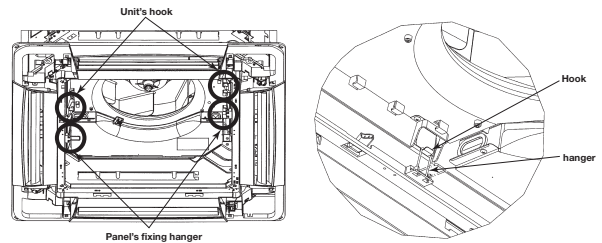

2. Fix the panel on the indoor unit
 - Fasten the panel on the indoor unit with the four bolts supplied with the panel.

Caution

- Improperly tightened hanging bolts can cause the problems listed below, so make sure that you have tightened them securely.
- If there is a gap remaining between the ceiling and the decorative panel even after the hanging bolts are tightened, adjust the installation level of the indoor unit again.

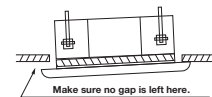
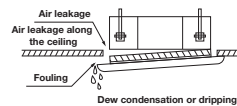

- It is possible to adjust the installation height of the indoor unit with the panel attached as long as there is no influence on the drain pipe inclination and/or the indoor unit levelness.

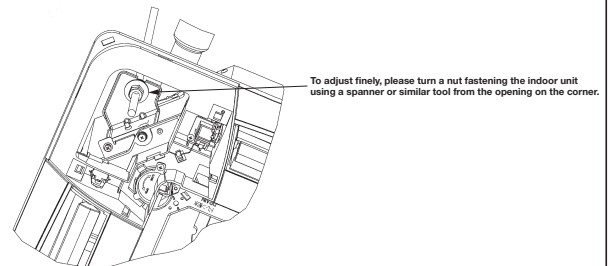

Caution

Make sure there is no stress given on the panel when adjusting the height of the indoor unit to avoid unexpected distortion. It may cause the distortion of panel or failing to close the air return grille.

⑦ Electrical wiring

1. After removing three screws of control box, detach the cover of control box (the hatched part).
2. Connect the connector for louver motor (white 20P).
 - Hold the wiring by using the clamps of the indoor unit.
 - Hold the connector inside the control box.
3. Connect the connector for panel switch.
 - Hold the wiring by using the clamps of the indoor unit.
 - Connect CNV (white) inside the control box.

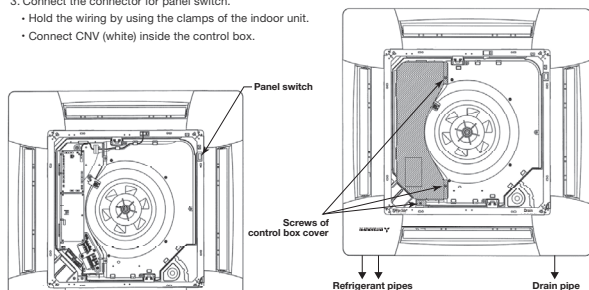

Connector for louver motor (white) Clamps of unit main body

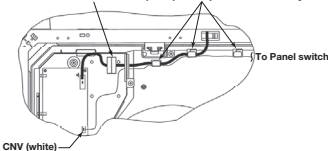

CAUTION

If the air return grille is opened, the panel switch is turned off so that the air-conditioner cannot be operated any more.
To start the air conditioner, close the air return grille.

8 Attaching a corner panel

1. To avoid unexpected falling of the corner panel, put the strap onto the corner panel's pin with turning the strap up.
2. Then hang the strap of a corner panel onto the decorative panel's pin.
3. First insert the part "a" of a corner panel into the part "A" of the decorative panel, and then engage four hooks.

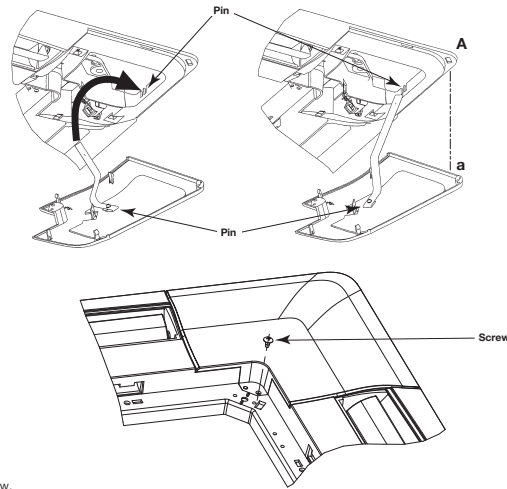

4. Fix with screw.

9 How to set the airflow direction

It is possible to change the movable range of the louver on the air outlet from the wired remote control. Once the top and bottom position is set, the louver will swing within the range between the top and the bottom when swing operation is chosen. It is also possible to apply different setting to each louver.

For the setting method of the louver's operating range, refer to the instruction manual of the wired remote control.

If it is necessary to fix the louver position manually, follow the procedure mentioned below.

1. Shut off the main power switch.
2. Unplug the connector of the louver motor which you want to fix the position. Make sure to insulate unplugged connectors electrically with a vinyl tape.
3. Adjust the louver position slowly by hand so as to be within the applicable range mentioned below table.

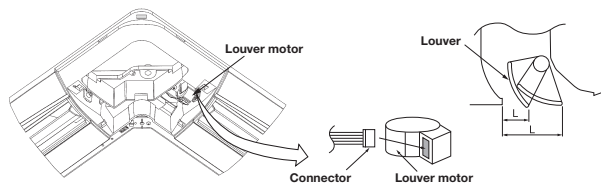

<Range of louver setting>

Vertical airflow direction	Horizontal 0°	Downwards 45°
Dimension L (mm)	43	26

※It can be set between 26-43mm freely.

Caution

- Any automatic control or operation from the remote control will be disabled on the louver whose position is fixed in the above way.
- Do not set a louver beyond the specified range. Failure to observe this instruction may result in dripping, dew condensation, the fouling of the ceiling and the malfunctioning of the unit.

10 Attaching the air return grille

To attach the air return grille, follow the procedure described in **9 Removing the air return grille** in the reverse order.

1. Hang the hooks of the air return grille in the hole of the panel. (The hooks of the grille can be hung in three side of the panel as following.)
2. After the grille is hanged, close the grille while the stoppers on the grille (2 places) are kept pressed to "OPEN" direction. When the grille comes to the original position, release the stoppers to hold the grille. Make sure to hear the sound of "CLICK" in both stoppers.

<Installation>

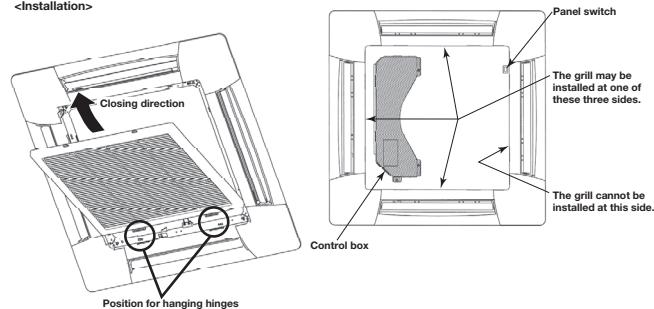

Caution

- Attaching the air return grille from the hinge side.
- Be careful in air return grille attaching, unstable attaching may cause grille falling.
- Repair or replace the distorted, broken stopper at once, or the grille falling may occur.

OUTDOOR AIR (OA) INTAKE FOR FDT

If it is required to intake OA through FDT unit, make sure to check following points carefully in order to conform to the requirement of customer.

If the OA intake volume through FDT unit is not satisfied with the required ventilation air volume, consider to install an independent ventilation system.

- 1) Be sure to calculate cooling/heating load considering the ventilation heat load and to decide the air-conditioning system.
- 2) Be sure the OA intake volume to FDT unit should not exceed 20% of the Supply Air (SA) volume of FDT unit and it should be less than $2\text{m}^3/\text{min}$.
- 3) Be sure to decide the OA intake volume considering the mixed air temperature will be within the usage temperature range of FDT unit.

Especially in following case, please consider to intake OA after processing OA or reducing the OA intake volume.

- 4) Be sure to equip a suitable filter for OA intaken in order to protect the dust.
(Because OA does not pass through the filter equipped on FDT unit)
- 5) Be sure to insulate OA duct.
(If not, it may have dew condensation.)
- 6) Be sure to interlock the booster fan for OA with the fan of FDT unit by using CNT connector.
(If not, the dust trapped on the filter of FDT unit may be blown out to the room by the OA being intaken during the fan of FDT unit stopping)
- 7) Be sure to select a suitable booster fan for OA considering the pressure loss in the OA duct and the pressure loss at the inlet port of FDT with following diagram.
(Please take into consideration the noise level as well)

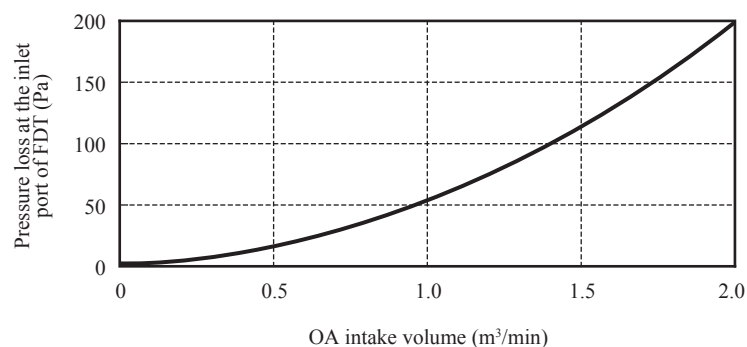
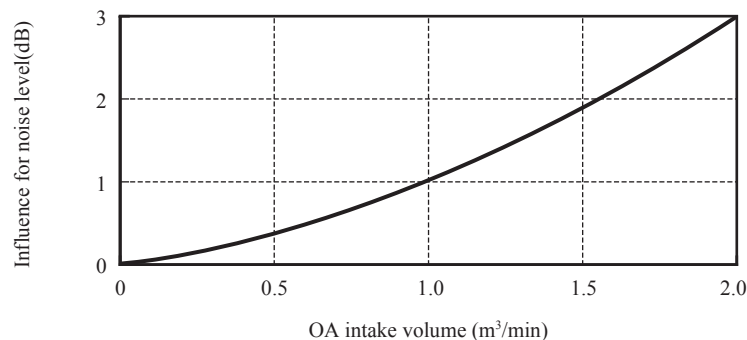

<Selection of booster fan>

Booster fan should have a static pressure calculated with following formula

Static pressure of booster fan

= the pressure loss at the inlet port of FDT (from above diagram)

+ Pressure loss in the OA duct (In case of ϕ 100 duct, 5Pa/m is required)

Select the booster fan from the fan characteristic diagram

(2) Ceiling cassette-4way compact type (FDTC)

PJA012D786

This manual is for the installation of an indoor unit.
 For electrical wiring work (Indoor), refer to page 251. For remote control installation, refer to page 263. For wireless kit installation, refer to page 517. For electrical wiring work (Outdoor) and refrigerant pipe work installation for outdoor unit, refer to page 277.
 This unit must always be used with the panel.

SAFETY PRECAUTIONS

- Read the "SAFETY PRECAUTIONS" carefully first of all and then strictly follow it during the installation work in order to protect yourself.
- The precautionary items mentioned below are distinguished into two levels, [WARNING] and [CAUTION].
 [WARNING]: Wrong installation would cause serious consequences such as injuries or death.
 [CAUTION]: Wrong installation might cause serious consequences depending on circumstances.
 Both mentions the important items to protect your health and safety so strictly follow them by any means.
 The meanings of "Marks" used here are as shown as follows:
 [S] Never do it under any circumstances. [O] Always do it according to the instruction.
- After completing the installation, do commissioning to confirm there are no abnormalities, and explain to the customers about "SAFETY PRECAUTIONS", correct operation method and maintenance method (air filter cleaning, operation method and temperature setting method) with user's manual of this unit.
 Ask your customers to keep this installation manual together with the user's manual. Also, ask them to hand over the user's manual to the new user when the owner is changed.

WARNING

- **Installation should be performed by the specialist.** [!]
 If you install the unit by yourself, it may lead to serious trouble such as water leakage, electric shock, fire, and injury due to overturn of the unit.
- **Install the system correctly according to these installation manuals.** [!]
 Improper installation may cause explosion, injury, water leakage, electric shock, and fire.
- **When installing in small rooms, take prevention measures not to exceed the density limit of refrigerant in the event of leakage, referred by the formula (accordance with ISO5149).** [!]
 If the density of refrigerant exceeds the limit, please consult the dealer and install the ventilation system, otherwise lack of oxygen can occur, which can cause serious accidents.
- **Use the genuine accessories and the specified parts for installation.** [!]
 If parts unspecified by our company are used it could cause water leakage, electric shock, fire, and injury due to overturn of the unit.
- **Ventilate the working area well in case the refrigerant leaks during installation.** [!]
 If the refrigerant contacts the fire, toxic gas is produced.
- **Install the unit in a location that can hold heavy weight.** [!]
 Improper installation may cause the unit to fall leading to accidents.
- **Install the unit properly in order to be able to withstand strong winds such as typhoons, and earthquakes.** [!]
 Improper installation may cause the unit to fall leading to accidents.
- **Do not mix air in to the cooling cycle on installation or removal of the air conditioner.** [!]
 If air is mixed in, the pressure in the cooling cycle will rise abnormally and may cause explosion and injuries.
- **Be sure to have the electrical wiring work done by qualified electrical installer, and use exclusive circuit.** [!]
 Power source with insufficient capacity and improper work can cause electric shock and fire.
- **Use specified wire for electrical wiring, fasten the wiring to the terminal securely, and hold the cable securely in order not to apply unexpected stress on the terminal.** [!]
 Loose connections or hold could result in abnormal heat generation or fire.
- **Arrange the electrical wires in the control box properly to prevent them from rising. Fit the lid of the services panel properly.** [!]
 Improper fitting may cause abnormal heat and fire.
- **Check for refrigerant gas leakage after installation is completed.** [!]
 If the refrigerant gas leaks into the house and comes in contact with a fan heater, a stove, or an oven, toxic gas is produced.
- **Use the specified pipe, flare nut, and tools for R410A.** [!]
 Using existing parts (R22) could cause the unit failure and serious accident due to explosion of the cooling cycle.
- **Tighten the flare nut according to the specified method by with torque wrench.** [!]
 If the flare nut were tightened with excess torque, it could cause burst and refrigerant leakage after a long period.
- **Do not put the drainage pipe directly into drainage channels where poisonous gases such as sulfide gas can occur.** [!]
 Poisonous gases will flow into the room through drainage pipe and seriously affect the user's health and safety. This can also cause the corrosion of the indoor unit and a resultant unit failure or refrigerant leak.
- **Connect the pipes for refrigeration circuit securely in installation work before compressor is operated.** [!]
 If the compressor is operated when the service valve is open without connecting the pipe, it could cause explosion and injuries due to abnormal high pressure in the system.
- **Stop the compressor before removing the pipe after shutting the service valve on pump down work.** [!]
 If the pipe is removed when the compressor is in operation with the service valve open, air would be mixed in the refrigeration circuit and it could cause explosion and injuries due to abnormal high pressure in the cooling cycle.
- **Only use prescribed optional parts. The installation must be carried out by the qualified installer.** [!]
 If you install the system by yourself, it can cause serious trouble such as water leaks, electric shocks, fire.
- **Do not repair by yourself. And consult with the dealer about repair.** [!]
 Improper repair may cause water leakage, electric shock or fire.
- **Consult the dealer or a specialist about removal of the air conditioner.** [!]
 Improper installation may cause water leakage, electric shock or fire.
- **Turn off the power source during servicing or inspection work.** [!]
 If the power is supplied during servicing or inspection work, it could cause electric shock and injury by the operating fan.
- **Do not run the unit when the panel or protection guard are taken off.** [!]
 Touching the rotating equipment, hot surface, or high voltage section could cause an injury to be caught in the machine, to get burned, or electric shock.
- **Shut off the power before electrical wiring work.** [!]
 It could cause electric shock, unit failure and improper running.

CAUTION

- **Perform earth wiring surely.** [!]
 Do not connect the earth wiring to the gas pipe, water pipe, lightning rod and telephone earth wiring. Improper earth could cause unit failure and electric shock due to a short circuit.
- **Earth leakage breaker must be installed.** [!]
 If the earth leakage breaker is not installed, it can cause electric shocks.
- **Use the circuit breaker of correct capacity. Circuit breaker should be the one that disconnect all poles under over current.** [!]
 Using the incorrect one could cause the system failure and fire.
- **Do not use any materials other than a fuse of correct capacity where a fuse should be used.** [!]
 Connecting the circuit by wire or copper wire could cause unit failure and fire.
- **Do not install the indoor unit near the location where there is possibility of flammable gas leakages.** [!]
 If the gas leaks and gathers around the unit, it could cause fire.
- **Do not install and use the unit where corrosive gas (such as sulfurous acid gas etc.) or flammable gas (such as thinner, petroleum etc.) may be generated or accumulated, or volatile flammable substances are handled.** [!]
 It could cause the corrosion of heat exchanger, breakage of plastic parts etc. And inflammable gas could cause fire.
- **Secure a space for installation, inspection and maintenance specified in the manual.** [!]
 Insufficient space can result in accident such as personal injury due to falling from the installation place.
- **Do not use the indoor unit at the place where water splashes such as laundry.** [!]
 Indoor unit is not waterproof. It could cause electric shock and fire.
- **Do not use the indoor unit for a special purpose such as food storage, cooling for precision instrument, preservation of animals, plants, and a work of art.** [!]
 It could cause the damage of the items.
- **Do not install nor use the system near equipments which generate electromagnetic wave or high harmonics.** [!]
 Equipments like inverter equipment, private power generator, high-frequency medical equipment, or telecommunication equipment might influence the air conditioner and cause a malfunction and breakdown. Or the air conditioner might influence medical equipments or telecommunication equipments, and obstruct their medical activity or cause jamming.
- **Do not install the remote control at the direct sunlight.** [!]
 It could cause breakdown or deformation of the remote control.
- **Do not install the indoor unit at the place listed below.** [!]
 - Places where flammable gas could leak.
 - Places where carbon fiber, metal powder or any powder is floated.
 - Place where the substances which affect the air conditioner are generated such as sulfide gas, chloride gas, acid, alkali or ammoniac atmospheres.
 - On vehicles and ships
 - Places where machinery which generates high harmonics is used.
 - Places where cosmetics or special sprays are frequently used.
 - Highly salted area such as beach.
 - Heavy snow area
 - Places where the system is affected by smoke from a chimney.
 - Altitude over 1000m
- **Do not install the indoor unit in the locations listed below (Be sure to install the indoor unit according to the installation manual for each model because each indoor unit has each limitation)** [!]
 - Locations with any obstacles which can prevent inlet and outlet air of the unit
 - Locations where vibration can be amplified due to insufficient strength of structure.
 - Locations where the infrared receiver is exposed to the direct sunlight or the strong light beam. (in case of the infrared specification unit)
 - Locations where an equipment affected by high harmonics is placed. (TV set or radio receiver is placed within 5m)
 - Locations where drainage cannot run off safely.
 It can affect performance or function and etc..
- **Do not put any valuables which will break down by getting wet under the air conditioner.** [!]
 Condensation could drop when the relative humidity is higher than 80% or drain pipe is clogged, and it damages user's belongings.
- **Do not use the base frame for the outdoor unit which is corroded or damaged after a long period of use.** [!]
 It could cause the unit falling down and injury.
- **Pay attention not to damage the drain pan by weld sputter when brazing work is done near the unit.** [!]
 If sputter entered into the unit during brazing work, it could cause damage (pinhole) of drain pan and leakage of water. To avoid damaging, keep the indoor unit packed or cover the indoor unit.
- **Install the drain pipe to drain the water surely according to the installation manual.** [!]
 Improper connection of the drain pipe may cause dropping water into room and damaging user's belongings.
- **Do not share the drain pipe for indoor unit and GHP (Gas Heat Pump system) outdoor unit.** [!]
 Toxic exhaust gas would flow into room and it might cause serious damage (some poisoning or deficiency of oxygen) to user's health and safety.
- **Be sure to perform air tightness test by pressurizing with nitrogen gas after completed refrigerant piping work.** [!]
 If the density of refrigerant exceeds the limit in the event of refrigerant leakage in the small room, lack of oxygen can occur, which can cause serious accidents.
- **For drain pipe installation, be sure to make descending slope of greater than 1/100, not to make traps, and not to make air-bleeding.** [!]
 Check if the drainage is correctly done during commissioning and ensure the space for inspection and maintenance.
- **Ensure the insulation on the pipes for refrigeration circuit so as not to condense water.** [!]
 Incomplete insulation could cause condensation and it would wet ceiling, floor, and any other valuables.
- **Do not install the outdoor unit where is likely to be a nest for insects and small animals.** [!]
 Insects and small animals could come into the electronic components and cause breakdown and fire. Instruct the user to keep the surroundings clean.
- **Pay extra attention, carrying the unit by hand.** [!]
 Carry the unit with 2 people if it is heavier than 20kg. Do not use the plastic straps but the grabbing place, moving the unit by hand. Use protective gloves in order to avoid injury by the aluminum fin.
- **Make sure to dispose of the packaging material.** [!]
 Leaving the materials may cause injury as metals like nail and woods are used in the package.
- **Do not operate the system without the air filter.** [!]
 It may cause the breakdown of the system due to clogging of the heat exchanger.
- **Do not touch any button with wet hands.** [!]
 It could cause electric shock.
- **Do not touch the refrigerant piping with bare hands when in operation.** [!]
 The pipe during operation would become very hot or cold according to the operating condition, and it could cause a burn or frostbite.
- **Do not clean up the air conditioner with water.** [!]
 It could cause electric shock.
- **Do not turn off the power source immediately after stopping the operation.** [!]
 Be sure to wait for more than 5 minutes. Otherwise it could cause water leakage or breakdown.
- **Do not control the operation with the circuit breaker.** [!]
 It could cause fire or water leakage. In addition, the fan may start operation unexpectedly and it may cause injury.

1 Before installation

- Install correctly according to the installation manual.
- Confirm the following points:
 - Unit type/Power supply specification
 - Pipes/Wires/Small parts
 - Accessory items

Accessory items

For unit hanging		For refrigerant pipe			For drain pipe			
Flat washer (M10)	Level gauge (Insulation)	Pipe cover(big)	Pipe cover (small)	Strap	Pipe cover(big)	Pipe cover(small)	Drain hose	Hose clamp
8	4	1	1	4	1	1	1	1
For adjustment in hoisting in the unit's main body		For heat insulation of gas pipe		For heat insulation of liquid tube	For pipe cover fixing	For heat insulation of drain socket		For drain pipe connecting

2 Selection of installation location for the indoor unit

- Select the suitable areas to install the unit under approval of the user.
 - Areas where the indoor unit can deliver hot and cold wind sufficiently. Suggest to the user to use a circulator if the ceiling height is over 3m to avoid warm air being accumulated on the ceiling.
 - Areas where there is enough space to install and service.
 - Areas where it can be drained properly. Areas where drain pipe descending slope can be taken.
 - Areas where there is no obstruction of airflow on both air return grille and air supply port.
 - Areas where fire alarm will not be accidentally activated by the air conditioner.
 - Areas where the supply air does not short-circuit.
 - Areas where it is not influenced by draft air.
 - Areas not exposed to direct sunlight.
 - Areas where dew point is lower than around 28°C and relative humidity is lower than 80%.
 (This indoor unit is tested under the condition of JIS (Japan Industrial Standard) high humidity condition and confirmed there is no problem. However, there is some risk of condensation drop if the air conditioner is operated under the severer condition than mentioned above. If there is a possibility to use it under such a condition, attach additional insulation of 10 to 20mm thick for entire surface of indoor unit, refrigeration pipe and drain pipe.)
 - Areas where TV and radio stays away more than 1m. (It could cause jamming and noise.)
 - Areas where any items which will be damaged by getting wet are not placed such as food, table wares, server, or medical equipment under the unit.
 - Areas where there is no influence by the heat which cookware generates.
 - Areas where not exposed to oil mist, powder and/or steam directly such as above fryer.
 - Areas where lighting device such as fluorescent light or incandescent light doesn't affect the operation.
 (A beam from lighting device sometimes affects the infrared receiver for the wireless remote control and the air conditioner might not work properly.)
- Check if the place where the air conditioner is installed can hold the weight of the unit. If it is not able to hold, reinforce the structure with boards and beams strong enough to hold it. If the strength is not enough, it could cause injury due to unit falling.
- If there are 2 units of wireless type, keep them away for more than 5m to avoid malfunction due to cross communication.
- When plural indoor units are installed nearby, keep them away for more than 4m.

Space for installation and service

- When it is not possible to keep enough space between indoor unit and wall or between indoor units, close the air supply port where it is not possible to keep space and confirm there is no short circuit of airflow.
- Install the indoor unit at a height of more than 2.5m above the floor.

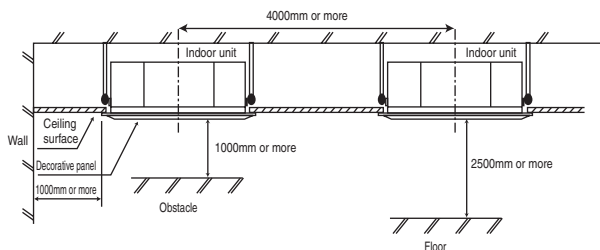

3 Preparation before installation

- If suspension bolt becomes longer, do reinforcement of earthquake resistant.
 - For grid ceiling
 When suspension bolt length is over 500mm, or the gap between the ceiling and roof is over 700mm, apply earthquake resistant brace to the bolt.
 - In case the unit is hanged directly from the slab and is installed on the ceiling plane which has enough strength.
 When suspension bolt length is over 1000mm, apply the earthquake resistant brace to the bolt.
- Prepare four (4) sets of suspension bolt, nut and spring washer (M10 or M8) on site.

Ceiling opening, Suspension bolts pitch, Pipe position

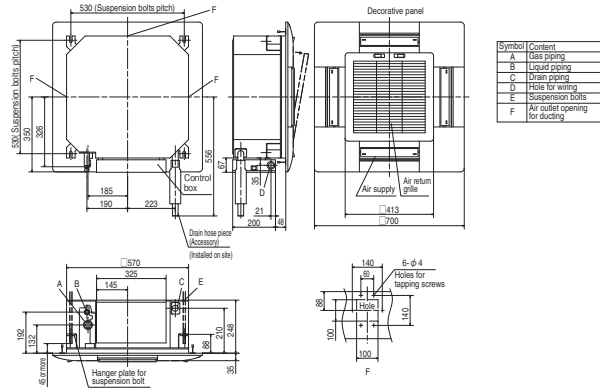

4 Installation of indoor unit

Work procedure

- This unit is designed for 2 x 2 grid ceiling. If necessary, please detach the T bar temporarily before you install it. If it is installed on a ceiling other than 2 x 2 grid ceiling, provide an inspection port on the control box side.
- Arrange the suspension bolt at the right position (530mm x 530mm).
- Make sure to use four suspension bolts and fix them so as to be able to hold 500N load.
- Ensure that the lower end of the suspension bolt should be 45mm above the ceiling plane. Temporarily put the four lower nuts 88mm above the ceiling plane and the upper nuts on distant place from the lower nuts in order not to obstruct hanging the indoor unit or adjust the indoor unit position, and then hang the indoor unit.
- Adjust the indoor unit position after hanging it by inserting the level gauge attached on the package into the air supply port and checking if the gap between the ceiling plane and the indoor unit is appropriate. In order to adjust the indoor unit position, adjust the lower nuts while the upper nuts are put on distant place. Confirm there is no backlash between the hanger plate for suspension bolt and the lower nut and washer.

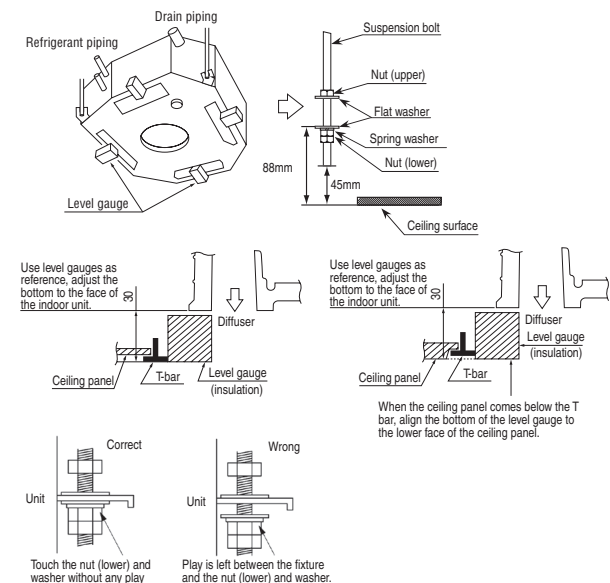

④ Installation of indoor unit (continued)

6. Make sure to install the indoor unit horizontally. Confirm the levelness of the indoor unit with a level gauge or transparent hose filled with water. Keep the height difference at both ends of the indoor unit within 3mm.
7. Tighten four upper nuts and fix the unit after height and levelness adjustment.

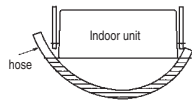

Caution

- Do not adjust the height by adjusting upper nuts. It will cause unexpected stress on the indoor unit and it will lead to deformation of the unit, failure of attaching a panel, and generating noise from the fan.
- Make sure to install the indoor unit horizontally and set the gap between the unit underside and the ceiling plane properly. Improper installation may cause air leakage, dew condensation, water leakage and noise.
- Even after decorative panel attached, still the unit height can be adjusted finely. Refer to the installation manual for decorative panel for details.
- Make sure there is no gap between decoration panel and ceiling surface, and between decoration panel and the indoor unit. The gap may cause air leakage, dew condensation and water leakage.
- In case decorative panel is not installed at the same time, or ceiling material is installed after the unit installed, put the cardboard template for installation attached on the package (packing material of cardboard box) on the bottom of the unit in order to avoid dust coming into the indoor unit.

⑤ Refrigerant pipe

Caution

- Use the new refrigerant pipe.
 - When re-using the existing pipe system for R22 or R407C, pay attention to the following items.
 - Change the flare nuts with the attached ones (JIS category 2), and reprocess the flare parts.
 - Do not use thin-walled pipes.
- Use phosphorus deoxidized copper alloy seamless pipe (C1220T specified in JIS H3300) for refrigeration pipe installation.
 - In addition, make sure there is no damage both inside and outside of the pipe, and no harmful substances such as sulfur, oxide, dust or a contaminant stuck on the pipes.
- Do not use any refrigerant other than R410A.
 - Using other refrigerant except R410A (R22 etc.) may degrade inside refrigeration oil. And air getting into refrigeration circuit may cause over-pressure and resultant it may result in bursting, etc.
- Store the copper pipes indoors and seal the both end of them until they are brazed in order to avoid any dust, dirt or water getting into pipe. Otherwise it will cause degradation of refrigeration oil and compressor breakdown, etc.
- Use special tools for R410A refrigerant.

Work procedure

1. Remove the flare nut and blind flanges on the pipe of the indoor unit.
 - ※ Make sure to loosen the flare nut with holding the nut on pipe side with a spanner and giving torque to the nut with another spanner in order to avoid unexpected stress to the copper pipe, and then remove them.
 - (Gas may come out at this time, but it is not abnormal.)
 - Pay attention whether the flare nut pops out. (as the indoor unit is sometimes pressured.)
2. Make a flare on liquid pipe and gas pipe, and connect the refrigeration pipes on the indoor unit.
 - ※ Bend the pipe with as big radius as possible and do not bend the pipe repeatedly. In addition, do not twist and crush the pipes.
 - ※ Do a flare connection as follows:
 - Make sure to loosen the flare nut with holding the nut on pipe side with a spanner and giving torque to the nut with another spanner in order to avoid unexpected stress to the copper pipe, and then remove them.
 - When fastening the flare nut, align the refrigeration pipe with the center of flare nut, screw the nut for 3-4 times by hand and then tighten it by spanner with the specified torque mentioned in the table below. Make sure to hold the pipe on the indoor unit securely by a spanner when tightening the nut in order to avoid unexpected stress on the copper pipe.
3. Cover the flare connection part of the indoor unit with attached insulation material after a gas leakage inspection, and tighten both ends with attached straps.
 - Make sure to insulate both gas pipes and liquid pipes completely.
 - ※ Incomplete insulation may cause dew condensation or water drooping.
4. Refrigerant is charged in the outdoor unit.
 - As for the additional refrigerant charge for the indoor unit and piping, refer to the installation manual attached to the outdoor unit.

Pipe diameter	Tightening torque N·m
φ 6.35	14 to 18
φ 9.52	34 to 42
φ 12.7	49 to 61
φ 15.88	68 to 82
φ 19.05	100 to 120

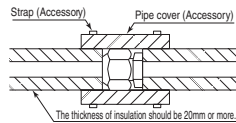

⑥ Drain pipe

Caution

- Install the drain pipe according to the installation manual in order to drain properly. Imperfection in draining may cause flood indoors and wetting the household goods etc.
- Do not put the drain pipe directly into the ditch where toxic gas such as sulfur, the other harmful and inflammable gas is generated. Toxic gas would flow into the room and it would cause serious damage to user's health and safety (some poisoning or deficiency of oxygen). In addition, it may cause corrosion of heat exchanger and bad smell.
- Connect the pipe securely to avoid water leakage from the joint.
- Insulate the pipe properly to avoid condensation drop.
- Check if the water can flow out properly from both the drain outlet on the indoor unit and the end of the drain pipe after installation.
- Make sure to make descending slope of greater than 1/100 and do not make up-down bend and/or trap in the midway. In addition, do not put air vent on the drain pipe. Check if water is drained out properly from the pipe during commissioning. Also, keep sufficient space for inspection and maintenance.

⑥ Drain pipe (continued)

Work procedure

1. Make sure to insert the drain hose (the end mode of soft PVC) to the end of the step part of drain socket.
 - Attach the hose clamp to the drain hose around 10mm from the end, and fasten the screw within 5mm left to the nut.
 - Do not apply adhesives on this end.

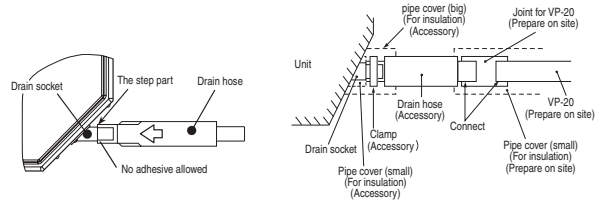

Fasten the screw within 5 mm left to the nut.

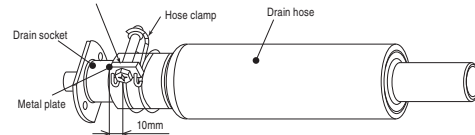

2. Prepare a joint for connecting VP-20 pipe, adhere and connect the joint to the drain hose (the end made of rigid PVC), and adhere and connect VP-20 pipe (prepare on site).
 - ※ As for drain pipe, apply VP-20 made of rigid PVC which is on the market.
 - Make sure that the adhesive will not get into the supplied drain hose. It may cause the flexible part broken after the adhesive is dried up and gets rigid.
 - Do not bend or make an excess offset on the drain hose as shown in the picture. Bend or excess offset will cause drain leakage.

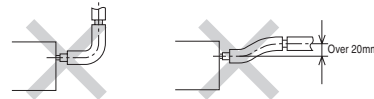

3. Make sure to make descending slope of greater than 1/100 and do not make up-down bend and/or trap in the midway.
 - Pay attention not to give stress on the pipe on the indoor unit side, and support and fix the pipe as close place to the unit as possible when connecting the drain pipe.
 - Do not set up air vent.

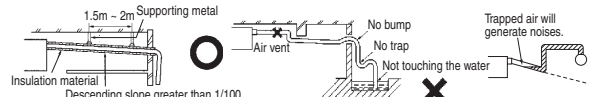

- When sharing a drain pipe for more than one unit, lay the main pipe 100mm below the drain outlet of the unit. In addition, select VP-30 or bigger size for main drain pipe.

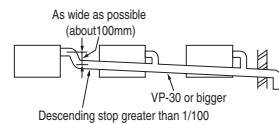

4. Insulate the drain pipe.
 - Be sure to insulate the drain socket and rigid PVC pipe installed indoors otherwise it may cause dew condensation and water leakage.
 - ※ After drainage test implementation, cover the drain socket part with pipe cover (small size), then use the pipe cover (big size) to cover the pipe cover (small size), clamps and part of the drain hose, and fix and wrap it with tapes to wrap and make joint part gapless.

Drain up

- The position for drain pipe outlet can be raised up to 600mm above the ceiling. Use elbows for installation to avoid obstacles inside ceiling. If the horizontal drain pipe is too long before vertical pipe, the backflow of water will increase when the unit is stopped, and it may cause overflow of water from the drain pan on the indoor unit. In order to avoid overflow, keep the horizontal pipe length and offset of the pipe within the limit shown in the figure below.

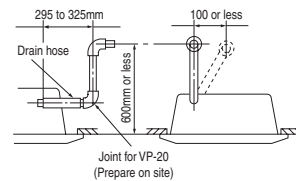

⑥ Drain pipe (continued)

Drain test

- After installation of drain pipe, make sure that drain system work in good condition and no water leakage from joint and drain pan. Check if the motor sound of drain pump is normal or not.
 - Do drain test even if installation of heating season.
 - For new building cases, make sure to complete the test before hanging the ceiling.
1. Pour water of about 1000cc into the drain pan in the indoor unit by pump so as not to get the electrical component wet.
 2. Make sure that water is drained out properly and there is no water leakage from any joints of the drain pipe at the test. Confirm that the water is properly drained out while the drain motor is operating. At the drain socket (transparent), it is possible to check if the water is drained out properly.
 3. Unplug the drain plug on the indoor unit to remove remaining water on the drain pan after the test, and re-plug it. And insulate the drain pipe properly finally.

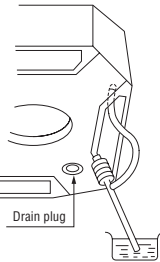

Drain pump operation

- In case electrical wiring work finished
Drain pump can be operated by remote control (wired).
For the operation method, refer to [Operation for drain pump] in the installation manual for wiring work.
- In case electrical wiring work not finished
Drain pump will run continuously when the dip switch "SW7-1" on the indoor unit PCB is turned ON, the Connector CNB is disconnected, and then the power supply (220-240VAC on the terminal block [① and ②] or [L and N]) is turned ON.
Make sure to turn OFF "SW7-1" and reconnect the Connector CNB after the test.

⑦ Wiring-out position and wiring connection

- Electrical installation work must be performed according to the installation manual by an electrical installation service provider qualified by a power provider of the country, and be executed according to the technical standards and other regulations applicable to electrical installation in the country. Be sure to use an exclusive circuit.
 - Use specified cord, fasten the wiring to the terminal securely, and hold the cord securely in order not to apply unexpected stress on the terminal.
 - Do not put both power source line and signal line on the same route. It may cause miscommunication and malfunction.
 - Be sure to do D type earth work.
 - For the details of electrical wiring work, see attached instruction manual for electrical wiring work.
1. Remove a lid of the control box (1 screws).
 2. Hold each wiring inside the unit and fasten them to terminal block securely.
 3. Fix the wiring with clamp.
 4. Install a lid of the control box back to original place.

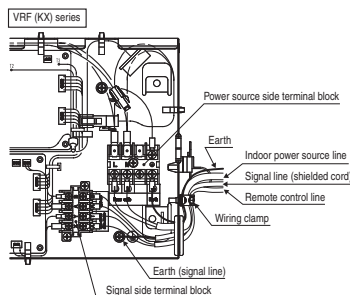
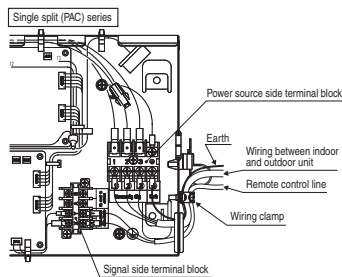

⑧ Panel installation

- After wiring work finished, install the panel on the indoor unit.
- Refer to attached panel installation manual for details. (see next page)

Accessory items

No.	Item	Quantity	Use
1	Hook	1 piece	For fixing temporarily
2	Chain	2 pieces	
3	Bolt	4 pieces	For installing the panel
4	Screw	1 piece	For attaching a hook
5	Screw	2 pieces	For attaching a chain

- Attach the panel on the indoor unit after electrical wiring work.
- Refer to attached manual for panel installation for details. (See next page)

⑨ Check list after installation

- Check the following items after all installation work completed.



Check if	Expected trouble	Check
The indoor and outdoor units are fixed securely?	Falling, vibration, noise	
Inspection for leakage is done?	Insufficient capacity	
Insulation work is properly done?	Water leakage	
Water is drained properly?	Water leakage	
Supply voltage is same as mentioned in the model name plate?	PCB burnt out, not working at all	
There is mis-wiring or mis-connection of piping?	PCB burnt out, not working at all	
Earth wiring is connected properly?	Electric shock	
Cable size comply with specified size?	PCB burnt out, not working at all	
Any obstacle blocks airflow on air inlet and outlet?	Insufficient capacity	

PANEL INSTALLATION MANUAL

PJA012D783 

Please read this manual together with the indoor unit's installation manual.

WARNING

- Fasten the wiring to the terminal securely and hold the cable securely so as not to apply unexpected stress on the terminal.  Loose connection or hold will cause abnormal heat generation or fire.
- Make sure the power supply is turned off when electric wiring work.  Otherwise, electric shock, malfunction and improper running may occur.

① Checking the indoor unit installation position

- Read this manual together with the air conditioner installation manual carefully.
- Check if the gap between the ceiling plane and the indoor unit is correct by inserting the level gauge into the air outlet port of the indoor unit. (See below drawing)
- Adjust the installation elevation if necessary.
- Remove the level gauge before you attach the panel.

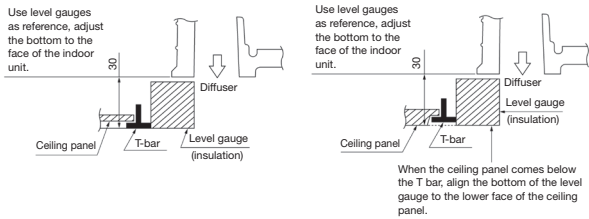

② Orientation of the panel and return air grille installation

1. Take note that there is an orientation to install the panel.
 - Attach the panel with the orientation shown on the below.
 - Align the "PIPE SIDE" mark (on the panel) with the refrigerant pipes on the indoor unit.
2. The intake grille can also be attached in a rotated position by 90 degrees.

Caution

In case the orientation of the panel is not correct, it will lead to air leakage and also it is not possible to connect the louver motor wiring.

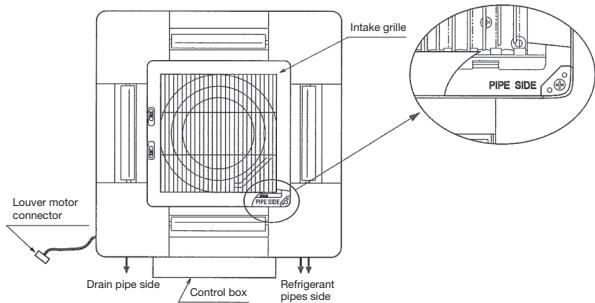

③ Removing a corner panel

- Unscrew the screw from the corner area, pull the corner panel toward the direction indicated by the arrow mark.

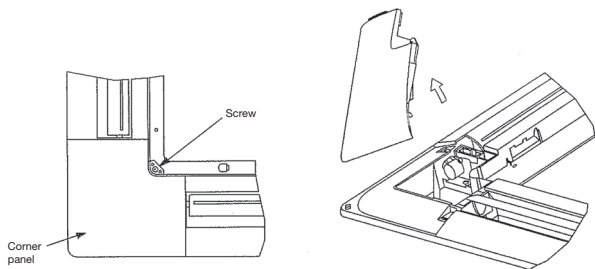

④ Attaching a corner panel



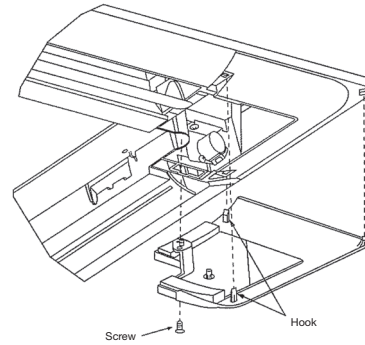

- First insert the part "a" of a corner panel into the part "A" of the cover panel, engage two hooks and tighten the screw.



⑤ Panel installation

- Install the panel on the unit after completing the electrical wiring.

Accessories

No.	Item	Image	Quantity	Use
1	Hook		1 piece	For fixing temporarily
2	Chain		2 pieces	
3	Screw		4 pieces	For hoisting the panel
4	Screw		1 piece	For attaching a hook
5	Screw		2 pieces	For attaching a chain

1. Screw in two bolts out of the four supplied with the panel by about slightly less than 5mm. (● mark (A/B)) [Figure 1]

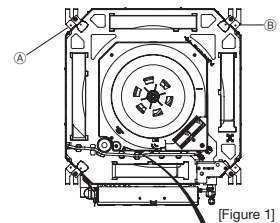

2. Attach the hook supplied with the panel to the main body with the hook fixing screw (1 screw). [Figure 2]

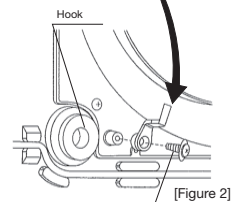

3. Open the intake grille.
4. Please remove the screw of a corner panel and remove a corner panel. (four places)

5. A panel is hooked on two bolts (● mark (A/B)). [Figure 3]

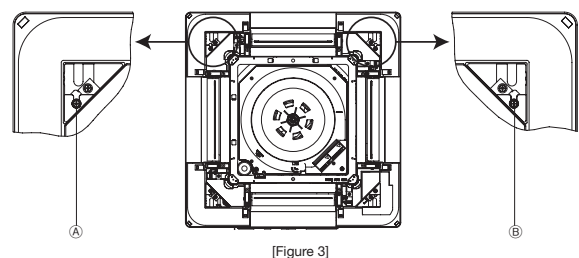

6. Please rotate a hook, put in the slot on the panel, and carry out fixing the panel temporarily. [Figure 4]

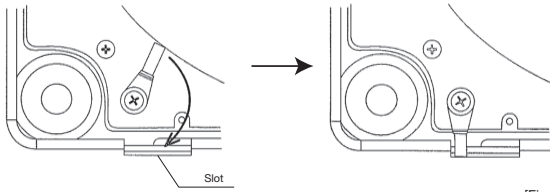

[Figure 4]

7. Tighten the two bolts used for fixing the panel temporarily and the other two.

Caution

- Improperly tightened hanging bolts can cause the problems listed below, so make sure that you have tightened them securely.
- If there is a gap remaining between the ceiling and the decorative panel even after the hanging bolts are tightened, adjust the installation level of the indoor unit again.



- 8. Please open the lid of a control box.
- 9. Like drain pump wiring, please band together by the clamp and put in louver motor wiring into a control box. [Figure 5]
- 10. Please connect a louver motor connector. [Figure 5]

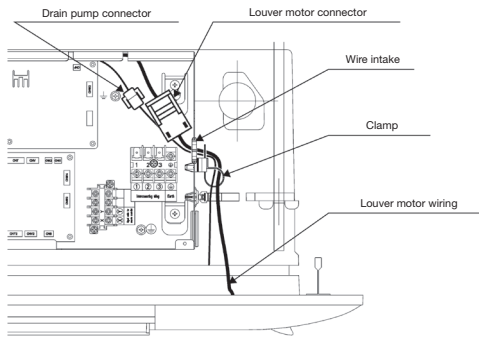

[Figure 5]

11. Attach two chains to the intake grille with two screws. [Figure 6]

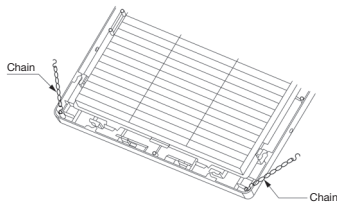

[Figure 6]

- 12. Replace the corner panels. Please also close a chain with a screw together then. [Figure 7]
- 13. Close the intake grill.

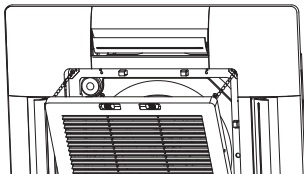

[Figure 7]

Caution

Make sure there is no stress given on the panel when adjusting the height of the indoor unit to avoid unexpected distortion. It may cause the distortion of panel or failing to close the air return grille.

⑦ How to set the airflow direction

It is possible to change the movable range of the louver on the air outlet from the wired remote control. Once the top and bottom position is set, the louver will swing within the range between the top and the bottom when swing operation is chosen. It is also possible to apply different setting to each louver. Note: This function is not able to be set with wireless remote control or simple remote control (RCH-H3).

1 Stop the air conditioner and press **SET button and **LOUVER** button simultaneously for three seconds or more.**

The following is displayed if the number of the indoor units connected to the remote control is one. Go to step 4.

"DATA LOADING"
No.1

The following is displayed if the number of the indoor units connected to the remote controller are more than one

"SELECT 1/1"
1/1000

2 Press **▲ or **▼** button. (selection of indoor unit)**

Select the indoor unit of which the louver is set.

[EXAMPLE]

1/1000 ▲=1/1001 ◀=1/1002 ▶=
1/1003

3 Press **SET button. (determination of indoor unit)**

Selected indoor unit is fixed.

[EXAMPLE]

1/1001 (displayed for two seconds)
"DATA LOADING"
No.1

4 Press **▲ or **▼** button. (selection of louver No.)**

Select the louver No. to be set according to the right figure.

[EXAMPLE]

No.1 ▲=No.2 ▶=No.3 ◀=
No.4

5 Press **SET button. (Determination of louver No.)**

The louver No. to be set is confirmed and the display shows the upper limit of the movable range.

[EXAMPLE] If No.1 louver is selected,
No.1 UPPER2 ▶ -- current upper limit position

6 Press **▲ or **▼** button. (selection of upper limit position)**

Select the upper limit of louver movable range.
"position 1" is the most horizontal, and "position 6" is the most downward.
"position --" is to return to the factory setting. If you need to change the setting to the default setting, use "position --".

No.1 UPPER1 ▼ (the most horizontal)
No.1 UPPER2 ◀
No.1 UPPER3 ▶
No.1 UPPER4 ◀
No.1 UPPER5 ▶
No.1 UPPER6 ▲ (the most downwards)
No.1 UPPER-- ▲ (return to the default setting)

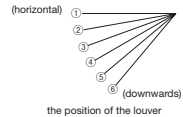

7 Press **SET button. (Fixing of the upper limit position)**

The upper limit position is fixed and the setting position is displayed for two seconds. Then proceed to lower limit position selection display.

[EXAMPLE]
No.1 UPPER2 (displayed for two seconds)
No.1 LOWER5 (shows current setting)

8 Press **▲ or **▼** button. (Selection of lower limit position)**

Select the lower limit position of louver.
"position 1" is the most horizontal, and "position 6" is the most downwards.
"position --" is to return to the factory setting. If you need to change the setting to the default setting, use "position --".

No.1 LOWER1 ▼ (the most horizontal)
No.1 LOWER2 ◀
No.1 LOWER3 ▶
No.1 LOWER4 ◀
No.1 LOWER5 ▶
No.1 LOWER6 ▲ (the most downwards)
No.1 LOWER-- ▲ (return to the default setting)

9 Press **SET button. (Fixing of the lower limit position)**

Upper limit position and lower limit position are fixed, and the set positions are displayed for two seconds, then setting is completed.
After the setting is completed, the louver which was set moves from the original position to the lower limit position, and goes back to the original position again. (This operation is not performed if the indoor unit and/or indoor unit fan is in operation.)

[EXAMPLE]
No.1 L2 L5 (displayed for two seconds)
SET COMPLETE
No.1

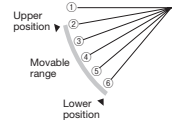

10 Press **ON/OFF button.**

Louver adjusting mode ends and returns to the original display.
For setting the swing range of other louvers, return to 1 and proceed same procedure respectively.

Caution

If the upper limit position number and the lower limit position number are set to the same position, the louver is fixed at that position auto swing does not function.

ATTENTION

If you press **RESET** button during settings, the display will return to previous display.
If you press **ON/OFF** button during settings, the mode will be ended and return to original display, and the settings that have not been completed will become invalid.

When plural remote controllers are connected, louver setting operation cannot be set by slave remote control.

If it is necessary to fix the louver position manually, follow the procedure mentioned below.

1. Shut off the main power switch.
2. Unplug the connector of the louver motor which you want to fix the position.
Make sure to insulate unplugged connectors electrically with a vinyl tape.
3. Adjust the louver position slowly by hand so as to be within the applicable range mentioned below table.

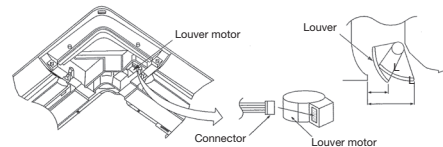

<Range of louver setting>

Vertical airflow direction	Horizontal 23°	Downwards 50°
Dimension L (mm)	40	24

※ It can be set between 24-40mm freely.

Caution







- Any automatic control or operation from the remote control will be disabled on the louver whose position is fixed in the above way.
- Do not set a louver beyond the specified range. Failure to observe this instruction may result in dripping, dew condensation, the fouling of the ceiling and the malfunctioning of the unit.

PFA012D621B 























(3) Ceiling suspended type (FDEN)

This manual is for the installation of an indoor unit.
 For electrical wiring work (Indoor), refer to page 251. For remote control installation, refer to page 263. For wireless kit installation, refer to page 519. For electrical wiring work (Outdoor) and refrigerant pipe work installation for outdoor unit, refer to the page 277.































SAFETY PRECAUTIONS

- Read the "SAFETY PRECAUTIONS" carefully first of all and then strictly follow it during the installation work in order to protect yourself.
- The precautionary items mentioned below are distinguished into two levels,  **WARNING** and  **CAUTION**.
 **WARNING**: Wrong installation would cause serious consequences such as injuries or death.
 **CAUTION**: Wrong installation might cause serious consequences depending on circumstances. Both mentions the important items to protect your health and safety so strictly follow them by any means.
- The meanings of "Marks" used here are as shown as follows:
 Never do it under any circumstances.  Always do it according to the instruction.
- After completing the installation, do commissioning to confirm there are no abnormalities, and explain to the customers about "SAFETY PRECAUTIONS", correct operation method and maintenance method (air filter cleaning, operation method and temperature setting method) with user's manual of this unit. Ask your customers to keep this installation manual together with the user's manual. Also, ask them to hand over the user's manual to the new user when the owner is changed.

WARNING

- **Installation should be performed by the specialist.** 
If you install the unit by yourself, it may lead to serious trouble such as water leakage, electric shock, fire, and injury due to overturn of the unit.
- **Install the system correctly according to these installation manuals.** 
Improper installation may cause explosion, injury, water leakage, electric shock, and fire.
- **When installing in small rooms, take prevention measures not to exceed the density limit of refrigerant in the event of leakage, referred by the formula (accordance with ISO5149).** 
If the density of refrigerant exceeds the limit, please consult the dealer and install the ventilation system, otherwise lack of oxygen can occur, which can cause serious accidents.
- **Use the genuine accessories and the specified parts for installation.** 
If parts unspecified by our company are used it could cause water leakage, electric shock, fire, and injury due to overturn of the unit.
- **Ventilate the working area well in case the refrigerant leaks during installation.** 
If the refrigerant contacts the fire, toxic gas is produced.
- **Install the unit in a location that can hold heavy weight.** 
Improper installation may cause the unit to fall leading to accidents.
- **Install the unit properly in order to be able to withstand strong winds such as typhoons, and earthquakes.** 
Improper installation may cause the unit to fall leading to accidents.
- **Do not mix air in to the cooling cycle on installation or removal of the air conditioner.** 
If air is mixed in, the pressure in the cooling cycle will rise abnormally and may cause explosion and injuries.
- **Be sure to have the electrical wiring work done by qualified electrical installer, and use exclusive circuit.** 
Power source with insufficient capacity and improper work can cause electric shock and fire.
- **Use specified wire for electrical wiring, fasten the wiring to the terminal securely, and hold the cable securely in order not to apply unexpected stress on the terminal.** 
Loose connections or hold could result in abnormal heat generation or fire.
- **Arrange the electrical wires in the control box properly to prevent them from rising. Fit the lid of the services panel property.** 
Improper fitting may cause abnormal heat and fire.
- **Check for refrigerant gas leakage after installation is completed.** 
If the refrigerant gas leaks into the house and comes in contact with a fan heater, a stove, or an oven, toxic gas is produced.
- **Use the specified pipe, flare nut, and tools for R410A.** 
Using existing parts (R22) could cause the unit failure and serious accident due to explosion of the cooling cycle.
- **Tighten the flare nut according to the specified method by with torque wrench.** 
If the flare nut were tightened with excess torque, it could cause burst and refrigerant leakage after a long period.
- **Do not put the drainage pipe directly into drainage channels where poisonous gases such as sulfide gas can occur.** 
Poisonous gases will flow into the room through drainage pipe and seriously affect the user's health and safety. This can also cause the corrosion of the indoor unit and a resultant unit failure or refrigerant leak.
- **Connect the pipes for refrigeration circuit securely in installation work before compressor is operated.** 
If the compressor is operated when the service valve is open without connecting the pipe, it could cause explosion and injuries due to abnormal high pressure in the system.
- **Stop the compressor before removing the pipe after shutting the service valve on pump down work.** 
If the pipe is removed when the compressor is in operation with the service valve open, air would be mixed in the refrigeration circuit and it could cause explosion and injuries due to abnormal high pressure in the cooling cycle.
- **Only use prescribed optional parts. The installation must be carried out by the qualified installer.** 
If you install the system by yourself, it can cause serious trouble such as water leaks, electric shocks, fire.
- **Do not repair by yourself. And consult with the dealer about repair.** 
Improper repair may cause water leakage, electric shock or fire.
- **Consult the dealer or a specialist about removal of the air conditioner.** 
Improper installation may cause water leakage, electric shock or fire.
- **Turn off the power source during servicing or inspection work.** 
If the power is supplied during servicing or inspection work, it could cause electric shock and injury by the operating fan.
- **Do not run the unit when the panel or protection guard are taken off.** 
Touching the rotating equipment, hot surface, or high voltage section could cause an injury to be caught in the machine, to get burned, or electric shock.
- **Shut off the power before electrical wiring work.** 
It could cause electric shock, unit failure and improper running.

CAUTION

- **Perform earth wiring surely.** 
Do not connect the earth wiring to the gas pipe, water pipe, lightning rod and telephone earth wiring. Improper earth could cause unit failure, electric shock and fire due to a short circuit.
- **Earth leakage breaker must be installed.** 
If the earth leakage breaker is not installed, it can cause fire and electric shocks.
- **Use the circuit breaker of correct capacity. Circuit breaker should be the one that disconnect all poles under over current.** 
Using the incorrect one could cause the system failure and fire.
- **Do not use any materials other than a fuse of correct capacity where a fuse should be used.** 
Connecting the circuit by wire or copper wire could cause unit failure and fire.
- **Do not install the indoor unit near the location where there is possibility of flammable gas leakages.** 
If the gas leaks and gathers around the unit, it could cause fire.
- **Do not install and use the unit where corrosive gas (such as sulfurous acid gas etc.) or flammable gas (such as thinner, petroleum etc.) may be generated or accumulated, or volatile flammable substances are handled.** 
It could cause the corrosion of heat exchanger, breakage of plastic parts etc. And inflammable gas could cause fire.
- **Secure a space for installation, inspection and maintenance specified in the manual.** 
Insufficient space can result in accident such as personal injury due to falling from the installation place.
- **Do not use the indoor unit at the place where water splashes such as laundry.** 
Indoor unit is not waterproof. It could cause electric shock and fire.
- **Do not use the indoor unit for a special purpose such as food storage, cooling for precision instrument, preservation of animals, plants, and a work of art.** 
It could cause the damage of the items.
- **Do not install nor use the system near equipments which generate electromagnetic wave or high harmonics.** 
Equipments like inverter equipment, private power generator, high-frequency medical equipment, or telecommunication equipment might influence the air conditioner and cause a malfunction and breakdown. Or the air conditioner might influence medical equipments or telecommunication equipments, and obstruct their medical activity or cause jamming.
- **Do not install the remote control at the direct sunlight.** 
It could cause breakdown or deformation of the remote control.
- **Do not install the indoor unit at the place listed below.** 
 - Places where flammable gas could leak.
 - Places where carbon fiber, metal powder or any powder is floated.
 - Place where the substances which affect the air conditioner are generated such as sulfide gas, chloride gas, acid, alkali or ammoniac atmospheres.
 - Places exposed to oil mist or steam directly.
 - On vehicles and ships
 - Places where machinery which generates high harmonics is used.
 - Places where cosmetics or special sprays are frequently used.
 - Highly salted area such as beach.
 - Heavy snow area
 - Places where the system is affected by smoke from a chimney.
 - Altitude over 1000m
- **Do not install the indoor unit in the locations listed below (Be sure to install the indoor unit according to the installation manual for each model because each indoor unit has each limitation)** 
 - Locations with any obstacles which can prevent inlet and outlet air of the unit
 - Locations where vibration can be amplified due to insufficient strength of structure.
 - Locations where the infrared receiver is exposed to the direct sunlight or the strong light beam. (in case of the infrared specification unit)
 - Locations where an equipment affected by high harmonics is placed. (TV set or radio receiver is placed within 5m)
 - Locations where drainage cannot run off safely. It can affect performance or function and etc..
- **Do not put any valuables which will break down by getting wet under the air conditioner.** 
Condensation could drop when the relative humidity is higher than 80% or drain pipe is clogged, and it damages user's belongings.
- **Do not use the base frame for the outdoor unit which is corroded or damaged after a long period of use.** 
It could cause the unit falling down and injury.
- **Pay attention not to damage the drain pan by weld sputter when brazing work is done near the unit.** 
If sputter entered into the unit during brazing work, it could cause damage (pinhole) of drain pan and leakage of water. To avoid damaging, keep the indoor unit packed or cover the indoor unit.
- **Install the drain pipe to drain the water surely according to the installation manual.** 
Improper connection of the drain pipe may cause dropping water into room and damaging user's belongings.
- **Do not share the drain pipe for indoor unit and GHP (Gas Heat Pump system) outdoor unit.** 
Toxic exhaust gas would flow into room and it might cause serious damage (some poisoning or deficiency of oxygen) to user's health and safety.
- **Be sure to perform air tightness test by pressurizing with nitrogen gas after completed refrigerant piping work.** 
If the density of refrigerant exceeds the limit in the event of refrigerant leakage in the small room, lack of oxygen can occur, which can cause serious accidents.
- **For drain pipe installation, be sure to make descending slope of greater than 1/100, not to make traps, and not to make air-bleeding.** 
Check if the drainage is correctly done during commissioning and ensure the space for inspection and maintenance.
- **Ensure the insulation on the pipes for refrigeration circuit so as not to condense water.** 
Incomplete insulation could cause condensation and it would wet ceiling, floor, and any other valuables.
- **Do not install the outdoor unit where is likely to be a nest for insects and small animals.** 
Insects and small animals could come into the electronic components and cause breakdown and fire. Instruct the user to keep the surroundings clean.
- **Pay extra attention, carrying the unit by hand.** 
Carry the unit with 2 people if it is heavier than 20kg. Do not use the plastic straps but the grabbing place, moving the unit by hand. Use protective gloves in order to avoid injury by the aluminum fin.
- **Make sure to dispose of the packaging material.** 
Leaving the materials may cause injury as metals like nail and woods are used in the package.
- **Do not operate the system without the air filter.** 
It may cause the breakdown of the system due to clogging of the heat exchanger.
- **Do not touch any button with wet hands.** 
It could cause electric shock.
- **Do not touch the refrigerant piping with bare hands when in operation.** 
The pipe during operation would become very hot or cold according to the operating condition, and it could cause a burn or frostbite.
- **Do not clean up the air conditioner with water.** 
It could cause electric shock.
- **Do not turn off the power source immediately after stopping the operation.** 
Be sure to wait for more than 5 minutes. Otherwise it could cause water leakage or breakdown.
- **Do not control the operation with the circuit breaker.** 
It could cause fire or water leakage. In addition, the fan may start operation unexpectedly and it may cause injury.

① Before installation

- Install correctly according to the installation manual.
- Confirm the following points:
 - Unit type/Power supply specification
 - Pipes/Wires/Small parts
 - Accessory items

Accessory item

For unit hanging		For refrigerant pipe				For drain pipe				For air return
Flat washer (M10)	Paper pattern	Pipe cover (large)	Pipe cover (small)	Strap	Drain hose with clamp	Hose clamp	Flange bracket	Screw	Heat insulation	Screw
8	1	1	1	4	1	1	1	2	1	4
For unit hanging	For unit hanging and adjustment	For heat insulation of gas pipe	For heat insulation of liquid pipe	For fixing of pipe cover	For drain pipe connection	For drain hose mounting	For fixing of drain hose	For installing of flange bracket	For drain hose	For fixing air return grille

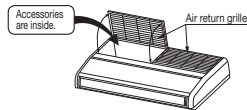

② Selection of installation location for the indoor unit

- Select the suitable areas to install the unit under approval of the user.
 - Areas where the indoor unit can deliver hot and cold wind sufficiently. Suggest to the user to use a circulator if the ceiling height is over 3m to avoid warm air being accumulated on the ceiling.
 - Areas where there is enough space to install and service.
 - Areas where it can be drained properly. Areas where drain pipe descending slope can be taken.
 - Areas where there is no obstruction of airflow on both air return grille and air supply port.
 - Areas where fire alarm will not be accidentally activated by the air conditioner.
 - Areas where the supply air does not short-circuit.
 - Areas where it is not influenced by draft air.
 - Areas not exposed to direct sunlight.
 - Areas where dew point is lower than around 23°C and relative humidity is lower than 80%. This indoor unit is tested under the condition of JIS (Japan Industrial Standard) high humidity condition and confirmed there is no problem. However, there is some risk of condensation drop if the air conditioner is operated under the severer condition than mentioned above.
 - Areas where TV and radio stays away more than 1m. (It could cause jamming and noise.)
 - Areas where any items which will be damaged by getting wet are not placed such as food, table wares, server, or medical equipment under the unit.
 - Areas where there is no influence by the heat which cookware generates.
 - Areas where not exposed to oil mist, powder and/or steam directly such as above fryer.
 - Areas where lighting device such as fluorescent light or incandescent light doesn't affect the operation. (A beam from lighting device sometimes affects the infrared receiver for the wireless remote control and the air conditioner might not work properly.)
- Check if the place where the air conditioner is installed can hold the weight of the unit. If it is not able to hold, reinforce the structure with boards and beams strong enough to hold it. If the strength is not enough, it could cause injury due to unit falling.
- If there are 2 units of wireless type, keep them away for more than 6m to avoid malfunction due to cross communication.
- When plural indoor units are installed nearby, keep them away for more than 4 to 5m.

Space for installation and service

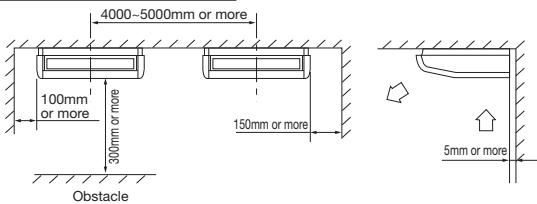

③ Preparation before installation

- If suspension bolt becomes longer, do reinforcement of earthquake resistant.
 - For grid ceiling
 - When suspension bolt length is over 500mm, or the gap between the ceiling and roof is over 700mm, apply earthquake resistant brace to the bolt.
 - In case the unit is hanged directly from the slab and is installed on the ceiling plane which has enough strength.
 - When suspension bolt length is over 1000mm, apply the earthquake resistant brace to the bolt.
- Prepare four (4) sets of suspension bolt, nut and spring washer (M10) on site.

③ Preparation before installation (continued)

Pitch of suspension bolts and pipe position

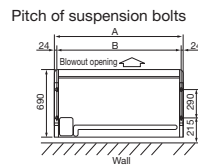

Series	type	(mm)	
		A	B
Single Split (PAC) series	40 to 50type	1070	1022
	60 to 71type	1320	1272
	100 to 140type	1620	1572
VRF (KX) series	36 to 56type	1070	1022
	71type	1320	1272
	112 to 140type	1620	1572

Pipe position

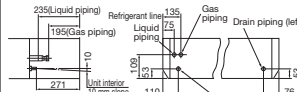

Haulage

- Move the box as close to the installation area as possible packed.
- If it must be unpacked, wrap the unit with a nylon sling, and be careful not to damage the unit.
- If you need to lay the unit on a floor after unpacking, always put it with the intake grille facing upward.



Preparation before installation

- Remove the air return grille.**
Slide stoppers (4 places) of the catches, then pull out the pins (4 or 6 places).
- Remove the side panel.**
Remove the screw and detach the side panel by sliding it toward the direction indicated by the arrow mark.

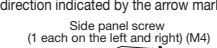
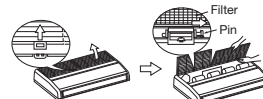

- Remove the hanging plate.**
Remove the screw, and then loosen the fixing bolts.

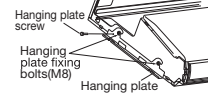

④ Remote control

Installation of remote control

- Up to two receiver or wired remote control can be installed in one indoor unit group.
- When both wired and wireless remote control are used
It is necessary to set wired or wireless remote control as slave. (For the method of changing the setting, refer to the installation manual attached to remote control or wireless kit.)
 - When wired remote control are used only (wireless type)
It is necessary to remove the line that is connected to the receiver. Remove signal line connected to the receiver from primary side of terminal block (X, Y).

ATTENTION

- ① Insulate with tape the removed line.
- ② The LED of that removed connector will not be able to make any indication.

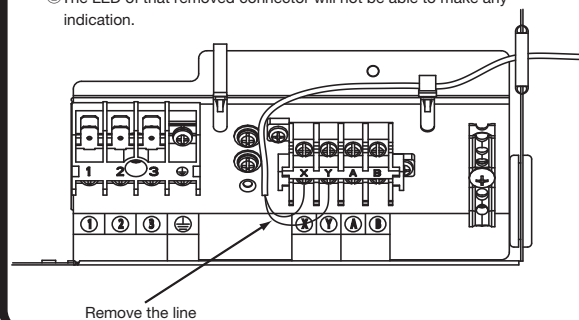

5 Installation of indoor unit

Work procedure

- Select the suspension bolt locations and the pipe hole location.
 - Use enclosed paper pattern as a reference, and drill the holes for the suspension bolts and pipe.
 - ※Decide the locations based on direct measurements.
 - Once the locations are properly placed, the paper pattern can be removed.
- Install the suspension bolts in place.
- Fix with 4 suspension bolts, which can endure load of 500N.
- Check the measurements given at the right figure for the length of the suspension bolts.

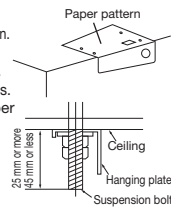

- Fasten the hanging plate onto the suspension bolts.
 - <When installed against a ceiling material.>
 - <No ceiling material to install against.>

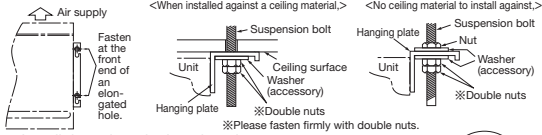

- Install the unit to the hanging plate.
 - Slide the unit in from front side to get it hung on the hanging plate with the bolts.
 - Fasten the four fixing bolts (M8: 2 each on the left and right sides) firmly.
 - Fasten the two screws (M4: 1 each on the left and right sides).

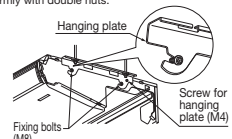

⚠WARNING : Hang a side panel on from the panel side to the rear side and then fasten it securely onto the indoor unit with screws.

※To ensure smooth drain flow, install the unit with a descending slope toward the drain outlet.

⚠CAUTION : Do not give the reversed slope, which may cause water leaks.

6 Refrigerant pipe

Caution

- Use the new refrigerant pipe.
 - When re-using the existing pipe system for R22 or R407C, pay attention to the following items.
 - Change the flare nuts with the attached ones (JIS category 2), and reprocess the flare parts.
 - Do not use thin-walled pipes.
- Use phosphorus deoxidized copper alloy seamless pipe (C1220T specified in JIS H3300) for refrigerant pipe installation. In addition, make sure there is no damage both inside and outside of the pipe, and no harmful substances such as sulfur, oxide, dust or a contaminant stuck on the pipes.
- Do not use any refrigerant other than R410A.
 - Using other refrigerant except R410A (R22 etc.) may degrade inside refrigeration oil. And air getting into refrigeration circuit may cause over-pressure and resultant it may result in bursting, etc.
- Store the copper pipes indoors and seal the both end of them until they are brazed in order to avoid any dust, dirt or water getting into pipe. Otherwise it will cause degradation of refrigeration oil and compressor breakdown, etc.
- Use special tools for R410A refrigerant.

Work procedure

- Remove the flare nut and blind flanges on the pipe of the indoor unit.
 - ※Make sure to loosen the flare nut with holding the nut on pipe side with a spanner and giving torque to the nut with another spanner in order to avoid unexpected stress to the copper pipe, and then remove them. (Gas may come out at this time, but it is not abnormal.)
 - Pay attention whether the flare nut pops out. (as the indoor unit is sometimes pressured.)
- Make a flare on liquid pipe and gas pipe, and connect the refrigeration pipes on the indoor unit.
 - When taking out the pipe to rear or top, install it together with the electric wire^③, passing them through the attached cover.
 - Seal clearances with putty, etc. to shut off dust.
 - ※Bend the pipe with as big radius as possible and do not bend the pipe repeatedly. In addition, do not twist and crush the pipes.
 - ※Do a flare connection as follows:
 - Make sure to loosen the flare nut with holding the nut on pipe side with a spanner and giving torque to the nut with another spanner in order to avoid unexpected stress to the copper pipe, and then remove them.
 - When fastening the flare nut, align the refrigeration pipe with the center of flare nut, screw the nut for 3-4 times by hand and then tighten it by spanner with the specified torque mentioned in the table below. Make sure to hold the pipe on the indoor unit securely by a spanner when tightening the nut in order to avoid unexpected stress on the copper pipe.
- Cover the flare connection part of the indoor unit with attached insulation material after a gas leakage inspection, and tighten both ends with attached straps.
 - Make sure to insulate both gas pipes and liquid pipes completely.
 - ※Incomplete insulation may cause dew condensation or water dropping.
- Refrigerant is charged in the outdoor unit.

As for the additional refrigerant charge for the indoor unit and piping, refer to the installation manual attached to the outdoor unit.

Pipe diameter	Tightening torque N·m
φ 6.35	14 to 18
φ 9.52	34 to 42
φ 12.7	49 to 61
φ 15.88	68 to 82
φ 19.05	100 to 120

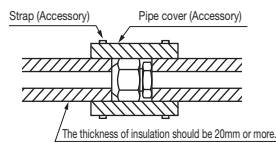

6 Refrigerant pipe (continued)

The pipe can be connected from three different directions. (back, right, top)

- When the pipe is routed through the back.
 - If the bracket is removed, piping work will become easy.
 - ※After piping, reinstall the removed bracket.

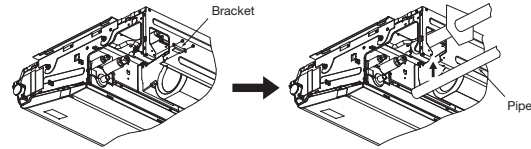

- When the pipe is routed through the back.
 - Cut the removed top cover, and install to the rear panel instead of rear cover.

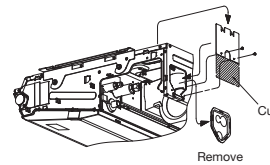

7 Drain pipe

The drain pipes may face out towards the back to the left, or to the right side.

Caution

- Install the drain pipe according to the installation manual in order to drain properly. Imperfection in draining may cause flood indoors and wetting the household goods, etc.
- Do not put the drain pipe directly into the ditch where toxic gas such as sulfur, the other harmful and inflammable gas is generated. Toxic gas would flow into the room and it would cause serious damage to user's health and safety (some poisoning or deficiency of oxygen). In addition, it may cause corrosion of heat exchanger and bad smell.
- Connect the pipe securely to avoid water leakage from the joint.
- Insulate the pipe properly to avoid condensation drop.
- Check if the water can flow out properly from both the drain outlet on the indoor unit and the end of the drain pipe after installation.
- Make sure to make descending slope of greater than 1/100 and do not make up-down bend and/or trap in the midway. In addition, do not put air vent on the drain pipe. Check if water is drained out properly from the pipe during commissioning. Also, keep sufficient space for inspection and maintenance.

Work procedure

- Insert drain hose completely to the base, and tighten the drain hose clamp securely. (adhesive must not be used.)
 - ※When plumbing on the left side, move the rubber plug and the cylindrical insulating materials by the pipe connecting hole on the left side of the unit to the right side.
- Beware of a possible outflow of water that may occur upon removal of a drain plug.
- Fix the drain hose at the lowest point with a hose clamp supplied as an accessory.
 - Give a drain hose a gradient of 10mm as illustrated in the right drawing by laying it without leaving a slack.
 - Take head of electrical cables so that they may not run beneath the drain hose.
- A drain hose must be clamped down with a hose clamp.
 - There is a possibility that drain water overflows.
- Connect VP-20 (prepare on site) to drain hose. (adhesive must not be used.)
 - Use commercially available rigid PVC general pipe VP-20 for drain pipe.
- Do not make the up-down bending and trap in the mid-way while assuming that the drain pipes is downhill. (more than 1/100)
 - Never set up air vent.
- Insulate the drain pipe.
 - Insulate the drain hose clamp with the heat insulation supplied as accessories.
 - When the unit is installed in a humid place, consider precautions against dew condensation such as heat insulation for the drain pipe.

Drain test

- After installation of drain pipe, make sure that drain system work in good condition and no water leakage from joint and drain pan.
- Do drain test even if installation of heating season.

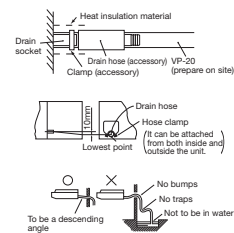

⑧ Wiring-out position and wiring connection

- Electrical installation work must be performed according to the installation manual by an electrical installation service provider qualified by a power provider of the country, and be executed according to the technical standards and other regulations applicable to electrical installation in the country.
Be sure to use an exclusive circuit.
- Use specified cord, fasten the wiring to the terminal securely, and hold the cord securely in order not to apply unexpected stress on the terminal.
- Do not put both power source line and signal line on the same route. It may cause miscommunication and malfunction.
- Be sure to do D type earth work.
- For the details of electrical wiring work, see attached instruction manual for electrical wiring work.

- Remove a lid of the electrical box (2 screws).
- Hold each wiring inside the unit and connect to a terminal block surely.
- Fix the wiring by clamps.
- Install the removed parts back to original place.

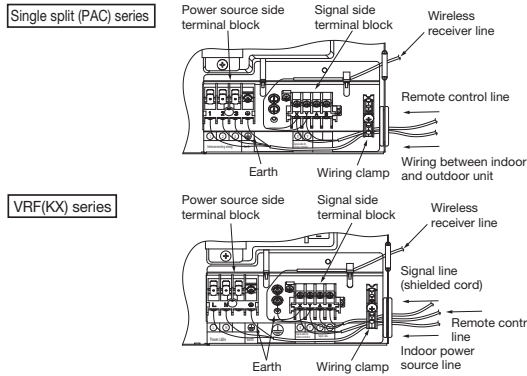

⑨ Attaching the air return grille

- The air return grille must be attached when electrical cabling work is completed.

- Fix the chains tied to the air return grille onto the indoor unit with screws supplied as accessories (4 pieces).
- Close the air return grille. This completes the unit installation work.

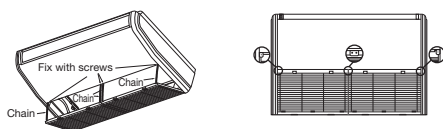

⑩ Check list after installation

- Check the following items after all installation work completed.

Check if	Expected trouble	Check
The indoor and outdoor units are fixed securely?	Falling, vibration, noise	
Inspection for leakage is done?	Insufficient capacity	
Insulation work is properly done?	Water leakage	
Water is drained properly?	Water leakage	
Supply voltage is same as mentioned in the model name plate?	PCB burnt out, not working at all	
There is mis-wiring or mis-connection of piping?	PCB burnt out, not working at all	
Earth wiring is connected properly?	Electric shock	
Cable size comply with specified size?	PCB burnt out, not working at all	
Any obstacle blocks airflow on air inlet and outlet?	Insufficient capacity	

⑪ How to set the airflow direction

It is possible to change the movable range of the louver on the air outlet from the wired remote control. Once the top and bottom position is set, the louver will swing within the range between the top and the bottom when swing operation is chosen. It is also possible to apply different setting to each louver. Note: This function is not able to be set with wireless remote control or simple remote control (RCH-H3).

- Stop the air conditioner and press **SET** button and **LOUVER** button simultaneously for three seconds or more.
 - The following is displayed if the number of the indoor units connected to the remote control is one. Go to step 4.
 - The following is displayed if the number of the indoor units connected to the remote control are more than one.

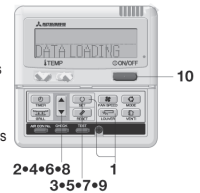

- Press **▲** or **▼** button. (selection of indoor unit) ● Select the indoor unit of which the louver is set.

[EXAMPLE]
 -L/0000 ▲
 -L/0003 ▲

- Press **SET** button. (determination of indoor unit) ● Selected indoor unit is fixed.

[EXAMPLE]
 -L/0001 * (displayed for two seconds)
 "DATA LOADING"
 -> No.1 ▲

- Press **▲** or **▼** button. (selection of louver No.) ● Select the louver No. to be set according to the right figure.

[EXAMPLE]
 -> No.1
 -> No.2
 -> No.3
 -> No.4 ▼

- Press **SET** button. (Determination of louver No.) ● The louver No. to be set is confirmed and the display shows the upper limit of the movable range.

[EXAMPLE] If No.1 louver is selected,
 No.1 UPPER2 ▲ (current upper limit position)

- Press **▲** or **▼** button. (selection of upper limit position) ● Select the upper limit of louver movable range. "position 1" is the most horizontal, and "position 6" is the most downward. "position --" is to return to the factory setting. If you need to change the setting to the default setting, use "position --".

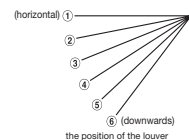

- Press **SET** button. (Fixing of the upper limit position) ● The upper limit position is fixed and the setting position is displayed for two seconds. Then proceed to lower limit position selection display.

[EXAMPLE]
 No.1 UPPER2 (displayed for two seconds)
 No.1 LOWER5 ● (shows current setting)

- Press **▲** or **▼** button. (Selection of lower limit position) ● Select the lower limit position of louver. "position 1" is the most horizontal, and "position 6" is the most downwards. "position --" is to return to the factory setting. If you need to change the setting to the default setting, use "position --".

No.1 LOWER1 ▼ (the most horizontal)
 No.1 LOWER2 ●
 No.1 LOWER3 ●
 No.1 LOWER4 ●
 No.1 LOWER5 ●
 No.1 LOWER6 ● (the most downwards)
 No.1 LOWER-- ▲ (return to the default setting)

- Press **SET** button. (Fixing of the lower limit position) ● Upper limit position and lower limit position are fixed, and the set positions are displayed for two seconds, then setting is completed.

After the setting is completed, the louver which was set moves from the original position to the lower limit position, and goes back to the original position again. (This operation is not performed if the indoor unit and/or indoor unit fan is in operation.)

[Example]
 No.1 L2 L6 (displayed for two seconds)
 SET COMPLETE
 -> No.1 ▲

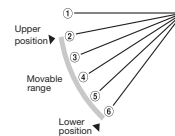

- Press **ON/OFF** button. ● Louver adjusting mode ends and returns to the original display.

Caution
 If the upper limit position number and the lower limit position number are set to the same position, the louver is fixed at that position auto swing does not function.

ATTENTION
 If you press **RESET** button during settings, the display will return to previous display. If you press **ON/OFF** button during settings, the mode will be ended and return to original display, and the settings that have not been completed will become invalid.

When plural remote controls are connected, louver setting operation cannot be set by slave remote control.

(4) Duct connected-High static pressure type (FDU)

PJG012D004

(a) Indoor unit

Models FDU100-140

This manual is for the installation of an indoor unit.
For electrical wiring work (Indoor), refer to page 255. For remote control installation, refer to page 263. For wireless kit installation, refer to page 523. For electrical wiring work (Outdoor) and refrigerant pipe work installation for outdoor unit, refer to page 277.

SAFETY PRECAUTIONS

- Read the "SAFETY PRECAUTIONS" carefully first of all and then strictly follow it during the installation work in order to protect yourself.
- The precautionary items mentioned below are distinguished into two levels, [WARNING] and [CAUTION].
[WARNING]: Wrong installation would cause serious consequences such as injuries or death.
[CAUTION]: Wrong installation might cause serious consequences depending on circumstances. Both mentions the important items to protect your health and safety so strictly follow them by any means.
- The meanings of "Marks" used here are as shown on the right:
⊗ Never do it under any circumstances. ⊕ Always do it according to the instruction.
- After completing the installation, do commissioning to confirm there are no abnormalities, and explain to the customers about "SAFETY PRECAUTIONS", correct operation method and maintenance method (air filter cleaning, operation method and temperature setting method) with user's manual of this unit. Ask your customers to keep this installation manual together with the user's manual. Also, ask them to hand over the user's manual to the new user when the owner is changed.

WARNING

- **Installation should be performed by the specialist.** ⊕
If you install the unit by yourself, it may lead to serious trouble such as water leakage, electric shock, fire, and injury due to overturn of the unit.
- **Install the system correctly according to these installation manuals.** ⊕
Improper installation may cause explosion, injury, water leakage, electric shock, and fire.
- **Check the density referred by the formula (accordance with ISO5149).** ⊕
If the density exceeds the limit density, please consult the dealer and installate the ventilation system.
- **Use the genuine accessories and the specified parts for installation.** ⊕
If parts unspecified by our company are used it could cause water leakage, electric shock, fire, and injury due to overturn of the unit.
- **Ventilate the working area well in case the refrigerant leaks during installation.** ⊕
If the refrigerant contacts the fire, toxic gas is produced.
- **Install the unit in a location that can hold heavy weight.** ⊕
Improper installation may cause the unit to fall leading to accidents.
- **Install the unit properly in order to be able to withstand strong winds such as typhoons, and earthquakes.** ⊕
Improper installation may cause the unit to fall leading to accidents.
- ⊗ **Do not mix air in to the cooling cycle on installation or removal of the air conditioner.** ⊕
If air is mixed in, the pressure in the cooling cycle will rise abnormally and may cause explosion and injuries.
- **Be sure to have the electrical wiring work done by qualified electrical installer, and use exclusive circuit.** ⊕
Power source with insufficient capacity and improper work can cause electric shock and fire.
- **Use specified wire for electrical wiring, fasten the wiring to the terminal securely, and hold the cable securely in order not to apply unexpected stress on the terminal.** ⊕
Loose connections or hold could result in abnormal heat generation or fire.
- **Arrange the electrical wires in the control box properly to prevent them from rising. Fit the lid of the services panel properly.** ⊕
Improper fitting may cause abnormal heat and fire.
- **Check for refrigerant gas leakage after installation is completed.** ⊕
If the refrigerant gas leaks into the house and comes in contact with a fan heater, a stove, or an oven, toxic gas is produced.
- **Use the specified pipe, flare nut, and tools for R410A.** ⊕
Using existing parts (R22) could cause the unit failure and serious accident due to explosion of the cooling cycle.
- **Tighten the flare nut according to the specified method by with torque wrench.** ⊕
If the flare nut were tightened with excess torque, it could cause burst and refrigerant leakage after a long period.
- ⊗ **Do not put the drainage pipe directly into drainage channels where poisonous gases such as sulfide gas can occur.** ⊕
Poisonous gases will flow into the room through drainage pipe and seriously affect the user's health and safety. This can also cause the corrosion of the indoor unit and a resultant unit failure or refrigerant leak.
- **Connect the pipes for refrigeration circuit securely in installation work before compressor is operated.** ⊕
If the compressor is operated when the service valve is open without connecting the pipes, it could cause explosion and injuries due to abnormal high pressure in the system.
- **Stop the compressor before removing the pipe after shutting the service valve on pump down work.** ⊕
If the pipe is removed when the compressor is in operation with the service valve open, air would be mixed in the refrigeration circuit and it could cause explosion and injuries due to abnormal high pressure in the cooling cycle.
- **Only use prescribed optional parts. The installation must be carried out by the qualified installer.** ⊕
If you install the system by yourself, it can cause serious trouble such as water leaks, electric shocks, fire.
- ⊗ **Do not repair by yourself. And consult with the dealer about repair.** ⊕
Improper repair may cause water leakage, electric shock or fire.
- **Consult the dealer or a specialist about removal of the air conditioner.** ⊕
Improper installation may cause water leakage, electric shock or fire.
- **Turn off the power source during servicing or inspection work.** ⊕
If the power is supplied during servicing or inspection work, it could cause electric shock and injury by the operating fan.
- ⊗ **Do not run the unit when the panel or protection guard are taken off.** ⊕
Touching the rotating equipment, hot surface, or high voltage section could cause an injury to be caught in the machine, to get burned, or electric shock.
- **Shut off the power before electrical wiring work.** ⊕
It could cause electric shock, unit failure and improper running.

CAUTION

- **Perform earth wiring surely.** ⊕
Do not connect the earth wiring to the gas pipe, water pipe, lightning rod and telephone earth wiring. Improper earth could cause unit failure and electric shock or fire due to a short circuit.
- **Earth leakage breaker must be installed.** ⊕
If the earth leakage breaker is not installed, it could cause electric shocks or fire.
- **Use the circuit breaker of correct capacity. Circuit breaker should be the one that disconnect all poles under over current.** ⊕
Using the incorrect one could cause the system failure and fire.
- ⊗ **Do not use any materials other than a fuse of correct capacity where a fuse should be used.** ⊕
Connecting the circuit by wire or copper wire could cause unit failure and fire.
- ⊗ **Do not install the indoor unit near the location where there is possibility of flammable gas leakages.** ⊕
If the gas leaks and gathers around the unit, it could cause fire.
- ⊗ **Do not install and use the unit where corrosive gas (such as sulfurous acid gas etc.) or flammable gas (such as thinner, petroleum etc.) may be generated or accumulated, or volatile flammable substances are handled.** ⊕
It could cause the corrosion of heat exchanger, breakage of plastic parts etc. And inflammable gas could cause fire.
- **Secure a space for installation, inspection and maintenance specified in the manual.** ⊕
Insufficient space can result in accident such as personal injury due to falling from the installation place.
- ⊗ **Do not use the indoor unit at the place where water splashes such as laundry.** ⊕
Indoor unit is not waterproof. It could cause electric shock and fire.
- ⊗ **Do not use the indoor unit for a special purpose such as food storage, cooling for precision instrument, preservation of animals, plants, and a work of art.** ⊕
It could cause the damage of the items.
- ⊗ **Do not install nor use the system near equipments which generate electromagnetic wave or high harmonics.** ⊕
Equipments like inverter equipment, private power generator, high-frequency medical equipment, or telecommunication equipment might influence the air conditioner and cause a malfunction and breakdown. Or the air conditioner might influence medical equipments or telecommunication equipments, and obstruct their medical activity or cause jamming.
- ⊗ **Do not install the remote control at the direct sunlight.** ⊕
It could cause breakdown or deformation of the remote control.
- ⊗ **Do not install the indoor unit at the place listed below.** ⊕
Places where flammable gas could leak. Places where carbon fiber, metal powder or any powder is floated. Places where the substances which affect the air conditioner are generated such as sulfide gas, chlorine gas, acid, alkali or ammoniac atmospheres. On vehicles and ships. Places where machinery which generates high harmonics is used. Places where cosmetics or special sprays are frequently used. Highly salted area such as beach. Heavy snow area. Places where the system is affected by smoke from a chimney. Altitude over 1000m.
- ⊗ **Do not install the indoor unit in the locations listed below (Be sure to install the indoor unit according to the installation manual for each model because each indoor unit has each limitation)** ⊕
Locations with any obstacles which can prevent inlet and outlet air of the unit. Locations where vibration can be amplified due to insufficient strength of structure. Locations where the infrared receiver is exposed to the direct sunlight or the strong light beam. (in case of the infrared specification unit) Locations where an equipment affected by high harmonics is placed. (TV set or radio receiver is placed within 5m) Locations where drainage cannot run off safely. It can affect performance or function and etc.
- ⊗ **Do not put any valuables which will break down by getting wet under the air conditioner.** ⊕
Condensation could drop when the relative humidity is higher than 80% or drain pipe is clogged, and it damages user's belongings.
- ⊗ **Do not use the base frame for the outdoor unit which is corroded or damaged after a long period of use.** ⊕
It could cause the unit falling down and injury.
- **Pay attention not to damage the drain pan by weld sputter when brazing work is done near the unit.** ⊕
If sputter entered into the unit during brazing work, it could cause damage (pinhole) of drain pan and leakage of water. To avoid damaging, keep the indoor unit packed or cover the indoor unit.
- **Install the drain pipe to drain the water surely according to the installation manual.** ⊕
Improper connection of the drain pipe may cause dropping water into room and damaging user's belongings.
- ⊗ **Do not share the drain pipe for indoor unit and GHP (Gas Heat Pump system) outdoor unit.** ⊕
Toxic exhaust gas would flow into room and it might cause serious damage (some poisoning or deficiency of oxygen) to user's health and safety.
- **Be sure to perform air tightness test by pressurizing with nitrogen gas after completed refrigerant piping work.** ⊕
If the density of refrigerant exceeds the limit in the event of refrigerant leakage in the small room, lack of oxygen can occur, which can cause serious accidents.
- **For drain pipe installation, be sure to make descending slope of greater than 1/100, not to make traps, and not to make air-bleeding.** ⊕
Check if the drainage is correctly done during commissioning and ensure the space for inspection and maintenance.
- **Ensure the insulation on the pipes for refrigeration circuit so as not to condense water.** ⊕
Incomplete insulation could cause condensation and it would wet ceiling, floor, and any other valuables.
- ⊗ **Do not install the outdoor unit where is likely to be a nest for insects and small animals.** ⊕
Insects and small animals could come into the electronic components and cause breakdown and fire. Instruct the user to keep the surroundings clean.
- **Pay extra attention, carrying the unit by hand.** ⊕
Carry the unit with 2 people if it is heavier than 20kg. Do not use the plastic straps but the grabbing place, moving the unit by hand. Use protective gloves in order to avoid injury by the aluminum fin.
- **Make sure to dispose of the packaging material.** ⊕
Leaving the materials may cause injury as metals like nail and woods are used in the package.
- ⊗ **Do not operate the system without the air filter.** ⊕
It may cause the breakdown of the system due to clogging of the heat exchanger.
- ⊗ **Do not touch any button with wet hands.** ⊕
It could cause electric shock.
- ⊗ **Do not touch the refrigerant piping with bare hands when in operation.** ⊕
The pipe during operation would become very hot or cold according to the operating condition, and it could cause a burn or frostbite.
- ⊗ **Do not clean up the air conditioner with water.** ⊕
It could cause electric shock.
- ⊗ **Do not turn off the power source immediately after stopping the operation.** ⊕
Be sure to wait for more than 5 minutes. Otherwise it could cause water leakage or breakdown.
- ⊗ **Do not control the operation with the circuit breaker.** ⊕
It could cause fire or water leakage. In addition, the fan may start operation unexpectedly and it may cause injury.

○ This model is middle static ducted type air conditioning unit. Therefore, do not use this model for direct blow type air conditioning unit.

① Before installation

● Install correctly according to the installation manual.

● Confirm the following points:

- Unit type/Power supply specification
- Pipes/Wires/Small parts
- Accessory items

Accessory item

For hanging		For refrigerant pipe			For drain pipe			
Flat washer (M10)	Pipe cover (big)	Pipe cover (small)	Strap	Pipe cover (big)	Pipe cover (small)	Drain hose	Hose clamp	
8	1	1	4	1	1	1	1	
For unit hanging	For heat insulation of gas pipe	For heat insulation of liquid tube	For pipe cover fitting	For heat insulation of drain socket	For heat insulation of drain socket	For drain pipe connecting	For drain hose mounting	

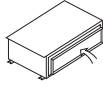

Accessory parts are stored inside this suction side.

② Selection of installation location for the indoor unit

① Select the suitable areas to install the unit under approval of the user.

- Areas where the indoor unit can deliver hot and cold wind sufficiently. Suggest to the user to use a circulator if the ceiling height is over 3m to avoid warm air being accumulated on the ceiling.
- Areas where there is enough space to install and service.
- Areas where it can be drained properly. Areas where drain pipe descending slope can be taken.
- Areas where there is no obstruction of airflow on both air return grille and air supply port.
- Areas where fire alarm will not be accidentally activated by the air conditioner.
- Areas where the supply air does not short-circuit.
- Areas where it is not influenced by draft air.
- Areas not exposed to direct sunlight.
- Areas where dew point is lower than around 28°C and relative humidity is lower than 80%.

This indoor unit is tested under the condition of JIS (Japan Industrial Standard) high humidity condition and confirmed there is no problem. However, there is some risk of condensation drop if the air conditioner is operated under the severer condition than mentioned above.

If there is a possibility to use it under such a condition, attach additional insulation of 10 to 20mm thick for entire surface of indoor unit, refrigeration pipe and drain pipe.

- Areas where TV and radio stays away more than 1m. (It could cause jamming and noise.)
- Areas where any items which will be damaged by getting wet are not placed such as food, table wares, server, or medical equipment under the unit.
- Areas where there is no influence by the heat which cookware generates.
- Areas where not exposed to oil mist, powder and/or steam directly such as above fryer.
- Areas where lighting device such as fluorescent light or incandescent light doesn't affect the operation.

(A beam from lighting device sometimes affects the infrared receiver for the wireless remote control and the air conditioner might not work properly.)

② Check if the place where the air conditioner is installed can hold the weight of the unit. If it is not able to hold, reinforce the structure with boards and beams strong enough to hold it. If the strength is not enough, it could cause injury due to unit falling.

Space for installation and service

● Make installation altitude over 2.5m.

(Indoor Unit)

Select either of two cases to keep space for installation and services.

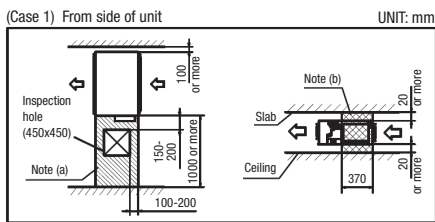

- Notes (a) There must not be obstacle to draw out fan motor. (hatched marked area)
 (b) Install refrigerant pipe, drain pipe, and wiring so as not to cross (cross-hatched marked area).

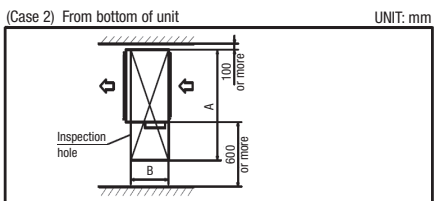

(Size of inspection hole)		UNIT: mm	
Single type	-	71	100-140
Multi type	45, 56	71, 90	112-160
A	1100	1300	1720
B	620	725	

③ Preparation before installation

● If suspension bolt becomes longer, do reinforcement of earthquake resistant.

○ For grid ceiling

When the suspension bolt length is over 500mm, or the gap between the ceiling and roof is over 700mm, apply earthquake resistant brace to the bolt.

○ In case the unit is hanged directly from the slab and is installed on the ceiling plane which has enough strength.

When suspension bolt length is over 1000mm, apply the earthquake resistant brace to the bolt.

● Prepare four (4) sets of suspension bolt, nut and spring washer (M10) on site.

Suspension Bolt Location

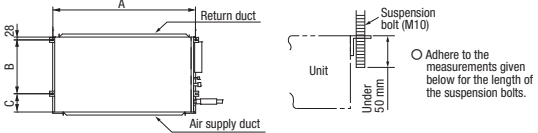

○ Adhere to the measurements given below for the length of the suspension bolts.

UNIT: mm			
Single type	-	71	100-140
Multi type	45, 56	71, 90	112-160
A	786	986	1404
B	472	472	530
C	135	135	180

Pipe locations

UNIT: mm	
Single type	71
Multi type	45-90

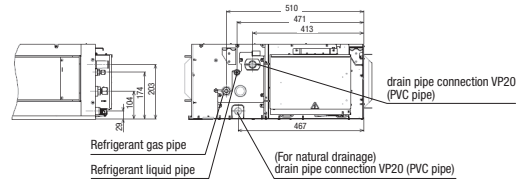

UNIT: mm	
Single type	100-140
Multi type	112-160

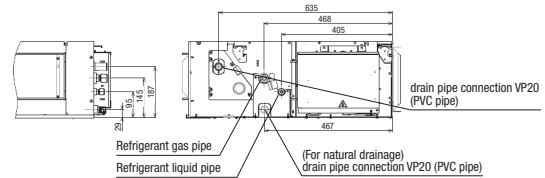

④ Installation of indoor unit

Installation

[Hanging]
Hang the unit up.

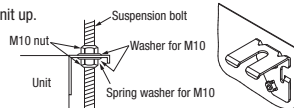

If the measurements between the unit and the ceiling hole do not match upon installation, it may be adjusted with the long holed installation tool.

Adjustment for horizontality

○ Either use a level vial, or adjust the level according to the method below.

● Adjust so the bottom side of the unit will be leveled with the water surface as illustrated below.

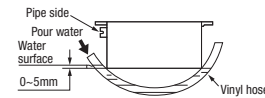

Let the pipe side be slightly sloped.

○ If the unit is not leveled, it may cause malfunctions or inoperation of the float switch.

⑤ Duct Work

- ① A corrugated board (for preventing sputtering) is attached to the main body of the air conditioner (on the outlet port). Do not remove it until connecting the duct.
- An air filter can be provided on the main body of the air conditioner (on the inlet port). Remove it when connecting the duct on the inlet port.

② Blowout duct

- Use rectangular duct to connect with unit.
- Duct size for each unit is as shown below.

	UNIT: mm		
Single type	—	71	100-140
Multi type	45, 56	71, 90	112-140
A	682	882	1202
B	172	172	172

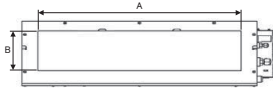

- Duct should be at their minimum length.
- We recommend to use sound and heat insulated duct to prevent it from condensation.
- Connect duct to unit before ceiling attachment.

③ Inlet port

- When connecting the duct to the inlet port, remove the air filter if it is fitted to the inlet port.
- Inlet port size for each unit is as shown below.

	UNIT: mm		
Single type	—	71	100-140
Multi Type	45, 56	71, 90	112-160
A	582	742	1282
B	202	202	237

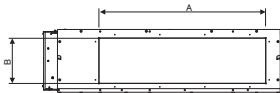

- Make sure to insulate the duct to prevent dewing on it.

④ Install the specific blowout duct in a location where the air will circulate to the entire room.

- Conduct the installation of the specific blowout hole and the connection of the duct before attaching them to the ceiling.
- Insulate the area where the duct is secured by a band for dew condensation prevention.

⑤ Make sure provide an inspection hole on the ceiling. It is indispensable to service electric equipment, motor, functional components and cleaning of heat exchanger.

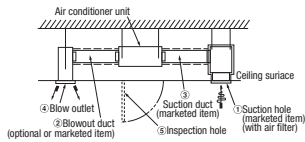
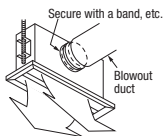

Bad example of duct work

- ① If a duct is not provided at the suction side but it is substituted with the space over the ceiling, humidity in the space will increase by the influence of capacity of ventilation fan, strength of wind blowing against the out door air louver, weather (rainy day) and others.
 - a) Moisture in air is likely to condense over the external plates of the unit and to drip on the ceiling. Unit should be operated under the conditions as listed in the above table and within the limitation of wind volume. When the building is a concrete structure, especially immediately after the construction, humidity tends to rise even if the space over the ceiling is not substituted in place of a duct. In such occasion, it is necessary to insulate the entire unit with glass wool (25mm). (Use a wire net or equivalent to hold the glass wool in place.)
 - b) It may run out the allowable limit of unit operation (Example: When outdoor air temperature is 35°C DB, suction air temperature is 27°C WB) and it could result in such troubles as compressor overload, etc..
 - c) There is a possibility that the blow air volume may exceed the allowable range of operation due to the capacity of ventilation fan or strength of wind blowing against external air louver so that drainage from be heat exchanger may fall to reach the drain pan but leak outside (Example: drip on to the ceiling) with consequential water leakage in the room.
- ② If vibration damping is not conducted between the unit and the duct, and between the unit and the slab, vibration will be transmitted to the duct and vibration noise may occur. Also, vibration may be transmitted from the unit to the slab. Vibration damping must be performed.

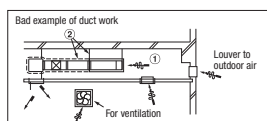

⑤ Duct Work (continued)

Connecting the air intake/vent ducts

① Fresh Air Intake

- [for air intake duct only]
- Use the side fresh air intake hole, or supply through a part of the suction duct.

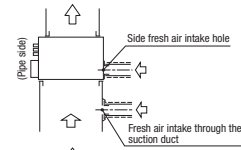

[for simultaneous air intake/vent]

- Intake air through the suction duct. (the side cannot be used)

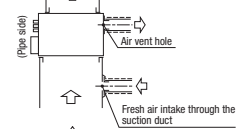

② Air Vent

- Use the side air vent hole. (always use together with the air intake)

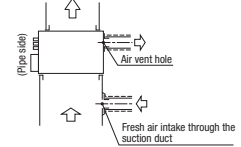

- Insulate the duct to protect it from dew condensation.

⑥ Refrigerant pipe

Caution

- Use the new refrigerant pipe.
 - When re-using the existing pipe system for R22 or R407C, pay attention to the following items.
 - Change the flare nuts with the attached ones (JIS category 2), and reprocess the flare parts.
 - Do not use thin-walled pipes.
- Use phosphorus deoxidized copper alloy seamless pipe (C1220T specified in JIS H3300) for refrigeration pipe installation. In addition, make sure there is no damage both inside and outside of the pipe, and no harmful substances such as sulfur, oxide, dust or a contaminant stuck on the pipes.
- Do not use any refrigerant other than R410A.
 - Using other refrigerant except R410A (R22 etc.) may degrade inside refrigeration oil. And air getting into refrigeration circuit may cause over-pressure and resultant it may result in bursting, etc.
- Store the copper pipes indoors and seal the both end of them until they are brazed in order to avoid any dust, dirt or water getting into pipe. Otherwise it will cause degradation of refrigeration oil and compressor breakdown, etc.
- Use special tools for R410A refrigerant.

Piping work

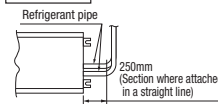

When conducting piping work, make sure to allow the pipes to be aligned in a straight line for at least 250 mm, as shown in the left illustration. (This is necessary for the drain pump to function)

Work procedure

- Remove the flare nut and blind flanges on the pipe of the indoor unit.
 - ※ Make sure to loosen the flare nut with holding the nut on pipe side with a spanner and giving torque to the nut with another spanner in order to avoid unexpected stress to the copper pipe, and then remove them. (Gas may come out at this time, but it is not abnormal.)
 - Pay attention whether the flare nut pops out. (as the indoor unit is sometimes pressured.)
- Make a flare on liquid pipe and gas pipe, and connect the refrigeration pipes on the indoor unit.
 - ※ Bend the pipe with as big radius as possible and do not bend the pipe repeatedly. In addition, do not twist and crush the pipes.
 - ※ Do a flare connection as follows:
 - Make sure to loosen the flare nut with holding the nut on pipe side with a spanner and giving torque to the nut with another spanner in order to avoid unexpected stress to the copper pipe, and then remove them.
 - When fastening the flare nut, align the refrigeration pipe with the center of flare nut, screw the nut for 3-4 times by hand and then tighten it by spanner with the specified torque mentioned in the table below. Make sure to hold the pipe on the indoor unit securely by a spanner when tightening the nut in order to avoid unexpected stress on the copper pipe.
- Cover the flare connection part of the indoor unit with attached insulation material after a gas leakage inspection, and tighten both ends with attached straps.
 - Make sure to insulate both gas pipes and liquid pipes completely.
 - ※ Incomplete insulation may cause dew condensation or water dropping.
- Refrigerant is charged in the outdoor unit.
 - As for the additional refrigerant charge for the indoor unit and piping, refer to the installation manual attached to the outdoor unit.

Pipe diameter	Tightening torque N·m
φ 6.35	14 to 18
φ 9.52	34 to 42
φ 12.7	49 to 61
φ 15.88	68 to 82

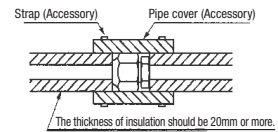

⑦ Drain pipe

Caution

- Install the drain pipe according to the installation manual in order to drain properly. Imperfection in draining may cause flood indoors and wetting the household goods, etc.
- Do not put the drain pipe directly into the ditch where toxic gas such as sulfur, the other harmful and inflammable gas is generated. Toxic gas would flow into the room and it would cause serious damage to user's health and safety (some poisoning or deficiency of oxygen). In addition, it may cause corrosion of heat exchanger and bad smell.
- Connect the pipe securely to avoid water leakage from the joint.
- Insulate the pipe properly to avoid condensation drop.
- Check if the water can flow out properly from both the drain outlet on the indoor unit and the end of the drain pipe after installation.
- Make sure to make descending slope of greater than 1/100 and do not make up-down bend and/or trap in the midway. In addition, do not put air vent on the drain pipe. Check if water is drained out properly from the pipe during commissioning. Also, keep sufficient space for inspection and maintenance.

Work procedure

1. Make sure to insert the drain hose (the end made of soft PVC) to the end of the step part of drain socket.
Attach the hose clamp to the drain hose around 10mm from the end, and fasten the screw within 5mm left to the nut.
 - Do not apply adhesives on this end.
 - Do not use acetone-based adhesives to connect to the drain socket.

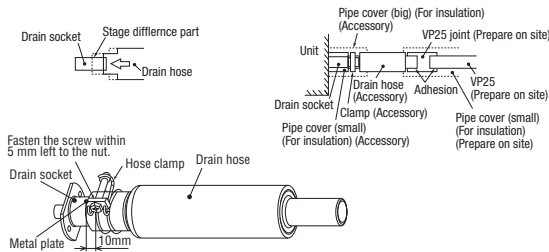

2. Prepare a joint for connecting VP-25 pipe, adhere and connect the joint to the drain hose (the end made of rigid PVC), and adhere and connect VP-25 pipe (prepare on site).
 - ※As for drain pipe, apply VP-25 made of rigid PVC which is on the market.
 - Make sure that the adhesive will not get into the supplied drain hose. It may cause the flexible part broken after the adhesive is dried up and gets rigid.
 - The flexible drain hose is intended to absorb a small difference at installation of the unit or drain pipes. Intentional bending, expanding may cause the flexible hose broken and water leakage.

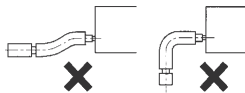

3. Make sure to make descending slope of greater than 1/100 and do not make up-down bend and/or trap in the midway.
 - Pay attention not to give stress on the pipe on the indoor unit side, and support and fix the pipe as close place to the unit as possible when connecting the drain pipe.
 - Do not set up air vent.

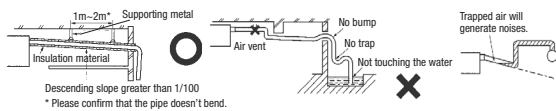

- When sharing a drain pipe for more than one unit, lay the main pipe 100mm below the drain outlet of the unit. In addition, select VP-30 or bigger size for main drain pipe.

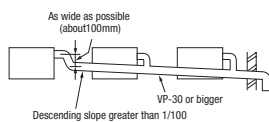

4. Insulate the drain pipe.

- Be sure to insulate the drain socket and rigid PVC pipe installed indoors otherwise it may cause dew condensation and water leakage.
 - ※After drainage test implementation, cover the drain socket part with pipe cover (small size), then use the pipe cover (big size) to cover the pipe cover (small size), clamps and part of the drain hose, and fix and wrap it with tapes to wrap and make joint part gapless.

⑦ Drain pipe (continued)

Drain up

- The position for drain pipe outlet can be raised up to 600mm above the ceiling. Use elbows for installation to avoid obstacles inside ceiling. If the horizontal drain pipe is too long before vertical pipe, the backflow of water will increase when the unit is stopped, and it may cause overflow of water from the drain pan on the indoor unit. In order to avoid overflow, keep the horizontal pipe length and offset of the pipe within the limit shown in the figure below.

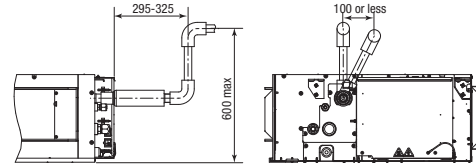

Otherwise, the construction point makes it same as drain pipe construction.

Drain test

1. Conduct a drain test after completion of the electrical work.
2. During the trial, make sure that drain flows properly through the piping and that no water leaks from connections.
3. In case of a new building, conduct the test before it is furnished with the ceiling.
4. Be sure to conduct this test even when the unit is installed in the heating season.

Procedures

1. Supply about 1000 cc of water to the unit through the air outlet by using a feed water pump.
2. Check the drain while cooling operation.

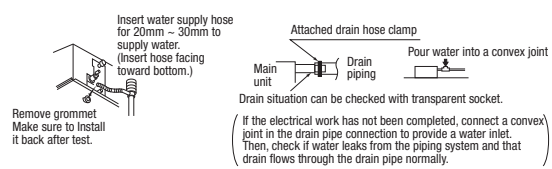

Outline of bottom drain piping work

- If the bottom drain piping can be done with a descending gradient (1/50-1/100), it is possible to connect the pipes as shown in the drawing below.

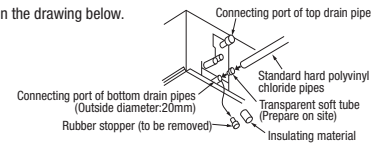

Uncoupling the drain motor connector

- Uncouple the connector CNR for the drain motor as illustrated in the drawing on the right.

(Note: If the unit is run with the connector coupled, drain water will be discharged from the upper drain pipe joint, causing a water leak.)

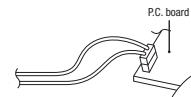

⑧ Wiring-out position and wiring connection

- Electrical installation work must be performed according to the installation manual by an electrical installation service provider qualified by a power provider of the country, and be executed according to the technical standards and other regulations applicable to electrical installation in the country.
Be sure to use an exclusive circuit.
 - Use specified cord, fasten the wiring to the terminal securely, and hold the cord securely in order not to apply unexpected stress on the terminal.
 - Do not put both power source line and signal line on the same route. It may cause miscommunication and malfunction.
 - For the details of electrical wiring work, see attached instruction manual for electrical wiring work.
1. Remove a lid of the control box (2 screws).
 2. Hold each wiring inside the unit and fasten them to terminal block securely.
 3. Fix the wiring with clamps.
 4. Install the removed parts back to original place.

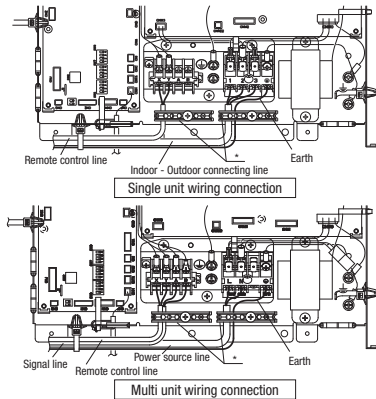

* Please fix the wiring in the band not to move even if it pulls.

⑩ Check list after installation

● Check the following items after all installation work completed.

Check if	Expected trouble	Check
The indoor and outdoor units are fixed securely?	Falling, vibration, noise	
Inspection for leakage is done?	Insufficient capacity	
Insulation work is properly done?	Water leakage	
Water is drained properly?	Water leakage	
Supply voltage is same as mentioned in the model name plate?	PCB burnt out, not working at all	
No mis-wiring or mis-connection of piping?	PCB burnt out, not working at all	
Earth wiring is connected properly?	Electric shock	
Cable size comply with specified size?	PCB burnt out, not working at all	
Any obstacle blocks airflow on air inlet and outlet?	Insufficient capacity	
Is setting of E.S.P finished?	Excessive air flow, water drop blow out	

⑨ External static pressure setting

You can set External Static Pressure (E.S.P) by method of MANUAL SETTING on remote control. Indoor unit will control fan-speed to keep rated air flow volume at each fan speed setting (Lo-Uhi). You can set required E.S.P by wired remote control that calculated with the set air flow rate and pressure loss of the duct connected.

- How to set E.S.P by wired remote control
 - ① Push "◆" marked button (E.S.P button).
 - ② Select indoor unit No. by using ◀▶ button.
 - ③ Select setting No. by using ◀▶ button and set E.S.P. by ◀▶ button.
 See detailed procedure in technical manual.

Notice

You can NOT set E.S.P by wireless remote control.

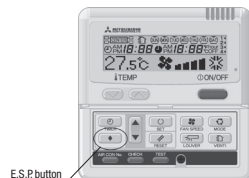

With E.S.P setting, confirm that actual E.S.P agrees with E.S.P setting. When E.S.P setting is higher than actual E.S.P, the airflow rate becomes excessively higher. This will cause water leakage if water splashes. When E.S.P setting is lower than actual E.S.P, the airflow rate becomes excessively lower and the cooling or heating may become ineffective. In order to reduce the risk above the factory E.S.P setting is set within the range of 80 – 150 Pa (E.S.P setting No. 8 – 15). Be sure to use within the range of 80 – 150 Pa in actual operations. If actual E.S.P is lower than 80 Pa, it may cause water leakage.

Setting No.	8	9	10	11	12	13	14	15
E.S.P (Pa)	80	90	100	110	120	130	140	150

※ If 1 – 7 is selected for the setting No. on the remote control, the setting No. shows No. 8.
If 16 – 20 is selected for the setting No. on the remote control, the setting No. shows No. 15.
Factory default is No. 8.

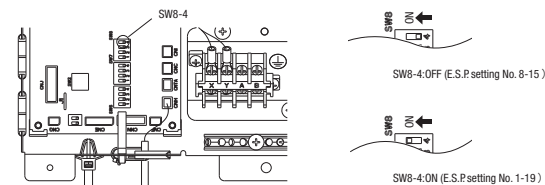

If SWB-4 is turned to "ON", E.S.P setting range can be changed to 10 – 200 Pa (E.S.P setting No. 1 – 19). This should not be used when actual E.S.P cannot be confirmed, because the risk above becomes higher.

Setting No.	1	2	3	4	5	6	7	8	9	10	11	12	13	14	15	16	17	18	19
E.S.P (Pa)	10	20	30	40	50	60	70	80	90	100	110	120	130	140	150	160	170	180	200

※ If 20 is selected for the setting No. on the remote control, the setting No. shows No. 19.

(b) Replacement procedure of the fan unit

- Notes(1) The unit is a heavy item. It must be supported securely and handled with care not to drop when it is necessary to replace.
(2) For the maintenance space, refer to page 227.

- (i) Remove the control box and the side panel, and remove the screws marked in the circles (2 places) from the unit located at the near side.

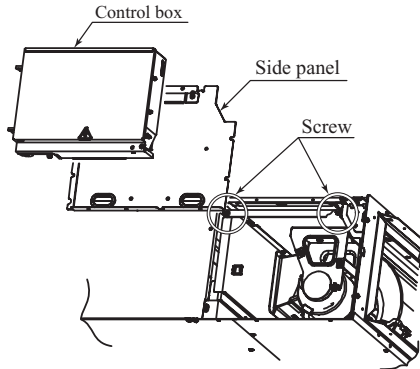

- (ii) Take out the fan unit located at the near side in the arrow direction.

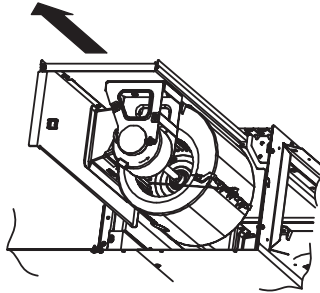

- (iii) Remove the screws marked in the circles (2 places) from the fan unit located at the far side.

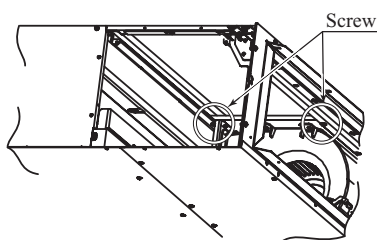

- (iv) Take out the fan unit in the arrow direction.

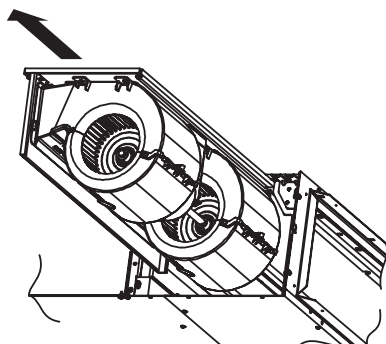

Models FDU200, 250

This manual is for the installation of an indoor unit.
 For electrical wiring work (Indoor), refer to page 251. For remote control installation, refer to page 263. For wireless kit installation, refer to page 523. For electrical wiring work (Outdoor) and refrigerant pipe work installation for outdoor unit, refer to page 277.

SAFETY PRECAUTIONS

- Read the "SAFETY PRECAUTIONS" carefully first of all and then strictly follow it during the installation work in order to protect yourself.
- The precautionary items mentioned below are distinguished into two levels, [WARNING] and [CAUTION].
 [WARNING]: Wrong installation would cause serious consequences such as injuries or death.
 [CAUTION]: Wrong installation might cause serious consequences depending on circumstances.
 Both mentions the important items to protect your health and safety so strictly follow them by any means.
- The meanings of "Marks" used here are as shown on the right:
 [⊘] Never do it under any circumstances. [⚠] Always do it according to the instruction.
- After completing the installation, do commissioning to confirm there are no abnormalities, and explain to the customers about "SAFETY PRECAUTIONS", correct operation method and maintenance method (air filter cleaning, operation method and temperature setting method) with user's manual of this unit.
 Ask your customers to keep this installation manual together with the user's manual. Also, ask them to hand over the user's manual to the new user when the owner is changed.

⚠ WARNING

- **Installation should be performed by the specialist.** [⚠]
 If you install the unit by yourself, it may lead to serious trouble such as water leakage, electric shock, fire, and injury due to overturn of the unit.
- **Install the system correctly according to these installation manuals.** [⚠]
 Improper installation may cause explosion, injury, water leakage, electric shock, and fire.
- **Check the density referred by the formula (accordance with ISO5149).** [⚠]
 If the density exceeds the limit density, please consult the dealer and installate the ventilation system.
- **Use the genuine accessories and the specified parts for installation.** [⚠]
 If parts unspecified by our company are used it could cause water leakage, electric shock, fire, and injury due to overturn of the unit.
- **Ventilate the working area well in case the refrigerant leaks during installation.** [⚠]
 If the refrigerant contacts the fire, toxic gas is produced.
- **Install the unit in a location that can hold heavy weight.** [⚠]
 Improper installation may cause the unit to fall leading to accidents.
- **Install the unit properly in order to be able to withstand strong winds such as typhoons, and earthquakes.** [⚠]
 Improper installation may cause the unit to fall leading to accidents.
- **Do not mix air in to the cooling cycle on installation or removal of the air conditioner.** [⊘]
 If air is mixed in, the pressure in the cooling cycle will rise abnormally and may cause explosion and injuries.
- **Be sure to have the electrical wiring work done by qualified electrical installer, and use exclusive circuit.** [⚠]
 Power source with insufficient capacity and improper work can cause electric shock and fire.
- **Use specified wire for electrical wiring, fasten the wiring to the terminal securely, and hold the cable securely in order not to apply unexpected stress on the terminal.** [⚠]
 Loose connections or hold could result in abnormal heat generation or fire.
- **Arrange the electrical wires in the control box properly to prevent them from rising. Fit the lid of the services panel properly.** [⚠]
 Improper fitting may cause abnormal heat and fire.
- **Check for refrigerant gas leakage after installation is completed.** [⚠]
 If the refrigerant gas leaks into the house and comes in contact with a fan heater, a stove, or an oven, toxic gas is produced.
- **Use the specified pipe, flare nut, and tools for R410A.** [⚠]
 Using existing parts (R22) could cause the unit failure and serious accident due to explosion of the cooling cycle.
- **Tighten the flare nut according to the specified method by with torque wrench.** [⚠]
 If the flare nut were tightened with excess torque, it could cause burst and refrigerant leakage after a long period.
- **Do not put the drainage pipe directly into drainage channels where poisonous gases such as sulfide gas can occur.** [⊘]
 Poisonous gases will flow into the room through drainage pipe and seriously affect the user's health and safety. This can also cause the corrosion of the indoor unit and a resultant unit failure or refrigerant leak.
- **Connect the pipes for refrigeration circuit securely in installation work before compressor is operated.** [⚠]
 If the compressor is operated when the service valve is open without connecting the pipe, it could cause explosion and injuries due to abnormal high pressure in the system.
- **Stop the compressor before removing the pipe after shutting the service valve on pump down work.** [⚠]
 If the pipe is removed when the compressor is in operation with the service valve open, air would be mixed in the refrigeration circuit and it could cause explosion and injuries due to abnormal high pressure in the cooling cycle.
- **Only use prescribed optional parts. The installation must be carried out by the qualified installer.** [⚠]
 If you install the system by yourself, it can cause serious trouble such as water leaks, electric shocks, fire.
- **Do not repair by yourself. And consult with the dealer about repair.** [⊘]
 Improper repair may cause water leakage, electric shock or fire.
- **Consult the dealer or a specialist about removal of the air conditioner.** [⚠]
 Improper installation may cause water leakage, electric shock or fire.
- **Turn off the power source during servicing or inspection work.** [⚠]
 If the power is supplied during servicing or inspection work, it could cause electric shock and injury by the operating fan.
- **Do not run the unit when the panel or protection guard are taken off.** [⊘]
 Touching the rotating equipment, hot surface, or high voltage section could cause an injury to be caught in the machine, to get burned, or electric shock.
- **Shut off the power before electrical wiring work.** [⚠]
 It could cause electric shock, unit failure and improper running.

⚠ CAUTION

- **Perform earth wiring surely.** [⚠]
 Do not connect the earth wiring to the gas pipe, water pipe, lightning rod and telephone earth wiring. Improper earth could cause unit failure and electric shock due to a short circuit.
- **Earth leakage breaker must be installed.** [⚠]
 If the earth leakage breaker is not installed, it can cause electric shocks.
- **Use the circuit breaker of correct capacity. Circuit breaker should be the one that disconnect all poles under over current.** [⚠]
 Using the incorrect one could cause the system failure and fire.
- **Do not use any materials other than a fuse of correct capacity where a fuse should be used.** [⊘]
 Connecting the circuit by wire or copper wire could cause unit failure and fire.
- **Do not install the indoor unit near the location where there is possibility of flammable gas leakages.** [⊘]
 If the gas leaks and gathers around the unit, it could cause fire.
- **Do not install and use the unit where corrosive gas (such as sulfuric acid gas etc.) or flammable gas (such as thinner, petroleum etc.) may be generated or accumulated, or volatile flammable substances are handled.** [⊘]
 It could cause the corrosion of heat exchanger, breakage of plastic parts etc. And inflammable gas could cause fire.
- **Secure a space for installation, inspection and maintenance specified in the manual.** [⚠]
 Insufficient space can result in accident such as personal injury due to falling from the installation place.
- **Do not use the indoor unit at the place where water splashes such as laundry.** [⊘]
 Indoor unit is not waterproof. It could cause electric shock and fire.
- **Do not use the indoor unit for a special purpose such as food storage, cooling for precision instrument, preservation of animals, plants, and a work of art.** [⊘]
 It could cause the damage of the items.
- **Do not install nor use the system near equipments which generate electromagnetic wave or high harmonics.** [⊘]
 Equipments like inverter equipment, private power generator, high-frequency medical equipment, or telecommunication equipment might influence the air conditioner and cause a malfunction and breakdown. Or the air conditioner might influence medical equipments or telecommunication equipments, and obstruct their medical activity or cause jamming.
- **Do not install the remote control at the direct sunlight.** [⊘]
 It could cause breakdown or deformation of the remote control.
- **Do not install the indoor unit at the place listed below.** [⊘]
 - Places where flammable gas could leak.
 - Places where carbon fiber, metal powder or any powder is floated.
 - Place where the substances which affect the air conditioner are generated such as sulfide gas, chlorine gas, acid, alkali or ammoniac atmospheres.
 - Places exposed to oil mist or steam directly.
 - On vehicles and ships
 - Places where machinery which generates high harmonics is used.
 - Places where cosmetics or special sprays are frequently used.
 - Highly salted area such as beach.
 - Heavy snow area
 - Places where the system is affected by smoke from a chimney.
 - Altitude over 1000m
- **Do not install the indoor unit in the locations listed below (Be sure to install the indoor unit according to the installation manual for each model because each indoor unit has each limitation)** [⊘]
 - Locations with any obstacles which can prevent inlet and outlet air of the unit
 - Locations where vibration can be amplified due to insufficient strength of structure.
 - Locations where the infrared receiver is exposed to the direct sunlight or the strong light beam. (in case of the infrared specification unit)
 - Locations where an equipment affected by high harmonics is placed. (TV set or radio receiver is placed within 5m)
 - Locations where drainage cannot run off safely.
 - It can affect performance or function and etc..
- **Do not put any valuables which will break down by getting wet under the air conditioner.** [⊘]
 Condensation could drop when the relative humidity is higher than 80% or drain pipe is clogged, and it damages user's belongings.
- **Do not use the base frame for the outdoor unit which is corroded or damaged after a long period of use.** [⊘]
 It could cause the unit falling down and injury.
- **Pay attention not to damage the drain pan by weld sputter when brazing work is done near the unit.** [⚠]
 If sputter entered into the unit during brazing work, it could cause damage (pinhole) of drain pan and leakage of water. To avoid damaging, keep the indoor unit packed or cover the indoor unit.
- **Install the drain pipe to drain the water surely according to the installation manual.** [⚠]
 Improper connection of the drain pipe may cause dropping water into room and damaging user's belongings.
- **Do not share the drain pipe for indoor unit and GHP (Gas Heat Pump system) outdoor unit.** [⊘]
 Toxic exhaust gas would flow into room and it might cause serious damage (some poisoning or deficiency of oxygen) to user's health and safety.
- **Be sure to perform air tightness test by pressurizing with nitrogen gas after completed refrigerant piping work.** [⚠]
 If the density of refrigerant exceeds the limit in the event of refrigerant leakage in the small room, lack of oxygen can occur, which can cause serious accidents.
- **For drain pipe installation, be sure to make descending slope of greater than 1/100, not to make traps, and not to make air-bleeding.** [⚠]
 Check if the drainage is correctly done during commissioning and ensure the space for inspection and maintenance.
- **Ensure the insulation on the pipes for refrigeration circuit so as not to condense water.** [⚠]
 Incomplete insulation could cause condensation and it would wet ceiling, floor, and any other valuables.
- **Do not install the outdoor unit where is likely to be a nest for insects and small animals.** [⊘]
 Insects and small animals could come into the electronic components and cause breakdown and fire. Instruct the user to keep the surroundings clean.
- **Pay extra attention, carrying the unit by hand.** [⚠]
 Carry the unit with 2 people if it is heavier than 20kg. Do not use the plastic straps but the grabbing place, moving the unit by hand. Use protective gloves in order to avoid injury by the aluminum fin.
- **Make sure to dispose of the packaging material.** [⚠]
 Leaving the materials may cause injury as metals like nail and woods are used in the package.
- **Do not operate the system without the air filter.** [⊘]
 It may cause the breakdown of the system due to clogging of the heat exchanger.
- **Do not touch any button with wet hands.** [⊘]
 It could cause electric shock.
- **Do not touch the refrigerant piping with bare hands when in operation.** [⊘]
 The pipe during operation would become very hot or cold according to the operating condition, and it could cause a burn or frostbite.
- **Do not clean up the air conditioner with water.** [⊘]
 It could cause electric shock.
- **Do not turn off the power source immediately after stopping the operation.** [⊘]
 Be sure to wait for more than 5 minutes. Otherwise it could cause water leakage or breakdown.
- **Do not control the operation with the circuit breaker.** [⊘]
 It could cause fire or water leakage. In addition, the fan may start operation unexpectedly and it may cause injury.

○ This model is high static ducted type air conditioning unit. Therefore, do not use this model for direct blow type air conditioning unit.

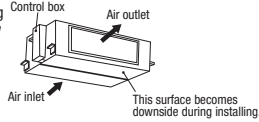

1 Before installation

- Install correctly according to the installation manual.
- Confirm the following points:
 - Unit type/Power supply specification
 - Pipes/Wires/Small parts
 - Accessory items

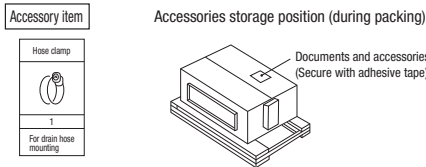

2 Selection of installation location for the indoor unit

- Select the suitable areas to install the unit under approval of the user.
 - Areas where the indoor unit can deliver hot and cold wind sufficiently. Suggest to the user to use a circulator if the ceiling height is over 3m to avoid warm air being accumulated on the ceiling.
 - Areas where there is enough space to install and service.
 - Areas where it can be drained properly. Areas where drain pipe descending slope can be taken.
 - Areas where there is no obstruction of airflow on both air return grille and air supply port.
 - Areas where fire alarm will not be accidentally activated by the air conditioner.
 - Areas where the supply air does not short-circuit.
 - Areas where it is not influenced by draft air.
 - Areas not exposed to direct sunlight.
 - Areas where dew point is lower than around 28°C and relative humidity is lower than 80%.
 (This indoor unit is tested under the condition of JIS (Japan Industrial Standard) high humidity condition and confirmed there is no problem. However, there is some risk of condensation drop if the air conditioner is operated under the severer condition than mentioned above.
 If there is a possibility to use it under such a condition, attach additional insulation of 10 to 20mm thick for entire surface of indoor unit, refrigeration pipe and drain pipe.)
 - Areas where TV and radio stays away more than 1m. (It could cause jamming and noise.)
 - Areas where any items which will be damaged by getting wet are not placed such as food, table wares, server, or medical equipment under the unit.
 - Areas where there is no influence by the heat which cookware generates.
 - Areas where not exposed to oil mist, powder and/or steam directly such as above fryer.
 - Areas where lighting device such as fluorescent light or incandescent light doesn't affect the operation.
 (A beam from lighting device sometimes affects the infrared receiver for the wireless remote controller and the air conditioner might not work properly.)

- Check if the place where the air conditioner is installed can hold the weight of the unit. If it is not able to hold, reinforce the structure with boards and beams strong enough to hold it. If the strength is not enough, it could cause injury due to unit falling.

Space for installation and service

- Make installation altitude over 2.5m.

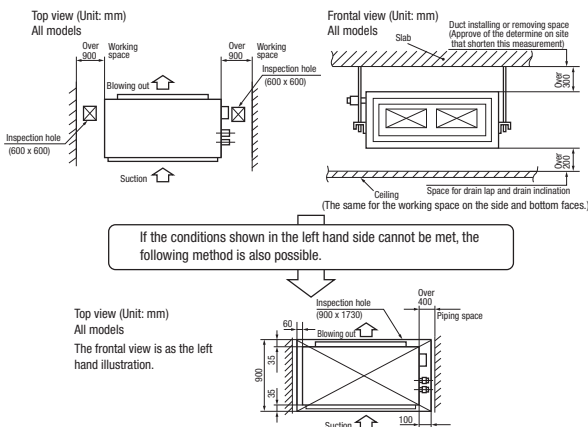

Air Conditions and Airflow Limits

Single	Multi	Airflow m ³ /min			Temperature of the blow-in air of the indoor unit		Air temperature surrounding the indoor unit
		Rating	Lower limit	Upper limit	Cooler	Heater	
200	224	51	38	65	Upper limit 26°C WB When outdoor temperature is 35°C Lower limit 16°C WB When outdoor temperature is 15°C	Upper limit 27°C DB Outdoor temperature is below 20°C WB Lower limit 10°C DB Outdoor temperature is above 10°C WB	Dew point temperature below 28°C
250	280	68	51	87	Refer to the technical document published by our company for more details.		

3 Preparation before installation

- If suspension bolt becomes longer, do reinforcement of earthquake resistant.
 - For grid ceiling
 When the suspension bolt length is over 500mm, or the gap between the ceiling and roof is over 700mm, apply earthquake resistant brace to the bolt.
 - In case the unit is hanged directly from the slab and is installed on the ceiling plane which has enough strength.
 When suspension bolt length is over 1000mm, apply the earthquake resistant brace to the bolt.
- Prepare four (4) sets of suspension bolt, nut and spring washer (M10) on site.

Suspension bolts pitch, Pipe position

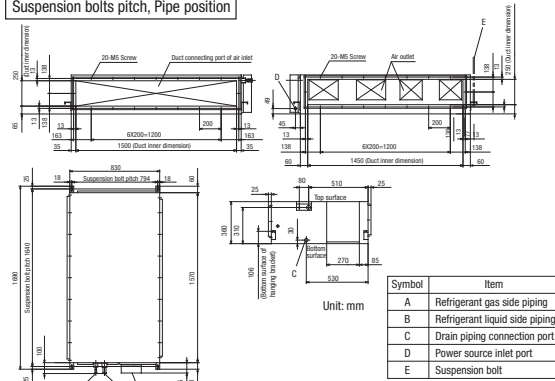

4 Installation of indoor unit

Installation

[Hanging]

- Hang the unit up.

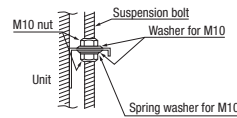

- If the measurements between the unit and the ceiling hole do not match upon installation, it may be adjusted with the long holed installation tool.



[Method for Fixing the Suspension Bolt]

- Secure the suspension bolt with one of the methods shown in the following illustration.

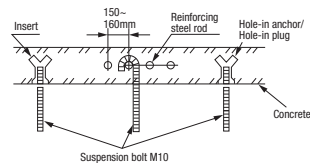

Horizontal Adjustment

- Use a level vial or adjust the level as shown in the following illustration.

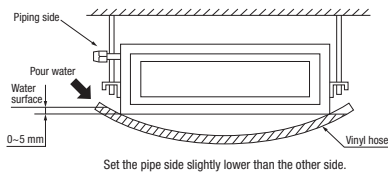

- If it is not horizontal, the float switch malfunctions or does not function.

(Packing Tools)

The packing tools (4) are not necessary.

Packing tools (4) should be removed.

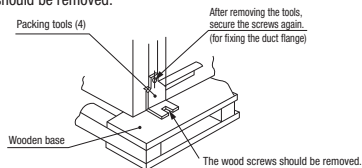

5 Duck work

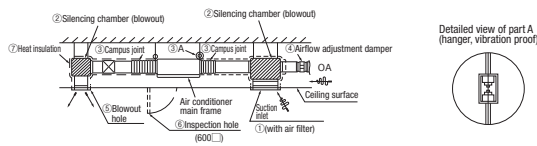

- ① Air filters are not provided with the main frame of the air conditioner. Assemble on to the suction grill which can be cleaned easily.
- ② Fit the silencing chamber according to the noise level tolerance inside the installation room. If it is particularly necessary to keep the noise level low, further silencing devices is required (always install them in offices, and conference rooms).
- ③ In order to keep the vibration from transferring to the ceiling and the slab, use a campus joint for the duct and a vibration proof rubber for the main frame.
- ④ Attach an airflow adjustment damper to the connection point of the OA duct so airflow adjustment may be possible after installation.
- ⑤ For the blowing outlet, select a shape and location where air may circulate, and a structure where airflow may be controlled.
- ⑥ An inspection hole must be made in the ceiling surface. This is necessary for the repair and maintenance of the electrical parts, motor and functional parts, as well as for cleaning the heat exchanger.
- ⑦ Insulation must be performed for the duct to prevent water condensation on the duct. The thickness of the insulating material is 65 mm (JISA 9501).

A bad example of duct work

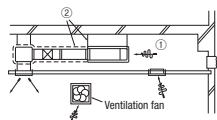

① If the suction duct is not used, and the attic is used as a suction duct, the attic will become extremely humid depending on the performance of the ventilation fan, the strength of wind blowing to the atmospheric gallery and the climate (e.g., rainy days).

- a. Condensation occurs on the outer board of the unit and water may fall on the ceiling. Use the unit according to the air conditions in the above table and airflow limits. In concrete constructions, high humidity can occur in new constructions even when the attic is not used as a suction duct. In this case, insulate the entire unit with glass wool (25 mm) (use a metal net to hold the wool).
 - b. Operation of the unit may exceed its limits (for example, when the temperature of the suction air is 24 °C with the outdoor temperature of 35 °C DB). In such a cases, problems such as an overload of the compressor may occur.
 - c. The volume of the air blowing in may increase due to the performance of the ventilation fan and the wind strength blowing against the atmospheric gallery. The air usage limit may be exceeded, and the water from the heat exchanger will not be able to drain to the drain pan. Instead it will drain outside and cause a water leak (to the ceiling).
- ② If vibration damping is not conducted between the unit and the duct, and between the unit and the slab, vibration will be transmitted to the duct and vibration noise may occur. Also, vibration may be transmitted from the unit to the slab. Vibration damping must be performed.

Simple setting method for duct measurement

The following shows the method when duct is used at one side of 250mm as 1Pa/m by frictional resistance per the unit length of the duct, and in case of 250 type (single unit)/280 type (multi unit) , 60Hz rating airflow for a example.

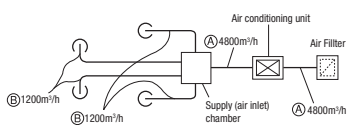

	Airflow	Duct (mm x mm)
Ⓐ	4800m ³ /h (80m ³ /min)	250 x 950
Ⓑ	1200m ³ /h (20m ³ /min)	250 x 310

○ Calculation of duct resistance
(Simplified calculate as following table)

Straight piping port	Calculate at 1Pa per 1m length to 1Pa/m
Bending port	Calculate at 3 to 4 m straight pipe per 1 piece of binding pipe
Air outlet port	Calculate at 25Pa
Chamber	Calculate at 50Pa per 1 piece
Air inlet grille (with filter)	Calculate at 40Pa per 1 piece

[Simplified duct dimension selection table]

Airflow	Duct type	
	Item	Dimensions
m ³ /h (m ³ /min)		(mm×mm)
100	250×60	
200	250×90	
300	250×120	
400	250×140	
450 (7.5)	250×160	
500	250×170	
600 (10)	250×190	
800	250×230	
1,000	250×270	
1,200 (20)	250×310	
1,400	250×350	
1,600	250×390	
1,800 (30)	250×430	
2,000	250×470	
2,400 (40)	250×560	
3,000 (50)	250×650	
3,500	250×740	
4,000	250×830	
4,500	250×920	
4,800 (80)	250×950	
5,000	250×1000	
5,500	250×1090	
6,000 (100)	250×1180	

6 Refrigerant pipe

Caution

- Use the new refrigerant pipe.
 - When re-using the existing pipe system for R22 or R407C, pay attention to the following items.
 - Change the flare nuts with the attached ones (JIS category 2), and reprocess the flare parts.
 - Do not use thin-walled pipes.
- Use phosphorus deoxidized copper alloy seamless pipe (C1220T specified in JIS H3300) for refrigerant pipe installation. In addition, make sure there is no damage both inside and outside of the pipe, and no harmful substances such as sulfur, oxide, dust or a contaminant stuck on the pipes.
- Do not use any refrigerant other than R410A.
 - Using other refrigerant except R410A (R22 etc.) may degrade inside refrigeration oil. And air getting into refrigeration circuit may cause over-pressure and resultant it may result in bursting, etc.
- Store the copper pipes indoors and seal the both end of them until they are brazed in order to avoid any dust, dirt or water getting into pipe. Otherwise it will cause degradation of refrigeration oil and compressor breakdown, etc.
- Use special tools for R410A refrigerant.
- The indoor unit pipes allow the maintenance panel to be removed. Therefore, regardless of the piping direction, there should be a straight section of 400 mm or more.

Work procedure

1. When brazing work, perform it while cool down around the brazing port with wet towels to prevent the overheating.
2. After check the gas leak test, install the heat insulation (prepare on site) to the brazing port of the indoor unit.
 - Be sure to perform the heat insulation both of gas side piping with liquid side piping.
 - ※ If heat insulation does not install to the pipes, dew condensation may occurs and it may cause the water leakage.
 - The thickness of the heat insulation should be more than 20mm.
3. Refrigerant is charged in the outdoor unit.
 - As for the additional refrigerant charge for the indoor unit and piping, refer to the installation manual attached to the outdoor unit.

Single unit		Multi unit		
Type 200	Liquid piping	φ 9.52	Flaring	
	Gas piping	φ 25.4	Flaring	
Type 250	Liquid piping	φ 12.7	Flaring	
	Gas piping	φ 25.4	Flaring	

7 Drain pipe

Caution

- Install the drain pipe according to the installation manual in order to drain properly. Imperfection in draining may cause flood indoors and wetting the household goods, etc.
- Do not put the drain pipe directly into the ditch where toxic gas such as sulfur, the other harmful and inflammable gas is generated. Toxic gas would flow into the room and it would cause serious damage to user's health and safety (some poisoning or deficiency of oxygen). In addition, it may cause corrosion of heat exchanger and bad smell.
- Connect the pipe securely to avoid water leakage from the joint.
- Insulate the pipe properly to avoid condensation drop.
- Check if the water can flow out properly from both the drain outlet on the indoor unit and the end of the drain pipe after installation.
- Make sure to make descending slope of greater than 1/100 and do not make up-down bend and/or trap in the midway. In addition, do not put air vent on the drain pipe. Check if water is drained out properly from the pipe during commissioning. Also, keep sufficient space for inspection and maintenance.

Work procedure

1. Insert the supplied drain hose (the end made of soft PVC) to the step of the drain socket on the indoor unit and fix it securely with the clamp.
 - Do not apply adhesives on this end.

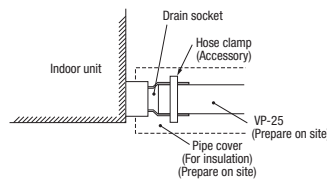

2. Prepare a joint for connecting VP-25 pipe, adhere and connect the joint to the drain hose (the end made of rigid PVC), and adhere and connect VP-25 pipe (prepare on site).
 - ※ As for drain pipe, apply VP-25 made of rigid PVC which is on the market.
 - Make sure that the adhesive will not get into the supplied drain hose. It may cause the flexible part broken after the adhesive is dried up and gets rigid.
 - The flexible drain hose is intended to absorb a small difference at installation of the unit or drain pipes. Intentional bending, expanding may cause the flexible hose broken and water leakage.

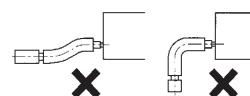

⑦ Drain pipe (continued)

3. Make sure to make descending slope of greater than 1/100 and do not make up-down bend and/or trap in the midway.
 - Pay attention not to give stress on the pipe on the indoor unit side, and support and fix the pipe as close place to the unit as possible when connecting the drain pipe.
 - Do not set up air vent.

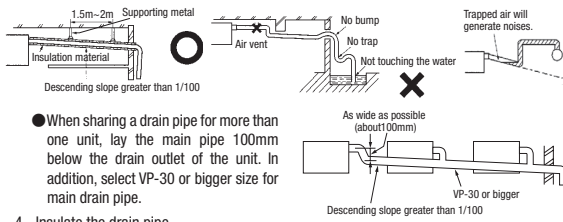

- When sharing a drain pipe for more than one unit, lay the main pipe 100mm below the drain outlet of the unit. In addition, select VP-30 or bigger size for main drain pipe.

4. Insulate the drain pipe.

- Be sure to insulate the drain socket and rigid PVC pipe installed indoors otherwise it may cause dew condensation and water leakage.

※ After drainage test implementation, cover the drain socket part with pipe cover (small size), then use the pipe cover (big size) to cover the pipe cover (small size), clamps and part of the drain hose, and fix and wrap it with tapes to wrap and make joint part gapless.

Caution

When the duct is connected and the blowing device is operated, the pressure inside the unit becomes negative to the atmospheric pressure.

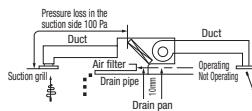

Example: As shown in the above illustration, if the pressure loss of the suction grill, air filter, and the suction side of the duct is 100 Pa, the drain water level during operation is 10mm higher than when it is not operating.

Fixing Traps

The pressure loss varies depending on the clogging in the air filter. Therefore, make one trap (during the piping work) to prevent water from remaining in the drain pan. It is necessary to make a trap with a structure that allows cleaning. Use the T joint as demonstrated in the left illustration. Also, set the trap height as shown in the left illustration. Arrange the trap near to the unit.

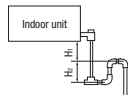

- Make one trap along the drain pipe as the left illustration.

H1 = 100 mm or the static pressure of the blowing device
H2 = 1/2 H1 or 50 ~ 100 mm

Drain test

Upon completion of drain piping, check by running water through it.

- Remove the side panel and gradually pour 1000 cc of water into the drain pan. Ensure that the water drains smoothly.

Also, ensure that there are no water leaks from the connections and joints.

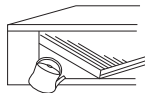

⑧ Wiring-out position and wiring connection

- Electrical installation work must be performed according to the installation manual by an electrical installation service provider qualified by a power provider of the country, and be executed according to the technical standards and other regulations applicable to electrical installation in the country.
- Be sure to use an exclusive circuit.
- Use specified cord, fasten the wiring to the terminal securely, and hold the cord securely in order not to apply unexpected stress on the terminal.
- Do not put both power source line and signal line on the same route. It may cause miscommunication and malfunction.
- Be sure to do D type earth work.
- For the details of electrical wiring work, see attached instruction manual for electrical wiring work.

1. Remove a lid of the control box (2 screws) and a hook which is located on top of it.
2. Hold each wiring inside the unit and fasten them to terminal block securely.
3. Fix the wiring with clamps.
4. Install the removed parts back to original place.

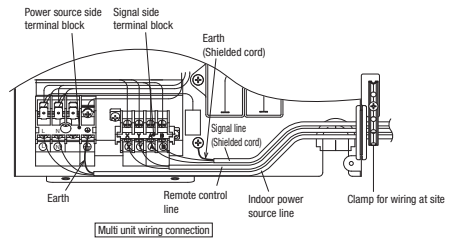
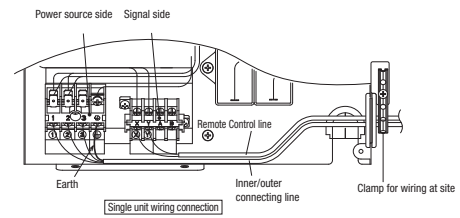

⑨ Check list after installation

- Check the following items after all installation work completed.

Check if	Expected trouble	Check
The indoor and outdoor units are fixed securely?	Falling, vibration, noise	
Inspection for leakage is done?	Insufficient capacity	
Insulation work is properly done?	Water leakage	
Water is drained properly?	Water leakage	
Supply voltage is same as mentioned in the model name plate?	PCB burnt out, not working at all	
There is mis-wiring or mis-connection of piping?	PCB burnt out, not working at all	
Earth wiring is connected properly?	Electric shock	
Cable size comply with specified size?	PCB burnt out, not working at all	
Any obstacle blocks airflow on air inlet and outlet?	Insufficient capacity	

(5) Duct connected-Low / Middle static pressure type (FDUM)

PJG012D008B

(a) Indoor unit

This manual is for the installation of an indoor unit.
For electrical wiring work (Indoor), refer to page 251. For remote control installation, refer to page 263. For wireless kit installation, refer to page 523. For electrical wiring work (Outdoor) and refrigerant pipe work installation for outdoor unit, refer page 277.

SAFETY PRECAUTIONS

- Read the "SAFETY PRECAUTIONS" carefully first of all and then strictly follow it during the installation work in order to protect yourself.
- The precautionary items mentioned below are distinguished into two levels, [WARNING] and [CAUTION].
[WARNING]: Wrong installation would cause serious consequences such as injuries or death.
[CAUTION]: Wrong installation might cause serious consequences depending on circumstances.
Both mentions the important items to protect your health and safety so strictly follow them by any means.
The meanings of "Marks" used here are as shown on the right.
[S] Never do it under any circumstances. [A] Always do it according to the instruction.
- After completing the installation, do commissioning to confirm there are no abnormalities, and explain to the customers about "SAFETY PRECAUTIONS", correct operation method and maintenance method (air filter cleaning, operation method and temperature setting method) with user's manual of this unit.
Ask your customers to keep this installation manual together with the user's manual. Also, ask them to hand over the user's manual to the new user when the owner is changed.

WARNING

- **Installation should be performed by the specialist.**
If you install the unit by yourself, it may lead to serious trouble such as water leakage, electric shock, fire, and injury due to overturn of the unit.
- **Install the system correctly according to these installation manuals.**
Improper installation may cause explosion, injury, water leakage, electric shock, and fire.
- **Check the density referred by the formula (accordance with ISO5149).**
If the density exceeds the limit density, please consult the dealer and installate the ventilation system.
- **Use the genuine accessories and the specified parts for installation.**
If parts unspecified by our company are used it could cause water leakage, electric shock, fire, and injury due to overturn of the unit.
- **Ventilate the working area well in case the refrigerant leaks during installation.**
If the refrigerant contacts the fire, toxic gas is produced.
- **Install the unit in a location that can hold heavy weight.**
Improper installation may cause the unit to fall leading to accidents.
- **Install the unit properly in order to be able to withstand strong winds such as typhoons, and earthquakes.**
Improper installation may cause the unit to fall leading to accidents.
- **Do not mix air in to the cooling cycle on installation or removal of the air conditioner.**
If air is mixed in, the pressure in the cooling cycle will rise abnormally and may cause explosion and injuries.
- **Be sure to have the electrical wiring work done by qualified electrical installer, and use exclusive circuit.**
Power source with insufficient capacity and improper work can cause electric shock and fire.
- **Use specified wire for electrical wiring, fasten the wiring to the terminal securely, and hold the cable securely in order not to apply unexpected stress on the terminal.**
Loose connections or hold could result in abnormal heat generation or fire.
- **Arrange the electrical wires in the control box properly to prevent them from rising. Fit the lid of the services panel properly.**
Improper fitting may cause abnormal heat and fire.
- **Check for refrigerant gas leakage after installation is completed.**
If the refrigerant gas leaks into the house and comes in contact with a fan heater, a stove, or an oven, toxic gas is produced.
- **Use the specified pipe, flare nut, and tools for R410A.**
Using existing parts (R22) could cause the unit failure and serious accident due to explosion of the cooling cycle.
- **Tighten the flare nut according to the specified method by with torque wrench.**
If the flare nut were tightened with excess torque, it could cause burst and refrigerant leakage after a long period.
- **Do not put the drainage pipe directly into drainage channels where poisonous gases such as sulfide gas can occur.**
Poisonous gases will flow into the room through drainage pipe and seriously affect the user's health and safety. This can also cause the corrosion of the indoor unit and a resultant unit failure or refrigerant leak.
- **Connect the pipes for refrigeration circuit securely in installation work before compressor is operated.**
If the compressor is operated when the service valve is open without connecting the pipe, it could cause explosion and injuries due to abnormal high pressure in the system.
- **Stop the compressor before removing the pipe after shutting the service valve on pump down work.**
If the pipe is removed when the compressor is in operation with the service valve open, air would be mixed in the refrigeration circuit and it could cause explosion and injuries due to abnormal high pressure in the cooling cycle.
- **Only use prescribed optional parts. The installation must be carried out by the qualified installer.**
If you install the system by yourself, it can cause serious trouble such as water leaks, electric shocks, fire.
- **Do not repair by yourself. And consult with the dealer about repair.**
Improper repair may cause water leakage, electric shock or fire.
- **Consult the dealer or a specialist about removal of the air conditioner.**
Improper installation may cause water leakage, electric shock or fire.
- **Turn off the power source during servicing or inspection work.**
If the power is supplied during servicing or inspection work, it could cause electric shock and injury by the operating fan.
- **Do not run the unit when the panel or protection guard are taken off.**
Touching the rotating equipment, hot surface, or high voltage section could cause an injury to be caught in the machine, to get burned, or electric shock.
- **Shut off the power before electrical wiring work.**
It could cause electric shock, unit failure and improper running.

CAUTION

- **Perform earth wiring surely.**
Do not connect the earth wiring to the gas pipe, water pipe, lightning rod and telephone earth wiring. Improper earth could cause unit failure and electric shock or fire due to a short circuit.
- **Earth leakage breaker must be installed.**
If the earth leakage breaker is not installed, it could cause electric shocks or fire.
- **Use the circuit breaker of correct capacity. Circuit breaker should be the one that disconnect all poles under over current.**
Using the incorrect one could cause the system failure and fire.
- **Do not use any materials other than a fuse of correct capacity where a fuse should be used.**
Connecting the circuit by wire or copper wire could cause unit failure and fire.
- **Do not install the indoor unit near the location where there is possibility of flammable gas leakages.**
If the gas leaks and gathers around the unit, it could cause fire.
- **Do not install and use the unit where corrosive gas (such as sulfurous acid gas etc.) or flammable gas (such as thinner, petroleum etc.) may be generated or accumulated, or volatile flammable substances are handled.**
It could cause the corrosion of heat exchanger, breakage of plastic parts etc. And inflammable gas could cause fire.
- **Secure a space for installation, inspection and maintenance specified in the manual.**
Insufficient space can result in accident such as personal injury due to falling from the installation place.
- **Do not use the indoor unit at the place where water splashes such as laundry.**
Indoor unit is not waterproof. It could cause electric shock and fire.
- **Do not use the indoor unit for a special purpose such as food storage, cooling for precision instrument, preservation of animals, plants, and a work of art.**
It could cause the damage of the items.
- **Do not install nor use the system near equipments which generate electromagnetic wave or high harmonics.**
Equipments like inverter equipment, private power generator, high-frequency medical equipment, or telecommunication equipment might influence the air conditioner and cause a malfunction and breakdown. Or the air conditioner might influence medical equipments or telecommunication equipments, and obstruct their medical activity or cause jamming.
- **Do not install the remote control at the direct sunlight.**
It could cause breakdown or deformation of the remote control.
- **Do not install the indoor unit at the place listed below.**
 - Places where flammable gas could leak.
 - Places where carbon fiber, metal powder or any powder is floated.
 - Place where the substances which affect the air conditioner are generated such as sulfide gas, chloride gas, acid, alkali or amoniac atmospheres.
 - Places exposed to oil mist or steam directly.
 - On vehicles and ships
 - Places where machinery which generates high harmonics is used.
 - Places where cosmetics or special sprays are frequently used.
 - Highly salted area such as beach.
 - Heavy snow area
 - Places where the system is affected by smoke from a chimney.
 - Altitude over 1000m
- **Do not install the indoor unit in the locations listed below (Be sure to install the indoor unit according to the installation manual for each model because each indoor unit has each limitation)**
 - Locations with any obstacles which can prevent inlet and outlet air of the unit
 - Locations where vibration can be amplified due to insufficient strength of structure.
 - Locations where the infrared receiver is exposed to the direct sunlight or the strong light beam. (In case of the infrared specification unit)
 - Locations where an equipment affected by high harmonics is placed. (TV set or radio receiver is placed within 5m)
 - Locations where drainage cannot run off safely.
 - It can affect performance or function and etc..
- **Do not put any valuables which will break down by getting wet under the air conditioner.**
Condensation could drop when the relative humidity is higher than 80% or drain pipe is clogged, and it damages user's belongings.
- **Do not use the base frame for the outdoor unit which is corroded or damaged after a long period of use.**
It could cause the unit falling down and injury.
- **Pay attention not to damage the drain pan by weld sputter when brazing work is done near the unit.**
If sputter entered into the unit during brazing work, it could cause damage (pinhole) of drain pan and leakage of water. To avoid damaging, keep the indoor unit packed or cover the indoor unit.
- **Install the drain pipe to drain the water surely according to the installation manual.**
Improper connection of the drain pipe may cause dropping water into room and damaging user's belongings.
- **Do not share the drain pipe for indoor unit and GHP (Gas Heat Pump system) outdoor unit.**
Toxic exhaust gas would flow into room and it might cause serious damage (some poisoning or deficiency of oxygen) to user's health and safety.
- **Be sure to perform air tightness test by pressurizing with nitrogen gas after completed refrigerant piping work.**
If the density of refrigerant exceeds the limit in the event of refrigerant leakage in the small room, lack of oxygen can occur, which can cause serious accidents.
- **For drain pipe installation, be sure to make descending slope of greater than 1/100, not to make traps, and not to make air-bleeding.**
Check if the drainage is correctly done during commissioning and ensure the space for inspection and maintenance.
- **Ensure the insulation on the pipes for refrigeration circuit so as not to condense water.**
Incomplete insulation could cause condensation and it would wet ceiling, floor, and any other valuables.
- **Do not install the outdoor unit where is likely to be a nest for insects and small animals.**
Insects and small animals could come into the electronic components and cause breakdown and fire. Instruct the user to keep the surroundings clean.
- **Pay extra attention, carrying the unit by hand.**
Carry the unit with 2 people if it is heavier than 20kg. Do not use the plastic straps but the grabbing place, moving the unit by hand. Use protective gloves in order to avoid injury by the aluminum fin.
- **Make sure to dispose of the packaging material.**
Leaving the materials may cause injury as metals like nail and woods are used in the package.
- **Do not operate the system without the air filter.**
It may cause the breakdown of the system due to clogging of the heat exchanger.
- **Do not touch any button with wet hands.**
It could cause electric shock.
- **Do not touch the refrigerant piping with bare hands when in operation.**
The pipe during operation would become very hot or cold according to the operating condition, and it could cause a burn or frostbite.
- **Do not clean up the air conditioner with water.**
It could cause electric shock.
- **Do not turn off the power source immediately after stopping the operation.**
Be sure to wait for more than 5 minutes. Otherwise it could cause water leakage or breakdown.
- **Do not control the operation with the circuit breaker.**
It could cause fire or water leakage. In addition, the fan may start operation unexpectedly and it may cause injury.

○ This model is middle static ducted type air conditioning unit. Therefore, do not use this model for direct blow type air conditioning unit.

① Before installation

- Install correctly according to the installation manual.
- Confirm the following points:
 - Unit type/Power supply specification
 - Pipes/Wires/Small parts
 - Accessory items

Accessory item

For hanging	For refrigerant pipe			For drain pipe			
Flat washer (M10)	Pipe cover (big)	Pipe cover (small)	Strap	Pipe cover (big)	Pipe cover (small)	Drain hose	Hose clamp
8	1	1	4	1	1	1	1
For unit hanging	For heat insulation of gas pipe	For heat insulation of liquid tube	For pipe cover fixing	For heat insulation of drain socket	For heat insulation of drain socket	For drain pipe connecting	For drain hose mounting

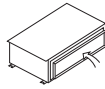

Accessory parts are stored inside this suction side.

② Selection of installation location for the indoor unit

- Select the suitable areas to install the unit under approval of the user.
 - Areas where the indoor unit can deliver hot and cold wind sufficiently. Suggest to the user to use a circulator if the ceiling height is over 3m to avoid warm air being accumulated on the ceiling.
 - Areas where there is enough space to install and service.
 - Areas where it can be drained properly. Areas where drain pipe descending slope can be taken.
 - Areas where there is no obstruction of airflow on both air return grille and air supply port.
 - Areas where fire alarm will not be accidentally activated by the air conditioner.
 - Areas where the supply air does not short-circuit.
 - Areas where it is not influenced by draft air.
 - Areas not exposed to direct sunlight.
 - Areas where dew point is lower than around 28°C and relative humidity is lower than 80%.
 (This indoor unit is tested under the condition of JIS (Japan Industrial Standard) high humidity condition and confirmed there is no problem. However, there is some risk of condensation drop if the air conditioner is operated under the severer condition than mentioned above. If there is a possibility to use it under such a condition, attach additional insulation of 10 to 20mm thick for entire surface of indoor unit, refrigeration pipe and drain pipe.)
 - Areas where TV and radio stays away more than 1m. (It could cause jamming and noise.)
 - Areas where any items which will be damaged by getting wet are not placed such as food, table wares, server, or medical equipment under the unit.
 - Areas where there is no influence by the heat which cookware generates.
 - Areas where not exposed to oil mist, powder and/or steam directly such as above fryer.
 - Areas where lighting device such as fluorescent light or incandescent light doesn't affect the operation.
 (A beam from lighting device sometimes affects the infrared receiver for the wireless remote control and the air conditioner might not work properly.)

Space for installation and service

- Make installation altitude over 2.5m.

(Indoor Unit)

Select either of two cases to keep space for installation and services.

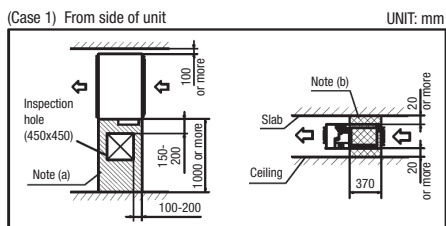

- Notes (a) There must not be obstacle to draw out fan motor. (hatched area marked area)
 (b) Install refrigerant pipe, drain pipe, and wiring so as not to cross (cross-hatched area) marked area.

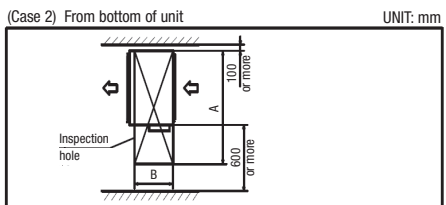

(Size of inspection hole)	UNIT: mm		
Single type	40-50	60-71	100-140
Multi type	22-56	71-90	112-160
A	1100	1300	1720
B		620	725

③ Preparation before installation

- If suspension bolt becomes longer, do reinforcement of earthquake resistant.
 - For grid ceiling
 When the suspension bolt length is over 500mm, or the gap between the ceiling and roof is over 700mm, apply earthquake resistant brace to the bolt.
 - In case the unit is hanged directly from the slab and is installed on the ceiling plane which has enough strength.
 When suspension bolt length is over 1000mm, apply the earthquake resistant brace to the bolt.
- Prepare four (4) sets of suspension bolt, nut and spring washer (M10) on site.

Suspension Bolt Location

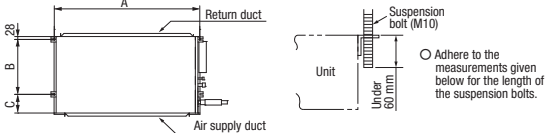

	UNIT: mm		
Multi type	22-56	71, 90	112-160
Single type	40-50	60, 71	100-140
A	786	986	1404
B	472	472	530
C	135	135	180

Pipe locations

	UNIT: mm
Multi type	22-90
Single type	40-71

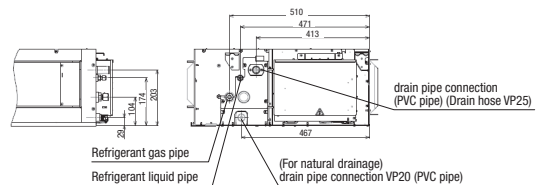

Multi type	112-160
Single type	100-140

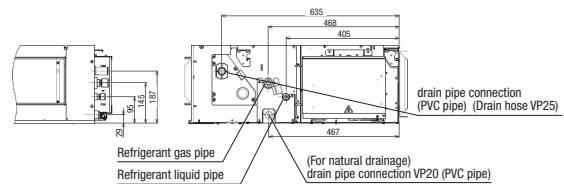

④ Installation of indoor unit

Installation

[Hanging]

Hang the unit up.

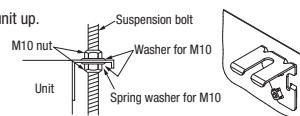

If the measurements between the unit and the ceiling hole do not match upon installation, it may be adjusted with the long holed installation tool.

Adjustment for horizontality

○ Either use a level vial, or adjust the level according to the method below.

- Adjust so the bottom side of the unit will be leveled with the water surface as illustrated below.

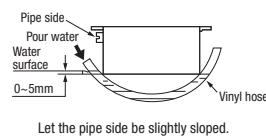

○ If the unit is not leveled, it may cause malfunctions or inoperation of the float switch.

⑤ Duct Work

① A corrugated board (for preventing sputtering) is attached to the main body of the air conditioner (on the outlet port). Do not remove it until connecting the duct.

● An air filter can be provided on the main body of the air conditioner (on the inlet port). Remove it when connecting the duct on the inlet port.

② Blowout duct

● Use rectangular duct to connect with unit.
Duct size for each unit is as shown below.

	UNIT: mm		
Single type	40-50	60-71	100-140
Multi type	22-56	71-90	112-140
A	682	882	1202
B	172	172	172

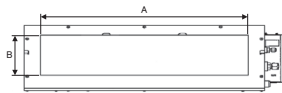

- Duct should be at their minimum length.
- We recommend to use sound and heat insulated duct to prevent it from condensation.
- Connect duct to unit before ceiling attachment.

③ Inlet port

- When shipped the inlet port lies on the back.
- When connecting the duct to the inlet port, remove the air filter if it is fitted to the inlet port.
- When placing the inlet port to carry out suction from the bottom side, use the following procedure to replace the suction duct joint and the bottom plate.

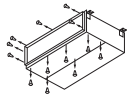

● Remove the screws which fasten the bottom plate and the duct joint on the inlet port side of the unit.

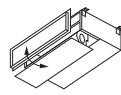

● Replace the removed bottom plate and duct joint.

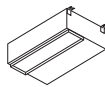

- Fit the duct joint with a screw; fit the bottom plate.
- Make sure to insulate the duct to prevent dewing on it.

④ Install the specific blowout duct in a location where the air will circulate to the entire room.

- Conduct the installation of the specific blowout hole and the connection of the duct before attaching them to the ceiling.
- Insulate the area where the duct is secured by a band for dew condensation prevention.

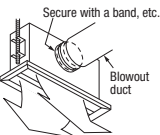

⑤ Make sure provide an inspection hole on the ceiling. It is indispensable to service electric equipment, motor, functional components and cleaning of heat exchanger.

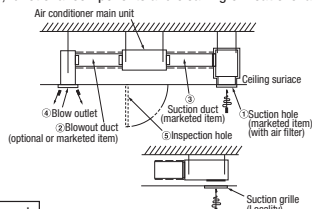

Bad example of duct work

① If a duct is not provided at the suction side but it is substituted with the space over the ceiling, humidity in the space will increase by the influence of capacity of ventilation fan, strength of wind blowing against the out door air louver, weather (rainy day) and others.

a) Moisture in air is likely to condense over the external plates of the unit and to drip on the ceiling. Unit should be operated under the conditions as listed in the above table and within the limitation of wind volume. When the building is a concrete structure, especially immediately after the construction, humidity tends to rise even if the space over the ceiling is not substituted in place of a duct. In such occasion, it is necessary to insulate the entire unit with glass wool (25mm). (Use a wire net or equivalent to hold the glass wool in place.)

b) It may run out the allowable limit of unit operation (Example: When outdoor air temperature is 35°C DB, suction air temperature is 27°C WB) and it could result in such troubles as compressor overload, etc..

c) There is a possibility that the blow air volume may exceed the allowable range of operation due to the capacity of ventilation fan or strength of wind blowing against external air louver so that drainage from be heat exchanger may fall to reach the drain pan but leak outside (Example: drip on to the ceiling) with consequential water leakage in the room.

② If vibration damping is not conducted between the unit and the duct, and between the unit and the slab, vibration will be transmitted to the duct and vibration noise may occur. Also, vibration may be transmitted from the unit to the slab. Vibration damping must be performed.

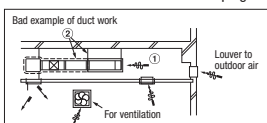

⑤ Duct Work (continued)

Connecting the air intake/vent ducts

① Fresh Air Intake

[for air intake duct only]

○ Use the side fresh air intake hole, or supply through a part of the suction duct.

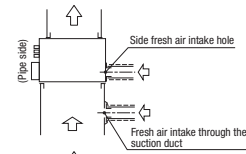

[for simultaneous air intake/vent]

○ Intake air through the suction duct.

(the side cannot be used)

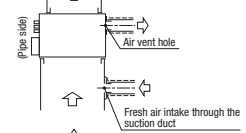

② Air Vent

○ Use the side air vent hole.

(always use together with the air intake)

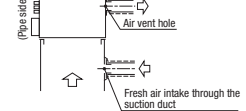

○ Insulate the duct to protect it from dew condensation.

⑥ Refrigerant pipe

Caution

● Use the new refrigerant pipe.

When re-using the existing pipe system for R22 or R407C, pay attention to the following items.

- Change the flare nuts with the attached ones (JIS category 2), and reprocess the flare parts.
- Do not use thin-walled pipes.

● Use phosphorus deoxidized copper alloy seamless pipe (C1220T specified in JIS H3300) for refrigeration pipe installation.

In addition, make sure there is no damage both inside and outside of the pipe, and no harmful substances such as sulfur, oxide, dust or a contaminant stuck on the pipes.

● Do not use any refrigerant other than R410A.

Using other refrigerant except R410A (R22 etc.) may degrade inside refrigeration oil. And air getting into refrigeration circuit may cause over-pressure and resultant it may result in bursting, etc.

● Store the copper pipes indoors and seal the both end of them until they are brazed in order to avoid any dust, dirt or water getting into pipe. Otherwise it will cause degradation of refrigeration oil and compressor breakdown, etc.

● Use special tools for R410A refrigerant.

Piping work

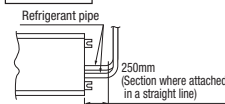

When conducting piping work, make sure to allow the pipes to be aligned in a straight line for at least 250 mm, as shown in the left illustration. (This is necessary for the drain pump to function)

Work procedure

1. Remove the flare nut and blind flanges on the pipe of the indoor unit.

※ Make sure to loosen the flare nut with holding the nut on pipe side with a spanner and giving torque to the nut with another spanner in order to avoid unexpected stress to the copper pipe, and then remove them. (Gas may come out at this time, but it is not abnormal.)

● Pay attention whether the flare nut pops out. (as the indoor unit is sometimes pressured.)

2. Make a flare on liquid pipe and gas pipe, and connect the refrigeration pipes on the indoor unit.
※ Bend the pipe with as big radius as possible and do not bend the pipe repeatedly. In addition, do not twist and crush the pipes.

※ Do a flare connection as follows:

● Make sure to loosen the flare nut with holding the nut on pipe side with a spanner and giving torque to the nut with another spanner in order to avoid unexpected stress to the copper pipe, and then remove them.

● When fastening the flare nut, align the refrigeration pipe with the center of flare nut, screw the nut for 3-4 times by hand and then tighten it by spanner with the specified torque mentioned in the table below. Make sure to hold the pipe on the indoor unit securely by a spanner when tightening the nut in order to avoid unexpected stress on the copper pipe.

3. Cover the flare connection part of the indoor unit with attached insulation material after a gas leakage inspection, and tighten both ends with attached straps.

● Make sure to insulate both gas pipes and liquid pipes completely.

※ Incomplete insulation may cause dew condensation or water dropping.

4. Refrigerant is charged in the outdoor unit.

As for the additional refrigerant charge for the indoor unit and piping, refer to the installation manual attached to the outdoor unit.

Pipe diameter	Tightening torque N·m
φ 6.35	14 to 18
φ 9.52	34 to 42
φ 12.7	49 to 61
φ 15.88	68 to 82

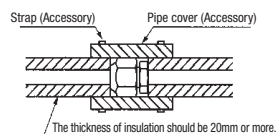

⑦ Drain pipe

Caution

- Install the drain pipe according to the installation manual in order to drain properly. Imperfection in draining may cause flood indoors and wetting the household goods, etc.
- Do not put the drain pipe directly into the ditch where toxic gas such as sulfur, the other harmful and inflammable gas is generated. Toxic gas would flow into the room and it would cause serious damage to user's health and safety (some poisoning or deficiency of oxygen). In addition, it may cause corrosion of heat exchanger and bad smell.
- Connect the pipe securely to avoid water leakage from the joint.
- Insulate the pipe properly to avoid condensation drop.
- Check if the water can flow out properly from both the drain outlet on the indoor unit and the end of the drain pipe after installation.
- Make sure to make descending slope of greater than 1/100 and do not make up-down bend and/or trap in the midway. In addition, do not put air vent on the drain pipe. Check if water is drained out properly from the pipe during commissioning. Also, keep sufficient space for inspection and maintenance.

Work procedure

1. Make sure to insert the drain hose (the end made of soft PVC) to the end of the step part of drain socket.
Attach the hose clamp to the drain hose around 10mm from the end, and fasten the screw within 5mm left to the nut.
 - Do not apply adhesives on this end.
 - Do not use acetone-based adhesives to connect to the drain socket.

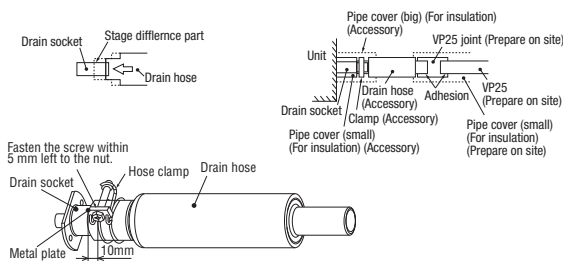

2. Prepare a joint for connecting VP-25 pipe, adhere and connect the joint to the drain hose (the end made of rigid PVC), and adhere and connect VP-25 pipe (prepare on site).
 - ※As for drain pipe, apply VP-25 made of rigid PVC which is on the market.
 - Make sure that the adhesive will not get into the supplied drain hose. It may cause the flexible part broken after the adhesive is dried up and gets rigid.
 - The flexible drain hose is intended to absorb a small difference at installation of the unit or drain pipes. Intentional bending, expanding may cause the flexible hose broken and water leakage.

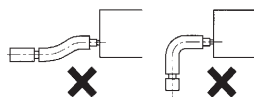

3. Make sure to make descending slope of greater than 1/100 and do not make up-down bend and/or trap in the midway.
 - Pay attention not to give stress on the pipe on the indoor unit side, and support and fix the pipe as close place to the unit as possible when connecting the drain pipe.
 - Do not set up air vent.

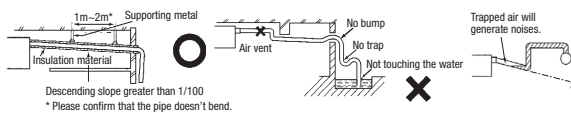

- When sharing a drain pipe for more than one unit, lay the main pipe 100mm below the drain outlet of the unit. In addition, select VP-30 or bigger size for main drain pipe.

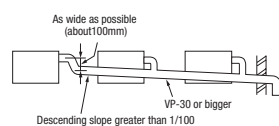

4. Insulate the drain pipe.
 - Be sure to insulate the drain socket and rigid PVC pipe installed indoors otherwise it may cause dew condensation and water leakage.
 - ※After drainage test implementation, cover the drain socket part with pipe cover (small size), then use the pipe cover (big size) to cover the pipe cover (small size), clamps and part of the drain hose, and fix and wrap it with tapes to wrap and make joint part gapless.

⑦ Drain pipe (continued)

Drain up

- The position for drain pipe outlet can be raised up to 600mm above the ceiling. Use elbows for installation to avoid obstacles inside ceiling. If the horizontal drain pipe is too long before vertical pipe, the backflow of water will increase when the unit is stopped, and it may cause overflow of water from the drain pan on the indoor unit. In order to avoid overflow, keep the horizontal pipe length and offset of the pipe within the limit shown in the figure below.

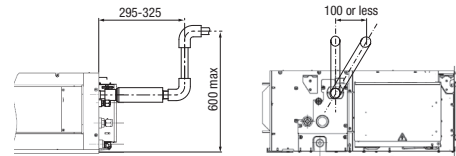

Otherwise, the construction point makes it same as drain pipe construction.

Drain test

1. Conduct a drain test after completion of the electrical work.
2. During the trial, make sure that drain flows properly through the piping and that no water leaks from connections.
3. In case of a new building, conduct the test before it is furnished with the ceiling.
4. Be sure to conduct this test even when the unit is installed in the heating season.

Procedures

1. Supply about 1000 cc of water to the unit through the air outlet by using a feed water pump.
2. Check the drain while cooling operation.

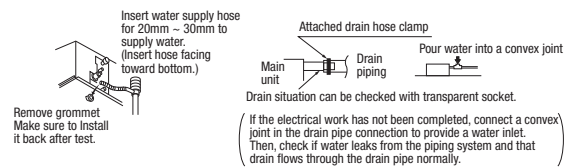

Outline of bottom drain piping work

- If the bottom drain piping can be done with a descending gradient (1/50-1/100), it is possible to connect the pipes as shown in the drawing below.

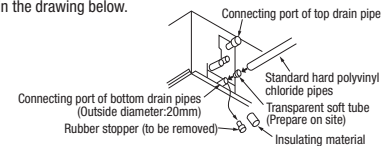

Uncoupling the drain motor connector

- Uncouple the connector CNR for the drain motor as illustrated in the drawing on the right.
- (Note: If the unit is run with the connector coupled, drain water will be discharged from the upper drain pipe joint, causing a water leak.)

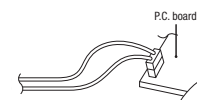

⑧ Wiring-out position and wiring connection

- Electrical installation work must be performed according to the installation manual by an electrical installation service provider qualified by a power provider of the country, and be executed according to the technical standards and other regulations applicable to electrical installation in the country.
Be sure to use an exclusive circuit.
 - Use specified cord, fasten the wiring to the terminal securely, and hold the cord securely in order not to apply unexpected stress on the terminal.
 - Do not put both power source line and signal line on the same route. It may cause miscommunication and malfunction.
 - For the details of electrical wiring work, see attached instruction manual for electrical wiring work.
1. Remove a lid of the control box (2 screws).
 2. Hold each wiring inside the unit and fasten them to terminal block securely.
 3. Fix the wiring with clamps.
 4. Install the removed parts back to original place.

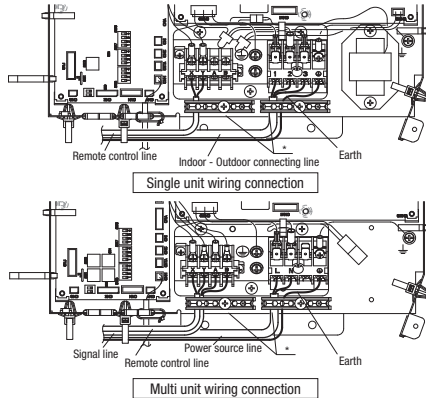

⑨ External static pressure setting (continued)

Indoor unit fan will run automatically and recognize E.S.P. by itself.
The operation for automatic E.S.P. recognition will last about 6 minutes, and it will be stopped after recognition is completed.

Caution

- Be sure to execute AUTOMATIC SETTING by remote control AFTER ducting work is completed.
- When duct specification is changed after AUTOMATIC SETTING, be sure to execute AUTOMATIC SETTING again after power resetting and turning on again.
- Be sure to execute AUTOMATIC SETTING before trial cooling operation.
(See ELECTRICAL WIRING WORK INSTRUCTION about trial cooling operation)
- Before AUTOMATIC SETTING, be sure to check that return air filter in duct is installed and damper is opened.
- Wrong procedure causes excessive air flow or water drop blown out.

Notice

- During operation for automatic recognition (the Auto Operation), fan rotates with certain speeds regardless of set fan speed by remote control.
- When duct is set with low static pressure (around 10-50Pa), even if indoor unit operate with higher air flow volume than rated one, but it is not abnormal.
- When you changed operation mode or stop operation with ON/OFF button during Auto Operation, the Auto operation will be canceled.
- In such case, be sure to execute AUTOMATIC SETTING again according to above procedure.

⑩ Check list after installation

- Check the following items after all installation work completed.

Check if	Expected trouble	Check
The indoor and outdoor units are fixed securely?	Falling, vibration, noise	
Inspection for leakage is done?	Insufficient capacity	
Insulation work is properly done?	Water leakage	
Water is drained properly?	Water leakage	
Supply voltage is same as mentioned in the model name plate?	PCB burnt out, not working at all	
No mis-wiring or mis-connection of piping?	PCB burnt out, not working at all	
Earth wiring is connected properly?	Electric shock	
Cable size comply with specified size?	PCB burnt out, not working at all	
Any obstacle blocks airflow on air inlet and outlet?	Insufficient capacity	
Is setting of E.S.P finished?	Excessive air flow, water drop blow out	

⑨ External static pressure setting

You can set External Static Pressure (E.S.P.) by either method of MANUAL SETTING or AUTOMATIC SETTING by remote control.
Indoor unit will control fan-speed to keep rated air flow volume at each fan speed setting (Lo-Uhi)

1. MANUAL SETTING

You can set required E.S.P. by wired remote control that calculated with the set air flow rate and pressure loss of the duct connected.
Select No.1-10 (10Pa-100Pa) from following table according to calculation result.
Refer to technical manual for details of air flow characteristic.

Setting No.	1	2	3	4	5	6	7	8	9	10
External Static Pressure (Pa)	10	20	30	40	50	60	70	80	90	100

※ When you set No.11-19 by remote control, unit will control fan-speed with setting of No.10 Factory default is at No.5.

- How to set E.S.P by wired remote control

- ① Push "◆" marked button(E.S.P button).
 - ② Select indoor unit No. by using ◆ button.
 - ③ Select setting No. by using ◆ button and set E.S.P. by □ button.
- See detailed procedure in technical manual.



Notice

You can NOT set E.S.P. by wireless remote control.

Caution

Be sure to set E.S.P. according to actual duct connected.
Wrong settings causes excessive air flow volume or water drop blown out.

2. AUTOMATIC SETTING

Indoor unit will recognize E.S.P. by itself automatically and select appropriate fan speed No.1-10.

- How to start automatic setting

- ①, ② Same setting as MANUAL SETTING.
- ③ Select [AUT] by using ◆ button and press □ button .
- ② After setting E.S.P. at "AUT", operate unit in FAN mode with certain fan speed (Lo-Uhi).

(b) Replacement procedure of the fan unit

- Notes(1) The unit is a heavy item. It must be supported securely and handled with care not to drop when it is necessary to replace.
 (2) For the maintenance space, refer to page 237.

(i) Model FDUM50VF

- 1) Remove the control box and the side panel, and remove the screws marked in the circles (2 places) in the figure.

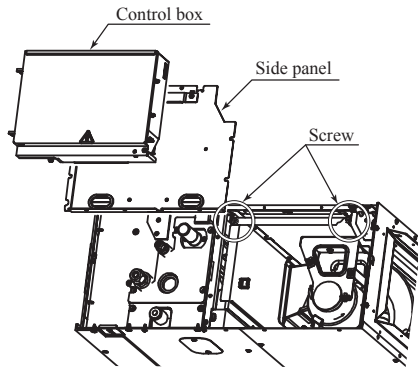

- 2) Take out the fan unit in the arrow direction.

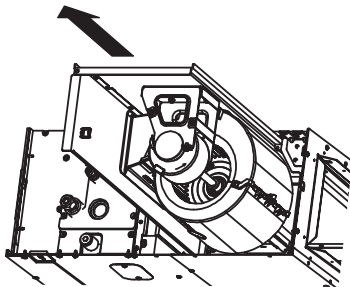

(ii) Models FDUM60VF, 71VF1

- 1) Remove the control box and the side panel, and remove the screws marked in the circles (2 places) in the figure.

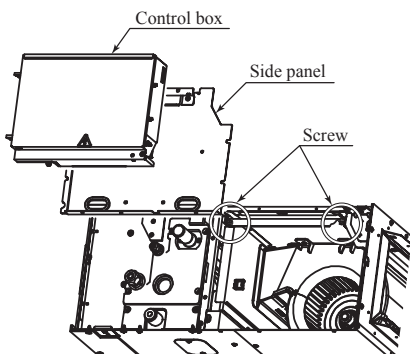

- 2) Take out the fan unit in the arrow direction.

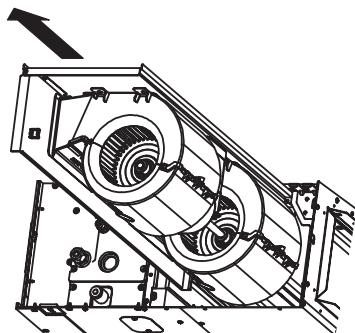

(iii) Models FDUM100VF1, 125VF, 140VF, 100VF2

- 1) Remove the control box and the side panel, and remove the screws marked in the circles (2 places) from the unit located at the near side.

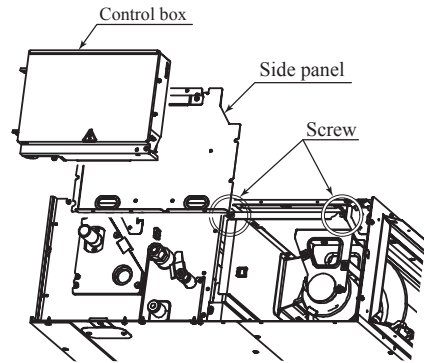

- 2) Take out the fan unit located at the near side in the arrow direction.

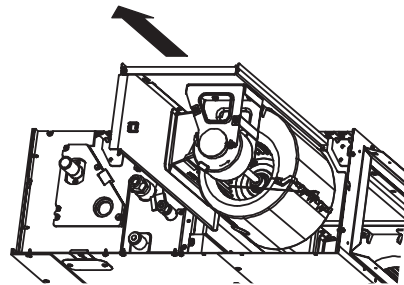

- 3) Remove the screws marked in the circles (2 places) from the fan unit located at the far side.

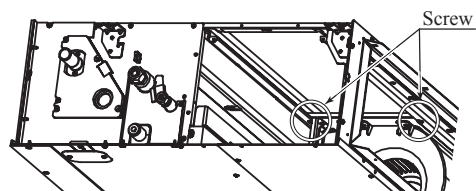

- 4) Take out the fan unit in the arrow direction.

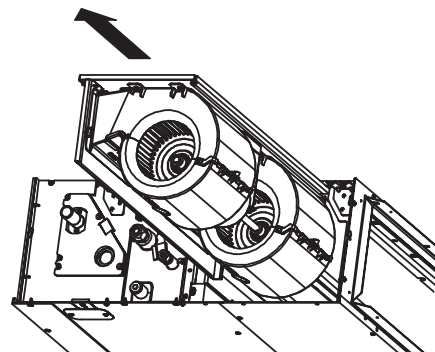

(6) Floor standing type (FDF)

This manual is for the installation of an indoor unit.
 For electrical wiring work (Indoor), refer to page 259. For remote control installation, refer to page 263.
 For wireless kit installation, refer to page 523. For electrical wiring work (Outdoor) and refrigerant pipe work installation for outdoor unit, refer to Page 277.

SAFETY PRECAUTIONS

- Read the "SAFETY PRECAUTIONS" carefully first of all and then strictly follow it during the installation work in order to protect yourself.
- The precautionary items mentioned below are distinguished into two levels, **⚠️ WARNING** and **⚡ CAUTION**.
⚠️ WARNING: Wrong installation would cause serious consequences such as injuries or death.
⚡ CAUTION: Wrong installation might cause serious consequences depending on circumstances.
 Both mentions the important items to protect your health and safety so strictly follow them by any means.
 The meanings of "Marks" used here are as shown on the right:
 Ⓜ️ Never do it under any circumstances. Ⓜ️ Always do it according to the instruction.
- After completing the installation, do commissioning to confirm there are no abnormalities, and explain to the customers about "SAFETY PRECAUTIONS", correct operation method and maintenance method (air filter cleaning, operation method and temperature setting method) with user's manual of this unit.
 Ask your customers to keep this installation manual together with the user's manual. Also, ask them to hand over the user's manual to the new user when the owner is changed.

⚠️ WARNING

- **Installation should be performed by the specialist.** ⚡
 If you install the unit by yourself, it may lead to serious trouble such as water leakage, electric shock, fire, and injury due to overturn of the unit.
- **Install the system correctly according to these installation manuals.** ⚡
 Improper installation may cause explosion, injury, water leakage, electric shock, and fire.
- **Check the density referred by the formula (accordance with ISO5149).** ⚡
 If the density exceeds the limit density, please consult the dealer and installate the ventilation system.
- **Use the genuine accessories and the specified parts for installation.** ⚡
 If parts unspecified by our company are used it could cause water leakage, electric shock, fire, and injury due to overturn of the unit.
- **Ventilate the working area well in case the refrigerant leaks during installation.** ⚡
 If the refrigerant contacts the fire, toxic gas is produced.
- **Install the unit in a location that can hold heavy weight.** ⚡
 Improper installation may cause the unit to fall leading to accidents.
- **Install the unit properly in order to be able to withstand strong winds such as typhoons, and earthquakes.** ⚡
 Improper installation may cause the unit to fall leading to accidents.
- **Do not mix air in to the cooling cycle on installation or removal of the air conditioner.** ⚡
 If air is mixed in, the pressure in the cooling cycle will rise abnormally and may cause explosion and injuries.
- **Be sure to have the electrical wiring work done by qualified electrical installer, and use exclusive circuit.** ⚡
 Power source with insufficient capacity and improper work can cause electric shock and fire.
- **Use specified wire for electrical wiring, fasten the wiring to the terminal securely, and hold the cable securely in order not to apply unexpected stress on the terminal.** ⚡
 Loose connections or hold could result in abnormal heat generation or fire.
- **Arrange the electrical wires in the control box properly to prevent them from rising, Fit the lid of the services panel properly.** ⚡
 Improper fitting may cause abnormal heat and fire.
- **Check for refrigerant gas leakage after installation is completed.** ⚡
 If the refrigerant gas leaks into the house and comes in contact with a fan heater, a stove, or an oven, toxic gas is produced.
- **Use the specified pipe, flare nut, and tools for R410A.** ⚡
 Using existing parts (R22) could cause the unit failure and serious accident due to explosion of the cooling cycle.
- **Tighten the flare nut according to the specified method by with torque wrench.** ⚡
 If the flare nut were tightened with excess torque, it could cause burst and refrigerant leakage after a long period.
- **Do not put the drainage pipe directly into drainage channels where poisonous gases such as sulfide gas can occur.** ⚡
 Poisonous gases will flow into the room through drainage pipe and seriously affect the user's health and safety. This can also cause the corrosion of the indoor unit and a resultant unit failure or refrigerant leak.
- **Connect the pipes for refrigeration circuit securely in installation work before compressor is operated.** ⚡
 If the compressor is operated when the service valve is open without connecting the pipe, it could cause explosion and injuries due to abnormal high pressure in the system.
- **Stop the compressor before removing the pipe after shutting the service valve on pump down work.** ⚡
 If the pipe is removed when the compressor is in operation with the service valve open, air would be mixed in the refrigeration circuit and it could cause explosion and injuries due to abnormal high pressure in the cooling cycle.
- **Only use prescribed optional parts. The installation must be carried out by the qualified installer.** ⚡
 If you install the system by yourself, it can cause serious trouble such as water leaks, electric shocks, fire.
- **Do not repair by yourself. And consult with the dealer about repair.** ⚡
 Improper repair may cause water leakage, electric shock or fire.
- **Consult the dealer or a specialist about removal of the air conditioner.** ⚡
 Improper installation may cause water leakage, electric shock or fire.
- **Turn off the power source during servicing or inspection work.** ⚡
 If the power is supplied during servicing or inspection work, it could cause electric shock and injury by the operating fan.
- **Do not run the unit when the panel or protection guard are taken off.** ⚡
 Touching the rotating equipment, hot surface, or high voltage section could cause an injury to be caught in the machine, to get burned, or electric shock.
- **Shut off the power before electrical wiring work.** ⚡
 It could cause electric shock, unit failure and improper running.

⚡ CAUTION

- **Perform earth wiring surely.** ⚡
 Do not connect the earth wiring to the gas pipe, water pipe, lightning rod and telephone earth wiring. Imperfect earth work (grounding) could cause an electric shock or fire if some trouble or earth leakage occurs.
- **Earth leakage breaker must be installed.** ⚡
 Unless the earth leakage circuit breaker is provided, if it could cause a fire or electric shock.
- **Use the circuit breaker of correct capacity. Circuit breaker should be the one that disconnect all poles under over current.** ⚡
 Using the incorrect one could cause the system failure and fire.
- **Do not use any materials other than a fuse of correct capacity where a fuse should be used.** ⚡
 Connecting the circuit by wire or copper wire could cause unit failure and fire.
- **Do not install the indoor unit near the location where there is possibility of flammable gas leakages.** ⚡
 If the gas leaks and gathers around the unit, it could cause fire.
- **Do not install and use the unit where corrosive gas (such as sulfurous acid gas etc.) or flammable gas (such as thinner, petroleum etc.) may be generated or accumulated, or volatile flammable substances are handled.** ⚡
 It could cause the corrosion of heat exchanger, breakage of plastic parts etc. And inflammable gas could cause fire.
- **Secure a space for installation, inspection and maintenance specified in the manual.** ⚡
 Insufficient space can result in accident such as personal injury due to falling from the installation place.
- **Do not use the indoor unit at the place where water splashes such as laundry.** ⚡
 Indoor unit is not waterproof. It could cause electric shock and fire.
- **Do not use the indoor unit for a special purpose such as food storage, cooling for precision instrument, preservation of animals, plants, and a work of art.** ⚡
 It could cause the damage of the items.
- **Do not install nor use the system near equipments which generate electromagnetic wave or high harmonics.** ⚡
 Equipments like inverter equipment, private power generator, high-frequency medical equipment, or telecommunication equipment might influence the air conditioner and cause a malfunction and breakdown. Or the air conditioner might influence medical equipments or telecommunication equipments, and obstruct their medical activity or cause jamming.
- **Do not install the remote control at the direct sunlight.** ⚡
 It could cause breakdown or deformation of the remote control.
- **Do not install the indoor unit at the place listed below.** ⚡
 - Places where flammable gas could leak.
 - Places where carbon fiber, metal powder or any powder is floated.
 - Place where the substances which affect the air conditioner are generated such as sulfide gas, chloride gas, acid, alkali or ammoniac atmospheres.
 - Places exposed to oil mist or steam directly.
 - On vehicles and ships
 - Places where machinery which generates high harmonics is used.
 - Places where cosmetics or special sprays are frequently used.
 - Highly salted area such as beach.
 - Heavy snow area
 - Places where the system is affected by smoke from a chimney.
 - Altitude over 1000m
- **Do not install the indoor unit in the locations listed below (Be sure to install the indoor unit according to the installation manual for each model because each indoor unit has each limitation)** ⚡
 - Locations with any obstacles which can prevent inlet and outlet air of the unit
 - Locations where vibration can be amplified due to insufficient strength of structure.
 - Locations where the infrared receiver is exposed to the direct sunlight or the strong light beam. (in case of the infrared specification unit)
 - Locations where an equipment affected by high harmonics is placed. (TV set or radio receiver is placed within 5m)
 - Locations where drainage cannot run off safely.
 - It can affect performance or function and etc..
- **Do not put any valuables which will break down by getting wet under the air conditioner.** ⚡
 Condensation could drop when the relative humidity is higher than 80% or drain pipe is clogged, and it damages user's belongings.
- **Do not use the base frame for the outdoor unit which is corroded or damaged after a long period of use.** ⚡
 It could cause the unit falling down and injury.
- **Pay attention not to damage the drain pan by weld sputter when brazing work is done near the unit.** ⚡
 If sputter entered into the unit during brazing work, it could cause damage (pinhole) of drain pan and leakage of water. To avoid damaging, keep the indoor unit packed or cover the indoor unit.
- **Install the drain pipe to drain the water surely according to the installation manual.** ⚡
 Improper connection of the drain pipe may cause dropping water into room and damaging user's belongings.
- **Do not share the drain pipe for indoor unit and GHP (Gas Heat Pump system) outdoor unit.** ⚡
 Toxic exhaust gas would flow into room and it might cause serious damage (some poisoning or deficiency of oxygen) to user's health and safety.
- **Be sure to perform air tightness test by pressurizing with nitrogen gas after completed refrigerant piping work.** ⚡
 If the density of refrigerant exceeds the limit in the event of refrigerant leakage in the small room, lack of oxygen can occur, which can cause serious accidents.
- **For drain pipe installation, be sure to make descending slope of greater than 1/100, not to make traps, and not to make air-bleeding.** ⚡
 Check if the drainage is correctly done during commissioning and ensure the space for inspection and maintenance.
- **Ensure the insulation on the pipes for refrigeration circuit so as not to condense water.** ⚡
 Incomplete insulation could cause condensation and it would wet ceiling, floor, and any other valuables.
- **Do not install the outdoor unit where is likely to be a nest for insects and small animals.** ⚡
 Insects and small animals could come into the electronic components and cause breakdown and fire. Instruct the user to keep the surroundings clean.
- **Pay extra attention, carrying the unit by hand.** ⚡
 Carry the unit with 2 people if it is heavier than 20kg. Do not use the plastic straps but the grabbing place, moving the unit by hand. Use protective gloves in order to avoid injury by the aluminum fin.
- **Make sure to dispose of the packaging material.** ⚡
 Leaving the materials may cause injury as metals like nail and woods are used in the package.
- **Do not operate the system without the air filter.** ⚡
 It may cause the breakdown of the system due to clogging of the heat exchanger.
- **Do not touch any button with wet hands.** ⚡
 It could cause electric shock.
- **Do not touch the refrigerant piping with bare hands when in operation.** ⚡
 The pipe during operation would become very hot or cold according to the operating condition, and it could cause a burn or frostbite.
- **Do not clean up the air conditioner with water.** ⚡
 It could cause electric shock.
- **Do not turn off the power source immediately after stopping the operation.** ⚡
 Be sure to wait for more than 5 minutes. Otherwise it could cause water leakage or breakdown.
- **Do not control the operation with the circuit breaker.** ⚡
 It could cause fire or water leakage. In addition, the fan may start operation unexpectedly and it may cause injury.

① Before installation

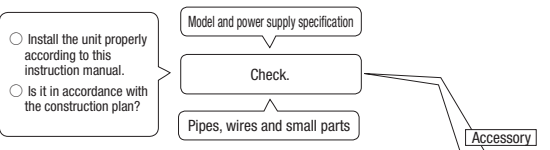

(1) For heat insulation of flare nut *1		(2) For installation Note) Nos. 1 and 5 are used also as hardware for packing.	
1	Pipe cover	1	Fall-prevention fitting
2	Pipe cover	2	Wood screw
3	Strap	2	Washer
		1	Rubber bushing
		2	L fitting

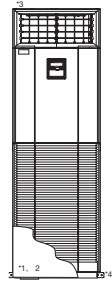

Where the accessories are put in

- *1. Open the air inlet grill and Nos. (1) will be found in the unit.
- *2. Nos. (2)-2-4 will be found at the same place as 1.
- *3. Fall-prevention fitting is mounting on the top panel of the unit.
- *4. L-fittings are mounted on the bottom part of the unit.

② Selection of installation place for the indoor unit

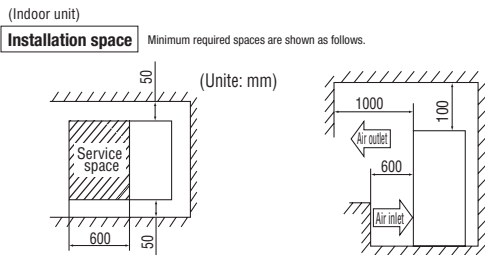

- Secure sufficient spaces for inspection and maintenance.

WARNING

- Install the unit securely on a floor that can endure its weight sufficiently. Insufficient strength or incorrect installation could result in injuries if the unit falls.

ATTENTION:

- Select a place for installation where the following conditions are fulfilled with customer's consent.
- Where cool or hot air can be blown sufficiently and widely.
- Where the piping and wiring work to outdoor unit can be done easily.
- Where drainage water can run off completely.
- Where the installation floor is strong enough.
- Where the unit is protected from direct exposure to sunlight.
- Where there is no obstacle at the air inlet and air outlet.
- Where the fire alarm apparatus will not be activated by malfunction.
- Where there is no risk for short-circuit of air.

③ Carrying-in and installation of the unit

Carrying-in



ATTENTION:

- Carry in the unit kept in a package as near as possible to the installation place.
- When it is necessary to unpack the unit before carrying in, sufficient care must be taken not to damage it by using nylon slings or the like. Note) Do not hold on the air inlet grill, air outlet louver or other sections made of plastics.
- When placing the unit on the floor after unpacking, be sure to have its front face at the top.

③ Carrying-in and installation of the unit (Continued)

ATTENTION:

- Be sure to fix the unit with L-fittings and the fall-prevention fitting.
- Since the unit is tall, secure the unit no sooner than setting it in place.

Procedure for preventing the unit from falling

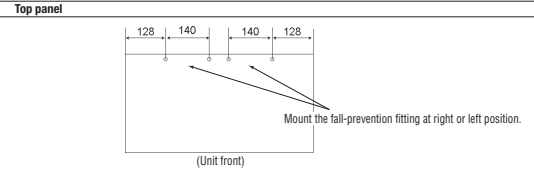
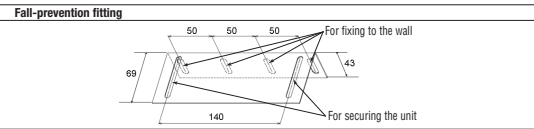
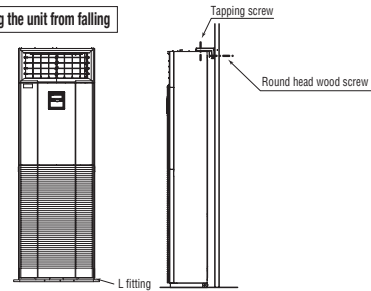

(1) Fixing the unit with the fall-prevention fitting

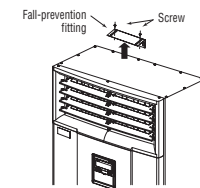

- Loosen screws (2 pcs) and remove the fall-prevention fitting.
 - Select a position to fix the fall-prevention fitting as illustrated and fix it to the top of unit and the wall.
- The fixing position of the fall-prevention fitting is as illustrated below.

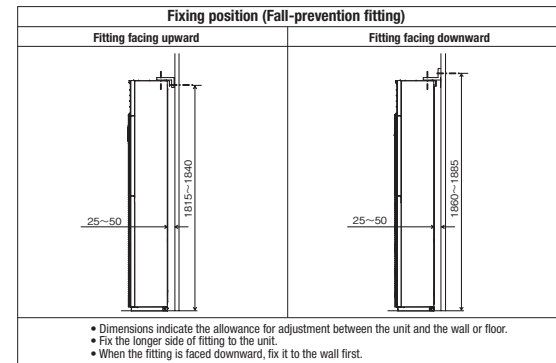

(2) Fixing the unit with the L-fittings

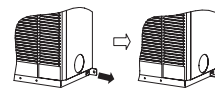

- Remove the L-fittings mounted on the unit with screws.
 - Turn over the L-fitting and fix it to the unit and either the floor or the wall as illustrated.
- Fixing position of the L-fittings are as illustrated below.

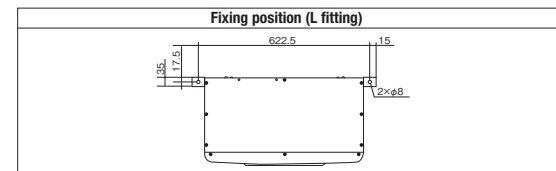

ATTENTION:

- Install the unit on the level.
- Inclination must be less than 1° in fore-aft and right-left directions.

④ Refrigerant piping

Caution

- Use the new refrigerant pipe.
When re-using the existing pipe system for R22 or R407C, pay attention to the following items.
 - Change the flare nuts with the attached ones (JIS category 2), and reprocess the flare parts.
 - Do not use thin-walled pipes.
- Use phosphorus deoxidized copper alloy seamless pipe (C1220T specified in JIS H3300) for refrigeration pipe installation.
In addition, make sure there is no damage both inside and outside of the pipe, and no harmful substances such as sulfur, oxide, dust or a contaminant stuck on the pipes.
- Do not use any refrigerant other than R410A.
Using other refrigerant except R410A (R22 etc.) may degrade inside refrigeration oil. And if air getting into refrigerant circuit, it may cause anomalously high pres and may result in burst, etc.
- Store the copper pipes indoors and seal the both end of them until they are brazed in order to avoid any dust, dirt or water getting into pipe. Otherwise it will cause degradation of refrigeration oil and compressor breakdown, etc.
- Use special tools for R410A refrigerant.

Work procedure

1. Remove the flare nuts and flare caps from the pipes of the indoor unit.
 - ※ Make sure to loosen the flare nut by holding the flared male fitting with a spanner and giving torque to the nut with another spanner in order to avoid unexpected stress to the copper pipe, and then remove them.
(Gas may come out a little at this time, but it is no anomaly.)
 - Pay attention that the flare nut may pop out.
(Because it is sometimes pressurized in the indoor unit)
2. Make a flare on liquid pipe and gas pipe, and connect the refrigerant pipes to the indoor unit.
 - ※ Bend the pipe with as big radius as possible and do not bend the pipe repeatedly. In addition, do not twist and crush the pipes.
 - ※ Do a flare connection as follows:
 - Make sure to loosen the flare nut by holding the flared male fitting with a spanner and giving torque to the nut with another spanner in order to avoid unexpected stress to the copper pipe, and then remove them.
 - When fastening the flare nut, align the refrigeration pipe with the center of flare nut, screw the nut for 3-4 times by hand and then tighten it with a spanner within the specified torque mentioned in the table below.
Make sure to hold the flared male fitting on the indoor unit side with another spanner when tightening the nut in order to avoid unexpected stress on the copper pipe.
3. Cover the flare connection part of the indoor unit with attached insulation material after a gas leakage inspection, and tighten both ends with attached straps.
 - Make sure to insulate both gas pipes and liquid pipes completely.
※ Incomplete insulation may cause dew condensation and dew dropping.
4. Refrigerant is pre-charged in the outdoor unit.
As for the additional refrigerant charge for the indoor unit and piping, refer to the installation manual attached to the outdoor unit.

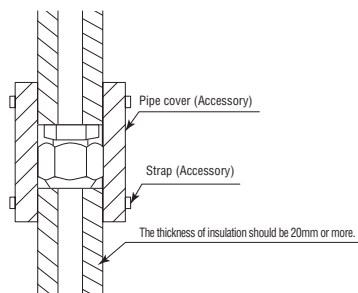

Pipe diameter	Tightening torque N·m
φ 6.35	14 to 18
φ 9.52	34 to 42
φ 12.7	49 to 61
φ 15.88	68 to 82
φ 19.05	100 to 120

④ Refrigerant piping (Continued)

◆ Pipe and wire extracting position

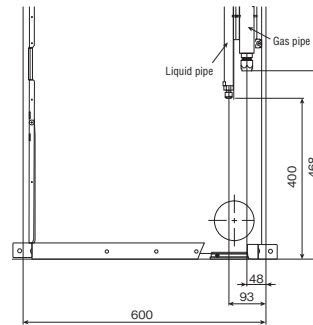

ATTENTION:

- Do not cut off the flange at the hole on the base plate for the downward extraction.



Downward extraction

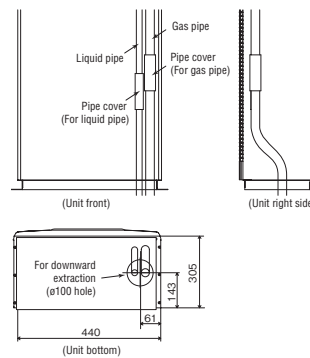

Backward extraction

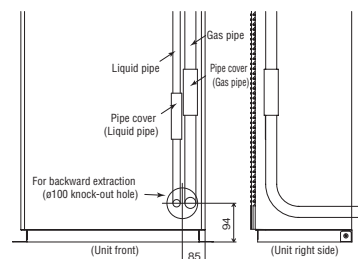

Sideward extraction

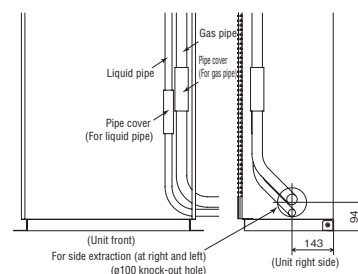

⑤ Drain pipe

⚠ WARNING

- Do not insert the drain pipe directly in the drain ditch where toxic gases such as sulfuric gas are produced. Toxic gas may flow into the room.

⚠ CAUTION

- Install the drain pipe properly according to the installation manual. Insulate it to prevent from dew condensation. Improper installation of drain pipe may cause damage of furniture drainage water leaked or dew condensation.

Procedure

- Connect the drain socket to the drain pipe (PV-20) provided at site and fix the joint with adhesive tape, or the like.
- When the pipe provided at site runs through a room, insulate the pipe with a commercial insulator (Polyethylene foam: Specific gravity 0.03, thickness 15 mm or more) to prevent dewing.

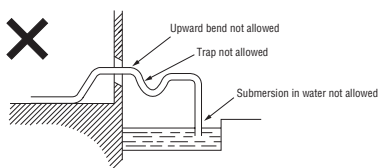
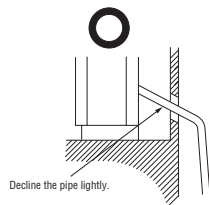
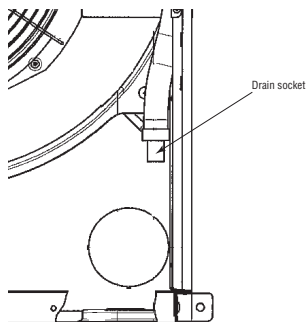

ATTENTION:

- Insulate the drain pipe to prevent dewing. (Especially in room and unit)
- Incline the drain pipe downward to the outlet (1/50 – 1/100). Upward bend or trap is not allowed on the way.
- Use a commercial hard polyvinyl chloride pipe, PV-20, for the drain pipe. <Use of adhesive agent is prohibited.>

⑥ Wire extracting position and wire connecton

Control box position and power cable connection

- Electric work must be made by qualified electricians according to the "Engineering standards concerning electric equipment", "Extension wiring regulations" and the electric wiring work manual. Be sure to use dedicated electric circuits.
- Make sure to use specified wires for wiring, and connect them securely. Clamp the wires to protect the terminal connection from external force.
- Make sure to protect the unit with the D-type grounding work.
- For details of wiring work, refer to the attached electric wiring work manual.

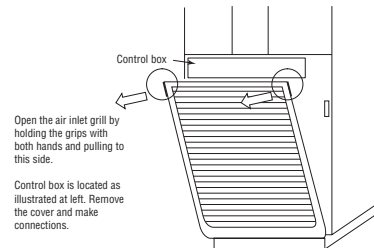

Procedure

- Remove the control box cover (fixed with a screw).
- Introduce wires in the unit and connect securely on the terminals.
- Fix each wire with a clamp (for fixing).
- Install removed parts as they were.

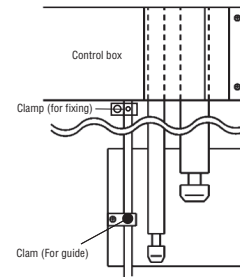

- Make sure to pass the power cable through the clamp (for guide).

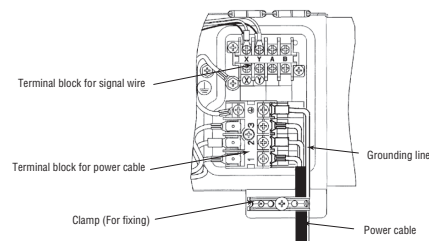

⑦ Check list after installation

- Check the following items after all installation work completed.

Check if:	Expected trouble	Check
The indoor and outdoor units are fixed securely?	Falling, vibration, noise	
Inspection for gas leakage is done?	Insufficient capacity	
Insulation work is properly done?	Water leakage	
Water is drained properly?	Water leakage	
Supply voltage is same as mentioned in the model name plate?	PCB burnt out, not working at all	
There is mis-wiring or mis-connection of piping?	PCB burnt out, not working at all	
Earth wiring is connected properly?	Electric shock	
Cable size comply with specified size?	PCB burnt out, not working at all	
Any obstacle blocks airflow on air inlet and outlet?	Insufficient capacity	

(7) Wall mounted type (SRK)

RYK012A01

- This installation manual illustrates the method of installing an indoor unit.
- For electrical wiring work, please see instructions set out on the backside.
- For outdoor unit installation and refrigerant piping, please refer to page 277.



- A wired remote control unit is supplied separately as an optional part.
- When install the unit, be sure to check whether the selection of installation place, power supply specifications, usage limitation (piping length, height differences between indoor and outdoor units, power supply voltage and etc.) and installation spaces.







SAFETY PRECAUTIONS

- Read the "SAFETY PRECAUTIONS" carefully first of all and strictly follow it during the installation work in order to protect yourself.
 - The precautionary items mentioned below are distinguished into two levels, **WARNING** and **CAUTION**.
WARNING: Wrong installation would cause serious consequences such as injuries or death.
CAUTION: Wrong installation might cause serious consequences depending on circumstances.
- Both mentions the important items to protect your health and safety so strictly follow them by any means.
- Be sure to confirm no anomaly on the equipment by commissioning after completed installation and explain the operating methods as well as the maintenance methods of this equipment to the user according to the owner's manual.

- Keep the installation manual together with owner's manual at a place where any user can read at any time. Moreover if necessary, ask to hand them to a new user.
- For installing qualified personnel, take precautions in respect to themselves by using suitable protective clothing, groves, etc., and then perform the installation works.
- Please pay attention not to fall down the tools, etc. when installing the unit at the high position.
- If unusual noise can be heard during operation, consult the dealer.
- The meanings of "Marks" used here are shown as follows:



 WARNING	
<p> Installation must be carried out by the qualified installer. If you install the system by yourself, it may cause serious trouble such as water leaks, electric shocks, fire and personal injury, as a result of a system malfunction. Do not carry out the installation and maintenance work except the by qualified installer.</p> <p>Install the system in full accordance with the installation manual. Incorrect installation may cause bursts, personal injury, water leaks, electric shocks and fire.</p> <p>Be sure to use only for household and residence. If this appliance is installed in inferior environment such as machine shop and etc., it can cause malfunction.</p> <p>Use the original accessories and the specified components for installation. If parts other than those prescribed by us are used, it may cause water leaks, electric shocks, fire and personal injury.</p> <p>Install the unit in a location with good support. Unsuitable installation locations can cause the unit to fall and cause material damage and personal injury.</p> <p>Ventilate the working area well in the event of refrigerant leakage during installation. If the refrigerant comes into contact with naked flames, poisonous gas is produced.</p> <p>When installing in small rooms, take prevention measures not to exceed the density limit of refrigerant in the event of leakage, referred by the formula (accordance with ISO5149). If the density of refrigerant exceeds the limit, please consult the dealer and install the ventilation system, otherwise lack of oxygen can occur, which can cause serious accident.</p> <p>After completed installation, check that no refrigerant leaks from the system. If refrigerant leaks into the room and comes into contact with an oven or other hot surface, poisonous gas is produced.</p> <p>Use the prescribed pipes, flare nuts and tools for R410A. Using existing parts (for R22 or R407C) can cause the unit failure and serious accidents due to burst of the refrigerant circuit.</p>	<p>Tighten the flare nut by torque wrench with specified method. If the flare nut were tightened with excess torque, this may cause burst and refrigerant leakage after a long period.</p> <p>The electrical installation must be carried out by the qualified electrician in accordance with "the norm for electrical work" and "national wiring regulation", and the system must be connected to the dedicated circuit. Power supply with insufficient capacity and incorrect function done by improper work can cause electric shocks and fire.</p> <p>Be sure to shut off the power before starting electrical work. Failure to shut off the power can cause electric shocks, unit failure or incorrect function of equipment.</p> <p>Be sure to use the cables conformed to safety standard and cable ampacity for power distribution work. Unconformable cables can cause electric leak, anomalous heat production or fire.</p> <p>This appliance must be connected to main power supply by means of a circuit breaker or switch (fuse:16A) with a contact separation of at least 3mm.</p> <p>When plugging this appliance, a plug conforming to the norm IEC60884-1 must be used.</p> <p>Use the prescribed cables for electrical connection, tighten the cables securely in terminal block and relieve the cables correctly to prevent overloading the terminal blocks. Loose connections or cable mountings can cause anomalous heat production or fire.</p> <p>Arrange the wiring in the control box so that it cannot be pushed up further into the box. Install the service panel correctly. Incorrect installation may result in overheating and fire.</p> <p>Be sure to switch off the power supply in the event of installation, inspection or servicing. If the power supply is not shut off, there is a risk of electric shocks, unit failure or personal injury due to the unexpected start of fan.</p> <p>Be sure to wear protective goggles and gloves while at work.</p> <p>Earth leakage breaker must be installed. If the earth leakage breaker is not installed, it can cause electric shocks.</p>
<p> Do not put the drainage pipe directly into drainage channels where poisonous gases such as sulphide gas can occur. Poisonous gases will flow into the room through drainage pipe and seriously affect the user's health and safety. This can also cause the corrosion of the indoor unit and a resultant unit failure or refrigerant leak.</p> <p>Ensure that no air enters in the refrigerant circuit when the unit is installed and removed. If air enters in the refrigerant circuit, the pressure in the refrigerant circuit becomes too high, which can cause burst and personal injury.</p>	<p>Do not processing, splice the power cord, or share a socket with other power plugs. This may cause fire or electric shock due to defecting contact, defecting insulation and over-current etc.</p> <p>Do not bundling, winding or processing for the power cord. Or, do not deforming the power plug due to treat it. This may cause fire or heating.</p>

 WARNING	
<p> Do not vent R410A into the atmosphere: R410A is a fluorinated greenhouse gas, covered by the Kyoto Protocol with GWP=1975.</p> <p>Do not run the unit with removed panels or protections. Touching rotating equipments, hot surfaces or high voltage parts can cause personal injury due to entrapment, burn or electric shocks.</p>	<p>Do not perform any change of protective device itself or its setup condition. The forced operation by short-circuiting protective device of pressure switch and temperature controller or the use of non specified component can cause fire or burst.</p>
 CAUTION	
<p> Carry out the electrical work for ground lead with care. Do not connect the ground lead to the gas line, water line, lightning conductor or telephone line's ground lead. Incorrect grounding can cause unit faults such as electric shocks due to short-circuiting.</p>	<p> Use the circuit breaker of correct capacity. Circuit breaker should be the one that disconnect all poles under over current. Using the incorrect one could cause the system failure and fire.</p> <p>Install isolator or disconnect switch on the power supply wiring in accordance with the local codes and regulations. The isolator should be locked in OFF state in accordance with EN60204-1.</p> <p>Be sure to install indoor unit properly according to the installation manual in order to run off the drainage smoothly. Improper installation of indoor unit can cause dropping water into the room and damaging personal property.</p> <p>Install the drainage pipe to run off drainage securely according to the installation manual. Incorrect installation of the drainage pipe can cause dropping water into the room and damaging personal property.</p> <p>Be sure to install the drainage pipe with descending slope of 1/100 or more, and not to make traps and air-bleedings. Check if the drainage runs off securely during commissioning and ensure the space for inspection and maintenance.</p> <p>Secure a space for installation, inspection and maintenance specified in the manual. Insufficient space can result in accident such as personal injury due to</p>
<p> Do not install the unit in the locations listed below.</p> <ul style="list-style-type: none"> • Locations where carbon fiber, metal powder or any powder is floating. • Locations where any substances that can affect the unit such as sulphide gas, chloride gas, acid and alkaline can occur. • Vehicles and ships. • Locations where cosmetic or special sprays are often used. • Locations with direct exposure of oil mist and steam such as kitchen and machine plant. • Locations where any machines which generate high frequency harmonics are used. • Locations with salty atmospheres such as coastlines. • Locations with heavy snow (If installed, be sure to provide base flame and snow hood mentioned in the manual). • Locations where the unit is exposed to chimney smoke. • Locations at high altitude (more than 1000m high). • Locations with ammoniac atmospheres. • Locations where heat radiation from other heat source can affect the unit. • Locations without good air circulation. • Locations with any obstacles which can prevent inlet and outlet air of the unit. • Locations where short circuit of air can occur (in case of multiple units installation). • Locations where strong air blows against the air outlet of outdoor unit. • Locations where something located above the unit could fall. • Locations where remarkable decrease in performance, corrosion and damage of components, malfunction and fire. <p>Do not install the indoor unit in the locations listed below (Be sure to install the indoor unit according to the installation manual for each model because each indoor unit has each limitation).</p> <ul style="list-style-type: none"> • Locations with any obstacles which can prevent inlet and outlet air of the unit. • Locations where vibration can be amplified due to insufficient strength of structure. • Locations where the infrared receiver is exposed to the direct sunlight or the strong light beam (in case of the infrared specification unit). • Locations where an equipment affected by high harmonics is placed (TV set or radio receiver is placed within 1m). • Locations where drainage cannot run off safely. <p>It can affect performance or function and etc.</p> <p>Do not install the unit near the location where leakage of combustible gases can occur.</p>	<p>falling from the installation place.</p> <ul style="list-style-type: none"> • For installation work, be careful not to get injured with the heat exchanger, piping flare portion or screws etc. • Be sure to insulate the refrigerant pipes so as not to condense the ambient air moisture on them. Insufficient insulation can cause condensation, which can lead to moisture damage on the ceiling, floor, furniture and any other valuables. • When perform the air conditioner operation (cooling or drying operation) in which ventilator is installed in the room. In this case, using the air conditioner in parallel with the ventilator, there is the possibility that drain water may backflow in accordance with the room lapse into the negative pressure status. Therefore, set up the opening port such as incorporate the air into the room that may appropriate to ventilation (For example; Open the door a little). In addition, just as above, so set up the opening port if the room lapse into negative pressure status due to register of the wind for the high rise apartment etc. • Be sure to perform air tightness test by pressurizing with nitrogen gas after completed refrigerant piping work. If the density of refrigerant exceeds the limit in the event of refrigerant leakage in the small room, lack of oxygen can occur, which can cause serious accidents. <p>If leaked gases accumulate around the unit, it can cause fire.</p> <ul style="list-style-type: none"> • Do not install the unit where corrosive gas (such as sulfuric acid gas etc.) or combustible gas (such as thinner and petroleum gases) can accumulate or collect, or where volatile combustible substances are handled. Corrosive gas can cause corrosion of heat exchanger, breakage of plastic parts and etc. And combustible gas can cause fire. • Do not use the indoor unit at the place where water splashes may occur such as in laundries. Since the indoor unit is not waterproof, it can cause electric shocks and fire. • Do not install nor use the system close to the equipment that generates electromagnetic fields or high frequency harmonics. Equipment such as inverters, standby generators, medical high frequency equipments and telecommunication equipments can affect the system, and cause malfunctions and breakdowns. The system can also affect medical equipment and telecommunication equipment, and obstruct its function or cause jamming. • Do not place any variables which will be damaged by getting wet under the indoor unit. When the relative humidity is higher than 80% or drainage pipe is clogged, condensation or drainage water can drop and it can cause the damage of valuables. • Do not install the remote control at the direct sunlight. It can cause malfunction or deformation of the remote control. • Do not use the unit for special purposes such as storing foods, cooling precision instruments and preservation of animals, plants or art. It can cause the damage of the items. • Do not use any materials other than a fuse with the correct rating in the location where fuses are to be used. Connecting the circuit with copper wire or other metal thread can cause unit failure and fire. • Do not touch any buttons with wet hands. It can cause electric shocks. • Do not touch any refrigerant pipes with your hands when the system is in operation. During operation the refrigerant pipes become extremely hot or extremely cold depending the operating condition, and it can cause burn injury or frost injury.

BEFORE INSTALLATION

○ Before installation check that the power supply matches the air conditioner.

Standard accessories (Installation kit)		Q'ty
Accessories for indoor unit		
①	Installation board (Attached to the rear of the indoor unit)	1
②	Wireless remote control	1
③	Remote control holder	1
④	Tapping screws (for installation board $\phi 4 \times 25\text{mm}$)	4
⑤	Wood screws (for remote control switch holder $\phi 3.5 \times 16\text{mm}$)	2
⑥	Battery [R03 (AAA, Micro) 1.5V]	2
⑦	Air-cleaning filters	2
⑧	Filter holders (Attached to the front panel of indoor unit)	2
⑨	Insulation (#486 50 x 100 I3)	1

Option parts		Q'ty
a	Sealing plate	
b	Sleeve	1
c	Inclination plate	1
d	Putty	1
e	Drain hose (extension hose)	1
f	Piping cover (for insulation of connection piping)	1

Necessary tools for the installation work	
1	Plus headed driver
2	Knife
3	Saw
4	Tape measure
5	Hammer
6	Spanner wrench
7	Torque wrench (14.0 - 61.0N·m (1.4 - 6.1kgf·m))
8	Hole core drill (65mm in diameter)
9	Wrench key (Hexagon) [4m/m]
10	Flaring tool set (Designed specifically for R410A)
11	Gas leak detector (Designed specifically for R410A)
12	Gauge for projection adjustment (Used when flare is made by using conventional flare tool)
13	Pipe bender

SELECTION OF INSTALLATION LOCATION

(Install at location that meets the following conditions, after getting approval from the customer)

Indoor unit

- Where there is no obstructions to the air flow and where the cooled and heated air can be evenly distributed.
- A solid place where the unit or the wall will not vibrate.
- A place where there will be enough space for servicing. (Where space mentioned below can be secured)
- Where wiring and the piping work will be easy to conduct.
- The place where receiving part is not exposed to the direct rays of the sun or the strong rays of the street lighting.
- A place where it can be easily drained.
- A place separated at least 1m away from the television or the radio. (To prevent interference to images and sounds.)
- Places where this unit is not affected by the high frequency equipment or electric equipment.
- Avoid installing this unit in place where there is much oil mist.
- Places where there is no electric equipment or household under the installing unit.

Wireless remote control

- A place where the air conditioner can be received the signal surely during operating the wireless remote control.
- Places where there is no affected by the TV and radio etc.
- Do not place where exposed to direct sunlight or near heat devices such as a stove.

INSTALLATION OF INDOOR UNIT

Installation of installation board

Look for the inside wall structures (Intermediats support or pillar and firmly install the unit after level surface has been checked.)

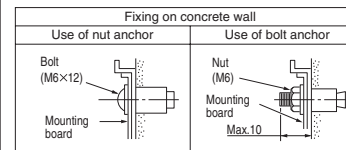
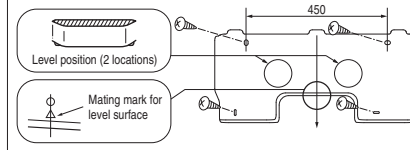

- Adjustment of the installation board in the horizontal direction is to be conducted with four screws in a temporary tightened state.
- Adjust so the board will be level by turning the board with the standard hole as the center.

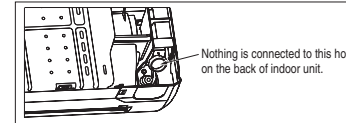
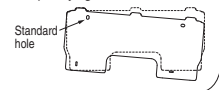

Drilling of holes and fixture of sleeve (Option parts)

When drilling the wall that contains a metal lath, wire lath or metal plate, be sure to use pipe hole sleeve sold separately.

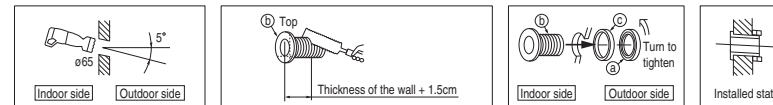

- Drill a hole with whole core drill.
- In case of rear piping draw out, cut off the lower and the right side portions of the sleeve collar.

Installing the support of piping

In case of piping in the right rear direction

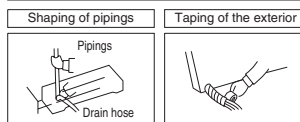

- Hold the bottom of the piping and fix direction before stretching it and shaping it.
- Tape only the portion that goes through the wall.
- Always tape the wiring with the piping.

Sufficient care must be taken not to damage the panel when connecting pipes.

Matters of special notice when piping from left or central/rear of the unit.

[Top view]

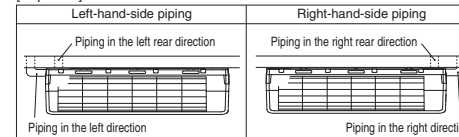

Piping is possible in the rear, left, left rear, left downward, right or downward direction.

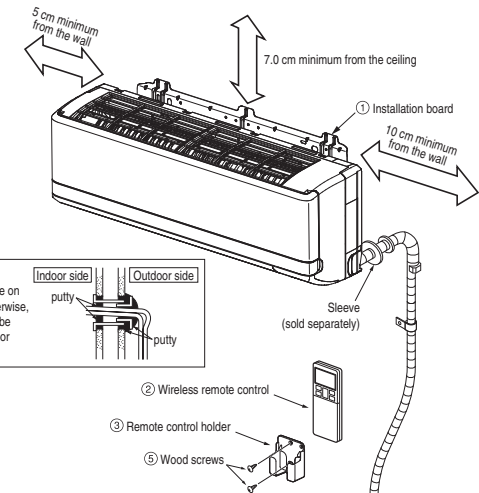
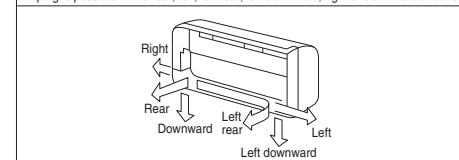

CAUTION

Completely seal the hole on the wall with putty. Otherwise, furniture, or other, may be wetted by leaked water or dewing.

Relation between setting plate and indoor unit

INSTALLATION SPACE (INDOOR UNIT) (FRONT VIEW)

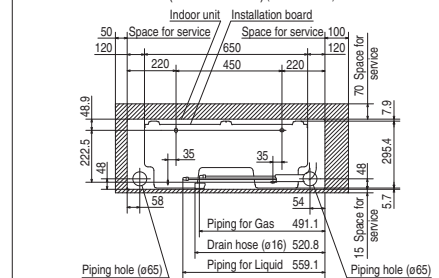

Piping for Liquid (20 to 60 type) : $\phi 6.35$
Piping for Gas (20 to 35 type) : $\phi 9.52$
(50 to 60 type) : $\phi 12.7$

(Unit : mm)

[Drain hose changing procedures]

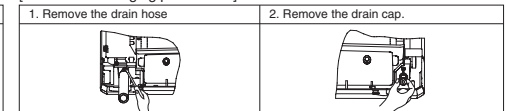

- Remove the screw and drain hose, making it rotate.
- Remove it with hand or pliers.

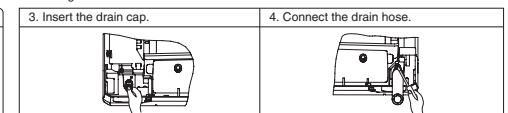

- Insert the drain cap which was removed at procedure "2" securely using a hexagonal wrench etc.
 - Insert the drain hose securely, making rotate. And install the screw.
- Note: Be careful that if it is not inserted securely, water leakage may occur.

Fixing of indoor unit

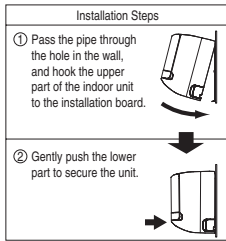
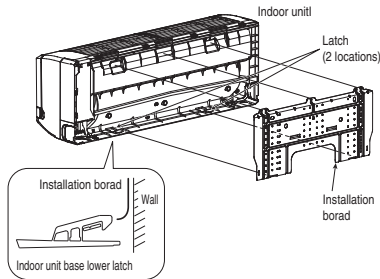

How to remove the indoor unit from the installation board

- 1 Push up at the marked portion of the indoor unit base lower latch, and slightly pull it toward you. (both right and left hand sides) (The indoor unit base lower latch can be removed from the installation board)
- 2 Push up the indoor unit upward. So the indoor unit will be removed from the installation board.

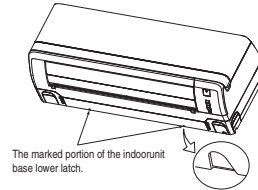

Since this air conditioner has been designed to collect dew drops on the rear surface to the drain pan, do not attach the power cord above the gutter.

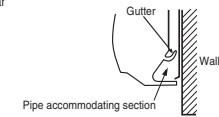

Drainage

- Arrange the drain hose in a downward angle.
- Avoid the following drain piping.

CAUTION Go through all installation steps and check if the drainage is all right. Otherwise water leak may occur.

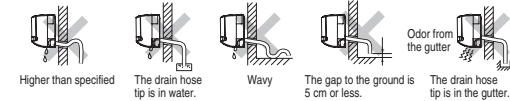

- Pour water to the drain pan located under the heat exchanger, and ensure that the water is discharged outdoor.
- When the extended drain hose is indoor, securely insulate it with a heat insulator available in the market.

CONNECTION OF REFRIGERANT PIPINGS

Preparation Keep the openings of the pipes covered with tapes etc. to prevent dust, sand, etc. from entering them.



- Remove the flared nuts. (on both liquid and gas sides)

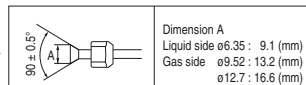

- Install the removed flared nuts to the pipes to be connected, then flared the pipes.

CAUTION
Do not apply refrigerating machine oil to the flared surface.

Flaring work

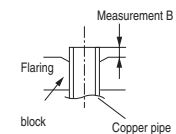

Copper pipe diameter	Clutch type flare tool for R410A	Measurement B (mm)	
		Conventional (R22) flare tool	Clutch type
ø6.35	0.0 - 0.5	1.0 - 1.5	1.5 - 2.0
ø9.52	0.0 - 0.5	1.0 - 1.5	1.5 - 2.0
ø12.7	0.0 - 0.5	1.0 - 1.5	2.0 - 2.5

Use a flare tool designed for R410A or a conventional flare tool.
Please note that measurement B (protrusion from the flaring block) will vary depending on the type of a flare tool in use.
If a conventional flare tool is used, please use a copper pipe gauge or a similar instrument to check protrusion so that you can keep measurement B to a correct value.

Connection

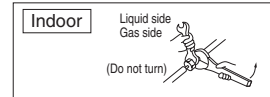

- Connect the pipes on both liquid and gas sides.
- Tighten the nuts to the following torque.
Liquid side (ø6.35) : 14.0 - 18.0 N·m (1.4 - 1.8 kgf·m)
Gas side (ø9.52) : 34.0 - 42.0 N·m (3.4 - 4.2 kgf·m)
(ø12.7) : 49.0 - 61.0 N·m (4.9 - 6.1 kgf·m)

CAUTION
Do not apply excess torque to the flared nuts. Otherwise, the flared nuts may check depending.

Insulation of the connection portion

Cover the coupling with insulator and then cover it with tapes.

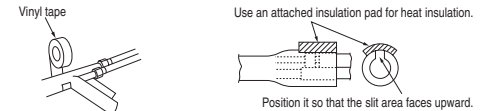

- Cover the indoor unit's flare-connected joints, after they are checked for a gas leak, with an indoor unit heat insulating material and then wrap them with a tape with an attached insulation pad placed over the heat insulating material's slit area.

Finishing work and fixing

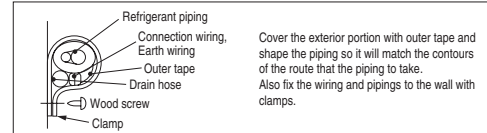

Open/close and detachment/attachment of the air inlet panel

- To open, pull the panel at both ends of lower part and release latches, then pull up the panel until you feel resistance. (The panel stops at approx. 60° open position)
- To close, hold the panel at both ends of lower part to lower downward and push it slightly until the latch works.
- To remove, pull up the panel to the position shown in right illustration and pull it toward you.
- To install, insert the panel arm into the slot on the front panel from the position shown in right illustration, hold the panel at both ends of lower part, lower it downward slowly, then push it slightly until the latch works.

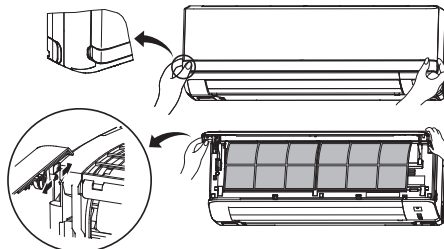

How to remove and fit the front panel

- Removing
 - 1 Remove the air inlet panel.
 - 2 Remove the 5 set screws.
 - 3 Remove the 4 latches in the upper section.
 - 4 Move the lower part of the panel forward and push upwards to remove.
- Fitting
 - 1 Do remove the air filter.
 - 2 Cover the body with the front panel.
 - 3 Fit the 4 latches in the upper section.
 - 4 Tighten the 5 set screws.
 - 5 Fit the air filter.
 - 6 Fit the air inlet panel.

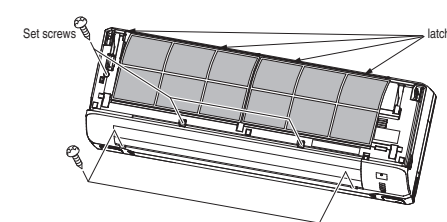

ELECTRICAL WIRING WORK

Preparation of indoor unit

Mounting of connecting wires

- ① Open the air inlet panel.
- ② Remove the service panel.
- ③ Remove the wiring clamp.
- ④ Connect the connecting wire securely to the terminal block.
 - 1) Connect the connection wire securely to the terminal block. If the wire is not affixed completely, contact will be poor, and it is dangerous as the terminal block may heat up and catch fire.
 - 2) Take care not to confuse the terminal numbers for indoor and outdoor connections.
- ⑤ Fix the connecting wire by wiring clamp.
- ⑥ Attach the service panel.
- ⑦ Close the air inlet panel.

CAUTION

In case of faulty wiring connection, the indoor unit stops, and then the run lamp turns on and the timer lamp blinks.

Use cables for interconnection wiring to avoid loosening of the wires. CENELEC code for cables Required field cables.

H05RN4G1.5 (example) or 245IEC57

H	Harmonized cable type
05	300/500 volts
R	Natural-and/or synth. rubber wire insulation
N	Polychloroprene rubber conductors insulation
R	Stranded core
4or5	Number of conductors
G	One conductor of the cable is the earth conductor (yellow/green)
1.5	Section of copper wire (mm ²)

The screw of the service panel is tightened securely.

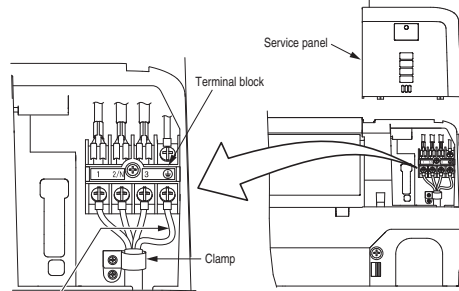

• Earth wire shall be Yellow/Green (Y/G) in color and longer than other AC wires for safety reason.

Installing the air-cleaning filters

1. Open the air inlet panel and remove the air filters.
2. Install the air-cleaning filter in the filter holders, and then install the filter holders in the air conditioner.
 - Each air-cleaning filter can be installed in the left or right filter holder.
3. Install the air filters and close the inlet panel.

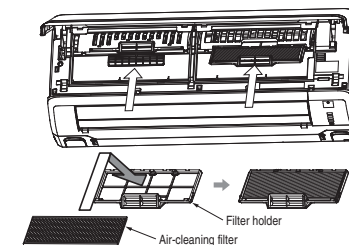

INSTALLATION OF WIRELESS REMOTE CONTROL

Mounting method of battery

- Uncover the wireless remote control, and mount the batteries [R03 (AAA, Micro), ×2 pieces] in the body regularly. (Fit the poles with the indication marks, ⊕ & ⊖ without fail)

CAUTION

Do not use new and old batteries together.

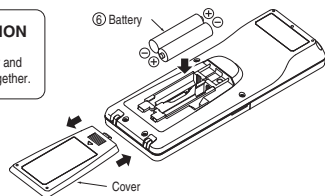

Fixing to pillar or wall

- Conventionally, operate the wireless remote control by holding in your hand.
- Avoid installing it on a clay wall etc.

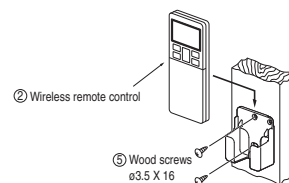

INSTALLING TWO AIR CONDITIONERS IN THE SAME ROOM

When two air conditioners are installed in the same room, use this setting when the two air conditioners are not operated with one wireless remote control. Set the wireless remote control and indoor unit.

Setting the wireless remote control

- ① Pull out the cover and take out batteries.
- ② Disconnect the switching line next to the battery with wire cutters.

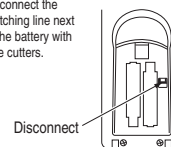

- ③ Insert batteries. Close the cover.

Setting an indoor unit

- ① Turn off the power supply, and turn it on after 1 minute.
- ② Point the wireless remote control that was set according to the procedure described on the left side at the indoor unit and send a signal by pressing the ACL switch on the wireless remote control. Since the signal is sent in about 6 seconds after the ACL switch is pressed, point the wireless remote control at the indoor unit for some time.
- ③ Check that the reception buzzer sound "pip" is emitted from the indoor unit. At completion of the setting, the indoor unit emits a buzzer sound "pip". (If no reception tone is emitted, start the setting from the beginning again.)

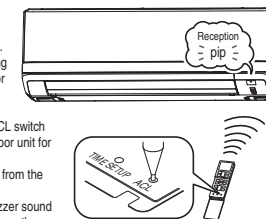

HOW TO RELOCATE OR DISPOSE OF THE UNIT

- In order to protect the environment, be sure to pump down (recovery of refrigerant).
- Pump down is the method of recovering refrigerant from the indoor unit to the outdoor unit when the pipes are removed from the unit.

- Forced cooling operation
Turn on a power supply again after a while after turn off a power supply. Then press continually the ON/OFF button 5 seconds or more.

<How to pump down>

- ① Connect charge hose to check joint of outdoor unit.
- ② Liquid side : Close the liquid valve with hexagon wrench key.
Gas side : Fully open the gas valve.
Carry out cooling operation. (If indoor temperature is low, operate forced cooling operation.)
- ③ After low pressure gauge become 0.01MPa, stop cooling operation and close the gas valve.

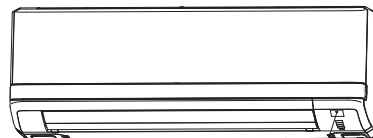

CONCERNING TERMINAL CONNECTION FOR AN INTERFACE

- ① Remove the front panel and lid of control.
- ② Remove the control.
- ③ There is a terminal (respectively marked with CNS) for the indoor control board. In connecting an interface, connect to the respective terminal securely with the connection harness supplied with an optional "Interface connection kit SC-BIKN-E" and fasten the connection harness onto the indoor control box with the clamp supplied with the kit. For more details, please refer to the user's manual of your "Interface connection kit SC-BIKN-E".

INSTALLATION TEST CHECK POINTS

Check the following points again after completion of the installation, and before turning on the power. Conduct a test run again and ensure that the unit operates properly. At the same time, explain to the customer how to use the unit and how to take care of the unit following the user's manual.

After installation

- The power supply voltage is correct as the rating.
- No gas leaks from the joints of the operation valve.
- Power cables and crossover wires are securely fixed to the terminal board.
- The screw of the service panel is tightened securely.

- Operation valve is fully open.
- The pipe joints for indoor and outdoor pipes have been insulated.

Test run

- Air conditioning operation is normal.
- No abnormal noise.
- Water drains smoothly.
- Protective functions are not working.
- The wireless remote control is normal.
- Operation of the unit has been explained to the customer. (Three-minutes restart preventive timer)
When the air conditioner is restarted or when changing the operation, the unit will not start operating for approximately 3 minutes. This is to protect the unit and it is not a malfunction.

(8) Effective range of cool/hot wind (Reference)

(a) FDT series

Guideline for ceiling height

Fan Speed Setting	Model			
	FDT40VF,50VF,60VF	FDT71VF1	FDT100VF1, 100VF2	FDT125VF,140VF
Hi	2.7m	3.0m	3.2m	3.6m
PHi	3.5m	3.8m	4.3m	4.5m

Notes (1) If the ceiling height is over 3m, please consider to add circulators.

This table shows reference values in case of four outlet.

If you shut some outlets, they are different.

Fan speed setting can be changed by using a wired remote controller.

(b) FDEN series

Model	Effective range
FDEN40VF, 50VF	7.5m
FDEN60VF, 71VF1	8.0m
FDEN100VF1, 125VF, 140VF	9.0m

- [Conditions]
1. Height of unit: 2.4 – 3.0 (m) above floor level
 2. Fan speed : Hi
 3. Location: Free space without obstacles
 4. The effective range means the horizontal distance for wind to reach the floor.
 5. Wind speed at the effective range: 0.5 m/s

(c) FDF series

Model	Effective range
FDF71VD1	5m
FDF100VD1, 125VD, 140VD, 100VD2	8m

- [Conditions]
1. Fan speed : Hi
 2. Location: Free space without obstacles
 3. The effective range means the horizontal distance for the wind to reach the floor.
 4. Wind speed at the effective range: 0.5 m/s

1.10.2 Electric wiring work installation

(1) FDT, FDTC, FDEN, FDU200-250, FDUM, series

PSB012D999

Electrical wiring work must be performed by an electrician qualified by a local power provider according to the electrical installation technical standards and interior wiring regulations applicable to the installation site.

Security instructions

- Read the "SAFETY PRECAUTIONS" carefully first of all and then strictly follow it during the installation work in order to protect yourself.
- The precautionary items mentioned below are distinguished into two levels, **⚠WARNING** and **⚡CAUTION**.
- **⚠WARNING** : Wrong installation would cause serious consequences such as injuries or death.
- **⚡CAUTION** : Wrong installation might cause serious consequences depending on circumstances. Both mentions the important items to protect your health and safety so strictly follow them by any means.
- The meanings of "Marks" used here are as shown on the right:
⚡ Never do it under any circumstances. ⚠ Always do it according to the instruction.
- Accord with following items. Otherwise, there will be the risks of electric shock and fire caused by overheating or short circuit.

⚠WARNING

- Be sure to have the electrical wiring work done by qualified electrical installer, and use exclusive circuit. ⚠
Power source with insufficient capacity and improper work can cause electric shock and fire.
- Use specified wire for electrical wiring, fasten the wiring to the terminal securely, and hold the cable securely in order not to apply unexpected stress on the terminal. ⚠
Loose connections or hold could result in abnormal heat generation or fire.
- Arrange the electrical wires in the control box properly to prevent them from rising. Fit the lid of the services panel properly. ⚠
Improper fitting may cause abnormal heat and fire.
- Use the genuine optional parts. And installation should be performed by a specialist. ⚠
If you install the unit by yourself, it could cause water leakage, electric shock and fire.
- Do not repair by yourself. And consult with the dealer about repair. ⚠
Improper repair may cause water leakage, electric shock or fire.
- Consult the dealer or a specialist about removal of the air conditioner. ⚠
Improper installation may cause water leakage, electric shock or fire.
- Turn off the power source during servicing or inspection work. ⚠
If the power is supplied during servicing or inspection work, it could cause electric shock and injury by the operating fan.
- Shut off the power before electrical wiring work. ⚠
It could cause electric shock, unit failure and improper running.

⚡CAUTION

- Perform earth wiring surely. ⚡
Do not connect the earth wiring to the gas pipe, water pipe, lightning rod and telephone earth wiring. Improper earth could cause unit failure and electric shock due to a short circuit.
- Earth leakage breaker must be installed. ⚡
If the earth leakage breaker is not installed, it can cause electric shocks.
- Make sure to install earth leakage breaker on power source line. (countermeasure thing to high harmonics.) ⚡
Absence of breaker could cause electric shock.
- Use the circuit breaker of correct capacity. Circuit breaker should be the one that disconnect all poles under over current. ⚡
Using the incorrect one could cause the system failure and fire.
- Do not use any materials other than a fuse of correct capacity where a fuse should be used. ⚡
Connecting the circuit by wire or copper wire could cause unit failure and fire.
- Use power source line of correct capacity. ⚡
Using incorrect capacity one could cause electric leak, abnormal heat generation and fire.
- Do not mingle solid cord and stranded cord on power source and signal side terminal block. ⚡
In addition, do not mingle difference capacity solid or stranded cord. Inappropriate cord setting could cause loosening screw on terminal block, bad electrical contact, smoke and fire.
- Do not turn off the power source immediately after stopping the operation. ⚡
Be sure to wait for more than 5 minutes. Otherwise it could cause water leakage or breakdown.
- Do not control the operation with the circuit breaker. ⚡
It could cause fire or water leakage. In addition, the fan may start operation unexpectedly and it may cause injury.

Control mode switching

- The control content of indoor units can be switched in following way. (is the default setting)

Switch No.	Control Content	
SW2	Indoor unit address (0-Fh)	
SW5-1	Master/Slave Switching (plural /Slave unit Setting)	
SW5-2	Model capacity setting	
SW6-1~4	Model capacity setting	
SW7-1	ON	Operation check, Drain motor test run
	OFF	Normal operation

① Electrical Wiring Connection

- Electrical wiring work must be performed by an electrician an qualified by a local power provider. These wiring specifications are determined on the assumption that the following instructions are observed:
 - ① Do not use cords other than copper ones.
Do not use any supply line lighter than one specified in parentheses for each type below.
 -braided cord (code designation 60245 IEC S1), if allowed in the relevant part 2;
 -ordinary tough rubber sheathed cord (code designation 60245 IEC S3);
 -flat twin tinsel cord (code designation 60227 IEC 41);
 -ordinary polyvinyl chloride sheathed cord (code designation 60227 IEC 53);
 - ② Connect the power supply to the outdoor unit.
 - ③ Pay extra attention so as not to confuse signal line and power source line connection, because an error in their connection can burn all the boards at once.
- Screw the line to terminal block without any looseness, certainly.
- Do not turn on the switch of power source, before all of line work is done.
- Provide a dedicated branching circuit and never share a branching circuit with other equipment. If shared, disconnection at the circuit breaker may occur, which can cause secondary damage.
- Use three-core cable as wiring between indoor and outdoor unit. As for detail, refer to "INSTALLATION MANUAL" of outdoor Unit.
- Set earth of D-type.
- Do not add cord in the middle of line (of indoor power source, remote control and signal) route on outside of unit. If connecting point is flooded, it could cause problem as for electric or communication.
(In the case that it is necessary to set connecting point on the signal line way, perform thorough waterproof measurement.)
- Run the lines (power source, remote control and "between indoor and outdoor unit") upper ceiling through iron pipe or other tube protection to avoid the damage by mouse and so on.
- Keep "remote control line" and "power source line" away from each other on constructing of unit outside.
- Do not connect the power source line [220V/240V/380V/415V] to signal side terminal block. Otherwise, it could cause failure.
- Connection of the line ("Between indoor and outdoor unit", Earth and Remote control)
 - ① Remove lid of control box before connect the above lines, and connect the lines to terminal block according to number pointed on label of terminal block.
In addition, pay enough attention to confirm the number to lines, because there is electrical polarity except earth line. Furthermore, connect earth line to earth position of terminal block of power source.
 - ② Install earth leakage breaker on power source line. In addition, select the type of breaker for inverter circuit as earth leakage breaker.
 - ③ If the function of selected earth leakage breaker is only for earth-fault protection, hand switch (switch itself and type "B" fuse) or circuit breaker is required in series with the earth leakage breaker.
 - ④ Install isolator or disconnect switch on the power supply wiring in accordance with the local codes and regulations. The isolator should be set in the box with key to prevent touching by another person when servicing.

Cable connection for single unit installation

- ① As for connecting method of power source, select from following connecting patterns. In principle, do not directly connect power source line to inside unit.
- ※ As for exceptional connecting method of power source, discuss with the power provider of the country with referring to technical documents, and follow its instruction.
- ② For cable size and circuit breaker selection, refer to the outdoor unit installation manual.

Single-phase model

Three-phase model

Cable connection for a V multi configuration installation

- ① Connect the same pairs number of terminal block "①, ②, and ③" and "ⓧ and Ⓨ" between master and slave indoor units.
- ② Do the same address setting of all inside units belong to same refrigerant system by rotary switch SW2 on indoor unit's PCB (Printed circuit board).
- ③ Set slave indoor unit as "slave 1" through "slave 3" by address switch SW5-1, 5-2 on PCB.
- ④ When the [AIR CON NO.] button on the remote control unit is pressed after turning on the power, an indoor unit's address number will be displayed. Do not fail to confirm that the connected indoor unit's numbers are displayed on the remote control unit by pressing the ▲ or ▼ button.

Method of setting Master/Slave of indoor unit

(Factory setting: "Master")

Indoor Unit	Master	Slave 1	Slave 2	Slave 3
PCB SW	SW5-1	SW5-2	SW5-3	SW5-4
	OFF	ON	OFF	ON

- 251 -

② Remote Control, Wiring and functions

● DO NOT install it on the following places

- ① Places exposed to direct sunlight
- ② Places near heat devices
- ③ High humidity places
- ④ Hot surface or cold surface enough to generate condensation
- ⑤ Places exposed to oil mist or steam directly.
- ⑥ Uneven surface

Installation and wiring of remote control

- ① Install remote control referring to the attached installation manual.
- ② Wiring of remote control should use 0.3mm² × 2 core wires or cables.
The insulation thickness is 1mm or more. (on-site configuration)
- ③ Maximum prolongation of remote control wiring is 600 m.

If the prolongation is over 100m, change to the size below.

But, wiring in the remote control case should be under 0.5mm². Change the wire size outside of the case according to wire connecting. Waterproof treatment is necessary at the wire connecting section. Be careful about contact failure.

- 100 - 200m 0.5mm² × 2 cores
- Under 300m 0.75mm² × 2 cores
- Under 400m 1.25mm² × 2 cores
- Under 600m 2.0mm² × 2 cores

- ④ Avoid using multi-core cables to prevent malfunction.
- ⑤ Keep remote control line away from earth (frame or any metal of building).
- ⑥ Make sure to connect remote control line to the remote control and terminal block of indoor unit. (No polarity)

Control plural indoor units by a single remote control.

- ① A remote control can control plural indoor units (Up to 16).
In above setting, all plural indoor units will operate under same mode and temperature setting.
- ② Connect all indoor units with 2 core remote control line.
- ③ Set unique remote control communication address from "0" to "F" to each inside unit by the rotary switch SW2 on the indoor unit's PCB.

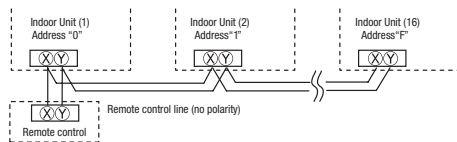

Master/ slave setting when more than one remote control unit are used

A maximum of two remote control units can be connected to one indoor unit (or one group of indoor units.)

The air conditioner operation follows the last operation of the remote control regardless of the master/slave setting of it.

Acceptable combination is "two (2) wired remote controls", "one (1) wired remote control and one (1) wireless kit" or "two (2) wireless kits".

Set one to "Master" and the other to "Slave".

Note: The setting "Remote control unit sensor enabled" is only selectable with the master remote control unit in the position where you want to check room temperature.

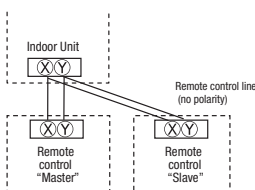

③ Operation and confirmation from remote control

Operation from RC-EX1A

- 1 Check the number of units connected in the remote control system.
It checks sub units of twin, triple or W-twin connection.

"Menu" ⇒ "Next" ⇒ "Service & Maintenance" ⇒
"Input password" ⇒ "IU address"

Operation from RC-E5

- Press **AIR CON NO** button to display the IU address. Press the **▼** or **▲** button and check addresses of connected indoor units one by one.

- 2 Check if each unit is connected properly in the remote control system.
It cannot check main and sub units of twin, triple or W-twin connection.

When the operation is stopped, "Menu" ⇒
"Next" ⇒ "Service & Maintenance" ⇒
"Input password" ⇒ "IU address" ⇒ "check run mode"

If AIR CON NO. button is pressed when the operation is stopped, the indoor unit address is displayed. If you select one of addresses for connected indoor units by pressing the **▼** or **▲** button and press the **MODE** button, the unit starts to blow air.

- 3 Setting main/slave remote controls

"Menu" ⇒ "Next" ⇒ "R/C function settings" ⇒
"Input password" ⇒ "Main/Sub of R/C"

Set SW1 to "Slave" for the slave remote control unit.

- 4 Checking operation data

"Menu" ⇒ "Next" ⇒ "Service & Maintenance" ⇒
"Input password" ⇒ "Operation data"

Press the **CHECK** button. ⇒ "PRR (DATA)" is displayed. ⇒ Press the **MODE** (SET) button. ⇒ "DATA (LOADING)" is displayed. ⇒ Press the **←** or **→** button. ⇒ Select one of addresses for connected indoor units by pressing the **▲** or **▼** button. ⇒ Press the **MODE** (SET) button. ⇒ "DATA (LOADING)" is displayed. ⇒ Select data by pressing the **▲** or **▼** button.

- 5 Checking inspection display

"Menu" ⇒ "Next" ⇒ "Service & Maintenance" ⇒
"Input password" ⇒ "Inspection display"

Press the **CHECK** button. ⇒ **▼** button. ⇒ ERR DATA. ⇒ Press the **MODE** (SET) button. ⇒ "DATA (LOADING)" is displayed. ⇒ Data.

- 6 Cooling test run from remote control

"Menu" ⇒ "Next" ⇒ "Installation settings" ⇒
"Input password" ⇒ "Test run" ⇒
"Cooling test run" ⇒ "Start"

- ① Start the system by pressing the **ON/OFF** button.
- ② Select "Cool" with the **MODE** button.
- ③ Press the **TEST** button for 3 seconds or longer.
The screen display will switch to TEST RUN.
- ④ When the **MODE** (SET) button is pressed while "TEST RUN" is indicated, a cooling test run will start.
The screen display will switch to TEST RUN.

- 7 Trial operation of drain pump from remote control

"Menu" ⇒ "Next" ⇒ "Installation settings" ⇒
"Input password" ⇒ "Test run" ⇒
"Drain pump test run" ⇒ "Run"

- ① Press the **TEST** button for three seconds or longer.
The display will change to TEST RUN.
- ② Press the **▼** button once and cause "DRAIN PUMP" to be displayed.
- ③ When the **MODE** (SET) button is pressed, a drain pump operation will start. Display: "STOP TO STOP".

④ Function of CNT connector of indoor printed circuit board

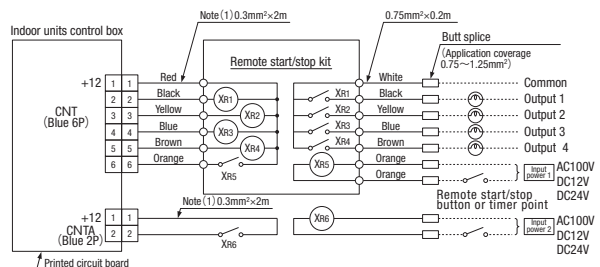

Note (1): Do not use the length over 2 meter

- CNT connector (local) vendor model
Connector : Made by molex 5264-06
Terminals : Made by molex 5263 T

● Function

Output 1	Air conditioner operation output (When the air conditioner ON: XR1 = ON)
Output 2	Heating output
Output 3	Thermostat ON output (When the thermostat ON: XR3 = ON)
Output 4	Air conditioner check ON (When checking air conditioner: XR4 = ON)
Input	At shipping XR5 OFF ⇒ ON: Air conditioner operates. XR5 ON ⇒ OFF: Air conditioner stops.
	*Functions and controls may vary depending on the switching at site.
Input 2 (FDT etc.)	At shipping XR6 OFF ⇒ ON: Air conditioner operates. XR6 ON ⇒ OFF: Air conditioner stops.
	*Functions and controls may vary depending on the switching at site.

* Refer to I/U settings.

- CNTA connector is installed on FDT, etc. Refer to the spec. drawings.
CNTA connector (local) vendor model
Connector : Made by JST XAP02V-1-E
Terminals : Made by JST SXA-01T-P0.6

⑥ Operation and setting from remote control

A: Refer to the instruction manual for RC-EX series.
 B: Refer to the installation manual for RC-EX series.
 C: Loading a utility software via Internet
 ○: Nearly same function setting and operations are possible.
 △: Similar function setting and operations are possible.

Setting & display item	Description	RC-EX series	RC-E5
1. Remote Control network			
1	Control plural indoor units by a single remote control	○	○
2	Master/slave setting of remote controls	B	○
2. TOP screen, Switch manipulation			
1	Menu	A	A
2	Operation mode	A	○
3	Set temp.	A	○
4	Air flow direction	A	○
5	Fan speed	A	○
6	Timer setting	A	○
7	ON/OFF	A	○
8	High power SW	A	
9	Energy-saving SW	A	
3. Energy-saving settin			
1	Auto OFF timer [Administrator password]	A	△
2	Peak-cut timer [Administrator password]	A	
3	Automatic temp. set back [Administrator password]	A	△
4. Individual flap control setting			
	Individual flap control setting	A	○
5. Ventilation			
1	External ventilation (in combination with ventilator)	A	○
6. Filter sign reset			
1	Filter sign reset	B	
2	Setting next cleaning date	A	
7. Initial settings			
1	Clock setting	A	△
2	Date and time display	A	
3	Summer time	A	
4	Contrast	A	
5	Backlight	A	
6	Controller sound	A	
8. Timer settings			
1	Set On timer by hour	A	△
2	Set Off timer by hour	A	△
3	Set On timer by clock	A	△
4	Set Off timer by clock	A	△
5	Confirmation of timer settings	A	
9. Weekly timer			
1	Weekly timer [Administrator password]	A	△
10. Home leave mode			
1	Home leave mode [Administrator password]	A	

⑥ Operation and setting from remote control (continued)

Setting & display item	Description	RC-EX series	RC-E5
11. Administrator settings	[Administrator password]	A	
1 Enable/Disable setting	•Enable/Disable setting of operation can be set. [On/Off] [Change set temp.] [Change operation mode] [Change air flow direction] [Individual flap control setting][Fan speed] [High power operation] [Energy-saving operation] [Timer settings] [Weekly timer setting] •Request for administrator password can be set. [Individual flap control setting][Weekly timer][Energy-saving setting][Home leave mode][Administrator settings]	A	△
2 Silent mode timer	The period of time to operate the outdoor unit by prioritizing the quietness can be set. •The [Start time] and the [End time] for operating outdoor unit in silent mode can be set. •The period of the operation time can be set once a day by 5 minutes interval.	A	△
3 Setting temp. range	The upper/lower limit of indoor temp. setting range can be set. •The limitation of indoor temp. setting range can be set for each operation mode in cooling and heating.	A	△
4 Temp. increment setting	The temp increment setting can be changed by 0.5°C or 1.0°C.	A	
5 RC display setting	Register [Room name] [Name of I/U] Display [indoor temp.] or not. Display [inspection code] or not. Display [Heating stand-by] [Defrost operation] [Auto cooling/heating] or not	A	○ △ ○
6 Change administrator password	The administrator password can be changed. (Default setting is "0000") The administrator password can be reset.	A B	
12. Installer settings	[Service password]	B	
1 Installation date	The [Installation date] can be registered. •When registering the [Installation date], the [Next service date] is displayed automatically. (For changing the [Next service date], please refer the item of [Service & Maintenance].)	B	
2 Service contact	The [Service contact] can be registered and can be displayed on the RC. •The [Contact company] can be registered within 10 characters. •The [Contact phone] can be registered within 13 digits.	B	
3 Test run	On/Off operation of the test run can be done.		
Cooling test run	The [Cooling test run] can be done at 5°C of set temp. for 30 minutes.	B	○
Drain pump test run	Only the drain pump can be operated.		○
Compressor Hz fixed operation	The [Test run] operation can be done with fixed compressor Hz set by installer.		○
4 Static pressure adjustment	In case of combination with only the ducted indoor unit which has a function of static pressure adjustment, the static pressure is adjustable.	B	
5 Change auto-address	The set address of each indoor unit decided by auto-address setting method can be changed to any other address. (For multiple KX units only)	B	△
6 Address setting of Main IU	Main indoor unit address can be set. •Only the Main indoor unit can change operation mode and the Sub indoor units dominated by the Main indoor unit shall follow. •The Main indoor unit can domain 10 indoor units at a maximum.	B	△
13. RC function settings	[Service password]	B	
1 Main/Sub RC setting	The setting of [Main/Sub RC] can be changed.	B	○
2 RC sensor	The offset value of [RC sensor] sensing temp. can be set respectively in heating and cooling.	B	○
3 9 RC sensor adjustment	The offset value of [RC sensor] sensing temp. can be set respectively in heating and cooling. •The setting range of offset value is ±3°C both in cooling and heating.	B	△
4 12 Operation mode	The [Valid/Invalid] setting of [Auto][Cooling][Heating] and [Dry] can be done respectively.	B	○
5 13 Fan speed	The setting of [Fan speed] can be done from following patterns. •1-speed, 2-speeds (Hi-Me), 2-speeds (Hi-Lo), 3-speeds, 4-speeds.	B	○
14 External input	The applicable range ([Individual] or [All units]) of CnT input to the multiple indoor units connected in one control system. •[Individual] : Only the unit received CnT input signal. •[All units] : All the units connected to one control system received CnT input signal.	B	○
7 15 Ventilation setting	The setting of [Invalid] operation of ventilator, [Interlock] with AC or [Independent] of ventilator can be selected. •When setting [Interlock], the operation of external ventilator is interlocked with the operation of AC •When setting [Independent], only the operation of external ventilator is available.	B	○
8 16 Flap control	The [Flap control] method can be switched to[Stop at fixed position] or [Stop at any position]-[Stop at fixed position] : Stop the flap at a certain position among the designated 4 positions. •[Stop at any position] : Stop the flap at any arbitrary position just after the stopping command from RC was sent.	B	○
9 17 Auto-restart	The operation control method after recovery of power blackout happened during operation can be set.	B	○
10 18 Auto temp. setting	[Valid] or [Invalid] of [Auto temp. setting] can be selected.	B	
11 19 Auto fan speed setting	[Valid] or [Invalid] of [Auto fan speed setting] can be selected.	B	
14. I/U settings	[Service password]	B	
1 High ceiling	The fan tap of indoor fan can be changed. •[Standard] [High ceiling 1] [High ceiling 2] can be selected.	B	○
2 Filter sign	The setting of filter sign display timer can be done from following patterns.	B	○
3 External input 1	The content of control by external input can be changed. •The selectable contents of control are [On/Off] [Permission/Prohibition] [Cooling/heating] [Emergency stop]	B	○
4 External input 1 signal	The type of external input signal ((Level input)/[Pulse input]) can be changed.	B	○
5 External input 2	•The selectable contents of control are [On/Off] [Permission/Prohibition] [Cooling/heating] [Emergency stop]	B	
6 External input 2 signal	The type of external input signal ((Level input)/[Pulse input]) can be changed.	B	
7 Heating thermo-off temp. adjust	The judgment temp. of heating thermo-off can be adjusted within the range from 0 to +3°C (1°C interval)	B	△
8 Return air sensor adjust.	The sensing temp. of return air temp. sensor built in the indoor unit can be adjusted within the range of ±2°C.	B	△
9 Fan control in heating thermo OFF	The fan control method at heating thermo-off can be changed. •The selectable fan control methods are [Low] [Set fan speed] [Intermittent] [Stop].	B	○
10 Anti-frost temp.	The judgment temp. of anti-frost control for the indoor unit in cooling can be changed to [Temp. High] or [Temp. Low].	B	○
11 Anti-frost control	When the anti-frost control of indoor unit in cooling is activated, the fan speed can be changed.	B	○
12 Drain pump operation	In any operation mode in addition to cooling and dry mode, the setting of drain pump operation can be done.	B	○
13 Residual fan operation in cooling	The time period of residual fan operation after stopping or thermo-off in cooling mode can be set.	B	○
14 Residual fan operation in heating	The time period of residual fan operation after stopping or thermo-off in heating mode can be set.	B	○
15 Intermittent fan operation in heating	The fan operation rule following the residual fan operation after stopping or thermo-off in heating mode can be set.	B	○
16 Fan circulator operation	In case that the fan is operated as the circulator, the fan control rule can be set.	B	
17 Control pressure adjust. (For OA processing unit only)	When only the OA processing units are operated, control pressure value can be changed.	B	○
18 Auto operation mode	The [Auto rule selection] for switching the operation mode automatically can be selected from 3 patterns.	B	
19 Thermo. rule setting	When selecting [Outdoor air temp. control], the judgment temp can be offset by outdoor temp..	B	
20 Auto fan speed control	Under the [Auto fan speed control] mode, the switching range of fan speed can be selected from following 2 patterns [Auto 1] [Auto 2]. •[Auto 1] : Hi ⇔Me⇔Lo •[Auto 2] : P-hi⇔Hi⇔Me⇔Lo	B	
15. Service & Maintenance	[Service password]	B	
1 IU address No.	Max. 16 indoor units can be connected to one remote control, and all address No. of the connected indoor units can be displayed. •The indoor unit conforming to the address No. can be identified by selecting the address No. and tapping [Check] to operate the indoor fan.	B	○
2 Next service date	The [Next service date] can be registered. •The [Next service date] and [Service contact] is displayed on the [Periodical check] message screen.	AB	
3 Operation data	Total 39 items of [Operation data] for indoor unit and outdoor unit can be displayed.	B	○
4 Error history	[Date and time of error occurred] [IU address] [Error code] for Max. 16 latest cases of error history can be displayed.	B	△
Display anomaly data	The operation data just before the latest error stop can be displayed.	B	
Reset periodical check	The timer for the periodical check can be reset.	B	○
5 Saving I/U settings	The I/U settings memorized in the indoor PCB connected to the remote control can be saved in the memory of the remote control.	B	
6 Special settings	[Erase I/U address] [CPU reset] [Initializing] [Touch panel calibration]	B	△
16. Inspection		A	△
Confirmation of Inspection	The address No. of anomalous indoor/outdoor unit and error code are displayed.		
17. PC connection		C	
USB connection	Weekly timer setting and etc., can be set from PC.		

(2) FDU 100-140 series

Electrical wiring work must be performed by an electrician qualified by a local power provider according to the electrical installation technical standards and interior wiring regulations applicable to the installation site.

Security instructions

- Read the "SAFETY PRECAUTIONS" carefully first of all and then strictly follow it during the installation work in order to protect yourself.
- The precautionary items mentioned below are distinguished into two levels, [WARNING] and [CAUTION].
- [WARNING] : Wrong installation would cause serious consequences such as injuries or death.
- [CAUTION] : Wrong installation might cause serious consequences depending on circumstances. Both mentions the important items to protect your health and safety so strictly follow them by any means.
- The meanings of "Marks" used here are as shown on the right.
- [Never do it under any circumstances.] [Always do it according to the instruction.]
- Accord with following items. Otherwise, there will be the risks of electric shock and fire caused by overheating or short circuit.

WARNING

- Be sure to have the electrical wiring work done by qualified electrical installer, and use exclusive circuit.
- Use specified wire for electrical wiring, fasten the wiring to the terminal securely, and hold the cable securely in order not to apply unexpected stress on the terminal.
- Arrange the electrical wires in the control box properly to prevent them from rising. Fit the lid of the services panel properly.
- Use the genuine optional parts. And installation should be performed by a specialist.
- Do not repair by yourself. And consult with the dealer about repair.
- Consult the dealer or a specialist about removal of the air conditioner.
- Turn off the power source during servicing or inspection work.
- Shut off the power before electrical wiring work.

CAUTION

- Perform earth wiring surely.
- Earth leakage breaker must be installed.
- Make sure to install earth leakage breaker on power source line. (countermeasure thing to high harmonics.)
- Use the circuit breaker of correct capacity. Circuit breaker should be the one that disconnect all poles under over current.
- Do not use any materials other than a fuse of correct capacity where a fuse should be used.
- Use power source line of correct capacity.
- Do not mingle solid cord and stranded cord on power source and signal side terminal block.
- Do not turn off the power source immediately after stopping the operation.
- Do not control the operation with the circuit breaker.

① Electrical Wiring Connection

- Use three-core cable as wiring between indoor and outdoor unit. As for detail, refer to "INSTALLATION MANUAL" of outdoor Unit.
- Set earth of D-type.
- Keep "remote control line" and "power source line" away from each other on constructing of unit outside.
- Run the lines (power source, remote control and "between indoor and outdoor unit") upper ceiling through iron pipe or other tube protection to avoid the damage by mouse and so on.
- Do not add cord in the middle of line route (of power source, remote control and "between indoor and outdoor unit") on outside of unit. If connecting point is flooded, it could cause problem as for electric or communication. (In the case that it is necessary to set connecting point on the way, perform thorough waterproof measurement.)
- Do not connect the power source line [220V/240V/380V/415V] to signal side terminal block. Otherwise, it could cause failure.
- Screw the line to terminal block without any looseness, certainly.
- Do not turn on the switch of power source, before all of line work is done.
- Connection of the line ("Between indoor and outdoor unit", Earth and Remote control)
- ① Remove lid of control box before connect the above lines, and connect the lines to terminal block according to number pointed on label of terminal block.
- In addition, pay enough attention to confirm the number to lines, because there is electrical polarity except earth line. Furthermore, connect earth line to earth position of terminal block of power source.
- ② Install earth leakage breaker on power source line. In addition, select the type of breaker for inverter circuit as earth leakage breaker.
- ③ If the function of selected earth leakage breaker is only for earth-fault protection, hand switch (switch itself and type "B" fuse) or circuit breaker is required in series with the earth leakage breaker.
- ④ Install isolator or disconnect switch on the power supply wiring in accordance with the local codes and regulations.
- The isolator should be set in the box with key to prevent touching by another person when servicing.

Cable connection for single unit installation

- ① As for connecting method of power source, select from following connecting patterns. In principle, do not directly connect power source line to inside unit.
- ※ As for exceptional connecting method of power source, discuss with the power provider of the country with referring to technical documents, and follow its instruction.
- ② For cable size and circuit breaker selection, refer to the outdoor unit installation manual.

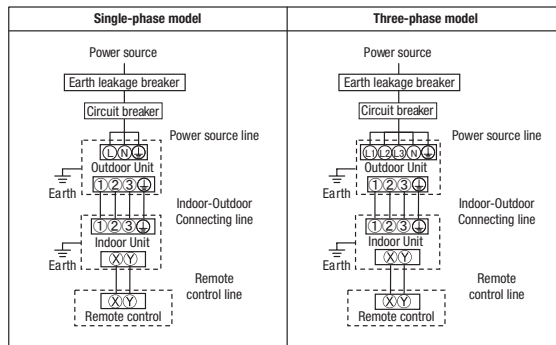

Cable connection for a V multi configuration installation

- ① Connect the same pairs number of terminal block "①, ②, and ③" and "X and Y" between master and slave indoor units.
- ② Do the same address setting of all inside units belong to same refrigerant system by rotary switch SW2 on indoor unit's PCB (Printed circuit board).
- ③ Set slave indoor unit as "slave 1" through "slave 3" by address switch SW5-1, 5-2 on PCB.
- ④ When the [AIR CON NO.] button on the remote control unit is pressed after turning on the power, an indoor unit's address number will be displayed. Do not fail to confirm that the connected indoor unit's numbers are displayed on the remote control unit by pressing the ▲ or ▼ button.

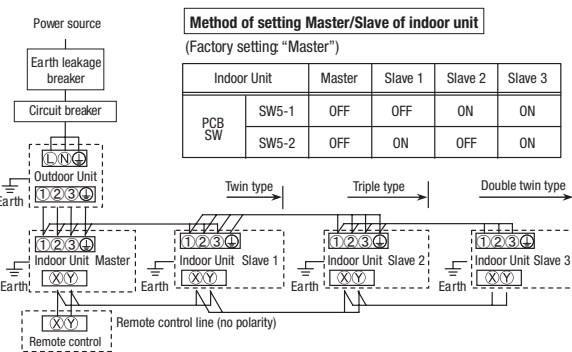

② Remote Control, Wiring and functions

● DO NOT install it on the following places

- ① Places exposed to direct sunlight
- ② Places near heat devices
- ③ High humidity places
- ④ Hot surface or cold surface enough to generate condensation
- ⑤ Places exposed to oil mist or steam directly.
- ⑥ Uneven surface

Installation and wiring of remote control

- ① Install remote control referring to the attached installation manual.
- ② Wiring of remote control should use 0.3mm² × 2 core wires or cables.
The insulation thickness is 1mm or more. (on-site configuration)
- ③ Maximum prolongation of remote control wiring is 600 m.
If the prolongation is over 100m, change to the size below.
But, wiring in the remote control case should be under 0.5mm². Change the wire size outside of the case according to wire connecting. Waterproof treatment is necessary at the wire connecting section. Be careful about contact failure.
100 - 200m 0.5mm² × 2 cores
Under 300m 0.75mm² × 2 cores
Under 400m 1.25mm² × 2 cores
Under 600m 2.0mm² × 2 cores
- ④ Avoid using multi-core cables to prevent malfunction.
- ⑤ Keep remote control line away from earth (frame or any metal of building).
- ⑥ Make sure to connect remote control line to the remote control and terminal block of indoor unit. (No polarity)

Control plural indoor units by a single remote control

- ① A remote control can control plural indoor units (Up to 16).
In above setting, all plural indoor units will operate under same mode and temperature setting.
- ② Connect all indoor units with 2 core remote control line.
- ③ Set unique remote control communication address from "0" to "F" to each inside unit by the rotary switch SW2 on the indoor unit's PCB.

After a unit is energized, it is possible to display an indoor unit address by pressing **AIR CON NO.** button on the remote control unit. Press the **▲** or **▼** button to make sure that all indoor units connected are displayed in order.

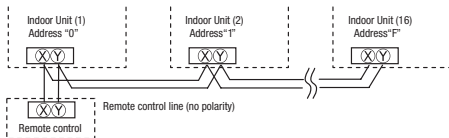

Confirming method of indoor units

When indoor unit address number is displayed on remote control, pushing the **MODE** button to make the indoor unit with that number blow air (Display example: "I/U001" ≈ " ") Push the **MODE** button again to stop the operation.
However, this operation is invalid on the air-conditioning running.

Master/ slave setting when more than one remote control unit are used

A maximum of two remote control units can be connected to one indoor unit (or one group of indoor units.)

The air conditioner follows the last operation of the remote control regardless of the master/slave setting of it.

Acceptable combination is "two (2) wired remote controls", "one (1) wired remote control and one (1) wireless kit" or "two (2) wireless kits".

Set SW1 (wired remote control) or SW1-2 (wireless kit) to "Slave" for the slave remote control unit. It was factory set to "Master" for shipment.

Note: The setting "Remote control unit sensor enabled" is only selectable with the master remote control unit in the position where you want to check room temperature.

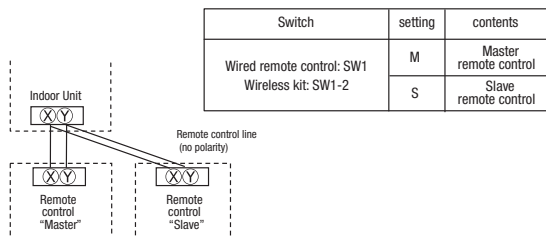

③ Trial operation

The method of trial cooling operation

Operate the remote control unit as follows.

1. Starting a cooling test run.
 - ① Start the system by pressing the **ON/OFF** button.
 - ② Select "❄️ (Cool)" with the **MODE** button.
 - ③ Press the **TEST** button for 3 seconds or longer.
The screen display will switch to: "❄️ TEST RUN ▼"
 - ④ When the **SET** button is pressed while "❄️ TEST RUN ▼" is indicated, a cooling test run will start.
The screen display will switch to "❄️ TEST RUN".
2. Ending a cooling test run.
Pressing the **ON/OFF** button, the **TEMP** button or **MODE** button will end a cooling test run. (Cooling test run will end after 30 minutes pass.)
"❄️ TEST RUN" shown on the screen will go off.

Checking operation data

Operation data can be checked with remote control unit operation.

1. Press the **CHECK** button.
The display change "OPER DATA ▼"
2. Press the **SET** button while "OPER DATA ▼" is displayed.
3. When only one indoor unit is connected to remote control, "DATA LOADING" is displayed (blinking indication during data loading).
Next, operation data of the indoor unit will be displayed. Skip to step 7.
4. When plural indoor units is connected, the smallest address number of indoor unit among all connected indoor unit is displayed.
[Example]:
"SELECT I/U" (blinking 1 seconds) → "I/U000 ▲" blinking.
5. Select the indoor unit number you would like to have data displayed with the **▲** **▼** button.
6. Determine the indoor unit number with the **SET** button.
(The indoor unit number changes from blinking indication to continuous indication) "I/U000" (The address of selected indoor unit is blinking for 2 seconds.)

Number	Data Item
01	❄️ (Operation Mode)
02	SET TEMP (Set Temperature)
03	RETURN AIR (Return Air Temperature)
04	SENSOR (Remote Control Thermistor Temperature)
05	THI-R1 (Indoor Unit Heat Exchanger Thermistor / U Band)
06	THI-R2 (Indoor Unit Heat Exchanger Thermistor / Capillary)
07	THI-R3 (Indoor Unit Heat Exchanger Thermistor / Gas Header)
08	I/U FANSPEED (Indoor Unit Fan Speed)
09	DEMAND Hz (Frequency Requirements)
10	ANSWER Hz (Response Frequency)
11	I/U EEV P (Pulse of Indoor Unit Expansion Valve)
12	TOTAL I/U RUN H (Total Running Hours of The Indoor Unit)
21	OUTDOOR (Outdoor Air Temperature)
22	THO-R1 (Outdoor Unit Heat Exchanger Thermistor)
23	THO-R2 (Outdoor Unit Heat Exchanger Thermistor)
24	COMP Hz (Compressor Frequency)
25	HP MPa (High Pressure)
26	LP MPa (Low Pressure)
27	Id (Discharge Pipe Temperature)
28	COMP BOTTOM (Comp Bottom Temperature)
29	CT AMP (Current)
30	TARGET SH (Target Super Heat)
31	SH (Super Heat)
32	TOSH (Discharge Pipe Super Heat)
33	PROTECTION No. (Protection State No. of The Compressor)
34	O/U FANSPEED (Outdoor Unit Fan Speed)
35	CSHT (CSHT On/Off)
36	DEFROST (Defrost Control On/Off)
37	TOTAL COMP RUN H (Total Running Hours of The Compressor)
38	O/U EEV1 P (Pulse of The Outdoor Unit Expansion Valve EEV1)
39	O/U EEV2 P (Pulse of The Outdoor Unit Expansion Valve EEV2)

※ Depending on outdoor unit model, there are data not shown.

- "DATA LOADING" (A blinking indication appears while data loaded.)
Next, the operation data of the indoor unit is indicated.
7. Upon operation of the **▲** **▼** button, the current operation data is displayed in order from data number 01.
The items displayed are in the above table.
※ Depending on models, the items that do not have corresponding data are not displayed.
 8. To display the data of a different indoor unit, press the **AIR CON NO.** button, which allows you to go back to the indoor unit selection screen.
 9. Pressing the **ON/OFF** button will stop displaying data.
Pressing the **RESET** button during remote control unit operation will undo your last operation and allow you to go back to the previous screen.
- Ⓞ If two (2) remote controls are connected to one (1) inside unit, only the master control is available for trial operation and confirmation of operation data. (The slave remote control is not available.)

Trail operation of drain pump

Drain pump operation from remote control unit is possible. Operate a remote control unit by following the steps described below.

1. To start a forced drain pump operation.
 - ① Press the **TEST** button for three seconds or longer.
The display will change "❄️ TEST RUN ▼"
 - ② Press the **▼** button once and cause "DRAIN PUMP ⚡" to be displayed.
 - ③ When the **SET** button is pressed, a drain pump operation will start.
Display: "🔌 TO STOP"
 2. To cancel a drain pump operation.
 - ① If either **SET** or **ON/OFF** button is pressed, a forced drain pump operation will stop. The air conditioning system will become OFF.
- Ⓞ If two (2) remote controls are connected to one (1) inside unit, only the master control is available for trial operation and confirmation of operation data. (The slave remote control is not available.)

④ Function Setting by Remote Control

The functional setting

The initial function setting for typical using is performed automatically for a remote control unit and an indoor unit when the door unit connected, when remote control and inside unit are connected.

As long as they are used in a typical manner, there will be no need to change the initial settings. If you would like to change the initial setting marked "○", set your desired setting as for the selected item. The procedure of functional setting is shown as the following diagram. As for detail of setting, refer to the installation manual of remote control.

[Flow of function setting]

Start : While indoor unit do not operate, press "○" (SET) and "○" (MODE) button for 3 seconds at the same time.
 Finalize : Press "○" (SET) button.
 Reset : Press "○" (RESET) button.
 Select : Press "▲" (UP) button.
 End : Press "○" (ON/OFF) button.

It is possible to finish above setting on the way, and unfinished change of setting is unavailable.

"○" : Initial settings

* : Automatic criterion

As for detail, refer to the installation manual of remote control.

During air-conditioner stopping push (SET) + (MODE) button simultaneously for 3 seconds

Consult the technical data etc for each control details

Record and save the setting

Note 1: The initial setting marked "※" is decided by connected indoor and outdoor unit, and is automatically defined as following table.

Function No.	Item	Default	Model
Function 02 of remote control	AUTO RUN SET	AUTO RUN ON	"Auto-RUN" mode selectable indoor unit.
Function 06 of remote control	DEFAN SPEED SW	HI-MID-LO	Indoor unit without "Auto-RUN" mode
Function 07 of remote control	LOUVER SW	INVALID	Indoor unit with only one of air flow setting
Function 13 of remote control	L/U FAN	HI-MID-LO	Indoor unit with automatically swing louver
Function 15 of remote control	MODEL TYPE	HEAT PUMP	Indoor unit without automatically swing louver
		COOLING ONLY	Indoor unit with three step of air flow setting
		HEAT PUMP	Indoor unit with two step of air flow setting
		COOLING ONLY	Indoor unit with only one of air flow setting
		HEAT PUMP	Heat pump unite
		COOLING ONLY	Exclusive cooling unite

Note 2: Fan setting of "HIGH SPEED"

Fan tap	Indoor unit air flow setting				
	STANDARD	2	3	4	5
FAN SPEED SET	STANDARD	UH - HI - Me - Lo	HI - Me - Lo	HI - Lo	HI - Me
	HIGH SPEED, 2	UH - UH - HI - Me	UH - HI - Me	UH - Me	UH - HI

Initial function setting of some indoor unit is "HIGH SPEED"

Note 3: As for plural indoor unit, set indoor functions to each master and slave indoor unit.

But only master indoor unit is received the setting change of indoor unit function "05 EXTERNAL INPUT" and "06 PERMISSION / PROHIBITION".

④ FUNCTION 7 (Remote control function)

Function	setting	
01 ESP SET	ESP VALID ○ ESP INVALID ○	Validate setting of ESP-External Static Pressure Invalidate setting of ESP
02 AUTO RUN SET	AUTO RUN ON ※ AUTO RUN OFF ※	Automatic operation is impossible
03 TEMP SW	TEMP VALID ○ TEMP INVALID ○	Temperature setting button is not working
04 MODE SW	MODE VALID ○ MODE INVALID ○	Mode button is not working
05 ON/OFF SW	ON/OFF VALID ○ ON/OFF INVALID ○	On/Off button is not working
06 DEFAN SPEED SW	DEFAN VALID ※ DEFAN INVALID ※	Fan speed button is not working
07 LOUVER SW	LOUVER VALID ※ LOUVER INVALID ※	Louver button is not working
08 TIMER SW	TIMER VALID ○ TIMER INVALID ○	Timer button is not working
09 THERMIST SET	THERMIST OFF ○ THERMIST ON ○ THERMIST +3.0°C ○ THERMIST +2.0°C ○ THERMIST +1.0°C ○ THERMIST -1.0°C ○ THERMIST -2.0°C ○ THERMIST -3.0°C ○	Remote thermostat is not working. Remote thermostat is working. Remote thermostat is working, and to be set for producing +3.0°C increase in temperature. Remote thermostat is working, and to be set for producing +2.0°C increase in temperature. Remote thermostat is working, and to be set for producing +1.0°C increase in temperature. Remote thermostat is working, and to be set for producing -1.0°C increase in temperature. Remote thermostat is working, and to be set for producing -2.0°C increase in temperature. Remote thermostat is working, and to be set for producing -3.0°C increase in temperature.
10 AUTO RESTART	INVALID ○ VALID ○	
11 VENT LINK SET	NO VENT ○ VENT LINK ○ NO VENT LINK ○	Connect the Single split series and the VRF series to the indoor board CNT and the indoor board CND respectively. If a ventilation device is connected, be geared with the motion of indoor device, the ventilation device is operated/stopped. By connecting the ventilation device with the Single split series device to indoor board CNT, the VRF series device to CND, you can operate/stop the ventilation device independently by the handling of ventilation button.
12 TEMP RANGE SET	TEMP CHANGE ○ NO TEMP CHANGE ○	If you change the range of set temperature, the indication of set temperature will vary following the control. If you change the range of set temperature, the indication of set temperature will not vary following the control, and keep the set temperature.
13 L/U FAN	HI-MID-LO ※ HI-LO ※ HI-MID ○ FAN SPEED ※	Airflow of fan becomes the three speed of $Hi_{set} - Me_{set} - Lo_{set}$ or $Hi_{set} - Me_{set} - Lo_{set} - Hi_{set} - Me_{set} - Lo_{set}$. Airflow of fan becomes the two speed of $Hi_{set} - Me_{set}$. Airflow of fan becomes the two speed of $Hi_{set} - Me_{set}$. Airflow of fan is fixed at one speed.
14 POSITION	POSITION STOP ○ FREE STOP ○	If you want to change the remote control function "14 POSITION", you must change the indoor function "04 PERMISSION" accordingly. You can select the lower stop position in the four. The lower can stop at any position.
15 MODEL TYPE	HEAT PUMP ※ COOLING ONLY ※	
16 EXTERNAL CONTROL SET	INDIVIDUAL ○ FOR ALL UNITS ○	If you input into the indoor printed circuit board CNT from outside, the indoor device will be operated independently following the input from outside. If you input into indoor printed circuit board CNT from outside, All units which share the same one remote control network work following the input from outside.
17 ROOM TEMP INDICATION SET	INDICATION OFF ○ INDICATION ON ○	In normal working indication, indoor unit temperature is indicated instead of airflow. (Only the master remote control can be indicated.)
18 HEATING INDICATION	INDICATION ON ○ INDICATION OFF ○	Heating preparation indication should not be indicated.
19 °C/°F SET	°C ○ °F ○	Temperature indication is by degree C Temperature indication is by degree F

④ FUNCTION 8 (Indoor unit function)

Only when plural indoor units are connected
Indoor No. selection

Function	setting	
02 FAN SPEED SET	STANDARD ○ HIGH SPEED 1 ○ HIGH SPEED 2 ○	
03 FILTER SIGN SET	INDICATION OFF ○ TYPE 1 ○ TYPE 2 ○ TYPE 3 ○ TYPE 4 ○	The filter sign is indicated after running for 180 hours. The filter sign is indicated after running for 600 hours. The filter sign is indicated after running for 1000 hours. The filter sign is indicated after running for 1000 hours, then it will be stopped by compulsion after 24 hours.
04 POSITION	POSITION STOP ○ FREE STOP ○	If to change the indoor function "04 POSITION", the remote control function "14 PERMISSION" should be changed accordingly. Select the lower stop position in four. The lower can stop at any position.
05 EXTERNAL INPUT	LEVEL INPUT ○ PULSE INPUT ○	
06 PERMISSION/PROHIBITION	INVALID ○ VALID ○	Make permission/prohibition control of function be in effect.
07 EMERGENCY STOP	INVALID ○ VALID ○	With the VRF series, it is used to stop all indoor units connected with the same outdoor unit immediately. When stop signal is input from remote on-off terminal "CNT-6", all indoor units are stopped immediately.
08 SP OFFSET	OFFSET +3.0°C ○ OFFSET +2.0°C ○ OFFSET +1.0°C ○ NO OFFSET ○	To be reset for producing +3.0°C increase in temperature during heating. To be reset for producing +2.0°C increase in temperature during heating. To be reset for producing +1.0°C increase in temperature during heating.
09 RETURN AIR TEMP	OFFSET +2.0°C ○ OFFSET +1.5°C ○ OFFSET +1.0°C ○ NO OFFSET ○ OFFSET -1.0°C ○ OFFSET -1.5°C ○ OFFSET -2.0°C ○	To be reset producing +2.0°C increase in return air temperature of indoor unit. To be reset producing +1.5°C increase in return air temperature of indoor unit. To be reset producing +1.0°C increase in return air temperature of indoor unit. To be reset producing -1.0°C increase in return air temperature of indoor unit. To be reset producing -1.5°C increase in return air temperature of indoor unit. To be reset producing -2.0°C increase in return air temperature of indoor unit.
10 FAN CONTROL	LOW FAN SPEED ○ SET FAN SPEED ○ INTERMITTENCE ○ FAN OFF ○	When heating thermostat is off, to be operated with low air flow. When heating thermostat is off, to be operated with set air flow. When heating thermostat is off, to be operated intermittently. When heating thermostat is off, the fan stops. When the remote thermostat is working, "FAN OFF" is set automatically. Do not set when the indoor unit's thermostat is working. Change of indoor heat exchanger temperature to start frost prevention control.
11 FROST PREVENTION TEMP	TEMP HIGH ○ TEMP LOW ○	
12 FROST PREVENTION CONTROL	FAN CONTROL ON ○ FAN CONTROL OFF ○	Working only with the single split series. To control frost prevention, the indoor fan tap is raised.
13 DRAIN PUMP LINK	ON ○ ON AND OFF ○ OFF ○	Drain pump is on during cooling and dry. Drain pump is on during cooling, dry and heating. Drain pump is on during cooling, dry, heating and fan. Drain pump is on during cooling, dry and fan.
14 IS FAN REMAINING	NO REMAINING ○ 0.5 HOUR ○ 1 HOUR ○ 2 HOUR ○	After cooling is stopped or cooling thermostat is off, the fan does not perform extra operation. After cooling is stopped or cooling thermostat is off, the fan perform extra operation for half an hour. After cooling is stopped or cooling thermostat is off, the fan perform extra operation for one hour. After cooling is stopped or cooling thermostat is off, the fan perform extra operation for two hours.
15 IS FAN REMAINING	NO REMAINING ○ 0.5 HOUR ○ 2 HOUR ○ 5 HOUR ○	After heating is stopped or heating thermostat is off, the fan does not perform extra operation. After heating is stopped or heating thermostat is off, the fan perform extra operation for half an hour. After heating is stopped or heating thermostat is off, the fan perform extra operation for two hours. After heating is stopped or heating thermostat is off, the fan perform extra operation for six hours.
16 IS FAN INTERMITTENCE	NO REMAINING ○ 2min OFF Swi ON ○ 5min OFF Swi ON ○	During heating is stopped or heating thermostat is off, the fan perform intermittent operation for five minutes after twenty minutes' off with low airflow. During heating is stopped or heating thermostat is off, the fan perform intermittent operation for five minutes after five minutes' off with low airflow.

ON/OFF button (finished)

⑤ Control mode switching

● The control content of indoor units can be switched in following way. (is the default setting)

Switch No.	Control Content	
SW2	Indoor unit address (0-Fh)	
SW5-1	Master/Slave Switching (plural /Slave unit Setting)	
SW5-2		
SW6-1~4	Model capacity setting	
SW7-1	ON	Operation check, Drain motor test run
	OFF	Normal operation

⑥ Function of CNT connector of indoor printed circuit board

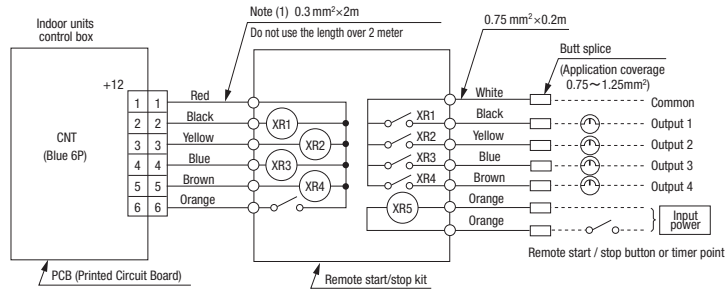

● CNT connector (local) vendor model
 Connector : Made by molex 5264 - 06
 Terminals : Made by molex 5263T

● Function

Output 1	Operation output (there is output when unit is in operation.)
Output 2	Heating output (there is output when operation MODE is HEATING.)
Output 3	Compressor ON output (there is output when compressor is in operation.)
Output 4	Inspection output (there is output when unit is stopped by error.)
Input 5	Remote operation input (Volt-free contact) (inputted to operate unit)

⑦ Troubleshooting

The operation data is saved when the situation of abnormal operation happen, and the data can be confirmed by remote control.

[Operating procedure]

- Press the [CHECK] button.
The display change "OPER DATA ▾".
- Once, press the [▼] button, and the display change "ERROR DATA ▲".
- Press the [SET] button and abnormal operation data mode is started.
- When only one indoor unit is connected to remote control, following is displayed.
 - The case that there is history of abnormal operation.
→ Error code and "DATA LOADING" is displayed.
[Example]: [E8] (ERROR CODE)
"DATA LOADING" is displayed (blinking indication during data loading).
Next, the abnormal operation data of the indoor unit will be displayed.
Skip to step 8.
 - The case that there is not history of abnormal operation.
→ "NO ERROR" is displayed for 3 seconds and this mode is closed.
- When plural indoor units is connected, following is displayed.
 - The case that there is history of abnormal operation.
→ Error code and the smallest address number of indoor unit among all connected indoor unit is displayed.
[Example]: [E8] (ERROR CODE)
"I/U000 ▲" blinking
 - The case that there is not history of abnormal operation.
→ Only address number is displayed.
- Select the indoor unit number you would like to have data displayed with the [▲] [▼] button.
- Determine the indoor unit number with the [SET] button.
[Example]: [E8] (ERROR CODE)
"I/U000 ▲" (The address of selected indoor unit is blinking for 2 seconds.)
↓
[E8] "DATA LOADING" (A blinking indication appears while data loaded).
Next, the abnormal operation data is indicated.
If the indoor unit doing normal operation is selected, "NO ERROR" is displayed for 3 seconds and address of indoor unit is displayed.
- By the [▲] [▼] button, the abnormal operation data is displayed.
Displayed data item is based on ③ Trial operation.
※ Depending on models, the items that do not have corresponding data are not displayed.
- To display the data of a different indoor unit, press the [AIR CON No.] button, which allows you to go back to the indoor unit selection screen.
- Pressing the [ON/OFF] button will stop displaying data.

Pressing the [RESET] button during remote control unit operation will undo your last operation and allow you to go back to the previous screen.

◎ If two (2) remote controls are connected to one (1) indoor unit, only the master control is available for trial operation and confirmation of operation data. (The slave remote control is not available.)

Error Code of indoor unit

Display on remote control	LED on indoor circuit board		Content
	red (checking)	green (normal)	
Off	Off	Continuous blinking	Normal
	Off	Off	
E1	Off	Continuous blinking	Fault on the transmission between indoor circuit board and remote control
	Not sure	Not sure	
E5	Blinking twice	Continuous blinking	Fault on outdoor-indoor transmission
E6	Blinking once	Continuous blinking	Indoor heat exchange sensor interrupted or short-circuit
E7	Blinking once	Continuous blinking	Indoor air inhaling sensor broken or short-circuit
E8	Blinking once	Continuous blinking	The temperature of heat exchange abnormal
E9	Blinking once	Continuous blinking	Float SW actions (only with FS)
	Blinking twice	Continuous blinking	
E10	Off	Continuous blinking	Excess number of remote control connections
E14	Blinking for three times	Continuous blinking	The communication fault for master/slave indoor units
E16	Blinking once	Continuous blinking	Fan motor (1) abnormal
	Blinking twice	Continuous blinking	
E19	Blinking once	Continuous blinking	Configuration fault on running checking model
E20	Blinking once	Continuous blinking	Fan motor (1) abnormal rotation
	Blinking twice	Continuous blinking	
E28	Off	Continuous blinking	Remote control sensor interrupted
Over E30	Off	Continuous blinking	Outdoor unit checking (outdoor circuit board LED checking)

(3) FDF series

Electrical wiring work must be performed by an electrician qualified by a local power provider according to the electrical installation technical standards and interior wiring regulations applicable to the installation site.

Security instructions

- Read the "SAFETY PRECAUTIONS" carefully first of all and then strictly follow it during the installation work in order to protect yourself.
- The precautionary items mentioned below are distinguished into two levels, **WARNING** and **CAUTION**.
 - WARNING** : Wrong installation would cause serious consequences such as injuries or death.
 - CAUTION** : Wrong installation might cause serious consequences depending on circumstances. Both mentions the important items to protect your health and safety so strictly follow them by any means.
- The meanings of "Marks" used here are as shown on the right:
 - ⊘ Never do it under any circumstances. Ⓜ Always do it according to the instruction.
- Accord with following items. Otherwise, there will be the risks of electric shock and fire caused by overheating or short circuit.

WARNING

- Be sure to have the electrical wiring work done by qualified electrical installer, and use exclusive circuit. Ⓜ
Power source with insufficient capacity and improper work can cause electric shock and fire.
- Use specified wire for electrical wiring, fasten the wiring to the terminal securely, and hold the cable securely in order not to apply unexpected stress on the terminal. Ⓜ
Loose connections or hold could result in abnormal heat generation or fire.
- Arrange the electrical wires in the control box properly to prevent them from rising. Fit the lid of the services panel properly. Ⓜ
Improper fitting may cause abnormal heat and fire.
- Use the genuine optional parts. And installation should be performed by a specialist. Ⓜ
If you install the unit by yourself, it could cause water leakage, electric shock and fire.
- Do not repair by yourself. And consult with the dealer about repair. Ⓜ
Improper repair may cause water leakage, electric shock or fire.
- Consult the dealer or a specialist about removal of the air conditioner. Ⓜ
Improper installation may cause water leakage, electric shock or fire.
- Turn off the power source during servicing or inspection work. Ⓜ
If the power is supplied during servicing or inspection work, it could cause electric shock and injury by the operating fan.
- Shut off the power before electrical wiring work. Ⓜ
It could cause electric shock, unit failure and improper running.

CAUTION

- Perform earth wiring surely. Ⓜ
Do not connect the earth wiring to the gas pipe, water pipe, lightning rod and telephone earth wiring. Improper earth could cause unit failure and electric shock due to a short circuit.
- Earth leakage breaker must be installed. Ⓜ
If the earth leakage breaker is not installed, it can cause electric shocks.
- Make sure to install earth leakage breaker on power source line. (countermeasure thing to high harmonics.) Ⓜ
Absence of breaker could cause electric shock.
- Use the circuit breaker of correct capacity. Circuit breaker should be the one that disconnect all poles under over current. Ⓜ
Using the incorrect one could cause the system failure and fire.
- Do not use any materials other than a fuse of correct capacity where a fuse should be used. Ⓜ
Connecting the circuit by wire or copper wire could cause unit failure and fire.
- Use power source line of correct capacity. Ⓜ
Using incorrect capacity one could cause electric leak, abnormal heat generation and fire.
- Do not mingle solid cord and stranded cord on power source and signal side terminal block. Ⓜ
In addition, do not mingle difference capacity solid or stranded cord. Inappropriate cord setting could cause losing screw on terminal block, bad electrical contact, smoke and fire.
- Do not turn off the power source immediately after stopping the operation. Ⓜ
Be sure to wait for more than 5 minutes. Otherwise it could cause water leakage or breakdown.
- Do not control the operation with the circuit breaker. Ⓜ
It could cause fire or water leakage. In addition, the fan may start operation unexpectedly and it may cause injury.

① Electrical Wiring Connection

- Use three-core cable as wiring between indoor and outdoor unit. As for detail, refer to "INSTALLATION MANUAL" of outdoor Unit.
- Set earth of D-type.
- Keep "remote control line" and "power source line" away from each other on constructing of unit outside.
- Run the lines (power source, remote control and "between indoor and outdoor unit") upper ceiling through iron pipe or other tube protection to avoid the damage by mouse and so on.
- Do not add cord in the middle of line route (of power source, remote control and "between indoor and outdoor unit") on outside of unit. If connecting point is flooded, it could cause problem as for electric or communication. (In the case that it is necessary to set connecting point on the way, perform thorough waterproof measurement.)
- Do not connect the power source line [220V/240V/380V/415V] to signal side terminal block. Otherwise, it could cause failure.
- Screw the line to terminal block without any looseness, certainly.
- Do not turn on the switch of power source, before all of line work is done.
- Connection of the line ("Between indoor and outdoor unit", Earth and Remote control)
- ① Remove lid of control box before connect the above lines, and connect the lines to terminal block according to number pointed on label of terminal block.
In addition, pay enough attention to confirm the number to lines, because there is electrical polarity except earth line. Furthermore, connect earth line to earth position of terminal block of power source.
- ② Install earth leakage breaker on power source line. In addition, select the type of breaker for inverter circuit as earth leakage breaker.
- ③ If the function of selected earth leakage breaker is only for earth-fault protection, hand switch (switch itself and type "B" fuse) or circuit breaker is required in series with the earth leakage breaker.
- ④ Install the local switch near the unit.

Cable connection for single unit installation

- ① As for connecting method of power source, select from following connecting patterns. In principle, do not directly connect power source line to inside unit.
- ⊘ As for exceptional connecting method of power source, discuss with the power provider of the country with referring to technical documents, and follow its instruction.
- ② For cable size and circuit breaker selection, refer to the outdoor unit installation manual.

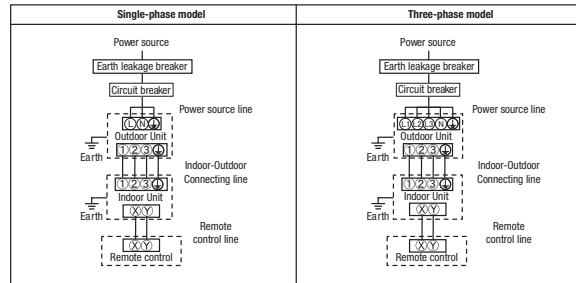

Cable connection for a V multi configuration installation

- ① Connect the same pairs number of terminal block "①", "②", and "③" and "Ⓧ" and "Ⓨ" between master and slave indoor units.
- ② Do the same address setting of all inside units belong to same refrigerant system by rotary switch SW2 on indoor unit's PCB (Printed circuit board).
- ③ Set slave indoor unit as "slave 1" through "slave 3" by address switch SW5-1, 5-2 on PCB.
- ④ When the [AIR CON NO.] button on the remote control unit is pressed after turning on the power, an indoor unit's address number will be displayed. Do not fail to confirm that the connected indoor unit's numbers are displayed on the remote control unit by pressing the [▲] or [▼] button.

Method of setting Master/Slave of indoor unit

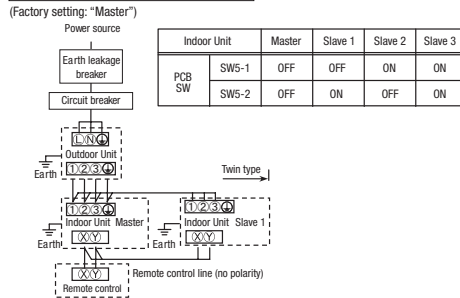

Switch and wiring specification

Refer to the installation manual attached to the outdoor unit.

② Wiring for the remote control

- For each indoor unit, one more remote control can be connected in addition to the one which is built in the main unit.

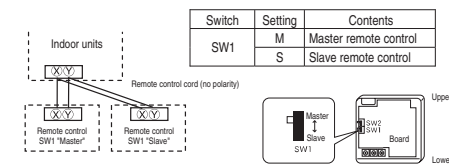

Set SW1 to "Slave" for the slave remote control. It was factory set to "Master" for shipment.
Note: The setting "Remote control thermostat enabled" is only selectable with the master remote control in the position where you want to check room temperature.

The air conditioner operation follows the last operation of the remote control regardless of the master/ slave setting of it.

* When setting the remote control built in the main unit to the "Slave":
Remove the cover and change the setting of switch as follows.

② Wiring for the remote control (Continued)

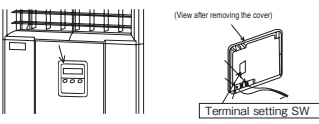
- Open the remote control cover and remove the screw without fail.
 
- Remove the upper case of remote control. Attach a flat head screwdriver at the upper part of remote control and pry lightly. It will come off easily. Use some cushion to protect the center panel.
 

③ Function Setting by Remote Control

Installation and wiring of remote control

- Wiring of remote control should use 0.3mm² × 2 core wires or cables. (on-site configuration)
- Maximum prolongation of remote control wiring is 600 m. If the prolongation is over 100m, change to the size below.

100 - 200m	0.5mm ² × 2 cores
Under 300m	0.75mm ² × 2 cores
Under 400m	1.25mm ² × 2 cores
Under 600m	2.0mm ² × 2 cores

The indication when power source is supplied

When power source is turned on, the following is displayed on the remote control until the communication between the remote control and indoor unit settled.

Master remote control: * @WAIT@ * M
Slave remote control: * @WAIT@ * S

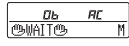

At the same time, a mark or a number will be displayed for two seconds. This is the software's administration number of the remote control, not an error code.

 * The left mark is only an example. Other marks may appear.

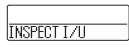
When remote control cannot communicate with the indoor unit for half an hour, the below indication will appear. Check wiring of the indoor unit and the outdoor unit etc.

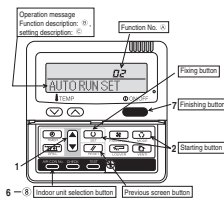
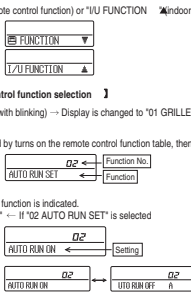

How to set function

- Stop air-conditioner and press () (SET) () (MODE) buttons at the same time for over three seconds, and the "FUNCTION SET" will be displayed.
 
- Press () (SET) button.
- Make sure which do you want to set, "FUNCTION" (remote control function) or "I/U FUNCTION" (indoor unit function).
- Press () or () button. Select "FUNCTION" (remote control function) or "I/U FUNCTION" (indoor unit function).
- Press () (SET) button.
- On the occasion of remote control function selection
 - "DATA LOADING" (Indication with blinking) → Display is changed to "01 GRILLE 1; SET".
 - Press () or () button. "No. and function" are indicated by turns on the remote control function table, then you can select from them. (For example)
 
 - Press () (SET) button. The current setting of selected function is indicated. (for example) "AUTO RUN ON" → If "02 AUTO RUN SET" is selected
 
 - Press () or () button. Select the setting. "SET COMPLETE" will be indicated, and the setting will be completed. Then after "No. and function" indication returns, set as the same procedure if you want to set continuously, and if to finish, go to 7.
 
- On the occasion of indoor unit function selection
 - "DATA LOADING" (Blinking for 2 to 23 seconds to read the data) → Indication is changed to "02 FAN SPEED SET". Go to ②.

[Note]

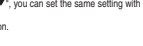
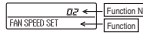
 (1) If plural indoor units are connected to a remote control, the indication is "IU 000" (blinking) → The lowest number of the indoor unit connected is indicated.
 
 - Press () or () button. Select the number of the indoor unit you are to set. If you select "ALL UNIT", you can set the same setting with all units.
 
 - Press () (SET) button.
 - Press () or () button. "No. and function" are indicated by turns on the indoor unit function table, then you can select from them. (For example)
 

③ Function Setting by Remote Control (Continued)

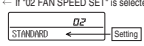
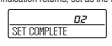
- Press () (SET) button. The current setting of selected function is indicated. (For example) "STANDARD" → If "02 FAN SPEED SET" is selected.
 
- Press () or () button. Select the setting.
 
- Press () (SET) button. "SET COMPLETE" will be indicated, and the setting will be completed. Then after "No. and function" indication returns, set as the same procedure if you want to set continuously, and if to finish, go to 7.

※ When plural indoor units are connected to a remote control, press the AIRCON NO. button, which allows you to go back to the indoor unit selection screen. (example "IU 000") ▲
- Press (ON/OFF) button. Setting is finished.

It is possible to finish by pressing (ON/OFF) button on the way, but unfinished change of setting is unavailable.
During setting, if you press () (RESET) button, you return to the previous screen.
Setting is memorized in the controller and it is saved independently of power failure.

How to check the current setting

When you select from "No. and function" and press set button by the previous operation, the "Setting" displayed first is the current setting. (But, if you select "ALL UNIT", the setting of the lowest number indoor unit is displayed.)

The functional setting

The initial function setting for typical using is performed automatically by the indoor unit connected, when remote control and indoor unit are connected. As long as they are used in a typical manner, there will be no need to change the initial settings. If you would like to change the initial setting marked "C", set your desired setting as for the selected item. The procedure of functional setting is shown as the following diagram. Sequence of the function setting is as follows.

The range of temperature setting

When shipped, the range of set temperature differs depending on the operation mode as below.
Heating: 16-30°C (55-86°F)
Except heating (cooling, fan, dry, automatic): 18-30°C (62-86°F)

Upper limit and lower limit of set temperature can be changed with remote control. Upper limit setting: valid during heating operation. Possible to set in the range of 20 to 30°C (68 to 86°F). Lower limit setting: valid except heating (automatic, cooling, fan, dry) Possible to set in the range of 18 to 26°C (62 to 79°F). When you set upper and lower limit by this function, control as below.

- When () TEMP RANGE SET, remote control function of function setting mode is "INDN CHANGE" (factory setting). [If upper limit value is set] During heating, you cannot set the value exceeding the upper limit. [If lower limit value is set] During operation mode except heating, you cannot set the value below the lower limit.
- When () TEMP RANGE SET, remote control function of function setting mode is "NO INDN CHANGE" [If upper limit value is set] During heating, even if the value exceeding the upper limit is set, upper limit value will be sent to the indoor unit. But, the indication is the same as the temperature set. [If lower limit value is set] During except heating, even if the value lower than the lower limit is set, lower limit value will be sent to the indoor unit. But, the indication is the same as the temperature set.

How to set upper and lower limit value

- Stop the air-conditioner, and press () (SET) and () (MODE) button at the same time for over three seconds. The indication changes to "FUNCTION SET".
- Press () button once, and change to the "TEMP RANGE" indication.
- Press () (SET) button, and enter the temperature range setting mode.
- Select "UPPER LIMIT" or "LOWER LIMIT" by using () () button.
- Press () (SET) button to fix.
- When "UPPER LIMIT" is selected (valid during heating)
 - Indication: "C ^ SET UP" → "UPPER 30°C" (blinking)
 - Select the upper limit value with temperature setting button () (). Indication example: "UPPER 26°C ^" (blinking)
 - Press () (SET) button to fix. Indication example: "UPPER 26°C" (Displayed for two seconds) After the fixed upper limit value displayed for two seconds, the indication will return to "UPPER LIMIT".
- When "LOWER LIMIT" is selected (valid during cooling, dry, fan, automatic)
 - Indication: "C ^ SET UP" → "LOWER 18°C" (blinking)
 - Select the lower limit value with temperature setting button () (). Indication example: "LOWER 24°C ^" (blinking)
 - Press () (SET) button to fix. Indication for example: "LOWER 24°C" (Displayed for two seconds) After the fixed lower limit value displayed for two seconds, the indication will return to "LOWER LIMIT".
- Press (ON/OFF) button to finish.

It is possible to finish by pressing (ON/OFF) button on the way, but unfinished change of setting is unavailable. During setting, if you press () (RESET) button, you return to the previous screen.

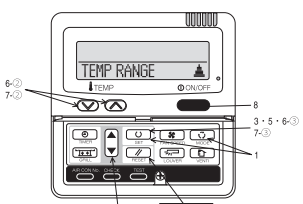

Note 1: Fan setting of "HIGH SPEED"

Fan tap	Indoor unit air flow setting											
	Standard	Hi	Hi-Me	Lo	Hi	Hi-Me	Lo	Hi	Hi-Me			
FAN SPEED SET	STANDARD	UH	Hi	Me	Lo	UH	Hi	Me	Lo	UH	Hi	Me
	HIGH SPEED 1, 2	UH	UH	Hi	Me	UH	Hi	Me	UH	UH	Hi	Me

Initial function setting of some indoor unit is "HIGH SPEED"

Note 2: As for plural indoor unit, set indoor functions to each master and slave indoor unit. But only master indoor unit is received the setting change of indoor unit function "05 EXTERNAL INPUT" and "06 PERMISSION / PROHIBITION".

③ Function Setting by Remote Control (Continued)

[Flow of function setting]

- Start : While indoor unit do not operate, press " (SET) and " (MODE) button for 3 seconds at the same time.
- Finalize : Press " (SET) button.
- Reset : Press " (RESET) button.
- Select : Press " (UP) button.
- End : Press " (ON/OFF) button.

It is possible to finish above setting on the way, and unfinished change of setting is unavailable.

- "○" : Initial settings
- "*" : Automatic criterion

As for detail, refer to the installation manual of remote control.

During air-conditioner stopping push (SET) + (MODE) button simultaneously for 3 seconds

Consult the technical data etc for each control details

Record and save the setting

FUNCTION SET

FUNCTION	Function	setting	(Indoor unit function)	(Note3)	Function	setting	
01	ROLLER P-L SET	T-L INVALID ○ 50Hz ZONE ONLY ○ 60Hz ZONE ONLY ○	When you use at 50Hz area When you use at 60Hz area		02	FAN SPEED SET	STANDARD * HIGH SPEED 1 * HIGH SPEED 2 *
02	AUTO RUN SET	AUTO RUN ON * AUTO RUN OFF ○	Automatic operation is impossible		03	FILTER SIGN SET	INDICATION OFF ○ TYPE 1 ○ TYPE 2 ○ TYPE 3 ○ TYPE 4 ○
03	ECO TEMP SW	ECO VALID ○ ECO INVALID ○	Temperature setting button is not working		04	POSITION	POSITION STOP * FREE STOP ○
04	MODE SW	MODE VALID ○ MODE INVALID ○	Mode button is not working	If to change re-set with other indoor unit, push [AIRC/CON. NO.] button, and indoor selection indication (for example: I/U 000) is set back.	05	EXTERNAL INPUT	LEVEL INPUT ○ PULSE INPUT ○
05	ON/OFF SW	ON VALID ○ ON INVALID ○	On/Off button is not working		06	PROHIBITION CONTROL	INVALID ○ VALID ○
06	FAN SPEED SW	FAN VALID * FAN INVALID *	Fan speed button is not working		07	EMERGENCY STOP	INVALID ○ VALID ○
07	LOUVER SW	LOUVER VALID ○ LOUVER INVALID *	Louver button is not working		08	SP OFFSET	OFFSET +3.0°C ○ OFFSET +2.0°C ○ OFFSET +1.0°C ○ NO OFFSET ○
08	TIMER SW	TIMER VALID ○ TIMER INVALID ○	Timer button is not working		09	RETURN AIR TEMP	NO OFFSET ○ OFFSET -1.0°C ○ OFFSET -1.5°C ○ OFFSET -2.0°C ○
09	SENSOR SET	SENSOR OFF ○ SENSOR ON ○ SENSOR +3.0°C ○ SENSOR +2.0°C ○ SENSOR +1.0°C ○ SENSOR -1.0°C ○ SENSOR -2.0°C ○ SENSOR -3.0°C ○	Remote thermostat is not working. Remote thermostat is working. Remote thermostat is working, and to be set for producing +3.0°C increase in temperature. Remote thermostat is working, and to be set for producing +2.0°C increase in temperature. Remote thermostat is working, and to be set for producing +1.0°C increase in temperature. Remote thermostat is working, and to be set for producing -1.0°C increase in temperature. Remote thermostat is working, and to be set for producing -2.0°C increase in temperature. Remote thermostat is working, and to be set for producing -3.0°C increase in temperature.		10	FAN CONTROL	LOW FAN SPEED ○ SET FAN SPEED ○ INTERMITTENCE ○ FAN OFF ○
10	AUTO RESTART	INVALID ○ VALID ○			11	FROST PREVENTION TEMP	TEMP HIGH ○ TEMP LOW ○
11	VENT LINK SET	NO VENT ○ VENT LINK ○ NO VENT LINK ○	Connect the Single split series and the VRF series to the indoor board CNT and indoor board CND respectively. If a ventilation device is connected, been geared with the motion of indoor device, the ventilation device is operated/stopped. By connecting the ventilation device with the Single split series device to indoor board CNT, the VRF series device to CND, you can operate/stop the ventilation device independently by the handling of ventilation button.		12	FROST PREVENTION CONTROL	FAN CONTROL ON ○ FAN CONTROL OFF ○
12	TEMP RANGE SET	INDIC CHANGE ○ NO INDIC CHANGE ○	If you change the range of set temperature, the indication of set temperature will vary following the control. If you change the range of set temperature, the indication of set temperature will not vary following the control, and keep the set temperature.		13	DRAIN PUMP LINK	DR ○ DR AND HE ○ DR AND HE AND FAN ○ DR AND HE ○
13	I/U FAN	HI-NOI-LO ○ HI-LO * HI-NOI * I FAN SPEED *	Airflow of fan becomes the three speed of $Real - Real - Real$ or $Real - Real - Real$.		14	FAN REMAINING	NO REMAINING ○ 0.5 HOUR ○ 1 HOUR ○ 6 HOUR ○
14	POSITION	POSITION STOP * FREE STOP ○	The louver can stop at any position.		15	FAN REMAINING	NO REMAINING ○ 0.5 HOUR ○ 2 HOUR ○ 6 HOUR ○
15	MODEL TYPE	HEAT PUMP * COOLING ONLY *			16	FAN INTERMITTENCE	NO REMAINING ○ 20min OFF 5min ON ○ 5min OFF 5min ON ○
16	EXTERNAL CONTROL SET	INDIVIDUAL ○ FOR ALL UNITS ○	If you input into the indoor printed circuit board CNT from outside, the indoor device will be operated independently following the input from outside. If you input into indoor printed circuit board CNT from outside, All units which share the same one remote control network work following the input from outside.				
17	ROOM TEMP INDICATION SET	INDICATION OFF ○ INDICATION ON ○	In normal working indication, indoor unit temperature is indicated instead of airflow. (Only the master remote control can be indicated.)				
18	HEATING INDICATION	INDICATION ON ○ INDICATION OFF ○	Heating preparation indication should not be indicated.				
19	TEMP SET	C ○ F ○	Temperature indication is by degree C Temperature indication is by degree F				

(ON/OFF) button (finished) Items marked with * are not available on the floor standing FDF. Do not change the initial setting

④ Trial operation

The method of trial cooling operation

Operate the remote control unit as follows.

1. Starting a cooling test run.

① Start the system by pressing the (ON/OFF) button.

② Select " (Cool) " with the (MODE) button.

③ Press the (TEST) button for 3 seconds or longer.

The screen display will switch to " TEST RUN ".

④ When the (SET) button is pressed while " TEST RUN " is indicated, a cooling test run will start.

The screen display will switch to " TEST RUN ".

2. Ending a cooling test run.

Pressing the (ON/OFF) button, the (TEMP) button or (MODE) button will end a cooling test run. (Cooling test run will end after 30 minutes pass.)

" TEST RUN " shown on the screen will go off.

④ Trial operation (Continued)

Checking operation data

Operation data can be checked with remote control unit operation.

- Press the [CHECK] button.
The display change "OPER DATA ▼"
- Press the (SET) button while "OPER DATA ▼" is displayed.
- When only one indoor unit is connected to remote control, "DATA LOADING" is displayed (blinking indication during data loading).

Next, operation data of the indoor unit will be displayed. Skip to step 7.

- When plural indoor units is connected, the smallest address number of indoor unit among all connected indoor unit is displayed.

[Example]:

SELECT I/U " (blinking 1 seconds) → I/U000 ▲ " blinking.

- Select the indoor unit number you would like to have data displayed with the ▲ ▼ button.
- Determine the indoor unit number with the (SET) button.

(The indoor unit number changes from blinking indication to continuous indication)

I/U000 " (The address of selected indoor unit is blinking for 2 seconds.)



"DATA LOADING" (A blinking indication appears while data loaded.)

Next, the operation data of the indoor unit is indicated.

- Upon operation of the ▲ ▼ button, the current operation data is displayed in order from data number 01.

The items displayed are in the above table.

※Depending on models, the items that do not have corresponding data are not displayed.

- To display the data of a different indoor unit, press the [AIR CON NO.] button, which allows you to go back to the indoor unit selection screen.
- Pressing the (ON/OFF) button will stop displaying data.
Pressing the (RESET) button during remote control unit operation will undo your last operation and allow you to go back to the previous screen.
- If two (2) remote control are connected to one (1) inside unit, only the master control is available for trial operation and confirmation of operation data. (The slave remote control is not available.)

Number	Data Item
01	SE (Operation Mode)
02	SET TEMP (Set Temperature)
03	RETURN AIR (Return Air Temperature)
04	SENSOR (Remote Control Thermistor Temperature)
05	TH-R1 (Indoor Unit Heat Exchanger Thermistor /U Bend)
06	TH-R2 (Indoor Unit Heat Exchanger Thermistor /Capillary)
07	TH-R3 (Indoor Unit Heat Exchanger Thermistor /Gas Header)
08	I/U FAN SPEED (Indoor Unit Fan Speed)
09	DEMAND (Frequency Requirements)
10	ANSWER (Response Frequency)
11	I/U EEV P (Pulse of Indoor Unit Expansion Valve)
12	TOTAL I/U RUN H (Total Running Hours of The Indoor Unit)
21	OUTDOOR (Outdoor Air Temperature)
22	THO-R1 (Outdoor Unit Heat Exchanger Thermistor)
23	THO-R2 (Outdoor Unit Heat Exchanger Thermistor)
24	COMP (Compressor Frequency)
25	HP (High Pressure)
26	LP (Low Pressure)
27	Td (Discharge Pipe Temperature)
28	COMP BOTTOM (Comp Bottom Temperature)
29	CT (Current)
30	TARGET SH (Target Super Heat)
31	SH (Super Heat)
32	TOSH (Discharge Pipe Super Heat)
33	PROTECTION No. (Protection State No. of The Compressor)
34	I/U FAN SPEED (Outdoor Unit Fan Speed)
35	63H1 (63H1 On/Off)
36	DEFROST (Defrost Control On/Off)
37	TOTAL COMP RUN H (Total Running Hours of The Compressor)
38	I/U EEV1 P (Pulse of The Outdoor Unit Expansion Valve EEV1)
39	I/U EEV2 P (Pulse of The Outdoor Unit Expansion Valve EEV2)

※Depending on outdoor unit model, there are data not shown.

⑦ Troubleshooting

The operation data is saved when the situation of abnormal operation happen, and the data can be confirmed by remote control.

Error Code of indoor unit

Display on remote control	LED on indoor circuit board		Content
	red (checking)	green (normal)	
Off	Off	Continuous blinking	Normal
E1	Off	Continuous blinking	Fault on the transmission between indoor circuit board and remote control
E5	Blinking twice	Continuous blinking	Fault on outdoor-indoor transmission
E6	Blinking once	Continuous blinking	Indoor heat exchange sensor interrupted or short-circuit
E7	Blinking once	Continuous blinking	Indoor air inhaling sensor broken or short-circuit
E8	Blinking once	Continuous blinking	The temperature of heat exchange abnormal
E9	Blinking once	Continuous blinking	Float SW actions (only with FS)
E10	Off	Continuous blinking	Excess number of remote control connections
E14	Blinking for three times	Continuous blinking	The communication fault for master/slave indoor units
E16	Blinking once	Continuous blinking	Fan motor abnormal
E19	Blinking once	Continuous blinking	Configuration fault on running checking model
E28	Off	Continuous blinking	Remote control sensor interrupted
Over E30	Off	Continuous blinking	Outdoor unit checking (outdoor circuit board LED checking)

[Operating procedure]

- Press the [CHECK] button.
The display change "OPER DATA ▼"
- Once, press the ▼ button, and the display change "ERROR DATA ▲"
- Press the (SET) button and abnormal operation data mode is started.
- When only one indoor unit is connected to remote control, following is displayed.
 - The case that there is history of abnormal operation.
→ Error code and "DATA LOADING" is displayed.
[Example]: [E8] (ERROR CODE)
"DATA LOADING" is displayed (blinking indication during data loading).
Next, the abnormal operation data of the indoor unit will be displayed. Skip to step 8.
 - The case that there is not history of abnormal operation.
→ "NO ERROR" is displayed for 3 seconds and this mode is closed.
- When plural indoor units is connected, following is displayed.
 - The case that there is history of abnormal operation.
→ Error code and the smallest address number of indoor unit among all connected indoor unit is displayed.
[Example]: [E8] (ERROR CODE)
"I/U000 ▲" blinking
 - The case that there is not history of abnormal operation.
→ Only address number is displayed.
- Select the indoor unit number you would like to have data displayed with the ▲ ▼ button.
- Determine the indoor unit number with the (SET) button.
[Example]: [E8] (ERROR CODE)
"I/U000 ▲" (The address of selected indoor unit is blinking for 2 seconds.)
↓
[E8] "DATA LOADING" (A blinking indication appears while data loaded.)
Next, the abnormal operation data is indicated.
If the indoor unit doing normal operation is selected, "NO ERROR" is displayed for 3 seconds and address of indoor unit is displayed.
- By the ▲ ▼ button, the abnormal operation data is displayed.
Displayed data item is based on (3) Trial operation.
※Depending on models, the items that do not have corresponding data are not displayed.
- To display the data of a different indoor unit, press the [AIR CON No.] button, which allows you to go back to the indoor unit selection screen.
- Pressing the (ON/OFF) button will stop displaying data.
Pressing the (RESET) button during remote control unit operation will undo your last operation and allow you to go back to the previous screen.
- If two (2) remote control are connected to one (1) indoor unit, only the master control is available for trial operation and confirmation of operation data. (The slave remote control is not available.)

⑤ Control mode switching

- The control content of indoor units can be switched in following way. (is the default setting)

Switch No.	Control Content	
SW2	Indoor unit address (0-Fh)	
SW5-1	Master/Slave Switching (plural /Slave unit Setting)	
SW5-2		
SW6-1~4	Model capacity setting	
SW7-1	ON	Operation check, Drain motor test run
	OFF	Normal operation

⑥ Function of CNT connector of indoor printed circuit board

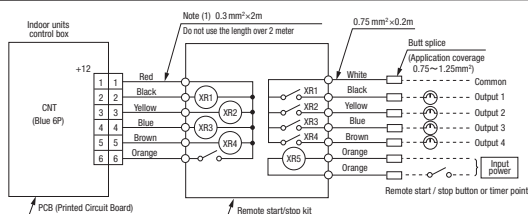

- CNT connector (local) vendor model
Connector : Made by molex 5264 - 06
Terminals : Made by molex 5263T

Function

Output 1	Operation output (there is output when unit is in operation.)
Output 2	Heating output (there is output when operation MODE is HEATING.)
Output 3	Compressor ON output (there is output when compressor is in operation.)
Output 4	Inspection output (there is output when unit is stopped by error.)
Input 5	Remote operation input (Volt-free contact) (Inputted to operate unit)

1.10.3 Installation of wired remote control (option)

PJZ012D077 

(1) Model RC-EX1A

eco touch REMOTE CONTROL RC-EX1A INSTALLATION MANUAL

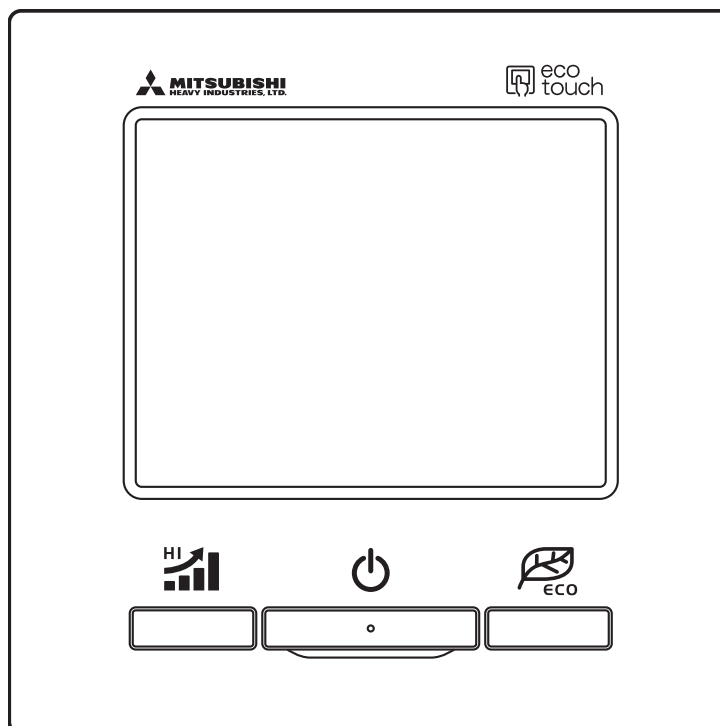



1 . Safety precautions

This installation manual describes the installation methods and precautions related to the remote control. Use this manual together with the user's manuals for the indoor unit, outdoor unit and other optional equipment. Please read this manual carefully before starting the installation work to install the unit properly.

Safety precautions

- Please read this manual carefully before starting installation work to install the unit properly. Every one of the followings is important information to be observed strictly.

 WARNING	Failure to follow these instructions properly may result in serious consequences such as death, severe injury, etc..
 CAUTION	Failure to follow these instructions properly may cause injury or property damage.

It could have serious consequences depending on the circumstances.

- The following pictograms are used in the text.

 Never do.	 Always follow the instructions given.
---	---

- Keep this manual at a safe place where you can consult with whenever necessary. Show this manual to installers when moving or repairing the unit. When the ownership of the unit is transferred, the "Installation Manual" should be given to a new owner.

WARNING

Ask a professional contractor to carry out installation work according to the installation manual.
Improper installation work may result in electric shocks, fire or break-down.



Shut OFF the main power supply before starting electrical work.
Otherwise, it could result in electric shocks, break-down or malfunction.



Do not install the unit in appropriate environment or where inflammable gas could generate, flow in, accumulate or leak.

If the unit is used at places where air contains dense oil mist, steam, organic solvent vapor, corrosive gas (ammonium, sulfuric compound, acid, etc) or where acidic or alkaline solution, special spray, etc. are used, it could cause electric shocks, break-down, smoke or fire as a result of significant deterioration of its performance or corrosion.



Do not install the unit where water vapor is generated excessively or condensation occurs.
It could cause electric shocks, fire or break-down.



Use the specified cables for wiring, and connect them securely with care to protect electronic parts from external forces.

Improper connections or fixing could cause heat generation, fire, etc.



Seal the inlet hole for remote control cable with putty.

If dew, water, insect, etc. enters through the hole, it could cause electric shocks, fire or break-down.



When installing the unit at a hospital, telecommunication facility, etc., take measures to suppress electric noises.

It could cause malfunction or break-down due to hazardous effects on the inverter, private power generator, high frequency medical equipment, radio communication equipment, etc.

The influences transmitted from the remote control to medical or communication equipment could disrupt medical activities, video broadcasting or cause noise interference.



 **CAUTION**

Do not install the remote control at following places.

It could cause break-down or deformation of remote control.

- (1) Where it is exposed to direct sunlight
- (2) Near the equipment to generate heat
- (3) Where the surface is not flat



Do not leave the remote control with its upper case removed.

When the upper case is removed, put it in a packing box or packing bag to protect internal PCBs or other parts from dust, moisture, etc.



2 . Accessories & prepare on site

Accessories	R/C main unit, wood screw (ø3.5 x 16) 2 pcs User's Manual, Installation Manual
-------------	---

Parts procured at site

Item name	Q'ty	Remark
Switch box For 1 piece or 2 pieces (JIS C8340 or equivalent)	1	These are not required when installing directly on a wall.
Thin wall steel pipe for electric appliance (JIS C8305 or equivalent)	As required	
Lock nut, bushing (JIS C8330 or equivalent)	As required	
Lacing (JIS C8425 or equivalent)	As required	Necessary to run R/C cable on the wall.
Putty	Suitably	For sealing gaps
Molly anchor	As required	
R/C cable (0.3 mm ² x 2 pcs)	As required	See right table when longer than 100 m

When the cable length is longer than 100 m, the max size for wires used in the R/C case is 0.5 mm². Connect them to wires of larger size near the outside of R/C. When wires are connected, take measures to prevent water, etc. from entering inside.

< 200 m	0.5 mm ² x 2-core
< 300 m	0.75 mm ² x 2-core
< 400 m	1.25 mm ² x 2-core
< 600 m	2.0 mm ² x 2-core

3. Remote control installation procedure

Determine where to install the remote control

Installation	“Using a switch box” “Installed directly on a wall”
Wiring direction	“Backward” “Upper center”, “Upper left”

Cautions for selecting installation place

- (1) Installation surface must be flat and sufficiently strong.
R/C case must not be deformed.
- (2) Where the R/C can detect room temperatures accurately.
This is a must when detecting room temperatures with the temperature sensor of R/C.
 - Install the R/C where it can detect the average temperature in the room.
 - Install the R/C separated from a heat source sufficiently.
 - Install the R/C where it will not be influenced by the turbulence of air when the door is opened or closed.
 Select a place where the R/C is not exposed to direct sunlight or blown by winds from the air conditioner or temperatures on the wall surface will not deviate largely from actual room temperature.

Installation space

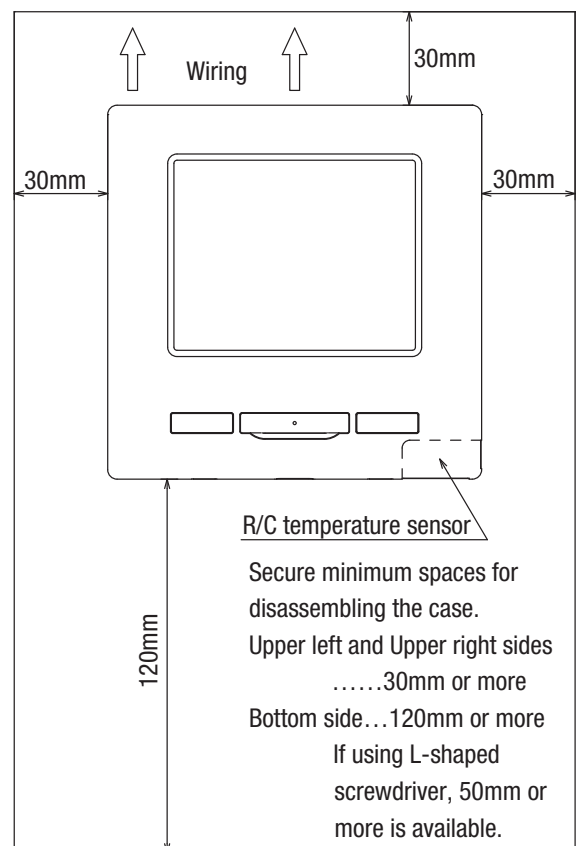

Request

Be sure not to install R/C at a place where temperatures around the installation surface of R/C may differ largely from actual room temperature.
 Difference between detected temperature and actual room temperature could cause troubles.
 The correction for detected temperature by the R/C cannot offset such temperature difference because it corrects the detected temperatures itself.



Request

Do not install the R/C at a place where it is exposed to direct sunlight or where surrounding air temperature exceeds 40°C or drops below 0°C.
 It could cause discoloration, deformation, malfunction or breakdown.



Installation procedure

Dimensions (Viewed from front)

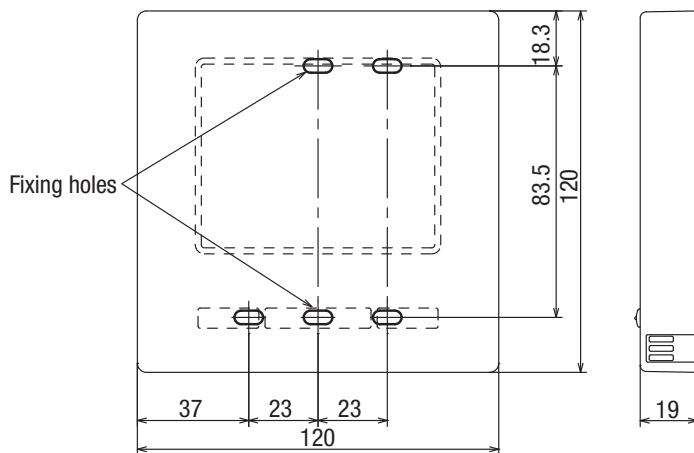

PCB side (Viewed from rear)

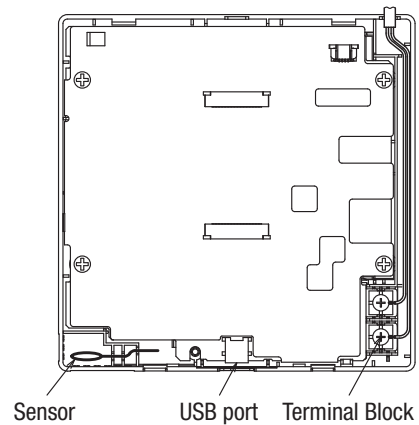

- ① To remove the upper case from the bottom cases of R/C
 - Insert the tip of flat head screwdriver or the like in the recess at the lower part of R/C and twist it lightly to remove.

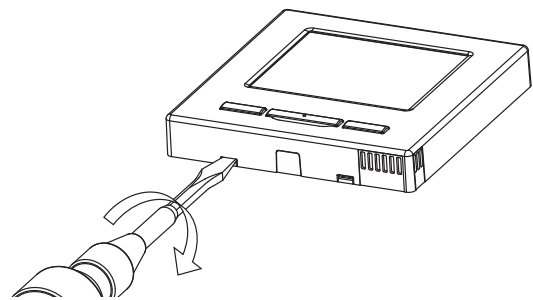

Take care to protect the removed upper case from moisture or dust.

- ② Connect wires from X and Y terminals of R/C to X and Y terminals of indoor unit.
 R/C wires (X, Y) have no polarity.

In case of embedding wiring (When the wiring is retrieved "Backward")

- ③ Embed the switch box and the R/C wires beforehand.

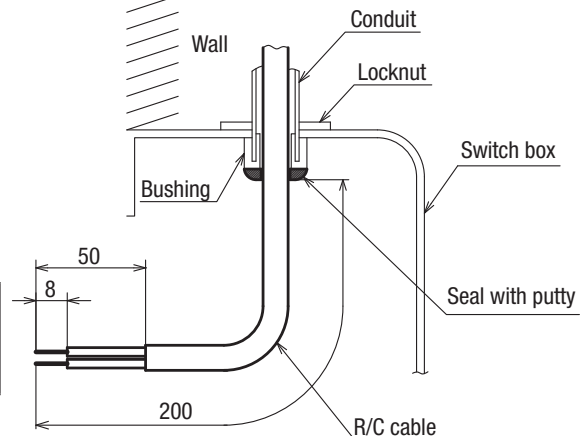

Seal the inlet hole for the R/C wiring with putty.
 ● If dust or insect enters, it could cause electric shocks, fire or breakdown.

- ④ When wires are passed through the bottom case, fix the bottom case at 2 places on the switch box.

Switch box
for 1 pc

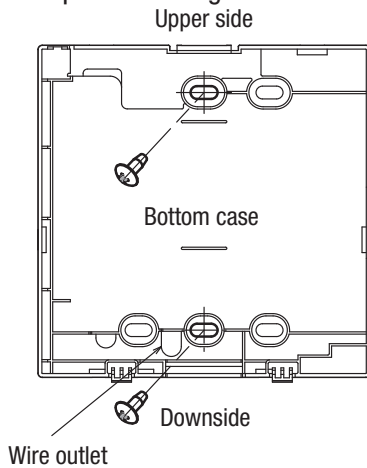

Switch box
for 2 pcs

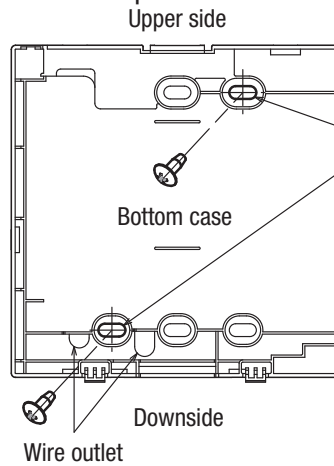

Cut out the thin wall part at the screw mounting section with a knife or the like before tightening the screw.

- ⑤ When fixing the bottom case diagonally at 2 places, cut out the thin wall section on the case.
 ⑥ Fix wires such that the wires will run around the terminal screws on the top case of R/C.

Cautions for wire connection
 Use wires of no larger than 0.5 mm² for wiring running through the remote control case. Take care not to pinch the sheath.
 Tighten by hand (0.7 N·m or less) the wire connection. If the wire is connected using an electric driver, it may cause failure or deformation.

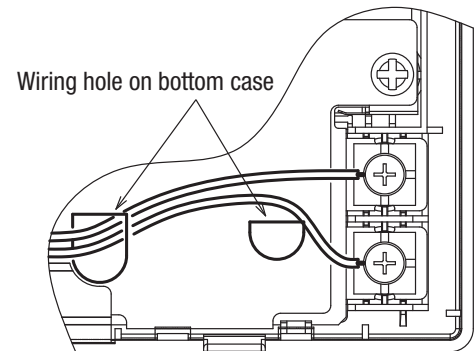

- ⑦ Install the upper case with care not to pinch wires of R/C.

In case of exposing wiring (When the wiring is taken out from the “upper center” or “upper left” of R/C)

- ③ Cut out the thin wall sections on the cases for the size of wire.

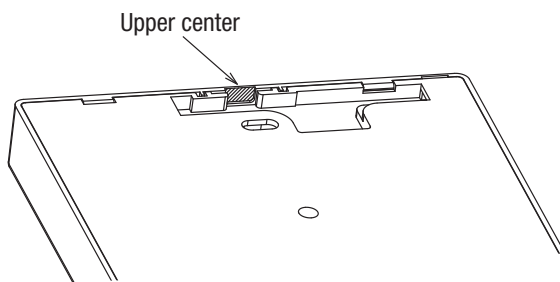

When taking the wiring out from the upper center, open a hole before separating the upper and bottom cases. This will reduce risk of damaging the PCB and facilitate subsequent work.

 When taking the wiring out from the upper left, take care not to damage the PCB and not to leave any chips of cut thin wall inside.

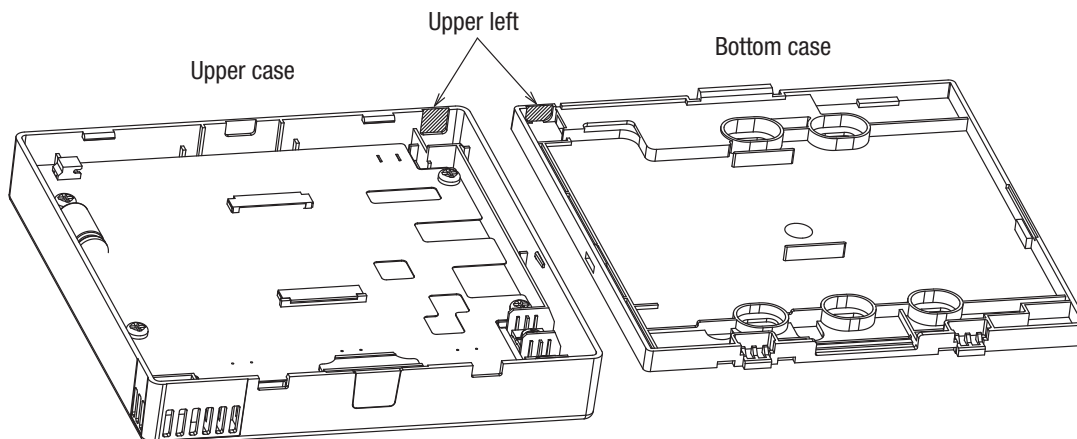

If the hole is cut too large, moisture, dust or insects may enter.
Seal gaps with putty or the like.



- ④ Fix the bottom R/C case on a flat surface with wood screws.
- ⑤ In case of the upper center, pass the wiring behind the bottom case. (Hatched section)
- ⑥ Fix wires such that the wires will run around the terminal screw of the top case of R/C.
- ⑦ Install the top case with care not to pinch wires of R/C.

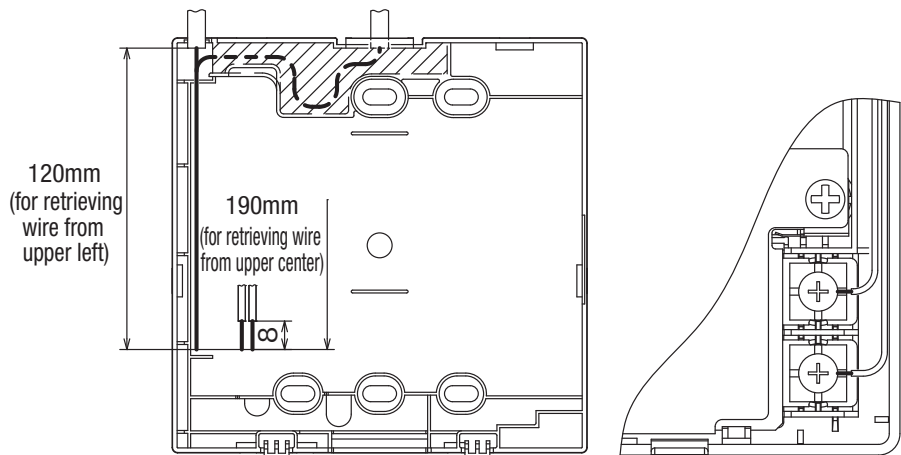

Main/Sub setting when more than one remote control are used

Main-Sub setting for use of two or more R/C

Up to two units of R/C can be used at the maximum for 1 indoor unit or 1 group.

One is main R/C and the other is sub R/C.

Operating range is different depending on the main or sub R/C.

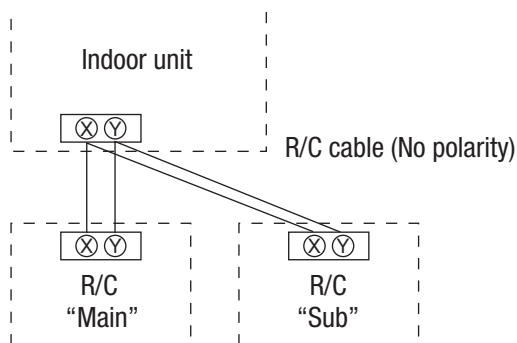

Set the "Main" and "Sub" as described at Section 7 of installation manual attached to the remote control.

R/C function	Main	Sub
Run/Stop, setting temperature, fan speed and flap direction operations	○	○
High power and energy-saving operations	○	○
Energy-saving setting	○	—
R/C sensor	○	—
Test run menu operation	○	—
Room temperature range setting	○	—
Indoor unit settings	○	—
Individual flap control	○	—
Operation data display	○	—
Error history display	○	○

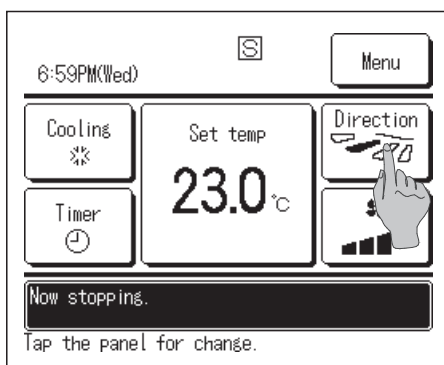

Note: Connection to personal computer

It can be set from a personal computer via the USB port (mini-B).
Connect after removing the cover for USB port of upper case.

Replace the cover after use.

If dust, insect, etc. enters, it could cause electric shocks or breakdown.



Special software is necessary for the connection.
For details, view the web site or refer to the engineering data.

Do not connect to a personal computer without using the special software.

Do not connect the personal computer to the USB simultaneously with other USB devices.
It could cause malfunction or breakdown of R/C or personal computer.

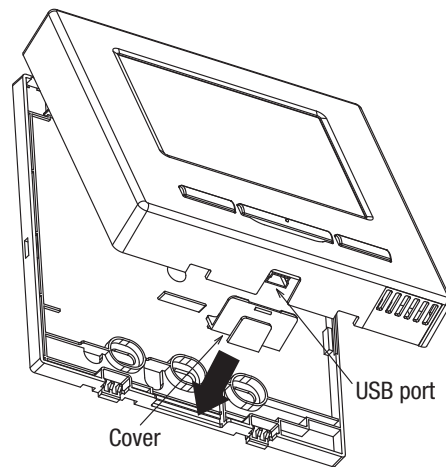

Note: Initializing of password

Administrator password (for daily setting items) and service password (for installation, test run and maintenance) are used.

- The administrator password at factory default is "0000". This setting can be changed (Refer to User's Manual). When the administrator password is forgotten, it can be initialized, if the [Highpower] and the [Energy-saving] buttons are pushed simultaneously for 5 seconds on the administrator password input screen.
- Service password is "9999", which cannot be changed.
When the administrator password is input, the service password is also accepted.

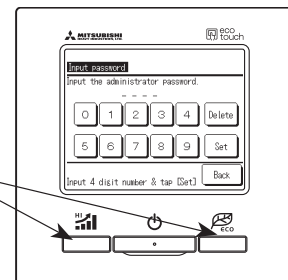

(2) Model RC-E5

PJA012D730

Read together with indoor unit's installation manual.

⚠ WARNING

- Fasten the wiring to the terminal securely and hold the cable securely so as not to apply unexpected stress on the terminal.
Loose connection or hold will cause abnormal heat generation or fire. !
- Make sure the power supply is turned off when electric wiring work.
Otherwise, electric shock, malfunction and improper running may occur. !

⚠ CAUTION

- DO NOT install the remote control at the following places in order to avoid malfunction.

(1) Places exposed to direct sunlight	(4) Hot surface or cold surface enough to generate condensation
(2) Places near heat devices	(5) Places exposed to oil mist or steam directly
(3) High humidity places	(6) Uneven surface

⊘
- DO NOT leave the remote control without the upper case.
In case the upper case needs to be detached, protect the remote control with a packaging box or bag in order to keep it away from water and dust. ⊘

Accessories	Remote control, wood screw (ø3.5×16) 2 pieces
Prepare on site	Remote control cord (2 cores) the insulation thickness in 1mm or more. [In case of embedding cord] Electrical box, M4 screw (2 pieces) [In case of exposing cord] Cord clamp (if needed)

Installation procedure

- ① Open the cover of remote control, and remove the screw under the buttons without fail.
- ② Remove the upper case of remote control.
Insert a flat-blade screwdriver into the dented part of the upper part of the remote control, and wrench slightly.

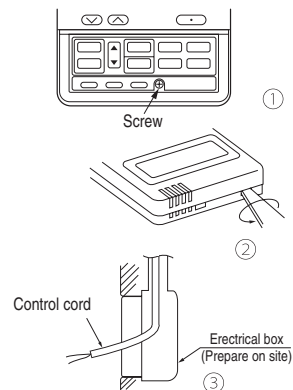

[In case of embedding cord]

- ③ Embed the electrical box and remote control cord beforehand.

- ④ Prepare two M4 screws (recommended length is 12-16mm) on site, and install the lower case to electrical box.
Choose either of the following two positions in fixing it with screws.

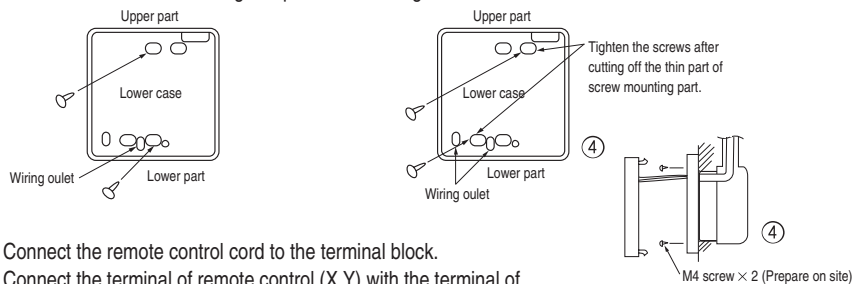

- ⑤ Connect the remote control cord to the terminal block.
Connect the terminal of remote control (X,Y) with the terminal of indoor unit (X,Y). (X and Y are no polarity)

- ⑥ Install the upper case as before so as not to catch up the remote control cord, and tighten with the screws.

[In case of exposing cord]

- ③ You can pull out the remote control cord from left upper part or center upper part.
Cut off the upper thin part of remote control lower case with a nipper or knife, and grind burrs with a file etc.
- ④ Install the lower case to the flat wall with attached two wooden screws.

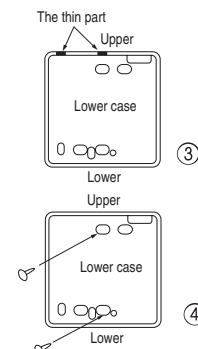

- ⑤ Connect the remote control cord to the terminal block.
 Connect the terminal of remote control (X,Y) with the terminal of indoor unit (X,Y).
 (X and Y are no polarity)
 Wiring route is as shown in the right diagram depending on the pulling out direction.

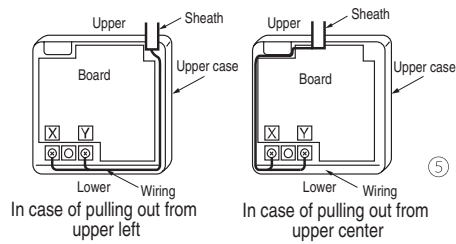

The wiring inside the remote control case should be within 0.3mm² (recommended) to 0.5mm².
 The sheath should be peeled off inside the remote control case.
 The peeling-off length of each wire is as below.

Pulling out from upper left	Pulling out from upper center
X wiring : 215mm	X wiring : 170mm
Y wiring : 195mm	Y wiring : 190mm

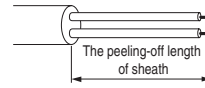

- ⑥ Install the upper case as before so as not to catch up the remote control cord, and tighten with the screws.
 ⑦ In case of exposing cord, fix the cord on the wall with cord clamp so as not to slack.

Installation and wiring of remote control

- ① Wiring of remote control should use 0.3mm² × 2 core wires or cables. (on-site configuration)
 ② Maximum prolongation of remote control wiring is 600 m.
 If the prolongation is over 100m, change to the size below.
 But, wiring in the remote control case should be under 0.5mm². Change the wire size outside of the case according to wire connecting. Waterproof treatment is necessary at the wire connecting section. Be careful about contact failure.
 100 - 200m.....0.5mm² × 2 cores
 Under 300m.....0.75mm² × 2 cores
 Under 400m.....1.25mm² × 2 cores
 Under 600m.....2.0mm² × 2 cores

Master/ slave setting when more than one remote controls are used

A maximum of two remote controls can be connected to one indoor unit (or one group of indoor units.)

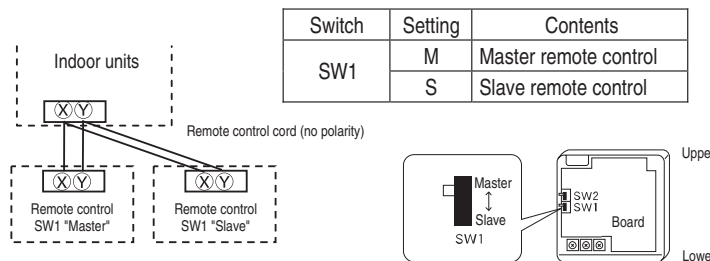

Set SW1 to "Slave" for the slave remote control. It was factory set to "Master" for shipment.
 Note: The setting "Remote control thermistor enabled" is only selectable with the master remote control in the position where you want to check room temperature.
 The air conditioner operation follows the last operation of the remote control regardless of the master/ slave setting of it.

The indication when power source is supplied

When power source is turned on, the following is displayed on the remote control until the communication between the remote control and indoor unit settled.

Master remote control : " WAIT M"
 Slave remote control : " WAIT S"

At the same time, a mark or a number will be displayed for two seconds first.
 This is the software's administration number of the remote control, not an error cord.

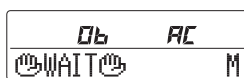

※ The left mark is only an example. Other marks may appear.

When remote control cannot communicate with the indoor unit for half an hour, the below indication will appear.
 Check wiring of the indoor unit and the outdoor unit etc.



The range of temperature setting

When shipped, the range of set temperature differs depending on the operation mode as below.

Heating : 16~30°C (55~86°F)

Except heating (cooling, fan, dry, automatic) : 18~30°C (62~86°F)

●Upper limit and lower limit of set temperature can be changed with remote control.

Upper limit setting: valid during heating operation. Possible to set in the range of 20 to 30°C (68 to 86°F).

Lower limit setting: valid except heating (automatic, cooling, fan, dry) Possible to set in the range of 18 to 26°C (62 to 79°F).

When you set upper and lower limit by this function, control as below.

- When ② TEMP RANGE SET, remote control function of function setting mode is "INDN CHANGE" (factory setting),
 【 If upper limit value is set 】
 During heating, you cannot set the value exceeding the upper limit.
 【 If lower limit value is set 】
 During operation mode except heating, you cannot set the value below the lower limit.
- When ② TEMP RANGE SET, remote control function of function setting mode is "NO INDN CHANGE"
 【 If upper limit value is set 】
 During heating, even if the value exceeding the upper limit is set, upper limit value will be sent to the indoor unit.
 But, the indication is the same as the temperature set.
 【 If lower limit value is set 】
 During except heating, even if the value lower than the lower limit is set, lower limit value will be sent to the indoor unit.
 But, the indication is the same as the temperature set.

●How to set upper and lower limit value

- Stop the air-conditioner, and press (SET) and (MODE) button at the same time for over three seconds.
 The indication changes to "FUNCTION SET ▼".
- Press button once, and change to the "TEMP RANGE ▲" indication.
- Press (SET) button, and enter the temperature range setting mode.
- Select "UPPER LIMIT ▼" or "LOWER LIMIT ▲" by using button.
- Press (SET) button to fix.
- When "UPPER LIMIT ▼" is selected (valid during heating)
 - ① Indication: " ▼ ^ SET UP" → "UPPER 30°C ▼"
 - ② Select the upper limit value with temperature setting button . Indication example: "UPPER 26°C ▼ ^" (blinking)
 - ③ Press (SET) button to fix. Indication example: "UPPER 26°C" (Displayed for two seconds)
 After the fixed upper limit value displayed for two seconds, the indication will return to "UPPER LIMIT ▼".
- When "LOWER LIMIT ▲" is selected (valid during cooling, dry, fan, automatic)
 - ① Indication: " ▼ ^ SET UP" → "LOWER 18°C ^"
 - ② Select the lower limit value with temperature setting button . Indication example: "LOWER 24°C ▼ ^" (blinking)
 - ③ Press (SET) button to fix. Indication for example: "LOWER 24°C" (Displayed for two seconds)
 After the fixed lower limit value displayed for two seconds, the indication will return to "LOWER LIMIT ▼".
- Press button to finish.

• It is possible to finish by pressing button on the way, but unfinished change of setting is unavailable.

• During setting, if you press (RESET) button, you return to the previous screen.

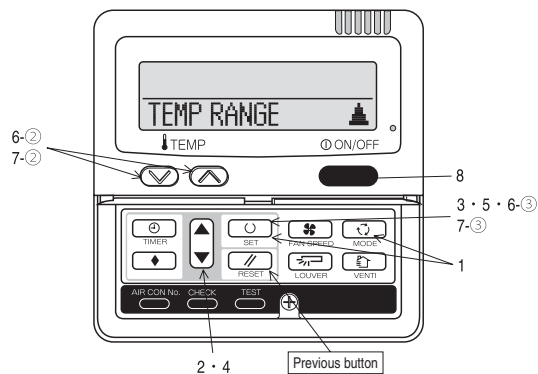

The functional setting

- The initial function setting for typical using is performed automatically by the indoor unit connected, when remote control and indoor unit are connected.
- As long as they are used in a typical manner, there will be no need to change the initial settings.
- If you would like to change the initial setting marked "○", set your desired setting as for the selected item.
- The procedure of functional setting is shown as the following diagram.

[Flow of function setting]

Start : Stop air-conditioner and press "○" (SET) and "MODE" (MODE) buttons at the same time for over three seconds.
 Finalize : Press "○" (SET) button.
 Reset : Press "RESET" (RESET) button.
 Select : Press "▲" (UP) button.
 End : Press "ON/OFF" button.

It is possible to finish above setting on the way, and unfinished change of setting is unavailable.
 "○": Initial settings
 "※": Automatic criterion

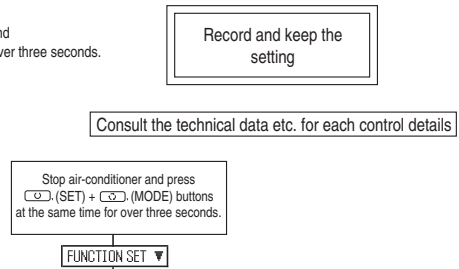

To next page

FUNCTION (Remote control function)

Function	setting	
01 ESP SET	ESP VALID	○ Validate setting of ESP: External Static Pressure
	ESP INVALID	○ Invalidate setting of ESP
02 AUTO RUN SET	AUTO RUN ON	※ Automatic operation is impossible
	AUTO RUN OFF	※ Automatic operation is impossible
03 TEMP SW	VALID	○ Temperature setting button is not working
	INVALID	○ Temperature setting button is not working
04 MODE SW	VALID	○ Mode button is not working
	INVALID	○ Mode button is not working
05 ON/OFF SW	VALID	○ On/Off button is not working
	INVALID	○ On/Off button is not working
06 FAN SPEED SW	VALID	※ Fan speed button is not working
	INVALID	※ Fan speed button is not working
07 LOUVER SW	VALID	※ Louver button is not working
	INVALID	※ Louver button is not working
08 TIMER SW	VALID	○ Timer button is not working
	INVALID	○ Timer button is not working
09 SENSOR SET	SENSOR OFF	○ Remote thermistor is not working.
	SENSOR ON	○ Remote thermistor is working.
	SENSOR +3.0℃	○ Remote thermistor is working, and to be set for producing +3.0℃ increase in temperature.
	SENSOR +2.0℃	○ Remote thermistor is working, and to be set for producing +2.0℃ increase in temperature.
	SENSOR +1.0℃	○ Remote thermistor is working, and to be set for producing +1.0℃ increase in temperature.
	SENSOR -1.0℃	○ Remote thermistor is working, and to be set for producing -1.0℃ increase in temperature.
	SENSOR -2.0℃	○ Remote thermistor is working, and to be set for producing -2.0℃ increase in temperature.
10 AUTO RESTART	INVALID	○
	VALID	○
11 VENT LINK SET	NO VENT	○ In case of Single split series, by connecting ventilation device to CNT of the indoor printed circuit board (in case of VRF series, by connecting it to CND of the indoor printed circuit board), the operation of ventilation device is linked with the operation of indoor unit.
	VENT LINK	○ In case of Single split series, by connecting ventilation device to CNT of the indoor printed circuit board (in case of VRF series, by connecting it to CND of the indoor printed circuit board), you can operate /stop the ventilation device independently by (VENT) button.
	NO VENT LINK	○ In case of Single split series, by connecting ventilation device to CNT of the indoor printed circuit board (in case of VRF series, by connecting it to CND of the indoor printed circuit board), you can operate /stop the ventilation device independently by (VENT) button.
12 TEMP RANGE SET	INDN CHANGE	○ If you change the range of set temperature, the indication of set temperature will vary following the control.
	NO INDN CHANGE	○ If you change the range of set temperature, the indication of set temperature will not vary following the control, and keep the set temperature.
13 I/U FAN	HI-MID-LO	※ Airflow of fan becomes of HI-MID-LO or the four speed of HI-MID-LO.
	HI-LO	※ Airflow of fan becomes of HI-LO.
	HI-MID	※ Airflow of fan becomes of HI-MID.
	1 FAN SPEED	※ Airflow of fan is fixed at one speed.
14 POSITION	POSITION STOP	○ If you change the remote control function "14 POSITION", you must change the indoor function "04 POSITION" accordingly. You can select the louver stop position in the four.
	FREE STOP	○ The louver can stop at any position.
15 MODEL TYPE	HEAT PUMP	※
	COOLING ONLY	※
16 EXTERNAL CONTROL SET	INDIVIDUAL	○ If you input signal into CNT of the indoor printed circuit board from external, the indoor unit will be operated independently according to the input from external.
	FOR ALL UNITS	○ If you input into CNT of the indoor printed circuit board from external, all units which connect to the same remote control are operated according to the input from external.
17 ROOM TEMP INDICATION SET	INDICATION OFF	○ In normal working indication, indoor unit temperature is indicated instead of airflow.
	INDICATION ON	○ (Only the master remote control can be indicated.)
18 INDICATION	INDICATION ON	○ Heating preparation indication should not be indicated.
	INDICATION OFF	○ Heating preparation indication should not be indicated.
19 °C/°F SET	°C	○ Temperature indication is by degree C
	°F	○ Temperature indication is by degree F

To next page

ON/OFF button (finished)

Note 1: The initial setting marked "※" is decided by connected indoor and outdoor unit, and is automatically defined as following table.

Function No.	Item	Default	Model
Remote control function02	AUTO RUN SET	AUTO RUN ON	"Auto-RUN" mode selectable indoor unit.
		AUTO RUN OFF	Indoor unit without "Auto-RUN" mode
Remote control function06	FAN SPEED SW	VALID	Indoor unit with two or three step of air flow setting
		INVALID	Indoor unit with only one of air flow setting
Remote control function07	LOUVER SW	VALID	Indoor unit with automatically swing louver
		INVALID	Indoor unit without automatically swing louver
Remote control function13	I/U FAN	HI-MID-LO	Indoor unit with three step of air flow setting
		HI-LO	Indoor unit with two step of air flow setting
		HI-MID	
		1 FAN SPEED	Indoor unit with only one of air flow setting
Remote control function15	MODEL TYPE	HEAT PUMP	Heat pump unit
		COOLING ONLY	Exclusive cooling unit

Note 3: As for plural indoor unit, set indoor functions to each master and slave indoor unit.

But only master indoor unit is received the setting change of indoor unit function "05 EXTERNAL INPUT" and "06 PERMISSION / PROHIBITION".

From previous page

Indoor unit No. are indicated only when
(Indoor unit function) I/U FUNCTION ▲ plural indoor units are connected.

Function

I/U000 ▲
I/U001 ▼
I/U002 ▼
I/U003 ▼
I/U004 ▼

To set other indoor unit, press [AIRCON NO.] button, which allows you to go back to the indoor unit selection screen (for example: I/U 000 ▲).

Function	setting
02 FAN SPEED SET	STANDARD ※ HIGH SPEED 1 ※ HIGH SPEED 2
03 FILTER SIGN SET	INDICATION OFF TYPE 1 ○ TYPE 2 TYPE 3 TYPE 4
04 POSITION	4 POSITION STOP ○ FREE STOP
05 EXTERNAL INPUT	LEVEL INPUT ○ PULSE INPUT
06 OPERATION PERMISSION/PROHIBITION	INVALID ○ VALID
07 EMERGENCY STOP	INVALID ○ VALID
08 ※ SP OFFSET	OFFSET +3.0℃ OFFSET +2.0℃ OFFSET +1.0℃ NO OFFSET ○
09 RETURN AIR TEMP	OFFSET +2.0℃ OFFSET +1.5℃ OFFSET +1.0℃ NO OFFSET ○ OFFSET -1.0℃ OFFSET -1.5℃ OFFSET -2.0℃
10 ※ FAN CONTROL	LOW FAN SPEED ○ SET FAN SPEED INTERMITTENCE FAN OFF
11 FROST PREVENTION TEMP	TEMP HIGH TEMP LOW ○
12 FROST PREVENTION CONTROL	FAN CONTROL ON ○ FAN CONTROL OFF
13 DRAIN PUMP LINK	○ AND ○ ○ AND ○ AND ○ ○ AND ○ AND ○
14 ※ FAN REMAINING	NO REMAINING ○ 0.5 HOUR 1 HOUR 6 HOUR
15 ※ FAN REMAINING	NO REMAINING ○ 0.5 HOUR 2 HOUR 6 HOUR
16 ※ FAN INTERMITTENCE	NO REMAINING ○ 20min OFF 5min ON 5min OFF 5min ON
17 PRESSURE CONTROL	STANDARD ※ TYPE1 ※

Note2: Fan setting of "HIGH SPEED"

Fan tap	Indoor unit air flow setting				
	Hi - Hi - Me - Lo	Hi - Me - Lo	Hi - Lo	Hi - Me	Hi - Hi
FAN SPEED SET	STANDARD	UH - Hi - Me - Lo	Hi - Me - Lo	Hi - Lo	Hi - Me
	HIGH SPEED1, 2	UH - UH - Hi - Me	UH - Hi - Me	UH - Me	UH - Hi

Initial function setting of some indoor unit is "HIGH SPEED".
4 speed is not able to be set with wireless remote control.

The filter sign is indicated after running for 180 hours.
The filter sign is indicated after running for 600 hours.
The filter sign is indicated after running for 1000 hours.
The filter sign is indicated after running for 1000 hours, then the indoor unit will be stopped by compulsion after 24 hours.

If you change the indoor function "04 POSITION", you must change the remote control function "14 POSITION" accordingly.
You can select the lower stop position in the four.
The louver can stop at any position.

Permission/prohibition control of operation will be valid.

With the VRF series, it is used to stop all indoor units connected with the same outdoor unit immediately.
When stop signal is inputted from remote on-off terminal "CNT-6", all indoor units are stopped immediately.

To be reset for producing +3.0℃ increase in temperature during heating.
To be reset for producing +2.0℃ increase in temperature during heating.
To be reset for producing +1.0℃ increase in temperature during heating.

To be reset producing +2.0℃ increase in return air temperature of indoor unit.
To be reset producing +1.5℃ increase in return air temperature of indoor unit.
To be reset producing +1.0℃ increase in return air temperature of indoor unit.

To be reset producing -1.0℃ increase in return air temperature of indoor unit.
To be reset producing -1.5℃ increase in return air temperature of indoor unit.
To be reset producing -2.0℃ increase in return air temperature of indoor unit.

When heating thermostat is OFF, fan speed is low speed.
When heating thermostat is OFF, fan speed is set speed.

When heating thermostat is OFF, fan speed is operated intermittently.
When heating thermostat is OFF, the fan is stopped.
When the remote thermostat is working, "FAN OFF" is set automatically.
Do not set "FAN OFF" when the indoor unit's thermostat is working.

Change of indoor heat exchanger temperature to start frost prevention control.

Working only with the Single split series.
To control frost prevention, the indoor fan tap is raised.

Drain pump is run during cooling and dry.
Drain pump is run during cooling, dry and heating.
Drain pump is run during cooling, dry, heating and fan.
Drain pump is run during cooling, dry and fan.

After cooling is stopped, the fan does not perform extra operation.
After cooling is stopped, the fan perform extra operation for half an hour.
After cooling is stopped, the fan perform extra operation for an hour.
After cooling is stopped, the fan perform extra operation for six hours.

After heating is stopped or heating thermostat is OFF, the fan does not perform extra operation.
After heating is stopped or heating thermostat is OFF, the fan perform extra operation for half an hour.
After heating is stopped or heating thermostat is OFF, the fan perform extra operation for two hours.
After heating is stopped or heating thermostat is OFF, the fan perform extra operation for six hours.

During heating is stopped or heating thermostat is OFF, the fan perform intermittent operation for five minutes with low fan speed after twenty minutes' OFF.
During heating is stopped or heating thermostat is OFF, the fan perform intermittent operation for five minutes with low fan speed after five minutes' OFF.

Connected "OA Processing" type indoor unit, and is automatically defined.

From previous page

How to set function

1. Stop air-conditioner and press (SET) (MODE) buttons at the same time for over three seconds, and the "FUNCTION SET ▼" will be displayed.



2. Press (SET) button.
3. Make sure which do you want to set, "FUNCTION ▼" (remote control function) or "I/U FUNCTION ▲" (indoor unit function).
4. Press or button.
Select "FUNCTION ▼" (remote control function) or "I/U FUNCTION ▲" (indoor unit function).

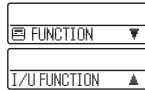

5. Press (SET) button.

6. [On the occasion of remote control function selection]

- ① "DATA LOADING" (Indication with blinking)
↓
Display is changed to "01 ESP SET".
- ② Press or button.
"No. and function" are indicated by turns on the remote control function table, then you can select from them.
(For example)

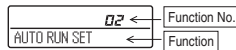

- ③ Press (SET) button.
The current setting of selected function is indicated.
(for example) "AUTO RUN ON" ← If "02 AUTO RUN SET" is selected

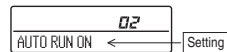

- ④ Press or button.
Select the setting.

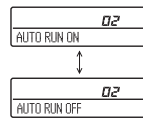

- ⑤ Press (SET)
"SET COMPLETE" will be indicated, and the setting will be completed.
Then after "No. and function" indication returns, set as the same procedure if you want to set continuously, and if to finish, go to 7.



7. Press (ON/OFF) button.
Setting is finished.

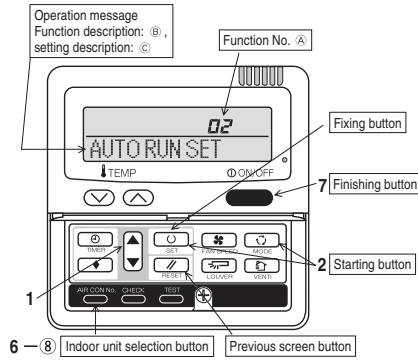

[On the occasion of indoor unit function selection]

- ① "DATA LOADING" (Blinking for 2 to 23 seconds to read the data)
↓
Indication is changed to "02 FAN SPEED SET".
Go to ②.

[Note]

- (1) If plural indoor units are connected to a remote control, the indication is "I/U 000" (blinking) ← The lowest number of the indoor unit connected is indicated.

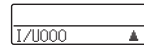

- (2) Press or button.
Select the number of the indoor unit you are to set
If you select "ALL UNIT ▼", you can set the same setting with all units.

- (3) Press (SET) button.

- ② Press or button.
"No. and function" are indicated by turns on the indoor unit function table, then you can select from them.
(For example)

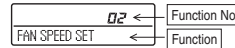

- ③ Press (SET) button.
The current setting of selected function is indicated.
(For example) "STANDARD" ← If "02 FAN SPEED SET" is selected.

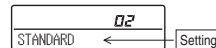

- ④ Press or button.
Select the setting.

- ⑤ Press (SET) button.
"SET COMPLETE" will be indicated, and the setting will be completed.
Then after "No. and function" indication returns, set as the same procedure if you want to set continuously, and if to finish, go to 7.



※ When plural indoor units are connected to a remote control, press the (AIRCON NO.) button, which allows you to go back to the indoor unit selection screen. (example "I/U 000 ▲")

- It is possible to finish by pressing (ON/OFF) button on the way, but unfinished change of setting is unavailable.
- During setting, if you press (RESET) button, you return to the previous screen.
- Setting is memorized in the control and it is saved independently of power failure.

[How to check the current setting]

When you select from "No. and function" and press set button by the previous operation, the "Setting" displayed first is the current setting.
(But, if you select "ALL UNIT ▼", the setting of the lowest number indoor unit is displayed.)

1.10.4 Installation of outdoor unit



(1) Models FDC100-140VN, 100-140VS

Inverter driven split PAC
100VN~140VN,100VS~140VS
100VNX~140VNX,100VSX~140VSX
Designed for R410A refrigerant

- ◎ This installation manual deals with outdoor units and general installation specifications only. For indoor units, refer to page 209.
- ◎ When install the unit, be sure to check whether the selection of installation place, power supply specifications, usage limitation (piping length, height differences between indoor and outdoor units, power supply voltage and etc.) and installation spaces

SAFETY PRECAUTIONS

- We recommend you to read this "SAFETY PRECAUTIONS" carefully before the installation work in order to gain full advantage of the functions of the unit and avoid malfunction due to mishandling.
- The precautions described below are divided into **WARNING** and **CAUTION**. The matters with possibilities leading to serious consequences such as death or serious personal injury due to erroneous handling are listed in the **WARNING** and the matters with possibilities leading to personal injury or damage of the unit due to erroneous handling including probability leading to serious consequences in some cases are listed in **CAUTION**. **These are very important precautions for safety. Be sure to observe all of them without fail.**
- The meaning of "Marks" used here are as shown below.

	Never do it under any circumstance.			Always do it according to the instruction
---	-------------------------------------	---	---	---
- For 3 phase power source outdoor unit, EN61000-3-2 is not applicable if consent by the utility company or notification to the utility company is given before usage.
- 3 phase power source unit, both indoor and outdoor, is suitable for installation in a commercial and light industrial environment. If installed as a house-hold appliance it could cause electromagnetic interference.
- 5 and 6 HP units of single phase power source are equipment complying with IEC 61000-3-12.
- Be sure to confirm no anomaly on the equipment by commissioning after completed installation and explain the operating methods as well as the maintenance methods of this equipment to the user according to the owner's manual.
- Keep the installation manual together with owner's manual at a place where any user can read at any time. Moreover if necessary, ask to hand them to a new user

Check before installation work

[Accessory]

Edging		1 piece	knock-out hole protection
--------	---	---------	---------------------------

- Model name and power source
- Refrigerant piping length
- Piping, wiring and miscellaneous small parts
- Indoor unit installation manual



WARNING



- **Installation must be carried out by the qualified installer.**
If you install the system by yourself, it may cause serious trouble such as water leaks, electric shocks, fire and personal injury, as a result of a system malfunction.
- **Install the system in full accordance with the instruction manual.**
Incorrect installation may cause bursts, personal injury, water leaks, electric shocks and fire.
- **Use the original accessories and the specified components for installation.**
If parts other than those prescribed by us are used, it may cause fall of the unit, water leaks, electric shocks, fire, refrigerant leak, substandard performance, control failure and personal injury.
- **When installing in small rooms, take prevention measures not to exceed the density limit of refrigerant in the event of leakage accordance with ISO5149.**
Consult the expert about prevention measures. If the density of refrigerant exceeds the limit in the event of leakage, lack of oxygen can occur, which can cause serious accidents.
- **Ventilate the working area well in the event of refrigerant leakage during installation.**
If the refrigerant comes into contact with naked flames, poisonous gas is produced.
- **After completed installation, check that no refrigerant leaks from the system.**
If refrigerant leaks into the room and comes into contact with an oven or other hot surface, poisonous gas is produced.
- **Hang up the unit at the specified points with ropes which can support the weight in lifting for portage. And to avoid jolting out of alignment, be sure to hang up the unit at 4-point support.**
An improper manner of portage such as 3-point support can cause death or serious personal injury due to falling of the unit
- **Install the unit in a location with good support.**
Unsuitable installation locations can cause the unit to fall and cause material damage and personal injury.
- **Ensure the unit is stable when installed, so that it can withstand earthquakes and strong winds.**
Unsuitable installation locations can cause the unit to fall and cause material damage and personal injury.
- **The electrical installation must be carried out by the qualified electrician in accordance with "the norm for electrical work" and "national wiring regulation", and the system must be connected to the dedicated circuit.**
Power supply with insufficient capacity and incorrect function done by improper work can cause electric shocks and fire.
- **Be sure to shut off the power before starting electrical work.**
Failure to shut off the power can cause electric shocks, unit failure or incorrect function of equipment.
- **Be sure to use the cables conformed to safety standard and cable ampacity for power distribution work.**
Unconformable cables can cause electric leak, anomalous heat production or fire.
- **Use the prescribed cables for electrical connection, tighten the cables securely in terminal block and relieve the cables correctly to prevent overloading the terminal blocks.**
Loose connections or cable mountings can cause anomalous heat production or fire.
- **Arrange the wiring in the control box so that it cannot be pushed up further into the box. Install the service panel correctly.**
Incorrect installation may result in overheating and fire.



- **Do not perform brazing work in the airtight room**
It can cause lack of oxygen.
- **Use the prescribed pipes, flare nuts and tools for R410A.**
Using existing parts (for R22 or R407C) can cause the unit failure and serious accidents due to burst of the refrigerant circuit.
- **Tighten the flare nut by using double spanners and torque wrench according to prescribed method. Be sure not to tighten the flare nut too much.**
Loose flare connection or damage on the flare part by tightening with excess torque can cause burst or refrigerant leaks which may result in lack of oxygen.
- **Do not open the service valves for liquid line and gas line until completed refrigerant piping work, air tightness test and evacuation.**
If the compressor is operated in state of opening service valves before completed connection of refrigerant piping work, you may incur frost bite or injury from an abrupt refrigerant outflow and air can be sucked into refrigerant circuit, which can cause burst or personal injury due to anomalously high pressure in the refrigerant
- **Only use prescribed optional parts. The installation must be carried out by the qualified installer.**
If you install the system by yourself, it can cause serious trouble such as water leaks, electric shocks, fire.
- **Do not perform any change of protective device itself or its setup condition**
The forced operation by short-circuiting protective device of pressure switch and temperature controller or the use of non specified component can cause fire or burst.
- **Be sure to switch off the power supply in the event of installation, inspection or servicing.**
If the power supply is not shut off, there is a risk of electric shocks, unit failure or personal injury due to the unexpected start of fan.
- **Consult the dealer or an expert regarding removal of the unit.**
Incorrect installation can cause water leaks, electric shocks or fire.
- **Stop the compressor before closing valve and disconnecting refrigerant pipes in case of pump down operation.**
If disconnecting refrigerant pipes in state of opening service valves before compressor stopping, you may incur frost bite or injury from an abrupt refrigerant outflow and air can be sucked, which can cause burst or personal injury due to anomalously high pressure in the refrigerant circuit
- **Ensure that no air enters in the refrigerant circuit when the unit is installed and removed.**
If air enters in the refrigerant circuit, the pressure in the refrigerant circuit becomes too high, which can cause burst and personal injury.
- **Do not run the unit with removed panels or protections**
Touching rotating equipments, hot surfaces or high voltage parts can cause personal injury due to entrapment, burn or electric shocks.
- **Be sure to fix up the service panels.**
Incorrect fixing can cause electric shocks or fire due to intrusion of dust or water.
- **Do not perform any repairs or modifications by yourself. Consult the dealer if the unit requires repair.**
If you repair or modify the unit, it can cause water leaks, electric shocks or fire.





CAUTION



● Carry out the electrical work for ground lead with care

Do not connect the ground lead to the gas line, water line, lightning conductor or telephone line's ground lead. Incorrect grounding can cause unit faults such as electric shocks due to short-circuiting. Never connect the grounding wire to a gas pipe because if gas leaks, it could cause explosion or ignition.



● Use the circuit breaker for all pole with correct capacity.

Using the incorrect circuit breaker, it can cause the unit malfunction and fire.

● Install isolator or disconnect switch on the power supply wiring in accordance with the local codes and regulations.

The isolator should be locked in accordance with EN60204-1.

● Take care when carrying the unit by hand.

If the unit weights more than 20kg, it must be carried by two or more persons. Do not carry by the plastic straps, always use the carry handle when carrying the unit by hand. Use gloves to minimize the risk of cuts by the aluminum fins.

● Dispose of any packing materials correctly.

Any remaining packing materials can cause personal injury as it contains nails and wood. And to avoid danger of suffocation, be sure to keep the plastic wrapper away from children and to dispose after tear it up.

● Pay attention not to damage the drain pan by weld spatter when welding work is done near the indoor unit.

If weld spatter entered into the indoor unit during welding work, it can cause pin-hole in drain pan and result in water leakage. To prevent such damage, keep the indoor unit in its packing or cover it.

● Be sure to insulate the refrigerant pipes so as not to condense the ambient air moisture on them.

Insufficient insulation can cause condensation, which can lead to moisture damage on the ceiling, floor, furniture and any other valuables.

● Be sure to perform air tightness test by pressurizing with nitrogen gas after completed refrigerant piping work.

If the density of refrigerant exceeds the limit in the event of refrigerant leakage in the small room, lack of oxygen can occur, which can cause serious accidents.

● Perform installation work properly according to this installation manual.

Improper installation can cause abnormal vibrations or increased noise generation.



● Earth leakage breaker must be installed

If the earth leakage breaker is not installed, it can cause fire or electric shocks.

● Do not use any materials other than a fuse with the correct rating in the location where fuses are to be used.

Connecting the circuit with copper wire or other metal thread can cause unit failure and fire.

● Do not install the unit near the location where leakage of combustible gases can occur.

If leaked gases accumulate around the unit, it can cause fire.

● Do not install the unit where corrosive gas (such as sulfuric acid gas etc.) or combustible gas (such as thinner and petroleum gases) can accumulate or collect, or where volatile combustible substances are handled.

Corrosive gas can cause corrosion of heat exchanger, breakage of plastic parts and etc. And combustible gas can cause fire.

● Secure a space for installation, inspection and maintenance specified in the manual.

Insufficient space can result in accident such as personal injury due to falling from the installation place..

● When the outdoor unit is installed on a roof or a high place, provide permanent ladders and handrails along the access route and fences and handrails around the outdoor unit.

If safety facilities are not provided, it can cause personal injury due to falling from the installation place.

● Do not install nor use the system close to the equipment that generates electromagnetic fields or high frequency harmonics

Equipment such as inverters, standby generators, medical high frequency equipments and telecommunication equipments can affect the system, and cause malfunctions and breakdowns. The system can also affect medical equipment and telecommunication equipment, and obstruct its function or cause jamming.

● Do not install the outdoor unit in a location where insects and small animals can inhabit.

Insects and small animals can enter the electric parts and cause damage or fire. Instruct the user to keep the surroundings clean.



● Do not use the base flame for outdoor unit which is corroded or damaged due to long periods of operation.

Using an old and damage base flame can cause the unit falling down and cause personal injury.

● Do not install the unit in the locations listed below

- Locations where carbon fiber, metal powder or any powder is floating.
 - Locations where any substances that can affect the unit such as sulphide gas, chloride gas, acid and alkaline can occur.
 - Vehicles and ships
 - Locations where cosmetic or special sprays are often used.
 - Locations with direct exposure of oil mist and steam such as kitchen and machine plant.
 - Locations where any machines which generate high frequency harmonics are used.
 - Locations with salty atmospheres such as coastlines
 - Locations with heavy snow (If installed, be sure to provide base flame and snow hood mentioned in the manual)
 - Locations where the unit is exposed to chimney smoke
 - Locations at high altitude (more than 1000m high)
 - Locations with ammoniac atmospheres (e.g. organic fertilizer).
 - Locations with calcium chloride (e.g. snow melting agent)
 - Locations where heat radiation from other heat source can affect the unit
 - Locations without good air circulation.
 - Locations with any obstacles which can prevent inlet and outlet air of the unit
 - Locations where short circuit of air can occur (in case of multiple units installation)
 - Locations where strong air blows against the air outlet of outdoor unit
- It can cause remarkable decrease in performance, corrosion and damage of components, malfunction and fire.

● Do not install the outdoor unit in the locations listed below.

- Locations where discharged hot air or operating sound of the outdoor unit can bother neighborhood.
 - Locations where outlet air of the outdoor unit blows directly to an animal or plants. The outlet air can affect adversely to the plant etc.
 - Locations where vibration can be amplified and transmitted due to insufficient strength of structure.
 - Locations where vibration and operation sound generated by the outdoor unit can affect seriously. (on the wall or at the place near bed room)
 - Locations where an equipment affected by high harmonics is placed. (TV set or radio receiver is placed within 5m)
 - Locations where drainage cannot run off safely.
- It can affect surrounding environment and cause a claim

● Do not use the unit for special purposes such as storing foods, cooling precision instruments and preservation of animals, plants or art.

It can cause the damage of the items.

● Do not touch any buttons with wet hands

It can cause electric shocks

● Do not touch any refrigerant pipes with your hands when the system is in operation.

During operation the refrigerant pipes become extremely hot or extremely cold depending the operating condition, and it can cause burn injury or frost injury.

● Do not clean up the unit with water

It can cause electric shocks

● Do not operate the outdoor unit with any article placed on it.

You may incur property damage or personal injury from a fall of the article.

● Do not step onto the outdoor unit.

You may incur injury from a drop or fall.

Notabilia as a unit designed for R410A

- Do not use any refrigerant other than R410A. R410A will rise to pressure about 1.6 times higher than that of a conventional refrigerant. A cylinder containing R410A has a pink indication mark on the top.
- A unit designed for R410A has adopted a different size indoor unit operation valve charge port and a different size check joint provided in the unit to prevent the charging of a wrong refrigerant by mistake. The processed dimension of the flared part of a refrigerant pipe and a flare nut's parallel side measurement have also been altered to raise strength against pressure. Accordingly, you are required to arrange dedicated R410A tools listed in the table on the right before installing or servicing this unit.
- Do not use a charge cylinder. The use of a charge cylinder will cause the refrigerant composition to change, which results in performance degradation.
- In charging refrigerant, always take it out from a cylinder in the liquid phase.
- All indoor units must be models designed exclusively for R410A. Check connectable indoor unit models in a catalog, etc. (A wrong indoor unit, if connected into the system, will impair proper system operation)

Dedicated R410A tools	
a)	Gauge manifold
b)	Charge hose
c)	Electronic scale for refrigerant charging
d)	Torque wrench
e)	Flare tool
f)	Protrusion control copper pipe gauge
g)	Vacuum pump adapter
h)	Gas leak detector

1. HAULAGE AND INSTALLATION (Take particular care in carrying in or moving the unit, and always perform such an operation with two or more persons.)

CAUTION

When a unit is hoisted with slings for haulage, take into consideration the offset of its gravity center position. If not properly balanced, the unit can be thrown off-balance and fall.

1) Delivery

- Deliver the unit as close as possible to the installation site before removing it from the packaging.
- When some compelling reason necessitates the unpacking of the unit before it is carried in, use nylon slings or protective wood pieces so as not to damage the unit by ropes lifting it.

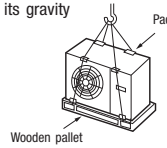

2) Portage

- The right hand side of the unit as viewed from the front (diffuser side) is heavier. A person carrying the right hand side must take heed of this fact. A person carrying the left hand side must hold with his right hand the handle provided on the front panel of the unit and with his left hand the corner column section.

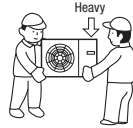

3) Selection of installation location for the outdoor unit

Be sure to select a suitable installation place in consideration of following conditions.

- A place where it is horizontal, stable and can endure the unit weight and will not allow vibration transmittance of the unit.
 - A place where it can be free from possibility of bothering neighbors due to noise or exhaust air from the unit
 - A place where the unit is not exposed to oil splashes.
 - A place where it can be free from danger of flammable gas leakage.
 - A place where drain water can be disposed without any trouble.
 - A place where the unit will not be affected by heat radiation from other heat source.
 - A place where snow will not accumulate.
 - A place where the unit can be kept away 5m or more from TV set and/or radio receiver in order to avoid any radio or TV interference.
 - A place where good air circulation can be secured, and enough service space can be secured for maintenance and service of the unit safely.
 - A place where the unit will not be affected by electromagnetic waves and/or high-harmonic waves generated by other equipment.
 - A place where chemical substances like sulfuric gas, chloric gas, acid and alkali (including ammonia), which can harm the unit, will not be generated and not remain.
 - A place where strong wind will not blow against the outlet air blow of the unit.
- Do not install the unit in places which exposed to sea breeze (e.g. coastal area) or calcium chloride (e.g. snow melting agent), exposed to ammonia substance (e.g. organic fertilizer).

4) Caution about selection of installation location

- (1) If the unit is installed in the area where the snow will accumulate, following measures are required. The bottom plate of unit and intake, outlet may be blocked by snow.

1. Install the unit on the base so that the bottom is higher than snow cover surface.
2. Provide a snow hood to the outdoor unit on site. Regarding outline of a snow hood, refer to our technical manual.
3. Install the unit under eaves or provide the roof on site.

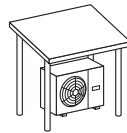
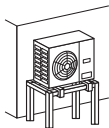

Since drain water generated by defrost control may freeze, following measures are required.

- Don't execute drain piping work by using a drain elbow and drain grommets (optional parts). [Refer to Drain piping work.]
- Recommend setting Defrost Control (SW3-1) and Snow Guard Fan Control (SW3-2). [Refer to Setting SW3-1, SW3-2.]

- (2) If the unit can be affected by strong wind, following measures are required.

Strong wind can cause damage of fan (fan motor), or can cause performance degradation, or can trigger anomalous stop of the unit due to rising of high pressure.

1. Install the outlet air blow side of the unit to face a wall of building, or provide a fence or a windbreak screen.
2. Install the outlet air blow side of the unit in a position perpendicular to the direction of wind.
3. The unit should be installed on the stable and level foundation. If the foundation is not level, tie down the unit with wires.

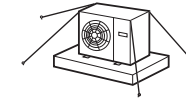
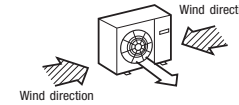
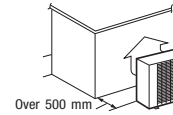

5) Installation space

- Walls surrounding the unit in the four sides are not acceptable.
- There must be a 1-meter or larger space in the above.
- Where a danger of short-circuiting exists, install guide louvers.
- When more than one unit are installed, provide sufficient intake space consciously so that short-circuiting may not occur.
- Where piling snow can bury the outdoor unit, provide proper snow guards.
- A barrier wall placed in front of the exhaust diffuser must not be higher than the unit.

		(mm)		
		100V~140V		
Size	Example installation	I	II	III
L1	Open	300	Open	500
L2		Open	5	Open
L3		150	300	150
L4		5	5	5

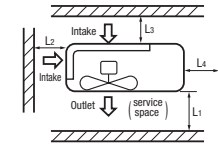

6) Installation

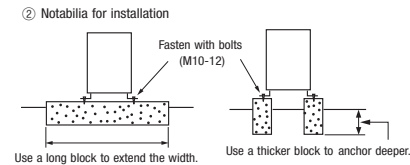
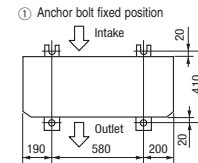

- In installing the unit, fix the unit's legs with bolts specified on the left.
 - The protrusion of an anchor bolt on the front side must be kept within 15 mm.
 - Securely install the unit so that it does not fall over during earthquakes or strong winds, etc.
 - Refer to the left illustrations for information regarding concrete foundations.
 - Install the unit in a level area. (With a gradient of 5 mm or less.)
- Improper installation can result in a compressor failure, broken piping within the unit and abnormal noise generation.

7) To run the unit for a cooling operation, when the outdoor temperature is -5°C or lower.

- When the outdoor air temperature is -5°C or lower, provide a snow hood to the outdoor unit on site. So that strong wind will not blow against the outdoor heat exchanger directly. Regarding outline of a snow hood, refer to our technical manual.

2. REFRIGERANT PIPING WORK

1) Restrictions on unit installation and use

- Check the following points in light of the indoor unit specifications and the installation site.
- Observe the following restrictions on unit installation and use. Improper installation can result in a compressor failure or performance degradation.

Descriptions	One-way pipe length difference from the first branching point to the indoor unit		Marks appearing in the drawing			
	Model for outdoor units	Dimensional limitations	Single type	Twin type	< 3m	≥ 3m
One-way pipe length of refrigerant piping	100VN, 125VN, 100VS, 125VS	≤ 50m	L	L+L1+L2	Triple type A	Triple type B
	140VN, 140VS				L+L1+L2+L3	L+La+L1+L2+L3
	100WN, 125WN, 100WSX, 125WSX				—	—
	140WN, 140WSX				L+L1+L2+L3	L+La+L1+L2+L3
Main pipe length	100VN, 125VN, 100VS, 125VS	≤ 50m	—	L	—	—
	140VN, 140VS		—	L	L	
	100WN, 125WN, 100WSX, 125WSX		—	—	—	—
	140WN, 140WSX		—	L	L	
One-way pipe length between the first branching point from to the second branching point	140VN, 140VS, 140WN, 140WSX	≤ 5m	—	—	—	La
One-way pipe length after the first branching point	100VN, 125VN, 100VS, 125VS, 140VN, 140VS, 100WN, 125WN, 100WSX, 125WSX, 140WN, 140WSX	≤ 30m	—	L1, L2	L1, L2, L3	L1 (t)
One-way pipe length after the first branching point and second branching point	140VN, 140VS, 140WN, 140WSX	≤ 27m	—	—	—	La+L2, La+L3 (t)
One-way pipe length difference from the first branching point to the indoor unit	Twin type	≤ 10m	—	L1-L2	L1-L2 , L2-L3 , L3-L1	—
	Triple type	≤ 10m	—	—	—	L1-(La+L2), L1-(La+L3) (t)
One-way pipe length difference from the second branching point to the indoor unit	140VN, 140VS, 140WN, 140WSX	≤ 10m	—	—	—	L2-L3
	When the outdoor unit is positioned higher.	≤ 30m	H	H	H	H
Elevation difference between indoor and outdoor units	When the outdoor unit is positioned lower.	≤ 15m	—	h	h1, h2, h3	h1, h2, h3
	Elevation difference between indoor units	≤ 0.5m	—	h	—	h1, h2, h3

CAUTION

- The use restrictions appearing in the table above are applicable to the standard pipe size combinations shown in the table below. Where an existing pipe system is utilized, different one-way pipe length restrictions should apply depending on its pipe size. For more information, see "6. UTILIZATION OF EXISTING PIPING."
- With the triple pipe connection, the way of use is different when the difference of one-way pipe length after the first branching point is 3m to 10m. For details, refer to the above table and right figure.

Note (1) Install the indoor units so that L + L1 becomes the longest one-way pipe. Keep the pipe length difference between L1 and (La + L2) or (La + L3) within 10m.

2) Determination of pipe size

- Determine refrigerant pipe size pursuant to the following guidelines based on the indoor unit specifications.

Outdoor unit connected	Model 100V		Model 125V		Model 140V		
	Gas pipe	Liquid pipe	Gas pipe	Liquid pipe	Gas pipe	Liquid pipe	
Refrigerant piping (branch pipeL)	φ15.88	φ9.52	φ15.88	φ9.52	φ15.88	φ9.52	
Flare	Flare	Flare	Flare	Flare	Flare	Flare	
Indoor unit connected	φ15.88	φ9.52	φ15.88	φ9.52	φ15.88	φ9.52	
In the case of a single type	Capacity of indoor unit	Model 100V		Model 125V		Model 140V	
	Branching pipe set	DIS-WA1		DIS-WA1		DIS-WA1	
	Refrigerant piping (branch pipe L1, L2)	φ12.7	φ9.52	φ12.7	φ9.52	φ15.88	φ9.52
In the case of a twin type	Indoor unit connected	φ12.7	φ6.35	φ12.7	φ6.35	φ15.88	φ9.52
	Capacity of indoor unit	Model 50V×2		Model 60V×2		Model 71V×2	
	Branching pipe set	DIS-TA1		DIS-TA1		DIS-TA1	
In the case of a triple type A	Refrigerant piping (branch pipe L1, L2, L3)	—	—	—	—	φ12.7	φ9.52
	Indoor unit connected	—	—	—	—	φ12.7	φ6.35
	Capacity of indoor unit	Model 50V×3		Model 60V×3		Model 71V×3	
In the case of a triple type B	Branching pipe set	DIS-WA1		DIS-WA1		DIS-WA1	
	Refrigerant piping (branch pipe La)	—	—	—	—	φ15.88	φ9.52
	Refrigerant piping (branch pipe L1)	—	—	—	—	φ12.7	φ9.52
	Refrigerant piping (branch pipe La)	—	—	—	—	φ12.7	φ9.52
	Refrigerant piping (branch pipe L2, L3)	—	—	—	—	φ12.7	φ9.52
	Indoor unit connected	—	—	—	—	φ12.7	φ6.35
Capacity of indoor unit	Model 50V×3		Model 60V×3		Model 71V×3		

CAUTION

- When the 50V or 60V model is connected as an indoor unit, always use a φ9.52 liquid pipe for the branch (branching pipe – indoor unit) and a different diameter joint supplied with the branching pipe set for connection with the indoor unit (φ6.35 on the liquid pipe side). If a φ6.35 pipe is used for connection with a branching pipe, a refrigerant distribution disorder may occur, causing one of the indoor units to fall short of the rated capacity.
- A riser pipe must be a part of the main. A branching pipe set should be installed horizontally at a point as close to an indoor unit as possible. A branching part must be dressed with a heat-insulation material supplied as an accessory.
- For the details of installation work required at and near a branching area, see the installation manual supplied with your branching pipe set.

< Single type >

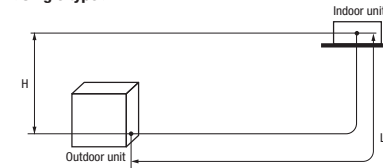

< Twin type >

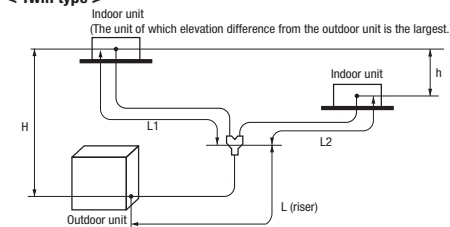

< Triple type >

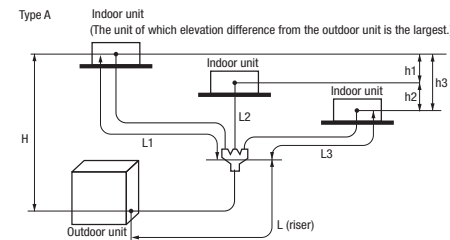

< Triple type >

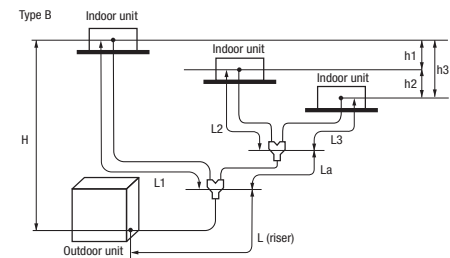

About brazing

Brazing must be performed under a nitrogen gas flow.

Without nitrogen gas, a large quantity of foreign matters (oxidized film) are created, causing a critical failure from capillary tube or expansion valve clogging.

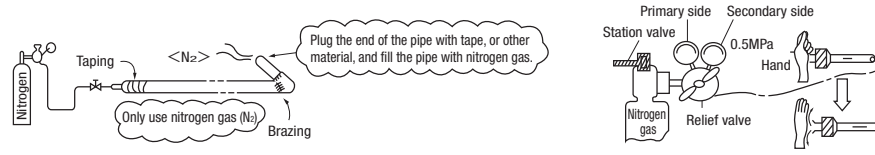

3) Refrigerant pipe wall thickness and material

- Select refrigerant pipes of the table shown on the right wall thickness and material as specified for each pipe size.
- This unit uses R410A. Always use 1/2H pipes having a 1.0mm or thicker wall for φ19.05 or larger pipes, because O-type pipes do not meet the pressure resistance requirement.

Pipe diameter (mm)	6.35	9.52	12.7	15.88	22.22	25.4	28.58
Minimum pipe wall thickness [mm]	0.8	0.8	0.8	1.0	1.0	1.0	1.0
Pipe material*	O-type pipe	O-type pipe	O-type pipe	O-type pipe	1/2H-type pipe	1/2H-type pipe	1/2H-type pipe

*Phosphorus deoxidized seamless copper pipe C1220T, JIS H3300

NOTE

- Select pipes having a wall thickness larger than the specified minimum pipe thickness.

4) On-site piping work

IMPORTANT

- Take care so that installed pipes may not touch components within a unit. If touching with an internal component, it will generate abnormal sounds and/or vibrations.

How to remove the service panel

First remove the five screws (× mark) of the service panel and push it down into the direction of the arrow mark and then remove it by pulling it toward you.

- The pipe can be laid in any of the following directions: side right, front, rear and downward.
- Remove a knock-out plate provided on the pipe penetration to open a minimum necessary area and attach an edging material supplied as an accessory by cutting it to an appropriate length before laying a pipe.
- Carry out the on site piping work with the operation valve fully closed.
- Give sufficient protection to a pipe end (compressed and blazed, or with an adhesive tape) so that water or foreign matters may not enter the piping.
- Bend a pipe to a radius as large as practical.(R100~R150) Do not bend a pipe repeatedly to correct its form.
- Flare connection is used between the unit and refrigerant pipe. Flare a pipe after engaging a flare nut onto it. Flare dimensions for R410A are different from those for conventional R407C. Although we recommend the use of flaring tools designed specifically for R410A, conventional flaring tools can also be used by adjusting the measurement of protrusion B with a protrusion control gauge.
- The pipe should be anchored every 1.5m or less to isolate the vibration.
- Tighten a flare joint securely with a double spanner.

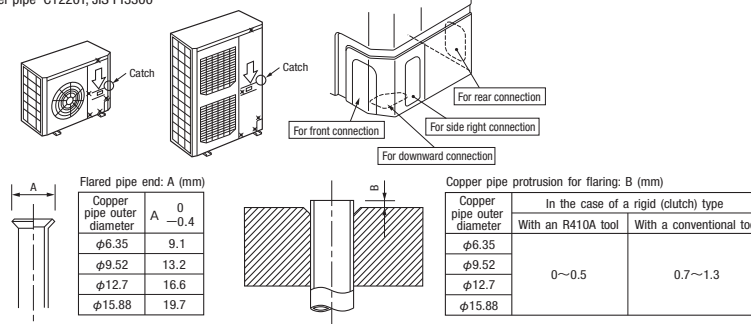

CAUTION

Do not apply force beyond proper fastening torque in tightening the flare nut.

Fix both liquid and gas service valves at the valve main bodies as illustrated on the right, and then fasten them, applying appropriate fastening torque.

Operation valve size (mm)	Tightening torque (N·m)	Tightening angle (°)	Recommended length of a tool handle (mm)
φ6.35 (1/4")	14~18	45~60	150
φ9.52 (3/8")	34~42	30~45	200
φ12.7 (1/2")	49~61	30~45	250
φ15.88 (5/8")	68~82	15~20	300

Do not hold the valve cap area with a spanner.

Use a torque wrench. If a torque wrench is not available, fasten the flare nut manually first and then tighten it further, using the left table as a guide.

5) Air tightness test

- Although outdoor and indoor units themselves have been tested for air tightness at the factory, check the connecting pipes after the installation work for air tightness from the operation valve's check joint equipped on the outdoor unit side. While conducting a test, keep the operation valve shut all the time.
 - Raise the pressure to 0.5 MPa, and then stop. Leave it for five minutes to see if the pressure drops.
 - Then raise the pressure to 1.5 MPa, and stop. Leave it for five more minutes to see if the pressure drops.
 - Then raise the pressure to the specified level (4.15 MPa), and record the ambient temperature and the pressure.
 - If no pressure drop is observed with an installation pressurized to the specified level and left for about one day, it is acceptable. When the ambient Temperature fall 1°C, the pressure also fall approximately 0.01 MPa. The pressure, if changed, should be compensated for.
 - If a pressure drop is observed in checking e) and a) - d), a leak exists somewhere. Find a leak by applying bubble test liquid to welded parts and flare joints and repair it. After repair, conduct an air-tightness test again.
- In conducting an air-tightness test, use nitrogen gas and pressurize the system with nitrogen gas from the gas side. Do not use a medium other than nitrogen gas under any circumstances.

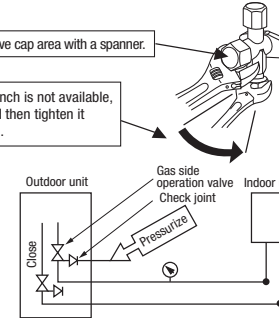

6) Evacuation

<Work flow> When the system has remaining moisture inside or a leaky point, the vacuum gauge indicator will rise. Check the system for a leaky point and then draw air to create a vacuum again.

Run the vacuum pump for at least one hour after the vacuum gauge shows -101kPa or lower. (-755mmHg or lower)
Confirm that the vacuum gauge indicator does not rise even if the system is left for one hour or more.

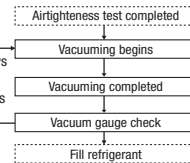

Pay attention to the following points in addition to the above for the R410A and compatible machines.

- To prevent a different oil from entering, assign dedicated tools, etc. to each refrigerant type. Under no circumstances must a gauge manifold and a charge hose in particular be shared with other refrigerant types (R22, R407C, etc.).
- Use a counterflow prevention adapter to prevent vacuum pump oil from entering the refrigerant system.

7) Additional refrigerant charge

- Calculate a required refrigerant charge volume from the following table.

<Single type>

Capacity	Item	Standard refrigerant charge volume (kg)	Pipe length for standard refrigerant charge volume (m)	Additional charge volume (kg) per meter of refrigerant piping (liquid pipe)	Refrigerant volume charged for shipment at the factory (kg)	Installation's pipe length (m) covered without additional refrigerant charge
100VN~140VN 100VS~140VS	Standard	2.0	0	0.06	3.8	30
	Installation	2.7				

- A standard refrigerant charge volume means a refrigerant charge volume for an installation with 0m long refrigerant piping.
- This unit contains factory charged refrigerant covering 30m of refrigerant piping and additional refrigerant charge on the installation site is not required for an installation with up to 30m refrigerant piping. When refrigerant piping exceeds 30m, additionally charge an amount calculated from the pipe length and the above table for the portion in excess of 30m.
- When refrigerant piping is shorter than 3m, reduce refrigerant by 1kg from the factory charged volume and adjust to 2.8kg or 3.5kg.
- If an existing pipe system is used, a required refrigerant charge volume will vary depending on the liquid pipe size. For further information, see "6. UTILIZATION OF EXISTING PIPING."

<Twin, triple, W-twin type>

Capacity	Item	Standard refrigerant charge volume (kg)	Pipe length for standard refrigerant charge volume (m)	Additional charge volume (kg) per meter of refrigerant piping (liquid pipe)		Refrigerant volume charged for shipment at the factory (kg)	Installation's pipe length (m) covered without additional refrigerant charge
				Main pipe	Branch pipe		
100VN~140VN 100VS~140VS	Standard	2.0	0	0.06		3.8	30
	Installation	2.7		4.5			

Formula to calculate the volume of additional refrigerant required

$$\text{Additional charge volume (kg)} = \{ \text{Main pipe length (m)} - \text{Length covered without additional charge 30 (m)} \} \times 0.06 \text{ (kg/m)} + \text{Total length of branch pipes (m)} \times 0.06 \text{ (kg/m)}$$

*When an additional charge volume calculation result is negative, it is not necessary to charge refrigerant additionally.

- To charge refrigerant again, recover refrigerant from the system first and then charge the volume calculated from the above table (Standard refrigerant charge volume + additional charge volume for total pipe length).

(2) Charging refrigerant

- Since R410A refrigerant must be charged in the liquid phase, you should charge it, keeping the container cylinder upside down or using a refrigerant cylinder equipped with a siphon tube.
- Charge refrigerant always from the liquid side service port with the operation valve shut. When you find it difficult to charge a required amount, fully open the outdoor unit valves on both liquid and gas sides and charge refrigerant from the gas (suction) side service port, while running the unit in the cooling mode. In doing so, care must be taken so that refrigerant may be discharged from the cylinder in the liquid phase all the time. When the cylinder valve is throttled down or a dedicated conversion tool to change liquid-phase refrigerant into mist is used to protect the compressor, however, adjust charge conditions so that refrigerant will gasify upon entering the unit.
- In charging refrigerant, always charge a calculated volume by using a scale to measure the charge volume.
- When refrigerant is charged with the unit being run, complete a charge operation within 30 minutes. Running the unit with an insufficient quantity of refrigerant for a long time can cause a compressor failure.

NOTE Put down the refrigerant volume calculated from the pipe length onto the caution label attached on the back side of the service panel.

8) Heating and condensation prevention

- (1) Dress refrigerant pipes (both gas and liquid pipes) for heat insulation and prevention of dew condensation.
- (2) Use a heat insulating material that can withstand 120°C or a higher temperature. Poor heat insulating capacity can cause heat insulation problems or cable deterioration.
 - Improper heat insulation/anti-dew dressing can result in a water leak or dripping causing damage to household effects, etc.
 - All gas pipes must be securely heat insulated in order to prevent damage from dripping water that comes from the condensation formed on them during a cooling operation or personal injury from burns because their surface can reach quite a high temperature due to discharged gas flowing inside during a heating operation.
 - Wrap indoor units' flare joints with heat insulating parts (pipe cover) for heat insulation (both gas and liquid pipes).
 - Give heat insulation to both gas and liquid side pipes. Bundle a heat insulating material and a pipe tightly together so that no gaps may be left between them and wrap them together with a connecting cable by a dressing tape.
 - Although it is verified in a test that this air conditioning unit shows satisfactory performance under JIS condensation test conditions, **both gas and liquid pipes need to be dressed with 20 mm or thicker heat insulation materials above the ceiling where relative humidity exceeds 70%.**

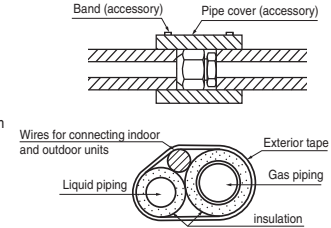

3. DRAIN PIPING WORK

- Execute drain piping by using a drain elbow and drain grommets supplied separately as optional parts, where water drained from the outdoor unit is a problem.

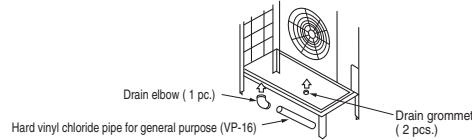

- There are 3 drain holes provided on the bottom plate of an outdoor unit to discharge condensed water.
- When condensed water needs to be led to a drain, etc., install the unit on a flat base (supplied separately as an optional part) or concrete blocks.
- Connect a drain elbow as shown in the illustration and close the other two drain holes with grommets.

4. ELECTRICAL WIRING WORK For details of electrical cabling, refer to the indoor unit installation manual.

Electrical installation work must be performed by an electrical installation service provider qualified by a power provider of the country. Electrical installation work must be executed according to the technical standards and other regulations applicable to electrical installations in the country.

- Do not use any supply cord lighter than one specified in parentheses for each type below.
 - braided cord (code designation 60245 IEC 51),
 - ordinary tough rubber sheathed cord (code designation 60245 IEC 53)
 - flat twin tinsel cord (code designation 60227 IEC 41);
- Do not use anything lighter than polychloroprene sheathed flexible cord (code designation 60245 IEC57) for supply cords of parts of appliances for outdoor use.
- Ground the unit. Do not connect the grounding wire to a gas pipe, water pipe, lightning rod or telephone grounding wire. If improperly grounded, an electric shock or malfunction may result.
- A grounding wire must be connected before connecting the power cable. Provide a grounding wire longer than the power cable.
- The installation of an impulse withstanding type earth leakage breaker is necessary. A failure to install an earth leakage breaker can result in an accident such as an electric shock or a fire.

- Do not turn on the power until the electrical work is completed.
- Do not use a condensive capacitor for power factor improvement under any circumstances. (It does not improve power factor, while it can cause an abnormal overheat accident)
- For power supply cables, use conduits.
- Do not lay electronic control cables (remote control and signaling wires) and other cables together outside the unit. Laying them together can result in the malfunctioning or a failure of the unit due to electric noises.
- Fasten cables so that they may not touch the piping, etc.
- When cables are connected, make sure that all electrical components within the electrical component box are free of loose connector coupling or terminal connection and then attach the cover securely. (Improper cover attachment can result in malfunctioning or a failure of the unit, if water penetrates into the box.)
- Always use a three-core cable for an indoor-outdoor connecting cable. Never use a shield cable.
- Connect a pair bearing a common terminal number with an indoor-outdoor connecting wire.
- In cabling, fasten cables securely with cable clamps so that no external force may work on terminal connections.
- Grounding terminals are provided in the control box.

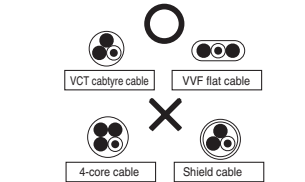
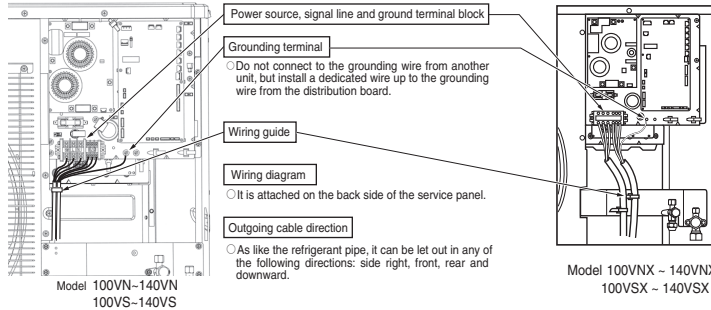

Power cable, indoor-outdoor connecting wires

- Always perform grounding system installation work with the power cord unplugged.

CAUTION Always use an earth leakage circuit breaker designed for inverter circuits to prevent a faulty operation.

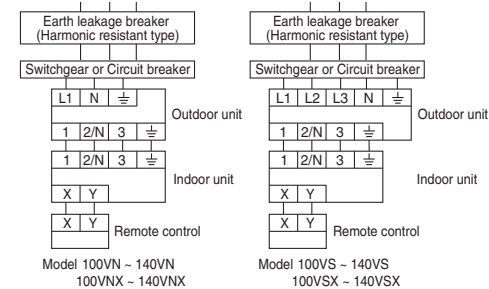

Model	Power source	Power cable thickness(mm ²)	MAX. over current (A)	Cable length (m)	Grounding wire thickness	Indoor-outdoor wire thickness x number
100VN~140VN	Single phase 3 wire 220-240V 50Hz 220V 60Hz	5.5	24	25	φ1.6mm	φ1.6mm x 3
100VNX			26	23		
125VN,140VN			27	22		
100VS ~ 140VS	3 phase 4 wire 380V-415V 50Hz 380V 60Hz	3.5	15	17		
100V SX~140V SX						

- The specifications shown in the above table are for units without heaters. For units with heaters, refer to the installation instructions or the construction instructions of the indoor unit.
- Switchgear or Circuit breaker capacity which is calculated from MAX. over current should be chosen along the regulations in each country.
- The cable specifications are based on the assumption that a metal or plastic conduit is used with no more than three cables contained in a conduit and a voltage drop is 2%. For an installation falling outside of these conditions, follow the internal cabling regulations. Adapt it to the regulation in effect in each country.

※At the connection with the duct type indoor unit.

Model	Power source	Power cable thickness(mm ²)	MAX. over current (A)	Cable length (m)	Grounding wire thickness	Indoor-outdoor wire thickness x number
100VN,100VNX	Single phase 3 wire 220-240V 50Hz 220V 60Hz	5.5	25	24	φ1.6mm	φ1.6mm x 3
125VN			27	22		
140VN			28	32		
125VNX			29	31		
140VNX			30	30		
100VS,100V SX			3 phase 4 wire 380-415V 50Hz 380V 60Hz	3.5		
125VS,125V SX	18	23				
140VS,140V SX	19	21				

5. TEST RUN

⚠ WARNING

- Before conduct a test run, do not fail to make sure that the operation valves are closed.
- Turn on power 6 hours prior to a test run to energize the crank case heater.
- In case of the first operation after turning on power, even if the unit does not move for 30 minutes, it is not a breakdown.
- Always give a 3-minute or longer interval before you start the unit again whenever it is stopped.
- Removing the service panel will expose high-voltage live parts and high-temperature parts, which are quite dangerous. Take utmost care not to incur an electric shock or burns. Do not leave the unit with the service panel open.

⚠ CAUTION

- When you operate switches (SW3, SW5) for on-site setting, be careful not to touch a live part.
- You cannot check discharge pressure from the liquid operation valve charge port.
- The 4-way valve (20S) is energized during a heating operation.
- When power supply is cut off to reset the unit, give 3 or more minutes before you turn on power again after power is cut off. If this procedure is not observed in turning on power again, "Communication error between outdoor and indoor unit" may occur.

1) Test run method

- (1) A test run can be initiated from an outdoor unit by using SW3-3 and SW3-4 for on-site setting.
- (2) Switching SW3-3 to ON will start the compressor.
- (3) The unit will start a cooling operation, when SW3-4 is OFF, or a heating operation, when SW3-4 is ON.
- (4) **Do not fail to switch SW3-3 to OFF when a test run is completed.**

SW-3-3	SW-3-4	
ON	OFF	Cooling during a test run
OFF	ON	Heating during a test run
OFF	—	Normal or After the test operation

2) Checking the state of the unit in operation

Use check joints provided on the piping before and after the four-way valve installed inside the outdoor unit for checking discharge pressure and suction pressure. As indicated in the table shown on the right, pressure detected at each point will vary depending on whether a cooling or heating operation has been selected.

	Check joint of the pipe	Charge port of the gas operation valve
Cooling operation	Discharge pressure (High pressure)	Suction pressure (Low pressure)
Heating operation	Suction pressure (Low pressure)	Discharge pressure (High pressure)

3) Setting SW3-1, SW3-2, on-site

- (1) Defrost control switching (SW3-1)
 - When this switch is turned ON, the unit will run in the defrost mode more frequently.
 - Set this switch to ON, when installed in a region where outdoor temperature falls below zero during the season the unit is run for a heating operation.
- (2) Snow guard fan control (SW3-2)
 - When this switch is turned on, the outdoor unit fan will run for 10 seconds in every 10 minutes, when outdoor temperature falls to 3°C or lower and the compressor is not running.
 - When the unit is used in a very snowy country, set this switch to ON.

4) Failure diagnosis in a test run

Error indicated on the remote control unit	Printed circuit board LED(The cycles of 5 seconds)		Failure event	Action
	Red LED	Green LED		
E34	Blinking once	Blinking continuously	Open phase	Check power cables for loose contact or disconnection
E40	Blinking once	Blinking continuously	63H1 actuation or operation with operation valves shut (occurs mainly during a heating operation)	1. Check whether the operation valves are open. 2. If an error has been canceled when 3 minutes have elapsed since a compressor stop, you can restart the unit by effecting Check Reset from the remote control unit.
E49	Blinking once	Blinking continuously	Low pressure error or operation with operation valves shut (occurs mainly during a cooling operation)	

- If an error code other than those listed above is indicated, refer to the wiring diagram of the outdoor unit and the indoor unit.

5) The state of the electronic expansion valve.

The following table illustrates the steady states of the electronic expansion valve.

	When power is turned on	When the unit comes to a normal stop			
		During a cooling operation	During a heating operation	During a cooling operation	During a heating operation
Valve for a cooling operation	Complete shut position	Complete shut position	Full open position	Full open position	Full open position
Valve for a heating operation	Full open position	Full open position	Complete shut position	Full open position	Full open position

6) Heed the following on the first operation after turning on the circuit breaker.

This outdoor unit may start in the standby mode (waiting for a compressor start up), which can continue up to 30 minutes, to prevent the oil level in the compressor from lowering on the first operation after turning on the circuit breaker. If that is the case, do not suspect a unit failure.

A failure to observe these instructions can result in a compressor breakdown.

Items to check before a test run

- When you leave the outdoor unit with power supplied to it, be sure to close the panel.

Item No. used in the installation manual	Item	Check item	Check
2	Refrigerant plumbing	If brazed, was it brazed under a nitrogen gas flow?	
		Were air-tightness test and vacuum extraction surely performed?	
		Are heat insulation materials installed on both liquid and gas pipes?	
		Are operation valves surely opened for both liquid and gas systems?	
		Have you recorded the additional refrigerant charge volume and refrigerant pipe length on the panel's label?	
4	Electric wiring	Is the unit free of cabling errors such as uncompleted connection, an absent or reversed phase?	
		Are properly rated electrical equipments used for circuit breakers and cables?	
		Doesn't cabling cross-connect between units, where more than one unit are installed?	
		Aren't indoor-outdoor signal wires connected to remote control wires?	
		Do indoor-outdoor connecting cables connect between the same terminal numbers?	
		Are either VCT cabletye cables or WF flat cables used for indoor-outdoor connecting cables?	
		Does grounding satisfy the D type grounding (type III grounding) requirements?	
		Is the unit grounded with a dedicated grounding wire not connected to another unit's grounding wire?	
		Are cables free of loose screws at their connection points?	
		Are cables held down with cable clamps so that no external force works onto terminal connections?	
—	Indoor unit	Is indoor unit installation work completed?	
		Where a face cover should be attached onto an indoor unit, is the face cover attached to the indoor unit?	

Test run procedure

- Always carry out a test run and check the following in order as listed.

Turn	The contents of operation	Check
①	Open the gas side operation valve fully.	
②	Open the liquid side operation valve fully.	
③	Close the panel.	
④	Where a remote control unit is used for unit setup on the installation site, follow instructions for unit setup on the installation site with a remote control unit.	
⑤	SW3-3 ON / SW3-4 OFF: the unit will start a cooling operation. SW3-3 ON / SW3-4 ON: the unit will start a heating operation.	
⑥	When the unit starts operation, press the wind direction button provided on the remote control unit to check its operation.	
⑦	Place your hand before the indoor unit's diffuser to check whether cold (warm) winds come out in a cooling (heating) operation.	
⑧	Make sure that a red LED is not blinking.	
⑨	When you complete the test run, do not forget to turn SW3-3 to the OFF position.	
⑩	Where options are used, check their operation according to the respective instruction manuals.	

SWITCHES FOR ON-SITE SETTING SW5

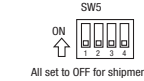

※Do not operate SW5-2, SW5-3, SW5-4

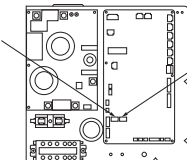

SWITCHES FOR ON-SITE SETTING SW3

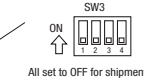

6. UTILIZATION OF EXISTING PIPING.

Check whether an existing pipe system is reusable or not by using the following flow chart.

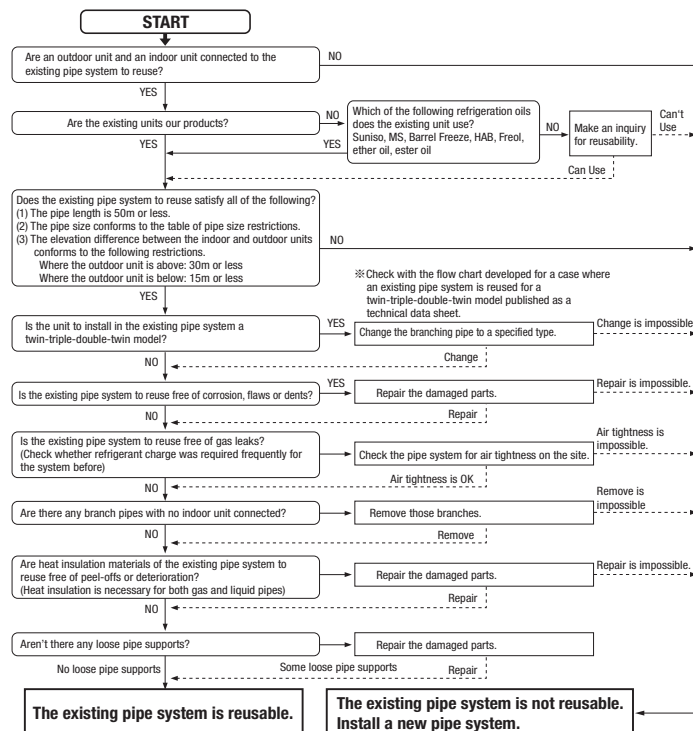

WARNING <Where the existing unit can be run for a cooling operation.>

Carry out the following steps with the existing unit (in the order of (1), (2), (3) and (4))

- (1) Run the unit for 30 minutes for a cooling operation.
- (2) Stop the indoor fan and run the unit for 3 minutes for a cooling operation (returning liquid)
- (3) Close the liquid side operation valve of the outdoor unit and pump down (refrigerant recovery)
- (4) Blow with nitrogen gas. ※ If discolored refrigeration oil or any foreign matters is discharged by the blow, wash the pipe system or install a new pipe system.
 - For the flare nut, do not use the old one, but use the one supplied with the outdoor unit. Process a flare to the dimensions specified for R410A.
 - Turn on-site setting switch SW5-1 to the ON position. (Where the gas pipe size is $\phi 19.05$)

<Where the existing unit cannot be run for a cooling operation.>

- Wash the pipe system or install a new pipe system.
- If you choose to wash the pipe system, contact our distributor in the area.

<Table of pipe size restrictions>

○:Standard pipe size ○:Usable
△:Restricted to shorter pipe length limits

Pipe size	Additional charging amount of refrigerant per 1m	0.06kg/m		0.08kg/m	
		Liquid pipe	Gas pipe	Liquid pipe	Gas pipe
100V	Liquid pipe	$\phi 9.52$	$\phi 9.52$	$\phi 12.7$	$\phi 12.7$
	Gas pipe	$\phi 15.88$	$\phi 19.05$	$\phi 15.88$	$\phi 19.05$
	Usability	○	○※1	△	△※1
125V	Liquid pipe	50	50	25	25
	Gas pipe	30	30	15	15
	Usability	○	○※1	△	△※1
140V	Liquid pipe	50	50	25	25
	Gas pipe	30	30	15	15
	Usability	○	○※1	△	△※1

※1 Because of its insufficient pressure resistance, turn the dip switch SW5-1 provided on the outdoor unit board to the ON position for $\phi 19.05 \times t1.0$.

(In the case of a twin-triple-double-twin model, this also applies to the case where $\phi 19.05 \times t1.0$ is used in a pipe system after the first branching point.

However, you need not turn the dip switch SW5-1 to the ON position, if 1/2H pipes or pipes having 1.2 or thicker walls are used.

※2 When the main pipe length exceeds 40m, a significant capacity drop may be experienced due to pressure loss in the liquid pipe system. Use $\phi 12.7$ for the liquid main.

※3 Keep the total pipe length, not one-way pipe length, below the specified maximum pipe length.

● When refrigerant piping is shorter than 3m, reduce refrigerant by 1kg from factory charged volume and adjust to 2.8kg.

● Any combinations of pipe sizes not listed in the table or marked with × in the table are not usable.

<Pipe system after the branching pipe>

○:Standard pipe size ○:Usable ×:Not usable

- Any combinations of pipe sizes not listed in the table or marked with × in the table are not usable.

Pipe size	Additional charging amount of refrigerant per 1m	After 1st branch ※4		After 2nd branch	
		0.06kg/m	0.06kg/m	0.06kg/m	0.06kg/m
100V	Liquid pipe	$\phi 9.52$	$\phi 9.52$	$\phi 9.52$	$\phi 9.52$
	Gas pipe	$\phi 12.7$	$\phi 15.88$	$\phi 12.7$	$\phi 15.88$
Model	Combination type	Combination of capacity			
100V	Twin	50+50	○	○	×
125V	Twin	60+60	○	○	×
140V	Twin	71+71	×	○	○
	Triple A	50+50+50	○	○	×
	Triple B	50+50+50	×	○※5	○

※4 Piping size after branch should be equal or smaller than main pipe size.

※5 Piping size from first branch to indoor unit should be $\phi 9.52$ (Liquid) / $\phi 12.7$ (Gas).

<The model types of existing units of which branching pipes are reusable.>

Models later than Type 8.

- F D C * * * 8
- F D C P * * * 8

The branching pipes used with models other than those listed above are not reusable because of their insufficient pressure resistance. Please use our genuine branching pipes for R410A.

- * * * are numbers representing horsepower. is an alphanumeric letter.

Formula to calculate additional charge volume

$$\text{Additional charge volume (kg)} = (\text{Main pipe length (m)} - \text{Length covered without additional charge shown in the table (m)}) \times \text{Additional charge volume per meter of pipe shown in the table (kg/m)} + \text{Total length of branch pipes (m)} \times \text{Additional charge volume per meter of pipe shown in the table (kg/m)}$$

※ If you obtain a negative figure as a result of calculation, no additional refrigerant needs to be charged.

Example When an 140V (single installation) is installed in a 20m long existing pipe system (liquid $\phi 12.7$, gas $\phi 19.05$), the quantity of refrigerant to charge additionally should be $(20\text{m}-15\text{m}) \times 0.08\text{kg/m} = 0.4 \text{ kg}$.

Pages of installation of outdoor unit were changed from page277~285 to page277~284.

Inverter driven single split PAC
200V · 250V
Designed for R410A refrigerant



(2) Models FDC200VS, 250VS

- This installation manual deals with outdoor units and general installation specifications only. For indoor units, refer to page 209.
- When install the unit, be sure to check whether the selection of installation place, power supply specifications, usage limitation (piping length, height differences between indoor and outdoor units, power supply voltage and etc.) and installation spaces



Check before installation work

SAFETY PRECAUTIONS

- We recommend you to read this "SAFETY PRECAUTIONS" carefully before the installation work in order to gain full advantage of the functions of the unit and to avoid malfunction due to mishandling.
- The precautions described below are divided into **WARNING** and **CAUTION**. The matters with possibilities leading to serious consequences such as death or serious personal injury due to erroneous handling are listed in the **WARNING** and the matters with possibilities leading to personal injury or damage of the unit due to erroneous handling including probability leading to serious consequences in some cases are listed in **CAUTION**. **These are very important precautions for safety. Be sure to observe all of them without fail.**
- The meaning of "Marks" used here are as shown below.

	Never do it under any circumstance.		Always do it according to the instruction
---	-------------------------------------	---	---
- For this outdoor unit, EN61000-3-2 is not applicable if consent by the utility company or notification to the utility company is given before usage.
- Be sure to confirm no anomaly on the equipment by commissioning after completed installation and explain the operating methods as well as the maintenance methods of this equipment to the user according to the owner's manual.
- Keep the installation manual together with owner's manual at a place where any user can read at any time. Moreover if necessary, ask to hand them to a new user

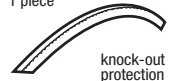
[Accessory]

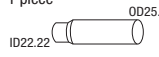
Edging	Accessory pipe	
1 piece  knock-out hole protection	1 piece ID22.22  Accessory pipe A	1 piece ID22.22 OD25.4  Accessory pipe B

- Model name and power source
- Refrigerant piping length
- Piping, wiring and miscellaneous small parts
- Indoor unit installation manual



WARNING

<p>!</p> <ul style="list-style-type: none"> ● Installation must be carried out by the qualified installer. If you install the system by yourself, it may cause serious trouble such as water leaks, electric shocks, fire and personal injury, as a result of a system malfunction. ● Install the system in full accordance with the instruction manual. Incorrect installation may cause bursts, personal injury, water leaks, electric shocks and fire. ● Use the original accessories and the specified components for installation. If parts other than those prescribed by us are used, it may cause fall of the unit, water leaks, electric shocks, fire, refrigerant leak, substandard performance, control failure and personal injury. ● When installing in small rooms, take prevention measures not to exceed the density limit of refrigerant in the event of leakage accordance with ISO5149. Consult the expert about prevention measures. If the density of refrigerant exceeds the limit in the event of leakage, lack of oxygen can occur, which can cause serious accidents. ● Ventilate the working area well in the event of refrigerant leakage during installation. If the refrigerant comes into contact with naked flames, poisonous gas is produced. ● After completed installation, check that no refrigerant leaks from the system. If refrigerant leaks into the room and comes into contact with an oven or other hot surface, poisonous gas is produced. ● Hang up the unit at the specified points with ropes which can support the weight in lifting for portage. And to avoid jolting out of alignment, be sure to hang up the unit at 4-point support. An improper manner of portage such as 3-point support can cause death or serious personal injury due to falling of the unit ● Install the unit in a location with good support. Unsuitable installation locations can cause the unit to fall and cause material damage and personal injury. ● Ensure the unit is stable when installed, so that it can withstand earthquakes and strong winds. Unsuitable installation locations can cause the unit to fall and cause material damage and personal injury. ● The electrical installation must be carried out by the qualified electrician in accordance with "the norm for electrical work" and "national wiring regulation", and the system must be connected to the dedicated circuit. Power supply with insufficient capacity and incorrect function done by improper work can cause electric shocks and fire, ● Be sure to shut off the power before starting electrical work. Failure to shut off the power can cause electric shocks, unit failure or incorrect function of equipment. ● Be sure to use the cables conformed to safety standard and cable ampacity for power distribution work. Unconformable cables can cause electric leak, anomalous heat production or fire. ● Use the prescribed cables for electrical connection, tighten the cables securely in terminal block and relieve the cables correctly to prevent overloading the terminal blocks. Loose connections or cable mountings can cause anomalous heat production or fire. ● Arrange the wiring in the control box so that it cannot be pushed up further into the box. Install the service panel correctly. Incorrect installation may result in overheating and fire. 	<p>!</p> <ul style="list-style-type: none"> ● Do not perform brazing work in the airtight room It can cause lack of oxygen. ● Use the prescribed pipes, flare nuts and tools for R410A. Using existing parts (for R22 or R407C) can cause the unit failure and serious accidents due to burst of the refrigerant circuit. ● Tighten the flare nut by using double spanners and torque wrench according to prescribed method. Be sure not to tighten the flare nut too much. Loose flare connection or damage on the flare part by tightening with excess torque can cause burst or refrigerant leaks which may result in lack of oxygen. ● Do not open the service valves for liquid line and gas line until completed refrigerant piping work, air tightness test and evacuation. If the compressor is operated in state of opening service valves before completed connection of refrigerant piping work, you may incur frost bite or injury from an abrupt refrigerant outflow and air can be sucked into refrigerant circuit, which can cause burst or personal injury due to anomalously high pressure in the refrigerant ● Only use prescribed optional parts. The installation must be carried out by the qualified installer. If you install the system by yourself, it can cause serious trouble such as water leaks, electric shocks, fire. ● Do not perform any change of protective device itself or its setup condition The forced operation by short-circuiting protective device of pressure switch and temperature controller or the use of non specified component can cause fire or burst. ● Be sure to switch off the power supply in the event of installation, inspection or servicing. If the power supply is not shut off, there is a risk of electric shocks, unit failure or personal injury due to the unexpected start of fan. ● Consult the dealer or an expert regarding removal of the unit. Incorrect installation can cause water leaks, electric shocks or fire. ● Stop the compressor before closing valve and disconnecting refrigerant pipes in case of pump down operation. If disconnecting refrigerant pipes in state of opening service valves before compressor stopping, you may incur frost bite or injury from an abrupt refrigerant outflow and air can be sucked, which can cause burst or personal injury due to anomalously high pressure in the refrigerant circuit <p>⊘</p> <ul style="list-style-type: none"> ● Ensure that no air enters in the refrigerant circuit when the unit is installed and removed. If air enters in the refrigerant circuit, the pressure in the refrigerant circuit becomes too high, which can cause burst and personal injury. ● Do not run the unit with removed panels or protections Touching rotating equipments, hot surfaces or high voltage parts can cause personal injury due to entrapment, burn or electric shocks. ● Be sure to fix up the service panels. Incorrect fixing can cause electric shocks or fire due to intrusion of dust or water. ● Do not perform any repairs or modifications by yourself. Consult the dealer if the unit requires repair. If you repair or modify the unit, it can cause water leaks, electric shocks or fire.
---	--



CAUTION



● **Carry out the electrical work for ground lead with care**
Do not connect the ground lead to the gas line, water line, lightning conductor or telephone line's ground lead. Incorrect grounding can cause unit faults such as electric shocks due to short-circuiting. Never connect the grounding wire to a gas pipe because if gas leaks, it could cause explosion or ignition.



- **Use the circuit breaker for all pole with correct capacity.**
Using the incorrect circuit breaker, it can cause the unit malfunction and fire.
- **Install isolator or disconnect switch on the power supply wiring in accordance with the local codes and regulations.**
The isolator should be locked in accordance with EN60204-1.
- **Take care when carrying the unit by hand.**
If the unit weights more than 20kg, it must be carried by two or more persons. Do not carry by the plastic straps, always use the carry handle when carrying the unit by hand. Use gloves to minimize the risk of cuts by the aluminum fins.
- **Dispose of any packing materials correctly.**
Any remaining packing materials can cause personal injury as it contains nails and wood. And to avoid danger of suffocation, be sure to keep the plastic wrapper away from children and to dispose after tear it up.
- **Pay attention not to damage the drain pan by weld spatter when welding work is done near the indoor unit.**
If weld spatter entered into the indoor unit during welding work, it can cause pin-hole in drain pan and result in water leakage. To prevent such damage, keep the indoor unit in its packing or cover it.
- **Be sure to insulate the refrigerant pipes so as not to condense the ambient air moisture on them.**
Insufficient insulation can cause condensation, which can lead to moisture damage on the ceiling, floor, furniture and any other valuables.
- **Be sure to perform air tightness test by pressurizing with nitrogen gas after completed refrigerant piping work.**
If the density of refrigerant exceeds the limit in the event of refrigerant leakage in the small room, lack of oxygen can occur, which can cause serious accidents.
- **Perform installation work properly according to this installation manual.**
Improper installation can cause abnormal vibrations or increased noise generation.



- **Earth leakage breaker must be installed**
If the earth leakage breaker is not installed, it can cause fire or electric shocks.
- **Do not use any materials other than a fuse with the correct rating in the location where fuses are to be used.**
Connecting the circuit with copper wire or other metal thread can cause unit failure and fire.
- **Do not install the unit near the location where leakage of combustible gases can occur.**
If leaked gases accumulate around the unit, it can cause fire.
- **Do not install the unit where corrosive gas (such as sulfuric acid gas etc.) or combustible gas (such as thinner and petroleum gases) can accumulate or collect, or where volatile combustible substances are handled.**
Corrosive gas can cause corrosion of heat exchanger, breakage of plastic parts and etc. And combustible gas can cause fire.
- **Secure a space for installation, inspection and maintenance specified in the manual.**
Insufficient space can result in accident such as personal injury due to falling from the installation place..
- **When the outdoor unit is installed on a roof or a high place, provide permanent ladders and handrails along the access route and fences and handrails around the outdoor unit.**
If safety facilities are not provided, it can cause personal injury due to falling from the installation place.
- **Do not install nor use the system close to the equipment that generates electromagnetic fields or high frequency harmonics**
Equipment such as inverters, standby generators, medical high frequency equipments and telecommunication equipments can affect the system, and cause malfunctions and breakdowns. The system can also affect medical equipment and telecommunication equipment, and obstruct its function or cause jamming.
- **Do not install the outdoor unit in a location where insects and small animals can inhabit.**
Insects and small animals can enter the electric parts and cause damage or fire. Instruct the user to keep the surroundings clean.



- **Do not use the base flame for outdoor unit which is corroded or damaged due to long periods of operation.**
Using an old and damaged base flame can cause the unit falling down and cause personal injury.
- **Do not install the unit in the locations listed below**
 - Locations where carbon fiber, metal powder or any powder is floating.
 - Locations where any substances that can affect the unit such as sulphide gas, chloride gas, acid and alkaline can occur.
 - Vehicles and ships
 - Locations where cosmetic or special sprays are often used.
 - Locations with direct exposure of oil mist and steam such as kitchen and machine plant.
 - Locations where any machines which generate high frequency harmonics are used.
 - Locations with salty atmospheres such as coastlines
 - Locations with heavy snow (if installed, be sure to provide base flame and snow hood mentioned in the manual)
 - Locations where the unit is exposed to chimney smoke
 - Locations at high altitude (more than 1000m high)
 - Locations with ammoniac atmospheres
 - Locations where heat radiation from other heat source can affect the unit
 - Locations without good air circulation.
 - Locations with any obstacles which can prevent inlet and outlet air of the unit
 - Locations where short circuit of air can occur (in case of multiple units installation)
 - Locations where strong air blows against the air outlet of outdoor unit
 It can cause remarkable decrease in performance, corrosion and damage of components, malfunction and fire.
- **Do not install the outdoor unit in the locations listed below.**
 - Locations where discharged hot air or operating sound of the outdoor unit can bother neighborhood.
 - Locations where outlet air of the outdoor unit blows directly to an animal or plants. The outlet air can affect adversely to the plant etc.
 - Locations where vibration can be amplified and transmitted due to insufficient strength of structure.
 - Locations where vibration and operation sound generated by the outdoor unit can affect seriously, (on the wall or at the place near bed room)
 - Locations where an equipment affected by high harmonics is placed. (TV set or radio receiver is placed within 5m)
 - Locations where drainage cannot run off safely.
 It can affect surrounding environment and cause a claim
- **Do not use the unit for special purposes such as storing foods, cooling precision instruments and preservation of animals, plants or art.**
It can cause the damage of the items.
- **Do not touch any buttons with wet hands**
It can cause electric shocks
- **Do not touch any refrigerant pipes with your hands when the system is in operation.**
During operation the refrigerant pipes become extremely hot or extremely cold depending the operating condition, and it can cause burn injury or frost injury.
- **Do not clean up the unit with water**
It can cause electric shocks
- **Do not operate the outdoor unit with any article placed on it.**
You may incur property damage or personal injury from a fall of the article.
- **Do not step onto the outdoor unit.**
You may incur injury from a drop or fall.

Notabilia as a unit designed for R410A

- Do not use any refrigerant other than R410A. R410A will rise to pressure about 1.6 times higher than that of a conventional refrigerant.
A cylinder containing R410A has a pink indication mark on the top.
- A unit designed for R410A has adopted a different size indoor unit operation valve charge port and a different size check joint provided in the unit to prevent the charging of a wrong refrigerant by mistake. The processed dimension of the flared part of a refrigerant pipe and a flare nut's parallel side measurement have also been altered to raise strength against pressure. Accordingly, you are required to arrange dedicated R410A tools listed in the table on the right before installing or servicing this unit.
- Do not use a charge cylinder. The use of a charge cylinder will cause the refrigerant composition to change, which results in performance degradation.
- In charging refrigerant, always take it out from a cylinder in the liquid phase.
- All indoor units must be models designed exclusively for R410A. Check connectable indoor unit models in a catalog, etc. (A wrong indoor unit, if connected into the system, will impair proper system operation)

Dedicated R410A tools	
a)	Gauge manifold
b)	Charge hose
c)	Electronic scale for refrigerant charging
d)	Torque wrench
e)	Flare tool
f)	Protrusion control copper pipe gauge
g)	Vacuum pump adapter
h)	Gas leak detector

1. HAULAGE AND INSTALLATION (Take particular care in carrying in or moving the unit, and always perform such an operation with two or more persons.)

CAUTION When a unit is hoisted with slings for haulage, take into consideration the offset of its gravity center position. If not properly balanced, the unit can be thrown off-balance and fall.

1) Delivery

- Deliver the unit as close as possible to the installation site before removing it from the packaging.
- When some compelling reason necessitates the unpacking of the unit before it is carried in, use nylon slings or protective wood pieces so as not to damage the unit by ropes lifting it.

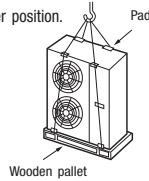

1. Install the outlet air blow side of the unit to face a wall of building, or provide a fence or a windbreak screen.

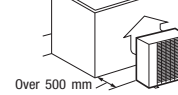

2. Install the outlet air blow side of the unit in a position perpendicular to the direction of wind.

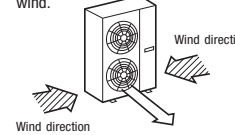

3. The unit should be installed on the stable and level foundation. If the foundation is not level, tie down the unit with wires.

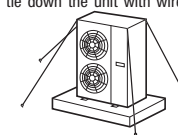

2) Portage

- The right hand side of the unit as viewed from the front (diffuser side) is heavier. A person carrying the right hand side must take heed of this fact. A person carrying the left hand side must hold with his right hand the handle provided on the front panel of the unit and with his left hand the corner column section.

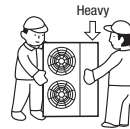

5) Installation space

- Walls surrounding the unit in the four sides are not acceptable.
- There must be a 1-meter or larger space in the above.
- Where a danger of short-circuiting exists, install guide louvers.
- When more than one unit are installed, provide sufficient intake space consciously so that short-circuiting may not occur.
- Where piling snow can bury the outdoor unit, provide proper snow guards.
- A barrier wall placed in front of the exhaust diffuser must not be higher than the unit.

3) Selection of installation location for the outdoor unit

Be sure to select a suitable installation place in consideration of following conditions.

- A place where it is horizontal, stable and can endure the unit weight and will not allow vibration transmittance of the unit.
- A place where it can be free from possibility of bothering neighbors due to noise or exhaust air from the unit
- A place where the unit is not exposed to oil splashes.
- A place where it can be free from danger of flammable gas leakage.
- A place where drain water can be disposed without any trouble.
- A place where the unit will not be affected by heat radiation from other heat source.
- A place where snow will not accumulate.
- A place where the unit can be kept away 5m or more from TV set and/or radio receiver in order to avoid any radio or TV interference.
- A place where good air circulation can be secured, and enough service space can be secured for maintenance and service of the unit safely.
- A place where the unit will not be affected by electromagnetic waves and/or high-harmonic waves generated by other equipment.
- A place where chemical substances like sulfuric gas, chloric gas, acid and alkali (including ammonia), which can harm the unit, will not be generated and not remain.
- A place where strong wind will not blow against the outlet air blow of the unit

Size	Example installation	200V, 250V (mm)		
		I	II	III
L1	Open	Open	500	
L2	300	5	Open	
L3	150	300	150	
L4	5	5	5	

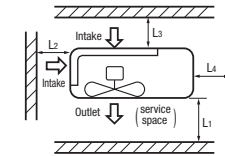

4) Caution about selection of installation location

(1) If the unit is installed in the area where the snow will accumulate, following measures are required. The bottom plate of unit and intake, outlet may be blocked by snow.

1. Install the unit on the base so that the bottom is higher than snow cover surface.

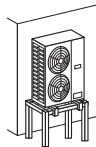

2. Provide a snow hood to the outdoor unit on site. Regarding outline of a snow hood, refer to our technical manual.



3. Install the unit under eaves or provide the roof on site.

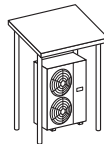

Since drain water generated by defrost control may freeze, following measures are required.

- Don't execute drain piping work by using a drain elbow and drain grommets (optional parts). [Refer to Drain piping work.]
- Recommend setting Defrost Control (SW3-1) and Snow Guard Fan Control (SW3-2). [Refer to Setting SW3-1, SW3-2.]

(2) If the unit can be affected by strong wind, following measures are required. Strong wind can cause damage of fan (fan motor), or can cause performance degradation, or can trigger anomalous stop of the unit due to rising of high pressure.

6) Installation

① Anchor bolt fixed position

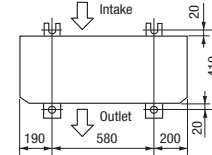

② Notabilia for installation

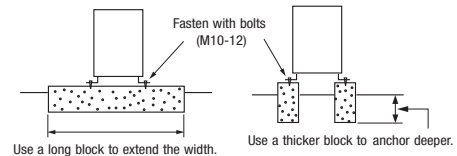

- In installing the unit, fix the unit's legs with bolts specified on the left.
 - The protrusion of an anchor bolt on the front side must be kept within 15 mm.
 - Securely install the unit so that it does not fall over during earthquakes or strong winds, etc.
 - Refer to the left illustrations for information regarding concrete foundations.
 - Install the unit in a level area. (With a gradient of 5 mm or less.)
- Improper installation can result in a compressor failure, broken piping within the unit and abnormal noise generation.

7) To run the unit for a cooling operation, when the outdoor temperature is -5°C or lower.

- When the outdoor air temperature is -5°C or lower, provide a snow hood to the outdoor unit on site. So that strong wind will not blow against the outdoor heat exchanger directly. Regarding outline of a snow hood, refer to our technical manual.

2. REFRIGERANT PIPING WORK

1) Restrictions on unit installation and use

- Check the following points in light of the indoor unit specifications and the installation site.
- Observe the following restrictions on unit installation and use. Improper installation can result in a compressor failure or performance degradation.

Restrictions	One-way pipe length difference from the first branching point to the indoor unit		Marks appearing in the drawing				
	Model for outdoor units		Dimensional restrictions		< 3m		W-twin type
	Single type	Twin type	Triple type A	Triple type B	≥ 3m		
One-way pipe length of refrigerant piping	200V Liquid Piping	φ9.52 φ12.7	≤ 40m	L	L+L1, L+L2, L+L3	L+L1 (n)	L+La+L1, L+La+L2 L+Lb+L3, L+Lb+L4
	200V-250V Gas piping	φ25.4 or φ28.58 φ22.22	≤ 70m ≤ 35m				
Main pipe length	200V Liquid Piping	φ9.52 φ12.7	≤ 40m	-	L	L+L1 (n)	L
	200V-250V Gas piping	φ25.4 or φ28.58 φ22.22	≤ 70m ≤ 35m				
One-way pipe length between the first branching point from to the second branching point	200V		≤ 5m	-	-	La	-
One-way pipe length after the first branching point	200V		≤ 30m	-	L1, L2, L3	L1 (n)	La+L1, La+L2 Lb+L3, Lb+L4
	250V		≤ 27m	-	-	La+L2, La+L3 (n)	-
One-way pipe length difference from the first branching point to the indoor unit	Twin type		≤ 10m	-	-	-	-
	Triple type	200V	≤ 3m	-	L1-L2 , L2-L3 , L3-L1	-	-
		250V	≤ 10m				
	W-twin type		200V/250V	≤ 10m	-	-	-
One-way pipe length difference from the second branching point to the indoor unit	200V		≤ 10m	-	-	L2-L3	L1-L2 , L3-L4
Total pipe length after the second branching point			≤ 15m	-	-	-	L1+L2, L3+L4
Elevation difference between indoor and outdoor units	When the outdoor unit is positioned higher,		≤ 30m	H	H	H	H
	When the outdoor unit is positioned lower,		≤ 15m	-	-	-	-
Elevation difference between indoor units			≤ 0.5m	-	h	h1, h2, h3	h1, h2, h3, h4, h5, h6

CAUTION

- For model 200V, always use φ12.7mm liquid pipes, when the length of the main "L" exceeds 40m. If φ9.52mm pipes are used in an installation having over 40m piping, they can cause performance degradation and/or water leaks from an indoor unit.
 - The use restrictions appearing in the table above are applicable to the standard pipe size combinations shown in the table below. Where an existing pipe system is utilized, different one-way pipe length restrictions should apply depending on its pipe size. For more information, see "6. UTILIZATION OF EXISTING PIPING."
 - With the triple pipe connection, the way of use is different when the difference of one-way pipe length after the first branching point is 3m to 10m. For details, refer to the above table and right figure.
- Note (1) Install the indoor units so that L + L1 becomes the longest one-way pipe.
Keep the pipe length difference between L1 and (La + L2) or (La + L3) within 10m.
Note (2) Connect the unit that is the maximum capacity with L1.

2) Determination of pipe size

- Determine refrigerant pipe size pursuant to the following guidelines based on the indoor unit specifications.

Outdoor unit connected	Model 200V		Model 250V		Model 50V		Model 60V	
	Gas pipe	Liquid pipe	Gas pipe	Liquid pipe	Gas pipe	Liquid pipe	Gas pipe	Liquid pipe
Refrigerant piping (branch pipeL)	φ22.22	φ9.52	φ22.22	φ12.7	φ22.22	φ12.7	φ22.22	φ12.7
In the case of asingle type	Indoor unit connected		Indoor unit connected		Indoor unit connected		Indoor unit connected	
	φ25.4	φ9.52	φ25.4	φ12.7	-	-	-	-
In the case of atwin type	Capacity of indoor unit		Capacity of indoor unit		Capacity of indoor unit		Capacity of indoor unit	
	φ15.88	φ9.52	φ15.88	φ9.52	-	-	-	-
In the case of a triple type A	Capacity of indoor unit		Capacity of indoor unit		Capacity of indoor unit		Capacity of indoor unit	
	φ15.88	φ9.52	φ15.88	φ9.52	-	-	-	-
In the case of a triple type B	Capacity of indoor unit		Capacity of indoor unit		Capacity of indoor unit		Capacity of indoor unit	
	φ15.88	φ9.52	φ15.88	φ9.52	φ15.88	φ9.52	φ15.88	φ9.52
In the case of a W-twin type	Capacity of indoor unit		Capacity of indoor unit		Capacity of indoor unit		Capacity of indoor unit	
	φ12.7	φ9.52	φ12.7	φ9.52	φ12.7	φ9.52	φ12.7	φ9.52

CAUTION

- When the model 50V or model 60V model is connected as an indoor unit, always use a φ9.52 liquid pipe for the branch (branching pipe - indoor unit) and a different diameter joint supplied with the branching pipe set for connection with the indoor unit (φ6.35 on the liquid pipe side).
- A riser pipe must be a part of the main. A branching pipe set should be installed horizontally at a point as close to an indoor unit as possible. A branching part must be dressed with a heat-insulation material supplied as an accessory.
- For the details of installation work required at and near a branching area, see the installation manual supplied with your branching pipe set.

< Single type >

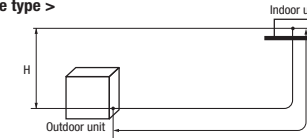

< Twin type >

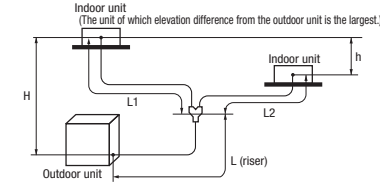

< Triple type >

Type A

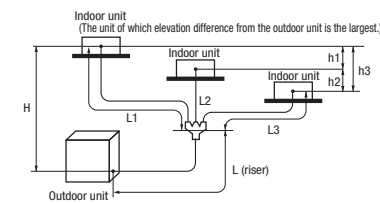

< Triple type >

Type B

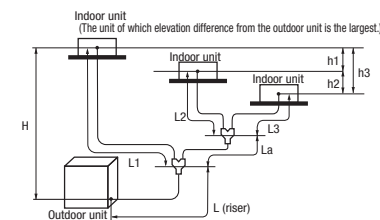

< W-twin type >

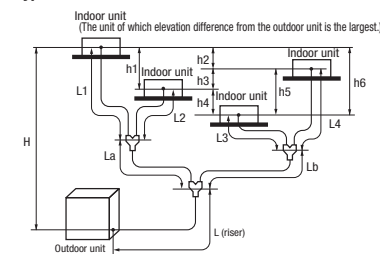

3) How to use pipe reducer.

● $\phi 22.22$ (OD) size of the refrigerant gas pipe can be used by using accessory pipe A,B.

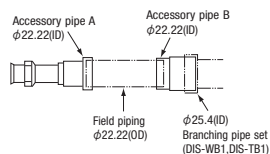

● $\phi 25.4$ (OD) size of the refrigerant gas pipe can be used by using accessory pipe A and joint pipe C. Ready joint C yourself. Need not accessory pipe B.

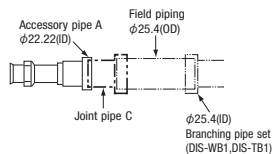

● $\phi 28.58$ (OD) size of the refrigerant gas pipe can be used by using accessory pipe A and joint pipe C,D. Ready joint C and D yourself.

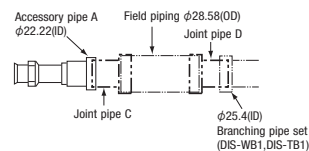

4) Refrigerant pipe wall thickness and material

- Select refrigerant pipes of the table shown on the right wall thickness and material as specified for each pipe size.
- This unit uses R410A. Always use 1/2H pipes having a 1.0mm or thicker wall for $\phi 19.05$ or larger pipes, because O-type pipes do not meet the pressure resistance requirement.

Pipe diameter [mm]	6.35	9.52	12.7	15.88	22.22	25.4	28.58
Minimum pipe wall thickness [mm]	0.8	0.8	0.8	1.0	1.0	1.0	1.0
Pipe material*	O-type pipe	O-type pipe	O-type pipe	O-type pipe	1/2H-type pipe	1/2H-type pipe	1/2H-type pipe

*Phosphorus deoxidized seamless copper pipe C1220T, JIS H3300

NOTE

● Select pipes having a wall thickness larger than the specified minimum pipe thickness.

5) On-site piping work

IMPORTANT

● Take care so that installed pipes may not touch components within a unit. If touching with an internal component, it will generate abnormal sounds and/or vibrations.

How to remove the service panel

First remove the five screws (X mark) of the service panel and push it down into the direction of the arrow mark and then remove it by pulling it toward you.

- The pipe can be laid in any of the following directions: side right, front, rear and downward.
- Remove a knock-out plate provided on the pipe penetration to open a minimum necessary area and attach an edging material supplied as an accessory by cutting it to an appropriate length before laying a pipe.
- Carry out the on site piping work with the operation valve fully closed.
- Give sufficient protection to a pipe end (compressed and blazed, or with an adhesive tape) so that water or foreign matters may not enter the piping.
- Bend a pipe to a radius as large as practical.(R100~R150) Do not bend a pipe repeatedly to correct its form.
- Flare connection is used between the unit and refrigerant pipe. Flare a pipe after engaging a flare nut onto it. Flare dimensions for R410A are different from those for conventional R407C. Although we recommend the use of flaring tools designed specifically for R410A, conventional flaring tools can also be used by adjusting the measurement of protrusion B with a protrusion control gauge.
- Use accessory pipes.
For detailed installation procedures, consult with the installation manual attached to your accessory pipe.
- The pipe should be anchored every 1.5m or less to isolate the vibration.
- Tighten a flare joint securely with a double spanner.

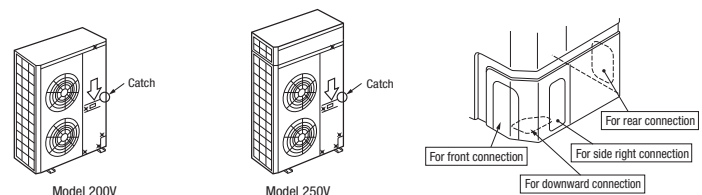

Flared pipe end: A (mm)

Copper pipe outer diameter	A
$\phi 6.35$	9.1
$\phi 9.52$	13.2
$\phi 12.7$	16.6
$\phi 15.88$	19.7

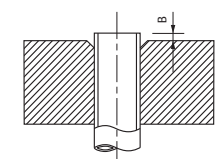

Copper pipe protrusion for flaring: B (mm)

Copper pipe outer diameter	In the case of a rigid (clutch) type	
	With an R410A tool	With a conventional tool
$\phi 6.35$	0~0.5	0.7~1.3
$\phi 9.52$		
$\phi 12.7$		
$\phi 15.88$		

CAUTION

Do not apply force beyond proper fastening torque in tightening the flare nut.

Fix both liquid and gas service valves at the valve main bodies as illustrated on the right, and then fasten them, applying appropriate fastening torque.

Operation valve size (mm)	Tightening torque (N-m)	Tightening angle (°)	Recommended length of a tool handle (mm)
$\phi 6.35$ (1/4")	14~18	45~60	150
$\phi 9.52$ (3/8")	34~42	30~45	200
$\phi 12.7$ (1/2")	49~61	30~45	250
$\phi 15.88$ (5/8")	68~82	15~20	300
$\phi 19.05$ (3/4")	100~120	15~20	450

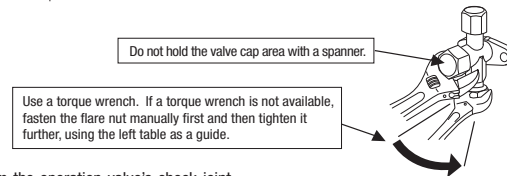

6) Air tightness test

- Although outdoor and indoor units themselves have been tested for air tightness at the factory, check the connecting pipes after the installation work for air tightness from the operation valve's check joint equipped on the outdoor unit side. While conducting a test, keep the operation valve shut all the time.
 - Raise the pressure to 0.5 MPa, and then stop. Leave it for five minutes to see if the pressure drops.
 - Then raise the pressure to 1.5 MPa, and stop. Leave it for five more minutes to see if the pressure drops.
 - Then raise the pressure to the specified level (4.15 MPa), and record the ambient temperature and the pressure.
 - If no pressure drop is observed with an installation pressurized to the specified level and left for about one day, it is acceptable. When the ambient Temperature fall 1°C, the pressure also fall approximately 0.01 MPa. The pressure, if changed, should be compensated for.
 - If a pressure drop is observed in checking e) and a) - d), a leak exists somewhere. Find a leak by applying bubble test liquid to welded parts and flare joints and repair it. After repair, conduct an air-tightness test again.
- In conducting an air-tightness test, use nitrogen gas and pressurize the system with nitrogen gas from the gas side. Do not use a medium other than nitrogen gas under any circumstances.

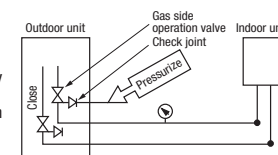

About brazing

Brazing must be performed under a nitrogen gas flow.

Without nitrogen gas, a large quantity of foreign matters (oxidized film) are created, causing a critical failure from capillary tube or expansion valve clogging.

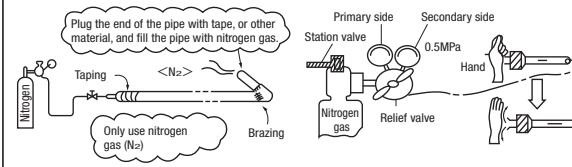

7) Evacuation

<Work flow>

When the system has remaining moisture inside or a leaky point, the vacuum gauge indicator will rise. Check the system for a leaky point and then draw air to create a vacuum again.

Run the vacuum pump for at least one hour after the vacuum gauge shows -101kPa or lower. (-755mmHg or lower)
Confirm that the vacuum gauge indicator does not rise even if the system is left for one hour or more.

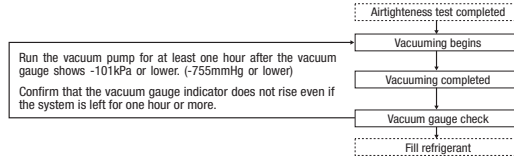

Pay attention to the following points in addition to the above for the R410A and compatible machines.

- To prevent a different oil from entering, assign dedicated tools, etc. to each refrigerant type. Under no circumstances must a gauge manifold and a charge hose in particular be shared with other refrigerant types (R22, R407C, etc.).
- Use a counterflow prevention adapter to prevent vacuum pump oil from entering the refrigerant system.

8) Additional refrigerant charge

(1) Calculate a required refrigerant charge volume from the following table.

<Single type>

Item Capacity	Standard refrigerant charge volume (kg)	Pipe length for standard refrigerant charge volume (m)	Additional charge volume (kg) per meter of refrigerant piping (liquid pipe)	Refrigerant volume charged for shipment at the factory (kg)	Installation's pipe length (m) covered without additional refrigerant charge
Model 200V	3.6	0	0.06 (Liquid piping φ9.52)	5.4	30
Model 250V			0.12 (Liquid piping φ12.7)		

<Twin, triple, W-twin type>

Item Capacity	Standard refrigerant charge volume (kg)	Pipe length for standard refrigerant charge volume (m)	Additional charge volume (kg) per meter of refrigerant piping (liquid pipe)		Refrigerant volume charged for shipment at the factory (kg)	Installation's pipe length (m) covered without additional refrigerant charge
			Main pipe	Branch pipe		
Model V200	3.6	0	0.06		5.4	30
Model V250			0.12	0.06		

- A standard refrigerant charge volume means a refrigerant charge volume for an installation with 0m long refrigerant piping.
- This unit contains factory charged refrigerant covering 30m of refrigerant piping and additional refrigerant charge on the installation site is not required for an installation with up to 30m refrigerant piping. When refrigerant piping exceeds 30m, additionally charge an amount calculated from the pipe length and the above table for the portion in excess of 30m.
- **When refrigerant piping is shorter than 3m, reduce refrigerant by 1kg from factory charged volume and adjust to 4.4kg(Model 200V) or 6.2kg(Model 250V).**
- If an existing pipe system is used, a required refrigerant charge volume will vary depending on the liquid pipe size. For further information, see " 6. UTILIZATION OF EXISTING PIPING."

Formula to calculate the volume of additional refrigerant required

Model 200V	In the case of φ9.52mm liquid piping	Additional charge volume (kg) = { Main pipe length (m) – Length covered without additional charge 30 (m) } × 0.06 (kg/m) + Total length of branch pipes (m) × 0.06 (kg/m)
	In the case of φ12.7mm liquid piping	Additional charge volume (kg) = { Main pipe length (m) – Length covered without additional charge 30 (m) } × 0.12 (kg/m) + Total length of branch pipes (m) × 0.06 (kg/m)
Model 250V		

*When an additional charge volume calculation result is negative, it is not necessary to charge refrigerant additionally.

- **To charge refrigerant again, recover refrigerant from the system first and then charge the volume calculated from the above table (Standard refrigerant charge volume + branch pipes charge volume)**

(2) Charging refrigerant

- Since R410A refrigerant must be charged in the liquid phase, you should charge it, keeping the container cylinder upside down or using a refrigerant cylinder equipped with a siphon tube.
- Charge refrigerant always from the liquid side service port with the operation valve shut. When you find it difficult to charge a required amount, fully open the outdoor unit valves on both liquid and gas sides and charge refrigerant from the gas (suction) side service port, while running the unit in the cooling mode. In doing so, care must be taken so that refrigerant may be discharged from the cylinder in the liquid phase all the time. When the cylinder valve is throttled down or a dedicated conversion tool to change liquid-phase refrigerant into mist is used to protect the compressor, however, adjust charge conditions so that refrigerant will gasify upon entering the unit.
- In charging refrigerant, always charge a calculated volume by using a scale to measure the charge volume.
- When refrigerant is charged with the unit being run, complete a charge operation within 30 minutes. Running the unit with an insufficient quantity of refrigerant for a long time can cause a compressor failure.

NOTE Put down the refrigerant volume calculated from the pipe length onto the caution label attached on the back side of the service panel.

9) Heating and condensation prevention

(1) Dress refrigerant pipes (both gas and liquid pipes) for heat insulation and prevention of dew condensation.
(2) Use a heat insulating material that can withstand 120°C or a higher temperature. Poor heat insulating capacity can cause heat insulation problems or cable deterioration.

- Improper heat insulation/anti-dew dressing can result in a water leak or dripping causing damage to household effects, etc.
- All gas pipes must be securely heat insulated in order to prevent damage from dripping water that comes from the condensation formed on them during a cooling operation or personal injury from burns because their surface can reach quite a high temperature due to discharged gas flowing inside during a heating operation.
- Wrap indoor units' flare joints with heat insulating parts (pipe cover) for heat insulation (both gas and liquid pipes).
- Give heat insulation to both gas and liquid side pipes. Bundle a heat insulating material and a pipe tightly together so that no gaps may be left between them and wrap them together with a connecting cable by a dressing tape.
- Although it is verified in a test that this air conditioning unit shows satisfactory performance under JIS condensation test conditions, **both gas and liquid pipes need to be dressed with 20 mm or thicker heat insulation materials above the ceiling where relative humidity exceeds 70%.**

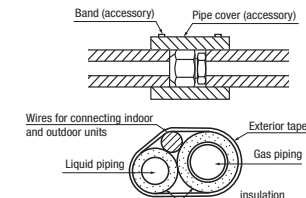

3. DRAIN PIPING WORK

- Execute drain piping by using a drain elbow and drain grommets supplied separately as optional parts, where water drained from the outdoor unit is a problem.

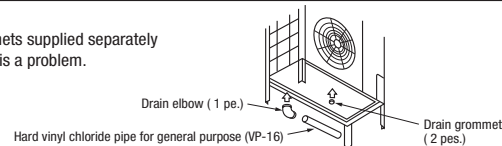

- There are 3 drain holes provided on the bottom plate of an outdoor unit to discharge condensed water.
- When condensed water needs to be led to a drain, etc., install the unit on a flat base (supplied separately as an optional part) or concrete blocks.
- Connect a drain elbow as shown in the illustration and close the other two drain holes with grommets.

4. ELECTRICAL WIRING WORK For details of electrical cabling, refer to the indoor unit installation manual.

Electrical installation work must be performed by an electrical installation service provider qualified by a power provider of the country. Electrical installation work must be executed according to the technical standards and other regulations applicable to electrical installations in the country.

• Do not use any supply cord lighter than one specified in parentheses for each type below.

- braided cord (code designation 60245 IEC 51),
- ordinary tough rubber sheathed cord (code designation 60245 IEC 53)
- flat twin tinsel cord (code designation 60227 IEC 41);

Do not use anything lighter than polychloroprene sheathed flexible cord (code designation 60245 IEC57) for supply cords of parts of appliances for outdoor use.

• Ground the unit. Do not connect the grounding wire to a gas pipe, water pipe, lightning rod or telephone grounding wire.

If improperly grounded, an electric shock or malfunction may result.

• A grounding wire must be connected before connecting the power cable. Provide a grounding wire longer than the power cable.

• The installation of an impulse withstanding type earth leakage breaker is necessary. A failure to install an earth leakage breaker can result in an accident such as an electric shock or a fire.

• Do not turn on the power until the electrical work is completed.

• Do not use a condensive capacitor for power factor improvement under any circumstances. (It does not improve power factor, while it can cause an abnormal overheat accident)

• For power supply cables, use conduits.

• Do not lay electronic control cables (remote control and signaling wires) and other cables together outside the unit. Laying them together can result in the malfunctioning or a failure of the unit due to electric noises.

• Fasten cables so that they may not touch the piping, etc.

• When cables are connected, make sure that all electrical components within the electrical component box are free of loose connector coupling or terminal connection and then attach the cover securely. (Improper cover attachment can result in malfunctioning or a failure of the unit, if water penetrates into the box.)

• Always use a three-core cable for an indoor-outdoor connecting cable. Never use a shield cable.

• Connect a pair bearing a common terminal number with an indoor-outdoor connecting wire.

• In cabling, fasten cables securely with cable clamps so that no external force may work on terminal connections.

• Grounding terminals are provided in the control box.

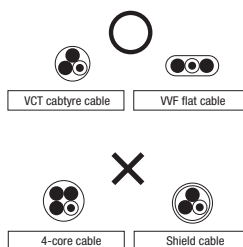
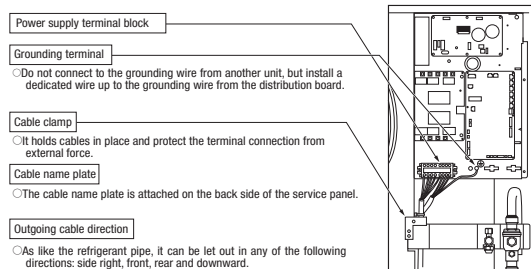

Power cable, indoor-outdoor connecting wires

- Always perform grounding system installation work with the power cord unplugged.

CAUTION

Always use an earth leakage circuit breaker designed for inverter circuits to prevent a faulty operation.

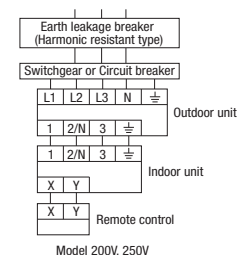

Model 200V, 250V

Model	Power source	Power cable thickness (mm ²)	MAX. over current (A)	Cable length (m)	Grounding wire thickness	Indoor-outdoor wire thickness × number
200V	3 phase 4 wire	3.5	19	21	φ1.6mm	φ1.6mm x 3
250V	380-415V 50Hz 380V 60Hz	5.5	22	31		

※At the connection with the duct type indoor unit.

Model	Power source	Power cable thickness (mm ²)	MAX. over current (A)	Cable length (m)	Grounding wire thickness	Indoor-outdoor wire thickness × number
200V	3 phase 4 wire	5.5	24	29	φ1.6mm	φ1.6mm x 3
250V	380-415V 50Hz 380V 60Hz		27	26		

• The specifications shown in the above table are for units without heaters. For units with heaters, refer to the installation instructions or the construction instructions of the indoor unit.

• Switchgear or Circuit breaker capacity which is calculated from MAX. over current should be chosen along the regulations in each country.

• The cable specifications are based on the assumption that a metal or plastic conduit is used with no more than three cables contained in a conduit and a voltage drop is 2%. For an installation falling outside of these conditions, follow the internal cabling regulations. Adapt it to the regulation in effect in each country.

5. TEST RUN

WARNING

- Before conduct a test run, do not fail to make sure that the operation valves are closed.
 - Turn on power 6 hours prior to a test run to energize the crank case heater.
 - Always give a 3-minute or longer interval before you start the unit again whenever it is stopped.
 - Removing the service panel will expose high-voltage live parts and high-temperature parts, which are quite dangerous. Take utmost care not to incur an electric shock or burns. Do not leave the unit with the service panel open.
- } A failure to observe these instructions can result in a compressor breakdown.

CAUTION

- When you operate switches (SW3, SW5) for on-site setting, be careful not to touch a live part.
- You cannot check discharge pressure from the liquid operation valve charge port.
- The 4-way valve (20S) is energized during a heating operation.
- When power supply is cut off to reset the unit, give 3 or more minutes before you turn on power again after power is cut off. If this procedure is not observed in turning on power again, "Communication error between outdoor and indoor unit" may occur.

1) Test run method

- (1) A test run can be initiated from an outdoor unit by using SW3-3 and SW3-4 for on-site setting.
- (2) Switching SW3-3 to ON will start the compressor.
- (3) The unit will start a cooling operation, when SW3-4 is OFF, or a heating operation, when SW3-4 is ON.
- (4) **Do not fail to switch SW3-3 to OFF when a test run is completed.**

SW-3-3	SW-3-4	
ON	OFF	Cooling during a test run
ON	ON	Heating during a test run
OFF	—	Normal or After the test operation

2) Checking the state of the unit in operation

Use check joints provided on the piping before and after the four-way valve installed inside the outdoor unit for checking discharge pressure and suction pressure. As indicated in the table shown on the right, pressure detected at each point will vary depending on whether a cooling or heating operation has been selected.

	Check joint of the pipe	Charge port of the gas operation valve
Cooling operation	Discharge pressure (High pressure)	Suction pressure (Low pressure)
Heating operation	Suction pressure (Low pressure)	Discharge pressure (High pressure)

3) Setting SW3-1, SW3-2, J7 on-site

- (1) Defrost control switching (SW3-1)
 - When this switch is turned ON, the unit will run in the defrost mode more frequently.
 - Set this switch to ON, when installed in a region where outdoor temperature falls below zero during the season the unit is run for a heating operation.
- (2) Snow guard fan control (SW3-2)
 - When this switch is turned on, the outdoor unit fan will run for 10 seconds in every 10 minutes, when outdoor temperature falls to 3°C or lower and the compressor is not running.
 - When the unit is used in a very snowy country, set this switch to ON.
- (3) High pressure control (J7)
 - When the option parts that change air flow from outlet are used, cut (open) J7. Cut the jumper wire into two parts and ensure that they are kept isolated from each other.

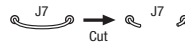

4) Failure diagnosis in a test run

Error indicated on the remote control unit	Printed circuit board LED(The cycles of 5 seconds)		Failure event	Action
	Red LED	Green LED		
E34	Blinking once	Blinking continuously	Open phase	Check power cables for loose contact or disconnection
E40	Blinking once	Blinking continuously	63H1 actuation or operation with operation valves shut (occurs mainly during a heating operation)	1. Check whether the operation valves are open. 2. If an error has been canceled when 3 minutes have elapsed since a compressor stop, you can restart the unit by effecting Check Reset from the remote control unit.
E49	Blinking once	Blinking continuously	Low pressure error or operation with operation valves shut (occurs mainly during a cooling operation)	

● If an error code other than those listed above is indicated, refer to the wiring diagram of the outdoor unit and the indoor unit.

5) The state of the electronic expansion valve.

The following table illustrates the steady states of the electronic expansion valve.

	When power is turned on	When the unit comes to a normal stop		When the unit comes to an abnormal stop	
		During a cooling operation	During a heating operation	During a cooling operation	During a heating operation
Valve for a cooling operation	Complete shut position	Complete shut position	Full open position	Full open position	Full open position
Valve for a heating operation	Full open position	Full open position	Complete shut position	Full open position	Full open position

6) Heed the following on the first operation after turning on the circuit breaker.

This outdoor unit may start in the standby mode (waiting for a compressor startup), which can continue up to 30 minutes, to prevent the oil level in the compressor from lowering on the first operation after turning on the circuit breaker. If that is the case, do not suspect a unit failure.

Items to check before a test run

● When you leave the outdoor unit with power supplied to it, be sure to close the panel.

Item No. used in the installation manual	Item	Check item	Check
2	Refrigerant plumbing	If brazed, was it brazed under a nitrogen gas flow?	
		Were air-tightness test and vacuum extraction surely performed?	
		Are heat insulation materials installed on both liquid and gas pipes?	
		Are operation valves surely opened for both liquid and gas systems?	
4	Electric wiring	Have you recorded the additional refrigerant charge volume and refrigerant pipe length on the panel's label?	
		Is the unit free of cabling errors such as uncompleted connection, an absent or reversed phase?	
		Are properly rated electrical equipments used for circuit breakers and cables?	
		Doesn't cabling cross-connect between units, where more than one unit are installed?	
		Are n't indoor-outdoor signal wires connected to remote control wires?	
		Do indoor-outdoor connecting cables connect between the same terminal numbers?	
		Are either VCT cabletype cables or WF flat cables used for indoor-outdoor connecting cables?	
		Does grounding satisfy the D type grounding (type III grounding) requirements?	
		Is the unit grounded with a dedicated grounding wire not connected to another unit's grounding wire?	
		Are cables free of loose screws at their connection points?	
Are cables held down with cable clamps so that no external force works onto terminal connections?			
-	Indoor unit	Is indoor unit installation work completed?	
		Where a face cover should be attached onto an indoor unit, is the face cover attached to the indoor unit?	

Test run procedure

● Always carry out a test run and check the following in order as listed.

Turn	The contents of operation	Check
①	Open the gas side operation valve fully.	
②	Open the liquid side operation valve fully.	
③	Close the panel.	
④	Where a remote control unit is used for unit setup on the installation site, please follow instructions for unit setup on the installation site with a remote control unit.	
⑤	SW3-3 ON / SW3-4 OFF: the unit will start a cooling operation. SW3-3 ON / SW3-4 ON: the unit will start a heating operation.	
⑥	When the unit starts operation, press the wind direction button provided on the remote control unit to check its operation.	
⑦	Place your hand before the indoor unit's diffuser to check whether cold (warm) winds come out in a cooling (heating) operation.	
⑧	Make sure that a red LED is not blinking.	
⑨	When you complete the test run, do not forget to turn SW3-3 to the OFF position.	
⑩	Where options are used, check their operation according to the respective instruction manuals.	

SWITCHES FOR ON-SITE SETTING SW5

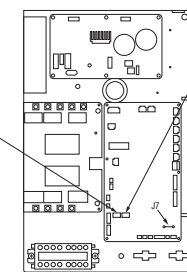
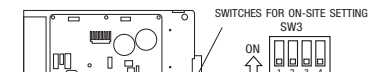
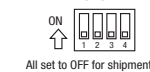

Model 200V, 250V

6. UTILIZATION OF EXISTING PIPING.

Check whether an existing pipe system is reusable or not by using the following flow chart.

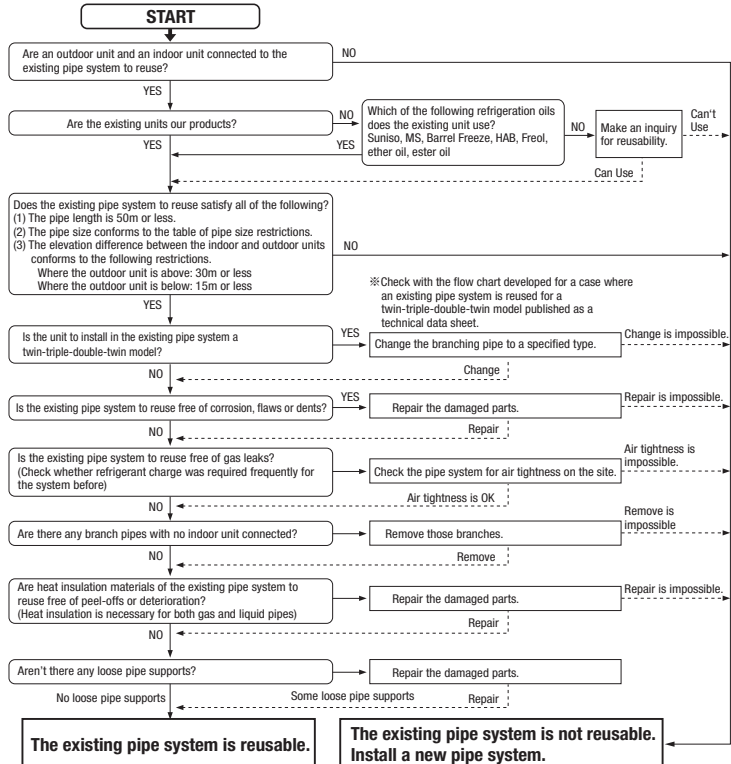

WARNING <Where the existing unit can be run for a cooling operation.>

- Carry out the following steps with the existing unit** (in the order of (1), (2), (3) and (4))
- Run the unit for 30 minutes for a cooling operation.
 - Stop the indoor fan and run the unit for 3 minutes for a cooling operation (returning liquid)
 - Close the liquid side operation valve of the outdoor unit and pump down (refrigerant recovery)
 - Blow with nitrogen gas. ※ If discolored refrigeration oil or any foreign matters is discharged by the blow, wash the pipe system or install a new pipe system.
 - For the flare nut, do not use the old one, but use the one supplied with the outdoor unit. Process a flare to the dimensions specified for R410A.
 - Turn on-site setting switch SW5-1 to the ON position. (Where the gas pipe size is φ19.05)

<Where the existing unit cannot be run for a cooling operation.>

- Wash the pipe system or install a new pipe system.
- If you choose to wash the pipe system, contact our distributor in the area.

<Table of pipe size restrictions> ◎:Standard pipe size ○:Usable △:Restricted to shorter pipe length limits Cool ↓ : Cooling capacity drop ×:Not usable

Pipe size	Additional charging amount of refrigerant per 1m	0.06kg/m			0.12kg/m			0.2kg/m		
		φ9.52	φ9.52	φ9.52	φ12.7	φ12.7	φ12.7	φ15.88	φ15.88	φ15.88
200V	Gas pipe	φ22.22	φ25.4 ^{※2}	φ28.6 ^{※2}	φ22.22	φ25.4	φ28.6	φ22.22	φ25.4	φ28.6
	Usability	◎	○	○	◎	△※3	△※3	△※3	△※3	×
	Maximum one-way pipe length	35	70	70	35	70	70	24	24	×
250V	Usability	×	×	×	◎	○	○	△※3	△※3	△※3
	Maximum one-way pipe length	×	×	×	35	70	70	40	40	40
	Length covered without additional charge	×	×	×	30	30	25	18	18	13

- ※1 Because of its insufficient pressure resistance, turn the dip switch SW5-1 provided on the outdoor unit board to the ON position for φ19.05 × t1.0. (In the case of a twin-triple-double-twin model, this also applies to the case where φ19.05 × t1.0 is used in a pipe system after the first branching point. However, you need not turn the dip switch SW5-1 to the ON position, if 1/2H pipes or pipes having 1.2 or thicker walls are used.
- ※2 When the main pipe length exceeds 40m, a significant capacity drop may be experienced due to pressure loss in the liquid pipe system. Use φ12.7 for the liquid main.
- ※3 Keep the total pipe length, not one-way pipe length, below the specified maximum pipe length.
- When refrigerant piping is shorter than 3m, reduce refrigerant by 1kg from factory charged volume and djust to 4.4kg(Model 200V) or 6.2kg(Model 250V).
- Any combinations of pipe sizes not listed in the table or marked with × in the table are not usable.

<Pipe system after the branching pipe> ◎:Standard pipe size ○:Usable ×:Not usable — : Outside of an object

● Any combinations of pipe sizes not listed in the table or marked with × in the table are not usable.

Pipe size	Additional charging amount of refrigerant per 1m	After 1st branch ※4			After 2nd branch		
		0.06kg/m			0.06kg/m		
Model	Liquid pipe	φ9.52	φ9.52	φ9.52	φ9.52	φ9.52	φ9.52
	Gas pipe	φ12.7	φ15.88	φ19.05※1	φ12.7	φ15.88	φ19.05※1
200V	Twin	100+100	×	◎	○	—	—
	Triple A	71+71+71	×	◎	○	—	—
	Triple B	71+71+71	×	◎	○	◎※5	○
	Double twin	50+50+50+50	×	◎	○	◎	◎
250V	Twin	125+125	×	◎	○	—	—
	Triple A	—	—	◎	○	—	—
	Triple B	60+60+125	×	◎	○	◎※5	×
	Double twin	60+60+60+60	×	◎	○	◎	◎

- ※4 Piping size after branch should be equal or smaller than main pipe size.
- ※5 Piping size from first branch to indoor unit should be φ9.52 (Liquid) / φ15.88 (Gas).

<The model types of existing units of which branching pipes are reusable.>

- Models later than Type 8.
- FDC * * * 8 □ □ □
- FDCP * * * 8 □ □ □

The branching pipes used with models other than those listed above are not reusable because of their insufficient pressure resistance. Please use our genuine branching pipes for R410A.

● * * * are numbers representing horsepower. □ □ □ is an alphanumeric letter.

Formula to calculate additional charge volume

$$\text{Additional charge volume (kg)} = (\text{Main pipe length (m)} - \text{Length covered without additional charge shown in the table (m)}) \times \text{Additional charge volume per meter of pipe shown in the table (kg/m)} + \text{Total length of branch pipes (m)} \times \text{Additional charge volume per meter of pipe shown in the table (kg/m)}$$

- ※ If you obtain a negative figure as a result of calculation, no additional refrigerant needs to be charged.
- Example) When an 250V (twin installation) is installed in a 40m long existing pipe system (main pipe length 30m, liquid φ15.88, gas φ25.4; pipe length after branching pipe 5m x 2, liquid φ9.52, gas φ15.88), the quantity of refrigerant to charge additionally should be (30m-18m) x 0.2kg/m + 5m x 2 x 0.06kg/m = 3.0 kg.

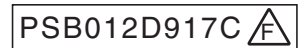

(3) Method for connecting the accessory pipe (Models FDC200,250)

Be sure to use the accessory pipe to connect the operation valve on the gas side with the field pipe.

- ① Referring to Table ① and Table ②, prepare the straight pipe and the elbow in the field, which are used in the construction examples (A)~(D) applicable to the connecting direction.
- ② Firstly, use the accessory pipe to assemble the connecting pipe assembly outside the outdoor unit.
As shown in the figures of construction examples (A)~(D) applicable to the connecting direction(chain double dashed line), braze the accessory pipe and the parts prepared in the above ①.
- ③ After assembly of the connecting pipe, connect it to the service valve on the gas side inside the outdoor unit.
Tighten the flare nut with appropriate torque.
- ④ After connection of the connecting pipe assembly to the service valve on the gas side, braze the connecting pipe assembly and the field pipe.

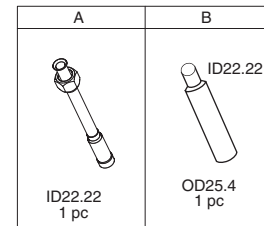

Appropriate torque	
φ 19.05	100~120N·m

Table ① Parts used for the connecting pipe assembly

No.	Name	Qty.	Remarks
1	Accessory pipe A	1	Accessories
2	Straight pipe ①	1	Procured in the field
3	Straight pipe ②	1 or 0	Procured in the field (Not required for downward direction)
4	Elbow	1 or 0	Procured in the field (Not required for downward direction)

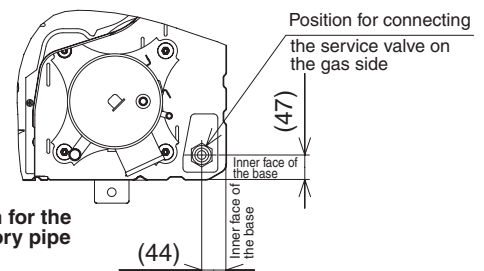

Table ② Length of the straight pipe (prepared in the field)

	Pipe size	(A) Downward	(B) Forward	(C) Rightward	(D) Backward
Straight pipe ①	φ 22.22 × t1.6	above 415mm	185~235mm	185~235mm	185~235mm
Straight pipe ②	φ 22.22 × t1.6	-	above 125mm	above 125mm	above 405mm

- Be sure to use pipes of 1/2H material, and wall thickness above 1mm. (Pressure resistance of O-type pipe is not enough)
- Switch ON SW5-1 on the control PCB, if O-type pipe must be used and bent with the bender.
During heating operation, the high-pressure protection may be actuated under the condition lower than the normal pressure, and the heating capacity may decrease.

About brazing

- **Be sure to braze while supplying nitrogen gas.**
If no nitrogen gas is supplied, a large amount of impurity (oxidized fi lm) will be generated, which may clog the capillary tube and the expansion valve, resulting in fatal malfunction.

- Branching pipe set can be used by using the accessory pipe B.
When φ 22.22(OD) size of the indoor unit gas pipe is used, the accessory pipe B is unnecessary.

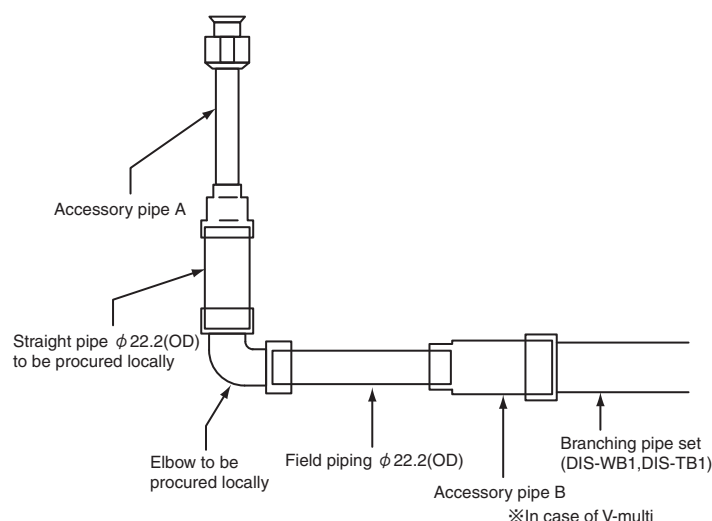

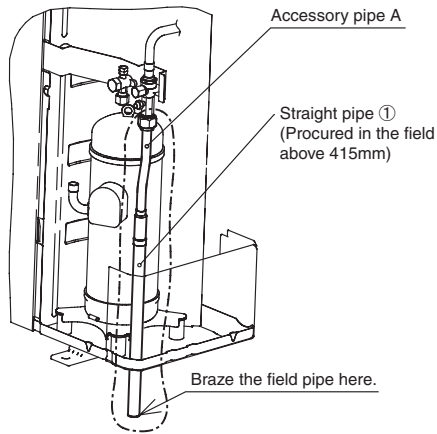

Construction example A
(Downward)

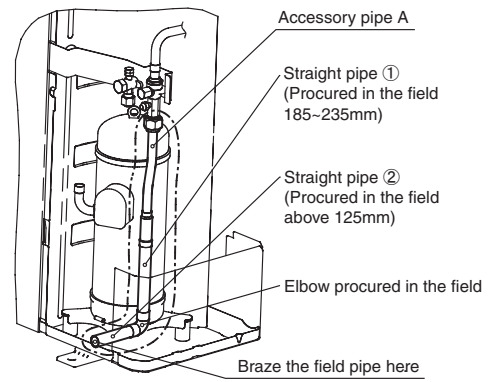

Construction example B
(Forward)

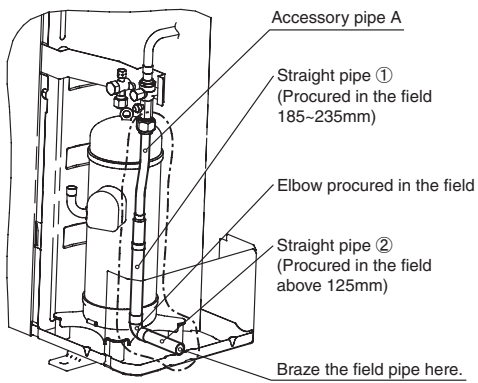

Construction example C
(Rightward)

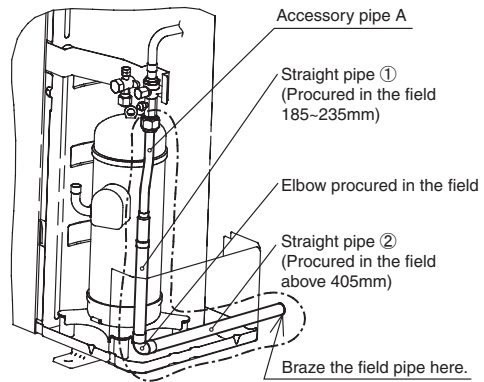

Construction example D
(Backward)

1.10.5 Instructions for branching pipe set (DIS-WA1, WB1, TA1, TB1)

For R410A

PSB012D865 











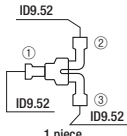
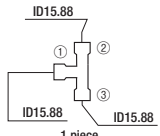

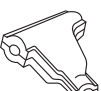
WARNING / CAUTION

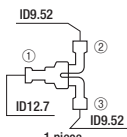
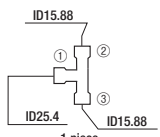
- This set is for R410A refrigerant.
- Select a branching pipe set correctly rated for the combined total capacity of connected indoor units and install it according to this manual. An improperly installed branching pipe set can cause degraded performance or an abnormal unit stop.
- Provide good heat insulation to the pipes by following instructions contained in this manual.
- Improper heat insulation can result in degraded performance or a water leak accident from condensation.
- Please make sure that only parts supplied as accessories or the manufacturer's approved parts are used in installing the unit, because a leak of refrigerant can result in a lack-of-oxygen accident, if it reaches a concentration beyond the tolerable limit.

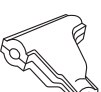
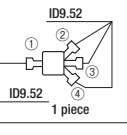
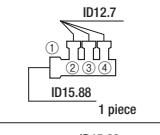
This manual explains how to use a branching pipe set that is indispensable in connecting pipes for a twin/triple/W-twin configuration installation (system). For the details of piping work, unit installation work and electrical installation work, please refer to the installation manuals and installation guides supplied with your outdoor and indoor units.

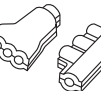
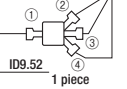
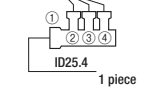
1. Branching pipe set specifications

- (1) Please make sure that you have chosen the right branching pipe set and the specifications of the parts contained in it by checking with the table below.
- (2) Connect pipes as illustrated in the table below. The pipe from an outdoor unit must be brazed to the pipe connection port "①" and the pipes from indoor units to "②," "③" and "④."

Branching pipe set type	Supported outdoor/indoor unit combinations		Part lists			
	Outdoor unit model	Indoor unit model	Branching pipe set for a liquid pipe	Branching pipe set for a gas pipe	Different diameter pipe joint	Heat insulation material
DIS-WA1 (Two-way branching set)	3HP	1.5HP + 1.5HP			Joint A ID9.52  2 pieces Flare joint (for indoor unit side connection)	
	4HP	2HP + 2HP				
		1.5HP + 2.5HP				
	5HP	2.5HP + 2.5HP				
		2HP + 3HP				
	3HP + 3HP			Joint B OD15.88  2 pieces ID12.7	One each for liquid and gas	
DIS-WB1 (Two-way branching set)	8HP	4HP + 4HP			Joint C OD12.7  1 piece ID9.52	
		3HP + 5HP				
	10HP	5HP + 5HP				
DIS-TA1 (Three-way branching set)	6HP	2HP + 2HP + 2HP			Joint A ID9.52  3 pieces Flare joint (for indoor unit side connection)	
DIS-TB1 (Three-way branching set)	8HP	3HP + 3HP + 3HP			Joint A ID9.52  2 pieces Flare joint (for indoor unit side connection) Joint B OD15.88  1 piece ID12.7 Joint D ID12.7  1 piece OD9.52	

- (3) To connect pipes for a Double Twin installation (involving 4 indoor units), please see 2-7. "Double Twin configuration."
- (4) A branching pipe set must always be installed into the posture as illustrated in the drawing below.

ID stands for inner diameter and OD, outer diameter.

< Posture to install into >

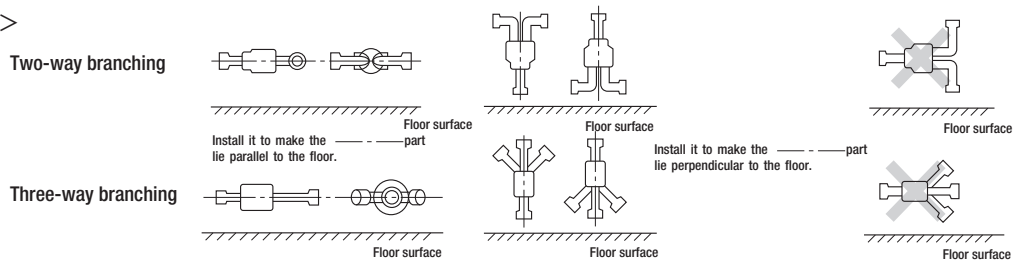

2. Pipe connecting procedure

Braze the different diameter pipe joint found in the set matching the connected outdoor and indoor unit capacities according to the instructions set out below.



CAUTION

In connecting an indoor unit of which capacity is 1.5HP, 2HP or 2.5HP, always use a ϕ 9.52 liquid pipe to connect to the branching pipe (branching pipe – indoor unit).
 In connecting to an indoor unit (liquid pipe side: ϕ 6.35), use the different diameter pipe joint A supplied with the set and follow the procedure set out below.

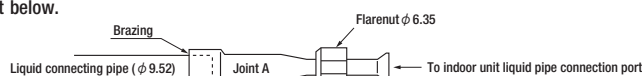

2-1 DIS-WA1

Supported combinations		Liquid branching pipe	Gas branching pipe
Outdoor unit model	Indoor unit model		
3HP	1.5HP + 1.5HP		
4HP	2HP + 2HP		
	1.5HP + 2.5HP		
5HP	2.5HP + 2.5HP		
	2HP + 3HP		
6HP	3HP + 3HP		
	2HP + 4HP		

Note When connect the indoor unit of an old model that is shown in the model list, use the joint supplied with the branch piping set like ※A

2-5. Triple type for same model/same capacity or different model/same capacity

When the difference in length of pipes after the branch is longer than 3 m and shorter than 10 m

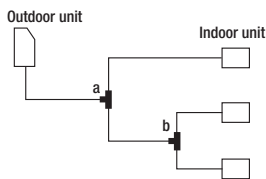

Outdoor unit model	Indoor unit model	Branching pipe	Branching pipe set type	Liquid branching pipe	Gas branching pipe
6HP	2HP + 2HP + 2HP	a	DIS-WA1		
8HP	3HP + 3HP + 3HP	a	DIS-WB1		
				b	DIS-WA1

2-2 DIS-WB1

Supported combinations		Liquid branching pipe	Gas branching pipe
Outdoor unit model	Indoor unit model		
8HP	3HP + 5HP		
	4HP + 4HP		
10HP	5HP + 5HP		

2-3 DIS-TA1 Applicable to the difference in length of pipes after the branch being less than 3 m
* Connection is not allowed when the difference in length of pipes is larger than 3 m.

Supported combinations		Liquid branching pipe	Gas branching pipe
Outdoor unit model	Indoor unit model		
6HP	2HP + 2HP + 2HP		

2-4 DIS-TB1 Applicable to the difference in length of pipes after the branch being less than 3 m
* Connection is not allowed when the difference in length of pipes is larger than 3 m.

Supported combinations		Liquid branching pipe	Gas branching pipe
Outdoor unit model	Indoor unit model		
8HP	3HP + 3HP + 3HP		

▷ OLD Model list

model name
FDTA251R
FDENA251R
FDKNA251R
FDURA251R
FDUMA252R

2-6. Triple type for same model/different capacity or different model/different capacity

Applicable to the difference in length of pipes after the branch being less than 3 m

* Connection is not allowed when the difference in length of pipes is larger than 3 m.

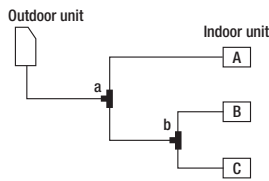

Connecting position

Outdoor unit model	Indoor unit model	A	B	C
10HP	2.5HP + 2.5HP + 5HP	5HP	2.5HP	2.5HP
	3HP + 3HP + 4HP	4HP	3HP	3HP

Outdoor unit model	Indoor unit model	Branching pipe	Branching pipe set type	Liquid branching pipe	Gas branching pipe
10HP	2.5HP + 2.5HP + 5HP	a	DIS-WB1		
		b	DIS-WA1		
10HP	3HP + 3HP + 4HP	a	DIS-WB1		
		b	DIS-WA1		

Note When connect the indoor unit of an old model that is shown in the model list, use the joint supplied with the branch piping set like ※ A.

2-7. Double Twin type

Pipes should be connected as follows for a Double Twin installation (4 connected indoor units. The capacity of an outdoor unit available for this configuration is either 8HP or 10HP only):

Outdoor unit capacity	Indoor unit capacity
8HP	2HP × 4 units
10HP	2.5HP × 4 units

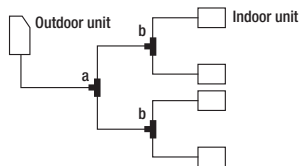

Branching pipe	Branching pipe set type	Outdoor unit model	Liquid branching pipe	Gas branching pipe
a	DIS-WB1	8HP		
		10HP		
b	DIS-WA1	8HP		
		10HP		

Note When connect the indoor unit of an old model that is shown in the model list, use the joint supplied with the branch piping set like ※ A.

3. Heat insulation work

- (1) Condensation can also occur on liquid pipes with this model. Please provide good heat insulation to both liquid and gas pipes.
- (2) For the heat insulation of a branching pipe, always use the heat insulation material supplied with the set and provide heat insulation according to the instructions set out below.

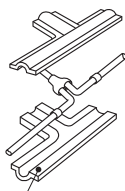

1. It has an adhesive layer on the entire inner face. Remove a separator and wrap it around the branching pipe.

Heat insulation material (for pipe insulation, etc.) to be procured locally

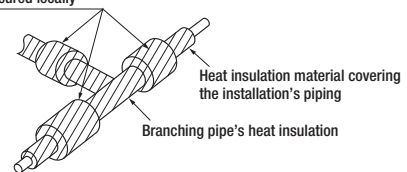

2. Apply a heat insulation material (to be procured locally) to the joint between the branching pipe's heat insulation and the heat insulation material covering the installation's piping as described above and wrap a tape over the gap shown as a hatched (///) area to complete dressing of the piping.

1.11 OUTLINE OF OPERATION CONTROL BY MICROCOMPUTER

1.11.1 Remote control

(1) Wired remote control Model RC-EX1A

All icons are shown for the sake of explanation.

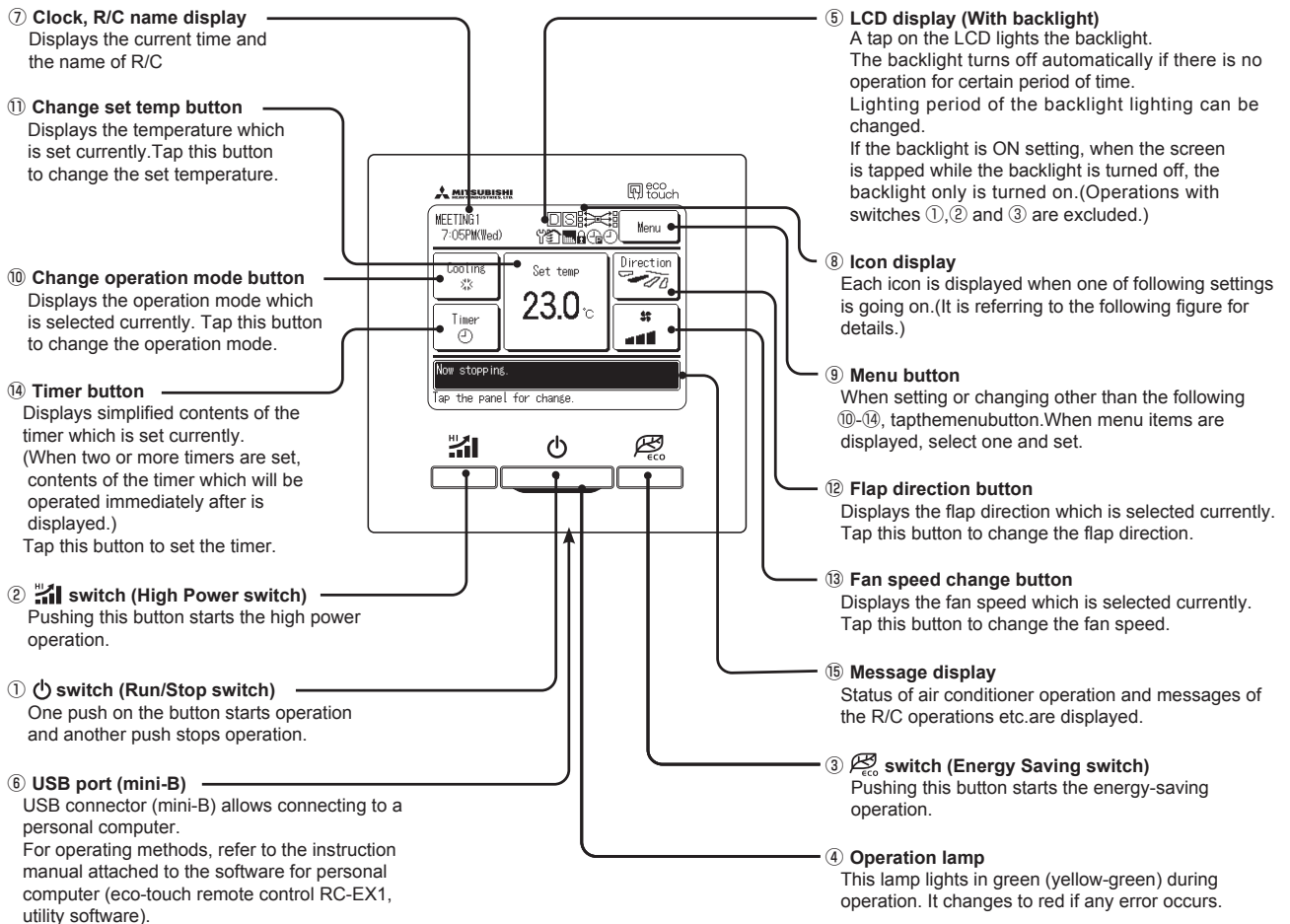

Touch panel system, which is operated by tapping the LCD screen with a finger, is employed for any operations other than the ① Run/Stop, ② High power and ③ Energy-saving switches.

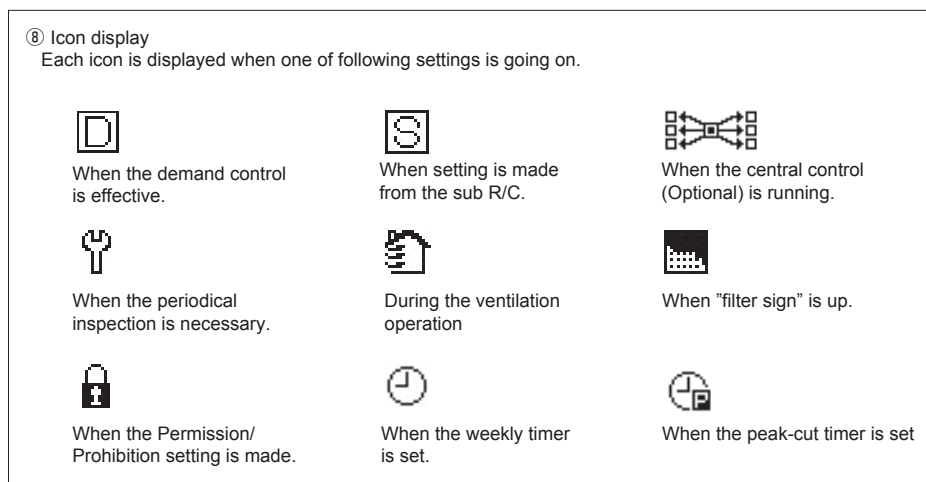

Model RC-E5

The figure below shows the remote control with the cover opened. Note that all the items that may be displayed in the liquid crystal display area are shown in the figure for the sake of explanation
 Characters displayed with dots in the liquid crystal display area are abbreviated.

The figure below shows the remote control with the cover opened.

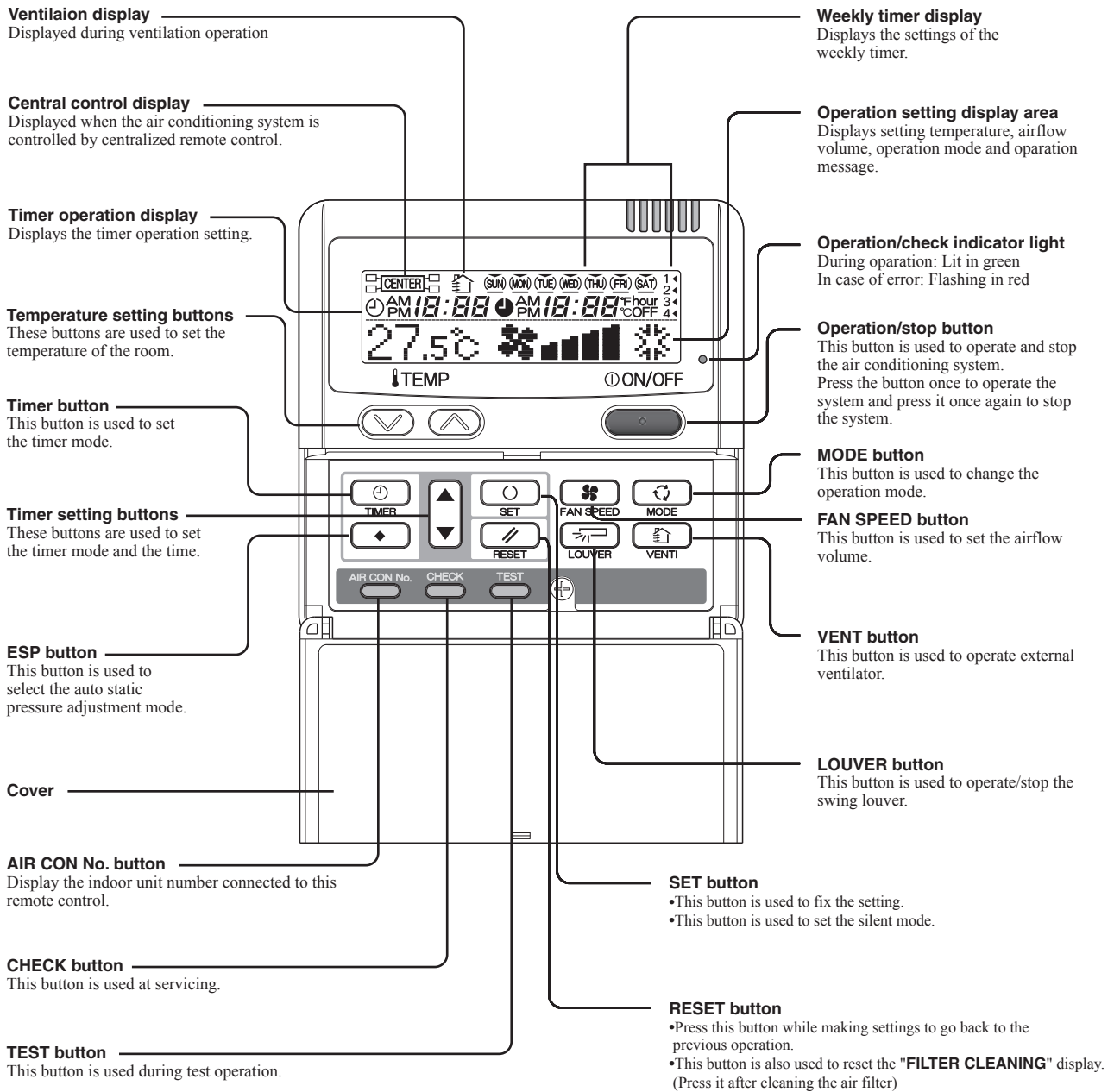

* All displays are described in the liquid crystal display for explanation.

(2) Wireless remote control

Indication section

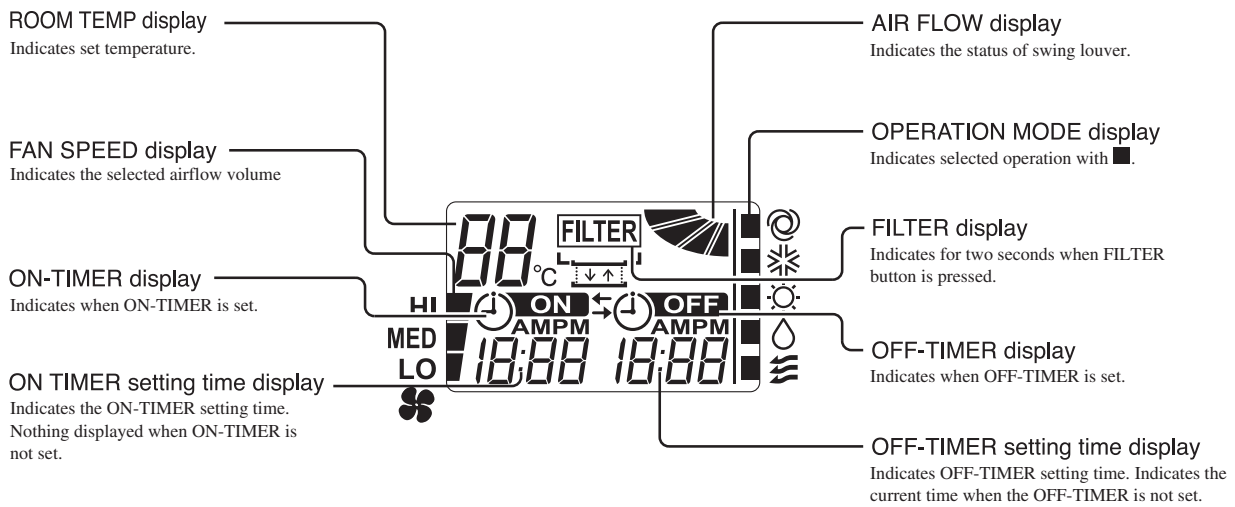

Operation section

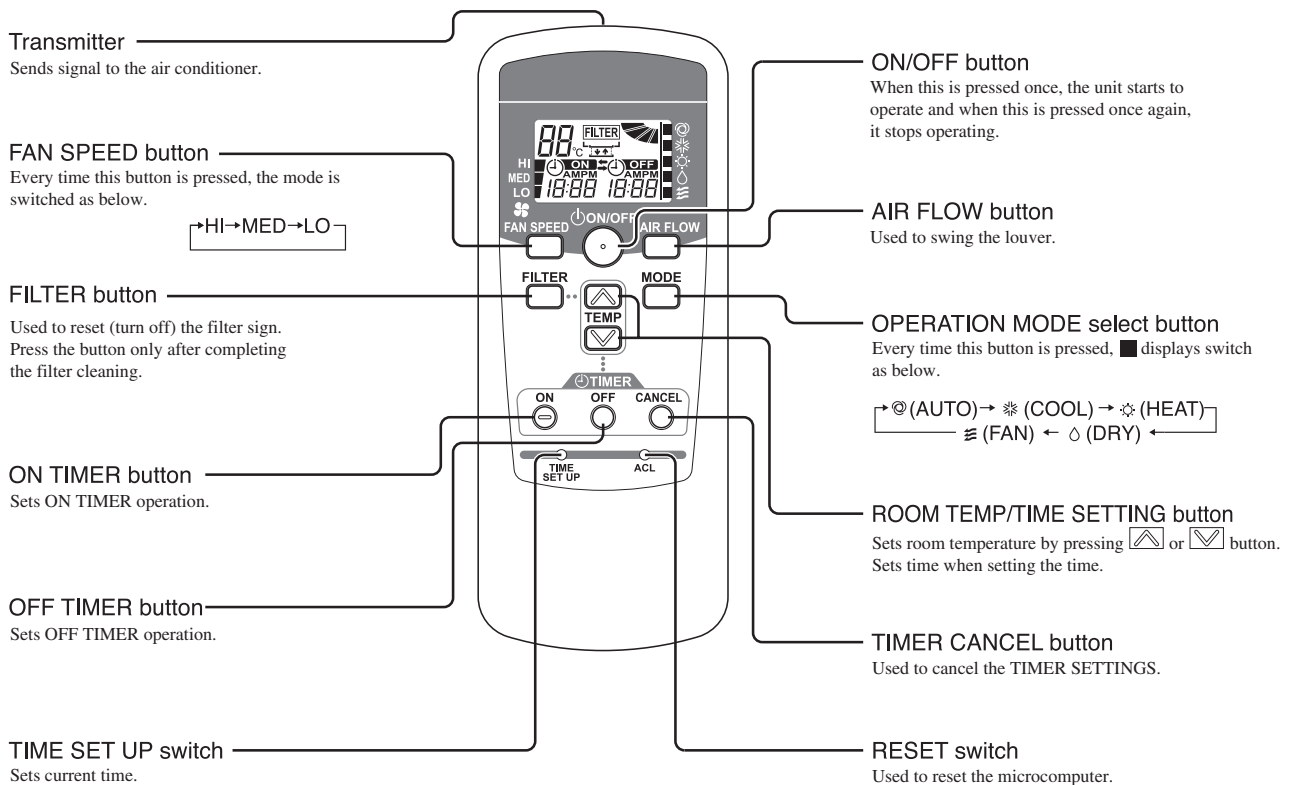

* All displays are described in the liquid crystal display for explanation

1.11.2 Operation control function by the wired remote control

Model RC-EX1A

(1) Switching sequence of the operation mode switches of remote control

- Tap the change operation mode button on the TOP screen.
- When the change operation mode screen is displayed, tap the button of desired mode.
- When the operation mode is selected, the display returns to the TOP screen.

Icons displayed have the following meanings.

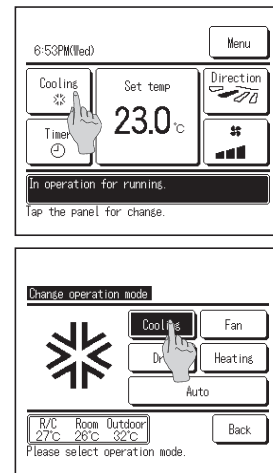
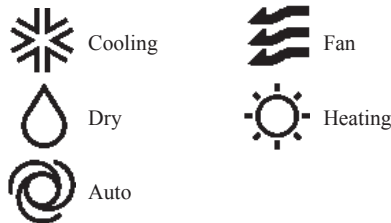

Notes(1) Operation modes which cannot be selected depending on combinations of IU and OU are not displayed.

- When the Auto is selected, the cooling and heating switching operation is performed automatically according to indoor and outdoor temperatures.

(2) CPU reset

Reset CPU from the remote control as follows.

- Tap the **Menu** button** on the TOP screen.
- Main menu screen is displayed.**
Tap the "Service & Maintenance" on the menu screen.
- Display the service password input screen.**
Enter the service password (4-digit number).
- Service & maintenance menus are displayed.**
- Special settings**
CPU reset : Microcomputers of IU and OU connected are reset (State of restoration after power failure).
- CPU reset**
All microcomputers on the R/C operated, other R/Cs, IUs and OUs are reset (State of restoration after power failure). Tap [Yes] to reset CPU

(3) Power failure compensation function (Electric power supply failure)

Enable the Auto-restart function from the remote control as follows.

- Tap the **Menu** button** on the TOP screen.
- Main menu screen is displayed.**
Tap the "Service & Maintenance" on the menu screen.
- Display the service password input screen.**
Enter the service password (4-digit number).
- R/C setting menu 1**
- R/C setting menu 2**
- R/C setting menu 3**
- Auto-restart**
Enable : It returns to the state before the power supply failure as soon as the power is restored (After the end of the primary control at the power on).
Disable : It stops after the restoration of power supply, regardless of the state of operation before the power failure.

- Since it memorizes always the condition of remote control, it starts operation according to the contents of memory no sooner than normal state is recovered after the power failure. Although the auto swing stop position and the timer mode are cancelled, the weekly timer setting is restored with the holiday setting for all weekdays. After recovering from the power failure, it readjusts the clock and resets the holiday setting for each weekday so that the setting of weekly timer becomes effective.

- Content memorized with the power failure compensation are as follows.

Note (1) Items (f), (g) and (h) are memorized regardless whether the power failure compensation is effective or not while the setting of silent mode is cancelled regardless whether the power failure compensation is effective or not.

- (a) At power failure – Operating/stopped

If it had been operating under the off timer mode, sleep timer mode, the state of stop is memorized. (Although the timer mode is cancelled at the recovery from power failure, the setting of weekly timer is changed to the holiday setting for all weekdays.)

- (b) Operation mode

- (c) Airflow volume mode

- (d) Room temperature setting

- (e) Louver auto swing/stop

However, the stop position (4-position) is cancelled so that it returns to Position (1).

- (f) “Remote control function items” which have been set with the remote control function setting (“Indoor function items” are saved in the memory of indoor unit.)

- (g) Upper limit value and lower limit value which have been set with the temperature setting control

- (h) Sleep timer and weekly timer settings (Other timer settings are not memorized.)

Model RC-E5

(1) Switching sequence of the operation mode switches of remote control



(2) CPU reset

This functions when “CHECK” and “ESP” buttons on the remote control are pressed simultaneously. Operation is same as that of the power supply reset.

(3) Power failure compensation function (Electric power supply failure)

- This becomes effective if “Power failure compensation effective” is selected with the setting of remote control function.
- Since it memorizes always the condition of remote control, it starts operation according to the contents of memory no sooner than normal state is recovered after the power failure. Although the auto swing stop position and the timer mode are cancelled, the weekly timer setting is restored with the holiday setting for all weekdays. After recovering from the power failure, it readjusts the clock and resets the holiday setting for each weekday so that the setting of weekly timer becomes effective.
- Content memorized with the power failure compensation are as follows.

Note (1) Items (f), (g) and (h) are memorized regardless whether the power failure compensation is effective or not while the setting of silent mode is cancelled regardless whether the power failure compensation is effective or not.

(a) At power failure – Operating/stopped

If it had been operating under the off timer mode, sleep timer mode, the state of stop is memorized. (Although the timer mode is cancelled at the recovery from power failure, the setting of weekly timer is changed to the holiday setting for all weekdays.)

- (b) Operation mode
- (c) Airflow volume mode
- (d) Room temperature setting
- (e) Louver auto swing/stop

However, the stop position (4-position) is cancelled so that it returns to Position (1).

- (f) “Remote control function items” which have been set with the remote control function setting (“Indoor function items” are saved in the memory of indoor unit.)
- (g) Upper limit value and lower limit value which have been set with the temperature setting control
- (h) Sleep timer and weekly timer settings (Other timer settings are not memorized.)

[Parts layout on remote control PCB]

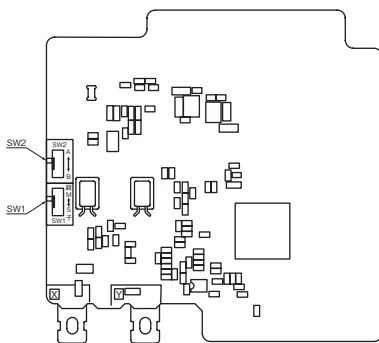

Master/ slave setting when more than one remote controls are used

A maximum of two remote controls can be connected to one indoor unit (or one group of indoor units.)

Switch	Setting	Contents
SW1	M	Master remote control
	S	Slave remote control

Note (1) Don't change SW2 because it is not used normally.

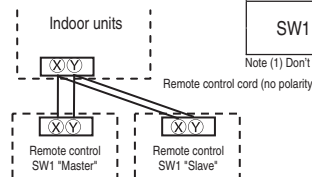

Caution

When using multiple remote controls, the following displays or settings cannot be done with the slave remote control. It is available only with the master remote control.

- ① Louver position setting (set upper or lower limit of swinging range)
- ② Setting indoor unit functions
- ③ Setting temperature range
- ④ Operation data display
- ⑤ Error data display
- ⑥ Silent mode setting
- ⑦ Test operation of drain pump
- ⑧ Remote control sensor setting

1.11.3 Operation control function by the indoor control

(I) FDT, FDTc, FDen, FDU, FDUM, FDF series

(1) Auto operation

(a) If "Auto" mode is selected by the remote control, the heating and the cooling are automatically switched according to the difference between outdoor air temperature and setting temperature and the difference between setting temperature and return air temperature. (When the switching of cooling mode ↔ heating mode takes place within 3 minutes, the compressor does not operate for 3 minutes by the control of 3-minute timer.) This will facilitate the cooling/heating switching operation in intermediate seasons and the adaptation to unmanned operation at stores, etc (ATM corner of bank).

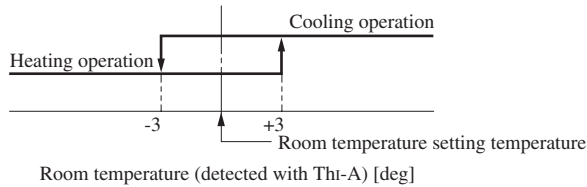

Notes (1) Temperature range of switching cooling/heating mode can be changed by RC-EX1A from ±1.0 ~ ±4.0.

(2) Room temperature control during auto cooling/auto heating is performed according to the room temperature setting temperature. (DIFF: ±1 deg)

(3) If the indoor heat exchanger temperature rises to 59°C or higher during heating operation, it is switched automatically to cooling operation. In addition, for 1 hour after this switching, the heating operation is not performed, regardless of the temperature shown at right.

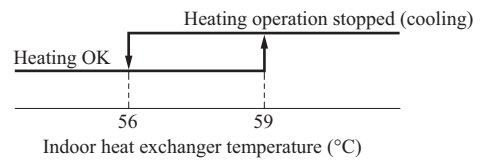

(b) The following automatic controls are performed other than (a) above.

(i) Cooling or heating operation mode is judged according to the conditions of the "Judgment based on Setting temperature + Cooling select temperature and Indoor return air temperature" and the "Judgment based on Outdoor temperature".

- 1) In "Setting temperature - Cooling select temperature < Indoor return air temperature" and "Outdoor temperature/Cooling < Outdoor return air temperature" ⇒ Operation mode: Cooling
- 2) "Setting temperature + Heating select temperature > Indoor return air temperature" and "Outdoor temperature/Heating > Outdoor air temperature" ⇒ Operation mode: Heating
- 3) The outdoor air temperature of the above judgment conditions is sampled at every 10 minutes.
- 4) In the range where the above cooling and heating zones are overlapped ⇒ Forced thermostat OFF

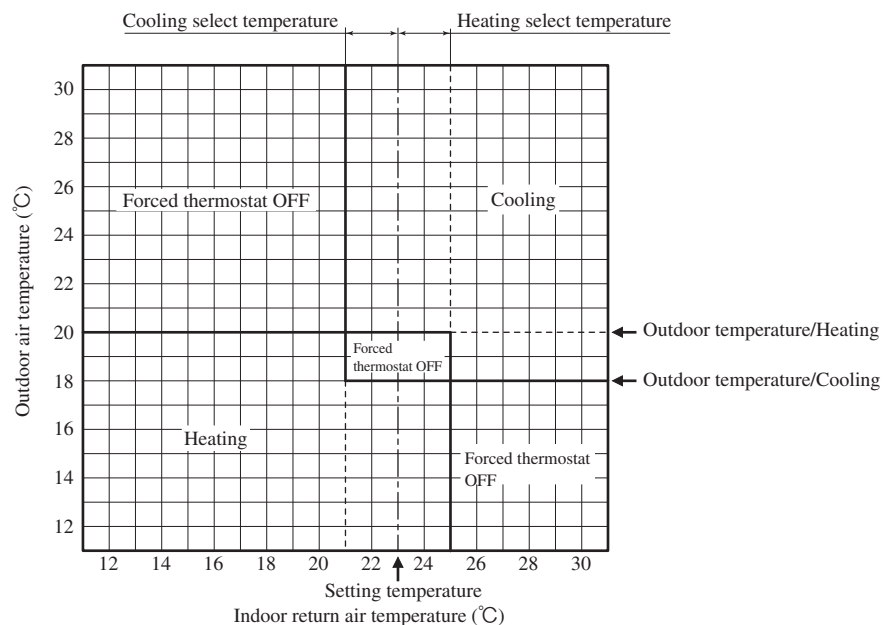

- (ii) Regardless of the setting temperature, the cooling or heating operation mode is judged according to the "Judgment based on Room temperature/Cooling or Heating and Outdoor temperature/Cooling or Heating".
- 1) In case of "Room temperature/Cooling < Indoor return air temperature" and "Outdoor temperature/Cooling < Outdoor air temperature" ⇒ Operation mode: Cooling
 - 2) In case of "Room temperature/Heating > Indoor return air temperature" and "Outdoor temperature /Heating > Outdoor air temperature" ⇒ Operation mode: Heating
 - 3) The outdoor air temperature of the above judgment conditions is sampled at every 10 minutes.
 - 4) In the range where the above cooling and heating zones are overlapped ⇒ Forced thermostat OFF

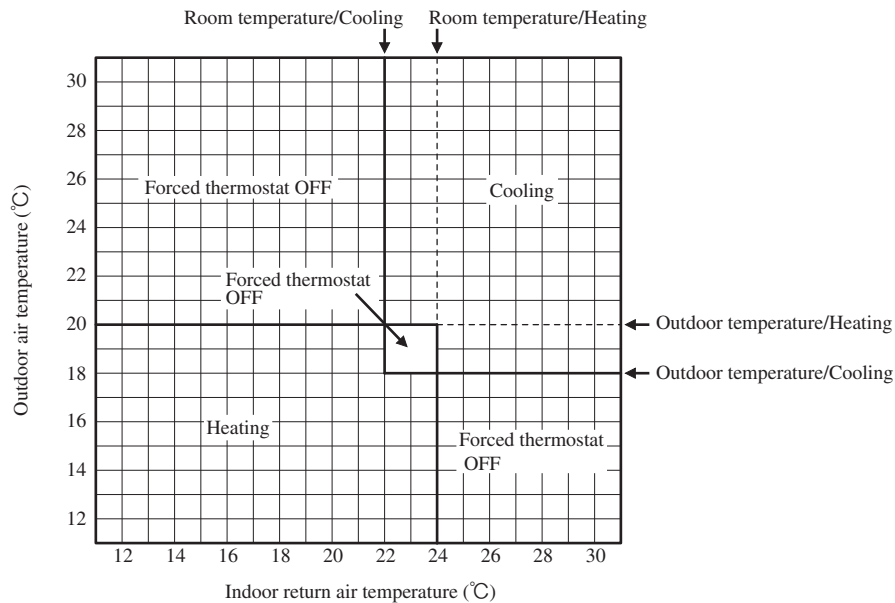

(2) Operations of functional items during cooling/heating

Operation / Functional item	Cooling		Fan	Heating			Dehumidify
	Thermostat ON	Thermostat OFF		Thermostat ON	Thermostat OFF	Hot start (Defrost)	
Compressor	○	×	×	○	×	○	○/×
4-way valve	×	×	×	○	○	○(×)	×
Outdoor unit fan	○	×	×	○	×	○(×)	○/×
Indoor unit fan	○	○	○	○/×	○/×	○/×	○/×
Drain pump ⁽³⁾	○	× ⁽²⁾	× ⁽²⁾	○/× ⁽²⁾			Thermostat ON: ○ Thermostat OFF: × ⁽²⁾

Note (1) ○: Operation ×: Stop ○/×: Turned ON/OFF by the control other than the room temperature control.
 (2) ON during the drain motor delay control.
 (3) Drain pump ON setting may be selected with the indoor unit function setting of the wired remote control.

(3) Dehumidifying operation

Return air temperature thermistor [ThI-A (by the remote control when the remote control thermistor is enabled)] controls the indoor temperature environment simultaneously.

- (a) Operation is started in the cooling mode. When the difference between the return air temperature and the setting temperature is 2°C or less, the indoor unit fan tap is brought down by one tap. That tap is retained for 3 minutes after changing the indoor unit fan tap.
- (b) If the return air temperature exceeds the setting temperature by 3°C during dehumidifying operation, the indoor unit fan tap is raised. That tap is retained for 3 minutes after changing the indoor unit fan tap.
- (c) If the thermostat OFF is established during the above control, the indoor unit fan tap at the thermostat ON is retained so far as the thermostat is turned OFF.

(4) Timer operation

(a) RC-EX1A

- (i) **Sleep timer**
Set the time from the start to stop of operation. The time can be selected in the range from 30 to 240 minutes (in the unit of 10-minute).
Note (1) Enable the "Sleep timer" setting from the remote control. If the setting is enabled, the timer operates at every time.
- (ii) **Set OFF timer by hour**
Set the time to stop the unit after operation, in the range from 1 to 12 hours (in the unit of hour).
- (iii) **Set ON timer by hour**
Set the time to start the unit after the stop of operation, in the range from 1 to 12 hours (in the unit of hour). It is allowed also to set simultaneously the indoor temperature, operation mode, air flow rate and warm-up enabled/disabled.
- (iv) **Set ON timer by clock**
Set the time to start operation. The time can be set in the unit of 5-minute. This setting can be activated only once or at every time. It is allowed also to set simultaneously the indoor temperature, operation mode, air flow rate and warm-up enabled/disabled.
Note (1) It is necessary to set the clock to use this timer.
- (v) **Set OFF timer by clock**
Set the time to stop operation. The time can be set in the unit of 5-minute. This setting can be activated only once or at every time.
Note (1) It is necessary to set the clock to use this timer.
- (vi) **Weekly timer**
Set the ON or OFF timer for a week. Up to 8 patterns can be set for a day. The day-off setting is provided for holidays and non-business days.
Note (1) It is necessary to set the clock to use the weekly timer.

(vii) Combination of patterns which can be set for the timer operations

	Sleep time	Set OFF timer by hour	Set ON timer by hour	Set OFF timer by clock	Set ON timer by clock	Weekly timer
Sleep time		×	×	○	○	○
Set OFF timer by hour	×		×	×	×	×
Set ON timer by hour	×	×		×	×	×
Set OFF timer by clock	○	×	×		○	×
Set ON timer by clock	○	×	×	○		×
Weekly timer	○	×	×	×	×	

Note (1) ○: Allowed ×: Not

(b) RC-E5

- (i) **Sleep timer**
Set the duration of time from the present to the time to turn off the air-conditioner.
It can be selected from 10 steps in the range from "OFF 1 hour later" to "OFF 10 hours later". After the sleep timer setting, the remaining time is displayed with progress of time in the unit of hour.
- (ii) **OFF timer**
Time to turn OFF the air-conditioner can be set in the unit of 10 minutes.
- (iii) **ON timer**
Time to turn ON the air-conditioner can be set. Indoor temperature can be set simultaneously.
- (iv) **Weekly timer**
Timer operation (ON timer, OFF timer) can be set up to 4 times a day for each weekday.
- (v) **Timer operations which can be set in combination**

Item	Timer	OFF timer	ON timer	Weekly timer
Timer		×	○	×
OFF timer	×		○	×
ON timer	○	○		×
Weekly timer	×	×	×	

Note (1) ○: Allowed ×: Not

(2) Since the ON timer, sleep timer and OFF timer are set in parallel, when the times to turn ON and OFF the airconditioner are duplicated, the setting of the OFF timer has priority.

(5) Remote control display during the operation stop

When the operation is stopped (the power supply is turned ON), it displays preferentially the “Room temperature”, “Center/Remote”, “Filter sign”, “Inspection” and “Timer operation”.

(6) Hot start (Cold draft prevention at heating)**(a) Operating conditions**

When either one of following conditions is met, the hot start control is performed.

- (i) From stop to heating operation
- (ii) From cooling to heating operation
- (iii) Form heating thermostat OFF to ON
- (iv) After completing the defrost control (only on units with thermostat ON)

(b) Contents of operation

- (i) Indoor fan motor control at hot start
 - 1) Within 7 minutes after starting heating operation, the fan mode is determined depending on the condition of thermostat (fan control with heating thermostat OFF).
 - a) Thermostat OFF
 - i) Operates according to the fan control setting at heating thermostat OFF.
 - ii) Even if it changes from thermostat OFF to ON, the fan continues to operate with the fan control at thermostat OFF till the heat exchanger thermistor (ThI-R1 or R2, whichever higher) detects 35°C or higher.
 - iii) When the heat exchanger thermistor (ThI-R1 or R2, whichever higher) detects 35°C or higher, the fan operates with the set airflow volume.
 - b) Thermostat ON
 - i) When the heat exchanger thermistor (ThI-R1 or R2, whichever higher) detects 25°C or lower, the fan is turned OFF and does not operate.
 - ii) When the heat exchanger thermistor (ThI-R1 or R2, whichever higher) detects 25°C or higher, the fan operates with the fan control at heating thermostat OFF.
 - iii) When the heat exchanger thermistor (ThI-R1 or R2, whichever higher) detects 35°C or higher, the fan operates with the set airflow volume.
 - c) If the fan control at heating thermostat OFF is set at the “Set airflow volume” (from the remote control), the fan operates with the set airflow volume regardless of the thermostat ON/OFF.
 - 2) Once the fan motor is changed from OFF to ON during the thermostat ON, the indoor fan motor is not turned OFF even if the heat exchanger thermistor detects lower than 25°C.

Note (1) When the defrost control signal is received, it complies with the fan control during defrosting.
 - 3) Once the hot start is completed, it will not restart even if the temperature on the heat exchanger thermistor drops.
- (ii) During the hot start, the louver is kept at the horizontal position.
- (iii) When the fan motor is turned OFF for 7 minutes continuously after defrosting, the fan motor is turned ON regardless of the temperatures detected with the indoor heat exchanger thermistors (ThI-R1, R2).

(c) Ending condition

- (i) If one of following conditions is met during the hot start control, this control is terminated, and the fan is operated with the set airflow volume.
 - 1) Heat exchanger thermistor (ThI-R1 or R2, whichever higher) detects 35°C or higher.
 - 2) It has elapsed 7 minutes after starting the hot start control.

(7) Hot keep

Hot keep control is performed at the start of the defrost control.

(a) Control

- (i) When the indoor heat exchanger temperature (detected with ThI-R1 or R2) drops to 35°C or lower, the speed of indoor fan is changed to the lower tap at each setting.
- (ii) During the hot keep, the louver is kept at the horizontal position.

(b) Ending condition

When the indoor fan is at the lower tap at each setting, it returns to the set airflow volume as the indoor heat exchanger temperature rises to 45°C or higher.

(8) Auto swing control (FDT, FDTC, FDEN, FDF only)

(a) RC-EX1A

(i) Louver control

- 1) To operate the swing louver when the air conditioner is operating, press the “Direction” button on the TOP screen of remote control. The wind direction select screen will be displayed.
- 2) To swing the louver, touch the “Auto swing” button. The lover will move up and down. To fix the swing louver at a position, touch one of [1] - [4] buttons. The swing lover will stop at the selected position.
- 3) Louver operation at the power on with a unit having the louver 4-position control function
The louver swings one time automatically (without operating the remote control) at the power on.
This allows the microcomputer recognizing and inputting the louver motor (LM) position.

(ii) Automatic louver level setting during heating



At the hot start and the heating thermostat OFF, regardless whether the auto swing switch is operated or not (auto swing or louver stop), the louver takes the level position (in order to prevent blowing of cool wind). The louver position display LCD continues to show the display which has been shown before entering this control.

(iii) Louver free stop control

If you touch the “Menu” → “Next” → “R/C settings” buttons one after another on the TOP screen of remote control, the “Flap control” screen is displayed. If the free stop is selected on this screen, the louver motor stops upon receipt of the stop signal from the remote control. If the auto swing signal is received from the remote control, the auto swing will start from the position before the stop.

(b) RC-E5

(i) Louver control

- 1) Press the “LOUVER” button to operate the swing louver when the air conditioner is operating.
“SWING ” is displayed for 3 seconds and then the swing louver moves up and down continuously.
- 2) To fix the swing louver at a position, press one time the “LOUVER” button while the swing louver is moving so that four stop positions are displayed one after another per second.
When a desired stop position is displayed, press the “LOUVER” button again. The display stops, changes to show the “STOP 1 ” for 5 seconds and then the swing louver stops.
- 3) Louver operation at the power on with a unit having the louver 4-position control function
The louver swings one time automatically (without operating the remote control) at the power on.
This allows inputting the louver motor (LM) position, which is necessary for the microcomputer to recognize the louver position.

Note (1) If you press the “LOUVER” button, the swing motion is displayed on the louver position LCD for 10 second. The display changes to the “SWING ” display 3 seconds later.

(ii) Automatic louver level setting during heating

At the hot start with the heating thermostat OFF, regardless whether the auto swing switch is operated or not (auto swing or louver stop), the louver takes the level position (In order to prevent the cold start). The louver position display LCD continues to show the display which has been shown before entering this control.

(iii) Louver-free stop control

When the louver-free stop has been selected with the indoor function of wired remote control “ POSITION”, the louver motor stops when it receives the stop signal from the remote control. If the auto swing signal is received from the remote control, the auto swing will start from the position where it was before the stop.

Note (1) When the indoor function of wired remote control “ POSITION” has been switched, switch also the remote control function “ POSITION” in the same way.

(9) Thermostat operation**(a) Cooling**

- (i) Thermostat is operated with the room temperature control.
 (ii) Thermostat is turned ON or OFF relative to the set room temperature as shown below.

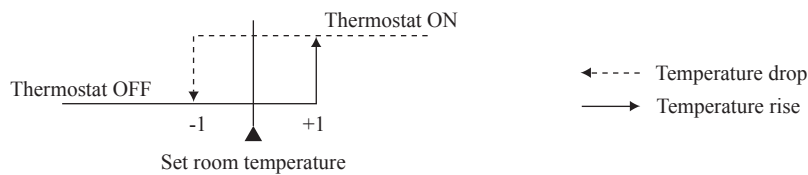

- (iii) Thermostat is turned ON when the room temperature is in the range of $-1 < \text{Set temperature} < +1$ at the start of cooling operation (including from heating to cooling).

(b) Heating

- (i) Thermostat is operated with the room temperature control.
 (ii) Thermostat is turned ON or OFF relative to the set room temperature as shown below.

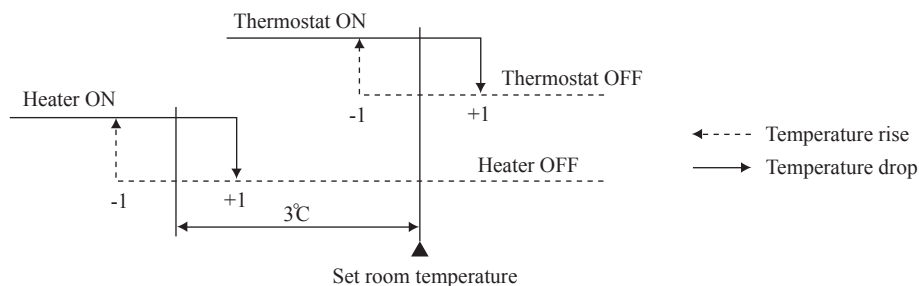

- (iii) Thermostat is turned ON when the room temperature is in the range of $-1 < \text{Set point} < +1$ at the start of cooling operation (including from cooling to heating).

(c) Fan control during heating thermostat OFF

- (i) Following fan controls during the heating thermostat OFF can be selected with the indoor function setting of the wired remote control.
- ① Low fan speed (Factory default), ② Set fan speed, ③ Intermittence, ④ Fan OFF
- (ii) When the “Low fan speed (Factory default)” is selected, the following taps are used for the indoor fans.
- For AC motor : Lo tap
 - For DC motor : ULo tap
- (iii) When the “Set fan speed” is selected, it is operated with the set fan speed also in the thermostat OFF condition.
- (iv) If the “Intermittence” is selected, following controls are performed:
- 1) If the thermostat is turned OFF during the heating operation, the indoor unit moves to the hot control and turns OFF the indoor fan if the heat exchanger thermistors (both ThI-R1 and R2) detect 25°C or lower.
 - 2) Indoor fan OFF is fixed for 5 minutes. After the 5 minutes, the indoor fan is operated at Lo or ULo for 2 minutes. In the meantime the louver is controlled at level.
 - 3) After operating at Lo or ULo for 2 minutes, the indoor fan moves to the state of 1) above.
 - 4) If the thermostat is turned ON, it moves to the hot start control.
 - 5) When the heating thermostat is turned OFF, the remote control displays the temperature detected at the fan stop and revises the temperature later when the indoor fan changes from Lo or ULo to stop. The remote control uses the operation data display function to display temperatures and updates values of temperature even when the indoor fan is turned OFF.
 - 6) When the defrosting starts while the heating thermostat is turned OFF or the thermostat is turned OFF during defrosting, the indoor fan is turned OFF. (Hot keep or hot start control takes priority.) However, the suction temperature is updated at every 7-minute.
 - 7) When the heating thermostat is turned ON or the operation is changed to another mode (including stop), this control is stopped immediately, and the operating condition is restored.
- (v) When the “Fan OFF” is selected, the fan on the indoor unit of which the thermostat has been turned OFF, is turned OFF. The same occurs also when the remote control sensor is effective.

(d) Fan control during cooling thermostat OFF

- (i) Following fan controls during the cooling thermostat OFF can be selected with the indoor function setting of the wired remote control.
 - ① Low fan speed, ② Set fan speed (Factory default), ③ Intermittence, ④ Fan OFF
- (ii) When the “Low fan speed” is selected, the following taps are used for the indoor fans.
 - For AC motor : Lo tap
 - For DC motor : ULo tap
- (iii) When the “Set fan speed” is selected, it is operated with the set fan speed also in the thermostat OFF condition.
- (iv) If the “Intermittence” is selected, following controls are performed:
 - 1) If the thermostat is turned OFF during the cooling operation, the indoor unit fan motor stope.
 - 2) Indoor fan OFF is fixed for 5 minutes. After the 5 minutes, the indoor fan is operated at Lo or ULo for 2 minutes. In the meantime the louver is controlled at level.
 - 3) After operating at Lo or ULo for 2 minutes, the indoor fan moves to the state of 1) above.
 - 4) If the thermostat is turned ON, the fan starts operation at set fan speed.
 - 5) When the cooling thermostat is turned OFF, the remote control displays the temperature detected at the fan stop and revises the temperature later when the indoor fan changes from Lo or ULo to stop.
By using operation data display function at wireless remote control, the temperature as displayad and the value is updated including the fan stops.
 - 6) When the cooling thermostat is turned ON or the operation is changed to another mode (including stop), this control is stopped immediately, and the operating condition is restored.
- (v) When the “Fan OFF” is selected, the fan on the indoor unit of which the thermostat has been turned OFF, is turned OFF. The same occurs also when the remote control sensor is effective.

(10) Filter sign

As the operation time (Total ON time of ON/OFF switch) accumulates to 180 hours (1), “FILTER CLEANING” is displayed on the remote control. (This is displayed when the unit is in trouble and under the centralized control, regardless of ON/OFF)

Note (1) Time setting for the filter sign can be made as shown below using the indoor function of wired remote control “FILTER SIGN SET”. (It is set at TYPE 1 at the shipping from factory.)

Filter sign setting	Function
TYPE 1	Setting time: 180 hrs (Factory default)
TYPE 2	Setting time: 600 hrs
TYPE 3	Setting time: 1,000 hrs
TYPE 4	Setting time: 1,000 hrs (Unit stop) ⁽²⁾

(2) After the setting time has elapsed, the “FILTER CLEANING” is displayed and, after operating for 24 hours further (counted also during the stop), the unit stops.

(11) Compressor inching prevention control

- (a) 3-minute timer

When the compressor has been stopped by the thermostat, remote control operation switch or anomalous condition, its restart will be inhibited for 3 minutes. However, the 3-minute timer is invalidated at the power on the electric power source for the unit.
- (b) 3-minute forced operation timer
 - (i) Compressor will not stop for 3 minutes after the compressor ON. However, it stops immediately when the unit is stopped by means of the ON/OFF switch or by when the thermister turned OFF the change of operation mode.
 - (ii) If the thermostat is turned OFF during the forced operation control of heating compressor, the louver position (with the auto swing) is returned to the level position.

Note (1) The compressor stops when it has entered the protective control.

(12) Drain pump control

- (a) This control is operated when the inverter frequency is other than 0 Hz during the cooling operation and automatic cooling and dehumidifying operations.
- (b) Drain pump ON condition continues for 5 minutes even when it enters the OFF range according to (i) above after turning the drain pump ON, and then stops. The 5-minute delay continues also in the event of anomalous stop.
- (c) The drain pump is operated with the 5-minute delay operation when the compressor is changed from ON to OFF.
- (d) Even in conditions other than the above (such as heating, fan, stop, cooling thermostat OFF), the drain pump control is performed by the drain detection.
- (e) Following settings can be made using the indoor function setting of the wired remote control.
 - (i) 标准 [Standard (in cooling & dry)] : Drain pump is run during cooling and dry.
 - (ii) 标准AND采暖 [Operate in standard & heating] : Drain pump is run during cooling, dry and heating.
 - (iii) 标准AND采暖AND送风 [Operate in heating & fan] : Drain pump is run during cooling, dry, heating and fan.
 - (iv) 标准AND送风 [Operate in standard & fan] : Drain pump is run during cooling, dry and fan.

Note (1) Values in [] are for the RC-EX1A model.

(13) Drain motor (DM) control

- (a) Drain detection switch is turned ON or OFF with the float switch (FS) and the timer.

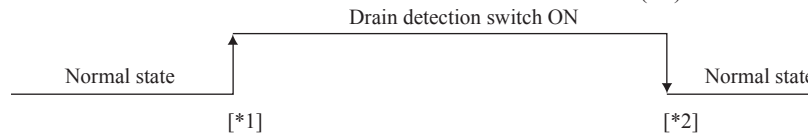

[*1] Drain detection switch is turned “ON” when the float switch “Open” is detected for 3 seconds continuously in the drain detectable space.

[*2] Drain detection switch is turned “OFF” when the float switch “Close” is detected for 10 seconds continuously.

- (i) It detects always from 30 seconds after turning the power ON.
 - 1) There is no detection of anomalous draining for 10 seconds after turning the drain pump OFF.
 - 2) Turning the drain detection switch “ON” causes to turn ON the drain pump forcibly.
 - 3) Turning the drain detection switch “OFF” releases the forced drain pump ON condition.
- (b) Indoor unit performs the control A or B depending on each operating condition.

	Indoor unit operation mode				
	Stop ⁽¹⁾	Cooling	Dry	Fan ⁽²⁾	Heating
Compressor ON		Control A			
Compressor OFF		Control B			

Note (1) Including the stop from the cooling, dehumidifying, fan and heating, and the anomalous stop
 (2) Including the “Fan” operation according to the mismatch of operation modes

- (i) Control A
 - 1) If the float switch detects any anomalous draining condition, the unit stops with the anomalous stop (displays E9) and the drain pump starts. After detecting the anomalous condition, the drain motor continues to be ON.
 - 2) It keeps operating while the float switch is detecting the anomalous condition.
- (ii) Control B

If the float switch detects any anomalous drain condition, the drain motor is turned ON for 5 minutes, and at 10 seconds after the drain motor OFF it checks the float switch. If it is normal, the unit is stopped under the normal mode or, if there is any anomalous condition, E9 is displayed and the drain motor is turned ON. (The ON condition is maintained during the drain detection.)

(14) Operation check/drain pump test run operation mode

- (a) If the power is turned on by the dip switch (SW7-1) on the indoor PCB when electric power source is supplied, it enters the mode of operation check/drain pump test run. It is ineffective (prohibited) to change the switch after turning power on.
- (b) When the communication with the remote control has been established within 60 seconds after turning power on by the dip switch (SW7-1) ON, it enters the operation check mode. Unless the remote control communication is established, it enters the drain pump test run mode.

Note (1) To select the drain pump test run mode, disconnect the remote control connector (CNB) on the indoor PCB to shut down the remote control communication.

(c) Operation check mode

There is no communication with the outdoor unit but it allows performing operation in respective modes by operating the remote control.

(d) Drain pump test run mode

As the drain pump test run is established, the drain pump only operates and during the operation protective functions by the microcomputer of indoor unit become ineffective.

(15) Cooling, dehumidifying frost protection

- (a) To prevent frosting during cooling mode or dehumidifying mode operation, the of compressor speed is reduced if the indoor heat exchanger temperature (detected with ThI-R) drops to 1.0 °C or lower at 4 minutes after the start of compressor operation. If the indoor unit heat exchanger temperature is 1.0 °C or lower after 1 minutes, the compressor speed is reduced further. If it becomes 2.5 °C or higher, the control terminates. When the indoor heat exchanger temperature has become as show below after reducing the compressor speed, it is switched to the fan operation. For the selection of indoor fan speed, refer to item 2).

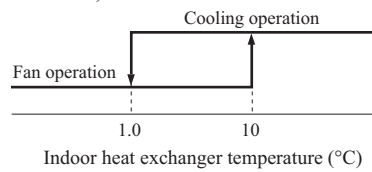

(b) Selection of indoor fan speed

If it enters the frost prevention control during cooling operation (excluding dehumidifying), the indoor unit fan speed is switched.

(i) In the case of FDT, FDU, FDUM only.

- 1) When the indoor return air detection temperature (detected with ThI-A) is 23°C or higher and the indoor heat exchanger temperature (detected with ThI-R) detects the compressor frequency drop start temperature A°C+1°C, of indoor unit fan speed is increased by 20rpm.
- 2) If the phenomenon of 1) above is detected again after the acceleration of indoor unit fan, indoor unit fan speed is increased further by 20rpm.

Note (1) Indoor unit fan speed can be increased by up to 2 taps.

• Compressor frequency drop start temperature

Item	Symbol	A
Temperature - Low (Factory default)		1.0
Temperature - High		2.5

Note (1) Frost prevention temperature setting can be selected with the indoor unit function setting of the wired remote control.

(16) Heating overload protection

- (a) If the indoor heat exchanger temperature (detected with ThI-R) at 63°C or higher is detected for 2 seconds continuously, the compressor stops. When the compressor is restarted after a 3-minute delay, if a temperature at 63°C or higher is detected for 2 seconds continuously within 60 minutes after initial detection and if this is detected 5 times consecutively, the compressor stops with the anomalous stop (E8). Anomalous stop occurs also when the indoor heat exchanger temperature at 63°C or higher is detected for 6 minutes continuously.

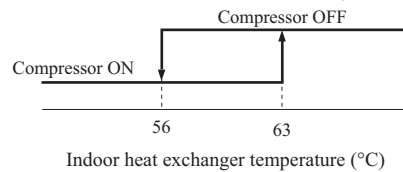

(b) Indoor unit fan speed selection

If, after second detection of heating overload protection up to fourth, the indoor fan is set at Me and Lo taps when the compressor is turned ON, the indoor fan speed is increased by 1 tap.

(17) Anomalous fan motor

- (a) After starting the fan motor, if the fan motor speed is 200min^{-1} or less is detected for 30 seconds continuously and 4 times within 60 minutes, then fan motor stops with the anomalous stop (E16).
- (b) If the fan motor fails to reach at $-50(\text{FDU: } -500)\text{min}^{-1}$ less than the required speed, it stops with the anomalous stop (E20).

(18) Plural unit control – Control of 16 units group by one remote control

(a) Function

One remote control switch can control a group of multiple number of unit (Max. 16 indoor units). “Operation mode” which is set by the remote control switch can operate or stop all units in the group one after another in the order of unit No.⁽¹⁾. Thermostat and protective function of each unit function independently.

Note (1) Unit No. is set by SW2 on the indoor unit control PCB. Unit No. setting by SW2 is necessary for the indoor unit only. In cases of the twin and triple specification, it is necessary set for the master and the slave units. This can be selected by SW5. (All are set for the master unit at the shipping from factory.)

SW2: For setting of 0 – 9, A – F

SW5: For setting of master and slave units
(See table shown at right.)

SW5 setting

Unit	Switch	
	SW5-1	SW5-2
Master unit	OFF	OFF
Slave unit a	OFF	ON
Slave unit b	ON	OFF

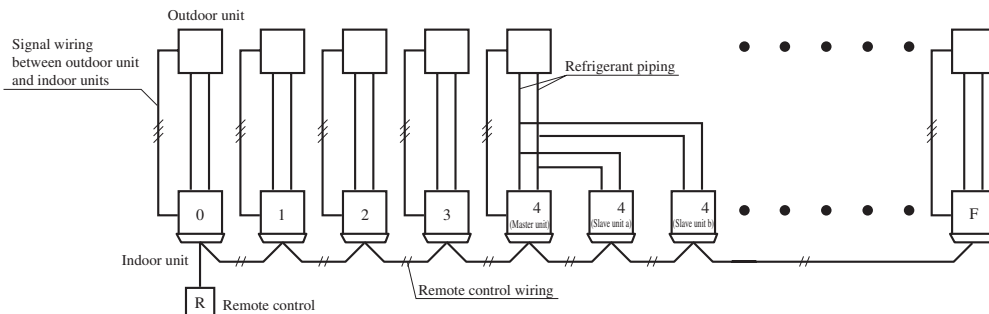

(2) Unit No. may be set at random unless duplicated, it should be better to set orderly like 0, 1, 2, ..., F to avoid mistake.

(b) Display to the remote control

- (i) Center or each remote control basis, heating preparation: the youngest unit No. among the operating units in the remote mode (or the center mode unless the remote mode is available) is displayed.
- (ii) Inspection display, filter sign: Any of unit that starts initially is displayed.
- (iii) Confirmation of connected units
 - 1) In case of RC-EX1A remote control
If you touch the buttons in the order of “Menu” → “Next” → “Service & Maintenance” → “IU address” on the TOP screen of remote control, the indoor units which are connected are displayed.
 - 2) In case of RC-E5 remote control
Pressing “AIR CON No.” button on the remote control displays the indoor unit address. If “▲” “▼” button is pressed at the next, it is displayed orderly starting from the unit of youngest No.
- (iv) In case of anomaly
 - 1) If any anomaly occurs on a unit in a group (a protective function operates), that unit stops with the anomalous stop but any other normal units continue to run as they are.
 - 2) Signal wiring procedure
Signal wiring between indoor and outdoor units should be made on each unit same as the normal wiring. For the group control, lay connect with sires wiring between rooms using terminal blocks (X, Y) of remote control. Connect the remote control communication wire separately from the power supply wire or wires of other electric devices (AC220V or higher).

(19) High ceiling control

When sufficient air flow rate cannot be obtained from the indoor unit which is installed at a room with high ceiling, the air flow rate can be increased by changing the fan tap. To change the fan tap, use the indoor unit function “FAN SPEED SET” on the wired remote control.

Fan tap		Indoor unit airflow setting			
		☀️ - ☀️ - ☀️ - ☀️	☀️ - ☀️ - ☀️	☀️ - ☀️	☀️ - ☀️
FAN SPEED SET	STANDARD	PHi - Hi - Me - Lo	Hi - Me - Lo	Hi - Lo	Hi - Me
	HIGH SPEED1, 2	PHi - PHi - Hi - Me	PHi - Hi - Me	PHi - Me	PHi - Hi

Notes (1) Factory default is STANDARD.

(2) At the hot-start and heating thermostat OFF, or other, the indoor unit fan is operated at the low speed tap of each setting.

(3) This function is not able to be set with wireless remote controls or simple remote control (RCH-E3)

(20) Abnormal temperature thermistor (return air/indoor heat exchanger) wire/short-circuit detection

- (a) Broken wire detection
When the return air temperature thermistor detects -50°C or lower or the heat exchanger temperature thermistor detect -50°C or lower for 5 seconds continuously, the compressor stops. After a 3-minute delay, the compressor restarts but, if it is detected again within 60 minutes after the initial detection for 6 minutes continuously, stops again (the return air temperature thermistor: E7, the heat exchanger temperature thermistor: E6).
- (b) Short-circuit detection
If the heat exchanger temperature thermistor detects 70°C or higher for 5 seconds continuously at 2 minutes and 20 seconds after the compressor ON during cooling operation, the compressor stops (E6).

(21) External input/output control (CnT or CnTA)

Be sure to connect the wired remote control to the indoor unit. Without wired remote control remote operation by CnT is not possible to perform.

• CnT

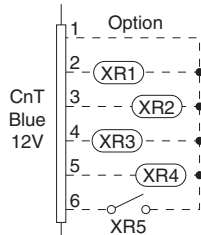

- ① Operation output (CnT-2: XR1)
- ② Heating output (CnT-3: XR2)
- ③ Thermostat ON output (CnT-4: XR3)
- ④ Error output (CnT-5: XR4)
- ⑤ Remote operation input (CnT-6: Volt-free contact)

• CnTA (FDT, FDU, FDUM only)

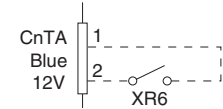

Note (1) CnTA function can be changed by RC-EX1A.

Priority order for combinations of CnT and CnTA input.

		CnTA					
		① Operation stop level	② Operation stop pulse	③ Operation permission/prohibition	④ Operation permission/prohibition pulse	⑤ Cooling/heating selection level	⑥ Cooling/heating selection pulse
CnT	① Operation stop level	CnT ①	CnT ①	CnT ① + CnTA ②	CnT ①	CnT ① / CnTA ⑤	CnT ① / CnTA ⑥
	② Operation stop pulse	CnT ②	CnT ②	CnT ② + CnTA ③	CnT ②	CnT ② / CnTA ⑤	CnT ② / CnTA ⑥
	③ Operation permission/prohibition level	CnT ③ > CnTA ①	CnT ③ > CnTA ②	CnT ③ + CnTA ③	CnT ③	CnT ③ / CnTA ⑤	CnT ③ / CnTA ⑥
	④ Operation permission/prohibition pulse	CnT ④	CnT ④	CnT ④ + CnTA ③※	CnT ④	CnT ④ / CnTA ⑤	CnT ④ / CnTA ⑥
	⑤ Cooling/heating selection level	CnT ⑤ / CnTA ①	CnT ⑤ / CnTA ②	CnT ⑤ / CnTA ③※	CnT ⑤ / CnTA ④	CnT ⑤	CnT ⑤
	⑥ Cooling/heating selection pulse	CnT ⑥ / CnTA ①	CnT ⑥ / CnTA ②	CnT ⑥ / CnTA ③	CnT ⑥ / CnTA ④	CnT ⑥	CnT ⑥

Note (1) Following operation commands are accepted when the operation prohibition is set with CnTA as indicated with *.

Individual operation command from remote control, test run command from outdoor unit and operation command from optional device, CNT input.

Reference: Explanation on the codes and the combinations of codes in the table above

1. In case of CnT “Number”, the CnT “Number” is adopted and CnTA is invalidated.
 2. In case of CnTA “Number”, the CnTA “Number” is adopted and CnT is invalidated.
 3. In case of CnT “Number”/CnTA “Number”, the CnT “Number” and the CnTA “Number” become independent functions each other.
 4. In case of CnT “Number” + CnTA “Number”, the CnT “Number” and the CnTA “Number” become competing functions each other.
 5. In case of CnT “Number” > CnTA “Number”, the function of CnT “Number” supersedes that of CnTA “Number”.
 6. In case of CnT “Number” < CnTA “Number”, the function of CnTA “Number” supersedes that of CnT “Number”.
- (The “Number” above means ① - ⑥ in the table.)

(a) Output for external control (remote display)

Following output connectors (CnT) are provided on the indoor control PCB for monitoring operation status.

- ① **Operation output:** Outputs DC12V signal for driving relay during operation
- ② **Heating output:** Outputs DC12V signal for driving relay during heating operation
- ③ **Thermostat ON output:** Outputs DC12V signal for driving relay when compressor is operating.
- ④ **Error output:** Outputs DC12V signal for driving relay when anomalous condition occurs.

(b) Remote operation input

Remote operation input connector (CnT-6 or CnTA) is provided on the indoor control PCB.

However remote operation by CnT-6 or CnTA is not effective, when “Center mode” is selected by center controller.

In case of plural unit (twin, triple, double twin), remote operation input to CnT-6 or CnTA on the slave indoor unit is invalid.

Only the “LEVEL INPUT” is acceptable for external input, however when the indoor function setting of “Level input (Factory default)” or “Pulse input” is selected by the function for “External input” of the wired remote control, operation status will be changed as follows.

(i) In case of “Level input” setting (Factory default)

Input signal to CnT-6 or CnTA is OFF→ON unit ON
 Input signal to CnT-6 or CnTA is ON→OFF unit OFF
 Operation is not inverted.

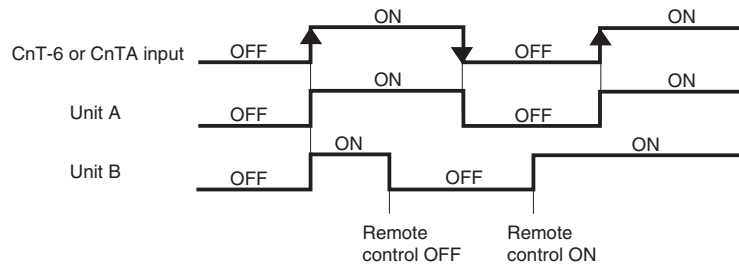

Note: The latest operation has priority

It is available to operate/stop by remote control or center control

(ii) In case of “Pulse input” setting (Local setting)

It is effective only when the input signal to CnT-6 or CnTA is changed OFF→ON, and at that time unit operation [ON/OFF] is inverted.

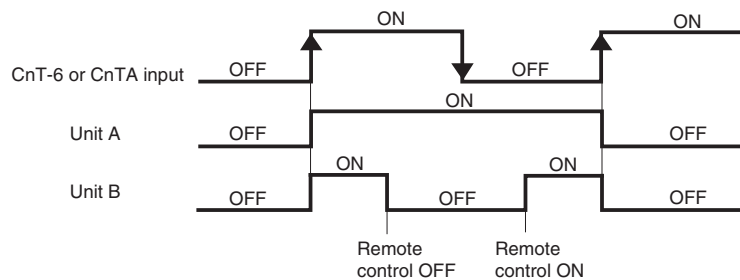

(c) Remote operation

(i) In case of multiple units (Max. 16 indoor units group) are connected to one wired remote control

When the indoor function setting of wired remote control for “External control set” is changed from “Individual (Factory default)” to “For all units”, all units connected in one wired remote control system can be controlled by external operation input.

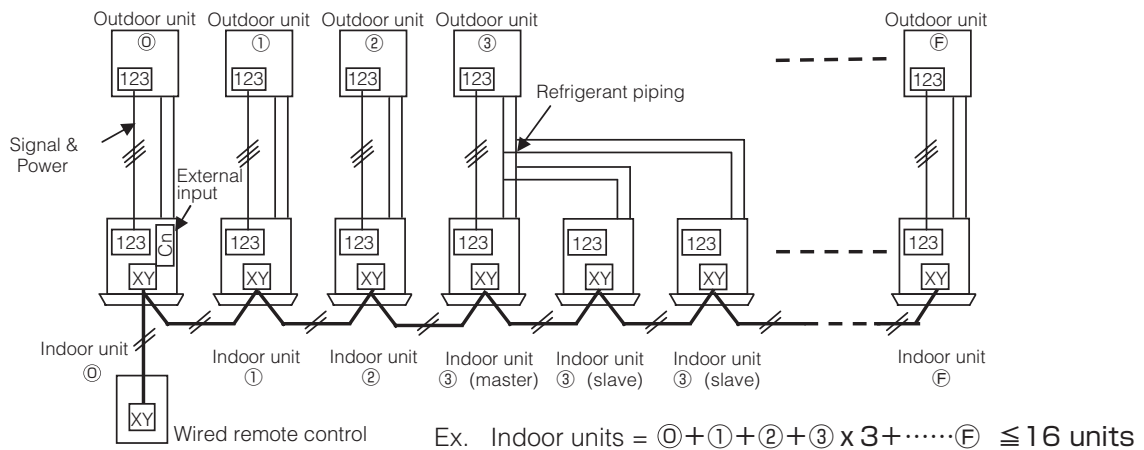

CnT-6 or CnTA	Individual operation (Factory default)		All units operation (Local setting)	
	ON	OFF	ON	OFF
	Only the unit directly connected to the remote control can be operated.	Only the unit directly connected to the remote control can be stopped operation.	All units in one remote control system can be operated.	All units in one remote control system can be stopped operation.
	Unit ① only	Unit ① only	Units ① - ⑥	Units ① - ⑥

When more than one indoor unit (Max. 16 indoor units) are connected in one wired remote control system:

- (1) With the factory default, external input to CnT-6 or CnTA is effective for only the unit ①.
- (2) When setting “For all unit” (Local setting), all units in one remote control system can be controlled by external input to CnT-6 or CnTA on the indoor unit ①.
- (3) External input to CnT-6 or CnTA on the other indoor unit than the unit ① is not effective.

(22) Operation permission/prohibition

(In case of adopting card key switches or commercially available timers)

When the indoor function setting of wired remote control for “Operation permission/prohibition” is changed from “Invalid (Factory default)” to “Valid”, following control becomes effective.

• CnT

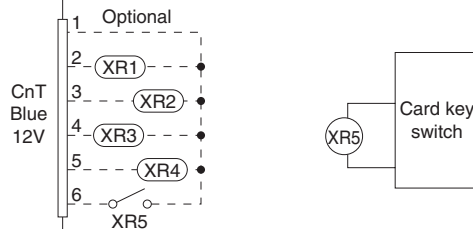

• CnTA (FDT, FDU, FDUM only)

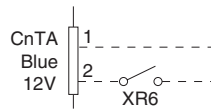

Note (1) CnTA function can be changed by RC-EX1A.

	Normal operation (Factory default)		Operation permission/prohibition mode “Valid” (Local setting)	
	ON	OFF	ON	OFF
CnT-6 or CnTA	Operation	Stop	Operation permission*1	Operation prohibition (Unit stops)

*1 **Only the “LEVEL INPUT” is acceptable for external input**, however when the indoor function setting of “Level input (Factory default)” or “Pulse input” is selected by the function for “External input” of the wired remote control, operation status will be changed as follows.

In case of “Level input” setting	In case of “Pulse input” setting
Unit operation from the wired remote control becomes available*(1)	Unit starts operation *(2)

* (1) In case that “Operation permission/prohibition mode” setting is “Valid” and “External input” setting is “Level input (Factory default)”;

- ① When card key switch is ON (CnT-6 or CnTA ON: Operation permission), start/stop operation of the unit from the wired remote control becomes available.
- ② When card key switch is OFF (CnT-6 or CnTA OFF: Operation prohibition), the unit stops operation in conjunction with OFF signal, and start/stop operation of the unit from the wired remote control becomes not available.

* (2) In case that “Operation permission/prohibition mode” setting is “Valid” and “External input” setting is “Pulse input (Local setting)”;

- ① When card key switch is ON (Operation permission), the unit starts operation in conjunction with ON signal, and also start/stop operation of the unit from the wired remote control becomes available.
- ② When card key switch is OFF (Operation prohibition), the unit stops operation in conjunction with OFF signal, and start/stop operation of the unit from the wired remote control becomes not available.

(3) This function is invalid only at “Center mode” setting done by central control.

(a) In case of CnT ① Operation stop level > CnTA ③ Operation permission/prohibition level

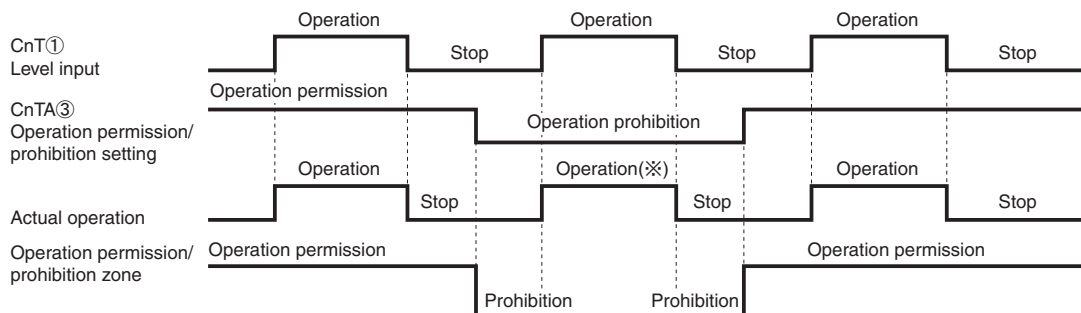

(※) CnT level input supersedes CnTA operation prohibition.

(b) In case of CnT ③ Operation permission/prohibition level + CnTA ③ Operation permission/prohibition level

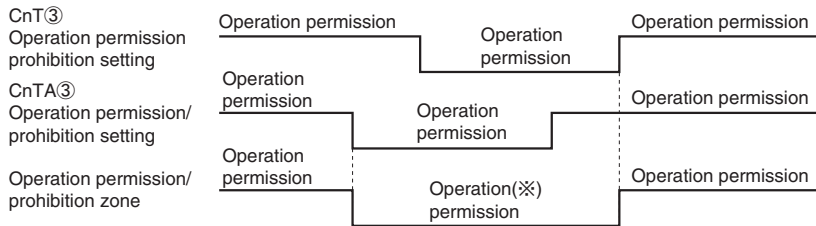

(※) Operation prohibition zone is determined by the OR judgment between CnT Operation prohibition zone and CnTA Operation prohibition zone.

(c) In case of CnT ③ Operation permission/prohibition level > CnTA ② Operation/stop pulse

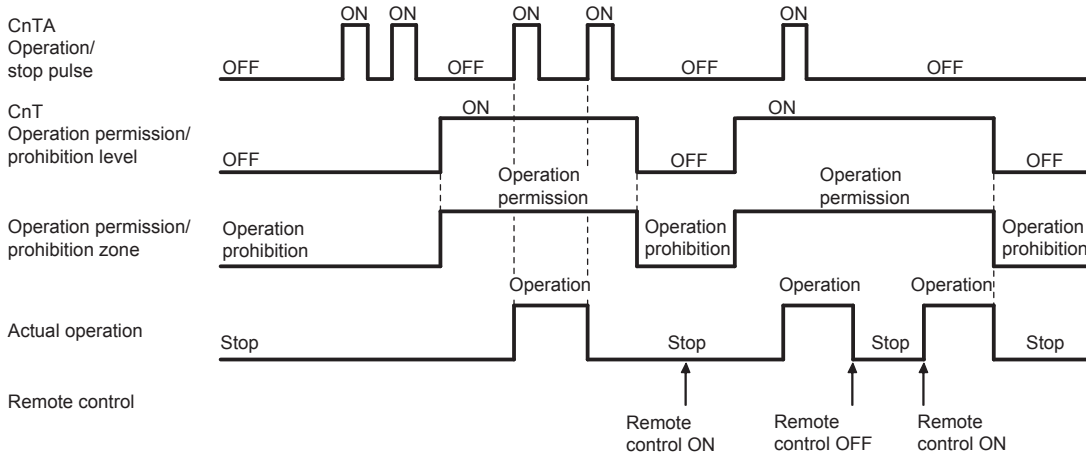

Note (1) If it is prohibited by CnT, all "Operation" and "Stop" commands are not accepted.

(d) In case of CnT ② Operation/stop pulse + CnTA ③ Operation permission/prohibition level

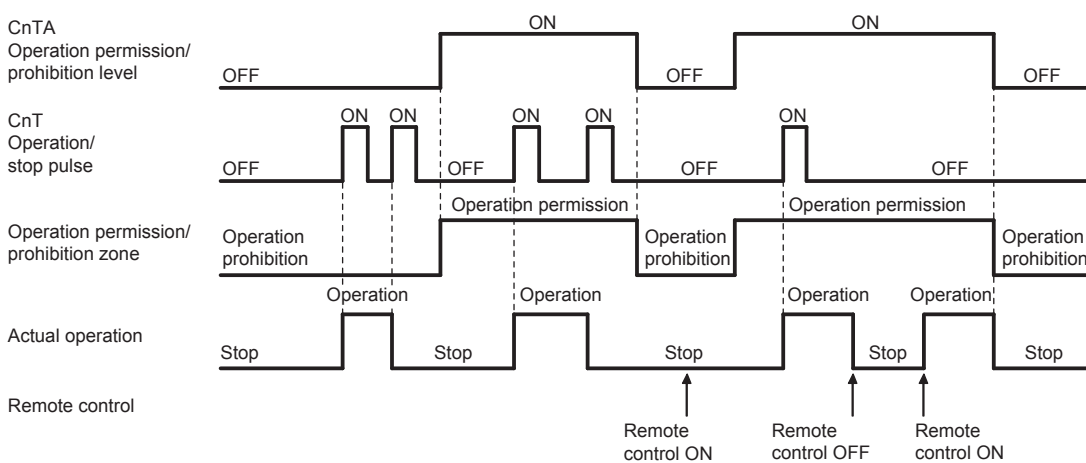

(23) Selection of cooling/heating external input function

- (a) When "External input 1 setting: Cooling/heating" is set for the indoor unit function from remote control, the cooling or heating is selected with CnT-6 or CnTA.
- (b) When the External input 1 method selection: Level input is set for the indoor unit function:
 - CnT-6 or CnTA: OPEN → Cooling operation mode
 - CnT-6 or CnTA: CLOSE → Heating operation mode
- (c) When the External input 1 method selection: Pulse input is set for the indoor unit function:

If the external input is changed OPEN → CLOSE, operation modes are inverted (Cooling → Heating or Heating → Cooling).

- (d) If the cooling/heating selection signal is given by the external input, the operation mode is transmitted to the remote control.

■ Selection of cooling/heating external input function

External input selection	External input method	Operation	
External input selection Cooling/heating selection	⑤ Level	External terminal input (CnT or CnTA)	
		Cooling/heating	
		Cooling/heating (Competitive)	
	⑥ Pulse	External terminal input (CnT or CnTA)	
		Cooling/heating	
		Cooling/heating (Competitive)	

Notes (1) Regarding the priority order for combinations of CnT and CnTA, refer to Page 316.

(24) Fan control at heating startup

- (a) Start conditions

At the start of heating operation, if the difference of setting temperature and return air temperature is 5°C or higher after the end of hot start control, this control is performed.

- (b) Contents of control

- (i) Sampling is made at each minute and, when the indoor unit heat exchanger temperature (detected with ThI-R) is 37°C or higher, present number of revolutions of indoor unit fan speed is increased by 10min⁻¹.
- (ii) If the indoor unit heat exchanger temperature drops below 37°C at next sampling, present number of revolutions of indoor unit fan speed is reduced by 10min⁻¹.

- (c) End conditions

Indoor fan speed is reduced to the setting airflow volume when the compressor OFF is established and at 30 minutes after the start of heating operation.

(25) Room temperature detection temperature compensation during heating

With the standard specification, the compressor is turned ON/OFF with the thermostat setting temperature. When the thermostat is likely to turn OFF earlier because the unit is installed at the ceiling where warm air tends to accumulate, the setting can be changed with the wired remote control indoor unit function “※ SP OFFSET”. The compressor and the heater are turned ON/OFF at one of the setting temperature +3, +2 or +1°C in order to improve the feeling of heating. The setting temperature, however, has the upper limit of 30°C.

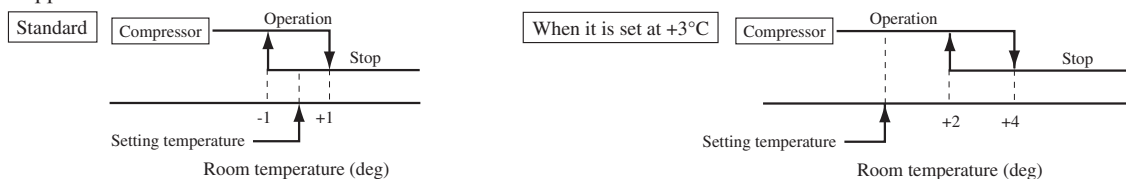

(26) Return air temperature compensation

This is the function to compensate the deviation between the detection temperature by the return air temperature thermistor and the measured temperature after installing the unit.

- (a) It is adjustable in the unit of 0.5°C with the wired remote control indoor unit function “RETURN AIR TEMP”.

- +1.0°C, +1.5°C, +2.0°C
- -1.0°C, -1.5°C, -2.0°C

- (b) Compensated temperature is transmitted to the remote control and the compressor to control them.

Note (1) The detection temperature compensation is effective on the indoor unit thermistor only.

(27) High power operation (RC-EX1A only)

It operates at with the set temp. fixed at 16°C for cooling, 30°C for heating and maximum indoor fan speed for 15 minutes maximum.

(28) Energy-saving operation (RC-EX1A only)

It operates with the setting temperature fixed at 28°C for cooling, 22°C for heating or 25°C for auto. (Maximum capacity is restricted at 80%.)

(29) Warm-up control (RC-EX1A only)

Operation will be started 5 to 60 minutes before use according to the forecast made by the microcomputer which calculates when the operation should be started in order to warm up the indoor temperature near the setting temperature at the setting time of operation start.

(30) Home leave mode (RC-EX1A only)

When the unit is not used for a long period of time, the room temperature is maintained at a moderate level, avoiding extremely hot or cool temperature.

- (a) Cooling or heating is operated according to the outdoor temperature (factory setting 35°C for cooling, 0°C for heating) and the set temp. (factory setting 33°C for cooling, 10°C for heating)
- (b) Set temp and indoor fan speed can be set by RC-EX1A.

(31) Auto temp. setting (RC-EX1A only)

Setting temperature is adjusted automatically at the adequate temperature the center set temp. is 24°C by correcting the outdoor air temperature.

(32) Fan circulator operation (RC-EX1A only)

When the fan is used for circulation, the unit is operated as follows depending on the setting with the remote control.

- (a) If the invalid is selected with the remote control, the fan is operated continuously during the fan operation. (normal fan mode)
- (b) If the valid is selected with the remote control, the fan is operated or stopped when on the difference of the remote control temperature sensor and the indoor unit return air temperature sensor becomes bigger than 3°C.

(33) The operation judgment is executed every 5 minutes (RC-EX1A only)

Setting temperature T_s is changed according to outdoor temperature
This control is valid with cooling and heating mode. (NOT auto mode)

- (a) Operate 5 minutes forcedly.
- (b) Setting temperature is adjusted every 10 minutes.
 - (i) Cooling mode.
 $T_s = \text{outdoor temperature} - \text{offset value}$
 - (ii) Heating mode.
 $T_s = \text{outdoor temperature} + \text{offset value}$
- (c) If the return air temperature lower than 18°C or return air temperature becomes lower than 25°C, unit goes thermo OFF.

(34) Auto fan speed control (RC-EX1A only)

In order to reach the room temperature to the set temperature as quickly as possible, the airflow rate is increased when the set temperature of thermostat differs largely from the return air temperature. According to temperature difference between set temperature and return air temperature, indoor fan tap are controlled automatically.

- Auto 1: Changes the indoor unit fan tap within the range of Hi ↔ Me ↔ Lo.
- Auto 2: Changes the indoor unit fan tap within the range of PHi ↔ Hi ↔ Me ↔ Lo.

(35) IU overload alarm (RC-EX1A only)

If the following condition is satisfied at 30 minutes after starting operation, RC-EX1A shows maintenance code "M07" and the signal is transmitted to the external output (CnT-5).

- (a) Receipt of the signal by the external output is indicated by lighting an LED or other prepared on site.
 - Cooling, Dry, Auto(Cooling) : Indoor air temperature = Set room temperature by remote control + Alarm temperature difference
 - Heating, Auto(Heating) : Indoor air temperature = Set room temperature by remote control - Alarm temperature difference
 Alarm temperature difference is selectable between 5 to 10°C.
- (b) If the following condition is satisfied or unit is stopped, the signal is disappeared.
 - Cooling, Dry, Auto(Cooling) : Indoor air temperature = Set room temperature + Alarm temperature difference - 2°C
 - Heating, Auto(Heating) : Indoor air temperature = Set room temperature - Alarm temperature difference + 2°C

(II) SRK series

(1) Unit ON/OFF button

If the remote control is malfunctioning, this button may be used to turn the unit on and off.

(a) Operation

Push the button once to place the unit in the automatic mode. Push it once more to turn the unit off.

(b) Details of operation

The unit will go into the automatic mode in which it automatically determines, from room temperature (as detected by sensor), whether to go into the cooling, thermal dry or heating modes.

Function	Room temperature setting	Fan speed	Swing control	Timer switch
Operation mode				
Cooling	About 24°C	Auto	Auto	Continuous
Thermal dry	About 25°C			
Heating	About 26°C			

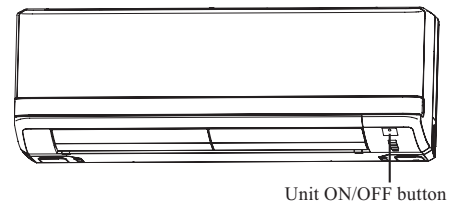

(2) Auto restart function

(a) Auto restart function records the operational status of the air-conditioner immediately prior to be switched off by a power cut, and then automatically resumes operations after the power has been restored.

(b) The following settings will be cancelled:

- Timer settings

- Notes
- (1) Auto restart function is set on when the air-conditioner is shipped from the factory. Consult with your dealer if this function needs to be switched off.
 - (2) When power failure occurs, the timer setting is cancelled. Once power is resumed, reset the timer.
 - (3) If the jumper wire (J170) "AUTO RESTART" is cut, auto restart is disabled. (See the diagram at right)

Jumper wire (J170)

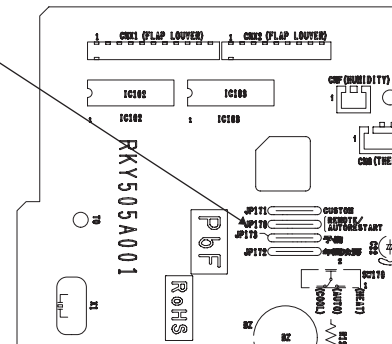

(3) Auto swing control

(a) RC-EX1A

(i) Louver control

- 1) To operate the swing louver when the air conditioner is operating, press the "Direction" button on the TOP screen of remote control. The wind direction select screen will be displayed.
- 2) To swing the louver, touch the "Auto swing" button. The lover will move up and down. To fix the swing louver at a position, touch one of [1] - [4] buttons. The swing louver will stop at the selected position.
- 3) Louver operation at the power on with a unit having the louver 4-position control function
The louver swings one time automatically (without operating the remote control) at the power on.
This allows the microcomputer recognizing and inputting the louver motor (LM) position.

(ii) Automatic louver level setting during heating

At the hot start and the heating thermostat OFF, regardless whether the auto swing switch is operated or not (auto swing or louver stop), the louver takes the level position (in order to prevent blowing of cool wind). The louver position display LCD continues to show the display which has been shown before entering this control.

(iii) Louver free stop control

If you touch the "Menu" → "Next" → "R/C settings" buttons one after another on the TOP screen of remote control, the "Flap control" screen is displayed. If the free stop is selected on this screen, the louver motor stops upon receipt of the stop signal from the remote control. If the auto swing signal is received from the remote control, the auto swing will start from the position before the stop.

(b) RC-E5**(i) Louver control**

- 1) Press the “LOUVER” button to operate the swing louver when the air conditioner is operating.
“SWING 𠄎” is displayed for 3 seconds and then the swing louver moves up and down continuously.
- 2) To fix the swing louver at a position, press one time the “LOUVER” button while the swing louver is moving so that four stop positions are displayed one after another per second.
When a desired stop position is displayed, press the “LOUVER” button again. The display stops, changes to show the “STOP 1 𠄎” for 5 seconds and then the swing louver stops.
- 3) Louver operation at the power on with a unit having the louver 4-position control function
The louver swings one time automatically (without operating the remote control) at the power on.
This allows inputting the louver motor (LM) position, which is necessary for the microcomputer to recognize the louver position.

Note (1) If you press the “LOUVER” button, the swing motion is displayed on the louver position LCD for 10 second. The display changes to the “SWING 𠄎” display 3 seconds later.

(ii) Automatic louver level setting during heating

At the hot start with the heating thermostat OFF, regardless whether the auto swing switch is operated or not (auto swing or louver stop), the louver takes the level position (In order to prevent the cold start). The louver position display LCD continues to show the display which has been shown before entering this control.

(iii) Louver-free stop control

When the louver-free stop has been selected with the indoor function of wired remote control “𠄎 POSITION”, the louver motor stops when it receives the stop signal from the remote control. If the auto swing signal is received from the remote control, the auto swing will start from the position where it was before the stop.

Note (1) When the indoor function of wired remote control “𠄎 POSITION” has been switched, switch also the remote control function “𠄎 POSITION” in the same way.

(4) Timer operation**(a) RC-EX1A****(i) Sleep timer**

Set the time from the start to stop of operation. The time can be selected in the range from 30 to 240 minutes (in the unit of 10-minute).

Note (1) Enable the “Sleep timer” setting from the remote control. If the setting is enabled, the timer operates at every time.

(ii) Set OFF timer by hour

Set the time to stop the unit after operation, in the range from 1 to 12 hours (in the unit of hour).

(iii) Set ON timer by hour

Set the time to start the unit after the stop of operation, in the range from 1 to 12 hours (in the unit of hour). It is allowed also to set simultaneously the indoor temperature, operation mode, air flow rate and warm-up enabled/disabled.

(iv) Set ON timer by clock

Set the time to start operation. The time can be set in the unit of 5-minute. This setting can be activated only once or at every time. It is allowed also to set simultaneously the indoor temperature, operation mode, air flow rate and warm-up enabled/disabled.

Note (1) It is necessary to set the clock to use this timer.

(v) Set OFF timer by clock

Set the time to stop operation. The time can be set in the unit of 5-minute. This setting can be activated only once or at every time.

Note (1) It is necessary to set the clock to use this timer.

(vi) Weekly timer

Set the ON or OFF timer for a week. Up to 8 patterns can be set for a day. The day-off setting is provided for holidays and non-business days.

Note (1) It is necessary to set the clock to use the weekly timer.

(vii) **Combination of patterns which can be set for the timer operations**

	Sleep time	Set OFF timer by hour	Set ON timer by hour	Set OFF timer by clock	Set ON timer by clock	Weekly timer
Sleep time		×	×	○	○	○
Set OFF timer by hour	×		×	×	×	×
Set ON timer by hour	×	×		×	×	×
Set OFF timer by clock	○	×	×		○	×
Set ON timer by clock	○	×	×	○		×
Weekly timer	○	×	×	×	×	

Note (1) ○: Allowed ×: Not

(b) **RC-E5**

(i) Sleep timer

Set the duration of time from the present to the time to turn off the air-conditioner.

It can be selected from 10 steps in the range from “OFF 1 hour later” to “OFF 10 hours later”. After the sleep timer setting, the remaining time is displayed with progress of time in the unit of hour.

(ii) OFF timer

Time to turn OFF the air-conditioner can be set in the unit of 10 minutes.

(iii) ON timer

Time to turn ON the air-conditioner can be set. Indoor temperature can be set simultaneously.

(iv) Weekly timer

Timer operation (ON timer, OFF timer) can be set up to 4 times a day for each weekday.

(v) Timer operations which can be set in combination

Item	Item	Timer	OFF timer	ON timer	Weekly timer
Timer			×	○	×
OFF timer	×			○	×
ON timer	○		○		×
Weekly timer	×	×	×	×	

Note (1) ○: Allowed ×: Not

(2) Since the ON timer, sleep timer and OFF timer are set in parallel, when the times to turn ON and OFF the airconditioner are duplicated, the setting of the OFF timer has priority.

(5) **Remote control display during the operation stop**

When the operation is stopped (the power supply is turned ON), it displays preferentially the “Room temperature”, “Center/Remote”, “Filter sign”, “Inspection” and “Timer operation”.

(6) **Outline of heating or cooling operation**

(a) Operation of major functional components in heating mode

	Heating		
	Thermostat ON	Thermostat OFF	Failure
Compressor	ON	OFF	OFF
Indoor fan motor	ON	ON(HOT KEEP)	OFF
Outdoor fan motor	ON	OFF	OFF
4-way valve	ON	ON	OFF (3 minutes ON)

(b) Operation of major functional components in Cooling mode

	Cooling		
	Thermostat ON	Thermostat OFF	Failure
Compressor	ON	OFF	OFF
Indoor fan motor	ON	ON	OFF
Outdoor fan motor	ON	OFF	OFF (few minutes ON)
4-way valve	OFF	OFF	OFF

(7) Indoor fan motor protection

When the air conditioner is operating and the indoor fan motor is turned ON, if the indoor fan motor has operated at 300 min⁻¹ or under for more than 30 seconds, the unit enters first in the stop mode and then stops the entire system.

(8) Serial signal transmission error protection

(a) Purpose: Prevents malfunction resulting from error on the indoor ↔ outdoor signals.

(b) Detail of operation: If the compressor is operating and a serial signal cannot be received from the indoor control with outdoor control having serial signals continues for 7 minute and 35 seconds, the compressor is stopped. After the compressor has been stopped, it will be restarted after the compressor start delay if a serial signal can be received again from the indoor control.

(9) Plural unit control – Control of 16 units group by one remote control

(a) Function

One remote control switch can control a group of multiple number of unit (Max. 16 indoor units). “Operation mode” which is set by the remote control switch can operate or stop all units in the group one after another in the order of unit No.⁽¹⁾. Thermostat and protective function of each unit function independently.

Note (1) Unit No. is set by SW1 on the interface PCB. Unit No. setting by SW1 is necessary for the interface only. In cases of the twin and triple specification, it is necessary set for the master and the slave units. This can be selected by SW3. (All are set for the master unit at the shipping from factory.)

SW1: For setting of 0 – 9, A – F
 SW3: For setting of master and slave units
 (See table shown at right.)

SW3 setting (For interface PCB)

Unit	Switch	
	SW3-1	SW3-2
Master	OFF	OFF
Slave1	OFF	ON
Slave2	ON	OFF

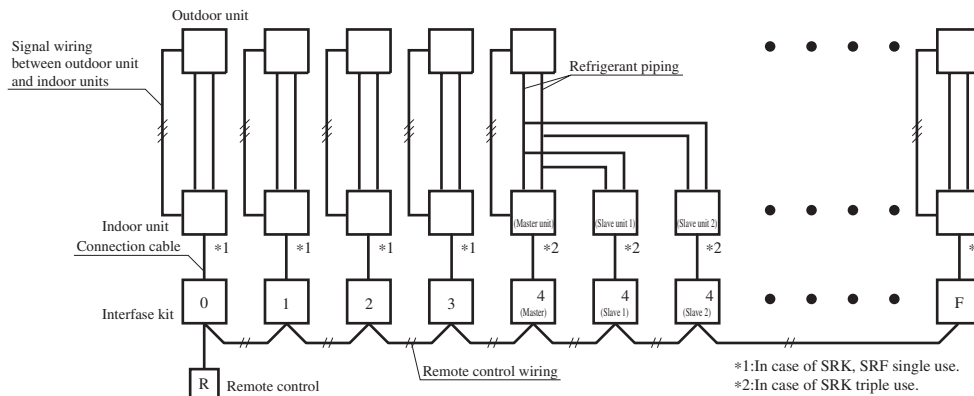

(2) Unit No. may be set at random unless duplicated, it should be better to set orderly like 0, 1, 2..., F to avoid mistake.

(b) Display to the remote control

- (i) Center or each remote control basis, heating preparation: the youngest unit No. among the operating units in the remote mode (or the center mode unless the remote mode is available) is displayed.
- (ii) Inspection display, filter sign: Any of unit that starts initially is displayed.
- (iii) Confirmation of connected units
 - 1) In case of RC-EX1A remote control
 If you touch the buttons in the order of “Menu” → “Next” → “Service & Maintenance” → “IU address” on the TOP screen of remote control, the indoor units which are connected are displayed.
 - 2) In case of RC-E5 remote control
 Pressing “AIR CON No.” button on the remote control displays the indoor unit address. If “▲” “▼” button is pressed at the next, it is displayed orderly starting from the unit of youngest No.

- (c) In case of anomaly
 - a) If any anomaly occurs on a unit in a group (a protective function operates), that unit stops with the anomalous stop but any other normal units continue to run as they are.
 - b) Signal wiring procedure
Signal wiring between indoor and outdoor units should be made on each unit same as the normal wiring. For the group control, lay connect with sires wiring between rooms using terminal blocks (X, Y) of interface kit. Connect the remote control communication wire separately from the power supply wire or wires of other electric devices (AC220V or higher).

(10) Filter sign

As the operation time (Total ON time of ON/OFF switch) accumulates to 180 hours (1), “Filter cleaning” is displayed on the remote control. (This is displayed when the unit is in trouble and under the centralized control, regardless of ON/OFF)

Note (1)Time setting for the filter sign can be made as shown below using the indoor function of wired remote control “FILTER SIGN SET”. (It is set at 1 at the shipping from factory.)

Filter sign setting	Function
Setting 1	Setting time: 180 hrs (Factory default)
Setting 2	Setting time: 600 hrs
Setting 3	Setting time: 1,000 hrs
Setting 4	Setting time: 1,000 hrs (Unit stop) ⁽²⁾

(2) After the setting time has elapsed, the “FILTER CLEANING” is displayed and, after operating for 24 hours further (counted also during the stop), the unit stops.

(11) Outline of automatic operation

(a) Determination of operation mode

The unit checks the indoor air temperature and the outdoor air temperature, determines the operation mode, and then begins in the automatic operation.

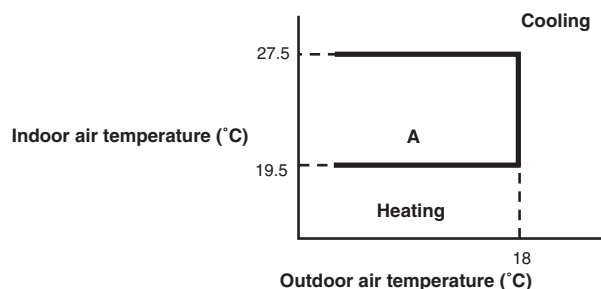

- (b) The unit checks the temperature every hour after the start of operation and, if the result of check is not same as the previous operation mode, changes the operation mode.
 - (i) If the setting temperature is changed with the remote control, the operation mode is judged immediately.
 - (ii) When both the indoor and the outdoor air temperatures are in the range "A", cooling or heating is switched depending on the difference between the setting temperature and the indoor air temperature.
 - (iii) When the operation mode has been judged following the change of setting temperature with the remote control, the hourly judgment of operation mode is cancelled.
- (c) When the unit is started again within one hour after the stop of automatic operation or when the automatic operation is selected during heating or cooling operation, the unit is operated in the previous operation mode.

(12) Frost prevention control

- (a) Operating conditions
 - (i) More than 8 minutes after starting the compressor.
 - (ii) Indoor heat exchanger temperature (detected with Th2) is lower than 2.5 °C .
- (b) Contents of frosting operation

	During this control	Reset
Compressor ON/OFF command	Forced stop	Operation command
Indoor fan motor	Depending on the airflow setting with the remote controller	

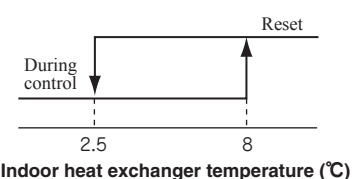

- (c) Resetting condition: Indoor heat exchanger temperature (Th2) is higher than 8 °C .

(13) Dew prevention control II [Cooling]: Prevents dewing on the indoor unit.

- (a) Operating conditions:** When the following conditions have been met for more than 30 minutes after starting operation
 - (i) Compressor's command speed is 28 rps or higher.
 - (ii) Detected value of humidity is 68% or higher.
- (b) Contents of operation**
 - (i) Air capacity control

Item		Model
		SRK50, 60
LO	Upper limit of compressor's command speed	RangeA: 50rps, RangeB: 30rps
	Indoor fan	5th speed
AUTO,HI,MED	Upper limit of compressor's command speed	RangeA: 50rps, RangeB: 30rps
	Indoor fan	Adaptable to compressor's command speed (5th to 9th speed)

Note (1) Ranges A and B are as shown below.

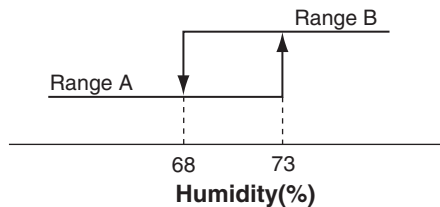

- (ii) When this control has continued for more than 30 minutes continuously, the following wind direction control is performed.
 - 1) When the vertical wind direction is set at other than the vertical swing, the flaps change to the horizontal position.

- (c) Resetting condition:** When any of followings is met
 - (i) Compressor's command speed is less than 28 rps.
 - (ii) Detected value of humidity is less than 63%.

(14) Outline of dry (dehumidifying) operation

(a) Purpose of DRY mode

The purpose is "Dehumidification", and not to control the humidity to the target condition. Indoor/outdoor unit control the operation condition to reduce the humidity, and also prevent over cooling.

(b) Outline of control

- (i) Indoor unit fan speed and compressor are controlled by the area which is selected by the temp. difference

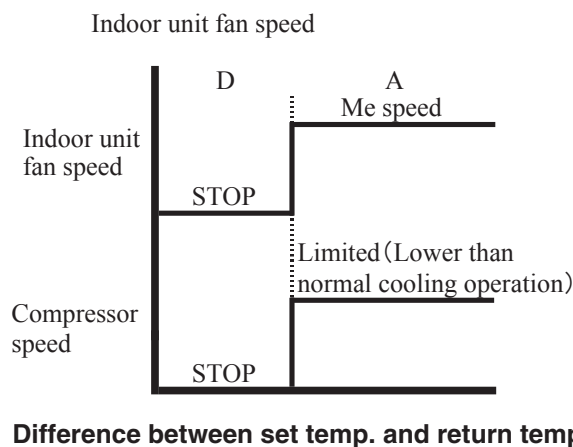

- (ii) The indoor unit check the current area by every 5 minutes, and operate by the next checking.

1.11.4 Operation control function by the outdoor control

(1) Determination of compressor speed (frequency)

Required frequency

(a) Cooling/dehumidifying operation Unit: rps

Model		100	125	140	200	250
Max. required frequency	Usual operation	90	105 (92)	105 (92)	100	120
	Silent mode, outdoor temperature $\leq 15^{\circ}\text{C}$	60	80	85	70	80
Min. required frequency		20	20	20	30	30

Note (1) Value in () are for the 3 phase models.

(b) Heating operation Unit: rps

Model		100	125	140	200	250
Max. required frequency	Usual operation	90	105 (120)	110 (120)	100	120
	Silent mode	60	80	85	70	80
Min. required frequency		20	20	20	30	30

Note (1) Value in () are for the 3 phase models.

(c) If the indoor unit fan speed becomes “Me” or “Lo”, Max required frequency goes down accordingly depending on indoor unit model.

(d) Max. required frequency under high outdoor air temperature in cooling mode
Maximum required frequency is selected according to the outdoor air temperature (Tho-A).

Unit: rps

Model		100	125	140	200	250
Max. required frequency	Outdoor air temperature is 40°C or higher	75	90	96	75	98
	Outdoor air temperature is 46°C or higher	75	75	75	66	66

(e) Max. required frequency under outdoor air temperature in heating mode
Maximum required frequency is selected according to the outdoor air temperature (Tho-A).

Unit: rps

Model		100	125	140	200	250
Max. required frequency	Outdoor air temperature is 18°C or higher	60	80	85	70	80

(f) Selection of max. required frequency by heat exchanger temperature

- (i) Maximum required frequency is selected according to the outdoor unit heat exchanger temperature (Tho-R) during cooling/dehumidifying or according to the indoor unit heat exchanger temperature (ThI-R) during heating mode.
- (ii) When there are 3 indoor unit heat exchanger temperatures (ThI-R), whichever the highest applies,

Unit: rps

Model			100	125	140	200	250
Max. required frequency	Cooling/dehumidifying	Outdoor unit heat exchanger temperature is 56°C or higher	90	100 (92)	100 (92)	100	120
	Heating	Indoor unit heat exchanger temperature is 56°C or higher	90	100	100	100	120

Note (1) Value in () are for the 3 phase models.

(g) When any of the controls from (a) to (f) above may duplicate, whichever the smallest value among duplicated controls is taken as the maximum required frequency.

(h) During heating, it is operated with the maximum required frequency until the indoor unit heat exchanger temperature becomes 40°C or higher.

(2) Compressor start control

(a) Compressor starts upon receipt of the thermostat ON signal from the indoor unit.

(b) However, at initial start after turning the power supply breaker, it may enter the standby state for maximum 30 minutes (“ PREPARATION” is displayed on the remote control) in order to prevent the oil loss in the compressor.

If the cooling/dehumidifying/heating operation is selected from the remote control when the outdoor unit is in the standby state, “ PREPARATION” is displayed for 3 seconds on the remote control.

(3) Compressor soft start control

(a) Compressor protection start I

[Control condition] Normally, the compressor operation frequency is raised in this start pattern.

[Control contents] (i) Starts with the compressor's target frequency at **A** rps.

However, when the ambient air temperature (Tho-A) is 35°C or higher during cooling/dehumidifying or the indoor return air temperature (ThI-A) is 25°C or higher during heating, it starts at **C** rps.

(ii) At 30 seconds after the start of compressor, its target frequency changes to **B** rps and the compressor is operated for 2 - 4 minutes with its operation frequency fixed at **B** rps.

Model	Operation mode	A rps	B rps	C rps
100-140	Cooling/Dehumidifying	55	55	30
	Heating	55	55	30
200, 250	Cooling/Dehumidifying	55	55	30
	Heating	55	55	30

(b) Compressor protection start III

[Control condition] Number of compressor starts is only 1 counted after the power supply breaker ON.

[Control contents] Operates by selecting one of following start patterns according to the operation mode and the outdoor air temperature (Tho-A).

(i) Low frequency operation control during cooling/dehumidifying

[Control condition] Upon establishing the conditions of compressor protection start III, the low frequency operation control is performed during cooling/dehumidifying.

[Control contents] ① Starts with the compressor's target frequency at **A** rps. When the outdoor air temperature (Tho-A) is 35°C or higher, it starts at **C** rps.

② At 30 seconds after the compressor start, the compressor's target frequency is changed to **B** rps and the compressor's operation frequency is fixed for 10 minutes.

Model	Operation mode	A rps	B rps	C rps
100-140	Cooling/Dehumidifying	55	55	30
200, 250	Cooling/Dehumidifying	55	30	30

(ii) Low frequency operation control during heating

[Control condition] When the conditions of compressor protection start III are established and one of following conditions ① and ② is satisfied, the low number of revolutions operation control is performed during heating.

① At 30 minutes or more after turning the power supply breaker on

② Compressor underneath temperature (Tho-H) is 4°C or higher and the difference from the outdoor air temperature (Tho-A) becomes 4°C or higher. [model 200, 250 only]

[Control contents] ① Starts the compressor with its target frequency at **A** rps. However, when the indoor unit return air temperature (ThI-A) is 25°C or higher, it start at **C** rps.

② At 30 seconds after the start of compressor, the compressor's target frequency is changed to **B** rps and the compressor's operation frequency is fixed for 10 minutes.

Model	Operation mode	A rps	B rps	C rps
100-140	Heating	55	55	30
200, 250	Heating	55	30	30

(4) Outdoor unit fan control

(a) Outdoor unit fan tap and fan motor speed

Unit: min⁻¹

Model	Mode	Fan motor tap						
		① speed	② speed	③ speed	④ speed	⑤ speed	⑥ speed	⑦ speed
100-140	Cooling/Dehumidifying	200	350	600	740	820	870	910 (950) ⁽²⁾
	Heating	200	350	600	740	820	870	910 (950) ⁽²⁾
200, 250	Cooling/Dehumidifying	200	370	560 (600) ⁽³⁾	820	850	910	950
	Heating	200	370	560 (600) ⁽³⁾	820	850	910	950

Notes (1) Fan motor speed for model 200 and 250 are same for both top and bottom lines
 (2) Value in () are for the model 125, 140.
 (3) Value in () are for the model 250.

(b) Fan tap control during Cooling/Defumidifying operation

Fan taps are selected depending on the outdoor unit heat exchanger temperature (Tho-R1, R2) and the outdoor air temperature (Tho-A).
 Note (1) It is detected by Tho-R1 or R2, whichever the higher.

	(A) zone	(B) zone	(C) zone	(D) zone
(a) zone	Tap 5	Tap 5	Tap 5	Tap 4
(b) zone	Tap 5	Tap 5	Tap 4 ⁽¹⁾	Tap 3
(c) zone	Tap 4	Tap 4 ⁽¹⁾	Tap 3	Tap 2
(d) zone	Tap 3	Tap 3	Tap 2	Tap 1

Note (1) If the “silent mode start” signal is received from the remote control, the speed changes from Tap 4 to Tap 3.

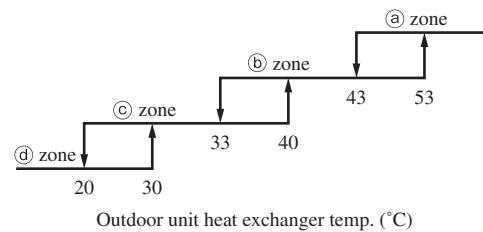
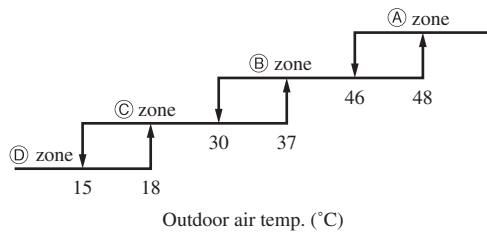

(c) Fan tap control during heating operation

Fan taps are selected depending on the outdoor unit heat exchanger temperature (Tho-R1, R2) and the outdoor air temperature (Tho-A).
 Note (1) It is detected by Tho-R1 or R2, whichever the lower.

	(A) zone	(B) zone	(C) zone
(a) zone	Tap 3	Tap 3	Tap 4
(b) zone	Tap 3	Tap 4 ⁽¹⁾	Tap 5
(c) zone	Tap 4	Tap 5	Tap 6

Note (1) If the “silent mode start” signal is received from the remote control, the speed changes from Tap 4 to Tap 3.

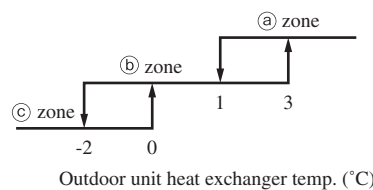
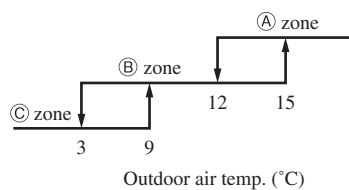

(d) Outdoor unit fan control at cooling low outdoor air

(i) When all the following conditions are established after the start of compressor, the following control is implemented.
 If the outdoor air temperature (Tho-A) is in the zone (B) in the cooling/dehumidifying mode, it has elapsed 20 seconds from the start of outdoor unit fan and the outdoor unit fan is at the tap 1 speed, the outdoor unit fan speed is controlled according to the outdoor unit heat exchanger temperature (Tho-R1, R2).

Note (1) It is detected with Tho-R1 or R2, whichever the higher.

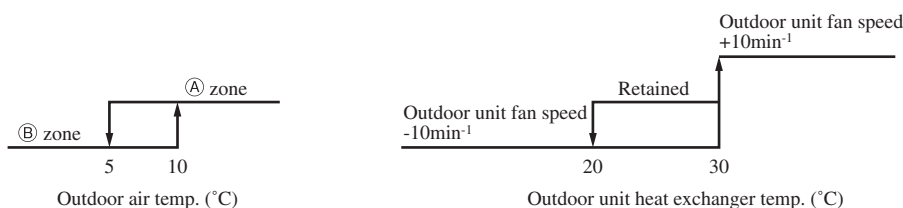

- (ii) The outdoor unit heat exchanger temperature is detected always and, when the number of revolutions of the outdoor fan speed has been increased or decreased, there is no change of fan speed for 20 seconds.
- (iii) Range of the outdoor unit fan speed under this control is as follows.
 - 1) Lower limit: 130min⁻¹
 - 2) Upper limit: 500min⁻¹
- (iv) As any of the following conditions is established, this control terminates.
 - 1) When the outdoor air temperature is in the zone ① and the outdoor unit heat exchanger temperature at 30°C or higher is established for 40 seconds or more continuously.
 - 2) When the outdoor fan speed is 500min⁻¹ and the outdoor unit heat exchanger temperature at 30°C or higher is established for 40 seconds or more continuously.
 - 3) When the outdoor unit heat changer temperature at 45°C or higher is established for 40 seconds or more.

(e) Outdoor unit fan control by the power transistor radiator fin temperature

When all the following conditions are established later than 3 minutes after the start of compressor, the following control is implemented.

- (i) Cooling/dehumidifying
 - 1) Outdoor air temperature $Tho-A \geq 33^{\circ}C$
 - 2) Compressor’s actual frequency $\geq A$ rps
 - 3) Power transistor radiator fin temperature $\geq C$ °C
- (ii) Heating
 - 1) Outdoor air temperature $Tho-A \geq 16^{\circ}C$
 - 2) Compressor’s actual frequency $\geq B$ rps
 - 3) Power transistor radiator fin temperature $\geq C$ °C
- (iii) Control contents
 - 1) Raises the outdoor unit fan tap by 1 tap.
 - 2) When the sampling is for 60 minutes and the value of power transistor radiator fin temperature (Tho-P) is as follows.
 - a) When the power transistor radiator fin temperature (Tho-P) $\geq C$ °C, the outdoor unit fan tap is raised by 1 speed further.
 - b) When C °C > power transistor radiator fin temperature (Tho-P) $\geq D$ °C, present outdoor unit fan tap is maintained.
 - c) When the power transistor radiator fin temperature (Tho-P) $\geq D$ °C, the outdoor unit fan tap is dropped by 1 speed.
- (iv) Ending conditions

When the operation under the condition of item (iii), c) above and with the outdoor unit fan tap, which is determined by the item (c) is detected 2 times consecutively.

- Compressor’s frequency and power transistor radiator fin temperature

Item	A	B	C	D
Model 100-140	85	85	72	68
200, 250	70	70	80	75

(f) Caution at the outdoor unit fan start control (3 phase models only)

When the outdoor unit fan is running at 400min⁻¹ before operating the compressor, it may operate with the compressor only, without starting up the outdoor fan This is normal.

(g) Snow protection fan control

If the dip switch (SW3-2) on the outdoor unit control PCB is turned ON, the outdoor unit fan is operated for 30 seconds at 4 tap speed once in every 10 minutes depending on the outdoor air temperature (detected with Tho-A) in the stop mode or anomalous stop mode.

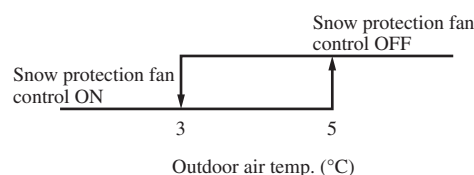

(5) Defrosting

(a) Defrosting start conditions

If all of the following defrosting conditions A or conditions B are met, the defrosting operation starts.

(i) Defrosting conditions A

- 1) Cumulative compressor operation time after the end of defrosting has elapsed 37 minutes, and the cumulative compressor operation time after the start of heating operation (remote control ON) has elapsed 30 minutes.
- 2) After 5 minutes from the compressor ON
- 3) After 5 minutes from the start of outdoor unit fan
- 4) After satisfying all above conditions, if temperatures of the outdoor unit heat exchanger temperature thermistor (Tho-R1, R2) and the outdoor air temperature thermistor (Tho-A) become lower than the defrosting start temperature as shown by the right figure for 15 seconds continuously, or the suction gas saturation temperature (SST) and the outdoor air temperature (Tho-A), which are obtained from the value detected by the low pressure sensor (LPT) stay for 3 minutes within the range below the defrosting operation start temperature as shown by the right figure. However, it excludes for 10 minutes after the start of compressor and the outdoor air temperature is as shown by the lower figure.

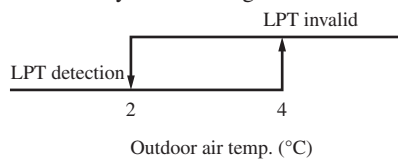

(ii) Defrosting conditions B

- 1) When previous defrosting end condition is the time out of defrosting operation and it is in the heating operation after the cumulative compressor operation time after the end of defrosting has become 30 minutes.
- 2) After 5 minutes from the start of compressor
- 3) After 5 minutes from the start of outdoor unit fan

(b) Defrosting end conditions

When any of the following conditions is satisfied, the defrosting end operation starts.

- (i) When it has elapsed 8 minutes and 20 seconds after the start of defrosting. (After 10 minutes and 20 seconds for model, 200 and 250)
- (ii) When the outdoor unit heat exchanger temperatures (Tho-R1, R2), whichever the lower, becomes 12°C or higher for 10 seconds continuously.

(c) Switching of defrosting control with SW3-1

- (i) If SW3-1 on the outdoor unit control PCB is turned to ON, it becomes easier to enter the defrosting operation. Use this when installing a unit at snowing regions.
- (ii) Control contents
 - 1) It allows entering the defrosting operation under the defrosting condition A when the cumulative heating operation time becomes 30 minutes. It is 37 minutes at SW3-1 OFF (Factory default).
 - 2) It allows entering the defrosting operation under the defrosting condition B when the cumulative heating operation time becomes 25 minutes. It is 30 minutes at SW3-1 OFF (Factory default).
 - 3) It allows the defrosting operation with the outdoor unit heat exchanger temperature (Tho-R) and suction pressure saturation temperature (SST) being higher than normal.

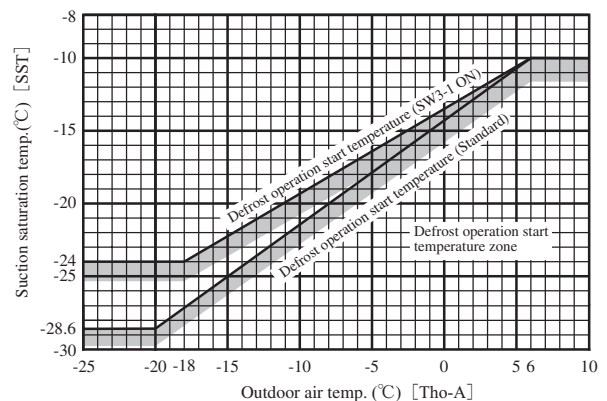
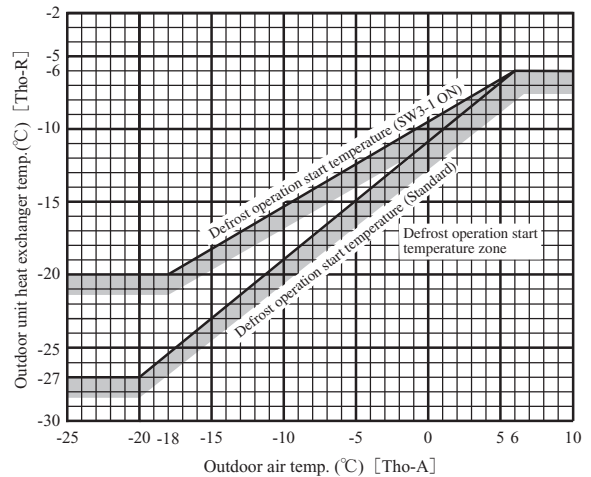

(6) Protective control/anomalous stop control by compressor's number of revolutions

(a) Compressor discharge pipe temperature protection

(i) Protective control

As the discharge pipe temperature (detected with Tho-D) exceeds the setting value, the compressor speed (frequency) is controlled to suppress the rise of discharge pipe temperature.

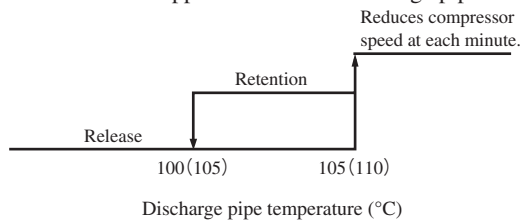

Note (1) Value in () are for the model 200, 250.

(ii) Anomalous stop control

- 1) If the discharge pipe temperature (detected with Tho-D) exceeds the setting value, the compressor stops.
- 2) When it is detected 2 times within 60 minutes or after continuous 60 minutes, including the stop of compressor, E36 is displayed on the remote controller and it enters the anomalous stop mode.

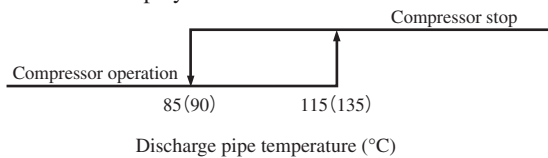

Note (1) Value in () are for the model 200, 250.

(iii) Reset of anomalous stop mode

As it drops to the reset value of 85°C (90°C) or lower for 45 minutes continuously, it becomes possible to restart from the remote control.

Note (1) Value in () is for the model 200, 250.

(b) Cooling high pressure protection

(i) Protective control

- 1) When the outdoor air temperature (Tho-A) is 40°C or higher and the outdoor unit heat exchanger temperature (Tho-R) exceeds the setting value, the compressor speed (frequency) is controlled to suppress the rise of high pressure.
- 2) Control value A is updated to an optimum value automatically according to the operating conditions.

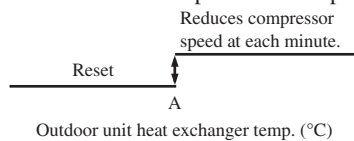

Control value A	
54-60°C	

(ii) Anomalous stop control

- 1) As the outdoor unit heat exchanger temperature (Tho-R) exceeds the setting value, the compressor stops.
- 2) If it is detected 5 times within 60 minutes or 65°C or higher continues for 60 minutes, including the stop of compressor, E35 is displayed on the remote control and it enters the anomalous stop mode.

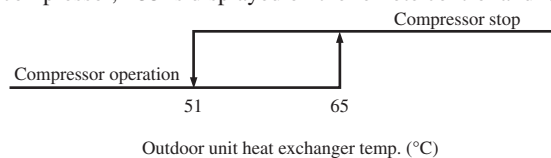

(iii) Reset of anomalous stop mode

As it reaches the reset value of 51°C or lower, it becomes possible to restart from the remote control.

(c) Heating high pressure protection

(i) Protective control

- 1) As the indoor unit heat exchanger temperature (ThI-R) exceeds the setting value, the compressor speed (frequency) is controlled to suppress the rise of high pressure.
- 2) Control value A is updated to an optimum value automatically according to the operating conditions.

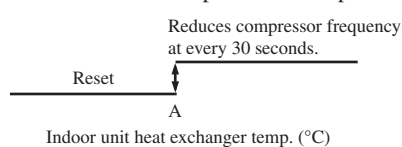

Model	Existing piping adaptation switch: SW5-1	
	OFF (Shipping)	ON
Control value A (°C)		
100-140	48-54	46-52
200, 250	52-58	

Note (1) Adaptation to existing piping is at ON.

(ii) Anomalous stop control

Operation control function by the indoor unit control - See the heating overload protection, page 314.

(iii) Adaptation to existing piping, stop control

If the existing piping adaptation switch, SW5-1, is turned ON, the compressor stops to protect existing piping when the indoor unit heat exchanger temperature (ThI-R) exceeds the setting value.

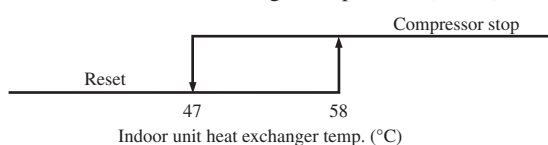

(d) Anomaly detection control by the high pressure switch (63H1)

- (i) If the pressure rises and operates the high pressure switch (opens at 4.15MPa/closes at 3.15MPa), the compressor stops.
- (ii) Under any of the following conditions, E40 is displayed and it enters the anomalous stop mode.
 - 1) When it occurs 5 times within 60 minutes that pressure rises and the compressor is stopped by 63H1.
 - 2) When 63H1 has been in the open state for 60 minutes continuously, including the stop of compressor.

(e) Low pressure control

- (i) Protective control
If the value detected by the low pressure sensor (LPT) exceeds the setting value, the compressor speed (frequency) is controlled to restrain the drop of pressure.

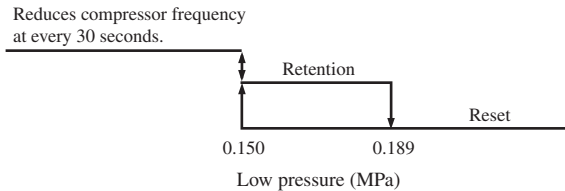

- (ii) Anomalous stop control
 - 1) When a value detected by the low pressure sensor (LPT) satisfies any of the following conditions, the compressor stops to run for its protection.
 - a) When the low pressure drops to 0.079MPa or under for 15 seconds continuously.
 - b) At 10 minutes after the start of compressor, the suction overheat becomes 30°C and the low pressure becomes 0.15MPa or under for 60 seconds continuously.
 - 2) E49 is displayed under any of the following conditions and it enters the anomalous stop mode.
 - a) When the low pressure drops 3 times within 60 minutes and the compressor stops under any of the above conditions.
 - b) When a value detected with the low pressure sensor becomes 0.079MPa or under for 5 minutes, including the stop of compressor.
 - 3) However, when the control condition of item 2), a) is established during the compressor protection start III, E49 is displayed at initial stop and it enters the anomalous stop mode.

(f) Compressor pressure ratio protection control

- (i) During heating operation, if the indoor unit heat exchanger temperature (ThI-R) and the low pressure sensor (LPT) exceed the setting values at 10 minutes after the start of compressor, the compressor speed (frequency) is controlled to protect the compressor.
- (ii) This control is not performed during the outdoor fan ON and for 10 minutes from the start of outdoor unit fan.
- (iii) This control is not performed during defrosting operation and at 10 minutes after the reset of defrosting operation.
- (iv) When there are 3 indoor unit heat exchanger temperatures (ThI-R), the highest temperature is detected.

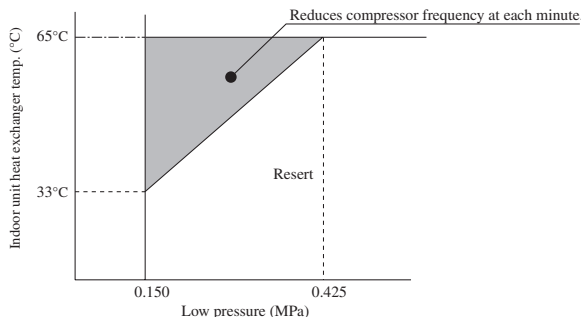

(g) Over-current protection current safe controls I, II

Detecting the outdoor unit inverter input (primary) current and the output (secondary) current, if the current values exceed setting values, the compressor speed (frequency) is controlled to protect the inverter.

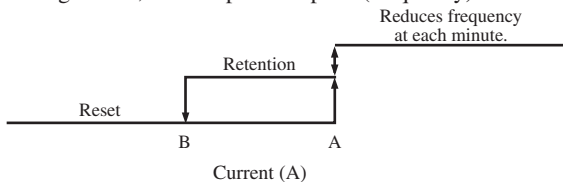

(Fig. C) The control value "A" and the reset value vary depending on the compressor speed.

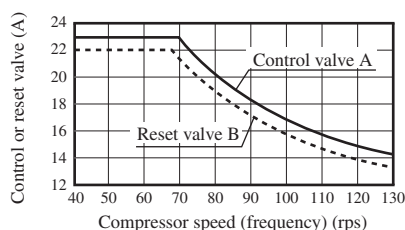

Model	Cooling		Heating		
	Control value A	Reset value B	Control value A	Reset value B	
Primary current side	100	13.5 (23.0)	12.5 (22.0)	13.5 (23.0)	12.5 (22.0)
	125, 140	13.5 (23.0)	12.5 (22.0)	13.5 (23.0)	12.5 (22.0)
	200	17.0	16.0	17.0	16.0
	250	20.0	19.0	20.0	19.0
Secondary current side	100	13.0 (Fig.C)	12.0 (Fig.C)	13.0 (Fig.C)	12.0 (Fig.C)
	125, 140	13.0 (Fig.C)	12.0 (Fig.C)	13.0 (Fig.C)	12.0 (Fig.C)
	200	Not implemented			
	250	Not implemented			

Note (1) Value in () are for the single phase models.

(h) Power transistor temperature protection

(i) Protective control (single phase model only)

If the power transistor temperature (detected with TIP) exceeds the setting value, the compressor speed (frequency) is controlled to suppress the rise of power transistor temperature.

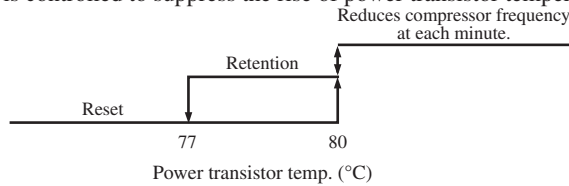

(ii) Anomalous stop control (model 200, 250 only)

- 1) If the power transistor temperature rises further, the protective switch in the power transistor operates to protect the compressor and the power transistor.
- 2) Under any of the following condition, E41 is displayed and it enters the anomalous stop mode.
 - a) When the protective switch in the power transistor operates 5 times within 60 minutes and the compressor stops.

(i) Anomalous power transistor current

- (i) Prevents over-current on the inverter. If the current value in the power transistor exceeds the setting value, the compressor stops.
- (ii) If the current value in the power transistor exceeds the specified value and the compressor stops 4 times within 30 minutes, E42 is displayed on the remote controller and it enters the anomalous stop mode.

(j) Anomalous inverter PCB

If the power transistor detects any anomaly for 15 minutes, including the stop of compressor, E51 is displayed on the remote controller and it enters the anomalous stop mode.

(k) Anti-frost control by the compressor frequency control

- (i) If the indoor unit heat exchanger temperature (detected with ThI-R) exceeds the setting value at 4 minutes after the start of compressor, the compressor speed (frequency) is controlled to initiate the anti-frost control of indoor unit heat exchanger.
- (ii) When there are 2 indoor unit heat exchanger temperatures (ThI-R), the lowest temperature is detected.

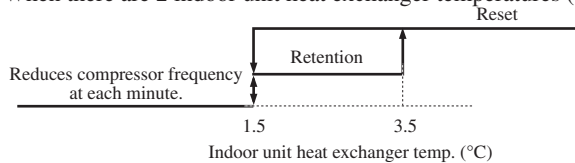

(iii) Regarding the anti-frost control by the operation stop, refer to the operation control function by the indoor unit controller and the cooling, dehumidifying frost prevention of page 314.

(l) Dewing prevention control

[Control condition] During cooling and dehumidifying operation, if all the following conditions are established, the compressor speed (frequency) is reduced to prevent dewing and water splash.

- ① Cooling electronic expansion valve aperture (EEVC) is 500 pulses.
- ② Suction overheat is 10°C or higher.
- ③ Compressor speed (frequency) is 60 rps or higher.

[Control contents] ① When the suction overheat is 10°C or higher, the compressor speed (frequency) is reduced at each 1 minute.

② Compressor speed (frequency) does not rise till the cooling expansion valve becomes 460 pulses.

③ This control takes 60 rps as its lower limit so that compressor speed is not controlled when it is less than 60 rps.

(m) Refrigerant quantity shortage protection

Under the compressor protection start III control during cooling and dehumidifying operations, the following control is performed by detecting the indoor unit heat exchanger temperature (ThI-R) and the indoor unit return air temperature (ThI-A).

[Control condition] When the state that the indoor unit heat exchanger temperature (ThI-R) does not become lower than the indoor unit return air temperature (ThI-A) by 4°C or more continues for 1 minute.

[Control contents] It judges that the flowing of refrigerant in to the indoor unit is insufficient so that the compressor is stopped and E57 is displayed on the remote control.

(n) Broken wire detection on temperature thermistor and low pressure sensor

- (i) Outdoor unit heat exchanger thermistor, outdoor air thermistor and low pressure sensor
 If the following is detected for 5 second continuously within 2 minutes to 2 minutes and 20 seconds after the compressor ON, the compressor stops. After a delay of 3 minutes, it restarts but, if the same is detected repeatedly 3 times within 40 minutes, the compressor stops with the anomalous stop.
 Note (1) During defrosting and for 3 minutes after the end of defrosting, it is not detected.
 - Outdoor unit heat exchanger thermistor: -50°C or lower
 - Outdoor air temperature thermistor: -45 or lower
 - Low pressure sensor: 0V or under or 4.0V or over
- (ii) Discharge pipe temperature thermistor, suction pipe temperature thermistor and underneath temperature thermistor (model 200, 250 only)
 If the following is detected for 5 second continuously within 10 minutes to 10 minutes and 20 seconds after the compressor ON, the compressor stops. After a delay of 3 minutes, it restarts but, if the same is detected repeatedly 3 times within 40 minutes, the compressor stops with the anomalous stop.
 Note (1) During defrosting and for 3 minutes after the end of defrosting, it is not detected.
 - Discharge pipe temperature thermistor: -10°C or lower
 - Suction pipe temperature thermistor: -50 or lower
 - Underneath temperature thermistor: -50°C or lower

(o) Fan motor error

- (i) If the fan speed of 100min⁻¹ or under is detected for 30 second continuously under the outdoor unit fan control (with the operation command of fan tap at ① speed or higher), the compressor stops.
- (ii) When the fan motor speed drops to 100min⁻¹ or under 5 times within 60 minutes and the compressor stops, it enters the anomalous stop mode with E48 displayed on the remote control.

(p) Anomalous stop by the compressor start stop

- (i) When it fails to shift to the compressor DC motor's rotor position defection operation at 5 seconds after establishing the compressor start condition, the compressor stops temporarily and restarts 3 minutes later.
- (ii) If it fails to shift to the position detection operation again at second time, it judges the anomalous compressor start and stops the compressor by the anomalous stop (E59).

(q) Anomalous compressor rotor lock (model 200, 250 only)

After shifting to the compressor rotor's position detection operation, if fails again to detect the rotor position, the compressor stops.
 Compressor restarts 3 minutes later but, if it is operated 4 times within 15 minutes, the anomalous stop (E60) occurs.

(7) Silent mode

- (a) As "Silent mode start" signal is received from the remote controller, it operates by dropping the outdoor unit fan tap and the compressor speed (frequency).
- (b) For details, refer to items (1) and (4) above.

(8) Test run

(a) It is possible to operate from the outdoor unit using the dip switch on the outdoor unit control PCB.

SW3-3	ON	SW3-4	OFF	Cooling test run
			ON	Heating test run
	OFF	Normal and end of test run		

Make sure to turn SW3-3 to OFF after the end of operation.

(b) Test run control

- (i) Operation is performed at the maximum compressor speed (frequency), which is determined for each model.
- (ii) Each protective control and error detection control are effective.
- (iii) If SW3-4 is switched during test run, the compressor is stoped for once by the stop control and the cooling/heating operation is switched.
- (iv) Setting and display of remote control during test run

Mode	Item	Contents of remote controller setting/display
Cooling test run		Setting temperature of cooling is 5°C.
Heating test run		Setting temperature of heating (preparation) is 30°C.

(9) Pump-down control

Turning ON the pump-down switch SW1 for 2 seconds during the operation stop or anomalous stop (excluding the thermostat OFF), the pump-down operation is performed. (This is invalid when the indoor unit is operating. This is effective even when the indoor unit is stopped by the anomalous stop or the power supply is turned OFF.)

(a) Control contents

- (i) Close the service valve at the liquid side. (It is left open at the gas side.)
- (ii) Compressor is started with the target speed (frequency) at 55 rps in the cooling mode.
- (iii) Red and green lamps (LED) keeps flashing continuously on the outdoor unit control PCB.
- (iv) Each of protection and error detection controls, excluding the low pressure control, anti-frost control and dewing prevention control, is effective.
- (v) Outdoor unit fan is controlled as usual.
- (vi) Electronic expansion valve is fully opened.

(b) Control ending conditions

Stop control is initiated depending on any of the following conditions.

- (i) Low pressure of 0.087MPa or lower is detected for 5 seconds continuously.
 - 1) Red LED: Light, Green LED: Flashing, Remote control: Displays stop.
 - 2) It is possible to restart when the low pressure is 0.087MPa or higher.
 - 3) Electronic expansion valve (cooling/heating) is kept fully open.
- (ii) Stop by the error detection control
 - 1) Red LED: Keeps flashing, Green LED: Flashing
 - 2) Restart is prohibited. To return to normal operation, reset the power supply.
 - 3) Electronic expansion valve (cooling/heating) is left fully open.
- (iii) When the cumulative operation time of compressor under the pump-down control becomes 5 minutes.
 - 1) Red LED: Stays OFF, Green LED: Flashing, Remote control: Stop
 - 2) It is possible to pump-down again.
 - 3) Electronic expansion valve (cooling/heating) is left fully open.

Note (1) After the stop of compressor, close the service valve at the gas side.

Caution: Since pressing the pump-down switch cancels communications with the indoor unit, the indoor unit and the remote control display “Transmission error – E5”. This is normal.

(10) Base heater ON/OFF output control (option)

(a) Base heater ON conditions

When all of following conditions are met, the base heater is turned ON.

- (i) Outdoor air temperature (detected with Tho-A) is 3°C or lower.
- (ii) In the heating mode
- (iii) When the compressor is turned ON

(b) Base heater OFF conditions

When either one of following conditions is met, the base heater is turned OFF.

- (i) Outdoor air temperature (detected with Tho-A) is 5°C or higher.
- (ii) When the compressor stop has been detected for 30 minutes continuously
- (iii) In the cooling or dehumidifying mode

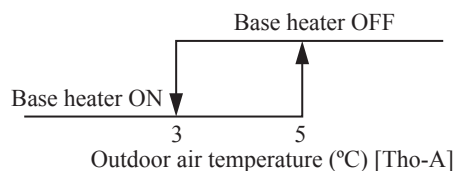

1.12 MAINTENANCE DATA

1.12.1 Diagnosing of microcomputer circuit

(1) Selfdiagnosis function

(a) Check Indicator Table

Whether a failure exists or not on the indoor unit and outdoor unit can be know by the contents of remote control error code, indoor/outdoor unit green LED (power pilot lamp and microcomputer normality pilot lamp) or red LED (check pilot lamp).

Note (1) SRK series only.

At the indoor unit side, errors are displayed with the combination of RUN light and TIMER light on the display panel.

(i) Indoor unit

1) FDT, FDTC, FDEN, FDU, FDUM, FDF series

Remote control		Indoor control PCB		Outdoor control PCB		Location of trouble	Description of trouble	Repair method	Reference page
Error code	Red LED	Red LED	Green LED (1)	Red LED	Green LED (1)				
No-indication	Stays OFF	Stays OFF	Keeps flashing	Stays OFF	Keeps flashing	—	• Normal operation	—	—
		Stays OFF	Stays OFF	2-time flash	Stays OFF	Indoor unit power supply	• Power OFF, broken wire/blown fuse, broken transformer wire	Repair	382
		* 3-time flash	Keeps flashing	Stays OFF	Keeps flashing	Remote control wires	• Poor connection, breakage of remote control wire * For wire breaking at power ON, the LED is OFF.	Repair	383
				Remote control	• Defective remote control PCB	Replacement of remote control			
WAIT or INSPECT I/U	Stays OFF	Keeps flashing	2-time flash	Keeps flashing	Indoor-outdoor units connection wire	• Poor connection, breakage of indoor-outdoor units connection wire	Repair	384-388	
					Remote control	• Improper setting of master and slave by remote control			
E1	Stays OFF	* Keeps flashing	Stays OFF	Keeps flashing	Remote control wires (Noise)	• Poor connection of remote control signal wire (White) * For wire breaking at power ON, the LED is OFF	Repair	390	
					Remote control indoor control PCB	* Defective remote control or indoor control PCB (defective communication circuit)?			
E5	2-time flash	Keeps flashing	2-time flash	Keeps flashing	Indoor-outdoor units connection wire	• Poor connection of wire between indoor-outdoor units during operation (disconnection, loose connection) • Anomalous communication between indoor-outdoor units by noise, etc.	Repair	391	
					(Noise)	• CPU-runaway on outdoor control PCB			
					Outdoor control PCB	* Occurrence of defective outdoor control PCB on the way of power supply (defective communication circuit)?	Replacement of PCB		
E6	1-time flash	Keeps flashing	Stays OFF	Keeps flashing	Indoor heat exchanger temperature thermistor	• Defective indoor heat exchanger temperature thermistor (defective element, broken wire, short-circuit) • Poor contact of temperature thermistor connector	Replacement, repair of temperature thermistor	392	
					Indoor control PCB	* Defective indoor control PCB (Defective temperature thermistor input circuit)?			Replacement of PCB
E7	1-time flash	Keeps flashing	Stays OFF	Keeps flashing	Indoor return air temperature thermistor	• Defective indoor return air temperature thermistor (defective element, broken wire, short-circuit) • Poor contact of temperature thermistor connector	Replacement, repair of temperature thermistor	393	
					Indoor control PCB	* Defective indoor control PCB (Defective temperature thermistor input circuit)?			Replacement of PCB
E8	1-time flash	Keeps flashing	Stays OFF	Keeps flashing	Installation or operating condition	• Heating over-load (Anomalously high indoor heat exchanger temperature)	Repair	394	
					Indoor heat exchanger temperature thermistor	• Defective indoor heat exchanger temperature thermistor (short-circuit)			
					Indoor control PCB	* Defective indoor control PCB (Defective temperature thermistor input circuit)?	Replacement of PCB		
E9	1-time flash	Keeps flashing	Stays OFF	Keeps flashing	Drain trouble	• Defective drain pump (DM), broken drain pump wire, disconnected connector	Replacement, repair of DM	395	
					Float switch	• Anomalous float switch operation (malfunction)			Repair
					Indoor control PCB	* Defective indoor control PCB (Defective float switch input circuit) * Defective indoor control PCB (Defective DM drive output circuit)?	Replacement of PCB		
					Option	• Defective optional parts (At optional anomalous input setting)	Repair		
E10	Stays OFF	Keeps flashing	Stays OFF	Keeps flashing	Number of connected indoor units	• When multi-unit control by remote control is performed, the number of units is over	Repair	396	
E11	Keeps flashing	Keeps flashing	Stays OFF	Keeps flashing	Address setting error	• Address setting error of indoor units	Repair	397	
E14	3-time flash	Keeps flashing	Stays OFF	Keeps flashing	Indoor unit No. setting	• No master is assigned to slaves.	Repair	398	
					Remote control wires	• Anomalous remote control wire connection, broken wire between master and slave units			
E16	1(2)-time flash	Keeps flashing	Stays OFF	Keeps flashing	Fan motor	• Defective fan motor	Replacement, repair	399	
					Indoor power PCB	• Defective indoor power PCB			Replacement
E18	1-time flash	Keeps flashing	Stays OFF	Keeps flashing	Address setting error	• Address setting error of master and slave indoor units	Repair	400	
E19	1-time flash	Keeps flashing	Stays OFF	Keeps flashing	Indoor control PCB	• Improper operation mode setting	Repair	401	

Remote control		Indoor control PCB		Outdoor control PCB		Location of trouble	Description of trouble	Repair method	Reference page
Error code	Red LED	Red LED	Green LED (1)	Red LED	Green LED (1)				
E20		1(2)-time flash	Keeps flashing	Stays OFF	Keeps flashing	Fan motor	• Indoor fan motor rotation speed anomaly	Replacement, repair	402
						Indoor power PCB	• Defective indoor power PCB	Replacement	
E21		1-time flash	Keeps flashing	Stays OFF	Keeps flashing	Panel switch detection	• Defective panel switch operation (FDT only)	Repair	403
E28		Stays OFF	Keeps flashing	Stays OFF	Keeps flashing	Remote control temperature thermistor	• Broken wire of remote control temperature thermistor	Repair	404

Note (1) **Normal indicator lamp (Indoor, outdoor units: Green) extinguishes (or lights continuously) only when CPU is anomalous. It keeps flashing in any trouble other than anomalous CPU.**

(2) * mark in the Description of trouble means that, in ordinary diagnosis, it cannot identify the cause definitely, and, if the trouble is repaired by replacing the part, it is judged consequently that the replaced part was defective.

2) SRK series

Remote control		Indoor unit display		Outdoor control PCB		Location of trouble	Description of trouble	Repair method	Reference page
Error code	Red LED	RUN light	TIMER light	Red LED	Green LED				
No-indication	Stays OFF	ON	Stays OFF	Stays OFF	Keeps flashing	—	•Normal operation	—	—
		—	—	2-time flash	Stays OFF	Indoor unit power supply	•Power OFF, broken wire/blown fuse, broken transformer wire	Repair	434
		—	—	Stays OFF	Keeps flashing	Remote control wires	•Poor connection, breakage of remote control wire * For wire breaking at power ON, the LED is OFF.	Repair	435
		—	—	Stays OFF	Keeps flashing	Remote control	• Defective remote control PCB	Replacement of remote control	
WAIT or INSPECT I/U		—	—	2-time flash	Keeps flashing	Indoor-outdoor units connection wire	• Poor connection, breakage of indoor-outdoor units connection wire	Repair	437-441
		—	—	Stays OFF	Keeps flashing	Indoor control PCB	• Defective indoor control PCB (Defective limit switch input circuit)?	Replacement of PCB	
E1		—	—	Stays OFF	Keeps flashing	Remote control wires (Noise)	•Poor connection of remote control signal wire (White) * For wire breaking at power ON, the LED is OFF	Repair	443
		—	—	Stays OFF	Keeps flashing	Remote control indoor control PCB	* Defective remote control or indoor control PCB (defective communication circuit)?	Replacement of remote control or PCB	
E5	Keeps flashing	ON	6-time flash	2-time flash	Keeps flashing	Indoor-outdoor units connection wire	•Poor connection of wire between indoor-outdoor units during operation (disconnection, loose connection) •Anomalous communication between indoor-outdoor units by noise, etc.	Repair	444
		ON	6-time flash	Stays OFF	Keeps flashing	(Noise)	•CPU-runaway on outdoor control PCB	Power reset or Repair	
		ON	6-time flash	Stays OFF	Keeps flashing	Outdoor control PCB	* Occurrence of defective outdoor control PCB on the way of power supply (defective communication circuit)?	Replacement of PCB	
E6	Keeps flashing	1-time flash	ON	Stays OFF	6-time flash	Indoor heat exchanger temperature sensor 1	•Defective indoor heat exchanger temperature sensor 1 (defective element, broken wire, short-circuit) • Poor contact of temperature sensor 1 connector	Replacement, repair of temperature sensor 1	445
		3-time flash	ON	Stays OFF	Keeps flashing	Indoor heat exchanger temperature sensor 2	•Defective indoor heat exchanger temperature sensor 2 (defective element, broken wire, short-circuit) • Poor contact of temperature sensor 2 connector	Replacement, repair of temperature sensor 2	
No-indication		2-time flash	ON	Stays OFF	Keeps flashing	Indoor room temperature sensor	•Defective indoor room temperature sensor (defective element, broken wire, short-circuit) •Poor contact of temperature sensor connector	Replacement, repair of temperature sensor	446
		—	—	Stays OFF	Keeps flashing	Indoor control PCB	•Defective indoor control PCB (Defective temperature thermistor input circuit)?	Replacement of PCB	
E10		—	—	Stays OFF	Keeps flashing	Number of connected indoor units	•When multi-unit control by remote control is performed, the number of units is over	Repair	447
E14		3-time flash	Keeps flashing	Stays OFF	Keeps flashing	Indoor unit No. setting	•No master is assigned to slaves.	Repair	448
						Remote control wires	•Anomalous remote control wire connection, broken wire between master and slave units	Replacement, repair	
E16		6-time flash	ON	Stays OFF	Keeps flashing	Fan motor	•Defective fan motor	Replacement, repair	449
						Indoor control PCB	•Defective indoor control PCB	Replacement	
E28		—	—	Stays OFF	Keeps flashing	Remote control temperature thermistor	• Broken wire of remote control temperature thermistor	Repair	450

Note (1) *mark in the Description of trouble means that, in ordinary diagnosis, it cannot identify the cause definitely, and, if the trouble is repaired by replacing the part, it is judged consequently that the replaced part was defective.

(ii) Outdoor unit

1) FDT, FDTC, FDEN, FDU, FDUM, FDF series

Remote control		Indoor control PCB		Outdoor control PCB		Outdoor inverter PCB		Location of trouble	Description of trouble	Repair method	Reference page
Error code	Red LED	Red LED	Green LED (1)	Red LED	Green LED (1)	Yellow LED (3) or Red LED (4)	Green LED (2)				
E35		Stays OFF	Keeps flashing	1-time flash	Keeps flashing			Installation or operating condition	• Higher outdoor heat exchanger temperature	Repair	405
								Outdoor heat exchanger temperature thermistor	• Defective outdoor heat exchanger temperature thermistor	Replacement of temperature thermistor	
								Outdoor control PCB	* Defective outdoor control PCB (Defective temperature thermistor input circuit)?	Replacement of PCB	
E36		Stays OFF	Keeps flashing	1-time flash	Keeps flashing			Installation or operating condition	• Higher discharge temperature	Repair	406
								Discharge pipe temperature thermistor	• Defective discharge pipe temperature thermistor	Replacement, repair of temperature thermistor	
								Outdoor control PCB	* Defective outdoor control PCB (Defective temperature thermistor input circuit)?	Replacement of PCB	
E37		Stays OFF	Keeps flashing	1-time flash	Keeps flashing	Keeps flashing		Outdoor heat exchanger temperature thermistor	• Defective outdoor heat exchanger temperature thermistor, broken wire or poor connector connection	Replacement, repair of temperature thermistor	407
								Outdoor control PCB	* Defective outdoor control PCB (Defective temperature thermistor input circuit)?	Replacement of PCB	
E38		Stays OFF	Keeps flashing	1-time flash	Keeps flashing			Outdoor air temperature thermistor	• Defective outdoor air temperature thermistor, broken wire or poor connector connection	Replacement, repair of temperature thermistor	408
								Outdoor control PCB	* Defective outdoor control PCB (Defective temperature thermistor input circuit)?	Replacement of PCB	
E39		Stays OFF	Keeps flashing	1-time flash	Keeps flashing			Discharge pipe temperature thermistor	• Defective discharge pipe temperature thermistor, broken wire or poor connector connection	Replacement, repair of temperature thermistor	409
								Outdoor control PCB	* Defective outdoor control PCB (Defective temperature thermistor input circuit)?	Replacement of PCB	
E40		Stays OFF	Keeps flashing	1-time flash	Keeps flashing			Installation or operating condition	• Rising high pressure (Operation of 63H1) • Service valve closing operation	Repair	410
								Outdoor control PCB	* Defective outdoor control PCB (Defective 63H input circuit)?	Replacement of PCB	
E41		Stays OFF	Keeps flashing	1-time flash	Keeps flashing	2-time flash or 6-time flash		Inverter PCB or radiator fin	• Power transistor overheat	Replacement of PCB or Repair	411 · 412
E42		Stays OFF	Keeps flashing	1-time flash	Keeps flashing	1-time flash or 5-time flash	Keeps flashing	Outdoor control PCB compressor	• Current cut (Anomalous compressor over-current)	Replacement of PCB	413 · 414
								Installation or operating condition	• Service valve closing operation	Repair	
E45		Stays OFF	Keeps flashing	1-time flash	Keeps flashing			Outdoor control PCB	• Anomalous outdoor control PCB communication	Service valve opening check	415
								Inverter PCB	• Anomalous inverter PCB communication	Replacement of PCB	
E48		Stays OFF	Keeps flashing	1-time flash	Keeps flashing	Keeps flashing		Outdoor fan motor	• Anomalous outdoor fan motor	Replacement, repair	416
								Outdoor control PCB	* Defective outdoor control PCB (Defective motor input circuit)?	Replacement of PCB	
E49		Stays OFF	Keeps flashing	1-time flash	Keeps flashing			Installation or operating condition	• Low pressure error • Service valve closing operation	Repair	417 · 418
								Low pressure sensor	• Anomalous low pressure, broken wire of low pressure sensor or poor connector connection	Replacement, repair of sensor	
								Outdoor control PCB	* Defective outdoor control PCB (Defective sensor input circuit)?	Replacement of control PCB	
E51		Stays OFF	Keeps flashing	1-time flash	Keeps flashing	2-time flash or 6-time flash		Inverter PCB	• Anomalous inverter PCB	Replacement of PCB	419
								Suction pipe temperature thermistor	• Defective suction pipe temperature thermistor, broken wire or poor connector connection	Replacement, repair of temperature thermistor	420
E53		Stays OFF	Keeps flashing	1-time flash	Keeps flashing			Outdoor control PCB	* Defective outdoor PCB (Defective thermistor input circuit)?	Replacement of control PCB	
								Low pressure sensor	• Defective low pressure sensor	Replacement of sensor	
E54		Stays OFF	Keeps flashing	1-time flash	Keeps flashing			Outdoor control PCB	• Defective outdoor control PCB (Defective sensor input circuit)?	Replacement of control PCB	422
								Compressor underneath temperature thermistor	• Defective compressor underneath temperature thermistor (Models 200, 250 only)	Replacement of temperature thermistor	
E55		Stays OFF	Keeps flashing	1-time flash	Keeps flashing			Outdoor control PCB	• Defective outdoor control PCB (Defective thermistor input circuit)? (Models 200, 250 only)	Replacement of control PCB	423
								Operation status	• Shortage in refrigerant quantity	Repair	
E57		Stays OFF	Keeps flashing	1-time flash	Keeps flashing			Installation status	• Service valve closing operation	Service valve opening check	424 · 425
								Compressor inverter PCB	• Anomalous compressor startup	Replacement	
E59		Stays OFF	Keeps flashing	5-time flash	Keeps flashing	Stays OFF or 4-time flash		Compressor	• Anomalous compressor rotor position detection (Models 200, 250 only)	Replacement	426
E60		Stays OFF	Keeps flashing	1-time flash	Keeps flashing	Keeps flashing		Compressor	• Anomalous compressor rotor position detection (Models 200, 250 only)	Replacement	426

Note (1) * mark in the Description of trouble means that, in ordinary diagnosis, it cannot identify the cause definitely, and, if the trouble is repaired by replacing the part, it is judged consequently that the replaced part was defective.

- (2) This LED is installed on models FDC200, 250VS
- (3) This LED is installed on models FDC100-140VN, FDC100-140VS
- (4) This LED is installed on models FDC200, 250VS

2) SRK series

Remote control		Indoor unit display		Outdoor control PCB		Outdoor inverter PCB	Location of trouble	Description of trouble	Repair method	Reference page
Error code	Red LED	RUN light	TIMER light	Red LED	Green LED	Yellow LED				
E35		ON	Keeps flashing	1-time flash	Keeps flashing		Installation or operating condition	• Higher outdoor heat exchanger temperature	Repair	451
							Outdoor heat exchanger temperature thermistor	• Defective outdoor heat exchanger temperature thermistor	Replacement of temperature thermistor	
							Outdoor control PCB	*• Defective outdoor control PCB (Defective temperature thermistor input circuit)?	Replacement of PCB	
E36		ON	5-time flash	1-time flash	Keeps flashing		Installation or operating condition	• Higher discharge temperature	Repair	452
							temperature thermistor	• Defective discharge pipe temperature thermistor	Replacement, repair of temperature thermistor	
							Outdoor control PCB	*• Discharge pipe Defective outdoor control PCB (Defective temperature thermistor input circuit)?	Replacement of PCB	
E37		Keeps flashing	2-time flash	1-time flash	Keeps flashing	Keeps flashing	Outdoor heat exchanger temperature thermistor	• Defective outdoor heat exchanger temperature thermistor, broken wire or poor connector connection	Replacement, repair of temperature thermistor	453
							Outdoor control PCB	*• Defective outdoor control PCB (Defective temperature thermistor input circuit)?	Replacement of PCB	
E38		Keeps flashing	1-time flash	1-time flash	Keeps flashing		Outdoor air temperature thermistor	• Defective Outdoor air temperature thermistor, broken wire or poor connector connection	Replacement, repair of temperature thermistor	454
							Outdoor control PCB	*• Defective outdoor control PCB (Defective temperature thermistor input circuit)?	Replacement of PCB	
E39		Keeps flashing	4-time flash	1-time flash	Keeps flashing		Discharge pipe temperature thermistor	• Defective discharge pipe temperature thermistor, broken wire or poor connector connection	Replacement, repair of temperature thermistor	455
							Outdoor control PCB	*• Defective outdoor control PCB (Defective temperature thermistor input circuit)?	Replacement of PCB	
E40		—	—	1-time flash	Keeps flashing		Installation or operating condition	• Rising high pressure (Operation of 63H1) • Service valve closing operation	Repair	456
							Outdoor control PCB	*• Defective outdoor control PCB (Defective 63H input circuit)?	Replacement of PCB	
E41		—	—	1-time flash	Keeps flashing	6-time flash	Inverter PCB or radiator fin	• Power transistor overheat	Replacement of PCB or Repair	457
E42		ON	1-time flash	1-time flash	Keeps flashing	1-time flash	Outdoor control PCB compressor	• Current cut (Anomalous compressor over-current)	Replacement of PCB	458-459
							Installation or operating condition	• Service valve closing operation	Repair	
E45		—	—	1-time flash	Keeps flashing		Outdoor control PCB	• Anomalous outdoor control PCB communication	Replacement of PCB	460
							Inverter PCB	• Anomalous inverter PCB communication		
E48		ON	7-time flash	1-time flash	Keeps flashing	Keeps flashing	Outdoor fan motor	• Anomalous outdoor fan motor	Replacement, repair	461
							Outdoor control PCB	*• Defective outdoor control PCB (Defective motor input circuit)?	Replacement of PCB	
							Installation or operating condition	• Low pressure error • Service valve closing operation	Repair	
E49		—	—	1-time flash	Keeps flashing		Low pressure sensor	• Anomalous low pressure, broken wire of low pressure sensor or poor connector connection	Replacement, repair of sensor	462-463
							Outdoor control PCB	*• Defective outdoor control PCB (Defective sensor input circuit)?	Replacement of control PCB	
							Installation or operating condition	• Low pressure error • Service valve closing operation	Repair	
E51		ON	4-time flash	1-time flash	Keeps flashing	6-time flash	Inverter PCB	• Anomalous inverter PCB	Replacement of PCB	464
E53		Keeps flashing	5-time flash	1-time flash	Keeps flashing	Keeps flashing	Suction pipe temperature thermistor	• Defective suction pipe temperature thermistor, broken wire or poor connector connection	Replacement, repair of temperature thermistor	465
							Outdoor control PCB	*• Defective outdoor PCB (Defective thermistor input circuit)?	Replacement of control PCB	
E54		—	—	1-time flash	Keeps flashing	Keeps flashing	Low pressure sensor	• Defective low pressure sensor	Replacement of sensor	466
							Outdoor control PCB	• Defective outdoor control PCB (Defective sensor input circuit)?	Replacement of control PCB	
E57		7-time flash	ON	1-time flash	Keeps flashing		Operation status	• Shortage in refrigerant quantity	Repair	467
							Installation status	• Service valve closing operation	Service valve opening check	
E59		—	—	5-time flash	Keeps flashing	Stays OFF	Compressor, inverter PCB	• Anomalous compressor startup	Replacement	468-469

Note (1) * mark in the Description of trouble means that, in ordinary diagnosis, it cannot identify the cause definitely, and, if the trouble is repaired by replacing the part, it is judged consequently that the replaced part was defective.

(iii) Optional controller in-use

1) FDT, FDTC, FDEN, FDU, FDUM, FDF series

Error code	Indoor unit control PCB			Outdoor unit control PCB		Description of trouble	Repair method
	Red LED	Red LED	Green LED	Red LED	Green LED		
E75	Keeps flashing	Stays OFF	Keeps flashing	Stays OFF	Keeps flashing	• Communication error (Defective communication circuit on the main unit of SC-SL2N-E or SC-SL3N-E) etc.	Replacement

2) SRK series

Error code	Indoor unit display panel			Outdoor unit control PCB		Description of trouble	Repair method
	Red LED	RUN light	TIMER light	Red LED	Green LED		
E75	Keeps flashing	—	—	Stays OFF	Keeps flashing	• Communication error (Defective communication circuit on the main unit of SC-SL2N-E or SC-SL3N-E) etc.	Replacement

(iv) Display sequence of error codes or inspection indicator lamps



■ Occurrence of one kind of error

Displays are shown respectively according to errors.

■ Occurrence of plural kinds of error

Section	Category of display
Error code on remote control	<ul style="list-style-type: none"> • Displays the error of higher priority (When plural errors are persisting) <p style="text-align: center;"><i>E 1 > E 5 > > E 10 > E 35 > > E 60</i></p> <ul style="list-style-type: none"> • Displays the present errors. (When a new error has occurred after the former error was reset.)
Red LED on indoor control PCB	
Red LED on outdoor control PCB	

■ Error detecting timing

Section	Error description	Error code	Error detecting timing
Indoor	Drain trouble (Float switch activated)	<i>E 9</i>	Whenever float switch is activated after 30 second had past since power ON.
	Communication error at initial operation	“  WAIT  ”	No communication between indoor and outdoor units is established at initial operation.
	Remote control communication circuit error	<i>E 1</i>	Communication between indoor unit and remote control is interrupted for mote than 2 minutes continuously after initial communication was established.
	Communication error during operation	<i>E 5</i>	Communication between indoor and outdoor units is interrupted for mote than 2 minutes continuously after initial communication was established.
	Excessive number of connected indoor units by controlling with one remote control	<i>E 10</i>	Whenever excessively connected indoor units is detected after power ON.
	Return air temperature thermistor anomaly	<i>E 7</i>	-50 (-45) °C or lower is detected for 5 (15) seconds continuously within 60 minutes after initial detection of this anomalous temperature.
	Indoor heat exchanger temperature thermistor anomaly	<i>E 6</i>	-50 (-28) °C or lower is detected for 5 (15) seconds continuously within 60 minutes after initial detection of this anomalous temperature. Or 70°C or higher is detected for 5 seconds continuously. (SRK series removes)
Outdoor	Outdoor air temperature thermistor anomaly	<i>E 38</i>	-45°C or lower is detected for 5 seconds continuously 3 times within 40 minutes after initial detection of this anomalous temperature. Or -45°C or lower is detected for 5 seconds continuously within 20 seconds after compressor ON.
	Outdoor heat exchanger temperature thermistor anomaly	<i>E 37</i>	-50°C or lower is detected for 5 seconds continuously 3 times within 40 minutes after initial detection of this anomalous temperature. Or -50°C or lower is detected for 5 seconds continuously within 20 seconds after compressor ON.
	Discharge pipe temperature thermistor anomaly	<i>E 39</i>	-10°C or lower is detected for 5 seconds continuously 3 times within 40 minutes after initial detection of this anomalous temperature.
	Suction pipe temperature thermistor anomaly	<i>E 53</i>	-50°C or lower is detected for 5 seconds continuously 3 times within 40 minutes after initial detection of this anomalous temperature.
	Low pressure sensor anomaly	<i>E 54</i>	0V or lower or 4.0V or higher is detected for 5 seconds continuously 3 times within 40 minutes after initial detection of this anomalous pressure.
	Underneath temperature thermistor anomaly	<i>E 55</i>	-50°C or lower is detected for 5 seconds continuously 3 times within 40 minutes after initial detection of this anomalous temperature.

Note (1) Value in () are for the SRK series.

■ **Error log and reset**

Error indicator	Memorized error log	Reset
Remote control display	• Higher priority error is memorized.	• Stop the unit by pressing the ON/OFF switch of remote controller. • If the unit has recovered from anomaly, it can be operated.
Red LED on indoor control PCB	• Not memorized.	
Red LED on outdoor control PCB	• Memorizes a mode of higher priority.	

■ **Resetting the error log**

- Resetting the memorized error log in the remote control
Holding down “CHECK” button, press “TIMER” button to reset the error log memorized in the remote control.
- Resetting the memorized error log in the indoor unit
The remote controller transmits error log erase command to the indoor unit when “VENTI” button is pressed while holding down “CHECK” button.
Receiving the command, the indoor unit erase the log and answer the status of no error.

(2) **Troubleshooting procedure**

When any trouble has occurred, inspect as follows. Details of respective inspection method will be described on later pages.

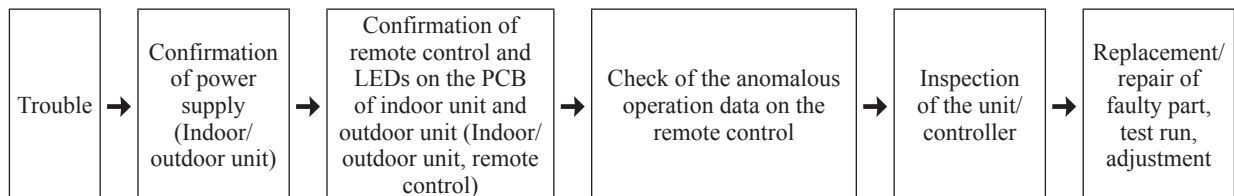

(3) **Troubleshooting at the indoor unit**

(a) **FDT, FDTC, FDEN, FDU, FDUM, FDF series**

With the troubleshooting, find out any defective part by checking the voltage (AC, DC), resistance, etc. at respective connectors at around the indoor PCB, according to the inspection display or operation status of unit (the compressor does not run, fan does not run, the 4-way valve does not switch, etc.), and replace or repair in the unit of following part.

(i) **Replacement part related to indoor PCB’s**

Control PCB, power supply PCB, temperature thermistor (return air, indoor heat exchanger), remote control switch, limit switch, transformer and fuse

Note (1) With regard to parts of high voltage circuits and refrigeration cycle, judge it according to ordinary inspection methods.

(ii) **Instruction of how to replace indoor control PCB**

SAFETY PRECAUTIONS

- Read the “SAFETY PRECAUTIONS” carefully first of all and then strictly follow it during the replacement in order to protect yourself.
- The precautionary items mentioned below are distinguished into two levels, WARNING and CAUTION. Both mentions the important items to protect your health and safety so strictly follow them by any means.
 - ⚠ **WARNING** Wrong installation would cause serious consequences such as injuries or death.
 - ⚠ **CAUTION** Wrong installation might cause serious consequences depending on circumstances.
- After completing the replacement, do commissioning to confirm there are no anomaly.

⚠ WARNING

- Replacement should be performed by the specialist.
If you replace the PCB by yourself, it may lead to serious trouble such as electric shock or fire.
- Replace the PCB correctly according to these instructions.
Improper replacement may cause electric shock or fire.
- Shut off the power before electrical wiring work.
Replacement during the applying the current would cause the electric shock, unit failure or improper running.
It would cause the damage of connected equipment such as fan motor, etc.
- Fasten the wiring to the terminal securely, and hold the cable securely so as not to apply unexpected stress on the terminal.
Loose connections or hold could result in abnormal heat generation or fire.
- Check the connection of wiring to PCB correctly before turning on the power, after replacement.
Defectiveness of replacement may cause electric shock or fire.

⚠ CAUTION

- In connecting connector onto the PCB, connect not to deform the PCB. It may cause breakage or malfunction.
- Insert connector securely, and hook stopper. It may cause fire or improper running.
- Bundle the cables together so as not to be pinched or be tensioned. It may cause malfunction or electric shock for disconnection or deformation.

1) Model FDT, FDUM series

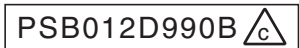

a) Control PCB

Replace and set up the PCB according to this instruction.

① Set to an appropriate address and function using switch on PCB.

Select the same setting with the removed PCB.

item	switch	Content of control			
Address	SW2	Plural indoor units control by 1 remote control			
Master /Slave setting		Master	Slave1	Slave2	Slave3
	SW5-1	—	—	○	○
	SW5-2	—	○	—	○
Test run	SW7-1	—	Normal		
		○	Operation check/drain motor test run		

○:ON —:OFF

② Set to an appropriate capacity using the model selector switch(SW6).

Select the same capacity with the PCB removed from the unit.

SW6	-1	-2	-3	-4
50V	○	—	○	—
60V	○	○	○	—
71V	○	—	—	○

SW6	-1	-2	-3	-4
100V	○	○	—	○
125V	—	—	○	○
140V	○	—	○	○

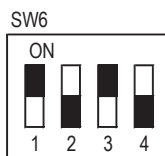

Example setting for 50V

③ Replace the PCB

1. Exchange PCB after detaching all connectors connected with the PCB.
2. Fix the PCB so as not to pitch the wiring.
3. Connect connectors to the PCB. Match the wiring connector to the connector color on the PCB and connect it.

④ Control PCB

Parts mounting are different by the kind of PCB.

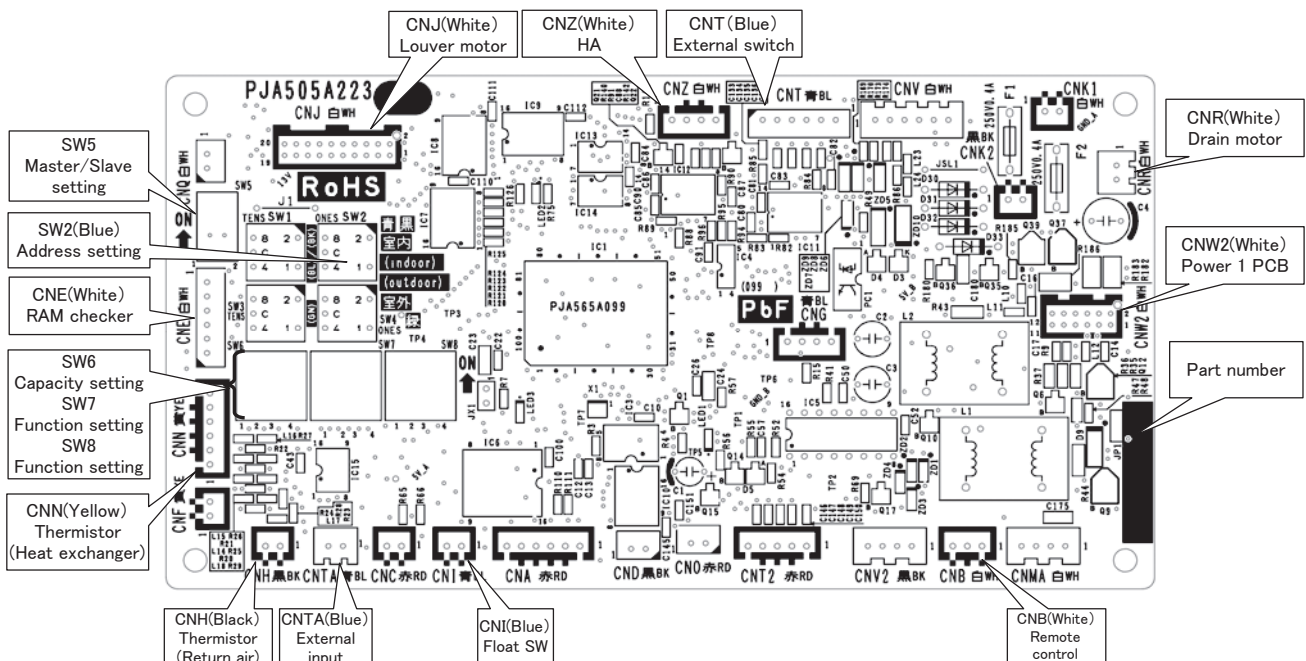

b) Power PCB

This PCB is a general PCB. Replace the PCB according to this instruction.

① Replace the PCB

1. Unscrew terminal of the wiring(yellow/green) connected to Terminal block (CNW0) from the box.
2. Replace the PCB only after all the wirings connected to the connector are removed.
3. Fix the board such that it will not pinch any of the wires.
4. Reconnect the wirings to the PCB. Wiring connector color should match with the color of connector of the PCB.
5. Screw back the terminal of wiring, that was removed in 1.

② Power PCB

Parts mounting are different by the kind of PCB.

• **Models FDT50-140VF, FDUM50VF**

PSB012D992

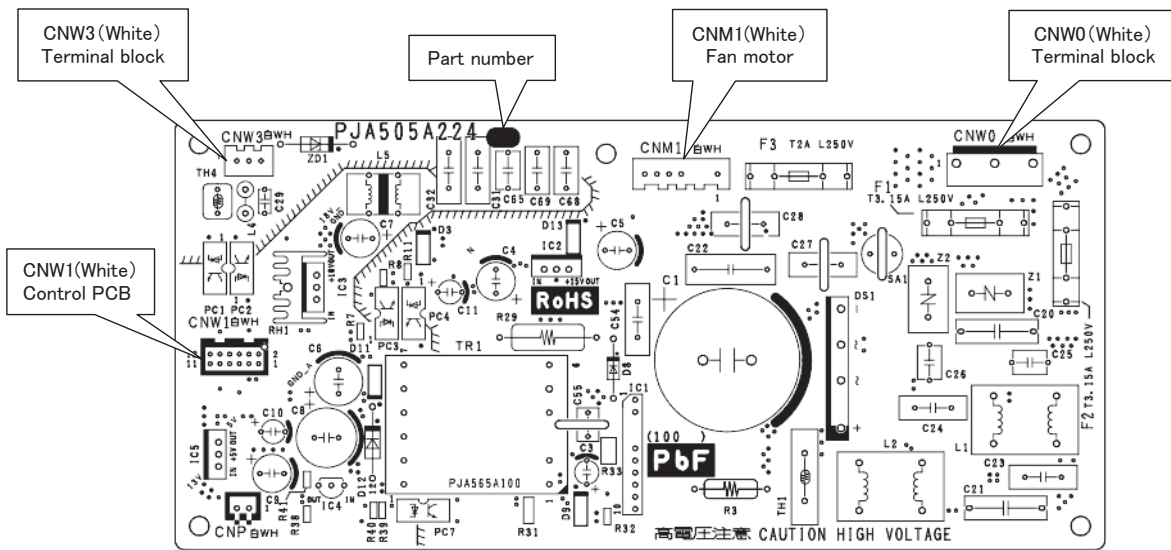

• **Models FDUM60-140VF**

PSB012D993

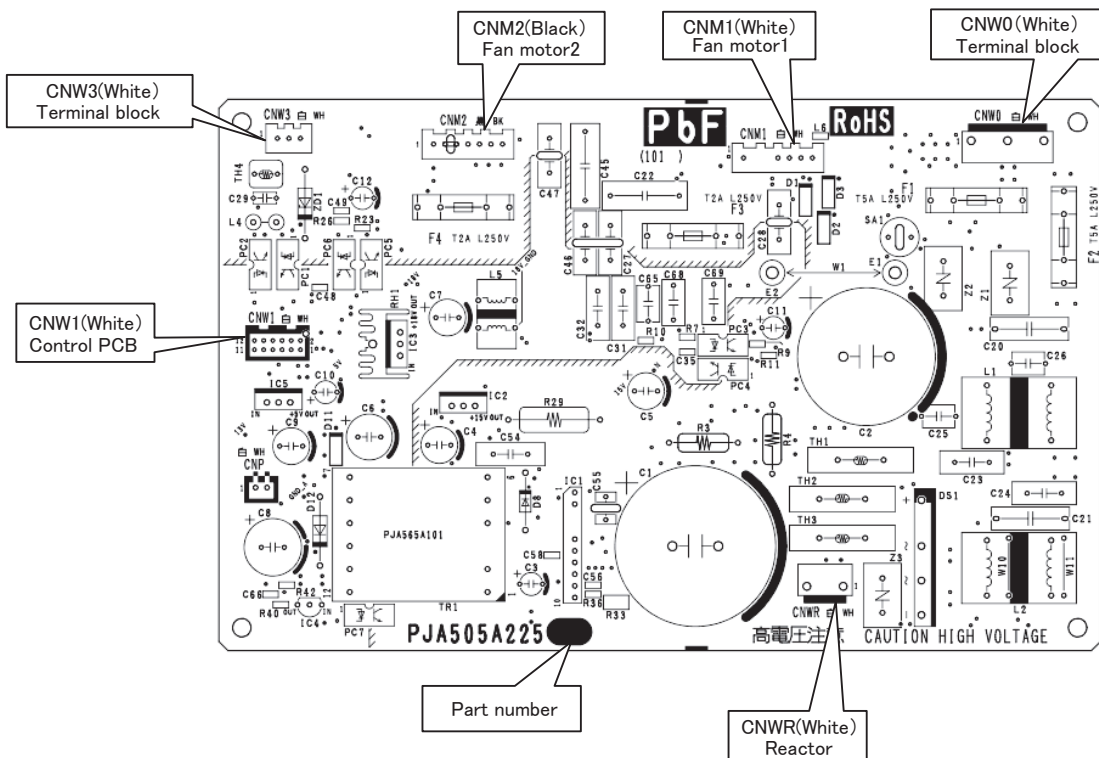

2) Model FDTC series

PSB012D976C

a) Control PCB

Replace and set up the PCB according to this instruction.

- ① Set to an appropriate address and function using switch on PCB.
Select the same setting with the removed PCB.

item	switch	Content of control			
Address	SW2	Plural indoor units control by 1 remote control			
Master / Slave setting		Master	Slave 1	Slave 2	Slave 3
	SW5-1	—	—	○	○
	SW5-2	—	○	—	○
Test run	SW7-1	—	Normal		
		○	Operation check/drain motor test run		

○:ON —:OFF

- ② Set to an appropriate capacity using the model selector switch(SW6).
Select the same capacity with the PCB removed from the unit.

SW6	-1	-2	-3	-4
50VF	○	—	○	—
60VF	○	○	○	—

SW6

Example setting for 50VF

- ③ Replace the PCB
 - Fix the PCB so as not to pitch the cords.
 - Connect connectors to the PCB. Connect a cable connector with the PCB connector of the same color.
 - Do not pass CPU surrounding about wirings.

- ④ Control PCB
Parts mounting are different by the kind of PCB.

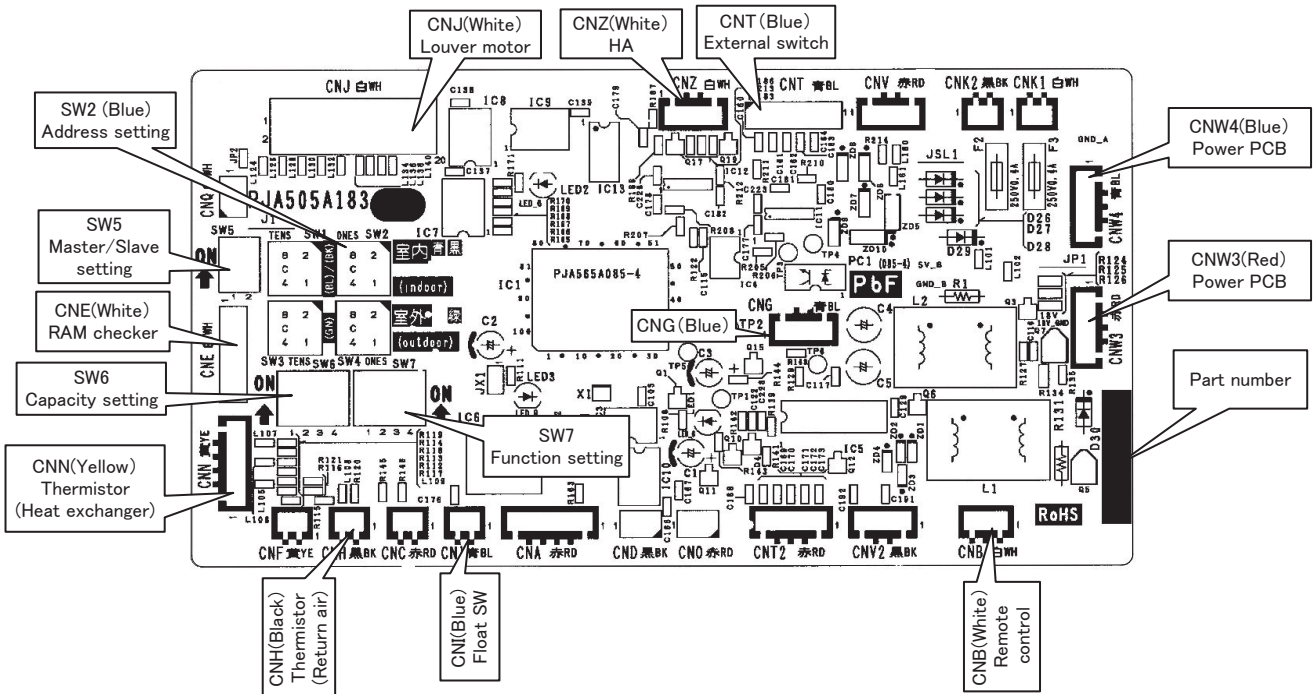

b) Power PCB

PSB012D953A

This PCB is a general PCB. Replace the PCB according to this instruction.

① Replace the PCB

1. Unscrew terminal of the wiring(yellow/green) soldered to PCB from the box.
2. Cut the band that binds the wiring (red and blue) from connector CNW1 and CNW2, and the wiring (yellow/green) from PCB (T2/T3) . (Note 1)
(However, do not cut the band that binds only the red and blue wirings.)
3. Replace the PCB only after all the wirings connected to the connector are removed.
4. Fix the board such that it will not pinch any of the wires.
5. Reconnect the wirings to the PCB. Wiring connector color should match with the color of connector of the PCB. (Note 2)
6. Let the wiring (red and blue) pass beneath the (yellow/green) wiring and bind together with band.
7. Screw back the terminal of wiring (yellow/green) from PCB(T1, T2/T3), that was removed in 1.
In that case, do not place the crimping part of the wiring under the PCB.
(Note 1): It might not be applicable on some models.
(Note 2): After replacing PCB, connection between capacitor assy and connector CNP is **no longer needed**.

② Power PCB

Parts mounting are different by the kind of PCB.

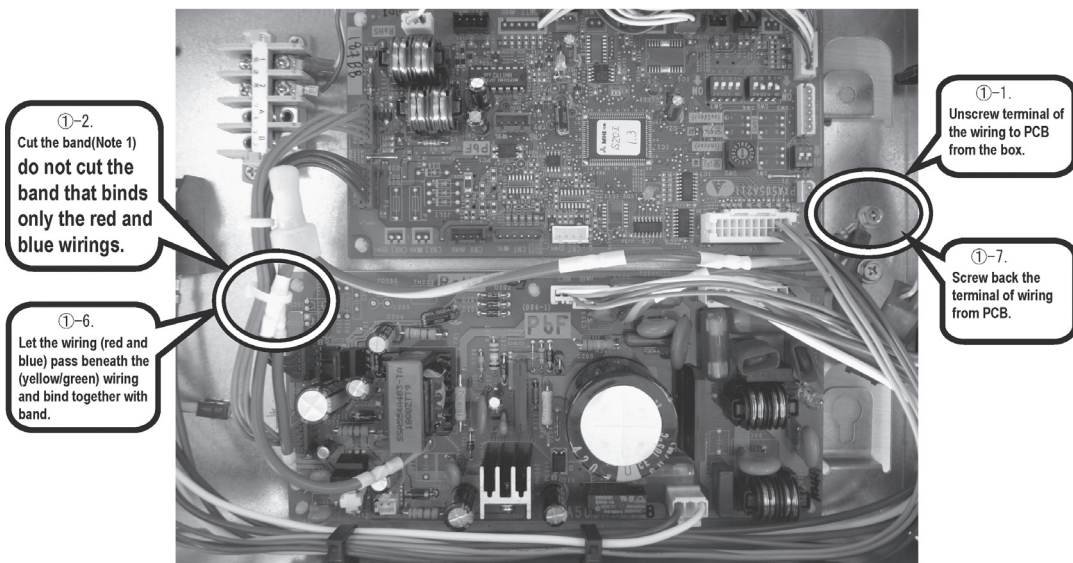
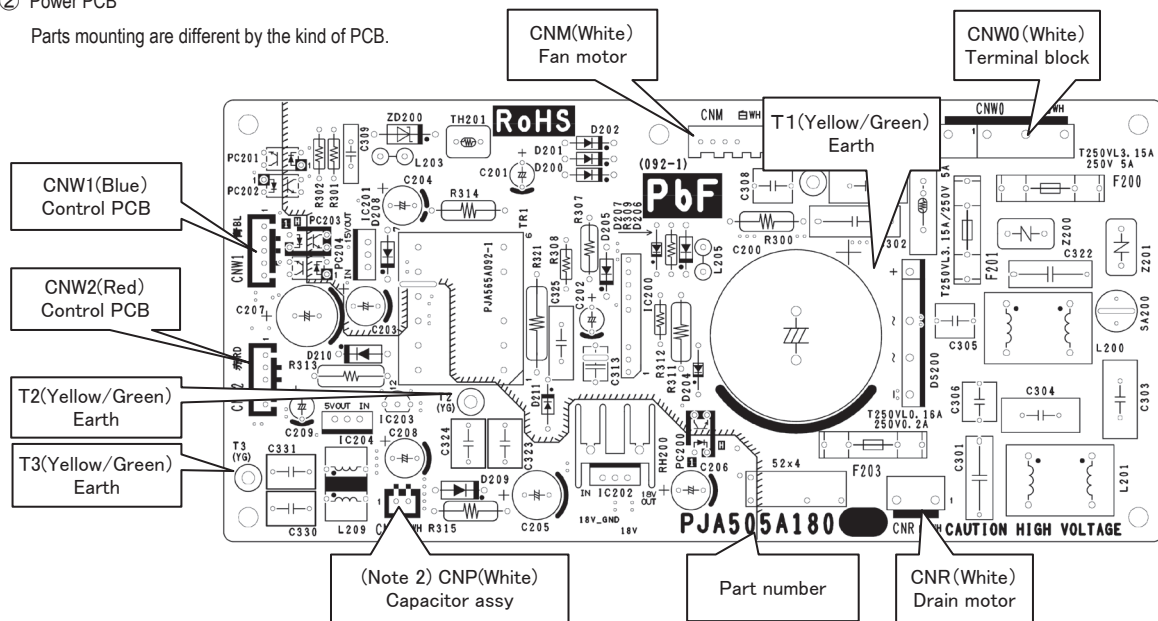

3) Model FDEN series

PSB01ZD974C

Replace and set up the PCB according to this instruction.

- ① Set to an appropriate address and function using switch on PCB.
 1. There is a unit having plural applicable PCB depending on a model.
 2. Set the function setting corresponding the spare PCB and the applicable model.
 3. Do "Setting according to the model *1" refer to "⑤ Function setting of wired remote control" after turning on the power source when using wired remote control
- ② Set to an appropriate capacity using the model selector switch(SW6).
 Select the same capacity with the PCB removed from the unit.

item	switch	Content of control			
Address	SW2	Plural indoor units control by 1 remote control			
Master/Slave setting	SW5-1	Master	Slave1	Slave2	Slave3
	SW5-2	—	—	○	○
T est run	SW7-1	Normal			
		○	Operation check/drain motor test run		

○ : ON — : OFF

SW6	-1	-2	-3	-4
50V	○	—	○	—
60V	○	○	○	—
71V	○	—	—	○

SW6	-1	-2	-3	-4
100V	○	○	—	○
125V	—	—	○	○
140V	○	—	○	○

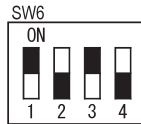

Example setting for 50V

- ③ Replace the PCB
 1. Fix the PCB so as not to pitch the cords.
 2. Connect connectors to the PCB. Connect a cable connector with the PCB connector of the same color.
 3. Do not pass CPU surrounding about wirings.
- ④ Control PCB
 Parts mounting are different by the kind of PCB.

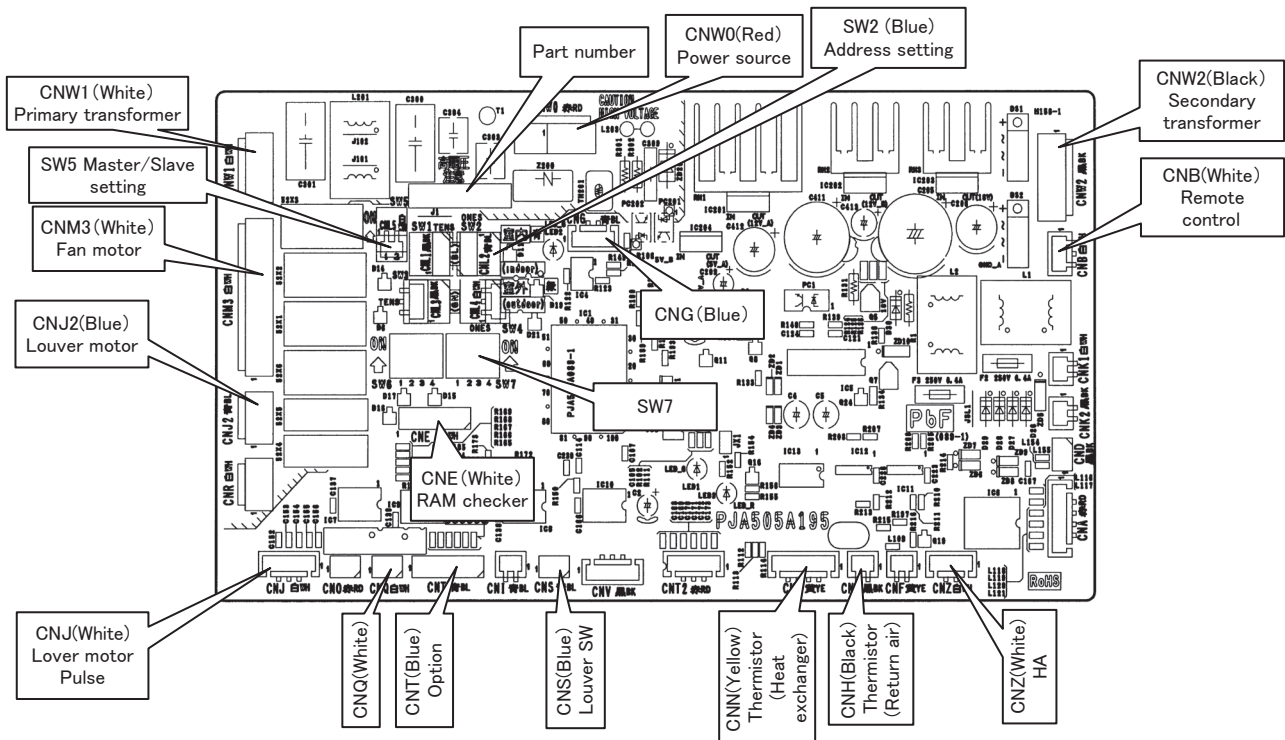

4) Model FDU series

PSC012D021

a) FDU100-140

This PCB is a general PCB. Replace the PCB according to this instruction.

① Replace the PCB

1. Unscrew terminal(Arrow A) of the "E2" wiring(yellow/green) that is connected to PCB.
2. Replace the PCB only after all the wirings connected to the connector are removed.
3. Fix the board such that it will not pinch any of the wires.
4. Reconnect the wirings to the PCB. Wiring connector color should match with the color of connector of the PCB.
5. Screw back the terminal(Arrow A) of the "E2" wiring, that was removed in 1.

② Power PCB

Parts mounting are different by the kind of PCB.

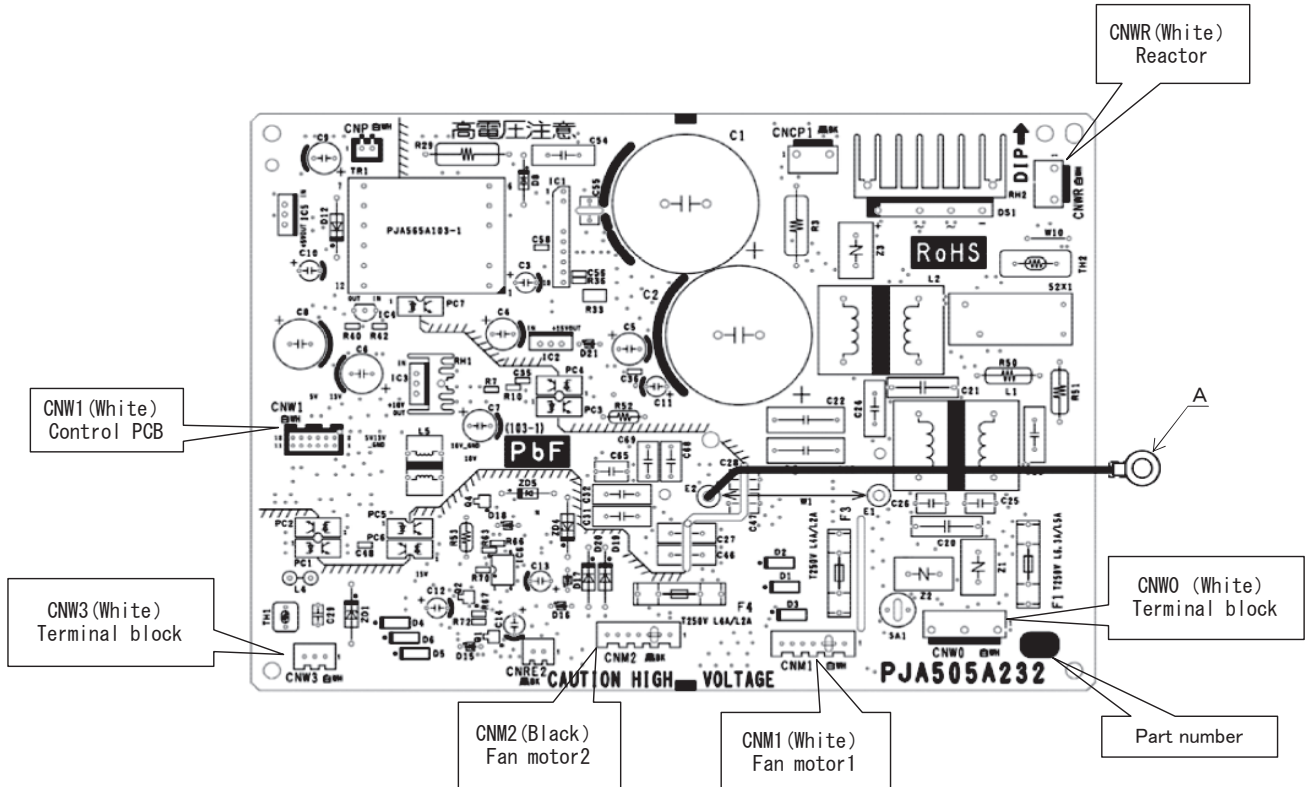

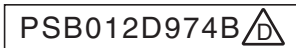

b) FDU200, 250

Replace and set up the PCB according to this instruction

- ① Set to an appropriate address and function using switch on PCB.
 1. There is a unit having plural applicable PCB depending on a model.
 2. Set the function setting corresponding the spare PCB and the applicable model.
 3. Do "Setting according to tht model *1" refer to "⑤ Function setting of wired remote control" after turning on the power source when using wired remote control

item	switch	Content of control	
Address	SW2	Plural indoor units control by 1 remote control	
Test run	SW7-1	—	Normal
		○	Operation check/drain motor test run

○ : ON — : OFF

- ② Set to an appropriate capacity using the model selector switch(SW6).
Select the same capacity with the PCB removed from the unit.

SW6	-1	-2	-3	-4
200V	—	○	○	○
250V	○	○	○	○

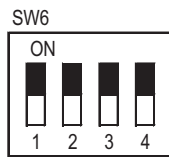

Example setting for 250V

- ③ Replace the PCB
 1. Fix the PCB so as not to pitch the cords.
 2. Connect connectors to the PCB. Connect a cable connector with the PCB connector of the same color.
 3. Do not pass CPU surrounding about wirings.

④ Control PCB

Parts mounting are different by the kind of PCB.

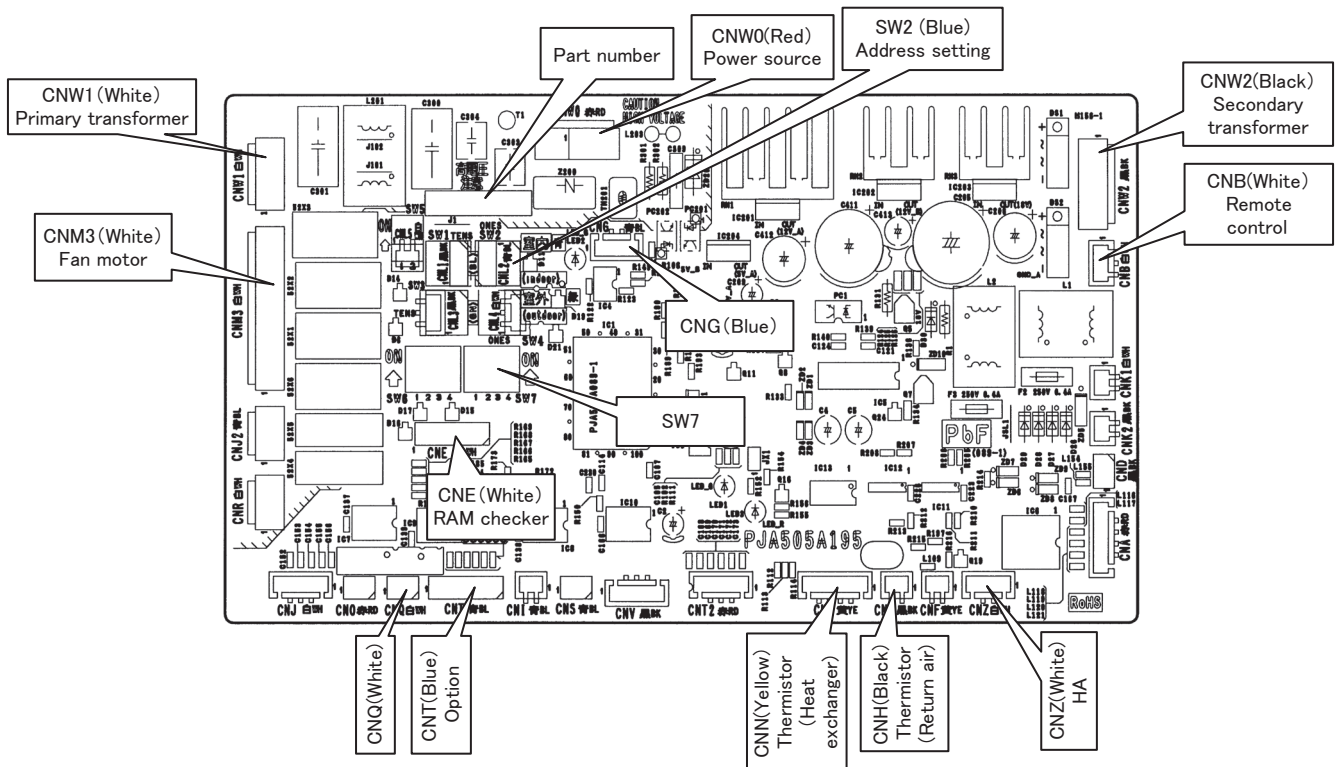

5) Model FDF series

PSB012D976C

a) Control PCB

Replace and set up the PCB according to this instruction.

① Set to an appropriate address and function using switch on PCB.

Select the same setting with the removed PCB.

item	switch	Content of control			
Address	SW2	Plural indoor units control by 1 remote control			
Master /Slave setting	SW5-1	Master	Slave1	Slave2	Slave3
	SW5-2	—	—	○	○
Test run	SW7-1	—	Normal		
		○	Operation check/drain motor test run		

② Set to an appropriate capacity using the model selector switch(SW6).

Select the same capacity with the PCB removed from the unit.

SW6	-1	-2	-3	-4
71V	○	—	—	○
100V	○	○	—	○
125V	—	—	○	○
140V	○	—	○	○

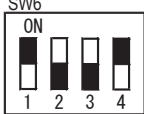

Example setting for 71V

③ Replace the PCB

1. Fix the PCB so as not to pitch the cords.
2. Connect connectors to the PCB. Connect a cable connector with the PCB connector of the same color.
3. Do not pass CPU surrounding about wirings.

④ Control PCB

Parts mounting are different by the kind of PCB.

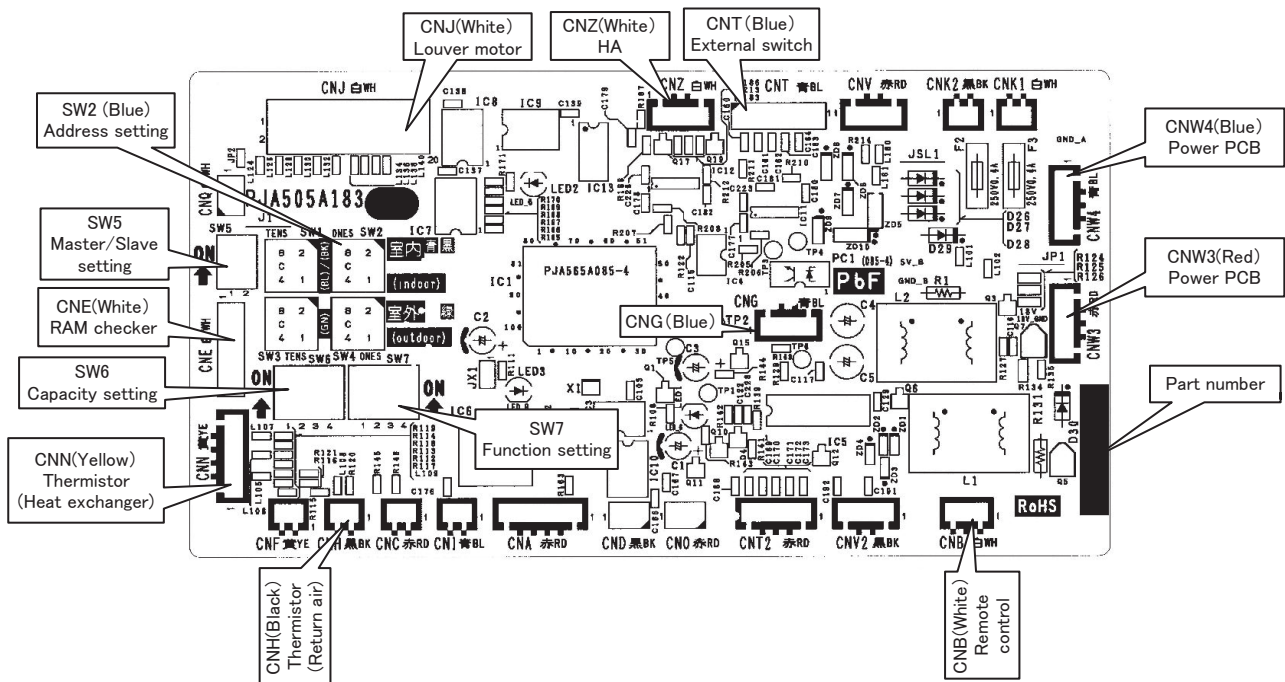

b) Power PCB

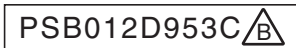

This PCB is a general PCB. Replace the PCB according to this instruction.

Replace the PCB

1. Unscrew terminal of the wiring(yellow/green) soldered to PCB from the box.
2. Replace the PCB only after all the wirings connected to the connector are removed.
3. Fix the board such that it will not pinch any of the wires.
4. Reconnect the wirings to the PCB. Wiring connector color should match with the color of connector of the PCB.
5. Screw back the terminal of wiring (yellow/green) from PCB(T1), that was removed in 1.

In that case, do not place the crimping part of the wiring under the PCB.

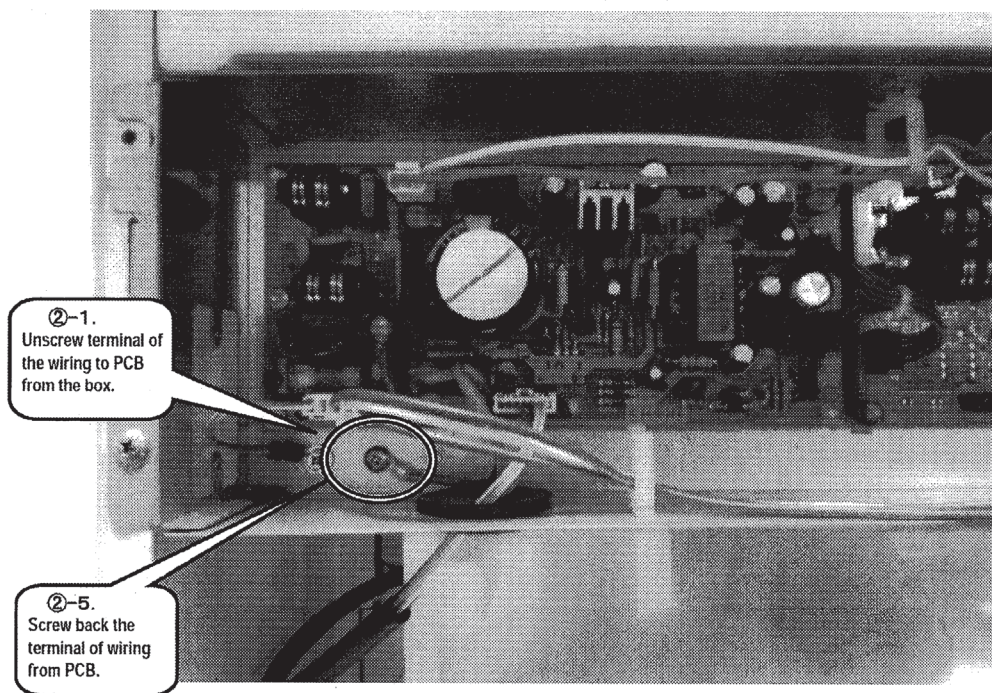
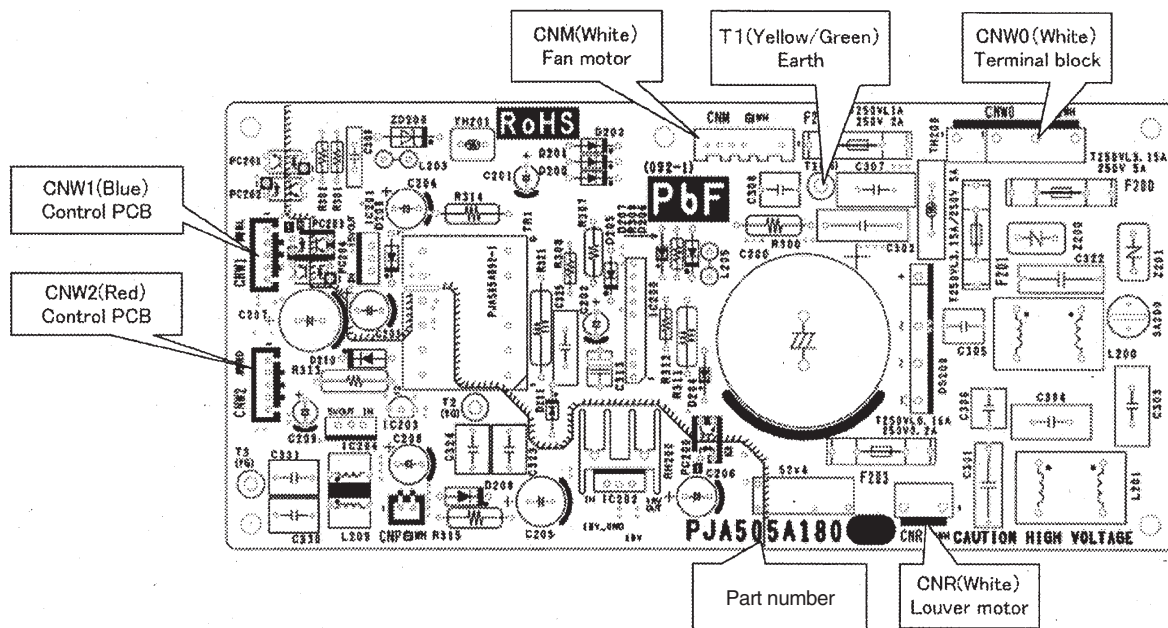

●DIP switch setting list

Switches	Description		Default setting		Remarks
SW2	Address No. setting at plural indoor units control by 1 R/C		0		0-F
SW5-1	Master/Slave setting	Master*/Slave	OFF		See table 2
SW5-2			OFF		
SW6-1	Model selection		As per model		See table 1
SW6-2					
SW6-3					
SW6-4					
SW7-1	Test run, Drain motor	Normal*/Test run	OFF	Normal	
SW7-2	Reserved		OFF		keep OFF
SW7-3	Powerful mode	Valid*/Invalid(FDU 200, 250 only)	ON	Valid	
SW7-4	Reserved		OFF		keep OFF
SW8-1	Reserved		OFF		keep OFF
SW8-2	Reserved		OFF		keep OFF
SW8-3	Reserved		OFF		keep OFF
SW8-4	Reserved		OFF		keep OFF
JSL1	Superlink terminal spare	Normal*/switch to spare	With		

Note (1) : SW8 : FDU200, 250 series removes. * Default setting

Table 1: Indoor unit model selection with SW6-1-SW6-4

	0: OFF 1:ON							
	50V	60V	71V	100V	125V	140V	200V	250V
SW6-1	1	1	1	1	0	1	0	1
SW6-2	0	1	0	1	0	0	1	1
SW6-3	1	1	0	0	1	1	1	1
SW6-4	0	0	1	1	1	1	1	1

Table 2: Indoor unit Master/Slave setting with SW5-1,SW5-2

	0: OFF 1:ON	
	SW5-1	SW5-2
Master	0	0
Slave1	0	1
Slave2	1	0
Slave3	1	1

(b) SRK series

(i) Cautions

- 1) If you are disassembling and checking an air conditioner, be sure to turn off the power before beginning.
When working on indoor units, let the unit sit for about 1 minute after turning off the power before you begin work.
- 2) When taking out printed circuit boards, be sure to do so without exerting force on the circuit boards or package components.
- 3) When disconnecting and connecting connectors, take hold of the connector housing and do not pull on the lead wires.

(ii) Items to check before troubleshooting

- 1) Is the air conditioner running? Is it displaying any self-diagnosis information?
- 2) Is a power supply with the correct voltage connected?
- 3) Are the control lines connecting the indoor and outdoor units wired correctly and connected securely?
- 4) Is the outdoor unit's service valve open?

(iii) Troubleshooting procedure (If the air conditioner does not run at all)

If the air conditioner does not run at all, diagnose the trouble using the following troubleshooting procedure.

Important When all the following conditions are met, we say that the air conditioner will not run at all.

- 1) The RUN light does not light up.
- 2) The flaps do not open.
- 3) The indoor unit fan motors do not run.
- 4) The self-diagnosis display does not function.

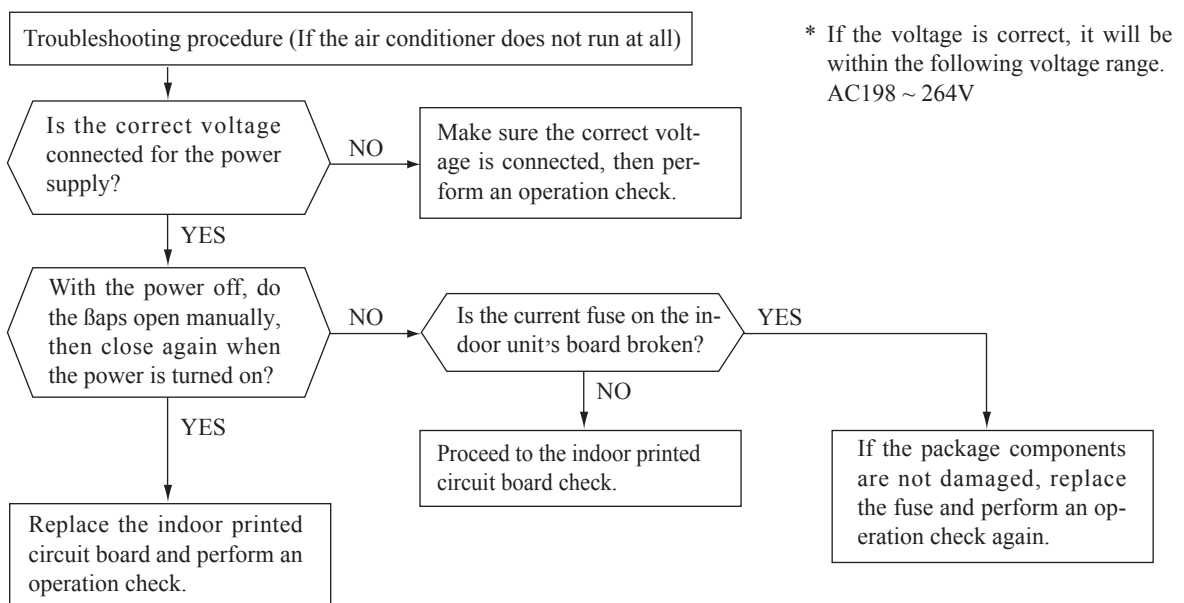

(iv) Inspection procedures corresponding to detail of trouble

Sensor error

[Broken sensor wire, connector poor connection]

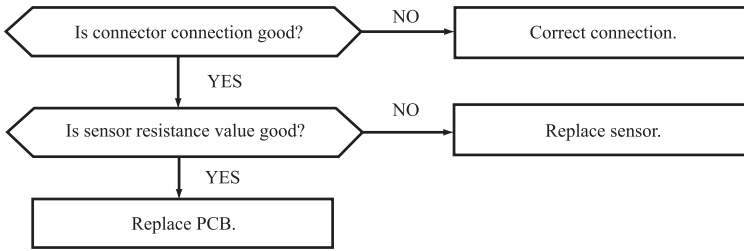

◆ **Sensor temperature characteristics (Room temp., indoor heat exchanger temp.)**

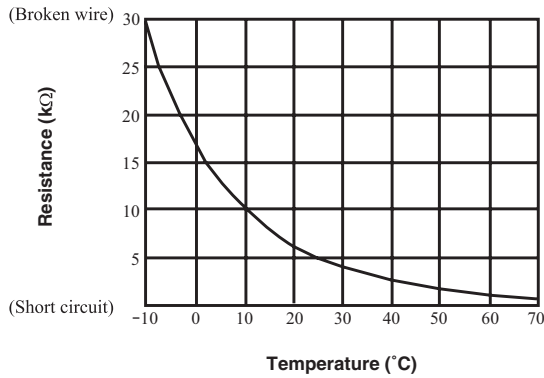

Indoor fan motor error

[Defective fan motor, connector poor connection, defective indoor PCB]

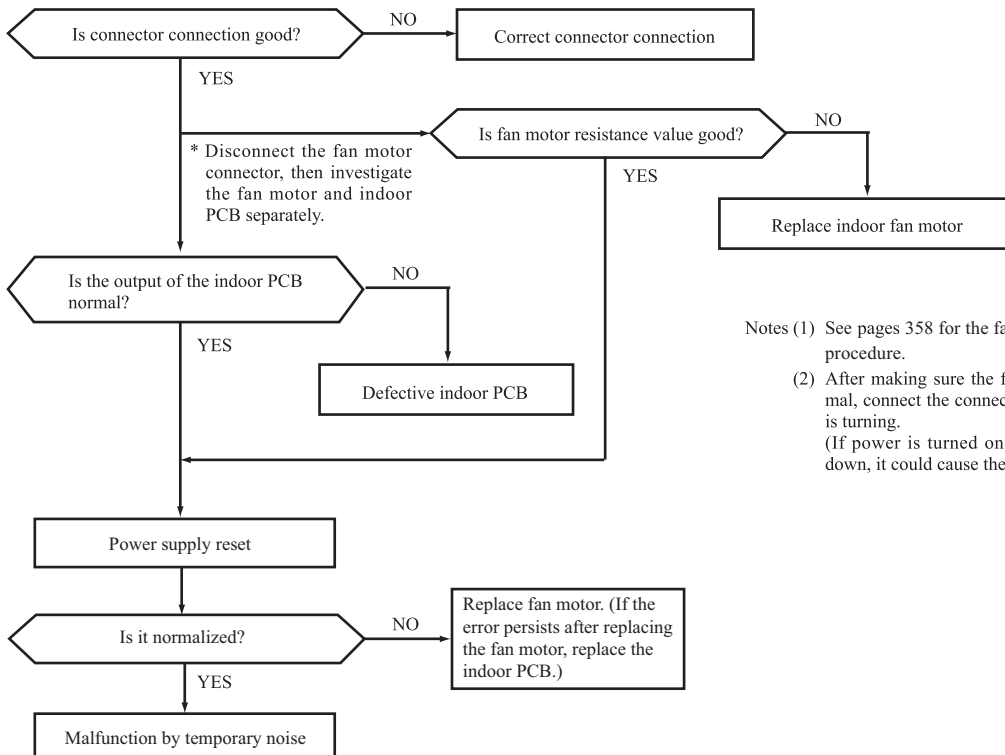

Notes (1) See pages 358 for the fan motor and indoor PCB check procedure.

(2) After making sure the fan motor and indoor PCB are normal, connect the connectors and confirm that the fan motor is turning.

(If power is turned on while one or the other is broken down, it could cause the other to break down also.)

Error of signal transmission

[Wiring error including power cable, defective indoor/
outdoor PCB]

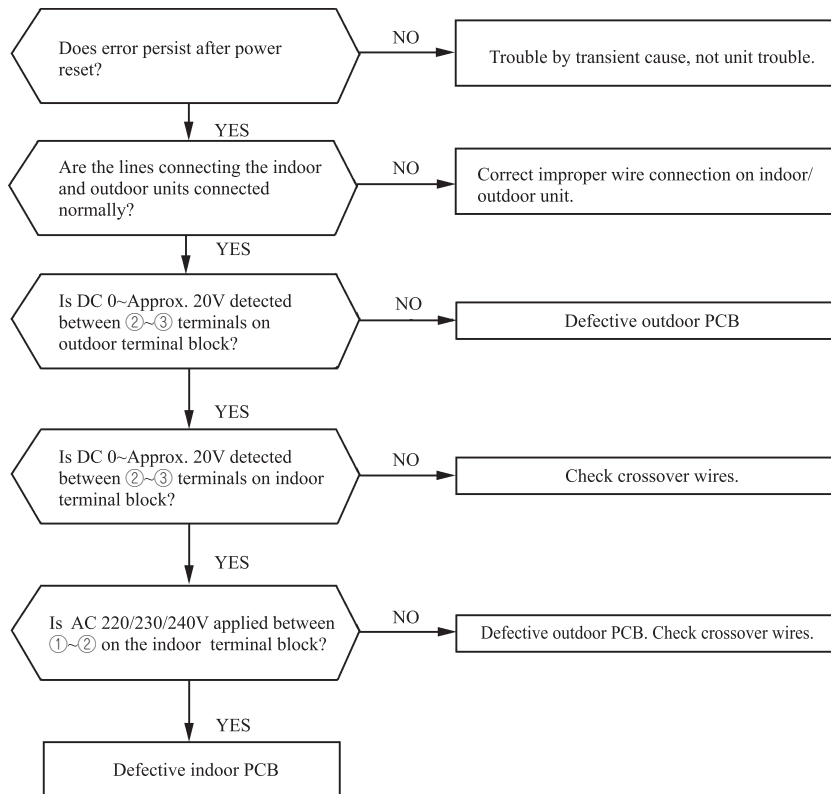

(v) Phenomenon observed after shortcircuit, wire breakage on sensor

Sensor	Operation mode	Phenomenon	
		Shortcircuit	Disconnected wire
Room temperature sensor	Cooling	Release of continuous compressor operation command.	Continuous compressor operation command is not released.
	Heating	Continuous compressor operation command is not released.	Release of continuous compressor operation command.
Heat exchanger sensor	Cooling	Freezing cycle system protection trips and stops the compressor.	Continuous compressor operation command is not released. (Anti-frosting)
	Heating	High pressure control mode (Compressor stop command)	Hot keep (Indoor fan stop)
Humidity sensor	Cooling	Refer to the table below.	Refer to the table below.
	Heating	Normal system operation is possible.	

■ Humidity sensor operation

Failure mode	Control input circuit reading	Air conditioning system operation
Disconnected wire	① Disconnected wire	Humidity reading is 0%
	② Disconnected wire	
	①② Disconnected wire	
Short circuit	① and ② are short circuited	Humidity reading is 100%

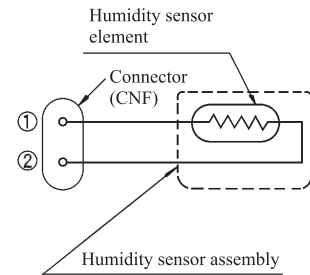

Remark: Do not perform a continuity check of the humidity sensor with a tester. If DC current is applied, it could damage the sensor.

(vi) Checking the indoor electrical equipment

1) Indoor PCB check procedure

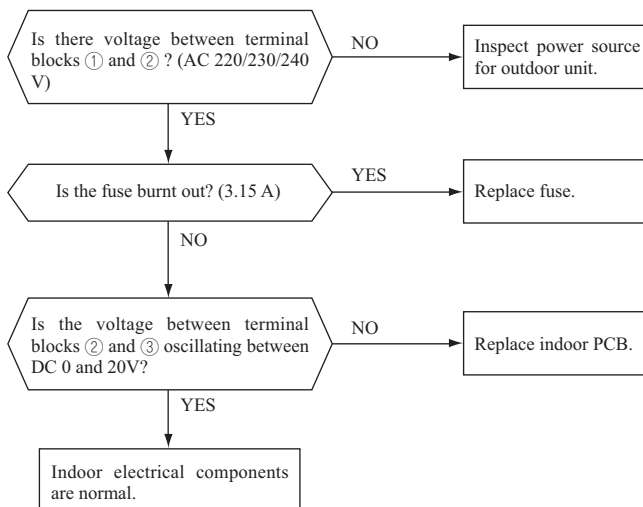

2) Indoor unit fan motor check procedure

This is a diagnostic procedure for determining if the indoor unit's fan motor or the indoor PCB is broken down.

a) Indoor PCB output check

- i) Turn off the power.
- ii) Remove the front panel, then disconnect the fan motor lead wire connector.
- iii) Turn on the power. If the unit operates when the ON/OFF button is pressed, if trouble is detected after the voltages in the following figure are output for approximately 30 seconds, it means that the indoor PCB is normal and the fan motor is broken down.

If the voltages in the following figure are not output at connector pins No. ①, ④ and ⑤, the indoor PCB has failed and the fan motor is normal.

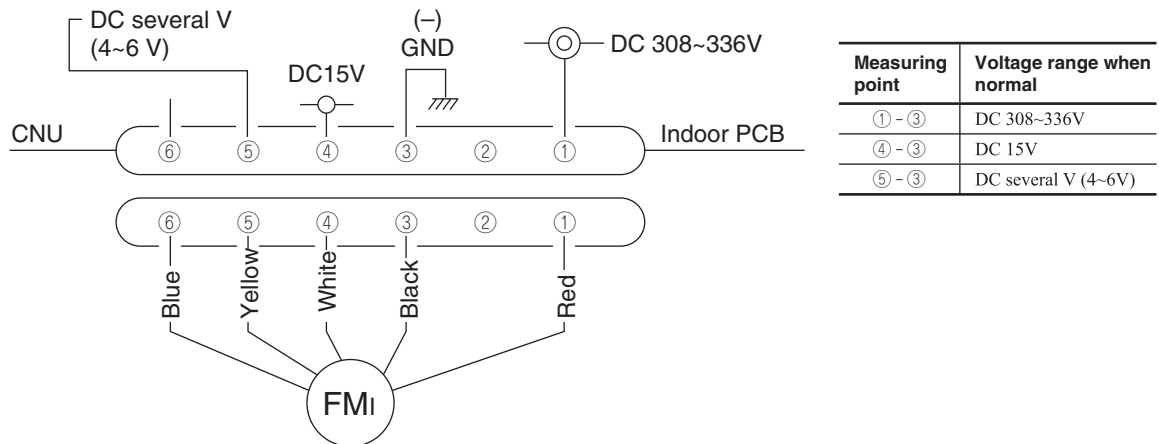

b) Fan motor resistance check

Measuring point	Resistance when normal
① - ③ (Red - Black)	20 MΩ or higher
④ - ③ (White - Black)	20 kΩ or higher

- Notes (1) Remove the fan motor and measure it without power connected to it.
- (2) If the measured value is below the value when the motor is normal, it means that the fan motor is faulty.

(vii) Inspection procedure for blown fuse on the indoor PCB

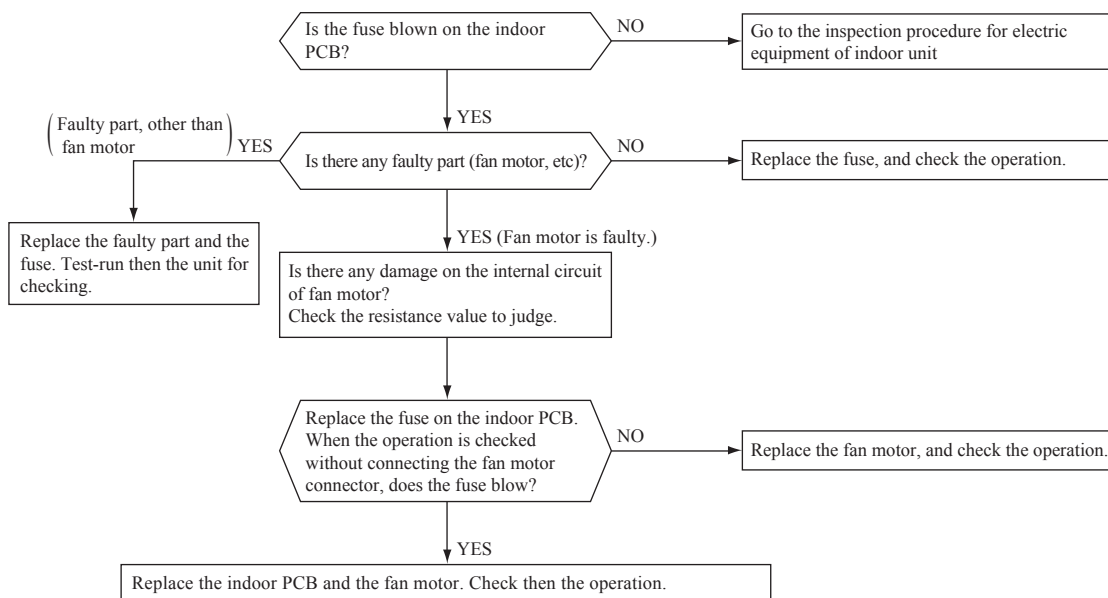

(4) Troubleshooting at the outdoor unit

When troubleshooting the outdoor unit, firstly assess the overview of malfunction and try to presume the cause and the faulty part by checking the error code displayed on the remote control and flashing pattern of indicator lamps (Red LED and Green LED), and then proceed further inspection and remedy it.

Self-diagnosis system by microcomputer on indoor and outdoor PCB can assist to find the cause of malfunction smoothly by making a diagnosis of not only the anomaly of microcomputer, but also the anomaly in power supply system, installation space, overload resulting from improper charging amount of refrigerant and etc.

Unless the power is reset, the error log is saved in memory and the inspection indicator lamps on outdoor PCB keep flashing after automatical recovering from malfunction.

After automatical recovering from malfunction, if any another error mode which has a higher priority than the previous error saved in memory occurs, it is overwritten in memory and is displayed.

[Reset of power supply]

Be sure to avoid electrical shock, when replacing or checking the outdoor control PCB, because some voltage is still retained in the electrolytic capacitor on the PCB even after shutting down the power supply to the outdoor unit.

Be sure to start repairing work, after confirming that the Green LED on the PCB has been extinguished for more than 10 seconds after more than 3 minutes had been passed since power shut down, and reconfirming that voltage has been discharged sufficiently by measuring the voltage (DC) between both terminals of electrolytic capacitor (C58) (Measurement of voltage may be disturbed by the moisture-proof coating. In such case, remove the coating and measure it by taking care of avoiding electrical shock)

(a) Module of part to be replaced for outdoor unit control

Outdoor control PCB, Inverter PCB, Temperature thermistor (of outdoor heat exchanger, discharge pipe, outdoor air, IPM and suction pipe), Fuses (for power supply and control PCB), Noise filter, Capacitor and Reactor.

(b) Replacement procedure of outdoor control PCB

Precautions for Safety	
<ul style="list-style-type: none"> • Since the following precaution is the important contents for safety, be sure to observe them. WARNING and CAUTION are described as follows: 	
<div style="border: 1px solid black; padding: 2px; display: inline-block;"> WARNING</div>	Indicates an imminently hazardous situation which will result in death or serious injury if proper safety procedures and instructions are not adhered to.
<div style="border: 1px solid black; padding: 2px; display: inline-block;"> CAUTION</div>	Indicates a potentially hazardous situation which may result in minor or moderate injury if proper safety procedures and instructions are not adhered to.
WARNING	
<ul style="list-style-type: none"> • Securely replace the PCB according to this procedure. If the PCB is incorrectly replaced, it will cause an electric shock or fire. • Be sure to check that the power source for the outdoor unit is turned OFF before replacing the PCB. The PCB replacement under current-carrying will cause an electric shock or fire. • After finishing the PCB replacement, check that wiring is correctly connected with the PCB before power distribution. If the PCB is incorrectly replaced, it will cause an electric shock or fire. 	
CAUTION	
<ul style="list-style-type: none"> • Band the wiring so as not to tense because it will cause an electric shock. 	

1) Model FDC100VN, 125VN, 140VN
FDC100VS, 125VS, 140VS

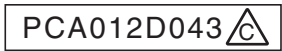

- a) Replace the PCB **after elapsing 3 minutes from power OFF.**
(Be sure to measure voltage (DC) on both capacitor terminals located in controller back, and check that the voltage is discharged sufficiently.)
- b) Disconnect the connectors from the control PCB.
- c) Disconnect the white wiring passing through CT1 on the PCB before replacing the PCB.
- d) Match the setting switches (SW3-5,JSW) with the former PCB.
- e) Tighten up a screw after passing white wiring through CT1 of the changed.
- f) Connect the connectors with the control PCB referring to the parts arrangement of fig.1-2. (Confirm the **connectors are not half inserted.**)

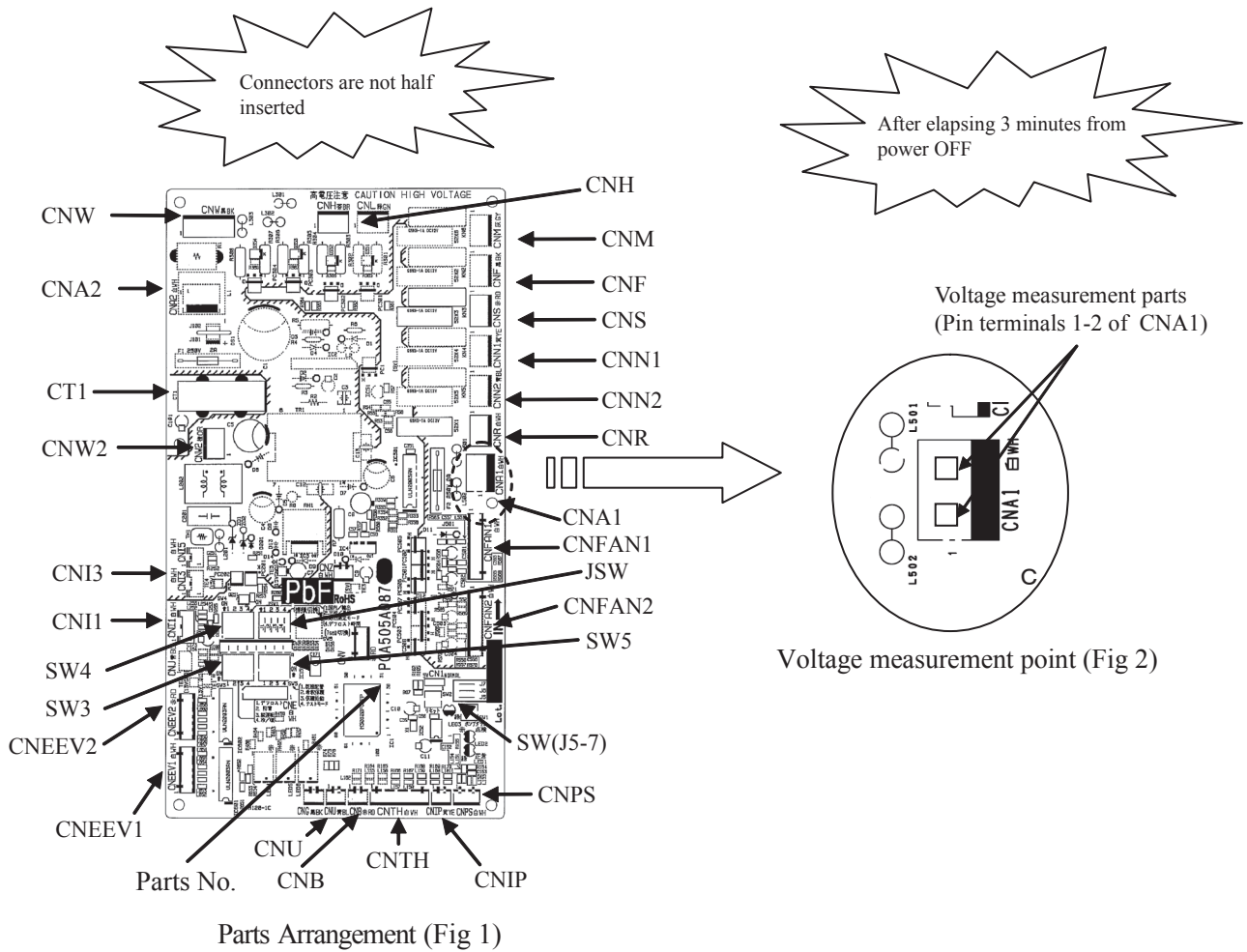

2) Model FDC200,250VS

PCA012D017F 

- a) Replace the PCB **after elapsing 3 minutes from power OFF.**
(Be sure to measure the voltage (DC) of two places (1.Resistor on PCB at the front of controller
 2.Both capacitor terminals located in back of controller), and **check that the voltage is discharged sufficiently.** (Refer to Fig.1))
- b) Disconnect the connectors from the control PCB.
- c) Disconnect the blue wiring passing through CT1 on the substrate before replacing the PCB.
- d) Match the setting switches (SW3-5,JSW) with the former PCB.
- e) Tighten up a screw after passing blue wiring through CT1 of the changed.
- f) Connect the connectors to the control PCB. (Confirm the connectors are not half inserted)

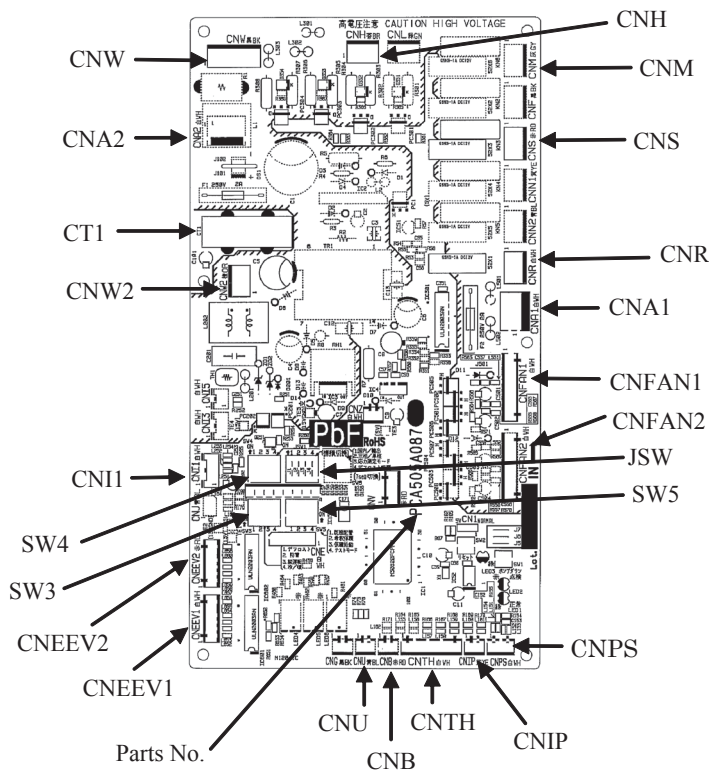

Parts Arrangement View

connectors are not half inserted

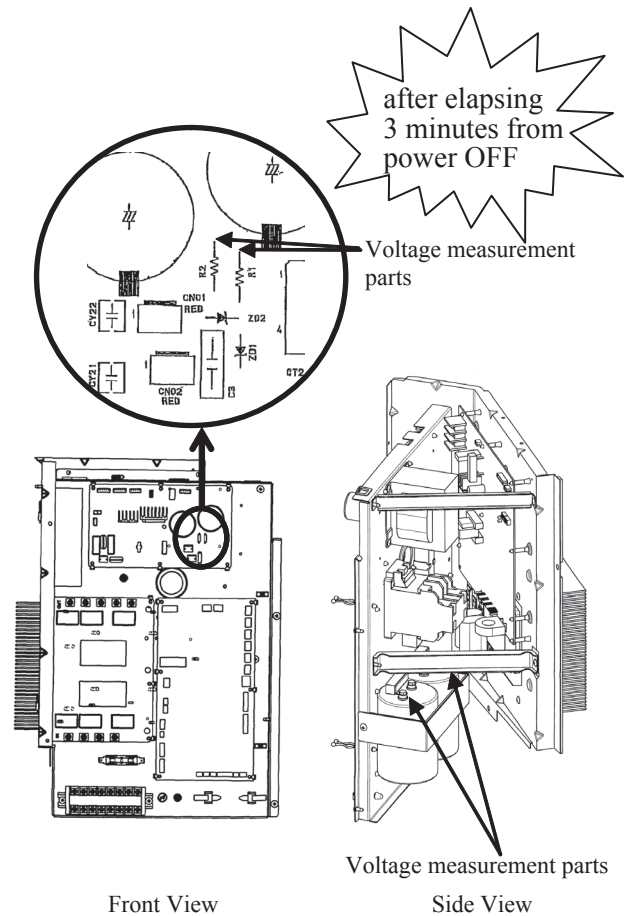

Front View

Side View

Fig.1 Position of capacitor

(c) Outdoor inverter PCB replacement procedure

Precautions for Safety

- Since the following precaution is the important contents for safety, be sure to observe them.
WARNING and CAUTION are described as follows:

! **WARNING**

Indicates an imminently hazardous situation which will result in death or serious injury if proper safety procedures and instructions are not adhered to.

! **CAUTION**

Indicates a potentially hazardous situation which may result in minor or moderate injury if proper safety procedures and instructions are not adhered to.

! WARNING

- Securely replace the PCB according to this procedure.
If the PCB is incorrectly replaced, it will cause an electric shock or fire.
- Be sure to check that the power source for the outdoor unit is turned OFF before replacing the PCB. The PCB replacement under current-carrying will cause an electric shock or fire.
- After finishing the PCB replacement, check that wiring is correctly connected with the PCB before power distribution. If the PCB is incorrectly replaced, it will cause an electric shock or fire.

! CAUTION

- Band the wiring so as not to tense because it will cause an electric shock.

Replace the inverter PCB according to the following procedure.

1) Model FDC100VN, 125VN, 140VN

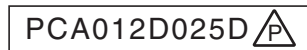

- a) Replace the PCB **after elapsing 3 minutes from power OFF.**
(Be sure to measure voltage (DC) on both capacitor terminals located in controller back, and check that the voltage is discharged sufficiently. (Refer to Fig.1))
- b) Take off the connection of inverter PCB terminal block connector and remove the screw of power transistor then remove the PCB. Wipe off the silicon grease neatly on the controller's radiation heat fins.
- c) Refer to table1 for the setting of switch (JSW10,11) of new PCB.
- d) Before installing the power transistor on the new PCB, Apply uniformly a bundled of silicon grease first on the surface of power transistor. Make sure it is applied to prevent damage on power transistor.
- e) Tighten the screw of power transistor on inverter PCB and connect the terminal block. Confirm the connection and don't use soldering in the connection. Tighten properly the power transistor with a screw and make sure there is no slack. Power transistor can be damage if not properly tighten. (Recommended power transistor tightening torque: 0.98~1.47N·m)

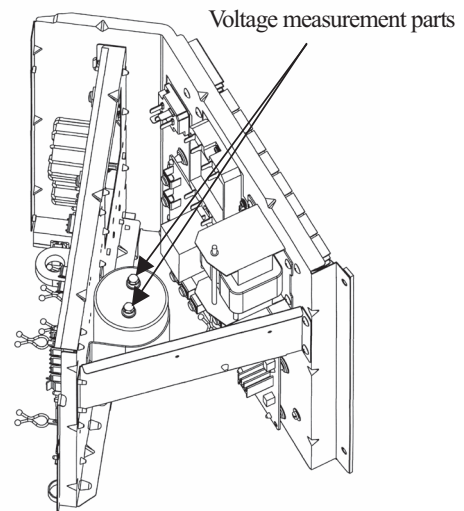
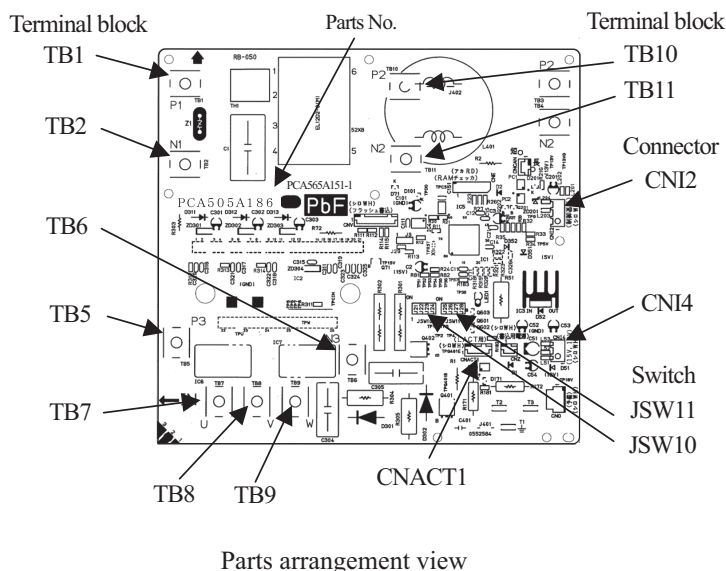
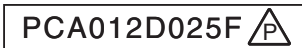

Table. 1 Switch setting

JSW 10	-1	OFF	JSW 11	-1	ON
	-2	OFF		-2	OFF
	-3	OFF		-3	OFF
	-4	OFF		-4	ON

2) Model FDC100VS, 125VS, 140VS



- a) Replace the PCB **after elapsing 3 minutes from power OFF.**
(Be sure to measure voltage (DC) on both capacitor terminals located in controller back, and **check that the voltage is discharged sufficiently.**(Refer to Fig.1))
- b) Take off the connection of inverter PCB terminal block connector and remove the screw of power transistor then remove the PCB. Wipe off the silicon grease neatly on the controller's radiation heat fins.
- c) Refer to table1 for the setting of switch (JSW10,11) of new PCB.
- d) Before installing the power transistor on the new PCB, Apply uniformly a bundled of silicon grease first on the surface of power transistor.Make sure it is applied to prevent damage on power transistor.
- e) Tighten the screw of power transistor on inverter PCB and connect the terminal block.Confirm the connection and don't use soldering in the connection.Tighten properly the power transistor with a screw and make sure there is no slack.Power transistor can be damage if not properly tighten.(Recommended power transistor tightening torque:0.98~1.47N·m)

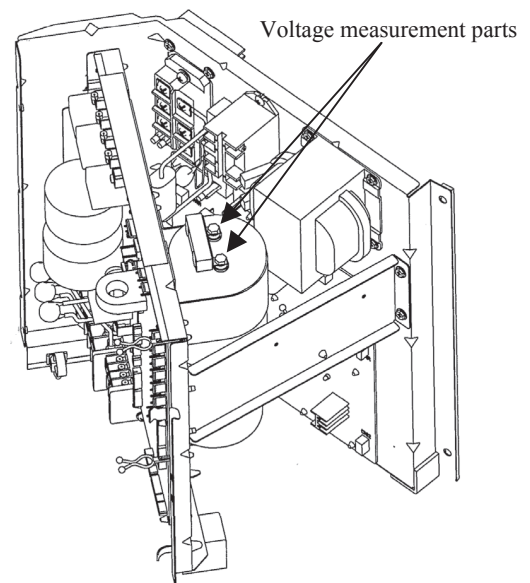
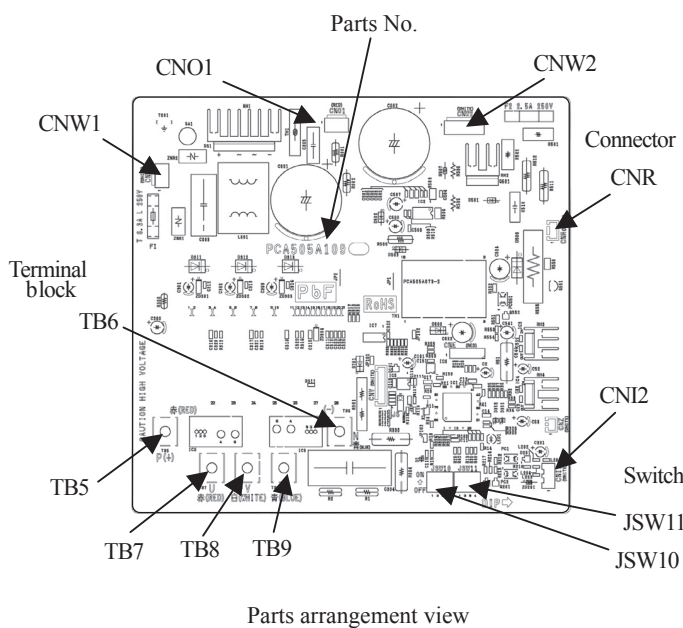



Table. 1 Switch setting (For service code blank, A, B)

JSW10	-1	OFF	JSW11	-1	OFF
	-2	OFF		-2	ON
	-3	OFF		-3	OFF
	-4	OFF		-4	ON

Table. 2 Switch setting (For service code C or later)

JSW10	-1	OFF	JSW11	-1	OFF
	-2	ON		-2	OFF
	-3	OFF		-3	ON
	-4	OFF		-4	OFF

3) Model FDC200VS, 250VS

PCB012D007C 

- a) Replace the inverter PCB after 10 minutes from power OFF. (Be sure to check that LED (LED1,2) of the inverter PCB put out the lights. It measures that the voltage (AC) between terminals (R,S,T) on the noise filter PCB (see Fig 1) is discharged sufficiently.)
 - b) Remove the terminal on the terminal block (TB2) of the inverter PCB and the connector (CNR) of replace the PCB.
 - c) Make set switch (SW1,2) as shown in Table 1.
 - d) Connect the terminal of terminal block and the connector to the inverter PCB.
- ※Remove the short bar form the PCB before the replacement.
Connect it with P2-P3 pins of PCB after the replacement.

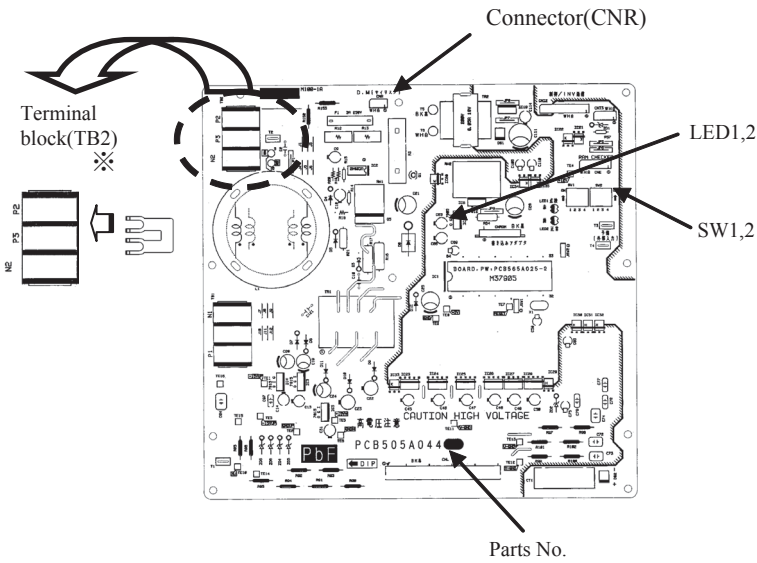

Parts Arrangement View
(the inverter PCB)

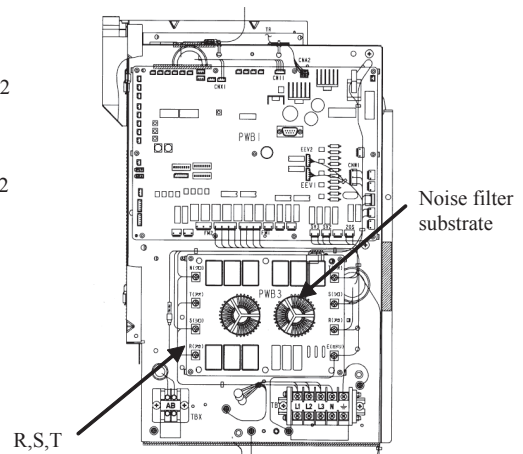

Fig. 1 The front of control

Table.1 Switch setting

In case of one substrate.

SW1-1	OFF
SW1-2	OFF
SW1-3	OFF
SW1-4	OFF
SW2-1	ON
SW2-2	OFF
SW2-3	OFF
SW2-4	OFF

● DIP switch setting list (Outdoor unit)

(1) Control PCB

Switches	Description		Default setting		Remarks
SW1	Pump down operation	Normal*/Pump down	OFF	Normal	
JSW1-1	Model selection		As per model		See table 1
JSW1-2					
JSW1-3					
JSW1-4					
SW3-1	Defrost condition	Normal*/Cold region	OFF	Normal	
SW3-2	Snow protection control	Normal*/Snow protection	OFF	Normal	
SW3-3	Test run SW	Normal*/Test run	OFF	Normal	
SW3-4	Test run mode	Cooling*/Heating	OFF	Cooling	
SW4-1	Model selection	Domestic/Overseas*	ON	Overseas	See table 1
SW4-2	Model selection	3-phase/Single phase	As per model		See table 1
SW4-3	Reserved		OFF		Keep OFF
SW4-4	Reserved		OFF		Keep OFF
SW5-1	Reserved		OFF		Keep OFF
SW5-2	Reserved		OFF		Keep OFF
SW5-3	Reserved		OFF		Keep OFF
SW5-4	Reserved		OFF		Keep OFF

* Default setting

Table 1: Outdoor unit model selection with JSW1-1-JSW1-4 and SW4-1-SW4-2

	0: OFF 1: ON							
	100VN	100VS	125VN	125VS	140VN	140VS	200VS	250VS
JSW1-1	0	0	1	1	0	0	1	0
JSW1-2	0	0	0	0	1	1	1	0
JSW1-3	0	0	0	0	0	0	0	1
JSW1-4	0	0	0	0	0	0	0	0
SW4-1	1	1	1	1	1	1	1	1
SW4-2*	1	0	1	0	1	0	0	0

* 3-phase: OFF/Single phase: ON

(2) Inverter PCB

Switches	100, 125, 140VN	100, 125, 140VS	Switches	200,250VS
	Single phase models	3-phase models		3-phase models
JSW10-1	OFF	OFF	SW1-1	OFF
JSW10-2	OFF	OFF	SW1-2	OFF
JSW10-3	OFF	OFF	SW1-3	OFF
JSW10-4	OFF *	OFF *	SW1-4	OFF
JSW11-1	ON	OFF	SW2-1	ON
JSW11-2	OFF	ON	SW2-2	OFF
JSW11-3	OFF	OFF	SW2-3	OFF
JSW11-4	ON	ON	SW2-4	OFF

* When checking inverter PCB of FDC100-140 models with inverter checker, turn JSW10-4 ON.

(Regarding the checking method of inverter PCB with inverter checker, refer to page 362 for details)

(5) Check of anomalous operation data with the remote control

(a) In case of RC-EX1A remote control

[Operating procedure]

① On the TOP screen, touch the buttons in the order of “Menu” → “Next” → “Service & Maintenance” → “Service password” → “Set” → “Error display” → “Error history”.

② When only one indoor unit is connected to the remote control, followings will be displayed.

1. When there is any anomaly: “Loading. Wait a while” is displayed, followed by the operation data at the occurrence of anomaly.

Contents of display

- Error code
- Number and data item

2. When there is no anomaly: “No anomaly” is displayed, and this mode is terminated.

③ When two or more indoor units are connected to the remote control, followings will be displayed.

1. When there is any anomaly: If the unit having anomaly is selected on the “Select IU” screen, “Loading. Wait a while” is displayed, followed by the operation data at the occurrence of anomaly.

Contents of display

- Indoor unit No.
- Error code
- Number and data item

2. When there is no anomaly: “No anomaly” is displayed, and this mode is terminated.

Note (1) When the number of connected units cannot be shown in a page, select “Next”.

④ If you press [RUN/STOP] button, the display returns to the TOP screen.

◎ **If you touch “Back” button on the way of setting, the display returns to the last precious screen.**

Note (1) When two remote controls are used to control indoor units, the check of anomaly operation data can be made on the master remote control only. (It cannot be operated from the slave remote control.)

■ Anomaly operation data (Corresponding data may not be provided depending on models. Such items will not be displayed.)

Number		Data Item
01	✳	(Operation Mode)
02	SET TEMP	(Set Temperature)
03	RETURN AIR	(Return Air Temperature)
04	SENSOR	(Remote Control Thermistor Temperature)
05	THI-R1	(Indoor Heat Exchanger Thermistor / U Bend)
06	THI-R2	(Indoor Heat Exchanger Thermistor / Capillary)
07	THI-R3	(Indoor Heat Exchanger Thermistor / Gas Header)
08	I/U FANSPEED	(Indoor Unit Fan Speed)
09	DEMAND	Hz (Frequency Requirements)
10	ANSWER	Hz (Response Frequency)
11	I/U EEV	P (Pulse of Indoor Unit Expansion Valve)
12	TOTAL I/U RUN	H (Total Running Hours of The Indoor Unit)
21	OUTDOOR	(Outdoor Air Temperature)
22	THO-R1	(Outdoor Heat Exchanger Thermistor)
23	THO-R2	(Outdoor Heat Exchanger Thermistor)
24	COMP	Hz (Compressor Frequency)
25	HP	MPa (High Pressure)
26	LP	MPa (Low Pressure)
27	Td	(Discharge Pipe Temperature)
28	COMP BOTTOM	(Comp Bottom Temperature)
29	CT	AMP (Current)
30	TARGET SH	(Target Super Heat)
31	SH	(Super Heat)
32	TDSH	(Discharge Pipe Super Heat)
33	PROTECTION No.	(Protection State No. of The Compressor)
34	O/U FANSPEED	(Outdoor Unit Fan Speed)
35	ESH1	(ESH1 On/Off)
36	DEFROST	(Defrost Control On/Off)
37	TOTAL COMP RUN	H (Total Running Hours of The Compressor)
38	O/U EEV1	P (Pulse of The Outdoor Unit Expansion Valve EEVC)
39	O/U EEV2	P (Pulse of The Outdoor Unit Expansion Valve EEVH)

●Details of Compressor protection status No. 33

No.	Contents of display	In case of FDC71-140 refer to
"0"	Normal	
"1"	Discharge pipe temperature protection control	P.333, (6).(a).(i)
"2"	Discharge pipe temperature anomaly	P.333, (6).(a).(ii)
"3"	Current safe control of inverter primary current	P.334, (6).(g)
"4"	High pressure protection control	P.333, (6).(b).(i), (c).(i)
"5"	High pressure anomaly	P.333, (6).(b).(ii)
"6"	Low pressure protection control	P.334, (6).(e).(i)
"7"	Low pressure anomaly	P.334, (6).(e).(ii)
"8"	Anti-frost prevention control	P.335, (6).(k)
"9"	Current cut	P.334, (6).(g)
"10"	Power transistor protection control	P.335, (6).(h)
"11"	Power transistor anomaly (Overheat)	P.335, (6).(i)
"12"	Compression ratio control	P.334, (6).(f)
"13"	Spare	
"14"	Dewing prevention control	P.335, (6).(l)
"15"	Current safe control of inverter secondary current	P.334, (6).(g)
"16"	Stop by compressor rotor lock	
"17"	Stop by compressor startup failure	P.336, (6).(p)
"18"	Active filter anomaly	

Note(1) Operation data display on the remote control.

- Data is displayed until canceling the protection control.
- In case of multiple protections controlled, only the younger No. is displayed.

Note(2) Common item.

- ① In heating mode.
During protection control by the command signal for reducing compressor frequency from indoor unit, No. "4" is displayed.
- ② In cooling and dehumidifying mode.
During protection control by the command signal for reducing compressor frequency from indoor unit, No. "8" is displayed.

(b) In case of RC-E5 remote control

Operation data can be checked with remote control unit operation.

- ① Press the **CHECK** button.
The display change “OPER DATA ▼”
- ② Press the **(SET)** button while “OPER DATA ▼” is displayed.
- ③ When only one indoor unit is connected to remote control, “DATA LOADING” is displayed (blinking indication during data loading).
Next, operation data of the indoor unit will be displayed. Skip to step ⑦.
- ④ When plural indoor units is connected, the smallest address number of indoor unit among all connected indoor unit is displayed.

[Example]:

“SELECT I/U” (blinking 1 seconds) → “I/U000 ▲” blinking.

- ⑤ Select the indoor unit number you would like to have data displayed with the **▲ ▼** button.
- ⑥ Determine the indoor unit number with the **(SET)** button.
(The indoor unit number changes from blinking indication to continuous indication)
“I/U000” (The address of selected indoor unit is blinking for 2 seconds.)
↓
“DATA LOADING” (A blinking indication appears while data loaded.)

Next, the operation data of the indoor unit is indicated.

- ⑦ Upon operation of the **▲ ▼** button, the current operation data is displayed in order from data number 01.
The items displayed are in the above table.

*Depending on models, the items that do not have corresponding data are not displayed.

- ⑧ To display the data of a different indoor unit, press the **AIR CON NO.** button, which allows you to go back to the indoor unit selection screen.

- ⑨ Pressing the **ON/OFF** button will stop displaying data.

Pressing the **(RESET)** button during remote control unit operation will undo your last operation and allow you to go back to the previous screen.

⊙ If two (2) remote controls are connected to one (1) inside unit, only the master controller is available for trial operation and confirmation of operation data. (The slave remote control is not available.)

● Details of Compressor protection status No. 33

No.	Contents of display	In case of FDC71-140 refer to
"0"	Normal	
"1"	Discharge pipe temperature protection control	P.333, (6).(a).(i)
"2"	Discharge pipe temperature anomaly	P.333, (6).(a).(ii)
"3"	Current safe control of inverter primary current	P.334, (6).(g)
"4"	High pressure protection control	P.333, (6).(b).(i), (c).(i)
"5"	High pressure anomaly	P.333, (6).(b).(ii)
"6"	Low pressure protection control	P.334, (6).(c).(i)
"7"	Low pressure anomaly	P.334, (6).(c).(ii)
"8"	Anti-frost prevention control	P.335, (6).(k)
"9"	Current cut	P.334, (6).(g)
"10"	Power transistor protection control	P.335, (6).(h)
"11"	Power transistor anomaly (Overheat)	P.335, (6).(i)
"12"	Compression ratio control	P.334, (6).(f)
"13"	Spare	
"14"	Dewing prevention control	P.335, (6).(l)
"15"	Current safe control of inverter secondary current	P.334, (6).(g)
"16"	Stop by compressor rotor lock	
"17"	Stop by compressor startup failure	P.336, (6).(p)
"18"	Active filter anomaly	

Number	Data Item
01	(Operation Mode)
02	SET TEMP (Set Temperature)
03	RETURN AIR (Return Air Temperature)
04	SENSOR (Remote Control Thermistor Temperature)
05	THI-R1 (Indoor Heat Exchanger Thermistor / U Bend)
06	THI-R2 (Indoor Heat Exchanger Thermistor / Capillary)
07	THI-R3 (Indoor Heat Exchanger Thermistor / Gas Header)
08	I/U FANSPEED (Indoor Unit Fan Speed)
09	DEMAND Hz (Frequency Requirements)
10	ANSWER Hz (Response Frequency)
11	I/U EEV P (Pulse of Indoor Unit Expansion Value)
12	TOTAL I/U RUN H (Total Running Hours of The Indoor Unit)
21	OUTDOOR (Outdoor Air Temperature)
22	THO-R1 (Outdoor Heat Exchanger Thermistor)
23	THO-R2 (Outdoor Heat Exchanger Thermistor)
24	COMP Hz (Compressor Frequency)
25	HP MPa (High Pressure)
26	LP MPa (Low Pressure)
27	Td (Discharge Pipe Temperature)
28	COMP BOTTOM (Comp Bottom Temperature)
29	CT AMP (Current)
30	TARGET SH (Target Super Heat)
31	SH (Super Heat)
32	TDSH (Discharge Pipe Super Heat)
33	PROTECTION No. (Protection State No. of The Compressor)
34	O/U FANSPEED (Outdoor Unit Fan Speed)
35	63H1 (63H1 On/Off)
36	DEFROST (Defrost Control On/Off)
37	TOTAL COMP RUN H (Total Running Hours of The Compressor)
38	O/U EEV1 P (Pulse of The Outdoor Unit Expansion Valve EEVC)
39	O/U EEV2 P (Pulse of The Outdoor Unit Expansion Valve EEVH)

Note(1) Operation data display on the remote control.
 • Data is displayed until canceling the protection control.
 • In case of multiple protections controlled, only the younger No. is displayed.
 Note(2) Common item.
 ① In heating mode.
 During protection control by the command signal for reducing compressor frequency from indoor unit, No. "4" is displayed.
 ② In cooling and dehumidifying mode.
 During protection control by the command signal for reducing compressor frequency from indoor unit, No. "8" is displayed.

(6) Power transistor module (including the driver PCB) inspection procedure

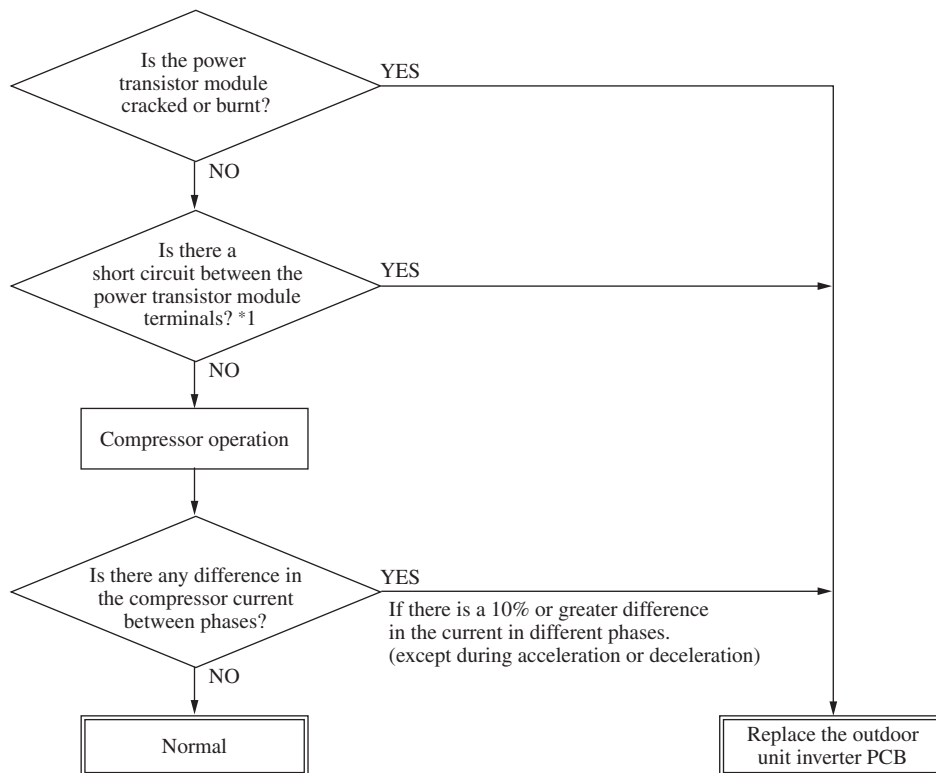

Note(1) In models 200 and 250, also replace the power transistor.

*1 Power transistor module terminal short circuit check procedure

Disconnect the compressor wiring, then conduct a short circuit check.

P-U, P-V, P-W

N-U, N-V, N-W

Check between the P-N terminals.

Bring the tester probes in contact with the following places on each terminal.

P: Power transistor P terminal,

N: Power transistor N terminal,

U: End of red harness to compressor

V: End of white harness to compressor

W: End of black or blue harness to compressor

Check for a power transistor short circuit.

- When you do not have a diagnostic checker for judging if the inverter is defective, measure between the terminals of the power transistor parts, judge whether the power transistor is defective or not.
- Disconnect the compressor, then measure with the controller incorporated.

Tester		Normal values (Ω)	
Terminal (+)	Terminal (-)	Model 100-140	Model 200, 250
P	N	Approx. 1 M Approx. 300-400	Scores of M
N	P		A few of M
P	U	0	Scores of M
P	V		Scores of M
P	W		Scores of M
N	U	Approx. 1.2 M	Hundreds of K
N	V		Hundreds of K
N	W		Hundreds of K
U	P	Approx. 1.3 M	Hundreds of K
V	P		Hundreds of K
W	P		Hundreds of K
U	N	0	Scores of M
V	N		Scores of M
W	N		Scores of M

If the measured values range from 0 ~ several kW, there is a possibility that the elements are damaged, so replace the power transistor parts.

(7) Inverter checker for diagnosis of inverter output

● Checking method

(a) Setup procedure of checker.

- 1) Power OFF (Turn off the breaker).
- 2) Remove the terminal cover of compressor and disconnect the wires (U, V, W) from compressor.
- 3) Connect the wires U (Red), V (White) and W (Black) of checker to the terminal of disconnected wires (U, V, W) from compressor respectively.

(b) Operation for judgment.

- 1) Power ON after JSW10-4 on outdoor inverter PCB was turned ON. (In case of FDC100-140)
 * In case of FDC200VS and 250VS, Start test operation on cooling or heating mode after power ON.
- 2) After 15 seconds since power has turned ON (or In case of FDC200VS, 250VS after the test operation started), LED start ON/OFF for 5 seconds cyclically and it repeats 10 times.
- 3) Check ON/OFF status of 6 LED's on the checker.
- 4) Judge the PCB by ON/OFF status of 6 LED's on the checker.

ON/OFF status of LED	If all of LED are ON/OFF according to following pattern	If all of LED stay OFF or some of LED are ON/OFF
Inverter PCB	Normal	Anomalous

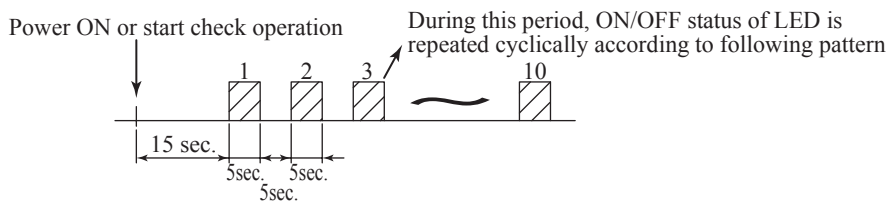

- 5) Be sure to turn off JSW10-4 on outdoor inverter PCB, after finishing the check operation. (In case of FDC100-140)

<Inverter checker>

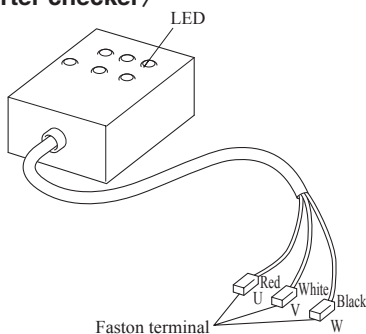

LED ON/OFF pattern

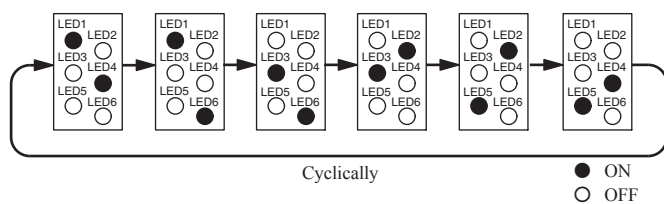

Connect to the terminal of the wires which are disconnected from compressor.

Models FDC100,125,140VN

●Outdoor unit check points

Check items with the *mark when the power is ON.

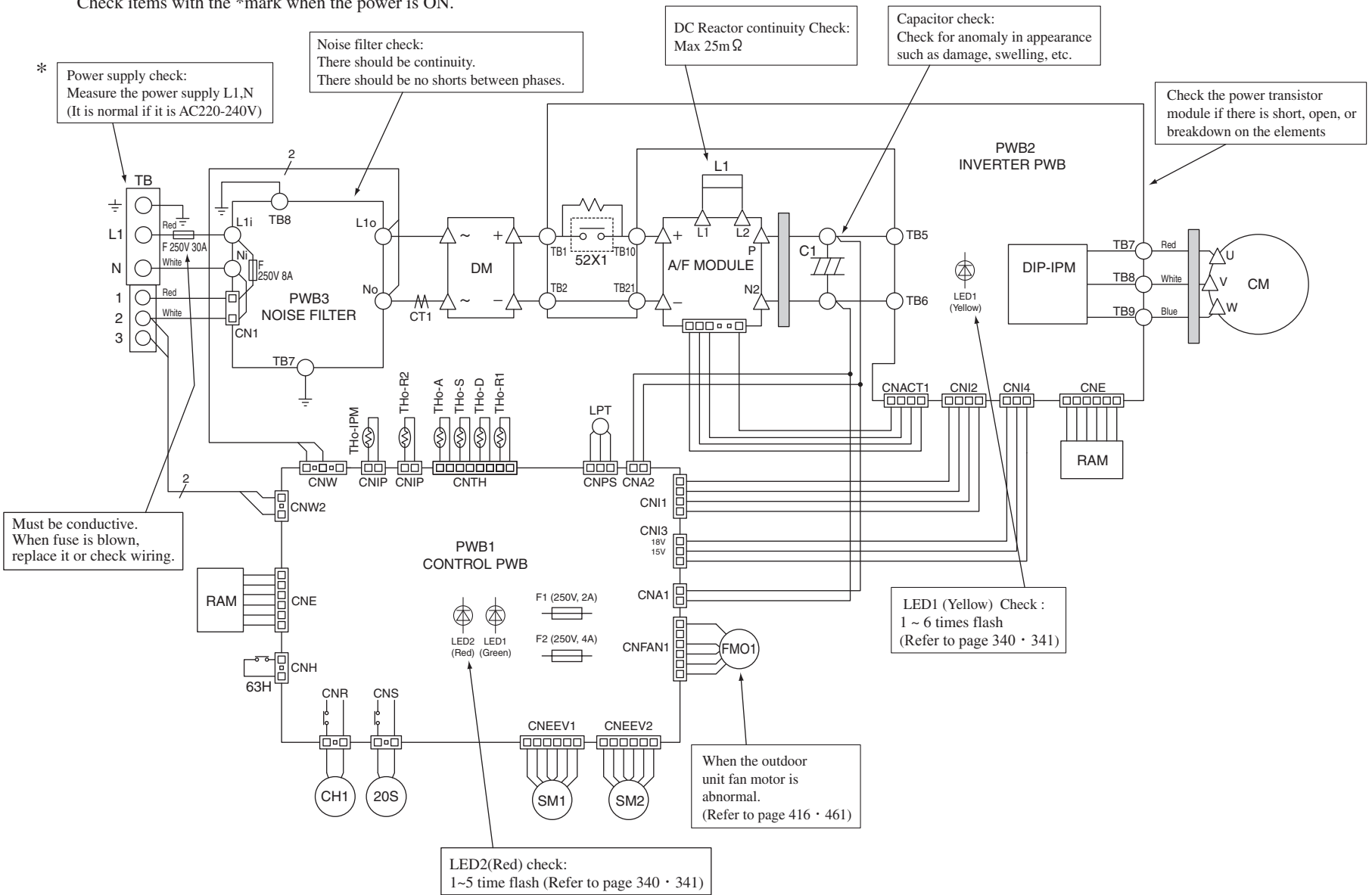

FDC100,125,140VS

Outdoor unit check points

Check items with the *mark when the power is ON.

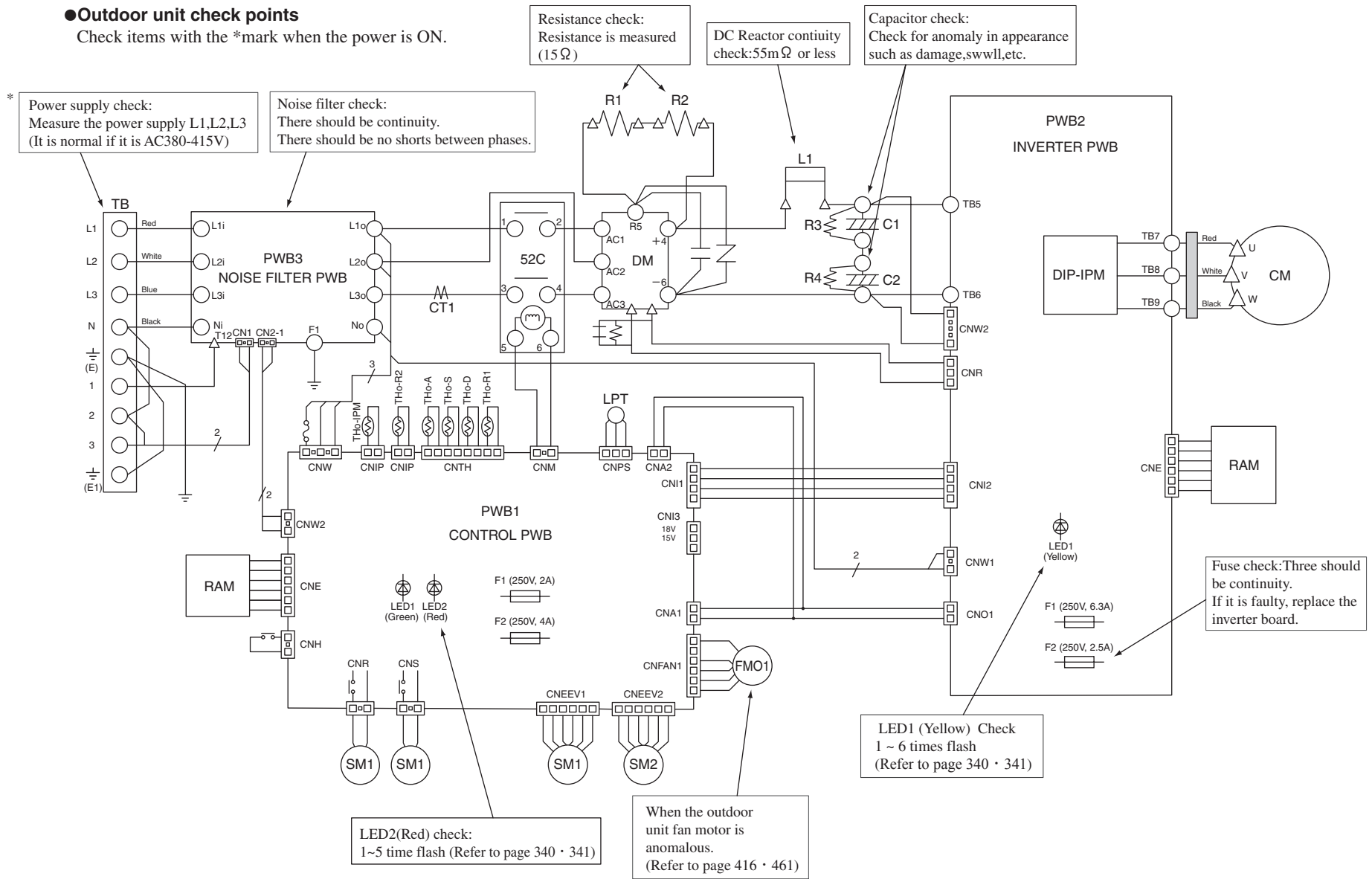

Models FDC200,250VS

●Outdoor unit check points

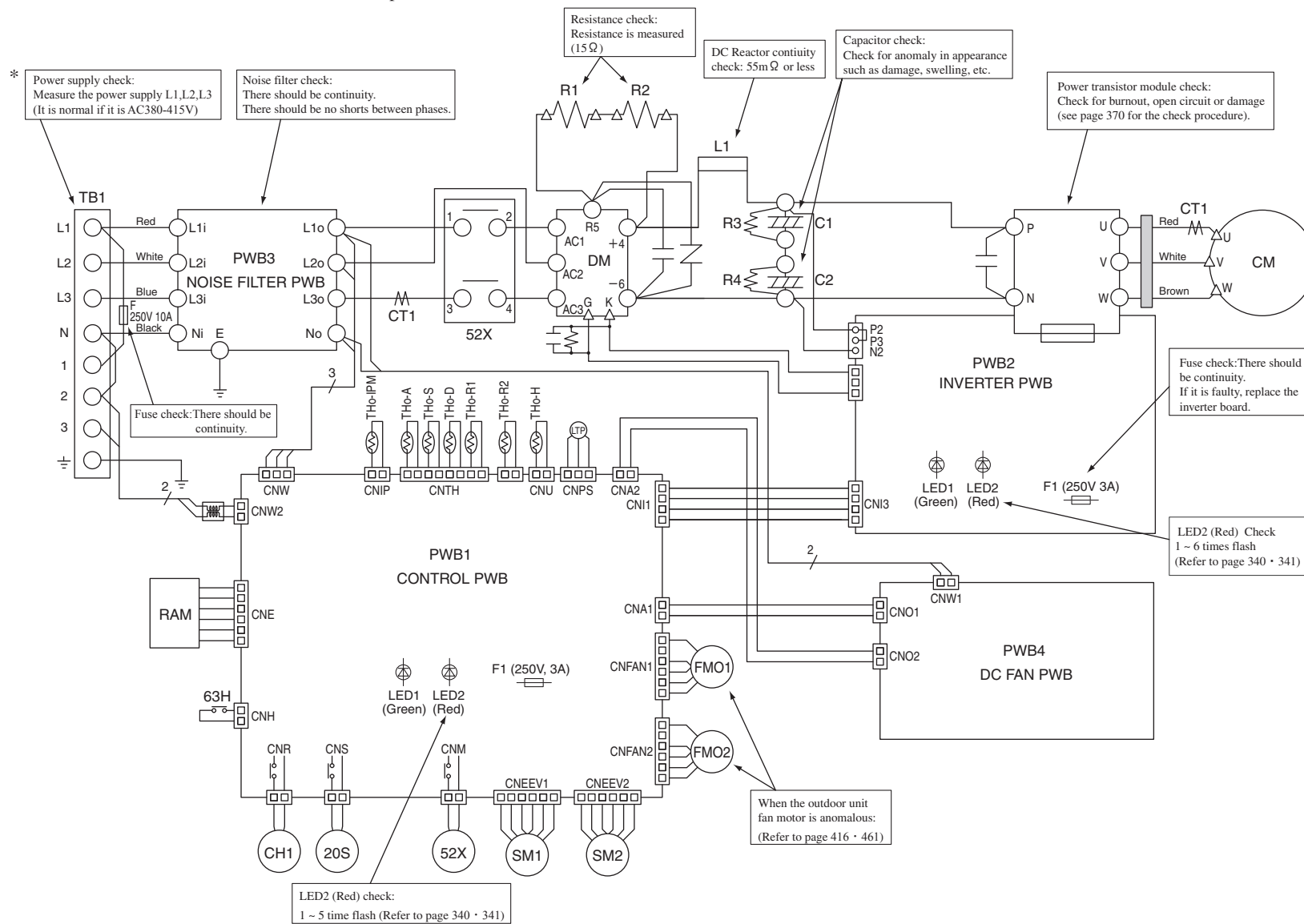

Check items with the *mark when the power is ON.



1.12.2 Troubleshooting flow

(1) List of troubles

(a) FDT, FDTC, FDEN, FDU, FDUM, FDF series

Remote control display	Description of trouble	Reference page
None	Operates but does not cool.	375
None	Operates but does not heat.	376
None	Earth leakage breaker activated	377
None	Excessive noise/vibration (1/3)	378
None	Excessive noise/vibration (2/3)	379
None	Excessive noise/vibration (3/3)	380
None	Louver motor failure (FDT, FDTC, FDEN, FDF series)	381
None	Power supply system error (Power supply to indoor control PCB)	382
None	Power supply system error (Power supply to remote control)	383
INSPECT I/U	INSPECT I/U (When 1 or 2 remote controls are connected)	384
INSPECT I/U	INSPECT I/U (Connection of 3 units or more remote controls)	385
 WAIT 	Communication error at initial operation	386-388
None	No display	389
E1	Remote control communication circuit error	390
E5	Communication error during operation	391
E6	Indoor heat exchanger temperature thermistor anomaly	392
E7	Return air temperature thermistor anomaly	393
E8	Heating overload operation	394
E9	Drain trouble	395
E10	Excessive number of connected indoor units (more than 17 units) by controlling with one remote control	396
E11	Address setting error of indoor units	397
E14	Communication error between master and slave indoor units	498
E16	Indoor fan motor anomaly	499
E18	Address setting error of master and slave indoor unit	400
E19	Indoor unit operation check, drain motor check setting error	401
E20	Indoor fan motor rotation speed anomaly	402
E21	Defective panel switch operation (FDT only)	403
E28	Remote control temperature thermistor anomaly	404
E35	Cooling overload operation	405
E36	Discharge pipe temperature error	406
E37	Outdoor heat exchanger temperature thermistor anomaly	407
E38	Outdoor air temperature thermistor anomaly	408
E39	Discharge pipe temperature thermistor anomaly	409
E40	High pressure error (63H1 activated)	410
E41	Power transistor overheat	411 • 412
E42	Current cut	413 • 414
E45	Inverter communication error	415
E48	Outdoor fan motor anomaly	416
E49	Low pressure error or low pressure sensor anomaly	417 • 418
E51	Inverter and fan motor anomaly	419
E53	Suction pipe temperature thermistor anomaly	420
E54	Low pressure sensor anomaly	421
E55	Underneath temperature thermistor anomaly (Models FDC 200, 250 only)	422
E57	Insufficient refrigerant amount or detection of service valve closure	423
E59	Compressor startup failure	424 • 425
E60	Anomalous compressor rotor lock (Models FDC 200, 250 only)	426

(b) SRK series

Remote control display	Description of trouble	Reference page
None	Operates but does not cool.	427
None	Operates but does not heat.	428
None	Earth leakage breaker activated	429
None	Excessive noise/vibration (1/3)	430
None	Excessive noise/vibration (2/3)	431
None	Excessive noise/vibration (3/3)	432
None	Louver motor failure	433
None	Power supply system error (Power supply to indoor control PCB)	434
None	Power supply system error (Power supply to remote control)	435
None	Limit switch anomaly	436
INSPECT I/U	INSPECT I/U (When 1 or 2 remote controls are connected)	437
INSPECT I/U	INSPECT I/U (Connection of 3 units or more remote controls)	438
🔊WAIT🔊	Communication error at initial operation	439-441
None	No display	442
E1	Remote control communication circuit error	443
E5	Communication error during operation	444
E6	Indoor heat exchanger temperature sensor anomaly	445
None	Room temperature sensor anomaly	446
E10	Excessive number of connected indoor units (more than 17 units) by controlling with one remote control	447
E14	Communication error between master and slave indoor units	448
E16	Indoor fan motor anomaly	449
E28	Remote control temperature thermistor anomaly	450
E35	Cooling overload operation	451
E36	Discharge pipe temperature error	452
E37	Outdoor heat exchanger temperature thermistor anomaly	453
E38	Outdoor air temperature thermistor anomaly	454
E39	Discharge pipe temperature thermistor anomaly	455
E40	High pressure error (63H1 activated)	456
E41	Power transistor overheat	457
E42	Current cut	458 • 459
E45	Communication error between inverter PCB and outdoor control PCB	460
E48	Outdoor fan motor anomaly	461
E49	Low pressure error or low pressure sensor anomaly	462 • 463
E51	Inverter and fan motor anomaly	464
E53	Suction pipe temperature thermistor anomaly	465
E54	Low pressure sensor anomaly	466
E57	Insufficient refrigerant amount or detection of service valve closure	467
E59	Compressor startup failure	468 • 469

(2) Troubleshooting

(a) FDT, FDTC, FDEN, FDU, FDUM, FDF series

Error code Remote control: None	LED	Green	Red	Content Operates but does not cool
	Indoor	Keeps flashing	Stays OFF	
	Outdoor	Keeps flashing	Stays OFF	

1. Applicable model
All models
2. Error detection method
3. Condition of Error displayed
4. Presumable cause
<ul style="list-style-type: none"> Poor compression of compressor Faulty expansion valve operation

5. Troubleshooting				
<table border="1"> <thead> <tr> <th>Diagnosis</th> <th>Countermeasure</th> </tr> </thead> <tbody> <tr> <td> <p>Check the indoor unit fan operation. Check the temperature difference between return and supply air.</p> <p>Is the temperature difference between return and supply air 10-20°C at cooling?</p> <p>NO</p> <p>Is the compressor operating?</p> <p>NO</p> <p>Is the compressor rotation speed low?</p> <p>NO</p> <p>Check which control "Determination control of compressor rotation speed" or "Protective control by controlling compressor rotation speed" is appropriate to this phenomenon.</p> <p>Are the temperature conditions of room and outdoor air close to the rated conditions? (1)</p> <p>NO</p> <p>The unit is operating normally but is operating under the control for protecting compressor or other respective parts.</p> </td> <td> <p>It is normal. (This unit is designed to start in the soft start mode by detecting the under dome temperature of compressor when it restart after power reset.)</p> <p>It is necessary to replace to higher capacity one or to install additional unit.</p> <p>Compressor refrigerant oil protection control at starting is activated. For the contents of control, refer to the compressor start control of the microcomputer control functions.</p> <p>Compressor may be stopped by the error detection control. For the contents of control, refer to anomalous stop control by controlling compressor rotation speed of microcomputer control functions.</p> <p>Inspect the followings.</p> <ul style="list-style-type: none"> Minor clogging of filter Minor clogging of heat exchanger Minor short-circuit Minor shortage of refrigerant amount Poor compression of compressor <p>Considering appropriate operation control, check suspicious points. Inspect the followings for reference.</p> <ul style="list-style-type: none"> Major clogging of filter Major clogging of heat exchanger Major short-circuit Major shortage of refrigerant amount Compressor protection ON Indoor fan tap Valid setting of silent mode </td> </tr> </tbody> </table>	Diagnosis	Countermeasure	<p>Check the indoor unit fan operation. Check the temperature difference between return and supply air.</p> <p>Is the temperature difference between return and supply air 10-20°C at cooling?</p> <p>NO</p> <p>Is the compressor operating?</p> <p>NO</p> <p>Is the compressor rotation speed low?</p> <p>NO</p> <p>Check which control "Determination control of compressor rotation speed" or "Protective control by controlling compressor rotation speed" is appropriate to this phenomenon.</p> <p>Are the temperature conditions of room and outdoor air close to the rated conditions? (1)</p> <p>NO</p> <p>The unit is operating normally but is operating under the control for protecting compressor or other respective parts.</p>	<p>It is normal. (This unit is designed to start in the soft start mode by detecting the under dome temperature of compressor when it restart after power reset.)</p> <p>It is necessary to replace to higher capacity one or to install additional unit.</p> <p>Compressor refrigerant oil protection control at starting is activated. For the contents of control, refer to the compressor start control of the microcomputer control functions.</p> <p>Compressor may be stopped by the error detection control. For the contents of control, refer to anomalous stop control by controlling compressor rotation speed of microcomputer control functions.</p> <p>Inspect the followings.</p> <ul style="list-style-type: none"> Minor clogging of filter Minor clogging of heat exchanger Minor short-circuit Minor shortage of refrigerant amount Poor compression of compressor <p>Considering appropriate operation control, check suspicious points. Inspect the followings for reference.</p> <ul style="list-style-type: none"> Major clogging of filter Major clogging of heat exchanger Major short-circuit Major shortage of refrigerant amount Compressor protection ON Indoor fan tap Valid setting of silent mode
Diagnosis	Countermeasure			
<p>Check the indoor unit fan operation. Check the temperature difference between return and supply air.</p> <p>Is the temperature difference between return and supply air 10-20°C at cooling?</p> <p>NO</p> <p>Is the compressor operating?</p> <p>NO</p> <p>Is the compressor rotation speed low?</p> <p>NO</p> <p>Check which control "Determination control of compressor rotation speed" or "Protective control by controlling compressor rotation speed" is appropriate to this phenomenon.</p> <p>Are the temperature conditions of room and outdoor air close to the rated conditions? (1)</p> <p>NO</p> <p>The unit is operating normally but is operating under the control for protecting compressor or other respective parts.</p>	<p>It is normal. (This unit is designed to start in the soft start mode by detecting the under dome temperature of compressor when it restart after power reset.)</p> <p>It is necessary to replace to higher capacity one or to install additional unit.</p> <p>Compressor refrigerant oil protection control at starting is activated. For the contents of control, refer to the compressor start control of the microcomputer control functions.</p> <p>Compressor may be stopped by the error detection control. For the contents of control, refer to anomalous stop control by controlling compressor rotation speed of microcomputer control functions.</p> <p>Inspect the followings.</p> <ul style="list-style-type: none"> Minor clogging of filter Minor clogging of heat exchanger Minor short-circuit Minor shortage of refrigerant amount Poor compression of compressor <p>Considering appropriate operation control, check suspicious points. Inspect the followings for reference.</p> <ul style="list-style-type: none"> Major clogging of filter Major clogging of heat exchanger Major short-circuit Major shortage of refrigerant amount Compressor protection ON Indoor fan tap Valid setting of silent mode 			

Note:

Error code Remote control: None	LED	Green	Red	Content Operates but does not heat
	Indoor	Keeps flashing	Stays OFF	
	Outdoor	Keeps flashing	Stays OFF	

1. Applicable model
All models
2. Error detection method
3. Condition of Error displayed
4. Presumable cause
<ul style="list-style-type: none"> Faulty 4-way valve operation Poor compression of compressor Faulty expansion valve operation

5. Troubleshooting				
<table border="1"> <thead> <tr> <th>Diagnosis</th> <th>Countermeasure</th> </tr> </thead> <tbody> <tr> <td> <p>Check the indoor unit fan operation. Check the temperature difference between return and supply air.</p> <p>Is the temperature difference between return and supply air 10-30°C at heating?</p> <p>YES → Does the heat load increase after installation?</p> <p>NO →</p> <p>YES → Mistake in model selection. Calculate heat load once again.</p> <p>Is the compressor operating?</p> <p>NO → "WAIT" message is displayed (for 3 seconds) when performing cooling, defrosting and heating operations from the remote control.</p> <p>YES →</p> <p>NO →</p> <p>Is the compressor rotation speed low?</p> <p>NO →</p> <p>YES → Check which control "Determination control of compressor rotation speed" or "Protective control by controlling compressor rotation speed" is appropriate to this phenomenon.</p> <p>Are the temperature conditions of room and outdoor air close to the rated conditions? (1)</p> <p>YES →</p> <p>NO → The unit is operating normally but is operating under the control for protecting compressor or other respective parts.</p> <p>Note (1) Outdoor: 7°C, Indoor: 20°C</p> </td> <td> <p>It is normal. (This unit is designed to start in the soft start mode by detecting the under dome temperature of compressor when it restart after power reset.)</p> <p>It is necessary to replace to higher capacity one or to install additional unit.</p> <p>Compressor refrigerant oil protection control at starting is activated. For the contents of control, refer to the compressor start control of the microcomputer control functions.</p> <p>Compressor may be stopped by the error detection control. For the contents of control, refer to anomalous stop control by controlling compressor rotation speed of microcomputer control functions.</p> <p>Inspect the followings.</p> <ul style="list-style-type: none"> Minor clogging of filter Minor clogging of heat exchanger Minor short-circuit Minor shortage of refrigerant amount Poor compression of compressor <p>Considering appropriate operation control, check suspicious points. Inspect the followings for reference.</p> <ul style="list-style-type: none"> Major clogging of filter Major clogging of heat exchanger Major short-circuit Major shortage of refrigerant amount Compressor protection ON Indoor fan tap Valid setting of silent mode </td> </tr> </tbody> </table>	Diagnosis	Countermeasure	<p>Check the indoor unit fan operation. Check the temperature difference between return and supply air.</p> <p>Is the temperature difference between return and supply air 10-30°C at heating?</p> <p>YES → Does the heat load increase after installation?</p> <p>NO →</p> <p>YES → Mistake in model selection. Calculate heat load once again.</p> <p>Is the compressor operating?</p> <p>NO → "WAIT" message is displayed (for 3 seconds) when performing cooling, defrosting and heating operations from the remote control.</p> <p>YES →</p> <p>NO →</p> <p>Is the compressor rotation speed low?</p> <p>NO →</p> <p>YES → Check which control "Determination control of compressor rotation speed" or "Protective control by controlling compressor rotation speed" is appropriate to this phenomenon.</p> <p>Are the temperature conditions of room and outdoor air close to the rated conditions? (1)</p> <p>YES →</p> <p>NO → The unit is operating normally but is operating under the control for protecting compressor or other respective parts.</p> <p>Note (1) Outdoor: 7°C, Indoor: 20°C</p>	<p>It is normal. (This unit is designed to start in the soft start mode by detecting the under dome temperature of compressor when it restart after power reset.)</p> <p>It is necessary to replace to higher capacity one or to install additional unit.</p> <p>Compressor refrigerant oil protection control at starting is activated. For the contents of control, refer to the compressor start control of the microcomputer control functions.</p> <p>Compressor may be stopped by the error detection control. For the contents of control, refer to anomalous stop control by controlling compressor rotation speed of microcomputer control functions.</p> <p>Inspect the followings.</p> <ul style="list-style-type: none"> Minor clogging of filter Minor clogging of heat exchanger Minor short-circuit Minor shortage of refrigerant amount Poor compression of compressor <p>Considering appropriate operation control, check suspicious points. Inspect the followings for reference.</p> <ul style="list-style-type: none"> Major clogging of filter Major clogging of heat exchanger Major short-circuit Major shortage of refrigerant amount Compressor protection ON Indoor fan tap Valid setting of silent mode
Diagnosis	Countermeasure			
<p>Check the indoor unit fan operation. Check the temperature difference between return and supply air.</p> <p>Is the temperature difference between return and supply air 10-30°C at heating?</p> <p>YES → Does the heat load increase after installation?</p> <p>NO →</p> <p>YES → Mistake in model selection. Calculate heat load once again.</p> <p>Is the compressor operating?</p> <p>NO → "WAIT" message is displayed (for 3 seconds) when performing cooling, defrosting and heating operations from the remote control.</p> <p>YES →</p> <p>NO →</p> <p>Is the compressor rotation speed low?</p> <p>NO →</p> <p>YES → Check which control "Determination control of compressor rotation speed" or "Protective control by controlling compressor rotation speed" is appropriate to this phenomenon.</p> <p>Are the temperature conditions of room and outdoor air close to the rated conditions? (1)</p> <p>YES →</p> <p>NO → The unit is operating normally but is operating under the control for protecting compressor or other respective parts.</p> <p>Note (1) Outdoor: 7°C, Indoor: 20°C</p>	<p>It is normal. (This unit is designed to start in the soft start mode by detecting the under dome temperature of compressor when it restart after power reset.)</p> <p>It is necessary to replace to higher capacity one or to install additional unit.</p> <p>Compressor refrigerant oil protection control at starting is activated. For the contents of control, refer to the compressor start control of the microcomputer control functions.</p> <p>Compressor may be stopped by the error detection control. For the contents of control, refer to anomalous stop control by controlling compressor rotation speed of microcomputer control functions.</p> <p>Inspect the followings.</p> <ul style="list-style-type: none"> Minor clogging of filter Minor clogging of heat exchanger Minor short-circuit Minor shortage of refrigerant amount Poor compression of compressor <p>Considering appropriate operation control, check suspicious points. Inspect the followings for reference.</p> <ul style="list-style-type: none"> Major clogging of filter Major clogging of heat exchanger Major short-circuit Major shortage of refrigerant amount Compressor protection ON Indoor fan tap Valid setting of silent mode 			

Note:

Error code Remote control: None	LED	Green	Red	Content Earth leakage breaker activated
	Indoor	Stays OFF	Stays OFF	
	Outdoor	Stays OFF	Stays OFF	

1. Applicable model
All models

2. Error detection method

3. Condition of Error displayed

4. Presumable cause
<ul style="list-style-type: none"> • Defective compressor • Noise

5. Troubleshooting	
Diagnosis	Countermeasure
<pre> graph TD D1{Are OK the insulation resistance and coil resistance of compressor?} -- NO --> C1[Replace compressor.*] D1 -- YES --> D2{Is insulation of respective harnesses OK? Is any harness bitten between pannel and casing or etc?} D2 -- NO --> C2[Secure insulation resistance.] D2 -- YES --> P1[Check the outdoor unit grounding wire/earth leakage breaker.] </pre>	
<p>Check of the outdoor unit grounding wire/earth leakage breaker</p> <p>① Run an independent grounding wire from the grounding screw of outdoor unit to the grounding terminal on the distribution panel. (Do not connect to another grounding wire.)</p> <p>② In order to prevent malfunction of the earth leakage breaker itself, confirm that it is conformed to higher harmonic regulation.</p> <p>* Insulation resistance of compressor</p> <ul style="list-style-type: none"> • Immediately after installation or when the unit has been left for long time without power supply, the insulation resistance may drop to a few MΩ because of refrigerant migrated in the compressor. <p>When the earth breaker is activated at lower insulation resistance, check the following points.</p> <p>① 6 hours after power ON, check if the insulation resistance recovers to normal.</p> <p>When power ON, crankcase heater heat up compressor and evaporate the refrigerant migrated in the compressor.</p> <p>② Check if the earth leakage breaker is conformed to higher harmonic regulation or not.</p> <p>Since the unit is equipped with inverter, it is necessary to use components conformed to higher harmonic regulation in order to prevent malfunction of earth leakage breaker.</p>	

Note:

Error code Remote control: None	LED	Green	Red	Content Excessive noise/vibration (1/3)
	Indoor	—	—	
	Outdoor	—	—	

1. Applicable model
All models

2. Error detection method

3. Condition of Error displayed

- 4. Presumable cause**
- ① Improper installation work
 - Improper anti-vibration work at installation
 - Insufficient strength of mounting face
 - ② Defective product
 - Before/after shipping from factory
 - ③ Improper adjustment during commissioning
 - Excess/shortage of refrigerant, etc.

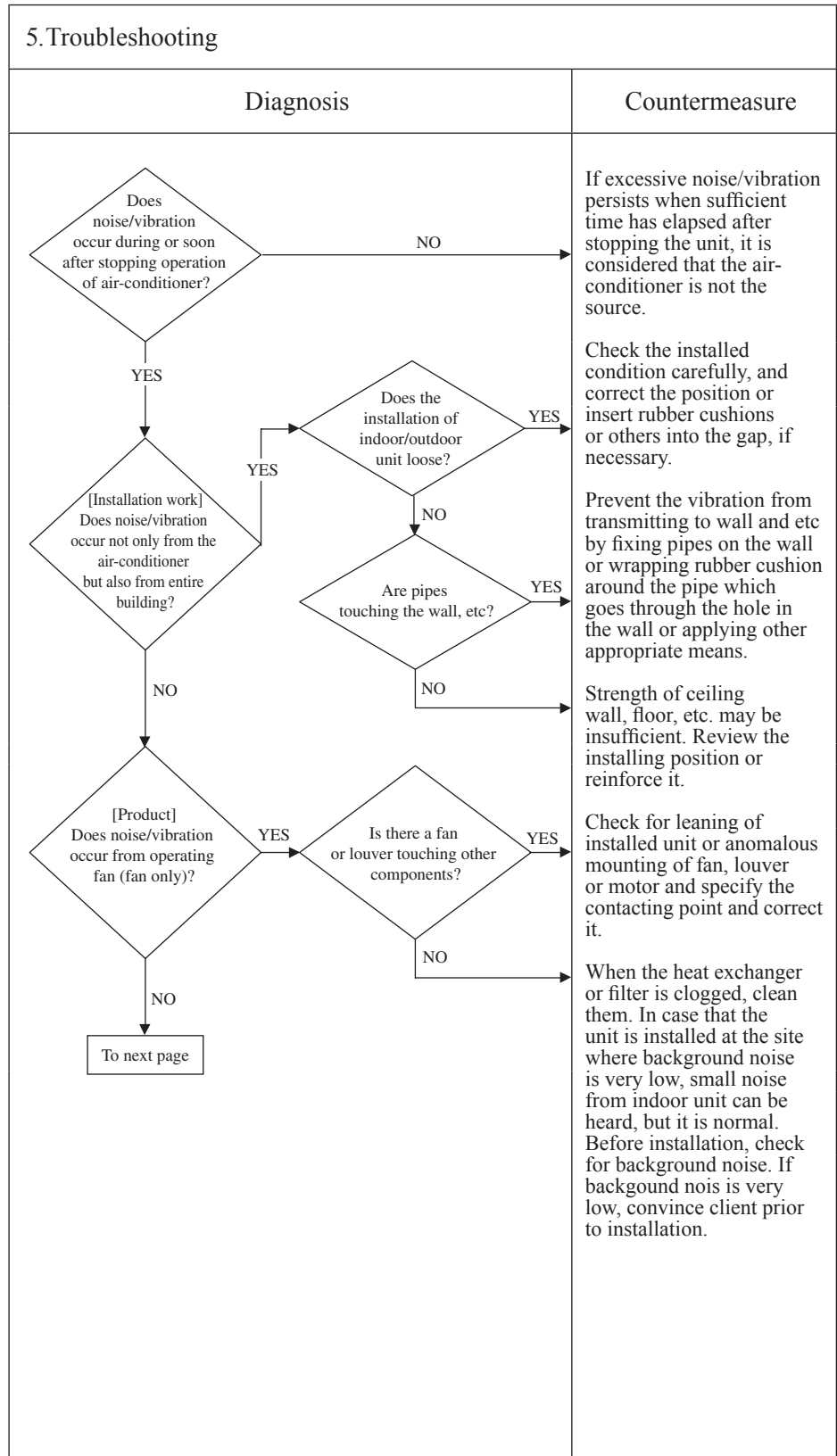

Note:

Error code Remote control: None	LED	Green	Red	Content Excessive noise/vibration (2/3)
	Indoor	—	—	
	Outdoor	—	—	

1. Applicable model
All models
2. Error detection method
3. Condition of Error displayed
4. Presumable cause

5. Troubleshooting	
Diagnosis	Countermeasure

Note:

Error code Remote control: None	LED	Green	Red	Content Excessive noise/vibration (3/3)
	Indoor	–	–	
	Outdoor	–	–	

<p>1. Applicable model</p> <p>All models</p>	5. Troubleshooting	
<p>2. Error detection method</p>	Diagnosis	Countermeasure
<p>3. Condition of Error displayed</p>	<pre> graph TD A[From previous page] --> B{Adjustment during commissioning Does noise/vibration occur when the cooling/heating operation is in anomalous condition?} B -- YES --> C[Countermeasure] </pre>	
<p>4. Presumable cause</p>	<p>If insufficient cooling/heating problem happens due to anomalous operating conditions at cooling/heating, followings are suspicious.</p> <ul style="list-style-type: none"> • Overcharge of refrigerant • Insufficient charge of refrigerant • Intrusion of air, nitrogen, etc. <p>In such occasion, it is necessary to recover refrigerant, vacuum-dry and recharge refrigerant.</p> <p>* Since there could be many causes of noise/vibration, the above do not cover all. In such case, check the conditions when, where, how the noise/vibration occurs according to following check point.</p> <ul style="list-style-type: none"> • Indoor/outdoor unit • Cooling/heating/fan mode • Startup/stop/during operation • Operating condition (Indoor/outdoor temperatures, pressure) • Time it occurred • Operation data retained by the remote control such as compressor rotation speed, heat exchanger temperature, EEV opening degree, etc. • Tone (If available, record the noise) • Any other anomalies 	

Note:

Error code Remote control: None	LED	Green	Red	Content Louver motor failure (FDT, FDTC, FDEN, FDF series)
	Indoor	Keeps flashing	Stays OFF	
	Outdoor	Keeps flashing	Stays OFF	

1. Applicable model
FDT, FDTC, FDEN, FDF series only

2. Error detection method

3. Condition of Error displayed

4. Presumable cause
<ul style="list-style-type: none"> • Defective LM • LM wire breakage • Faulty indoor control PCB

5. Troubleshooting	
Diagnosis	Countermeasure
<p>▲ Check at the indoor unit side.</p> <div style="border: 1px solid black; padding: 5px; width: fit-content; margin-bottom: 10px;">Operate after waiting for more than 1 minute.</div> <pre> graph TD Start[Operate after waiting for more than 1 minute.] --> Q1{Does the louver operate at the power on?} Q1 -- NO --> Q2{Is LM wiring broken?} Q2 -- YES --> C1[Repair wiring.] Q2 -- NO --> Q3{Is LM locked?} Q3 -- YES --> C2[Replace LM.] Q3 -- NO --> C3[Defective indoor control PCB → Replace.] Q1 -- YES --> Q4{Is the louver operable with the remote control?} Q4 -- YES --> C4[Normal] Q4 -- NO --> C5[Adjust LM lever and then check again.] </pre> <p style="text-align: center;">LM: louver motor</p>	

Note:

Error code Remote control: None	LED	Green	Red	Content Power supply system error (Power supply to indoor control PCB)
	Indoor	Stays OFF	Stays OFF	
	Outdoor	Stays OFF	2-time flash	

1. Applicable model
All models

2. Error detection method

3. Condition of Error displayed

4. Presumable cause
<ul style="list-style-type: none"> • Misconnection or breakage of connecting wires • Blown fuse • Faulty transformer • Faulty indoor control or power PCB • Broken harness • Faulty outdoor control PCB (Noise filter)

5. Troubleshooting	
Diagnosis	Countermeasure
<pre> graph TD D1{Is AC220/240V detected between 1 and 2 on the terminal block of indoor unit?} D2{Are fuses OK?} D3{Is the check of resistance between ①-③ of CNW0 OK?} D4{Is the checked result of resistance of FM, etc OK?} D5{Is DCSV detected between ④-⑤ of CNW1?} D6{Is JX1 open?} D7{Is AC380/415V for 3-phase unit detected between 1, 2 and 3 on the terminal block of outdoor unit or is AC220/240V for 1-phase unit detected between 1 and 2 on the terminal block of outdoor unit?} D1 -- YES --> D2 D1 -- NO --> D7 D2 -- YES --> D5 D2 -- NO --> D3 D3 -- YES --> D4 D3 -- NO --> CM1[Defective indoor power PCB → Replace.] D4 -- YES --> CM2[Replace fuse.] D4 -- NO --> CM3[Replace FM, etc.] D5 -- YES --> CM4[Open JX1.] D5 -- NO --> CM5[Defective indoor power PCB → Replace.] D6 -- YES --> CM6[Defective indoor control PCB → Replace.] D6 -- NO --> CM7[Open JX1.] D7 -- YES --> CM8[Misconnection or breakage of connecting wires] D7 -- NO --> CM9[Defective outdoor control PCB (Noise filter)] </pre> <p>Note(1) FDT, FD071-140, FDUM : F1, F2 FDTC, FDF : F200, F201 FDEN, FDU200, 250 : Fuse between wires.</p> <p>Note (2) ⑤ for GND</p>	<p>Defective outdoor control PCB (Noise filter)</p> <p>Misconnection or breakage of connecting wires</p> <p>Defective indoor power PCB → Replace.</p> <p>Replace FM, etc.</p> <p>Replace fuse.</p> <p>Defective indoor power PCB → Replace.</p> <p>Open JX1.</p> <p>Defective indoor control PCB → Replace.</p>

Note:

Error code Remote control: None	LED	Green	Red	Content Power supply system error (Power supply to remote control)
	Indoor	Keeps flashing	Stays OFF	
	Outdoor	Keeps flashing	2-time flash	

1. Applicable model
All models

2. Error detection method

3. Condition of Error displayed

4. Presumable cause
<ul style="list-style-type: none"> • Remote control wire breakage/short-circuit • Defective remote control • Malfunction by noise • Faulty indoor power PCB • Broken harness • Faulty indoor control PCB

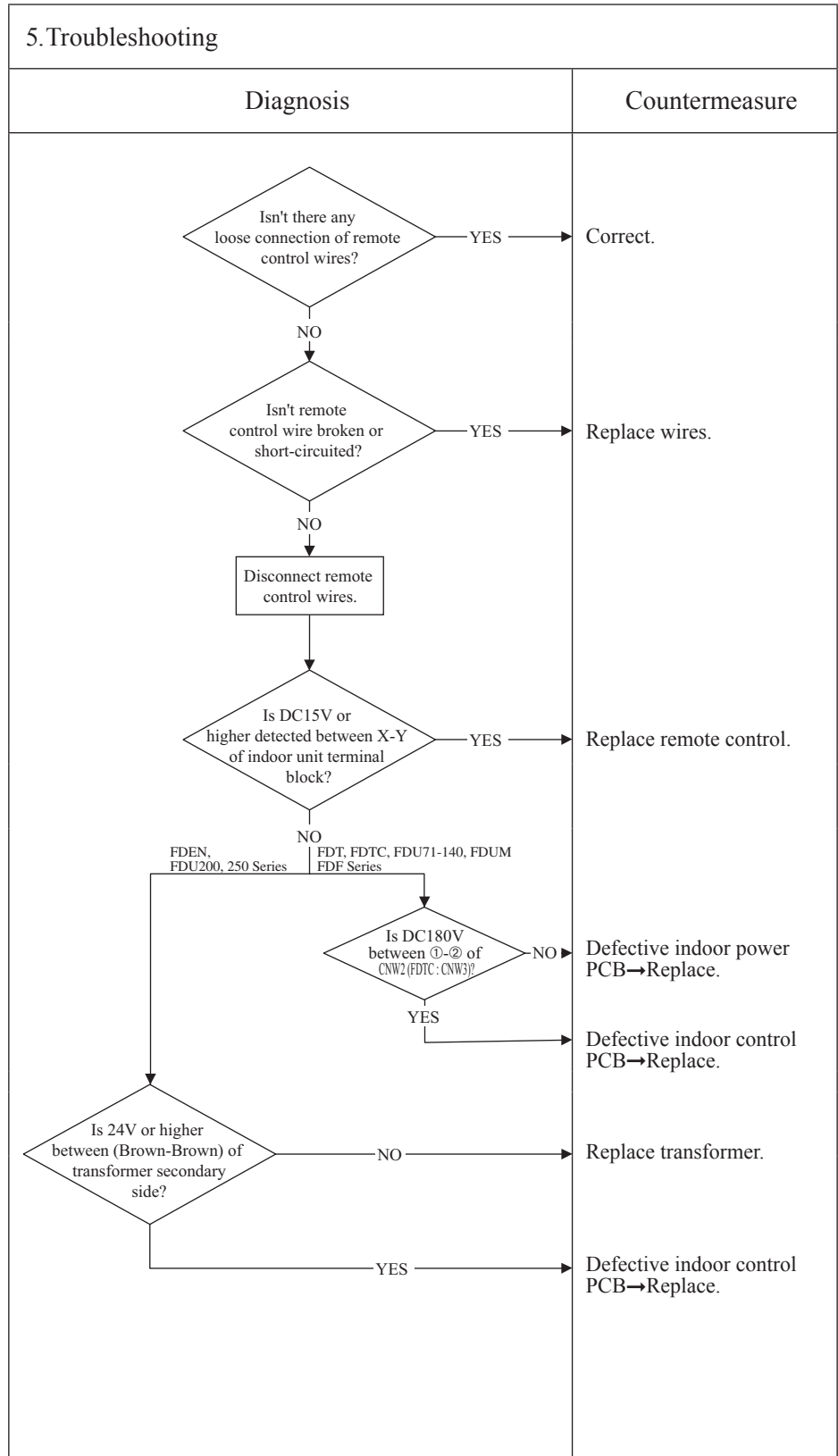

Note:

Error code Remote control: INSPECT I/U	LED	Green	Red	Content INSPECT I/U (When 1 or 2 remote controls are connected)
	Indoor	Keeps flashing	Stays OFF	
	Outdoor	Keeps flashing	2-time flash	

1. Applicable model
All models
2. Error detection method
Communication between indoor unit and remote control is disabled for more than 30 minutes after the power on.
3. Condition of Error displayed
Same as above
4. Presumable cause
<ul style="list-style-type: none"> • Improper setting • Surrounding environment • Defective remote control communication circuit • Faulty indoor control PCB

5. Troubleshooting	
Diagnosis	Countermeasure
<pre> graph TD Q1{Are 2 units of remote control connected?} Q2{Is it set at the slave remote control?} Q3{Does it become normal?} Q4{Do more than one indoor units have the same address?} Q5{Are remote control wires laid along high voltage wires?} Q6{Does DM start 60 seconds later automatically.} Q1 -- YES --> S1[Set one remote control for "Master" and the other for "Slave"] S1 --> Q3 Q3 -- NO --> Q4 Q1 -- NO --> Q2 Q2 -- NO --> Q4 Q2 -- YES --> C1[Set SW1 on remote control PCB at "Master".] Q4 -- YES --> C2[Set address again. (SW2 on indoor control PCB)] Q4 -- NO --> Q5 Q5 -- YES --> C3[Separate remote control wires from high voltage wires.] Q5 -- NO --> S2[Disconnect the connecting wire ③ between the indoor and outdoor unit.] S2 --> S3[Power supply reset] S3 --> Q6 Q6 -- YES --> C4[Defective indoor control PCB -> Replace.] Q6 -- NO --> C5[Defective remote control -> Change.] </pre>	

Note: If any error is detected 30 minutes after displaying “WAIT” on the remote control, the display changes to “INSPECT I/U”.

Error code Remote control: INSPECT I/U	LED	Green	Red	Content INSPECT I/U (Connection of 3 units or more remote control)
	Indoor	Keeps flashing	Stays OFF	
	Outdoor	Keeps flashing	2-time flash	

1. Applicable model
All models

2. Error detection method
Indoor unit cannot communicate for more than 30 minutes after the power on with remote control.

3. Condition of Error displayed
Same as above

4. Presumable cause
<ul style="list-style-type: none"> • Improper setting • Surrounding environment • Defective remote control communication circuit • Faulty indoor control or power PCB • Faulty outdoor control PCB

5. Troubleshooting	
Diagnosis	Countermeasure

Note: If any error is detected 30 minutes after displaying “WAIT” on the remote control, the display changes to “INSPECT I/U”.

Error code Remote control: 🟡WAIT🟡	LED	Green	Red	Content Communication error at initial operation (1/3)
	Indoor	Keeps flashing	Stays OFF	
	Outdoor	Keeps flashing	2-time flash	

1. Applicable model
All models

2. Error detection method

3. Condition of Error displayed

- 4. Presumable cause**
- Faulty indoor control or power PCB
 - Defective remote control
 - Broken remote control wire
 - Faulty outdoor control PCB
 - Broken connection wires

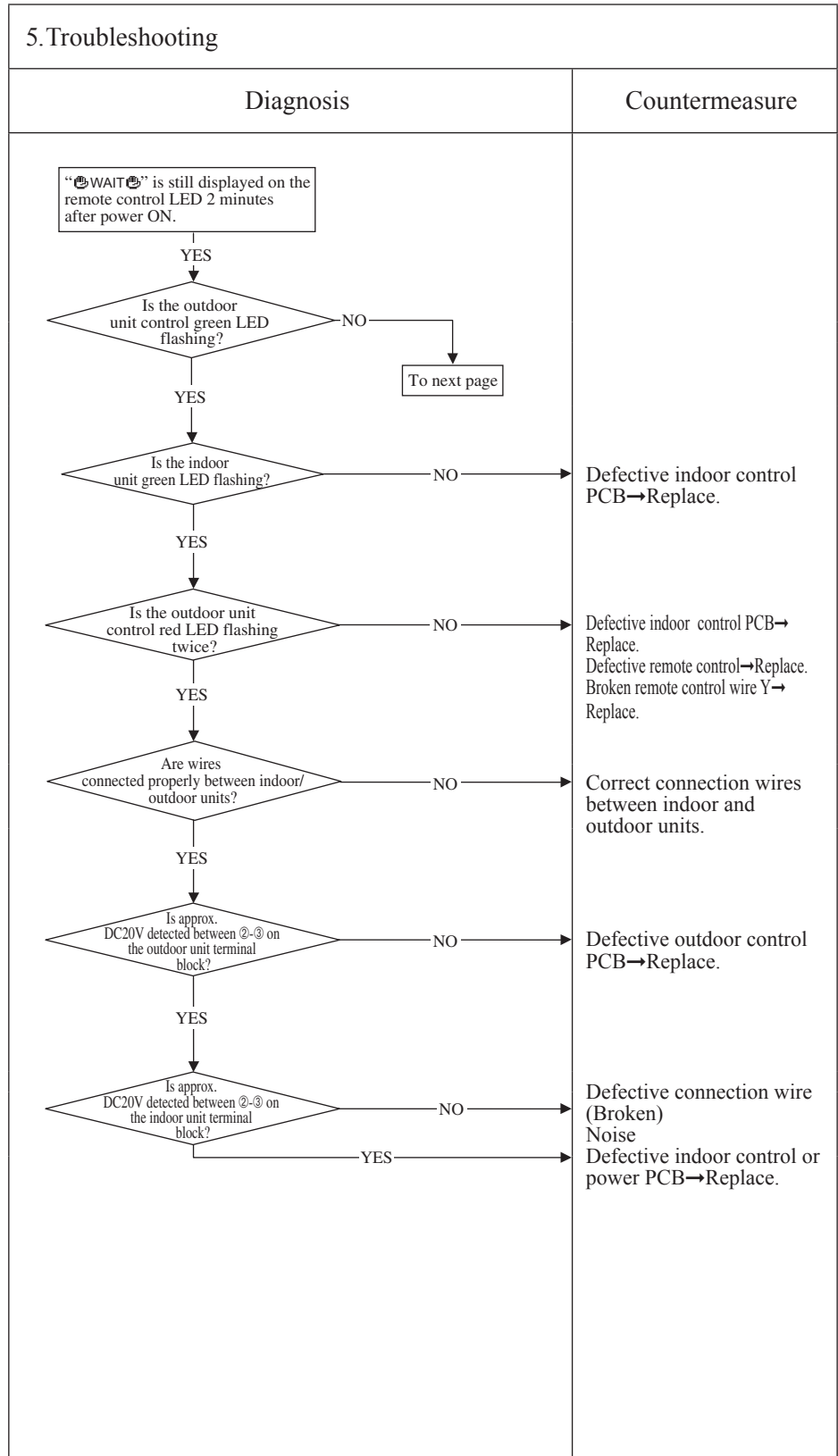

Note:

Error code Remote control: 🏠 WAIT 🏠	LED	Green	Red	Content <h2 style="text-align: center;">Communication error at initial operation (2/3)</h2>
	Indoor	Keeps flashing	Stays OFF	
	Outdoor	Keeps flashing	2-time flash	

1. Applicable model All models
--

2. Error detection method

3. Condition of Error displayed
--

4. Presumable cause <ul style="list-style-type: none"> • Faulty noise filter • Faulty indoor control PCB • Faulty outdoor control PCB • Faulty inverter PCB • Faulty fan motor

5. Troubleshooting
Diagnosis
Diagnosis for when the outdoor control PCB LED is turned off
From previous page → Shut down the breaker and back on again the breaker 3 minutes later.
NO → Does it reset normally?
YES → Normal (Malfunction by noise)
(1) Note (1) FDC100-140VN and FDC200, 250VS only Isn't the outdoor unit control power supply fuse (30A or 10A) blown?
NO → To check method for inverter PCB before replacment of blown power supply fuse. → To next page
YES → Is AC220/240V or AC380/415V detected at the noise filter secondary side?
NO → Replace noise filter.
YES → Is DC255-310V detected at CNA2? Model 100-140 Is DC255-310V detected at CNA2? Model 200, 250 Is 220/240 detected at CNW2?
NO → Check connection of diode stack and electrolytic capacitor by refering main electrical circuit diagram
YES → Note (2) Value in () are for the model 200, 250. Isn't fuse (250V, 2(3)A) on the outdoor control PCB blown?
NO → Defective outdoor control PCB → Replace.
YES → Is DC5V detected on the outdoor control PCB (Between ①-② of CNV)?
NO → Defective outdoor control PCB → Replace.
YES → Is DC5V detected if the connector of outdoor unit fan motor is disconnected?
NO → Defective outdoor fan motor
YES → Is DC5V detected if the inverter power supply connector (CN12) is disconnected?
NO → Defective inverter PCB → Replace.
YES → Defective outdoor control PCB → Replace.

Note:

Error code Remote control: 🖱️ WAIT 🖱️	LED	Green	Red	Content Communication error at initial operation (3/3)
	Indoor	Keeps flashing	Stays OFF	
	Outdoor	Keeps flashing	2-time flash	

1. Applicable model
All models

2. Error detection method

3. Condition of Error displayed

4. Presumable cause
- Blown fuse
 - Faulty noise filter
 - Faulty inverter PCB
 - Faulty reactor
 - Faulty electrolytic capacitor

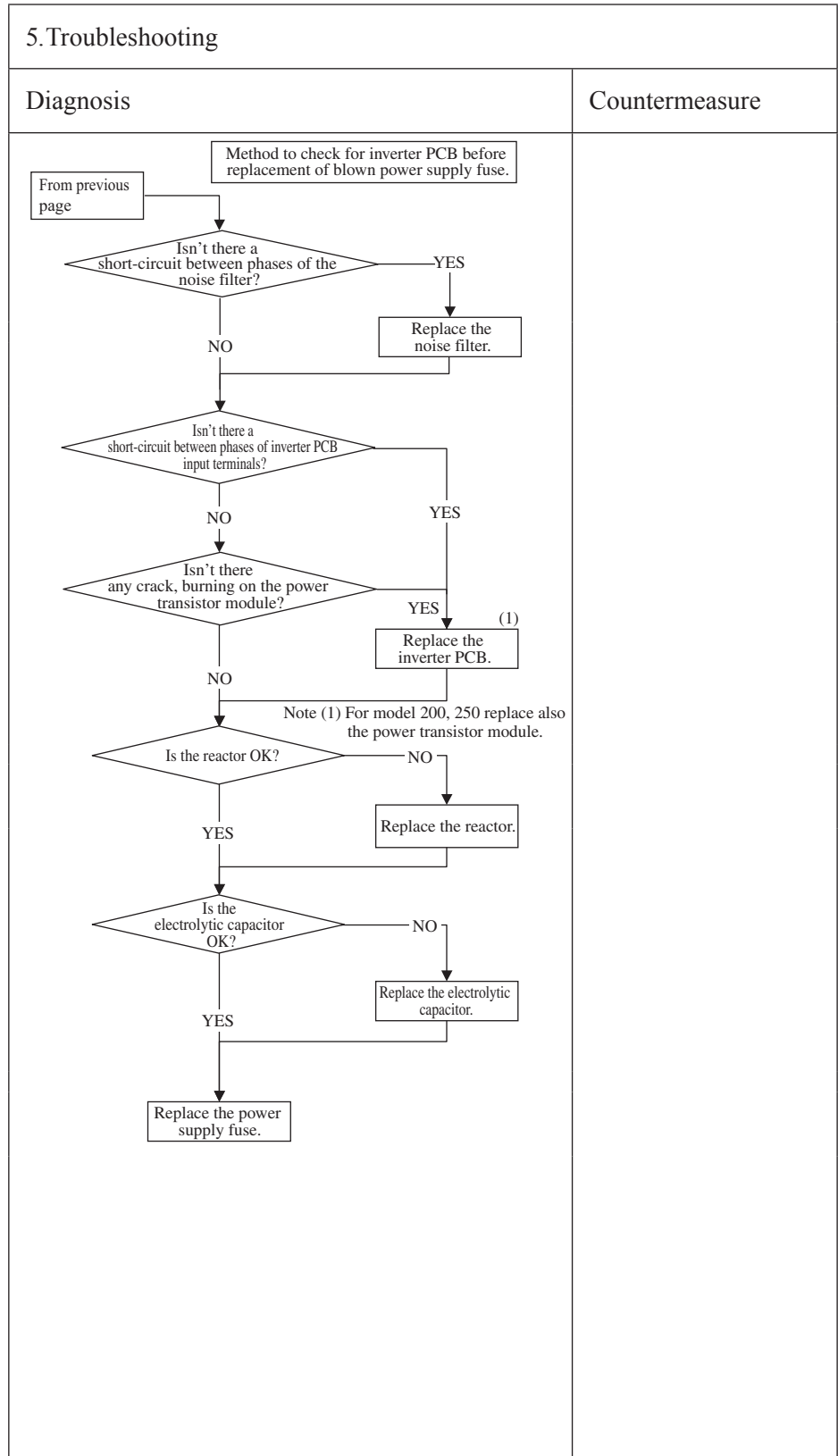

Note:

Error code Remote control: None	LED	Green	Red	Content No display
	Indoor	Keeps flashing	Stays OFF	
	Outdoor	Keeps flashing	2-time flash	

1. Applicable model	5. Troubleshooting		
All models	Diagnosis	Countermeasure	
2. Error detection method	<pre> graph TD Start[Remote control does not display anything after the power on.] --> D1{Is DC10V or higher detected at remote control connection terminals?} D1 -- YES --> C1[Defective remote control] D1 -- NO --> D2{Is DC10V or higher detected on remote control wires if the remote control is removed?} D2 -- YES --> C2[Defective remote control] D2 -- NO --> D3{Are wires connected properly between the indoor/outdoor units?} D3 -- YES --> C3[Defective connecting wire. Defective remote control wire (Short-circuit, etc.)] D3 -- NO --> C4[Defective indoor control PCB → Replace.] </pre>		
3. Condition of Error displayed			
4. Presumable cause	<ul style="list-style-type: none"> • Faulty indoor control PCB • Defective remote control • Broken remote control wire 		

Note:

Error code Remote control: E1	LED	Green	Red	Content	Remote control communication circuit error
	Indoor	Keeps flashing	Stays OFF		
	Outdoor	Keeps flashing	Stays OFF		

1. Applicable model
All models

2. Error detection method
When normal communication between the remote control and the indoor unit is interrupted for more than 2 minutes. (Detectable only with the remote control)

3. Condition of Error displayed
Same as above

4. Presumable cause
<ul style="list-style-type: none"> • Defective communication circuit between remote control-indoor unit • Noise • Defective remote control • Faulty indoor control PCB

5. Troubleshooting	
Diagnosis	Countermeasure
<pre> graph TD A{Is it possible to reset normally by the power reset?} -- YES --> B[Malfunction by noise Check peripheral environment.] A -- NO --> C[Turn SW7-1 to OFF. → ON Remove the wire ③ connecting between indoor/outdoor units.] C --> D[Power reset] D --> E{Does the drain pump restart automatically 1 minute later?} E -- YES --> F[Defective indoor control PCB → Replace.] E -- NO --> G[Defective remote control → Replace.] </pre> <p>Note (2) Does the remote control still display “WAIT” even after 3 minutes?</p>	

Note: If the indoor unit cannot communicate normally with the remote control for 180 seconds, the indoor unit PCB starts to reset automatically.

Error code Remote control: E5	LED	Green	Red	Content Communication error during operation
	Indoor	Keeps flashing	2-time flash	
	Outdoor	Keeps flashing	See below	

1. Applicable model
All models

2. Error detection method
When normal communication between indoor and outdoor unit is interrupted for more than 2 minutes.

3. Condition of Error displayed
Same as above is detected during operation.

4. Presumable cause
<ul style="list-style-type: none"> • Unit No. setting error • Broken remote control wire • Faulty remote control wire connection • Faulty outdoor control PCB

5. Troubleshooting	
Diagnosis	Countermeasure
<p>In case that the outdoor unit red LED flashes 2-time</p> <p>Note (1) Inspect faulty connections (disconnection, looseness) on the outdoor unit terminal block.</p> <p>Is the connection of signal wires at the outdoor unit side OK?</p> <p>NO → Repair signal wires.</p> <p>YES</p> <p>Note (2) Check for faulty connection or breakage of signal wires between indoor-outdoor units.</p> <p>Is the connection of signal wires between indoor-outdoor units OK?</p> <p>NO → Repair signal wires.</p> <p>YES</p> <p>Power reset</p> <p>Has the remote control LCD returned to normal state?</p> <p>NO → To the diagnosis of “WAIT”</p> <p>YES → Unit is normal. (Malfunction by temporary noise, etc.)</p> <p>In case that the outdoor unit red LED stays OFF</p> <p>Power reset</p> <p>NO</p> <p>Has the remote control LCD returned to normal state?</p> <p>NO → Defective outdoor control PCB (Defective network communication circuit) → Replace.</p> <p>YES → Unit is normal. (Malfunction by temporary noise, etc.)</p>	

Note: Pressing the pump-down switch cancels communications between indoor and outdoor unit so that “communication error-E5” is displayed on indoor unit and remote control, but it is normal.

Error code Remote control: E6	LED	Green	Red	Content Indoor heat exchanger temperature thermistor anomaly
	Indoor	Keeps flashing	1-time flash	
	Outdoor	Keeps flashing	Stays OFF	

1. Applicable model
All models

2. Error detection method
Anomalously low temperature or high temperature (resistance) is detected on the indoor heat exchanger thermistor (ThI-R1, R2 or R3).

3. Condition of Error displayed

- When the temperature thermistor detects -50°C or lower for 5 seconds continuously, the compressor stops. After 3-minutes delay, the compressor starts again automatically, but if this error occurs again within 60 minutes after the initial detection.
- Or if 70°C or higher is detected for 5 seconds continuously.

4. Presumable cause

- Defective indoor heat exchanger thermistor connector
- Indoor heat exchanger temperature thermistor anomaly
- Faulty indoor control PCB

5. Troubleshooting

Diagnosis	Countermeasure
<pre> graph TD Q1{Is the connection of indoor heat exchanger temperature thermistor connector OK?} Q2{Are characteristics of indoor heat exchanger temperature thermistor OK?} Q1 -- NO --> C1[Correct. → Insert connector securely.] Q1 -- YES --> Q2 Q2 -- NO --> C2[Defective indoor heat exchanger temperature thermistor → Replace.] Q2 -- YES --> C3[Defective indoor control PCB → Replace. (Defective indoor unit heat exchanger temperature thermistor input circuit)] </pre>	
<p>(Broken wire)</p> <p>(Short circuit)</p>	

Note:

Error code Remote control: E7	LED	Green	Red	Content Return air temperature thermistor anomaly
	Indoor	Keeps flashing	1-time flash	
	Outdoor	Keeps flashing	Stays OFF	

1. Applicable model
All models

2. Error detection method
Anomalously low temperature or high temperature (resistance) is detected by indoor return air temperature thermistor (ThI-A)

3. Condition of Error displayed

- When the temperature thermistor detects -50°C or lower for 5 seconds continuously, the compressor stops. After 3-minute delay, the compressor starts again automatically, but if this error occurs again within 60 minutes after the initial detection.

4. Presumable cause

- Defective return air temperature thermistor connector
- Defective return air temperature thermistor
- Faulty indoor control PCB

5. Troubleshooting

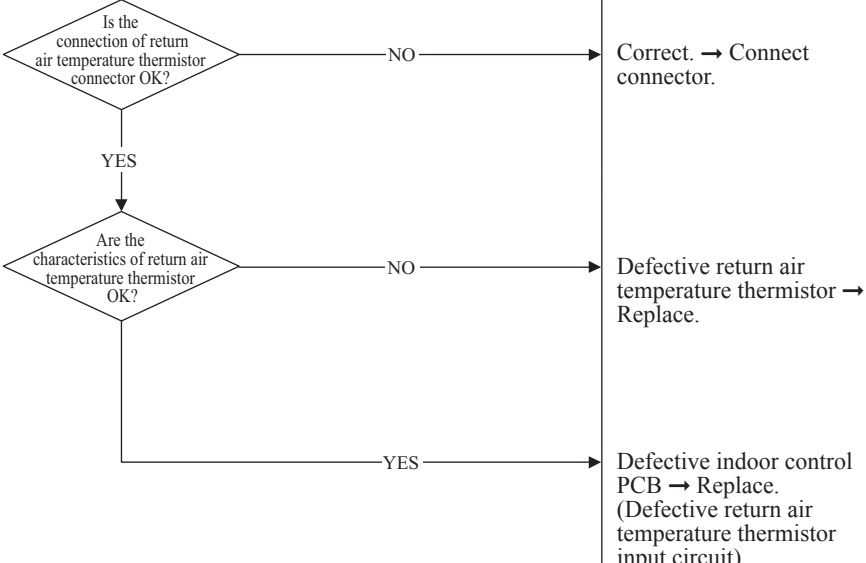
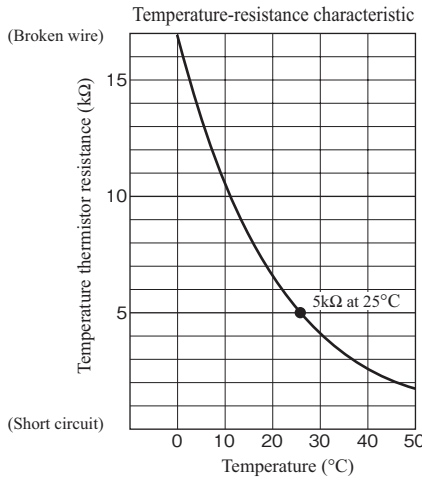
Diagnosis	Countermeasure
 <pre> graph TD Q1{Is the connection of return air temperature thermistor connector OK?} Q2{Are the characteristics of return air temperature thermistor OK?} C1[Correct. -> Connect connector.] C2[Defective return air temperature thermistor -> Replace.] C3[Defective indoor control PCB -> Replace. (Defective return air temperature thermistor input circuit)] Q1 -- NO --> C1 Q1 -- YES --> Q2 Q2 -- NO --> C2 Q2 -- YES --> C3 </pre>	
<p>Temperature-resistance characteristic</p>  <p>(Broken wire)</p> <p>Temperature thermistor resistance (kΩ)</p> <p>Temperature (°C)</p> <p>5kΩ at 25°C</p> <p>(Short circuit)</p>	

Note:

Error code Remote control: E8	LED	Green	Red	Content Heating overload operation
	Indoor	Keeps flashing	1-time flash	
	Outdoor	Keeps flashing	Stays OFF	

1. Applicable model
All models

2. Error detection method
Indoor heat exchanger temperature thermistor (ThI-R1, R2, R3)

3. Condition of Error displayed
When it is detected 5 times within 60 minutes from initial detection or when the overload condition is detected for 6 minutes continuously.

- 4. Presumable cause**
- Clogged air filter
 - Defective indoor heat exchanger temperature thermistor connector
 - Defective indoor heat exchanger temperature thermistor
 - Anomalous refrigerant system

5. Troubleshooting

Diagnosis	Countermeasure
<pre> graph TD Q1{Is the air filter clogged?} -- NO --> Q2{Is the indoor heat exchanger temperature thermistor connection OK?} Q1 -- YES --> C1[Wash.] Q2 -- NO --> C2[Defective indoor heat exchanger temperature thermistor connector → Correct.] Q2 -- YES --> Q3{Are the characteristics of indoor heat exchanger temperature thermistor OK? (2)} Q3 -- NO --> C3[Defective indoor heat exchanger temperature thermistor.] Q3 -- YES --> R1[Check the error data with the remote controller.] R1 --> Q4{Is the unit operating in the state of heating overload?} Q4 -- NO --> C4[Check refrigerant system.] Q4 -- YES --> C5[Adjust] </pre>	
<p>Note (1) Judge if it is in the state of overload or not as follows.</p> <ul style="list-style-type: none"> ▲ Is there any short-circuit of air? ▲ Isn't there any fouling or clogging on the indoor heat exchanger? ▲ Is the outdoor fan control normal? ▲ Isn't the room and outdoor air temperature too high? <p>Note (2) For characteristics of indoor heat exchanger temperature thermistor, see the error display E6.</p> <p>The graph shows a horizontal line representing indoor heat exchanger temperature. A downward arrow labeled 'Reset' points to the line at 56°C. An upward arrow labeled 'Error stop' points to the line at 63°C.</p>	

Note: During heating operation; After starting compressor, compressor rotation speed is decreased by detecting indoor heat exchanger temperature (ThI-R) in order to control high pressure.

Error code Remote control: E9	LED	Green	Red	Content Drain trouble (FDT, FDTC, FDU and FDUM series)
	Indoor	Keeps flashing	1-time flash	
	Outdoor	Keeps flashing	Stays OFF	

1. Applicable model
FDT, FDTC, FDU and FDUM series only
2. Error detection method
Float switch is activated
3. Condition of Error displayed
If the float switch OPEN is detected for 3 seconds continuously or if float switch connector or wire is disconnected.
4. Presumable cause
<ul style="list-style-type: none"> • Defective indoor control PCB • Float switch setting error • Humidifier DM interlock setting error • Optional equipment setting error • Drain piping error • Defective drain motor • Disconnection of drain motor wiring

5. Troubleshooting	
Diagnosis	Countermeasure
<pre> graph TD Start[Check the error data in the remote controller.] --> Q1{Is there any overflow?} Q1 -- NO --> Q2{Is DC12V at CNI connector?} Q2 -- YES --> C1[Check float switch.] Q2 -- NO --> Q3{Is the CNI connected firmly?} Q3 -- NO --> C2[Defective indoor control PCB → Replace.] Q3 -- YES --> Q4{Is there any anomaly on the optional equipment?} Q4 -- NO --> C3[Defective indoor control PCB → Replace.] Q4 -- YES --> C4[Check optional equipment] Q1 -- YES --> Q5{Is the humidifier connected?} Q5 -- YES --> Q6{Is the humidifier Drain Motor interlocked by the indoor unit function setting of remote controller?} Q6 -- NO --> C5[Correct setting to "Humidifier DM interlock".] Q6 -- YES --> S1[Drain motor ON from the remote controller] S1 --> Q7{Does DM operate?} Q7 -- NO --> Q8{Is AC220/240V or DC12V detected at CNR connector?} Q8 -- NO --> C6[Defective indoor control PCB → Replace. (Replace power PCB on FDTC series.)] Q8 -- YES --> C7[Check wiring of Drain motor] Q7 -- YES --> Q9{Is the drain piping unclogged? Is the drain pipe slop OK?} Q9 -- NO --> C8[Correct.] Q9 -- YES --> C9[Check drain motor.] </pre>	

Note: When this error occurred at power ON, disconnection of wire or connector of the float switch is suspected. Check and correct it (or replace it, if necessary).

Error code Remote control: E10	LED	Green	Red	Content Excessive number of connected indoor units (more than 17 units) by controlling with one remote control
	Indoor	Keeps flashing	Stays OFF	
	Outdoor	Keeps flashing	Stays OFF	

<p>1. Applicable model</p> <p>All models</p>	<p>5. Troubleshooting</p> <table border="1" style="width: 100%;"> <thead> <tr> <th style="width: 50%;">Diagnosis</th> <th style="width: 50%;">Countermeasure</th> </tr> </thead> <tbody> <tr> <td style="text-align: center;"> <pre> graph LR A{Aren't more than 17 indoor units connected to one remote control?} -- NO --> B[Defective remote control -> Replace.] A -- YES --> C[Reduce to 16 or less units.] </pre> </td> <td></td> </tr> </tbody> </table>		Diagnosis	Countermeasure	<pre> graph LR A{Aren't more than 17 indoor units connected to one remote control?} -- NO --> B[Defective remote control -> Replace.] A -- YES --> C[Reduce to 16 or less units.] </pre>	
Diagnosis	Countermeasure					
<pre> graph LR A{Aren't more than 17 indoor units connected to one remote control?} -- NO --> B[Defective remote control -> Replace.] A -- YES --> C[Reduce to 16 or less units.] </pre>						
<p>2. Error detection method</p> <p>When it detects more than 17 of indoor units connected to one remote control</p>						
<p>3. Condition of Error displayed</p> <p>Same as above</p>						
<p>4. Presumable cause</p> <ul style="list-style-type: none"> • Excessive number of indoor units connected • Defective remote control 						

Note:

Error code Remote control: E11	LED	Green	Red	Content Address setting error of indoor units
	Indoor	Keeps flashing	Keeps flashing	
	Outdoor	Keeps flashing	stays OFF	

1.Applicable model
All models

2.Error detection method
IU address has been set using the “Master IU address set” function of remote control.

3.Condition of Error displayed
Same as above

4.Presumable cause
Same as above

5.Troubleshooting	
Diagnosis	Countermeasure
<pre> graph TD A[E11 occurs] --> B{Is "Master IU address set" function of remote control used?} B -- YES --> C[Countermeasure] </pre>	
<p>In case the wiring is below and “Mastar IU address set” is used, E11 is appeared.</p>	
<ul style="list-style-type: none"> • In cases of RC-E5 Return address No. to “IU ...” using [▲] or [▲] button. • In cases of RC-EX1A Menu → Next → IU settings → Select IU 	

Note:

Error code Remote control: E14	LED	Green	Red	Content Communication error between master and slave indoor units
	Indoor	Keeps flashing	3-time flash	
	Outdoor	Keeps flashing	Stays OFF	

1.Applicable model
All models

2.Error detection method
When communication error between master and slave indoor units occurs

3.Condition of Error displayed
Same as above

4.Presumable cause

- Unit address setting error
- Broken remote control wire
- Defective remote control wire connection
- Defective indoor control PCB

5.Troubleshooting

Diagnosis	Countermeasure
<pre> graph TD D1{Is it OK the unit address setting for master and slave indoor units?} D2{Isn't the remote control wiring between indoor units defective?} D3{Is it restored by resetting the power supply?} D1 -- NO --> C1[Correct unit address setting.] D1 -- YES --> D2 D2 -- YES --> C2[Correct wiring.] D2 -- NO --> D3 D3 -- NO --> C3[Defective indoor control PCB -> Replace.] D3 -- YES --> C4["• Malfunction by noise • Check surrounding environment."] </pre>	

Note (1) Set dip switches SW5-1 and SW5-2 as shown in the following table.
(Factory default setting – “Master”)

		Indoor unit		
		Master	Slave-a	Slave-b
Dip switch	SW5-1	OFF	OFF	ON
	SW5-2	OFF	ON	OFF

Note:

Error code Remote control: E16	LED	Green	Red	Content Indoor fan motor anomaly
	Indoor	Keeps flashing	1(2)-time flash	
	Outdoor	Keeps flashing	Stays OFF	

Note (1) Value in () is for the FDUM series FMI2 only.

1. Applicable model
All models
2. Error detection method
Detected by rotation speed of indoor fan motor
3. Condition of Error displayed
When actual rotation speed of indoor fan motor drops to lower than 200min ⁻¹ for 30 seconds continuously, the compressor and the indoor fan motor stop. After 2-seconds, it starts again automatically, but if this error occurs 4 times within 60 minutes after the initial detection.
4. Presumable cause
<ul style="list-style-type: none"> • Defective indoor power PCB • Foreign material at rotational area of fan propeller • Defective fan motor • Dust on control PCB • Blown fuse • External noise, surge

5. Troubleshooting	
Diagnosis	Countermeasure
<pre> graph TD D1{Does any foreign material intervene in rotational area of fan propeller?} -- YES --> C1[Remove foreign material.] D1 -- NO --> D2{Does the fan rotate smoothly when turned by hand?} D2 -- NO --> C2[Replace the fan motor.] D2 -- YES --> D3{Is DC280V detected between ①-④ of fan motor connector CNM?} Note1[Note (1) ④ for GND] --- D3 D3 -- YES --> C3[Replace indoor control PCB.] D3 -- NO --> Branch1(()) Branch1 -- "FDEN, FDU200,250 series" --> C3 Branch1 -- "FDT, FDTC, FDU100-140, FDUM and FDF series" --> D4{Is the fuse F3 (F4) or F202 blown?} D4 -- YES --> C4[Replace faulty fan motor and power PCB.] D4 -- NO --> C5[Check power voltage.] Box1[Power supply reset] --> D5{Is it normalized?} D5 -- YES --> C6[Malfunction by temporary noise] D5 -- NO --> C7[Replace fan motor. (If the error persists after replacing the fan motor, replace the indoor control PCB.)] </pre>	

Note:

Error code Remote control: E18	LED	Green	Red	Content Address setting error of master and slave indoor units
	Indoor	Keeps flashing	1-time flash	
	Outdoor	Keeps flashing	Stays OFF	

1. Applicable model
All models

2. Error detection method
IU address has been set using the “Master IU address set” function of remote control.

3. Condition of Error displayed
Same as above

4. Presumable cause
Same as above

5. Troubleshooting

Diagnosis	Countermeasure
<pre> graph TD A[E18 occurs] --> B{Is "Master IU address set" function of remote control used?} B -- YES --> C[Return address No. to "IU ..." using [▲] or [▼] button.] </pre>	<p>Return address No. to “IU ...” using [▲] or [▼] button.</p>

Note:

Error code Remote control: E19	LED	Green	Red	Content Indoor unit operation check, drain motor check setting error
	Indoor	Keeps flashing	1-time flash	
	Outdoor	Keeps flashing	Stays OFF	

1. Applicable model
All models

2. Error detection method
After indoor operation check, when the communication between indoor and outdoor unit is established and SW7-1 is still kept ON.

3. Condition of Error displayed
Same as above

4. Presumable cause
Mistake in SW7-1 setting (Due to forgetting to turn OFF SW7-1 after indoor operation check)

5. Troubleshooting	
Diagnosis	Countermeasure
<pre> graph TD Start[E19 occurs when the power ON] --> Decision{Is SW7-1 on the indoor control PCB ON?} Decision -- NO --> Countermeasure1[Defective indoor control PCB (Defective SW7) -> Replace] Decision -- YES --> Countermeasure2[Turn SW7-1 on the indoor control PCB OFF and reset the power] </pre>	

Note:

Error code Remote control: E20	LED	Green	Red	Content Indoor fan motor rotation speed anomaly
	Indoor	Keeps flashing	1(2)-time flash	
	Outdoor	Keeps flashing	Stays OFF	

Note (1) Value in () is for the FDUM series FMI2 only.

<p>1. Applicable model</p> <p>All models</p>	<p>5. Troubleshooting</p>	
<p>2. Error detection method</p> <p>Detected by rotation speed of indoor fan motor</p>	<p style="text-align: center;">Diagnosis</p> <pre> graph TD D1{Does any foreign material intervene in rotational area of fan propeller?} -- YES --> C1[Remove foreign material.] D1 -- NO --> D2{Does the fan rotate smoothly when turned by hand?} D2 -- YES --> D3{Is DC280V detected between ①-④ of fan motor connector CNM?} D2 -- NO --> C2[Replace the fan motor.] D3 -- YES --> PR[Power supply reset] D3 -- NO --> D4{Is the fuse F3 (F4) or F202 blown?} PR --> D5{Is it normalized?} D4 -- YES --> C3[Replace faulty fan motor and power PCB.] D4 -- NO --> D6{Is DC280V detected between ①-④ of fan motor connector CNM?} D5 -- YES --> C4[Malfunction by temporary noise] D5 -- NO --> C5[Replace fan motor. (If the error persists after replacing the fan motor, replace the indoor control PCB.)] D6 -- YES --> C6[Replace control PCB.] D6 -- NO --> C7[Check power voltage.] </pre>	<p style="text-align: center;">Countermeasure</p>
<p>3. Condition of Error displayed</p> <p>When the actual fan rotation speed does not reach to the speed of [required speed -50min⁻¹] after 2 minutes have been elapsed since the fan motor rotation speed command was output, the unit stops by detecting indoor fan motor anomaly.</p>		
<p>4. Presumable cause</p> <ul style="list-style-type: none"> • Defective indoor power (control) PCB • Foreign material at rotational area of fan propeller • Defective fan motor • Dust on control PCB • Blown fuse • External noise, surge 		

Note:

Error code Remote control: E21	LED	Green	Red	Content
	Indoor	Keeps flashing	1-time flash	
	Outdoor	Keeps flashing	Stays OFF	

Defective panel switch operation (FDT)

1. Applicable model
FDT series only
2. Error detection method
Panel switch (PS) has detected Open for more than 1 second.
3. Condition of Error displayed
Same as above
4. Presumable cause
<ul style="list-style-type: none"> • Defective panel switch • Disconnection of wiring • Defective indoor control PCB

5. Troubleshooting	
Diagnosis	Countermeasure
<pre> graph TD Q1{Is grill opened?} -- YES --> C1[Reset the error and close the grill.] Q1 -- NO --> Q2{Does matter improve if panel switch is turned ON forcibly after resetting error?} Q2 -- YES --> C2["Insufficient push on the panel switch at the internal face of grill -> Attach 3 mm thick rubber sheet at the section where the panel switch touches the inside of grill. Close then the grill."] Q2 -- NO --> Q3{Are connectors at right inserted properly?} Q3 -- NO --> C3["Disconnected, poorly connected connectors -> Reinsert properly."] Q3 -- YES --> Q4{Is there continuity between #1 - #4 of CNV on indoor control PCB when panel switch operation is checked?} Q4 -- NO --> C4["• Defective panel switch or incorrect panel switch wiring -> Replace panel switch. • Broken wire between panel switch PCB (CNV) -> Correct or replace wire."] Q4 -- YES --> C5[Defective indoor control PCB -> Replace indoor control PCB.] </pre>	<p><Forced panel switch ON> Put the switch in the state of ON by fixing the silicone section of panel switch with adhesive tape while it is held down.</p> <p><Connectors on PCBs> Indoor control PCB: CNV</p> <p><To CNY1></p> <p>Silicone guide Panel switch Push to turn ON.</p>

Note:

Error code Remote control: E28	LED	Green	Red	Content Remote control temperature thermistor anomaly
	Indoor	Keeps flashing	Stays OFF	
	Outdoor	Keeps flashing	Stays OFF	

1. Applicable model
All models

2. Error detection method
Detection of anomalously low temperature (resistance) of remote control temperature thermistor (Thc)

3. Condition of Error displayed
When the temperature thermistor detects -50°C or lower for 5 seconds continuously, the compressor stops. After 3-minutes delay, the compressor starts again automatically, but if this error occurs again within 60 minutes after the initial detection.

4. Presumable cause

- Faulty connection of remote control temperature thermistor
- Defective remote control temperature thermistor
- Defective remote control PCB

5. Troubleshooting

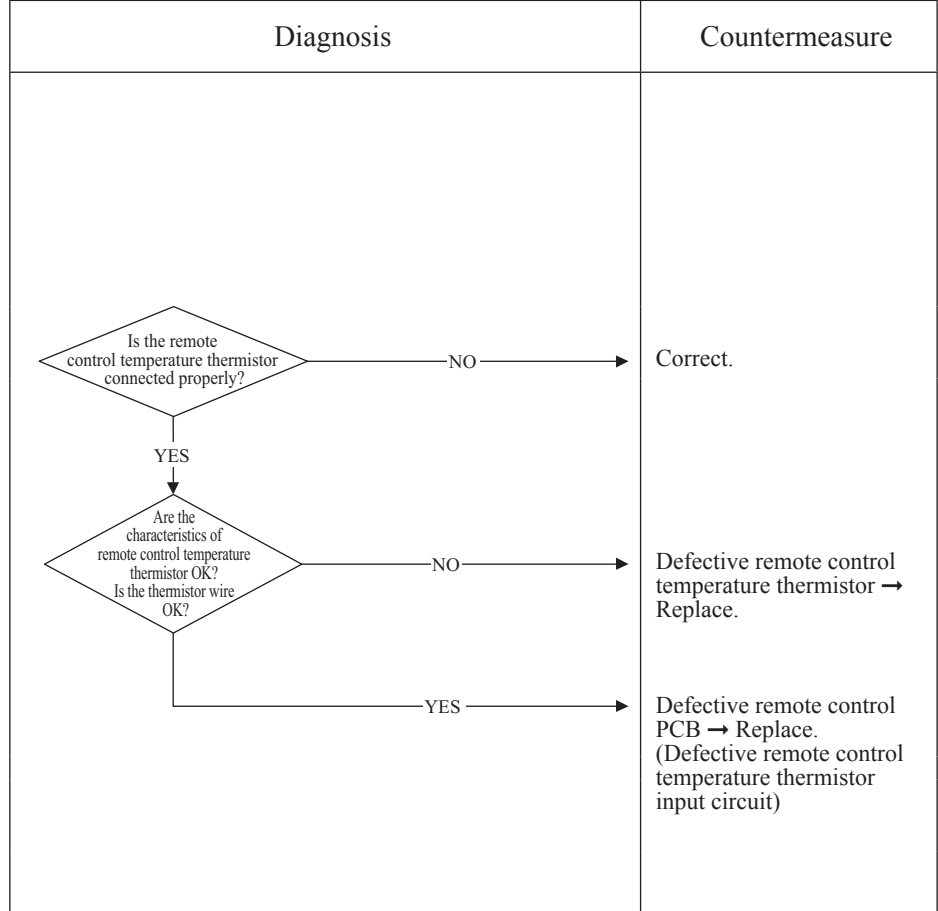

Resistance-temperature characteristics of remote control temperature thermistor (ThC)

Temperature (°C)	Resistance value (kΩ)	Temperature (°C)	Resistance value (kΩ)
0	65	30	16
1	62	32	15
2	59	34	14
4	53	36	13
6	48	38	12
8	44	40	11
10	40	42	9.9
12	36	44	9.2
14	33	46	8.5
16	30	48	7.8
18	27	50	7.3
20	25	52	6.7
22	23	54	6.3
24	21	56	5.8
26	19	58	5.4
28	18	60	5.0

Note: After 10 seconds has passed since remote control thermistor was switched from valid to invalid, E28 will not be displayed even if the thermistor harness is disconnected. At same time the thermistor, which is effective, is switched from remote control thermistor to indoor return air temperature thermistor. Even though the remote control thermistor is set to be Effective, the return air temperature displayed on remote control for checking still shows the value detected by indoor return air temperature thermistor, not by remote control temperature thermistor.

Error code Remote control: E35	LED	Green	Red	Content Cooling overload operation
	Indoor control PCB	Keeps flashing	Stays OFF	
	Outdoor control PCB	Keeps flashing	1-time flash	
	Outdoor inverter PCB	Yellow LED or Red LED Keeps flashing	Green LED Keeps flashing	

1. Applicable model
All models

2. Error detection method
For the error detection method, refer to the protective control by controlling compressor rotation speed and cooling high pressure protective control of micro computer control function for corresponding models.

3. Condition of Error displayed
When outdoor heat exchanger temperature anomaly is detected 5 times within 60 minutes or this anomalous state is detected 60 minutes continuously including compressor stop.

4. Presumable cause
<ul style="list-style-type: none"> • Defective outdoor heat exchanger temperature thermistor • Defective outdoor control PCB • Indoor, outdoor unit installation spaces • Short-circuit of air on indoor, outdoor units • Fouling, clogging of heat exchanger • Excessive refrigerant amount

5. Troubleshooting	
Diagnosis	Countermeasure
<p style="text-align: right;">* For the characteristics of outdoor heat exchanger temperature thermistor, refer to E37.</p> <pre> graph TD Q1{Are the characteristics of outdoor heat exchanger temperature thermistor normal?} Q2{Is the unit operating in the state of cooling overload?} Q3{Is the high pressure control normal?} Q4{Is the temperature (measured actually) at detection of error correct?} Q1 -- NO --> C1[Replace outdoor heat exchanger temperature thermistor.] Q1 -- YES --> Q2 Q2 -- YES --> C2[Check unit side.
• Isn't the air circulation of outdoor unit short-circuited?
• Are installation spaces adequate?
• Isn't there any fouling or clogging on heat exchanger?] Q2 -- NO --> Q3 Q3 -- NO --> C3[Control operation check *] Q3 -- YES --> Q4 Q4 -- NO --> C4[Defective outdoor control PCB -> Replace.] Q4 -- YES --> C5[Excessive refrigerant amount : Recharge refrigerant by weighing proper amount on a scale.] </pre>	
<p>* For the contents of control, refer to the protective control by controlling compressor rotation speed and cooling high pressure protective control of micro computer control function for corresponding models.</p>	

Note:

Error code Remote control: E36	LED	Green	Red	Content Discharge pipe temperature error
	Indoor control PCB	Keeps flashing	Stays OFF	
	Outdoor control PCB	Keeps flashing	1-time flash	
	Outdoor inverter PCB	Yellow LED or Red LED Keeps flashing	Green LED Keeps flashing	

1. Applicable model
All models

2. Error detection method
For the error detection method, refer to the protective control by controlling compressor rotation speed and cooling high pressure protective control of micro computer control function for corresponding models.

3. Condition of Error displayed
When discharge pipe temperature anomaly is detected 2 times within 60 minutes or this anomalous state is detected 60 minutes continuously including compressor stop.

4. Presumable cause
<ul style="list-style-type: none"> • Defective outdoor control PCB • Defective discharge pipe temperature thermistor • Clogged filter • Indoor, outdoor unit installation spaces • Short-circuit of air on indoor, outdoor units • Fouling, clogging of heat exchanger

5. Troubleshooting	
Diagnosis	Countermeasure
<p style="text-align: right;">* For the characteristics of discharge pipe temperature, refer to E39.</p> <pre> graph TD D1{Are the characteristics of discharge pipe temperature thermistor normal?} D2{Is the discharge pipe temperature error persisted during cooling operation?} D3{Is the discharge pipe temperature control normal?} D4{Is the temperature (measured actually) at detection of error correct?} D1 -- NO --> C1[Replace discharge pipe temperature thermistor.] D1 -- YES --> D2 D2 -- YES --> C2[Insufficient refrigerant amount : Recharge refrigerant by weighing proper amount on a scale.] D2 -- NO --> D3 D3 -- NO --> C3[Control operation check *] D3 -- YES --> D4 D4 -- NO --> C4[Defective outdoor control PCB → Replace.] D4 -- YES --> C5[Check unit side: • Isn't filter clogged? • Are adequate indoor, outdoor unit installation spaces? • Isn't there any short-circuit of air? • Isn't there any fouling, clogging on indoor heat exchanger?] </pre> <p>* For the contents of control, refer to the protective control by controlling compressor rotation speed and cooling high pressure protective control of micro computer control function for corresponding models.</p>	

Note:

Error code Remote control: E37	LED	Green	Red	Content Outdoor heat exchanger temperature thermistor anomaly
	Indoor control PCB	Keeps flashing	Stays OFF	
	Outdoor control PCB	Keeps flashing	1-time flash	
	Outdoor inverter PCB	Yellow LED or Red LED Keeps flashing	Green LED Keeps flashing	

1.Applicable model
All models

2. Error detection method
Detection of anomalously low temperature (resistance) on the outdoor heat exchanger temperature thermistor

3. Condition of Error displayed
<ul style="list-style-type: none"> When the temperature thermistor detects -50°C or lower for 20 seconds continuously within 2 minutes to 2 minutes 20 seconds after the compressor ON, the compressor stops. After 3-minutes delay, the compressor starts again automatically, but if this anomalous temperature is detected 3 times within 40 minutes. When -50°C or lower is detected for 5 seconds continuously within 20 second after compressor ON.

4. Presumable cause
<ul style="list-style-type: none"> Defective outdoor control PCB Broken thermistor harness or temperature sensing section Disconnected wire connection (connector)

5.Troubleshooting																	
Diagnosis	Countermeasure																
<p style="text-align: center;">Is the outdoor heat exchanger temperature thermistor connector connected properly?</p> <p style="text-align: right;">NO → Correct connector.</p> <p style="text-align: center;">YES</p> <p style="text-align: center;">For the characteristics of outdoor heat exchanger temperature thermistor, see the following graph.</p> <p style="text-align: center;">Are the characteristics of outdoor heat exchanger temperature thermistor OK?</p> <p style="text-align: right;">NO → Defective outdoor heat exchanger temperature thermistor → Replace.</p> <p style="text-align: right;">YES → Defective outdoor control PCB → Replace. (Defective outdoor heat exchanger temperature thermistor input circuit)</p>																	
<p style="text-align: center;">Temperature-resistance characteristics</p> <table border="1"> <caption>Temperature-resistance characteristics data points (approximate)</caption> <thead> <tr> <th>Temperature (°C)</th> <th>Resistance (kΩ)</th> </tr> </thead> <tbody> <tr> <td>0</td> <td>15</td> </tr> <tr> <td>10</td> <td>10</td> </tr> <tr> <td>20</td> <td>7</td> </tr> <tr> <td>25</td> <td>5</td> </tr> <tr> <td>30</td> <td>4</td> </tr> <tr> <td>40</td> <td>3</td> </tr> <tr> <td>50</td> <td>2</td> </tr> </tbody> </table>		Temperature (°C)	Resistance (kΩ)	0	15	10	10	20	7	25	5	30	4	40	3	50	2
Temperature (°C)	Resistance (kΩ)																
0	15																
10	10																
20	7																
25	5																
30	4																
40	3																
50	2																

Note:

Error code Remote control: E38	LED	Green	Red	Content Outdoor air temperature thermistor anomaly
	Indoor control PCB	Keeps flashing	Stays OFF	
	Outdoor control PCB	Keeps flashing	1-time flash	
	Outdoor inverter PCB	Yellow LED or Red LED Keeps flashing	Green LED Keeps flashing	

1.Applicable model
All models

2. Error detection method
Detection of anomalously low temperature (resistance) on outdoor air temperature thermistor

3. Condition of Error displayed
<ul style="list-style-type: none"> When the temperature thermistor detects -45°C or lower for 5 seconds continuously within 2 minutes to 2 minutes 20 seconds after the compressor ON, the compressor stops. After 3-minutes delay, the compressor starts again automatically, but if this anomalous temperature is detected 3 times within 40 minutes. When -45°C or lower is detected for 5 seconds continuously within 20 second after compressor ON.

4. Presumable cause
<ul style="list-style-type: none"> Defective outdoor control PCB Broken thermistor harness or temperature sensing section (Check molding.) Disconnected wire connection (connector)

5. Troubleshooting															
Diagnosis	Countermeasure														
<p style="text-align: center;">Is the outdoor air temperature thermistor connector connected properly?</p> <p style="text-align: center;">NO → Correct connector.</p> <p style="text-align: center;">YES</p> <p style="text-align: center;">Is the characteristics of the outdoor air temperature thermistor OK? <small>For the characteristics of outdoor air temperature thermistor, see the following graph.</small></p> <p style="text-align: center;">NO → Defective outdoor air temperature thermistor → Replace.</p> <p style="text-align: center;">YES → Defective outdoor control PCB → Replace. (Defective outdoor air temperature thermistor input circuit)</p>															
<p style="text-align: center;">Temperature-resistance characteristics</p> <table border="1"> <caption>Temperature-resistance characteristics data</caption> <thead> <tr> <th>Temperature (°C)</th> <th>Temperature thermistor resistance (kΩ)</th> </tr> </thead> <tbody> <tr><td>0</td><td>35</td></tr> <tr><td>10</td><td>25</td></tr> <tr><td>20</td><td>18</td></tr> <tr><td>30</td><td>12</td></tr> <tr><td>40</td><td>8</td></tr> <tr><td>50</td><td>5</td></tr> </tbody> </table>		Temperature (°C)	Temperature thermistor resistance (kΩ)	0	35	10	25	20	18	30	12	40	8	50	5
Temperature (°C)	Temperature thermistor resistance (kΩ)														
0	35														
10	25														
20	18														
30	12														
40	8														
50	5														

Note:

Error code Remote control: E39	LED	Green	Red	Content <h2 style="text-align: center;">Discharge pipe temperature thermistor anomaly</h2>
	Indoor control PCB	Keeps flashing	Stays OFF	
	Outdoor control PCB	Keeps flashing	1-time flash	
	Outdoor inverter PCB	Yellow LED or Red LED Keeps flashing	Green LED Keeps flashing	

1. Applicable model
All models

2. Error detection method
Detection of anomalously low temperature (resistance) on the discharge pipe temperature thermistor

3. Condition of Error displayed
When the temperature thermistor detects -10°C or lower for 5 seconds continuously within 10 minutes to 10 minutes 20 seconds after the compressor ON, the compressor stops. After 3-minutes delay, the compressor starts again automatically, but if this anomalous temperature is detected 3 times within 40 minutes.

4. Presumable cause
<ul style="list-style-type: none"> • Defective outdoor control PCB • Broken thermistor harness or temperature sensing section (Check molding.) • Disconnected wire connection (connector)

5. Troubleshooting	
Diagnosis	Countermeasure
<p>(Broken wire) Temperature-resistance characteristics</p> <p>(Short circuit)</p>	

Note:

Error code Remote control: E40	LED	Green	Red	Content High pressure error (63H1 activated)
	Indoor control PCB	Keeps flashing	Stays OFF	
	Outdoor control PCB	Keeps flashing	1-time flash	
	Outdoor inverter PCB	Yellow LED or Red LED Keeps flashing	Green LED Keeps flashing	

1. Applicable model
All models

2. Error detection method
When the high pressure switch 63H1 is activated.

3. Condition of Error displayed
If 63H1 turns OFF (opened), the compressor stops. After 3-minutes delay, the compressor restarts. If this anomaly occurs 5 times within 60 minutes or continues for 60 minutes continuously.

4. Presumable cause
<ul style="list-style-type: none"> • Short circuit of air flow, disturbance of air flow and clogging filter at outdoor heat exchanger/Breakdown of fan motor • Defective outdoor control PCB • Defective 63H1 connector • Defective electronic expansion valve connector • Closed service valve • Mixing of non-condensing gas (nitrogen, etc.)

5. Troubleshooting	
Diagnosis	Countermeasure
<p>If the power supply breaker is turned OFF and ON too quickly, E40 may be displayed. (This is normal.)</p>	
<p>Is the service valve fully opened?</p> <p>NO → Open service valve.</p> <p>YES →</p>	
<p>Has 63H1 activated?</p> <p>NO →</p> <p>YES →</p>	
<p>On operation of 63H1</p> <p>1. During cooling</p> <ul style="list-style-type: none"> • Is the outdoor fan motor running? • Isn't any short-circuit of air on the outdoor unit? • Are sufficient return air/supply air space secured? <p>2. During heating</p> <ul style="list-style-type: none"> • Isn't the indoor heat exchanger temperature thermistor disconnected from the thermistor casing? • Isn't the filter clogged? <p>* Under the condition of overcharging refrigerant, 63H1 may activate due to delay of starting the preventive control by compressor speed control, because detected heat exchanger temperature, which conducts compressor speed control, becomes lower than normal condition due to excess sub-cooling degree.</p>	
<p>Is 63H1 connector connected properly?</p> <p>NO → Correct 63H1 connector.</p> <p>YES →</p>	
<p>Is the electronic expansion valve connector connection OK?</p> <p>NO → Correct electronic expansion valve connector.</p> <p>YES →</p> <p>If any anomaly exists on the electronic expansion valve connector connection, the power supply must be reset.</p>	
<p>Defective outdoor control PCB → Replace. (Defective 63H1 input circuit)</p>	

Note: In the protective control range for compressor startup (initial startup after power ON), even if 63H1 is activated only once (63H1 turns OFF), immediately the error is displayed.

Error code Remote control: E41	LED	Green	Red	Content Power transistor overheat(1/2) (Models FDC100-140)
	Indoor control PCB	Keeps flashing	Stays OFF	
	Outdoor control PCB	Keeps flashing	1-time flash	
	Outdoor inverter PCB	Yellow LED 6-time flash		

1.Applicable model
Models FDC100-140

2.Error detection method
When less than DC14V of the output voltage is detected between ② and ③ on CNI3, E41 is displayed. (See "Note" mentioned below)

3.Condition of Error displayed
Seme as above.

4.Presumable cause
<ul style="list-style-type: none"> • Inverter PCB anomaly • Outdoor fan motor anomaly • Outdoor control PCB anomaly • Noise filter PCB anomaly

5.Troubleshooting	
Diagnosis	Countermeasure
<p>• Single phase models (FDC100-140VN)</p> <pre> graph TD Q1{Is DC15V detected between ② and ③ on CNI3? (1) (2)} Q2{Is DC15V detected after disconnecting outdoor fan motor? (1)} Q1 -- YES --> C1[Replace inverter PCB If not solved, replace Noise filter PCB as well] Q1 -- NO --> N1[Note(1) Under anomalous conditions, the voltage becomes less than DC14V.] N1 --> Q2 Q2 -- YES --> C2[Replace outdoor fan motor] Q2 -- NO --> C3[Replace outdoor control PCB If not solved, replace inverter PCB as well] </pre> <p>Note(2) How to check the voltage between ② and ③ of CNI3? ⇒See E51</p>	
<p>• 3-phase models (FDC100-140VS) E41⇒Replace inverter PCB.</p>	

Note: The "Single phase models" of inverter PAC have no function to output the signal for the power transistor overheat. However since the power source for the power transistor and the outdoor fan motor is in the same line, when the anomaly of the outdoor fan motor occurs, E41 is displayed.

Error code Remote control: E41	LED	Green	Red	Content Power transistor overheat(2/2) (Models FDC200, 250 only)
	Indoor control PCB	Keeps flashing	Stays OFF	
	Outdoor control PCB	Keeps flashing	1-time flash	
	Outdoor inverter PCB	Red LED 2-time flash	Green LED Keeps flashing	

1.Applicable model
Models FDC200, 250

2.Error detection method
When anomalously high temperature is detected by power transistor temperature thermistor (Tho-P1)

3.Condition of Error displayed
Anomalously high temperature of power transistor is detected 5 times within 60 minutes.

- 4.Presumable cause**
- Inverter PCB anomaly
 - Outdoor fan motor anomaly
 - Improperly fixing of power transistor to radiator fin
 - Power transistor temperature thermistor anomaly
 - Inadequate installation space of outdoor unit

5.Troubleshooting

Diagnosis	Countermeasure																		
<pre> graph TD Q1{Is it possible to reset the error for 10 minutes after compressor stopped?} -- NO --> A1[Replace inverter PCB] A1 --> Q2{Can error be reset?} Q2 -- YES --> OK1[OK] Q2 -- NO --> A2[Replace power transistor.] Q1 -- YES --> Q3{Is the installation space of outdoor unit enough?} Q3 -- NO --> A3[Correct it.] Q3 -- YES --> Q4{Is the outdoor fan running?} Q4 -- NO --> A4[Replace the outdoor fan motor or the outdoor control PCB.] Q4 -- YES --> Q5{Are the characteristics of power transistor temperature thermistor OK?} Q5 -- NO --> A5[Replace the power transistor temperature thermistor.] Q5 -- YES --> Q6{Is the connection of power transistor temperature thermistor connector OK?} Q6 -- NO --> A6[Connect it securely.] Q6 -- YES --> Q7{Is the fixing of power transistor to radiator fin OK?} Q7 -- NO --> A7[Fix properly.] Q7 -- YES --> Q8{Does the error recur?} Q8 -- YES --> Q1 Q8 -- NO --> OK2[OK] </pre>																			
<p>* Characteristics of power transistor temperature thermistor</p> <p>Temperature-resistance characteristics</p> <table border="1"> <caption>Temperature-resistance characteristics</caption> <thead> <tr> <th>Temperature (°C)</th> <th>Temperature thermistor resistance (kΩ)</th> </tr> </thead> <tbody> <tr><td>0</td><td>180</td></tr> <tr><td>20</td><td>100</td></tr> <tr><td>40</td><td>50</td></tr> <tr><td>60</td><td>30</td></tr> <tr><td>80</td><td>20</td></tr> <tr><td>100</td><td>15</td></tr> <tr><td>120</td><td>12</td></tr> <tr><td>140</td><td>10</td></tr> </tbody> </table>	Temperature (°C)	Temperature thermistor resistance (kΩ)	0	180	20	100	40	50	60	30	80	20	100	15	120	12	140	10	
Temperature (°C)	Temperature thermistor resistance (kΩ)																		
0	180																		
20	100																		
40	50																		
60	30																		
80	20																		
100	15																		
120	12																		
140	10																		

Note:

Error code Remote control: E42	LED	Green	Red	Content Current cut (1/2)
	Indoor control PCB	Keeps flashing	Stays OFF	
	Outdoor control PCB	Keeps flashing	1-time flash	
	Outdoor inverter PCB	Yellow LED or Red LED 1-time flash or 5-time flash	Green LED Keeps flashing	

1. Applicable model
All models

2. Error detection method
In order to prevent from overcurrent of inverter, if the current exceeds the specifications, it makes the compressor stopping.

3. Condition of Error displayed
<ul style="list-style-type: none"> • If the output current of inverter exceeds the specifications, it makes the compressor stopping. • After 3-minute delay, the compressor restarts, but if this anomaly occurs 4 times within 30 minute after the initial detection.

4. Presumable cause
<ul style="list-style-type: none"> • The valves closed • Faulty power supply • Insufficient refrigerant amount • Faulty compressor • Faulty power transistor module

5. Troubleshooting	
Diagnosis	Countermeasure
<pre> graph TD D1{Is the Power supply voltage OK?} -- NO --> C1[Check power supply.] D1 -- YES --> D2{Are the service valves opened?} D2 -- NO --> C2[Open the valves.] D2 -- YES --> D3{Is the high pressure during operation OK?} D3 -- NO --> C3[Check refrigerant amount and refrigerant circuit *In case of transitional increase of high pressure and/or test run, several times restarting may recover it, because liquid refrigerant (migrated) in the compressor is discharged from the compressor.] D3 -- YES --> D4{Is the checked result of insulation resistance and coil resistance (1) of compressor motor OK?} D4 -- NO --> C4[Replace compressor.] D4 -- YES --> E[To next page.] </pre>	

Note:

Error code Remote control:E42	LED	Green	Red	Content Current cut (2/2)
	Indoor	Keeps flashing	Stays OFF	
	Outdoor control PCB	Keeps flashing	1-time flash	
	Outdoor inverter PCB	Yellow LED or Red LED 1-time flash or 5-time flash	Green LED Keeps flashing	

1. Applicable model
All models

2. Error detection method
In order to prevent from overcurrent of inverter, if the current exceeds the specifications, it makes the compressor stopping.

3. Condition of Error displayed

- If the output current of inverter exceeds the specifications, it makes the compressor stopping.
- After 3-minute delay, the compressor restarts, but if this anomaly occurs 4 times within 30 minute after the initial detection.

4. Presumable cause

- Defective outdoor control PCB
- Defective inverter PCB
- Faulty power supply
- Insufficient refrigerant amount
- Faulty compressor
- Faulty power transistor module

5. Troubleshooting

Diagnosis	Countermeasure
<p>From previous page</p> <p>Is the checked result of power transistor module OK?</p> <p>NO → Defective inverter PCB → Replace. *For model 200, 250 replace also the power transistor module.</p> <p>YES</p> <div style="border: 1px dashed black; padding: 5px;"> <ul style="list-style-type: none"> • Is the space for installation of indoor and/or outdoor unit enough? • Is there any short circuit of air on indoor and/or outdoor unit? • At cooling, does the outdoor fan motor run? Are the service valves fully opened? Is the filter clogged? • At heating, does the indoor fan motor run? Are the service valves fully opened? Is the filter clogged? • Is there any liquid flooding? Is the superheat within normal range? Is the low pressure sensor and suction pipe temperature thermistor normal? • Is there any anomalous sound on the compressor? </div> <p>YES</p> <p>After resetting power for several times does it become normal?</p> <p>NO → Defective inverter PCB → Replace. *For model 200, 250 replace also the power transistor module.</p> <p>YES</p> <p>Temporary noise may cause of anomaly. If noise source can be found, take countermeasure.</p>	

Note:

Error code Remote control:E45	LED	Green	Red	Content Communication error between inverter PCB and outdoor control PCB
	Indoor control PCB	Keeps flashing	Stays OFF	
	Outdoor control PCB	Keeps flashing	1-time flash	
	Outdoor inverter PCB	Yellow LED or Red LED Keeps flashing	Green LED Keeps flashing	

1.Applicable model
All models

2.Error detection method
When the communication between inverter PCB and outdoor control PCB is not established.

3. Condition of Error displayed
Same as above.

4.Presumable cause
<ul style="list-style-type: none"> • Inverter PCB anomaly • Anomalous connection of connector between the outdoor control PCB and inverter PCB • Outdoor control PCB anomaly • Outdoor fan motor anomaly

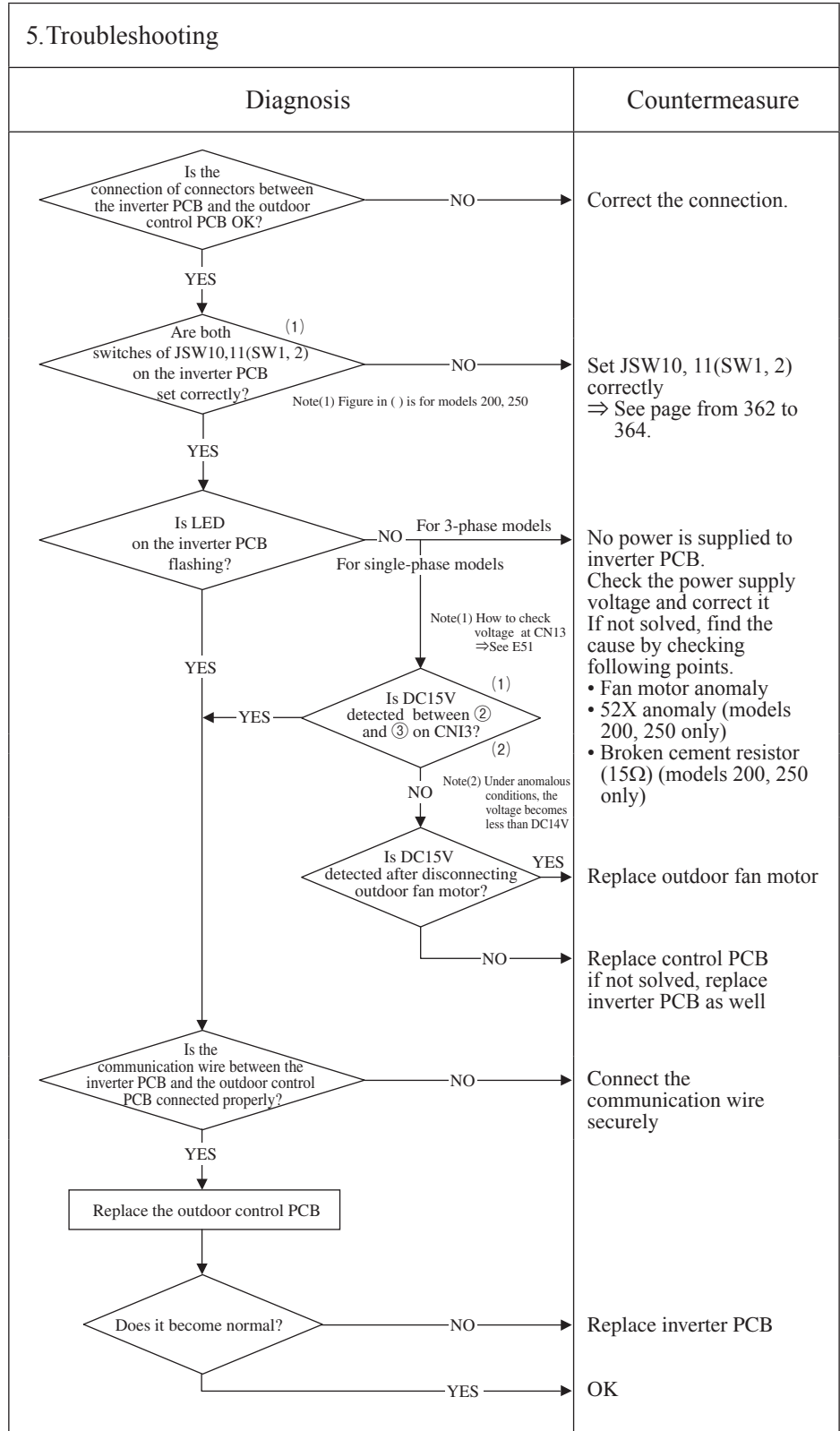

Note:

Error code Remote control:E48	LED	Green	Red	Content Outdoor fan motor anomaly
	Indoor control PCB	Keeps flashing	Stays OFF	
	Outdoor control PCB	Keeps flashing	1-time flash	
	Outdoor inverter PCB	Yellow LED or Red LED Keeps flashing	Green LED Keeps flashing	

1.Applicable model
All models

2. Error detection method
Detected by rotation speed of outdoor fan motor

3. Condition of Error displayed
When actual rotation speed of outdoor fan motor (FMo1) drops to 100min ⁻¹ or lower for 30 minutes continuously, the compressor and the outdoor fan motor stop. After 3-minutes delay, it starts again automatically, but if this anomaly occurs 5 times within 60 minutes after the initial detection.

4. Presumable cause
<ul style="list-style-type: none"> • Defective outdoor control PCB • Foreign material at rotational area of fan propeller • Defective fan motor • Dust on outdoor control PCB • Blow fuse • External noise, surge

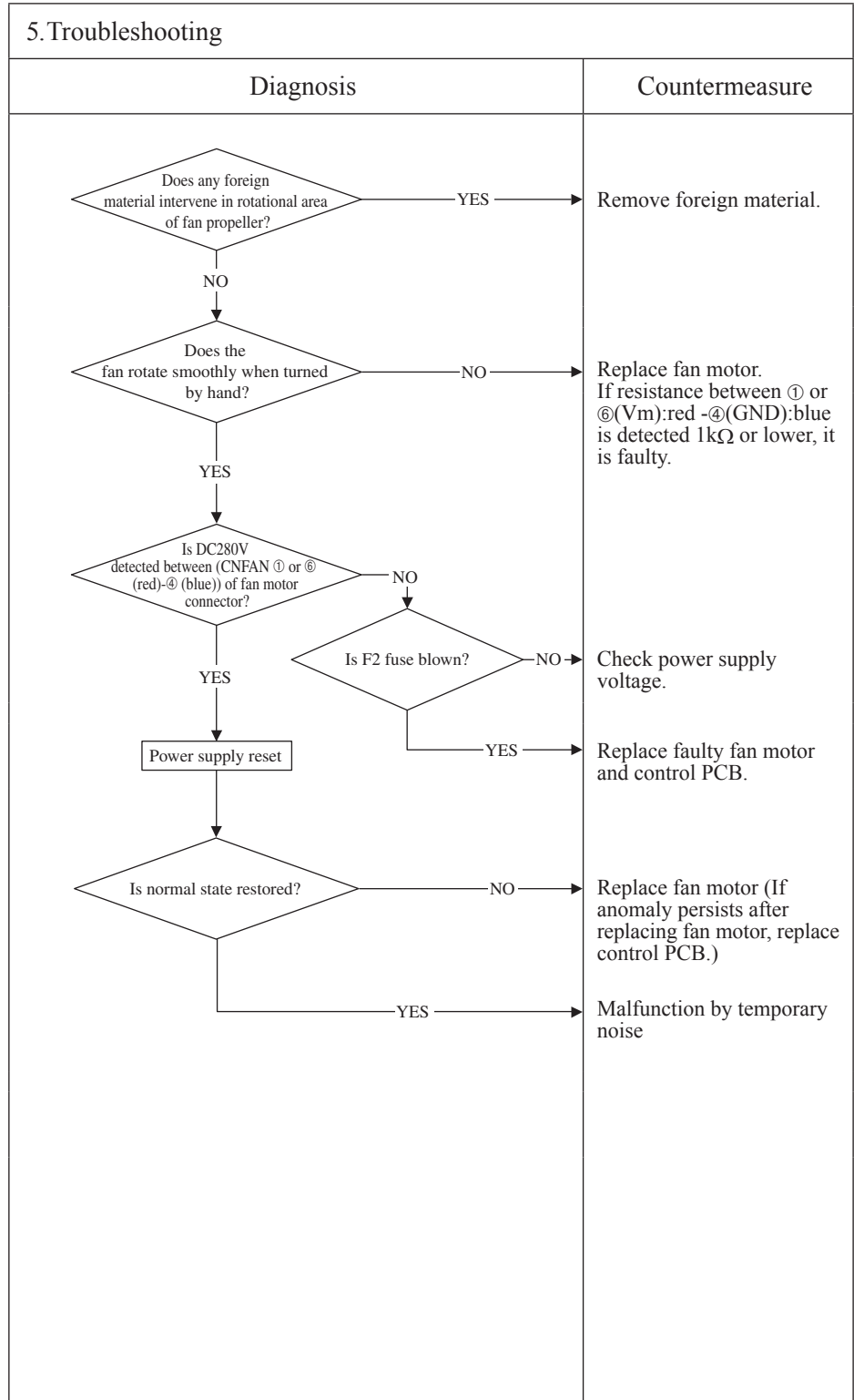

Note: When E48 error occurs, in almost cases F2 fuse (4A) on the outdoor control PCB is blown. There are a lot of cases that fuse is blown and E48 occurs due to defective fan motor. And even though only the outdoor control PCB (or fuse) is replaced, another trouble (*1) could occur. Therefore when fuse is blown, check whether the fan motor is OK or not.
 After confirming the fan motor normal, check by power ON. (Don't power ON without confirming the fan motor normal.)
 *1 The error which does not seem to relate E48 may occur like as “”, Stay OFF of LED on outdoor control PCB, inverter communication error (E45) and etc.

Error code Remote control:E49	LED	Green	Red	Content Low pressure error or low pressure sensor anomaly (1/2)
	Indoor control PCB	Keeps flashing	Stays OFF	
	Outdoor control PCB	Keeps flashing	1-time flash	
	Outdoor inverter PCB	Yellow LED or Red LED Keeps flashing	Green LED Keeps flashing	

1.Applicable model
All models

2.Error detection method
Detected by low pressure drop and suction superheat

3.Condition of Error displayed

- ① When the low pressure sensor detects 0.079MPa or lower for 15 seconds continuously, compressor stops and it restarts automatically after 3-minutes delay. And if this anomaly occurs 3 times within 60 minutes,
- ② 10 minutes after the compressor starts, if the low pressure sensor detects 0.15MPa or lower for 60 minutes continuously and compressor suction superheat is detected 30degC or higher for 60 minutes continuously. And if this anomaly occurs 3 times within 60 minutes,
- ③ If low pressure sensor detects 0.079MPa or lower for 5 minutes continuously (including the compressor stop status),

4.Presumable cause

- Defective outdoor control PCB
- Defective low pressure sensor connector
- Defective low pressure sensor
- Defective suction pipe temperature thermistor connector
- Defective suction pipe temperature thermistor

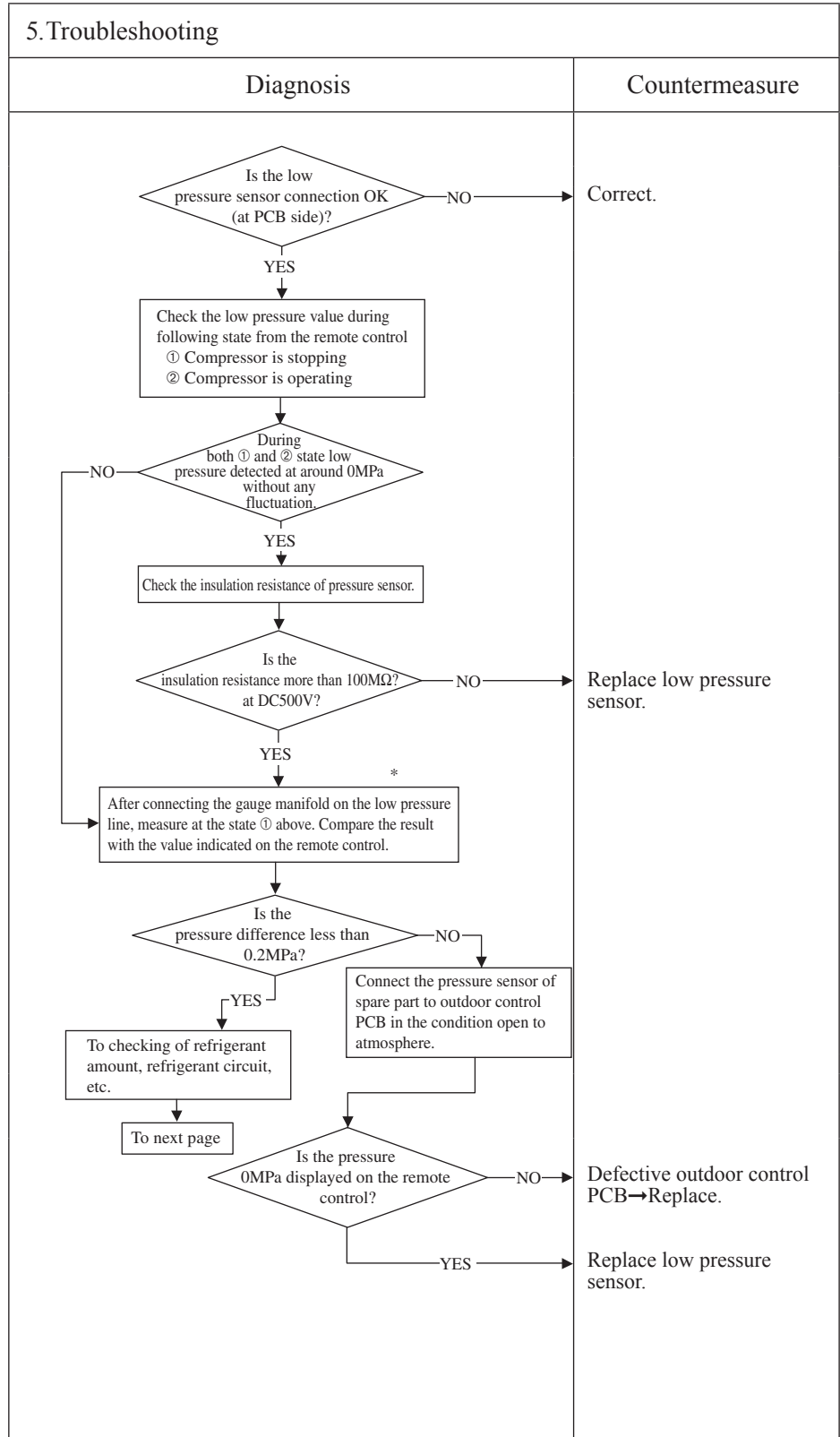

Note: * Connect the gauge manifold to the service valve check joint during cooling, or connect it to the check joint at internal piping of outdoor unit during heating.

Error code Remote control: E49	LED	Green	Red	Content Low pressure error or low pressure sensor anomaly (2/2)
	Indoor control PCB	Keeps flashing	Stays OFF	
	Outdoor control PCB	Keeps flashing	1-time flash	
	Outdoor inverter PCB	Yellow LED or Red LED Keeps flashing	Green LED Keeps flashing	

1. Applicable model
All models

2. Error detection method

3. Condition of Error displayed

4. Presumable cause

5. Troubleshooting	
Diagnosis	Countermeasure
<pre> graph TD Start[From previous page.] --> D1{Is the service valve fully opened?} D1 -- NO --> C1[Open fully.] D1 -- YES --> D2{Are the connections of low pressure sensor and suction pipe temperature thermistor connector OK?} D2 -- NO --> C2[Correct.] D2 -- YES --> D3{Are the characteristics of low pressure sensor, suction pipe temperature thermistor OK?} D3 -- NO --> C3["Defective low pressure sensor, suction pipe temperature thermistor -> Replace."] D3 -- YES --> D4{Is the low pressure normal during operation?} D4 -- NO --> C4[Charge refrigerant.] D4 -- YES --> C5["Defective outdoor control PCB -> Replace. (Defective low pressure sensor, suction pipe temperature thermistor circuits)"] </pre>	

Note:

Error code Remote control:E51	LED	Green	Red	Content Inverter and fan motor anomaly
	Indoor control PCB	Keeps flashing	Stays OFF	
	Outdoor control PCB	Keeps flashing	1-time flash	
	Outdoor inverter PCB	Yellow LED or Red LED 6-time flash or 2-time flash	Green LED Keeps flashing	

1.Applicable model
All models

2.Error detection method
When power transistor anomaly is detected for 15 minutes continuously

3.Condition of Error displayed
Same as above

4.Presumable cause
<ul style="list-style-type: none"> • Outdoor fan motor anomaly • Inverter PCB anomaly • Outdoor control PCB anomaly

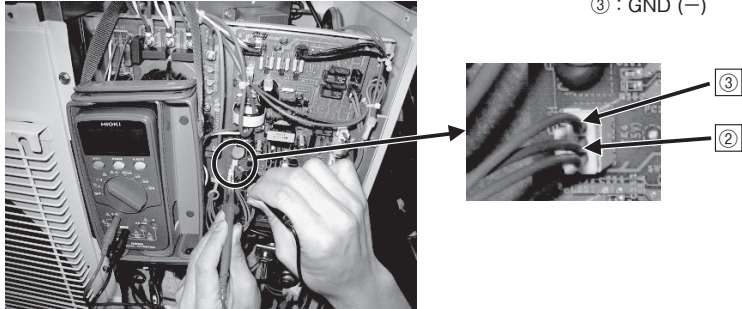
5.Troubleshooting	
Diagnosis	Countermeasure
<p>• Model FDC100-140VN</p> <p>Is DC15V (1) (2) detected between ② and ③ on CNI3?</p> <p>YES → Replace inverter PCB If not solved, replace Noise filter PCB as well.</p> <p>NO → Note(1) Under anomalous conditions, the voltage becomes less than DC14V.</p> <p>Is DC15V (1) detected after disconnecting outdoor fan motor?</p> <p>YES → Replace outdoor fan motor.</p> <p>NO → Replace outdoor control PCB If not solved, replace inverter PCB as well.</p> <p>• Model FDC100-140VS and FDC200, 250VS Replace immediately the inverter PCB and the power transistor.</p> <p>Note(2) How to check the voltage between ② and ③ of CNI3?</p>	
<p>② : 15V (+) ③ : GND (-)</p>	
	

Note:

Error code Remote control:E53	LED	Green	Red	Content Suction pipe temperature thermistor anomaly
	Indoor control PCB	Keeps flashing	Stays OFF	
	Outdoor control PCB	Keeps flashing	1-time flash	
	Outdoor inverter PCB	Yellow LED or Red LED Keeps flashing	Green LED Keeps flashing	

1.Applicable model
All models

2. Error detection method
When the suction pipe temperature thermistor detects anomalously low temperature

3. Condition of Error displayed
If the temperature thermistor detects -50°C or lower for 5 seconds continuously within 10 minutes to 10 minutes 20 seconds after compressor ON, the compressor stops. When the compressor is restarted automatically after 3-minutes delay, if this anomaly occurs 3 times within 40 minute.

4. Presumable cause
<ul style="list-style-type: none"> • Defective suction pipe temperature thermistor connection • Defective suction pipe temperature thermistor • Defective outdoor control PCB

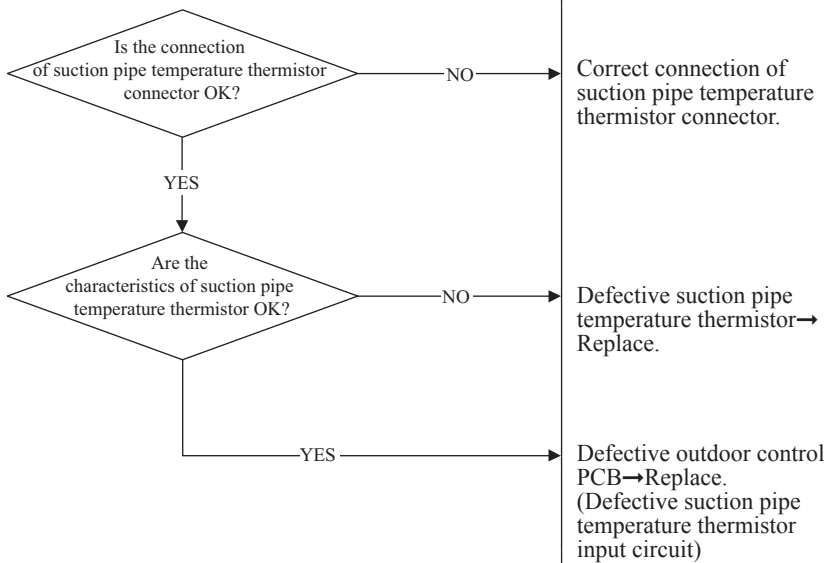
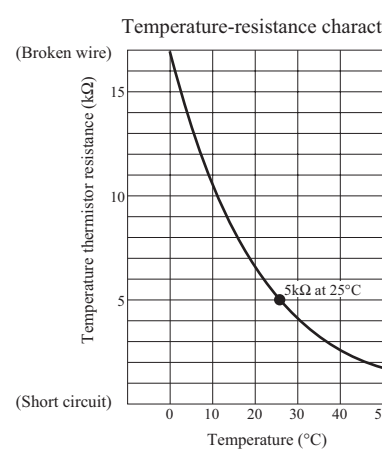
5.Troubleshooting																	
Diagnosis	Countermeasure																
 <pre> graph TD Q1{Is the connection of suction pipe temperature thermistor connector OK?} Q2{Are the characteristics of suction pipe temperature thermistor OK?} C1[Correct connection of suction pipe temperature thermistor connector.] C2[Defective suction pipe temperature thermistor -> Replace.] C3[Defective outdoor control PCB -> Replace. (Defective suction pipe temperature thermistor input circuit)] Q1 -- NO --> C1 Q1 -- YES --> Q2 Q2 -- NO --> C2 Q2 -- YES --> C3 </pre>																	
<p>Temperature-resistance characteristics</p>  <table border="1"> <caption>Temperature-resistance characteristics data points (approximate)</caption> <thead> <tr> <th>Temperature (°C)</th> <th>Thermistor resistance (kΩ)</th> </tr> </thead> <tbody> <tr> <td>0</td> <td>15</td> </tr> <tr> <td>10</td> <td>10</td> </tr> <tr> <td>20</td> <td>6</td> </tr> <tr> <td>25</td> <td>5</td> </tr> <tr> <td>30</td> <td>4</td> </tr> <tr> <td>40</td> <td>3</td> </tr> <tr> <td>50</td> <td>2</td> </tr> </tbody> </table>		Temperature (°C)	Thermistor resistance (kΩ)	0	15	10	10	20	6	25	5	30	4	40	3	50	2
Temperature (°C)	Thermistor resistance (kΩ)																
0	15																
10	10																
20	6																
25	5																
30	4																
40	3																
50	2																

Note:

Error code Remote control:E54	LED	Green	Red	Content Low pressure sensor anomaly
	Indoor control PCB	Keeps flashing	Stays OFF	
	Outdoor control PCB	Keeps flashing	1-time flash	
	Outdoor inverter PCB	Yellow LED or Red LED Keeps flashing	Green LED Keeps flashing	

1.Applicable model
All models

2. Error detection method
When anomalous voltage (pressure) is detected

3. Condition of Error displayed
If the pressure sensor detects 0V or lower and 4.0V or higher for 5 seconds continuously within 2 minutes to 2 minutes 20 seconds after compressor ON, the compressor stops. When the compressor is restarted automatically after 3-minuts delay, if this anomaly occurs 3 times within 40 minutes

4. Presumable cause
<ul style="list-style-type: none"> • Defective low pressure sensor connection • Defective low pressure sensor • Defective outdoor control PCB • Improper amount of refrigerant • Anomalous refrigeration circuit

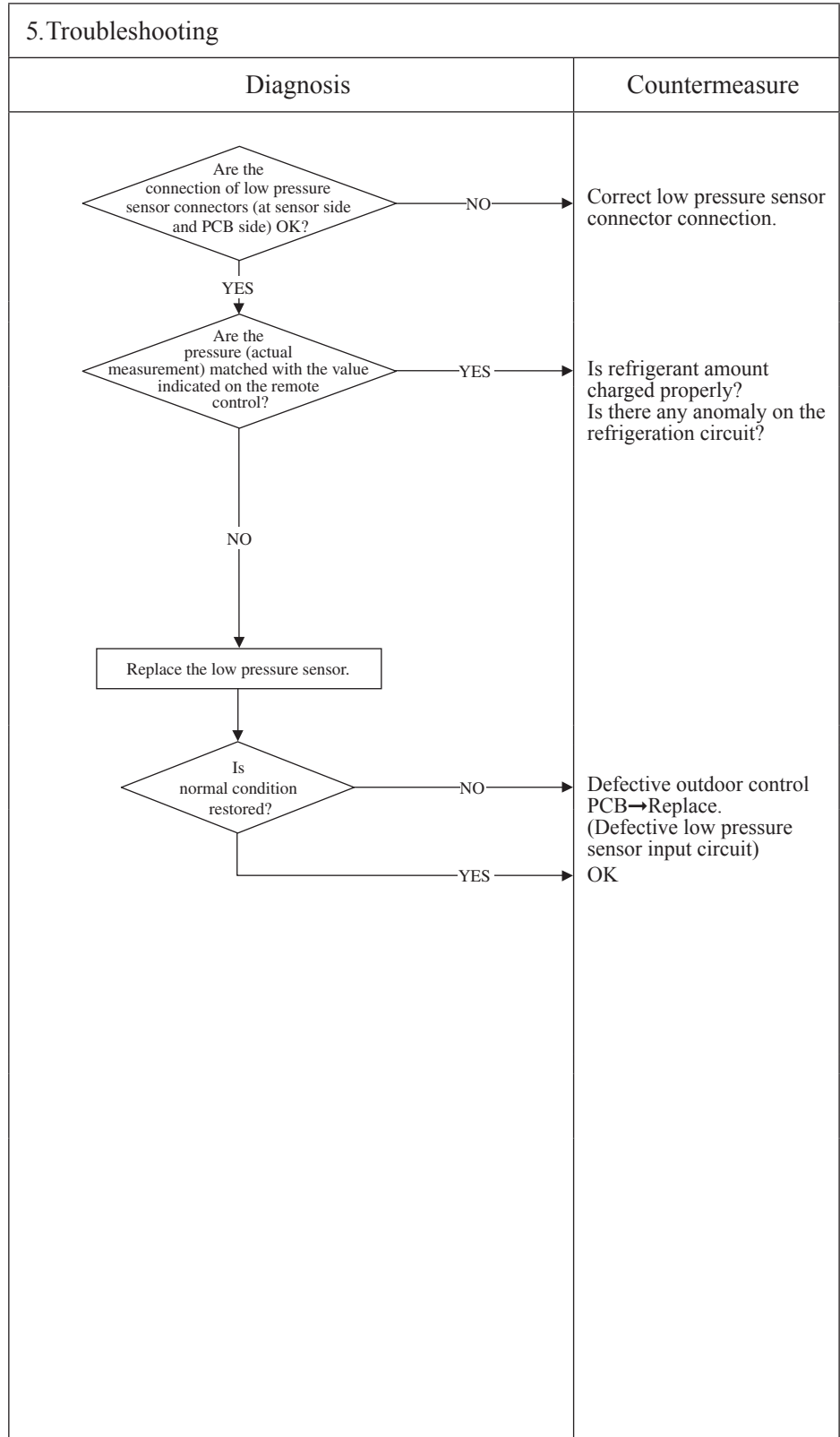

Note:

Error code Remote control:E55	LED	Green	Red	Content Underneath temperature thermistor anomaly (Models FDC200, 250 only)
	Indoor control PCB	Keeps flashing	Stays OFF	
	Outdoor control PCB	Keeps flashing	1-time flash	
	Outdoor inverter PCB	Red LED Keeps flashing	Green LED Keeps flashing	

1.Applicable model
Models FDC200, 250

2.Error detection method
When anomalous low temperature (resistance) is detected by the underneath temperature thermistor

3.Condition of Error displayed
If the temperature thermistor detects -50°C or lower for 5 seconds continuously within 10 minutes to 10 minutes 20 seconds after compressor ON, the compressor stops. When the compressor is restarted automatically after 3-minutes delay, if this anomaly occurs 3 times within 40 minute.

4.Presumable cause
<ul style="list-style-type: none"> • Defective underneath temperature thermistor connection • Defective underneath temperature thermistor • Defective outdoor control PCB

5.Troubleshooting	
Diagnosis	Countermeasure
<pre> graph TD A{Is the connection of underneath temperature thermistor connector OK?} -- NO --> B[Correct connection of underneath temperature thermistor connector.] A -- YES --> C{Are the characteristics of underneath temperature thermistor OK?} C -- NO --> D[Defective underneath temperature thermistor -> Replace.] C -- YES --> E[Replace outdoor control PCB. (Defective underneath temperature thermistor input circuit)] </pre>	
<p>(Broken wire)</p> <p>Temperature-resistance characteristics</p> <p>Temperature thermistor resistance (kΩ)</p> <p>Temperature (°C)</p> <p>5kΩ at 25°C</p> <p>(Broken wire)</p> <p>(Short circuit)</p>	

Note:

Error code Remote control:E57	LED	Green	Red	Content Insufficient refrigerant amount or detection of service valve
	Indoor control PCB	Keeps flashing	Stays OFF	
	Outdoor control PCB	Keeps flashing	1-time flash	
	Outdoor inverter PCB	Yellow LED or Red LED Keeps flashing	Green LED Keeps flashing	

1.Applicable model
All models

2. Error detection method
<ul style="list-style-type: none"> • Judge insufficient refrigerant amount by detecting the temperature difference between indoor heat exchanger (ThI-R) and indoor return air (ThI-A). • It detects at initial startup in cooling or dehumidifying mode after power ON.

3. Condition of Error displayed
Anomalous stop at initial detection

4. Presumable cause
<ul style="list-style-type: none"> • Defective indoor heat exchanger temperature thermistor • Defective indoor return air temperature thermistor • Defective indoor control PCB • Insufficient refrigerant amount

5. Troubleshooting

Diagnosis	Countermeasure
<p>Indoor heat exchanger, return air temperature thermistor Temperature-resistance characteristics</p> <p>(Broken wire)</p> <p>(Short circuit)</p>	

Note: Insufficient refrigerant amount preventive control makes compressor stopped, if it judges insufficient refrigerant amount by detecting the temperature difference between indoor heat exchanger (ThI-R) and return air temperature (ThI-A) for 1 minute after compressor ON in cooling or dehumidifying mode and for 9 minutes after compressor ON in heating mode. [in cooling mode: (ThI-A)-(ThI-R)>4degC, in heating mode: (ThI-R)-(ThI-A)<4degC]

Error code Remote control: E59	LED	Green	Red	Content Compressor startup failure (1/2)
	Indoor control PCB	Keeps flashing	Stays OFF	
	Outdoor control PCB	Keeps flashing	5-time flash	
	Outdoor inverter PCB	Yellow LED Red LED Stays OFF or 4-time flash	Green LED Keeps flashing	

1. Applicable model
All models

2. Error detection method
When it fails to change over to the operation for rotor position detection of compressor motor (If the compressor speed cannot increase 11Hz or higher)

3. Condition of Error displayed
If the compressor fails to startup for 20 times (10 patterns x2 times) continuously.

4. Presumable cause

- Outdoor fan motor anomaly
- Outdoor control PCB anomaly
- Inverter PCB anomaly
- Anomalous power supply voltage
- Insufficient or Excessive refrigerant amount
- Faulty component for refrigerant circuit
- Compressor anomaly (Motor or bearing)

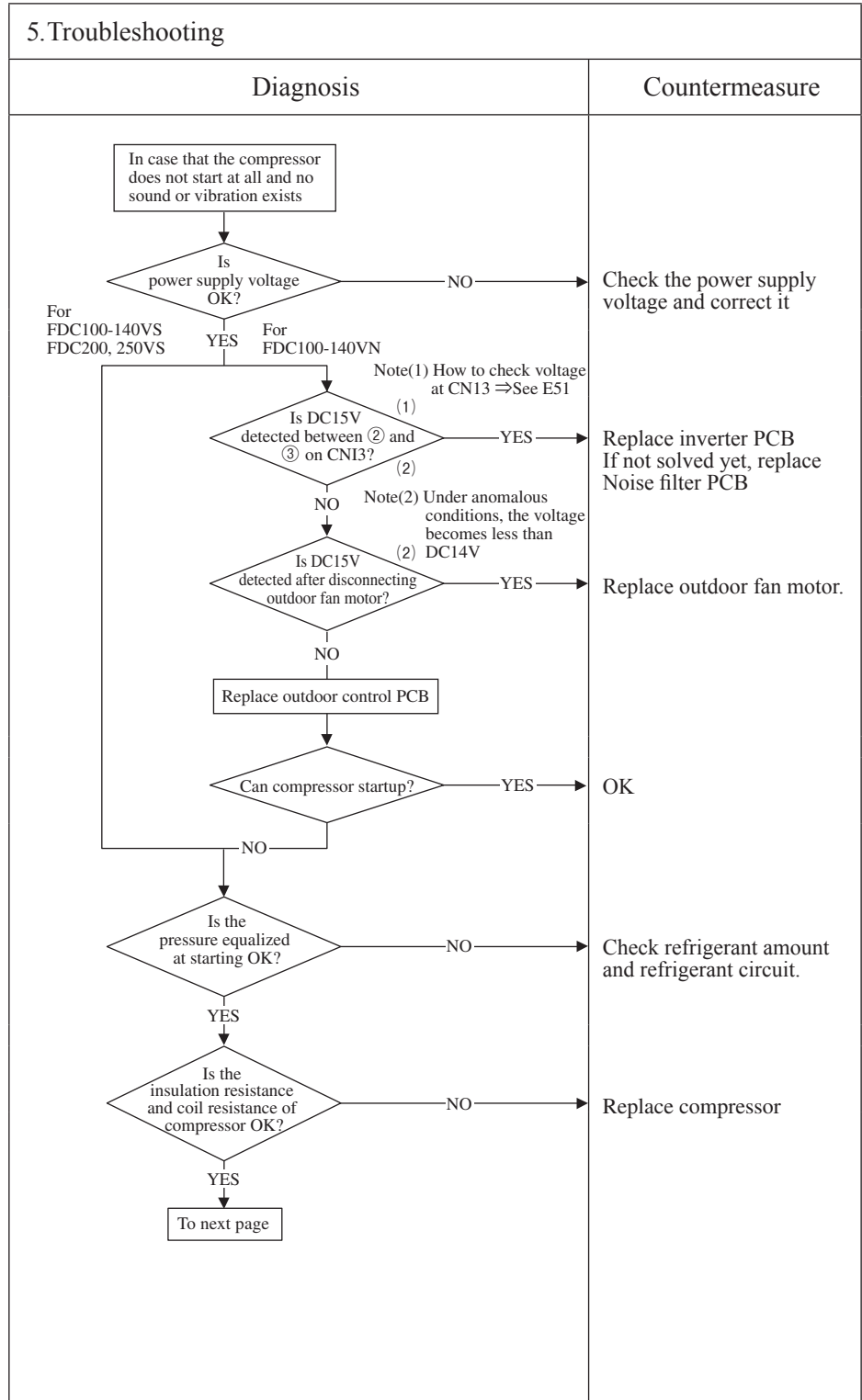

Note: Insulation resistance

- The unit is left for long period without power supply or soon after installation, insulation resistance may decrease to several MΩ or lower due to the liquid refrigerant migrated in the refrigerant oil in compressor. If the electric leakage breaker is activated due to low insulation resistance, check followings.
- ① Check whether the insulation resistance can recover or not, after 6 hours has passed since power ON.
(By energize the crankcase heater, liquid refrigerant migrated in the refrigerant oil in compressor can be evaporated)
- ② Check whether the electric leakage breaker conforms to high-harmonic specifications
(As INV PAC units has inverter, in order to prevent from improper operation, be sure to use the breaker of high-harmonic type)

Error code Remote control: E59	LED	Green	Red	Content Compressor startup failure (2/2)
	Indoor control PCB	Keeps flashing	Stays OFF	
	Outdoor control PCB	Keeps flashing	5-time flash	
	Outdoor inverter PCB	Yellow LED Red LED Stays OFF or 4-time flash	Green LED Keeps flashing	

1. Applicable model
All models

2. Error detection method

3. Condition of Error displayed

4. Presumable cause

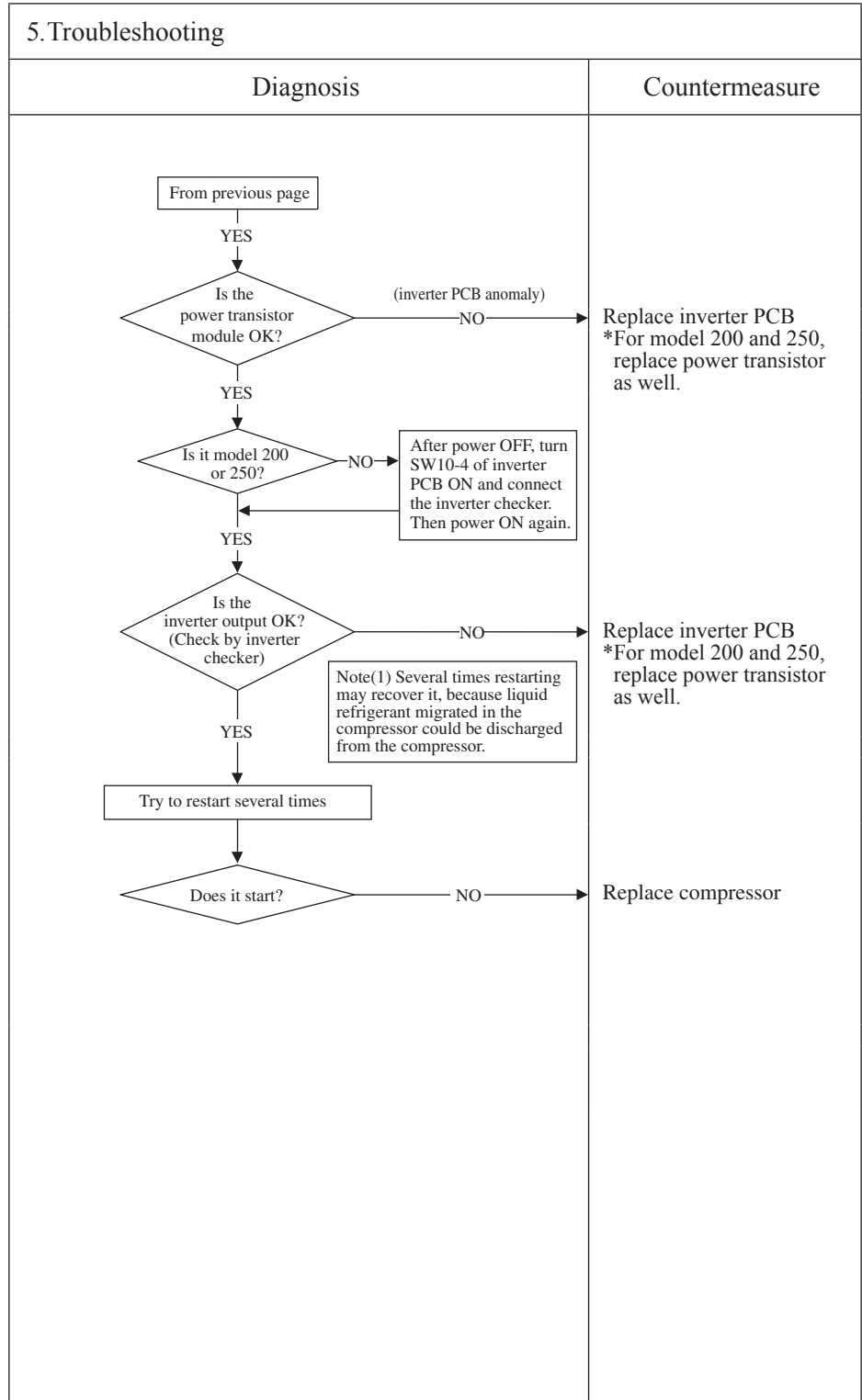

Note:

Error code Remote control:E60	LED	Green	Red	Content Compressor rotor lock error (Models FDC200, 250 only)
	Indoor control PCB	Keeps flashing	Stays OFF	
	Outdoor control PCB	Keeps flashing	1-time flash	
	Outdoor inverter PCB	Red LED Keeps flashing	Green LED Keeps flashing	

1.Applicable model
Models FDC200, 250

2. Error detection method
Compressor rotor position

3. Condition of Error displayed
If it fails again to detect the rotor position after shifting to the compressor rotor position detection operation, the compressor stops. <ul style="list-style-type: none"> When it is restart automatically after 3 minutes, it is detected 4 times within 15 minutes.

4. Presumable cause
<ul style="list-style-type: none"> Defective outdoor fan motor Defective outdoor control PCB Defective inverter PCB Anomalous power supply voltage Improper refrigerant amount and refrigerant circuit Defective compressor (motor, bearing)

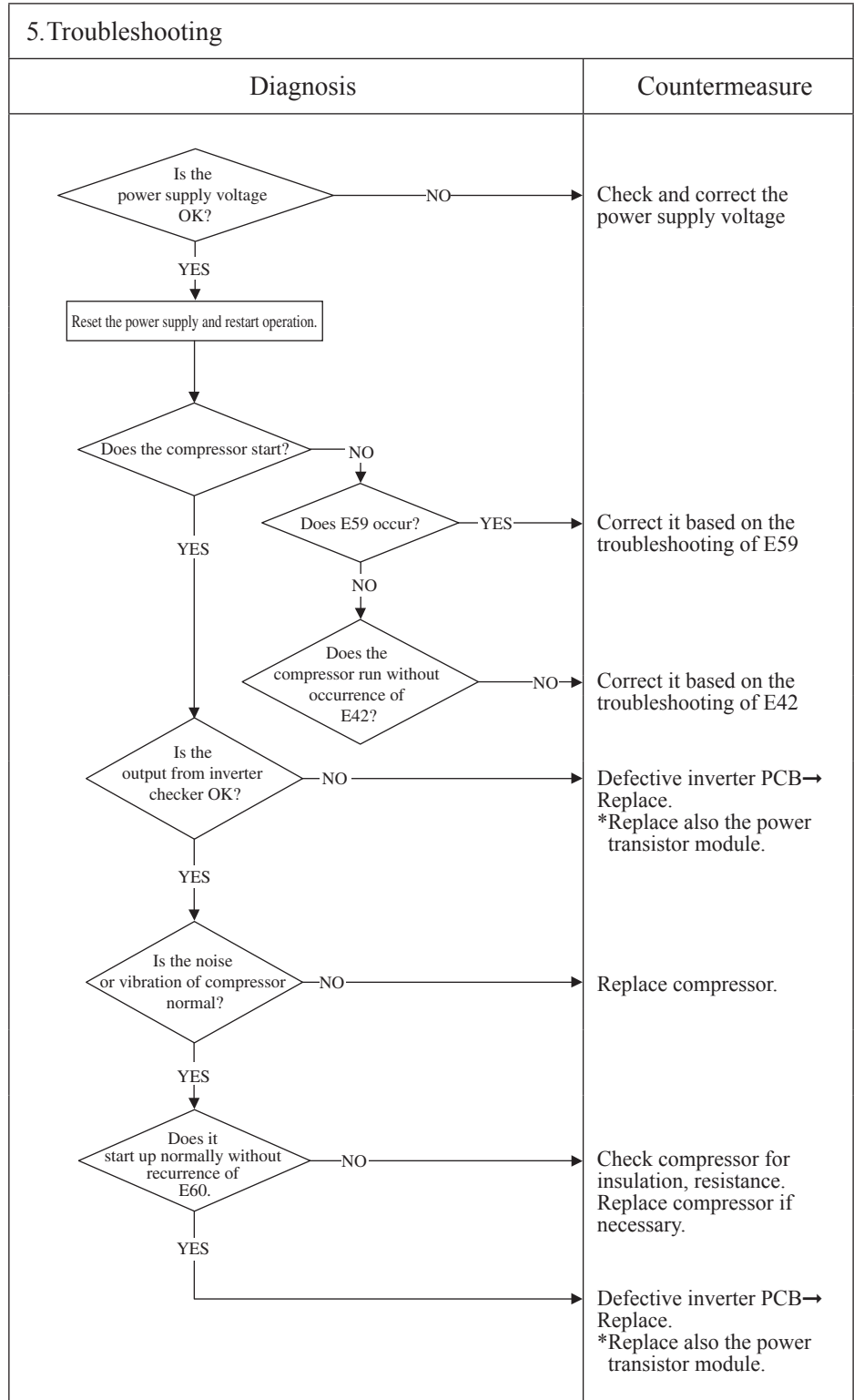

Note: Insulation resistance
 • The unit is left for long period without power supply or soon after installation, migrated liquid refrigerant may dissolve in the refrigerant oil in the compressor. In such case insulation resistance decreases upto several MΩ or lower. If the electric leakage breaker is activated due to low insulation resistance, check followings.
 ① Check whether the insulation resistance can recover or not, after 6 hours has passed since power ON.
 (By energize the crankcase heater, migrated liquid refrigerant in the refrigerant oil in compressor can be evaporated)
 ② Check whether the electric leakage breake conforms to high-hermonic specifications
 (As units has inverter, in order to prevent from improper operation, be sure to use high-hermonic one.)

(b) SRK series

Error code Remote control: None	Indoor display	RUN light —	TIMER light —	Content Operates but does not cool
	Outdoor control PCB	Green LED	Red LED	
		Keeps flashing	Stays OFF	

1. Applicable model
All models
2. Error detection method
3. Condition of Error displayed
4. Presumable cause
<ul style="list-style-type: none"> Poor compression of compressor Faulty expansion valve operation

5. Troubleshooting	
Diagnosis	Countermeasure
<p>Check the indoor unit fan operation. Check the temperature difference between return and supply air.</p> <pre> graph TD Start[Check indoor unit fan operation and temperature difference] --> D1{Is the temperature difference between return and supply air 10-20°C at cooling?} D1 -- YES --> D2{Does the heat load increase after installation?} D1 -- NO --> D3{Is the compressor operating?} D2 -- NO --> C1[It is normal. (This unit is designed to start in the soft start mode by detecting the under dome temperature of compressor when it restart after power reset.)] D2 -- YES --> B1[Mistake in model selection. Calculate heat load once more.] B1 --> C2[It is necessary to replace to higher capacity one or to install additional unit.] D3 -- NO --> D4{"WAIT" message is displayed (for 3 seconds) when performing cooling, defrosting and heating operations from the remote control.} D3 -- YES --> D5{Is the compressor rotation speed low?} D4 -- YES --> C3[Compressor refrigerant oil protection control at starting is activated. For the contents of control, refer to the compressor start control of the microcomputer control functions.] D4 -- NO --> C4[Compressor may be stopped by the error detection control. For the contents of control, refer to anomalous stop control by controlling compressor rotation speed of microcomputer control functions.] D5 -- NO --> C5[Inspect the followings. • Minor clogging of filter • Minor clogging of heat exchanger • Minor short-circuit • Minor shortage of refrigerant amount • Poor compression of compressor] D5 -- YES --> B2[Check which control "Determination control of compressor rotation speed" or "Protective control by controlling compressor rotation speed" is appropriate to this phenomenon.] B2 --> D6{Are the temperature conditions of room and outdoor air close to the rated conditions? (1)} D6 -- YES --> C6[Considering appropriate operation control, check suspicious points. Inspect the followings for reference. • Major clogging of filter • Major clogging of heat exchanger • Major short-circuit • Major shortage of refrigerant amount • Compressor protection ON • Indoor fan tap • Valid setting of silent mode] D6 -- NO --> B3[The unit is operating normally but is operating under the control for protecting compressor or other respective parts.] </pre>	

Note:

Error code Remote control:None	Indoor display	RUN light -	TIMER light -	Content Operates but does not heat
	Outdoor control PCB	Green LED Keeps flashing	Red LED Stays OFF	

1. Applicable model
All models
2. Error detection method
3. Condition of Error displayed
4. Presumable cause
<ul style="list-style-type: none"> Faulty 4-way valve operation Poor compression of compressor Faulty expansion valve operation

5. Troubleshooting	
Diagnosis	Countermeasure
<p>Check the indoor unit fan operation. Check the temperature difference between return and supply air.</p> <pre> graph TD Start[Check indoor unit fan operation and temperature difference] --> D1{Is the temperature difference between return and supply air 10-30°C at heating?} D1 -- YES --> D2{Does the heat load increase after installation?} D1 -- NO --> D3{Is the compressor operating?} D2 -- YES --> Box1[Mistake in model selection. Calculate heat load once again.] D2 -- NO --> D4{“WAIT” message is displayed for 3 seconds when performing cooling, defrosting and heating operations from the remote control.} D3 -- NO --> D4 D3 -- YES --> D5{Is the compressor rotation speed low?} Box1 --> CM1[It is necessary to replace to higher capacity one or to install additional unit.] D4 -- YES --> CM2[Compressor refrigerant oil protection control at starting is activated. For the contents of control, refer to the compressor start control of the microcomputer control functions.] D4 -- NO --> CM3[Compressor may be stopped by the error detection control. For the contents of control, refer to anomalous stop control by controlling compressor rotation speed of microcomputer control functions.] D5 -- NO --> CM4[Inspect the followings. • Minor clogging of filter • Minor clogging of heat exchanger • Minor short-circuit • Minor shortage of refrigerant amount • Poor compression of compressor] D5 -- YES --> Box2[Check which control “Determination control of compressor rotation speed” or “Protective control by controlling compressor rotation speed” is appropriate to this phenomenon.] Box2 --> D6{Are the temperature conditions of room and outdoor air close to the rated conditions? (1)} D6 -- YES --> CM5[Considering appropriate operation control, check suspicious points. Inspect the followings for reference. • Major clogging of filter • Major clogging of heat exchanger • Major short-circuit • Major shortage of refrigerant amount • Compressor protection ON • Indoor fan tap • Valid setting of silent mode] D6 -- NO --> Box3[The unit is operating normally but is operating under the control for protecting compressor or other respective parts.] </pre>	

Note:

Error code Remote control: None	Indoor display	RUN light —	TIMER light —	Content Earth leakage breaker activated
	Outdoor control PCB	Green LED Stays OFF	Red LED Stays OFF	

1. Applicable model
All models
2. Error detection method
3. Condition of Error displayed
4. Presumable cause
<ul style="list-style-type: none"> • Defective compressor • Noise

5. Troubleshooting	
Diagnosis	Countermeasure
<pre> graph TD D1{Are OK the insulation resistance and coil resistance of compressor?} D2{Is insulation of respective harnesses OK? Is any harness bitten between pannel and casing or etc?} P1[Check the outdoor unit grounding wire/earth leakage breaker.] C1[Replace compressor.*] C2[Secure insulation resistance.] D1 -- NO --> C1 D1 -- YES --> D2 D2 -- NO --> C2 D2 -- YES --> P1 </pre>	
<p>Check of the outdoor unit grounding wire/earth leakage breaker</p> <p>① Run an independent grounding wire from the grounding screw of outdoor unit to the grounding terminal on the distribution panel. (Do not connect to another grounding wire.)</p> <p>② In order to prevent malfunction of the earth leakage breaker itself, confirm that it is conformed to higher harmonic regulation.</p> <p>* Insulation resistance of compressor</p> <ul style="list-style-type: none"> • Immediately after installation or when the unit has been left for long time without power supply, the insulation resistance may drop to a few MΩ because of refrigerant migrated in the compressor. <p>When the earth breaker is activated at lower insulation resistance, check the following points.</p> <p>① 6 hours after power ON, check if the insulation resistance recovers to normal.</p> <p>When power ON, crankcase heater heat up compressor and evaporate the refrigerant migrated in the compressor.</p> <p>② Check if the earth leakage breaker is conformed to higher harmonic regulation or not.</p> <p>Since the unit is equipped with inverter, it is necessary to use components conformed to higher harmonic regulation in order to prevent malfunction of earth leakage breaker.</p>	

Note:

Error code Remote control:None	Indoor display	RUN light -	TIMER light -	Content Excessive noise/vibration (1/3)
	Outdoor control PCB	Green LED -	Red LED -	

1. Applicable model
All models

2. Error detection method

3. Condition of Error displayed

- 4. Presumable cause**
- ① Improper installation work
 - Improper anti-vibration work at installation
 - Insufficient strength of mounting face
 - ② Defective product
 - Before/after shipping from factory
 - ③ Improper adjustment during commissioning
 - Excess/shortage of refrigerant, etc.

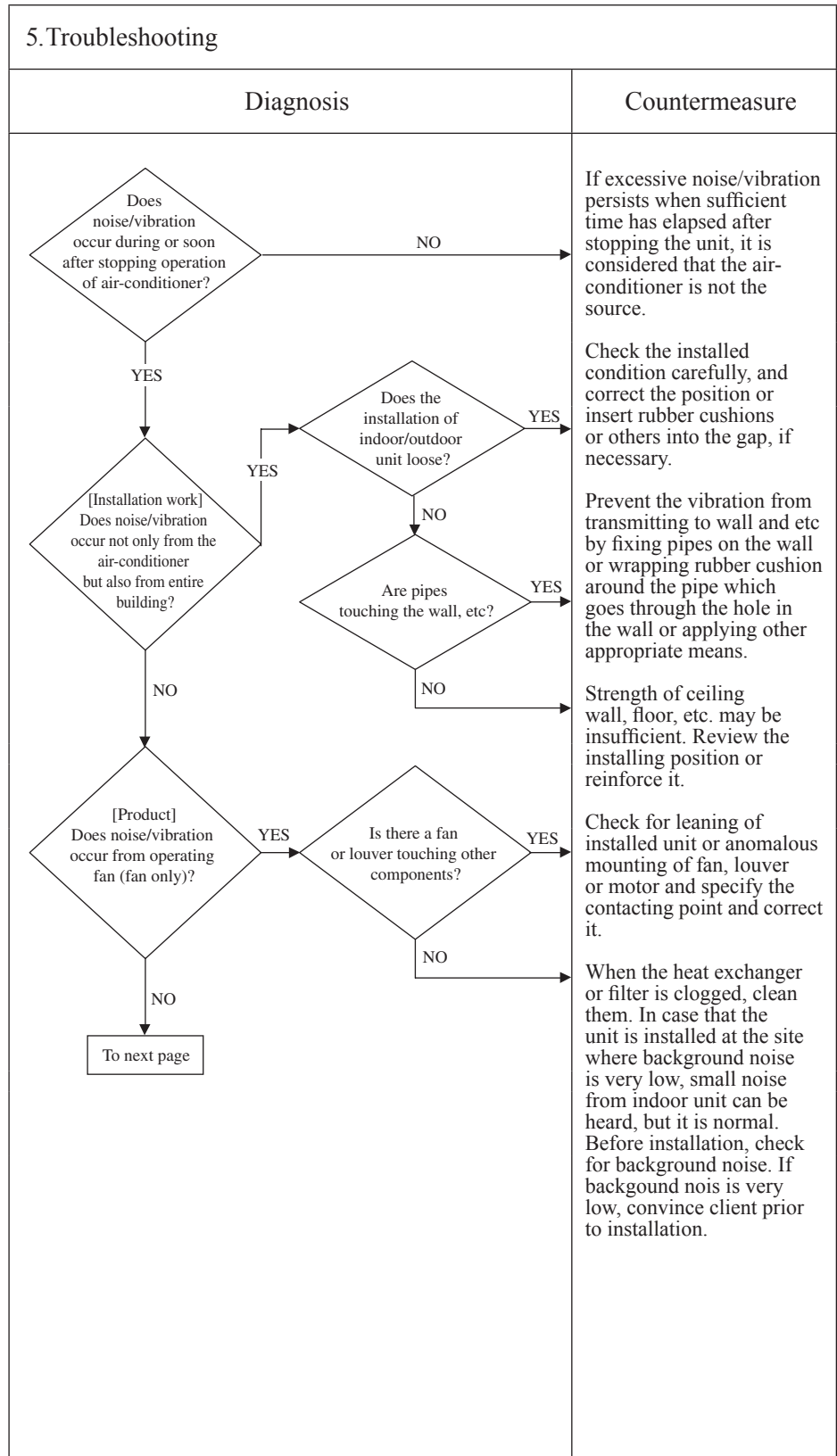

Note:

Error code Remote control: None	Indoor display	RUN light -	TIMER light -	Content Excessive noise/vibration (2/3)
	Outdoor control PCB	Green LED -	Red LED -	

1. Applicable model All models
2. Error detection method
3. Condition of Error displayed
4. Presumable cause

5. Troubleshooting	
Diagnosis	Countermeasure
<pre> graph TD Start([From previous page]) --> D1{[Unit side] Does noise/vibration occur when the cooling/heating operation is performed normally?} D1 -- YES --> D2{Are the pipes contacting the casing?} D1 -- NO --> End1([To next page]) D2 -- YES --> C1[Rearrange the piping to avoid contact with the casing.] D2 -- NO --> D3{Is it heard continuous hissing or roaring sound?} D3 -- YES --> C2[It is noise/vibration that is generated when the refrigerant gas or liquid flow through inside of piping of air-conditioner. It is likely to occur particularly during cooling or defrosting in the heating mode. It is normal.] D3 -- NO --> D4{Are hissing sounds heard at the startup or stopping?} D4 -- YES --> C3[The noise/vibration occurs when the refrigerant starts or stops flowing. It is normal.] D4 -- NO --> D5{Is blowing sound heard at the start/stop of defrosting during heating?} D5 -- YES --> C4[When the defrosting starts or stops during heating, the refrigerant flow is reversed due to switching 4-way valve. This causes a large change in pressure which produces a blowing sound. It may accompany also the hissing sounds as mentioned above. They are normal.] D5 -- NO --> D6{Is cracking noise heard during heating operation?} D6 -- YES --> C5[After the start or stop of heating operation or during defrosting, abrupt changes in temperature cause resin parts to shrink or expand. This is normal.] D6 -- NO --> D7{Hissing noise is heard during cooling operation or after stopping.} D7 -- YES --> C6[It is the sound produced by the drain pump that discharges drain from the indoor unit. The pump continues to run for 5 minutes after stopping the cooling operation. This is normal.] D7 -- NO --> C7[Apply the damper sealant at places considered to be the sources such as the pressure reducing mechanism (expansion valve), capillary, etc.] </pre>	

Note:

Error code Remote control:None	Indoor display	RUN light -	TIMER light -	Content Excessive noise/vibration (3/3)
	Outdoor control PCB	Green LED -	Red LED -	

<p>1. Applicable model</p> <p>All models</p>	5. Troubleshooting	
<p>2. Error detection method</p>	Diagnosis	Countermeasure
<p>3. Condition of Error displayed</p>	<div style="text-align: center;"> <p>From previous page</p> </div>	
<p>4. Presumable cause</p>	<p>If insufficient cooling/heating problem happens due to anomalous operating conditions at cooling/heating, followings are suspicious.</p> <ul style="list-style-type: none"> • Overcharge of refrigerant • Insufficient charge of refrigerant • Intrusion of air, nitrogen, etc. <p>In such occasion, it is necessary to recover refrigerant, vacuum-dry and recharge refrigerant.</p> <p>* Since there could be many causes of noise/vibration, the above do not cover all. In such case, check the conditions when, where, how the noise/vibration occurs according to following check point.</p> <ul style="list-style-type: none"> • Indoor/outdoor unit • Cooling/heating/fan mode • Startup/stop/during operation • Operating condition (Indoor/outdoor temperatures, pressure) • Time it occurred • Operation data retained by the remote controller such as compressor rotation speed, heat exchanger temperature, EEV opening degree, etc. • Tone (If available, record the noise) • Any other anomalies 	

Note:

Error code Remote control: None	Indoor display	RUN light -	TIMER light -	Content <h2>Louver motor failure</h2>
	Outdoor control PCB	Green LED Keeps flashing	Red LED Stays OFF	

1. Applicable model
All models

2. Error detection method

3. Condition of Error displayed

4. Presumable cause
<ul style="list-style-type: none"> • Defective LM • LM wire breakage • Faulty indoor control PCB

5. Troubleshooting	
Diagnosis	Countermeasure
<p>▲ Check at the indoor unit side.</p> <div style="border: 1px solid black; padding: 5px; width: fit-content; margin-bottom: 10px;">Operate after waiting for more than 1 minute.</div> <pre> graph TD Start[Operate after waiting for more than 1 minute.] --> Q1{Does the louver operate at the power on?} Q1 -- NO --> Q2{Is LM wiring broken?} Q2 -- YES --> C1[Repair wiring.] Q2 -- NO --> Q3{Is LM locked?} Q3 -- YES --> C2[Replace LM.] Q3 -- NO --> C3[Defective indoor control PCB → Replace.] Q1 -- YES --> Q4{Is the louver operable with the remote control?} Q4 -- YES --> C4[Normal] Q4 -- NO --> C5[Adjust LM lever and then check again.] </pre> <p style="text-align: center;">LM: louver motor</p>	

Note:

Error code Remote control:None	Indoor display	RUN light -	TIMER light -	Content Power supply system error (Power supply to indoor control PCB)
	Outdoor control PCB	Green LED Stays OFF	Red LED 2-time flash	

1. Applicable model
All models

2. Error detection method

3. Condition of Error displayed

4. Presumable cause
<ul style="list-style-type: none"> • Misconnection or breakage of connecting wires • Blown fuse • Faulty indoor control PCB • Broken harness • Faulty outdoor control PCB (Noise filter)

5. Troubleshooting	
Diagnosis	Countermeasure
<pre> graph TD D1{Is AC220/240V detected between 1 and 2 on the terminal block of indoor unit?} D2{Is AC380/415V for 3-phase unit detected between 1, 2 and 3 on the terminal block of outdoor unit or is AC220/240V for 1-phase unit detected between 1 and 2 on the terminal block of outdoor unit?} D3{Are fuse OK (250V 3.15A)?} D1 -- YES --> D3 D1 -- NO --> D2 D2 -- YES --> C1[Misconnection or breakage of connecting wires] D2 -- NO --> C2[Defective outdoor control PCB (Noise filter)] D3 -- YES --> C3[Defective indoor control PCB -> Replace.] D3 -- NO --> C4[Replace fuse.] </pre>	

Note:

Error code Remote control:None	Indoor display	RUN light -	TIMER light -	Content Power supply system error (Power supply to remote control)
	Outdoor control PCB	Green LED Keeps flashing	Red LED 2-time flash	

1.Applicable model
All models

2.Error detection method

3.Condition of Error displayed

- 4.Presumable cause**
- Remote control wire breakage/short-circuit
 - Defective remote control
 - Malfunction by noise
 - Broken harness
 - Faulty indoor control PCB
 - Faulty interface kit

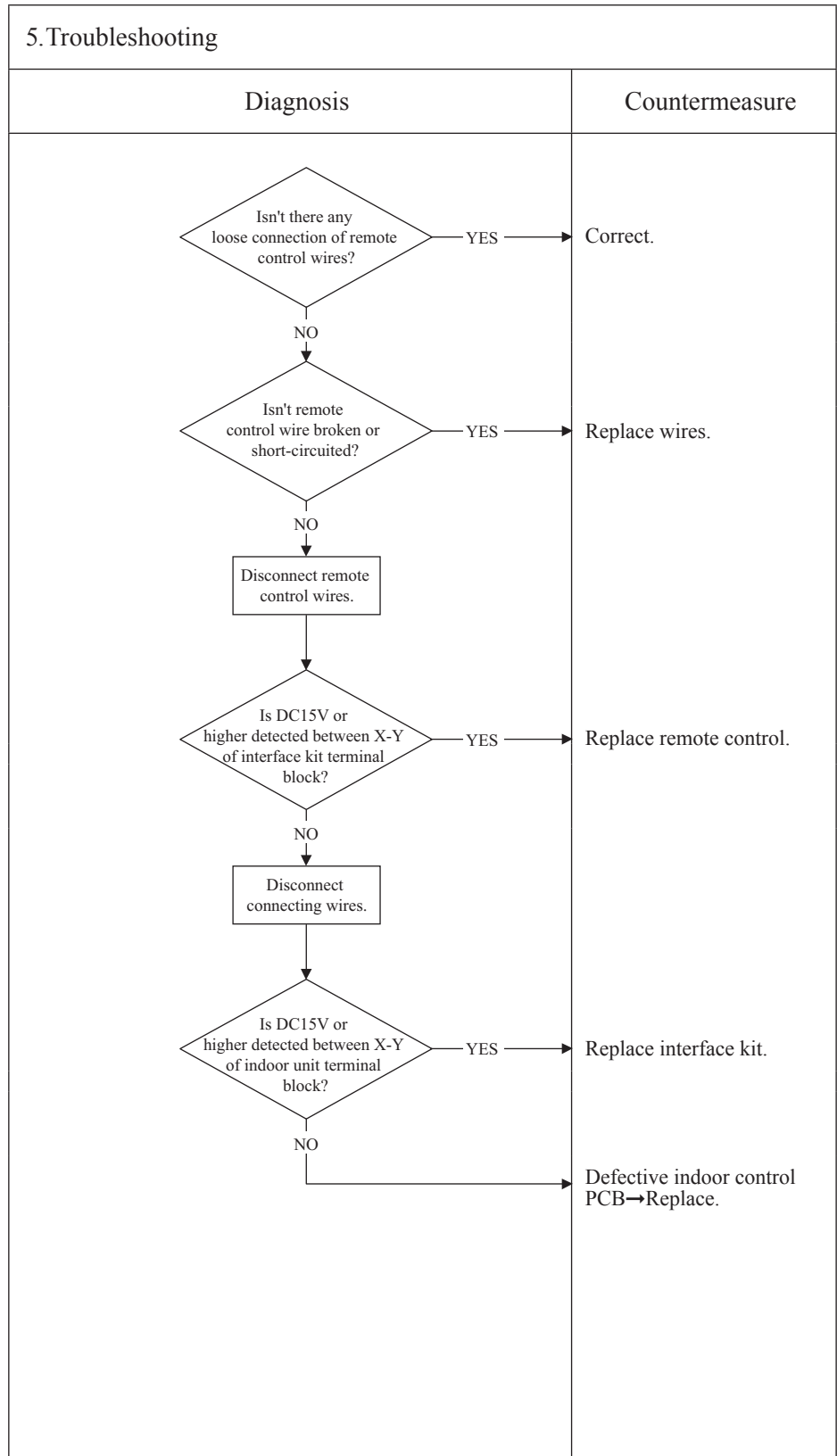

Note:

Error code Remote control: None	Indoor display	RUN light Stays OFF	TIMER light Keeps flashing	Content <h2 style="text-align: center;">Limit switch anomaly</h2>
	Outdoor control PCB	Green LED Keeps flashing	Red LED Stays OFF	

1. Applicable model
All models

2. Error detection method
The limit switch operates when the indoor unit is stopped.

3. Condition of Error displayed
Same as above

4. Presumable cause
<ul style="list-style-type: none"> • Defective Limit switch • Faulty indoor control PCB

5. Troubleshooting	
Diagnosis	Countermeasure
<pre> graph TD A{Is the inlet panel set correctly?} -- NO --> B[Correction, re-set] A -- YES --> C{Are limit switch OK? (1)} C -- NO --> D[Defective limit switch -> Replace.] C -- YES --> E[Defective indoor control PCB -> Replace. (Defective limit switch input circuit)] </pre>	
<p>Note (1) Check the operation of limit switch by checking if the error can be rest or not by pushing the limit switch by finger when the inlet panel is removed.</p>	

Note:

Error code Remote control:INSPECT I/U	Indoor display	RUN light -	TIMER light -	Content INSPECT I/U (When 1 or 2 remote controls are connected)
	Outdoor control PCB	Green LED	Red LED	
		Keeps flashing	2-time flash	

1. Applicable model
All models
2. Error detection method
Communication between indoor unit and remote control is disabled for more than 30 minutes after the power on.
3. Condition of Error displayed
Same as above
4. Presumable cause
<ul style="list-style-type: none"> • Improper setting • Surrounding environment • Defective remote control communication circuit • Faulty interface kit PCB

5. Troubleshooting	
Diagnosis	Countermeasure
<pre> graph TD Q1{Are 2 units of remote control connected?} Q2{Is it set at the slave remote control?} Q3{Does it become normal?} Q4{Do more than one interface kit have the same address?} Q5{Are remote control wires laid along high voltage wires?} Q6{Is approx. DC20V detected between ②-③ on the interface kit terminal block?} Q7{Is approx. DC20V detected between ②-③ on the remote control terminal block?} Q1 -- YES --> S1[Set one remote control for "Master" and the other for "Slave"] S1 --> Q3 Q3 -- NO --> Q4 Q3 -- YES --> Q1 Q1 -- NO --> Q2 Q2 -- YES --> C1[Set SW1 on remote control PCB at "Master".] Q2 -- NO --> Q4 Q4 -- YES --> C2[Set address again. (SW3 on interface kit PCB)] Q4 -- NO --> Q5 Q5 -- YES --> C3[Separate remote control wires from high voltage wires.] Q5 -- NO --> Q6 Q6 -- YES --> C4[Defective interface kit PCB -> Replace.] Q6 -- NO --> Q7 Q7 -- YES --> C5[Defective remote control PCB -> Replace.] Q7 -- NO --> C6[Broken connecting wire -> Correct.] </pre>	<p>Set SW1 on remote control PCB at "Master".</p> <p>Set address again. (SW3 on interface kit PCB)</p> <p>Separate remote control wires from high voltage wires.</p> <p>Defective interface kit PCB → Replace.</p> <p>Broken connecting wire → Correct.</p> <p>Defective remote control PCB → Replace.</p>

Note: If any error is detected 30 minutes after displaying "WAIT" on the remote control, the display changes to "INSPECT I/U".

Error code Remote control:INSPECT I/U	Indoor display	RUN light -	TIMER light -	Content INSPECT I/U (Connection of 3 units or more remote control)
	Outdoor control PCB	Green LED Keeps flashing	Red LED 2-time flash	

1.Applicable model
All models

2. Error detection method
Indoor unit cannot communicate for more than 30 minutes after the power on with remote control.

3. Condition of Error displayed
Same as above

4. Presumable cause
<ul style="list-style-type: none"> • Improper setting • Surrounding environment • Defective remote control communication circuit • Faulty indoor control PCB • Faulty outdoor control PCB • Faulty interface kit PCB

5. Troubleshooting	
Diagnosis	Countermeasure

Note: If any error is detected 30 minutes after displaying “WAIT” on the remote control, the display changes to “INSPECT I/U”.

Error code Remote control: WAIT	Indoor display	RUN light -	TIMER light -	Content Communication error at initial operation (1/3)
	Outdoor control PCB	Green LED Keeps flashing	Red LED 2-time flash	

1. Applicable model
All models

2. Error detection method

3. Condition of Error displayed

4. Presumable cause
<ul style="list-style-type: none"> • Faulty indoor control PCB • Defective remote control • Broken remote control wire • Faulty outdoor control PCB • Broken connection wires

5. Troubleshooting	
Diagnosis	Countermeasure
	<p>Defective indoor control PCB → Replace. Defective remote control → Replace. Broken remote control wire Y → Replace.</p> <p>Correct connection wires between indoor and outdoor units.</p> <p>Defective outdoor control PCB → Replace.</p> <p>Defective connection wire (Broken) Noise</p> <p>Defective indoor control PCB → Replace.</p>

Note:

Error code Remote control: WAIT	Indoor display	RUN light -	TIMER light -	Content Communication error at initial operation (2/3)
	Outdoor control PCB	Green LED Keeps flashing	Red LED 2-time flash	

1. Applicable model
All models

2. Error detection method

3. Condition of Error displayed

4. Presumable cause
- Faulty noise filter
 - Faulty indoor control PCB
 - Faulty outdoor control PCB
 - Faulty inverter PCB
 - Faulty fan motor

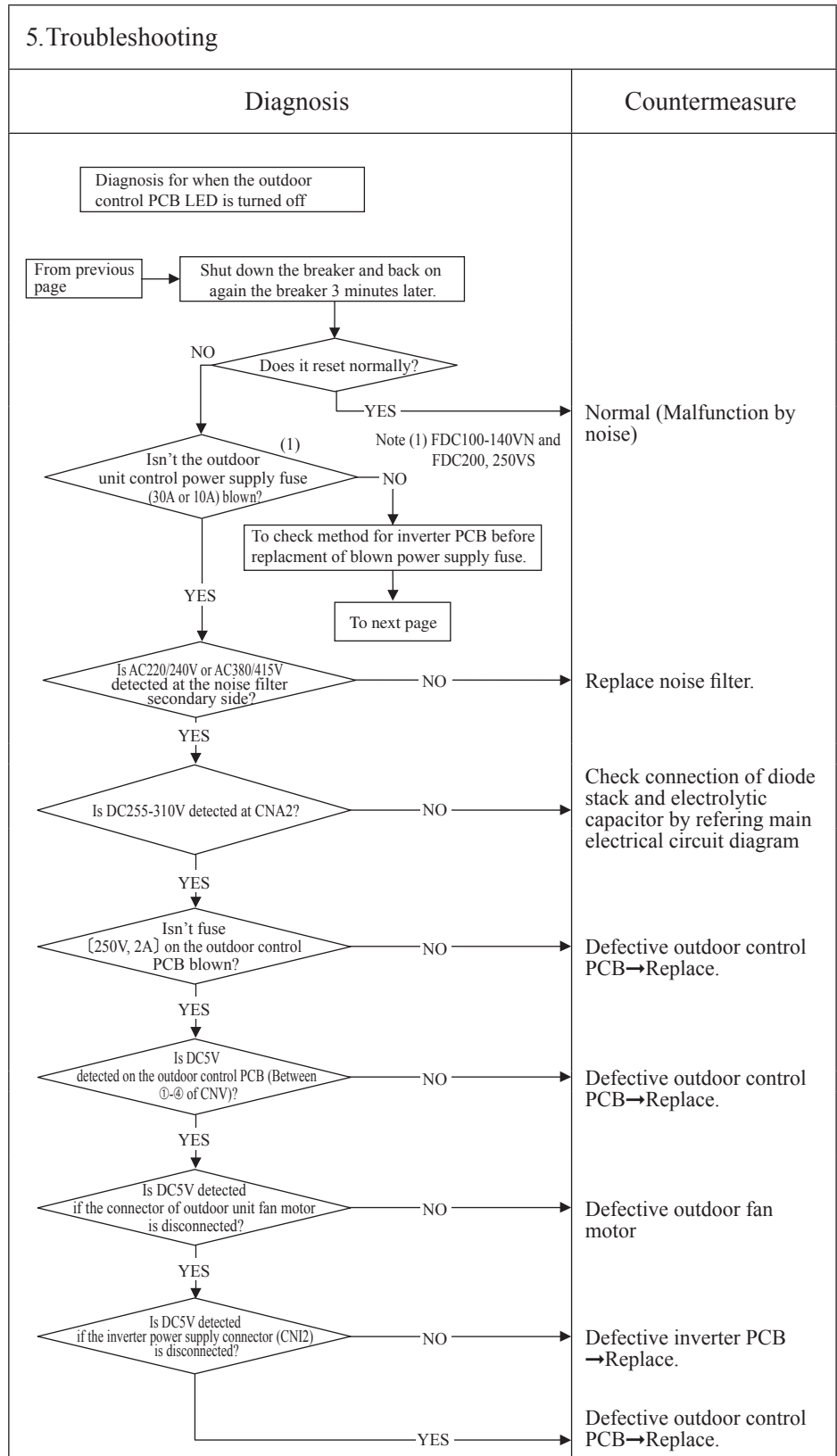

Note:

Error code Remote control: 🏠 WAIT 🏠	Indoor display	RUN light -	TIMER light -	Content Communication error at initial operation (3/3)
	Outdoor control PCB	Green LED Keeps flashing	Red LED 2-time flash	

1. Applicable model
All models

2. Error detection method

3. Condition of Error displayed

4. Presumable cause
- Blown fuse
 - Faulty noise filter
 - Faulty inverter PCB
 - Faulty reactor
 - Faulty electrolytic capacitor

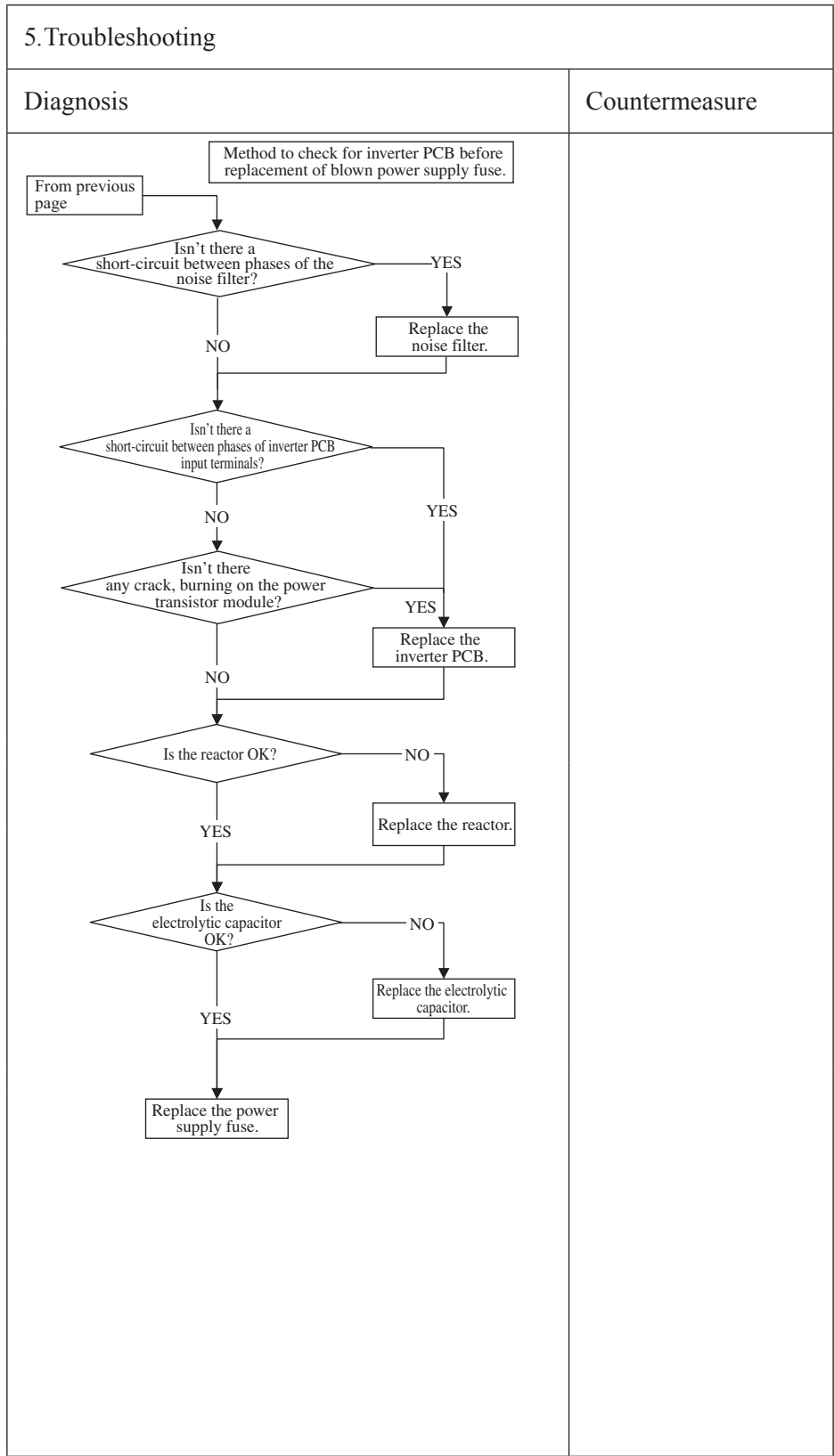

Note:

Error code Remote control:None	Indoor display	RUN light -	TIMER light -	Content No display
	Outdoor control PCB	Green LED Keeps flashing	Red LED 2-time flash	

1.Applicable model
All models

2. Error detection method

3. Condition of Error displayed

4. Presumable cause
<ul style="list-style-type: none"> • Faulty indoor control PCB • Defective remote control • Broken remote control wire • Defective interface kit

5.Troubleshooting	
Diagnosis	Countermeasure
<pre> graph TD Start[Remote control does not display anything after the power on.] --> D1{Is DC10V or higher detected at remote control connection terminals?} D1 -- YES --> C1[Defective remote control] D1 -- NO --> D2{Is DC10V or higher detected on remote control wires if the remote control is removed?} D2 -- YES --> C2[Defective remote control] D2 -- NO --> D3{Is DC10V or higher detected at interface kit connection terminals?} D3 -- YES --> C3[Defective interface kit] D3 -- NO --> D4{Is DC10V or higher detected on connecting wires if the interface kit is removed?} D4 -- YES --> C4[Defective interface kit] D4 -- NO --> D5{Are wires connected properly between the indoor/outdoor units?} D5 -- YES --> C5[Defective connecting wire. Defective remote control wire (Short-circuit, etc.)] D5 -- NO --> C6[Defective indoor control PCB -> Replace.] </pre>	

Note:

Error code Remote control:E1	Indoor display	RUN light -	TIMER light -	Content	<h2>Remote control communication circuit error</h2>
	Outdoor control PCB	Green LED Keeps flashing	Red LED Stays OFF		

1.Applicable model
All models

2. Error detection method
When normal communication between the remote control and the indoor unit is interrupted for more than 2 minutes. (Detectable only with the remote control)

3. Condition of Error displayed
Same as above

4. Presumable cause
<ul style="list-style-type: none"> • Defective communication circuit between remote controller-indoor unit • Noise • Defective remote control • Faulty indoor control PCB • Defective interface kit

5. Troubleshooting	
Diagnosis	Countermeasure
<pre> graph TD D1{Is it possible to reset normally by the power reset?} -- YES --> C1[Malfunction by noise Check peripheral environment.] D1 -- NO --> D2{Is DC10V or higher detected at remote control connection terminals?} D2 -- YES --> C2[Defective remote control] D2 -- NO --> D3{Is DC10V or higher detected on remote control wires if the remote control is removed?} D3 -- YES --> C3[Defective remote control] D3 -- NO --> D4{Is DC10V or higher detected at interface kit connection terminals?} D4 -- YES --> C4[Defective interface kit] D4 -- NO --> D5{Is DC10V or higher detected on connecting wires if the interface kit is removed?} D5 -- YES --> C5[Defective interface kit] D5 -- NO --> D6{Are wires connected properly between the indoor/outdoor units?} D6 -- YES --> C6[Defective connecting wire. Defective remote control wire (Short-circuit, etc.)] D6 -- NO --> C7[Defective indoor control PCB -> Replace.] </pre> <p>Note (2) Does the remote control still display “WAIT” even after 3 minutes?</p>	

Note: If the indoor unit cannot communicate normally with the remote control for 180 seconds, the indoor unit PCB starts to reset automatically.

Error code Remote control: E5	Indoor display	RUN light ON	TIMER light 6-time flash	Content Communication error during operation
	Outdoor control PCB	Green LED Keeps flashing	Red LED See below	

1. Applicable model
All models
2. Error detection method
When normal communication between indoor and outdoor unit is interrupted for more than 2 minutes.
3. Condition of Error displayed
Same as above is detected during operation.
4. Presumable cause
<ul style="list-style-type: none"> • Unit No. setting error • Broken remote control wire • Faulty remote control wire connection • Faulty outdoor control PCB

5. Troubleshooting	
Diagnosis	Countermeasure
<p>In case that the outdoor unit red LED flashes 2-times</p> <p>Note (1) Inspect faulty connections (disconnection, looseness) on the outdoor unit terminal block.</p> <p>Is the connection of signal wires at the outdoor unit side OK?</p> <p>NO → Repair signal wires.</p> <p>YES</p> <p>Note (2) Check for faulty connection or breakage of signal wires between indoor-outdoor units.</p> <p>Is the connection of signal wires between indoor-outdoor units OK?</p> <p>NO → Repair signal wires.</p> <p>YES</p> <p>Power reset</p> <p>Has the remote controller LCD returned to normal state?</p> <p>NO → To the diagnosis of “WAIT”</p> <p>YES → Unit is normal. (Malfunction by temporary noise, etc.)</p> <p>In case that the outdoor unit red LED stays OFF</p> <p>Power reset</p> <p>NO</p> <p>Has the remote controller LCD returned to normal state?</p> <p>NO → Defective outdoor control PCB (Defective network communication circuit) → Replace.</p> <p>YES → Unit is normal. (Malfunction by temporary noise, etc.)</p>	

Note: Pressing the pump-down switch cancels communications between indoor and outdoor unit so that “communication error-E5” is displayed on indoor unit and remote control, but it is normal.

Error code Remote control: E6	Indoor display	RUN light 1(3)-time flash ⁽¹⁾	TIMER light ON	Content Indoor heat exchanger temperature sensor anomaly
	Outdoor control PCB	Green LED Keeps flashing	Red LED Stays OFF	

Note(1) Value in () are the Th2.

1. Applicable model
All models
2. Error detection method
Anomalously low temperature or high temperature (resistance) is detected on the indoor heat exchanger sensor (Th2 ₁ , Th2 ₂).
3. Condition of Error displayed
<ul style="list-style-type: none"> When the temperature sensor detects -28°C or lower for 15 seconds continuously, the compressor stops. After 3-minutes delay, the compressor starts again automatically, but if this error occurs again within 60 minutes after the initial detection.
4. Presumable cause
<ul style="list-style-type: none"> Defective indoor heat exchanger sensor connector Indoor heat exchanger temperature sensor anomaly Faulty indoor control PCB

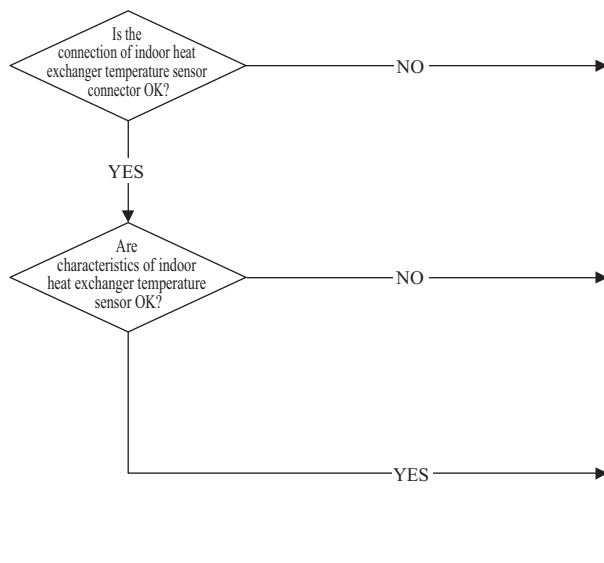
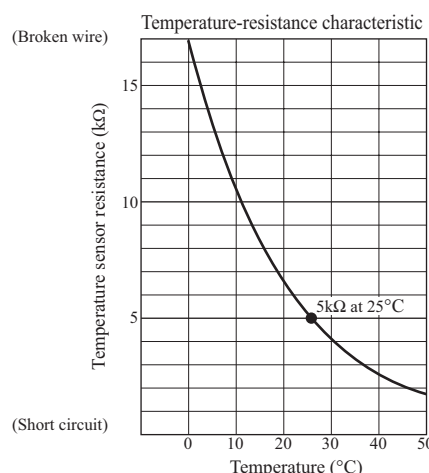
5. Troubleshooting	
Diagnosis	Countermeasure
	<p>Correct. → Insert connector securely.</p> <p>Defective indoor heat exchanger temperature sensor → Replace.</p> <p>Defective indoor control PCB → Replace. (Defective indoor unit heat exchanger temperature sensor input circuit)</p>
<p>(Broken wire)</p> <p style="text-align: center;">Temperature-resistance characteristic</p>  <p>(Short circuit)</p>	

Note:

Error code Remote control:None	Indoor display	RUN light 2-time flash	TIMER light ON	Content Room temperature sensor anomaly
	Outdoor control PCB	Green LED Keeps flashing	Red LED Stays OFF	

1. Applicable model
All models

2. Error detection method
Anomalously low temperature or high temperature (resistance) is detected by indoor return air temperature sensor (Th1)

3. Condition of Error displayed

- When the temperature thermistor detects -45°C or lower for 15 seconds continuously, the compressor stops. After 3-minute delay, the compressor starts again automatically, but if this error occurs again within 60 minutes after the initial detection.

4. Presumable cause

- Defective room temperature sensor connector
- Defective room temperature sensor
- Faulty indoor control PCB

5. Troubleshooting

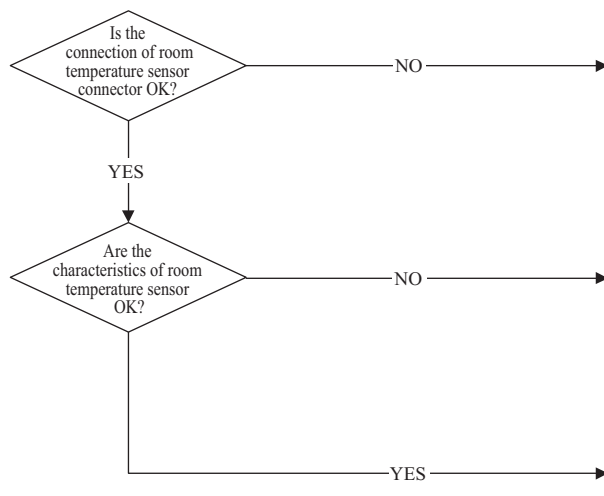
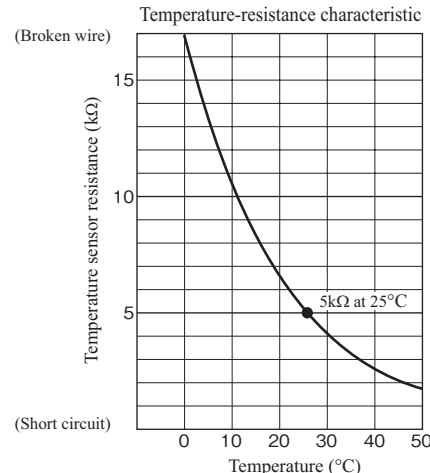
Diagnosis	Countermeasure																
 <pre> graph TD Q1{Is the connection of room temperature sensor connector OK?} Q2{Are the characteristics of room temperature sensor OK?} Q1 -- NO --> C1[Correct. -> Connect connector.] Q1 -- YES --> Q2 Q2 -- NO --> C2[Defective room temperature sensor -> Replace.] Q2 -- YES --> C3[Defective indoor control PCB -> Replace. (Defective room temperature sensor input circuit)] </pre>																	
<p>Temperature-resistance characteristic</p>  <table border="1"> <caption>Temperature-resistance characteristic data points (approximate)</caption> <thead> <tr> <th>Temperature (°C)</th> <th>Temperature sensor resistance (kΩ)</th> </tr> </thead> <tbody> <tr> <td>0</td> <td>15</td> </tr> <tr> <td>10</td> <td>10</td> </tr> <tr> <td>20</td> <td>7</td> </tr> <tr> <td>25</td> <td>5</td> </tr> <tr> <td>30</td> <td>4</td> </tr> <tr> <td>40</td> <td>3</td> </tr> <tr> <td>50</td> <td>2</td> </tr> </tbody> </table>	Temperature (°C)	Temperature sensor resistance (kΩ)	0	15	10	10	20	7	25	5	30	4	40	3	50	2	
Temperature (°C)	Temperature sensor resistance (kΩ)																
0	15																
10	10																
20	7																
25	5																
30	4																
40	3																
50	2																

Note:

Error code Remote control: E10	Indoor display	RUN light -	TIMER light -	Content Excessive number of connected indoor units (more than 17 units) by controlling with one remote control
	Outdoor control PCB	Green LED	Red LED	
		Keeps flashing	Stays OFF	

<p>1. Applicable model</p> <p>All models</p>	5. Troubleshooting	
<p>2. Error detection method</p> <p>When it detects more than 17 of indoor units connected to one remote control</p>	Diagnosis	Countermeasure
<p>3. Condition of Error displayed</p> <p>Same as above</p>	<pre> graph LR A{Aren't more than 17 indoor units connected to one remote control?} -- NO --> B[Defective remote control -> Replace.] A -- YES --> C[Reduce to 16 or less units.] </pre>	
<p>4. Presumable cause</p> <ul style="list-style-type: none"> • Excessive number of indoor units connected • Defective remote control 		

Note:

Error code Remote control:E14	Indoor display	RUN light 3-time flash	TIMER light Keeps flashing	Content Communication error between master and slave indoor units
	Outdoor control PCB	Green LED Keeps flashing	Red LED Stays OFF	

1.Applicable model
All models

2.Error detection method
When communication error between master and slave indoor units occurs

3.Condition of Error displayed
Same as above

4.Presumable cause

- Unit address setting error
- Broken remote control wire
- Defective remote control wire connection
- Broken interface kit wire
- Defective interface kit wire connection
- Defective indoor control PCB

5.Troubleshooting

Diagnosis	Countermeasure																	
<pre> graph TD D1{Is it OK the unit address setting for master and slave interface kit?} D2{Isn't the remote controller wiring between interface kit defective?} D3{Isn't the interface kit wiring between indoor units defective?} D4{Is it restored by resetting the power supply?} D1 -- NO --> C1[Correct unit address setting.] D1 -- YES --> D2 D2 -- YES --> C2[Correct wiring.] D2 -- NO --> D3 D3 -- YES --> C3[Correct wiring.] D3 -- NO --> D4 D4 -- NO --> C4[Defective indoor control PCB -> Replace.] D4 -- YES --> C5["• Malfunction by noise • Check surrounding environment."] </pre>																		
<p>Note (1) Set dip switches SW3-1 and SW3-2 as shown in the following table. (Factory default setting – “Master”)</p> <table border="1"> <thead> <tr> <th colspan="2" rowspan="2"></th> <th colspan="3">Interface kit</th> </tr> <tr> <th>Master</th> <th>Slave1</th> <th>Slave2</th> </tr> </thead> <tbody> <tr> <th rowspan="2">Dip switch</th> <th>SW3-1</th> <td>OFF</td> <td>OFF</td> <td>ON</td> </tr> <tr> <th>SW3-2</th> <td>OFF</td> <td>ON</td> <td>OFF</td> </tr> </tbody> </table>				Interface kit			Master	Slave1	Slave2	Dip switch	SW3-1	OFF	OFF	ON	SW3-2	OFF	ON	OFF
				Interface kit														
		Master	Slave1	Slave2														
Dip switch	SW3-1	OFF	OFF	ON														
	SW3-2	OFF	ON	OFF														

Note:

Error code Remote control: E16	Indoor display	RUN light 6-time flash	TIMER light ON	Content <h2 style="text-align: center;">Indoor fan motor anomaly</h2>
	Outdoor control PCB	Green LED Keeps flashing	Red LED Stays OFF	

1. Applicable model
All models

2. Error detection method
Detected by rotation speed of indoor fan motor

3. Condition of Error displayed
<ul style="list-style-type: none"> When actual rotation speed of indoor fan motor drops to lower than 300min⁻¹ for 30 seconds continuously, the compressor and the indoor fan motor stop.

4. Presumable cause
<ul style="list-style-type: none"> Defective indoor control PCB Foreign material at rotational area of fan propeller Defective fan motor Dust on indoor control PCB External noise, surge

5. Troubleshooting	
Diagnosis	Countermeasure
<pre> graph TD D1{Does any foreign material intervene in rotational area of fan propeller?} -- YES --> C1[Remove foreign material.] D1 -- NO --> D2{Does the fan rotate smoothly when turned by hand?} D2 -- YES --> D3{Is DC280V detected between ①-③ of fan motor connector CNU?} D2 -- NO --> C2[Replace the fan motor.] D3 -- YES --> C3[Replace indoor control PCB] D3 -- NO --> C2 D3 --- Note["Note (1) ③ for GND"] D3 --- P1["(1)"] D3 -- YES --> P2[Power supply reset] P2 --> D4{Is it normalized?} D4 -- YES --> C4[Malfunction by temporary noise] D4 -- NO --> C5["Replace fan motor. (If the error persists after replacing the fan motor, replace the indoor control PCB.)"] </pre>	

Note:

Error code Remote control:E28	Indoor display	RUN light -	TIMER light -	Content Remote control temperature thermistor anomaly
	Outdoor control PCB	Green LED Keeps flashing	Red LED Stays OFF	

1.Applicable model
All models

2. Error detection method
Detection of anomalously low temperature (resistance) of remote control temperature thermistor (Thc)

3. Condition of Error displayed
When the temperature thermistor detects -50°C or lower for 5 seconds continuously, the compressor stops. After 3-minutes delay, the compressor starts again automatically, but if this error occurs again within 60 minutes after the initial detection.

4. Presumable cause
<ul style="list-style-type: none"> Faulty connection of remote control temperature thermistor Defective remote control temperature thermistor Defective remote control PCB

5. Troubleshooting

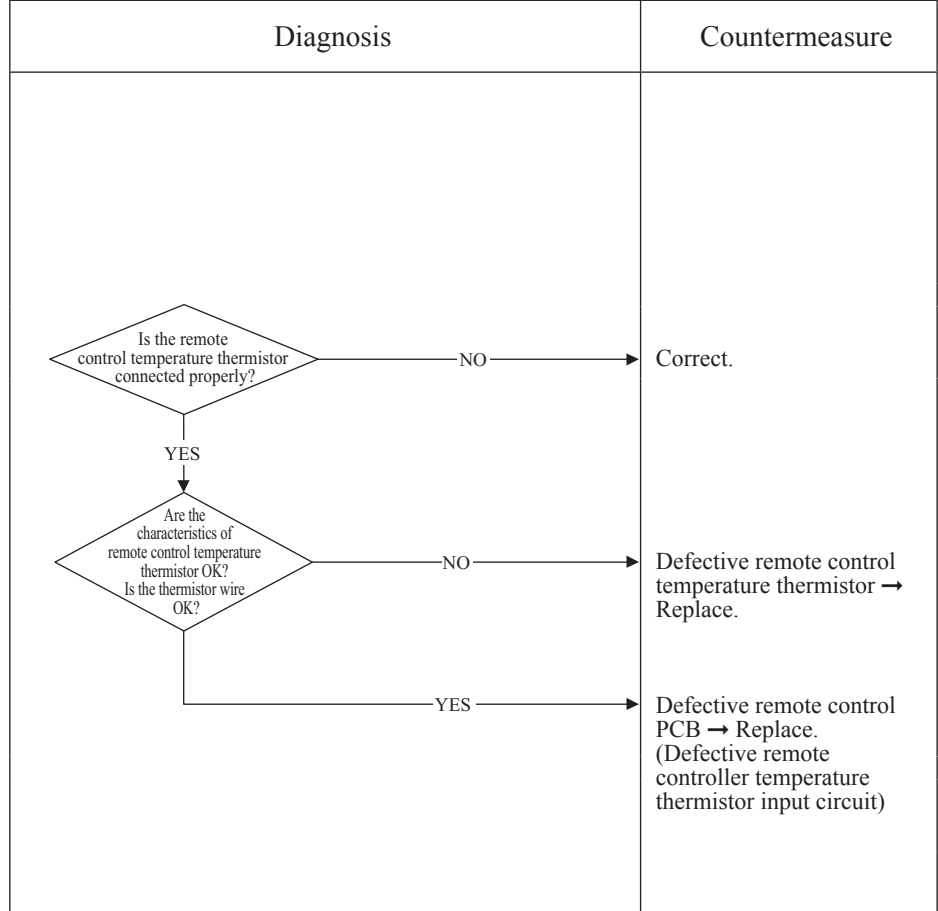

Resistance-temperature characteristics of remote control temperature thermistor (ThC)

Temperature (°C)	Resistance value (kΩ)	Temperature (°C)	Resistance value (kΩ)
0	65	30	16
1	62	32	15
2	59	34	14
4	53	36	13
6	48	38	12
8	44	40	11
10	40	42	9.9
12	36	44	9.2
14	33	46	8.5
16	30	48	7.8
18	27	50	7.3
20	25	52	6.7
22	23	54	6.3
24	21	56	5.8
26	19	58	5.4
28	18	60	5.0

Note: After 10 seconds has passed since remote control thermistor was switched from valid to invalid, E28 will not be displayed even if the thermistor harness is disconnected. At same time the thermistor, which is effective, is switched from remote control thermistor to indoor return air temperature thermistor. Even though the remote control thermistor is set to be Effective, the return air temperature displayed on remote control for checking still shows the value detected by indoor return air temperature thermistor, not by remote control temperature thermistor.

Error code Remote control:E35	Indoor display	RUN light ON	TIMER light Keeps flashing	Content Cooling overload operation
	Outdoor control PCB	Green LED Keeps flashing	Red LED 1-time flash	
		Yellow LED Keeps flashing		
	Outdoor inverter PCB			

1.Applicable model
All models

2.Error detection method
For the error detection method, refer to the protective control by controlling compressor rotation speed and cooling high pressure protective control of micro computer control function for corresponding models.

3.Condition of Error displayed
When outdoor heat exchanger temperature anomaly is detected 5 times within 60 minutes or this anomalous state is detected 60 minutes continuously including compressor stop.

4.Presumable cause
<ul style="list-style-type: none"> • Defective outdoor heat exchanger temperature thermistor • Defective outdoor control PCB • Indoor, outdoor unit installation spaces • Short-circuit of air on indoor, outdoor units • Fouling, clogging of heat exchanger • Excessive refrigerant amount

5.Troubleshooting	
Diagnosis	Countermeasure
<p style="text-align: right;">* For the characteristics of outdoor heat exchanger temperature thermistor, refer to E37.</p> <pre> graph TD Q1{Are the characteristics of outdoor heat exchanger temperature thermistor normal?} Q2{Is the unit operating in the state of cooling overload?} Q3{Is the high pressure control normal?} Q4{Is the temperature (measured actually) at detection of error correct?} Q1 -- NO --> C1[Replace outdoor heat exchanger temperature thermistor.] Q1 -- YES --> Q2 Q2 -- YES --> C2["Check unit side. • Isn't the air circulation of outdoor unit short-circuited? • Are installation spaces adequate? • Isn't there any fouling or clogging on heat exchanger?"] Q2 -- NO --> Q3 Q3 -- NO --> C3[Control operation check *] Q3 -- YES --> Q4 Q4 -- NO --> C4[Defective outdoor control PCB→Replace.] Q4 -- YES --> C5["Excessive refrigerant amount : Recharge refrigerant by weighing proper amount on a scale."] </pre>	
<p>* For the contents of control, refer to the protective control by controlling compressor rotation speed and cooling high pressure protective control of micro computer control function for corresponding models.</p>	

Note:

Error code Remote control:E36	Indoor display	RUN light ON	TIMER light 5-time flash	Content Discharge pipe temperature error
	Outdoor control PCB	Green LED Keeps flashing	Red LED 1-time flash	
		Yellow LED Keeps flashing		
	Outdoor inverter PCB			

1.Applicable model
All models

2. Error detection method
For the error detection method, refer to the protective control by controlling compressor rotation speed and cooling high pressure protective control of micro computer control function for corresponding models.

3. Condition of Error displayed
When discharge pipe temperature anomaly is detected 2 times within 60 minutes or this anomalous state is detected 60 minutes continuously including compressor stop.

4. Presumable cause
<ul style="list-style-type: none"> • Defective outdoor control PCB • Defective discharge pipe temperature thermistor • Clogged filter • Indoor, outdoor unit installation spaces • Short-circuit of air on indoor, outdoor units • Fouling, clogging of heat exchanger

5.Troubleshooting	
Diagnosis	Countermeasure
<pre> graph TD Q1{Are the characteristics of discharge pipe temperature thermistor normal?} Q2{Is the discharge pipe temperature error persisted during cooling operation?} Q3{Is the discharge pipe temperature control normal?} Q4{Is the temperature (measured actually) at detection of error correct?} Q1 -- NO --> C1[Replace discharge pipe temperature thermistor.] Q1 -- YES --> Q2 Q2 -- YES --> C2[Insufficient refrigerant amount : Recharge refrigerant by weighing proper amount on a scale.] Q2 -- NO --> Q3 Q3 -- NO --> C3[Control operation check *] Q3 -- YES --> Q4 Q4 -- NO --> C4[Defective outdoor control PCB -> Replace.] Q4 -- YES --> C5[Check unit side: • Isn't filter clogged? • Are adequate indoor, outdoor unit installation spaces? • Isn't there any short-circuit of air? • Isn't there any fouling, clogging on indoor heat exchanger?] </pre>	
<p>* For the characteristics of discharge pipe temperature, refer to E39.</p> <p>* For the contents of control, refer to the protective control by controlling compressor rotation speed and cooling high pressure protective control of micro computer control function for corresponding models.</p>	

Note:

Error code Remote control:E37	Indoor display	RUN light Keeps flashing	TIMER light 2-time flash	Content Outdoor heat exchanger temperature themistor anomaly
	Outdoor control PCB	Green LED Keeps flashing	Red LED 1-time flash	
		Yellow LED Keeps flashing		
	Outdoor inverter PCB			

1.Applicable model
All models

2. Error detection method
Detection of anomalously low temperature (resistance) on the outdoor heat exchanger temperature thermistor

3. Condition of Error displayed
<ul style="list-style-type: none"> When the temperature thermistor detects -50°C or lower for 20 seconds continuously within 2 minutes to 2 minutes 20 seconds after the compressor ON, the compressor stops. After 3-minutes delay, the compressor starts again automatically, but if this anomalous temperature is detected 3 times within 40 minutes. When -50°C or lower is detected for 5 seconds continuously within 20 second after compressor ON.

4. Presumable cause
<ul style="list-style-type: none"> Defective outdoor control PCB Broken thermistor harness or temperature sensing section Disconnected wire connection (connector)

5. Troubleshooting																	
Diagnosis	Countermeasure																
<p style="text-align: center;">Temperature-resistance characteristics</p> <table border="1"> <caption>Temperature-resistance characteristics data points (approximate)</caption> <thead> <tr> <th>Temperature (°C)</th> <th>Temperature thermistor resistance (kΩ)</th> </tr> </thead> <tbody> <tr> <td>0</td> <td>15</td> </tr> <tr> <td>10</td> <td>10</td> </tr> <tr> <td>20</td> <td>6</td> </tr> <tr> <td>25</td> <td>5</td> </tr> <tr> <td>30</td> <td>4</td> </tr> <tr> <td>40</td> <td>3</td> </tr> <tr> <td>50</td> <td>2</td> </tr> </tbody> </table>		Temperature (°C)	Temperature thermistor resistance (kΩ)	0	15	10	10	20	6	25	5	30	4	40	3	50	2
Temperature (°C)	Temperature thermistor resistance (kΩ)																
0	15																
10	10																
20	6																
25	5																
30	4																
40	3																
50	2																

Note:

Error code Remote control:E38	Indoor display	RUN light Keeps flashing	TIMER light 1-time flash	Content Outdoor air temperature thermistor anomaly
	Outdoor control PCB	Green LED Keeps flashing	Red LED 1-time flash	
		Yellow LED Keeps flashing		
	Outdoor inverter PCB			

1.Applicable model
All models

2. Error detection method
Detection of anomalously low temperature (resistance) on outdoor air temperature thermistor

3. Condition of Error displayed
<ul style="list-style-type: none"> When the temperature thermistor detects -45°C or lower for 5 seconds continuously within 2 minutes to 2 minutes 20 seconds after the compressor ON, the compressor stops. After 3-minutes delay, the compressor starts again automatically, but if this anomalous temperature is detected 3 times within 40 minutes. When -45°C or lower is detected for 5 seconds continuously within 20 second after compressor ON.

4. Presumable cause
<ul style="list-style-type: none"> Defective outdoor control PCB Broken thermistor harness or temperature sensing section (Check molding.) Disconnected wire connection (connector)

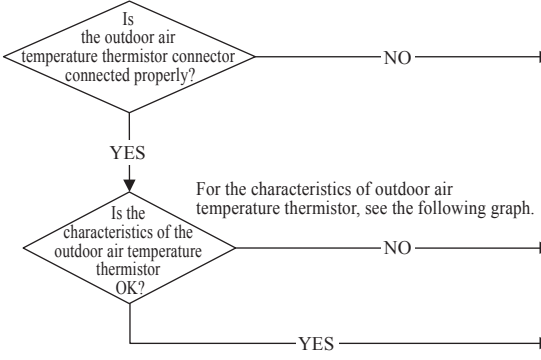
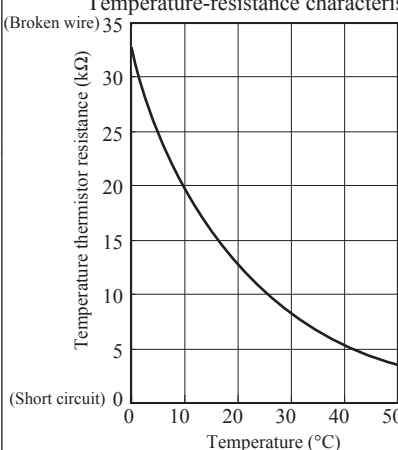
5. Troubleshooting	
Diagnosis	Countermeasure
	
<p style="text-align: center;">Temperature-resistance characteristics</p> 	

Note:

Error code Remote control:E39	Indoor display	RUN light Keeps flashing	TIMER light 4-time flash	Content Discharge pipe temperature thermistor anomaly
	Outdoor control PCB	Green LED Keeps flashing	Red LED 1-time flash	
		Yellow LED Keeps flashing		
	Outdoor inverter PCB			

1.Applicable model
All models

2.Error detection method
Detection of anomalously low temperature (resistance) on the discharge pipe temperature thermistor

3.Condition of Error displayed
When the temperature thermistor detects -10°C or lower for 5 seconds continuously within 10 minutes to 10 minutes 20 seconds after the compressor ON, the compressor stops. After 3-minutes delay, the compressor starts again automatically, but if this anomalous temperature is detected 3 times within 40 minutes.

4.Presumable cause
<ul style="list-style-type: none"> • Defective outdoor control PCB • Broken thermistor harness or temperature sensing section (Check molding.) • Disconnected wire connection (connector)

5.Troubleshooting	
Diagnosis	Countermeasure
<p>(Broken wire) Temperature-resistance characteristics</p> <p>(Short circuit)</p>	

Note:

Error code Remote control:E40	Indoor display	RUN light	TIMER light	Content High pressure error (63H1 activated)
	Outdoor control PCB	Green LED	Red LED	
		Keeps flashing	1-time flash	
	Outdoor inverter PCB	Yellow LED		
Keeps flashing				

1.Applicable model
All models

2. Error detection method
When the high pressure switch 63H1 is activated.
<p>Compressor ON</p> <p>Compressor OFF</p> <p>3.15 4.15 High pressure (MPa)</p>

3. Condition of Error displayed
If 63H1 turns OFF (opened), the compressor stops. After 3-minutes delay, the compressor restarts. If this anomaly occurs 5 times within 60 minutes or continues for 60 minutes continuously.

4. Presumable cause
<ul style="list-style-type: none"> • Short circuit of air flow, disturbance of air flow and clogging filter at outdoor heat exchanger/Breakdown of fan motor • Defective outdoor control PCB • Defective 63H1 connector • Defective electronic expansion valve connector • Closed service valve • Mixing of non-condensing gas (nitrogen, etc.)

5.Troubleshooting	
Diagnosis	Countermeasure
<p>If the power supply breaker is turned OFF and ON too quickly, E40 may be displayed. (This is normal.)</p>	
<p>Is the service valve fully opened?</p> <p>NO → Open service valve.</p> <p>YES</p> <p>Has 63H1 activated?</p> <p>NO → Is 63H1 connector connected properly?</p> <p>NO → Correct 63H1 connector.</p> <p>YES</p> <p>Is the electronic expansion valve connector connection OK?</p> <p>NO → Correct electronic expansion valve connector.</p> <p>YES</p> <p>If any anomaly exists on the electronic expansion valve connector connection, the power supply must be reset.</p> <p>YES → Defective outdoor control PCB → Replace. (Defective 63H1 input circuit)</p>	
<p>On operation of 63H1</p> <p>1. During cooling</p> <ul style="list-style-type: none"> • Is the outdoor fan motor running? • Isn't any short-circuit of air on the outdoor unit? • Are sufficient return air/supply air space secured? <p>2. During heating</p> <ul style="list-style-type: none"> • Isn't the indoor heat exchanger temperature thermistor disconnected from the thermistor casing? • Isn't the filter clogged? <p>* Under the condition of overcharging refrigerant, 63H1 may activate due to delay of starting the preventive control by compressor speed control, because detected heat exchanger temperature, which conducts compressor speed control, becomes lower than normal condition due to excess sub-cooling degree.</p>	

Note: In the protective control range for compressor startup (initial startup after power ON), even if 63H1 is activated only once (63H1 turns OFF), immediately the error is displayed.

Error code Remote control:E41	Indoor display	RUN light	TIMER light	Content Power transistor overheat
	Outdoor control PCB	Green LED	Red LED	
		Keeps flashing	1-time flash	
	Outdoor inverter PCB	Yellow LED		
		6-time flash		

1.Applicable model
All models

2.Error detection method
When less than DC14V of the output voltage is detected between ② and ③ on CNI3, E41 is displayed. (See "Note" mentioned below)

3.Condition of Error displayed
Same as above.

4.Presumable cause
<ul style="list-style-type: none"> • Defective inverter PCB • Defective outdoor fan motor • Defective outdoor control PCB • Delective noise filter PCB

5.Troubleshooting	
Diagnosis	Countermeasure
<p>• Single phase models</p> <pre> graph TD Q1{Is DC15V detected between ② and ③ on CNI3? (1) (2)} Q1 -- YES --> C1[Replace inverter PCB] Q1 -- NO --> N1[Note(1) Under anomalous conditions, the voltage becomes less than DC14V.] N1 --> Q2{Is DC15V detected after disconnecting outdoor fan motor? (1)} Q2 -- YES --> C2[Replace outdoor fan motor] Q2 -- NO --> C3[Replace outdoor control PCB If not solved, replace inverter PCB as well] </pre> <p>Note(2) How to check the voltage between ② and ③ of CNI3? ⇒See E51</p> <p>• 3-phase models E41⇒Replace inverter PCB</p>	

Note: The "Single phase models" of inverter PAC have no function to output the signal for the power transistor overheat. However since the power source for the power transistor and the outdoor fan motor is in the same line, when the anomaly of the outdoor fan motor occurs, E41 is displayed.

Error code Remote control:E42	Indoor display	RUN light ON	TIMER light 1-time flash	Content Current cut (1/2)
	Outdoor control PCB	Green LED Keeps flashing	Red LED 1-time flash	
		Yellow LED 1-time flash		
	Outdoor inverter PCB			

1.Applicable model
All models

2. Error detection method
In order to prevent from overcurrent of inverter, if the current exceeds the specifications, it makes the compressor stopping.

3. Condition of Error displayed
<ul style="list-style-type: none"> • If the output current of inveter exceeds the specifications, it makes the compressor stopping. • After 3-minute delay, the compressor restarts, but if this amonaly occurs 4 times within 30 minute after the intial detection.

4. Presumable cause
<ul style="list-style-type: none"> • The valves closed • Faulty power supply • Insufficient refrigerant amount • Faulty compressor • Faulty power transistor module

5.Troubleshooting	
Diagnosis	Countermeasure
<pre> graph TD D1{Is the Power supply voltage OK?} -- NO --> C1[Check power supply.] D1 -- YES --> D2{Are the service valves opened?} D2 -- NO --> C2[Open the valves.] D2 -- YES --> D3{Is the high pressure during operation OK?} D3 -- NO --> C3[Check refrigerant amount and refregerant circuit *In case of transitional increase of high pressure and/or test run, several times restarting may recover it, because liquid refrigerant (migrated) in the compressor is discharged from the compressor.] D3 -- YES --> D4{Is the checked result of insulation resistance and coil resistance (1) of compressor motor OK?} D4 -- NO --> C4[Replace compressor.] D4 -- YES --> E1[To next page.] </pre>	

Note:

Error code Remote control:E42	Indoor display	RUN light ON	TIMER light 1-time flash	Content Current cut (2/2)
	Outdoor control PCB	Green LED Keeps flashing	Red LED 1-time flash	
		Yellow LED 1-time flash		
	Outdoor inverter PCB			

1. Applicable model
All models

2. Error detection method
In order to prevent from overcurrent of inverter, if the current exceeds the specifications, it makes the compressor stopping.

3. Condition of Error displayed

- If the output current of inverter exceeds the specifications, it makes the compressor stopping.
- After 3-minute delay, the compressor restarts, but if this anomaly occurs 4 times within 30 minute after the initial detection.

4. Presumable cause

- Defective inverter PCB
- Faulty power supply
- Insufficient refrigerant amount
- Faulty compressor
- Faulty power transistor module

5. Troubleshooting

Diagnosis	Countermeasure
<p>From previous page</p> <p>Is the checked result of power transistor module OK?</p> <p>NO → Defective inverter PCB → Replace.</p> <p>YES</p> <div style="border: 1px dashed black; padding: 5px;"> <ul style="list-style-type: none"> • Is the space for installation of indoor and/or outdoor unit enough? • Is there any short circuit of air on indoor and/or outdoor unit? • At cooling, does the outdoor fan motor run? Are the service valves fully opened? Is the filter clogged? • At heating, does the indoor fan motor run? Are the service valves fully opened? Is the filter clogged? • Is there any liquid flooding? Is the superheat within normal range? Is the low pressure sensor and suction pipe temperature thermistor normal? • Is there any anomalous sound on the compressor? </div> <p>YES</p> <p>After resetting power for several times does it become normal?</p> <p>NO → Defective inverter PCB → Replace.</p> <p>YES</p> <p>Temporary noise may cause of anomaly. If noise source can be found, take countermeasure.</p>	

Note:

Error code Remote control:E45	Indoor display	RUN light	TIMER light	Content Communication error between inverter PCB and outdoor control PCB
	Outdoor control PCB	Green LED	Red LED	
		Keeps flashing	1-time flash	
	Outdoor inverter PCB	Yellow LED		
Keeps flashing				

1.Applicable model
All models

2. Error detection method
When the communication between inverter PCB and outdoor control PCB is not established.

3. Condition of Error displayed
Same as above.

4. Presumable cause
<ul style="list-style-type: none"> • Defective inverter PCB • Defective connector between the outdoor control PCB and inverter PCB • Defective outdoor control PCB • Defective outdoor fan motor

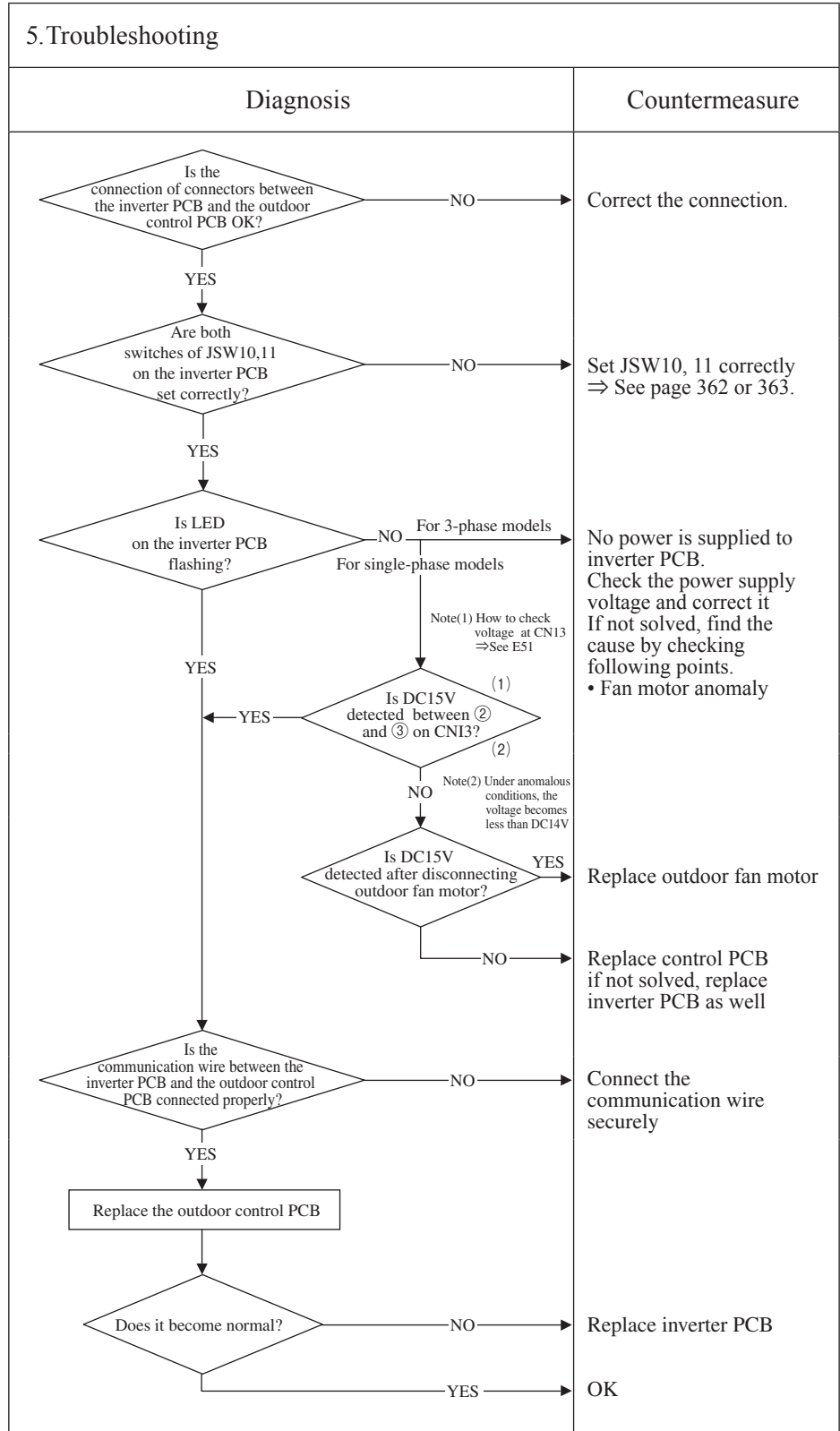

Note:

Error code Remote control:E48	Indoor display	RUN light ON	TIMER light 7-time flash	Content Outdoor fan motor anomaly
	Outdoor control PCB	Green LED Keeps flashing	Red LED 1-time flash	
		Yellow LED Keeps flashing		
	Outdoor inverter PCB			

1.Applicable model
All models

2. Error detection method
Detected by rotation speed of outdoor fan motor

3. Condition of Error displayed
When actual rotation speed of outdoor fan motor (FMo1) drops to 100min ⁻¹ or lower for 30 minutes continuously, the compressor and the outdoor fan motor stop. After 3-minutes delay, it starts again automatically, but if this anomaly occurs 5 times within 60 minutes after the initial detection.

4.Presumable cause
<ul style="list-style-type: none"> • Defective outdoor control PCB • Foreign material at rotational area of fan propeller • Defective fan motor • Dust on outdoor control PCB • Blow fuse • External noise, surge

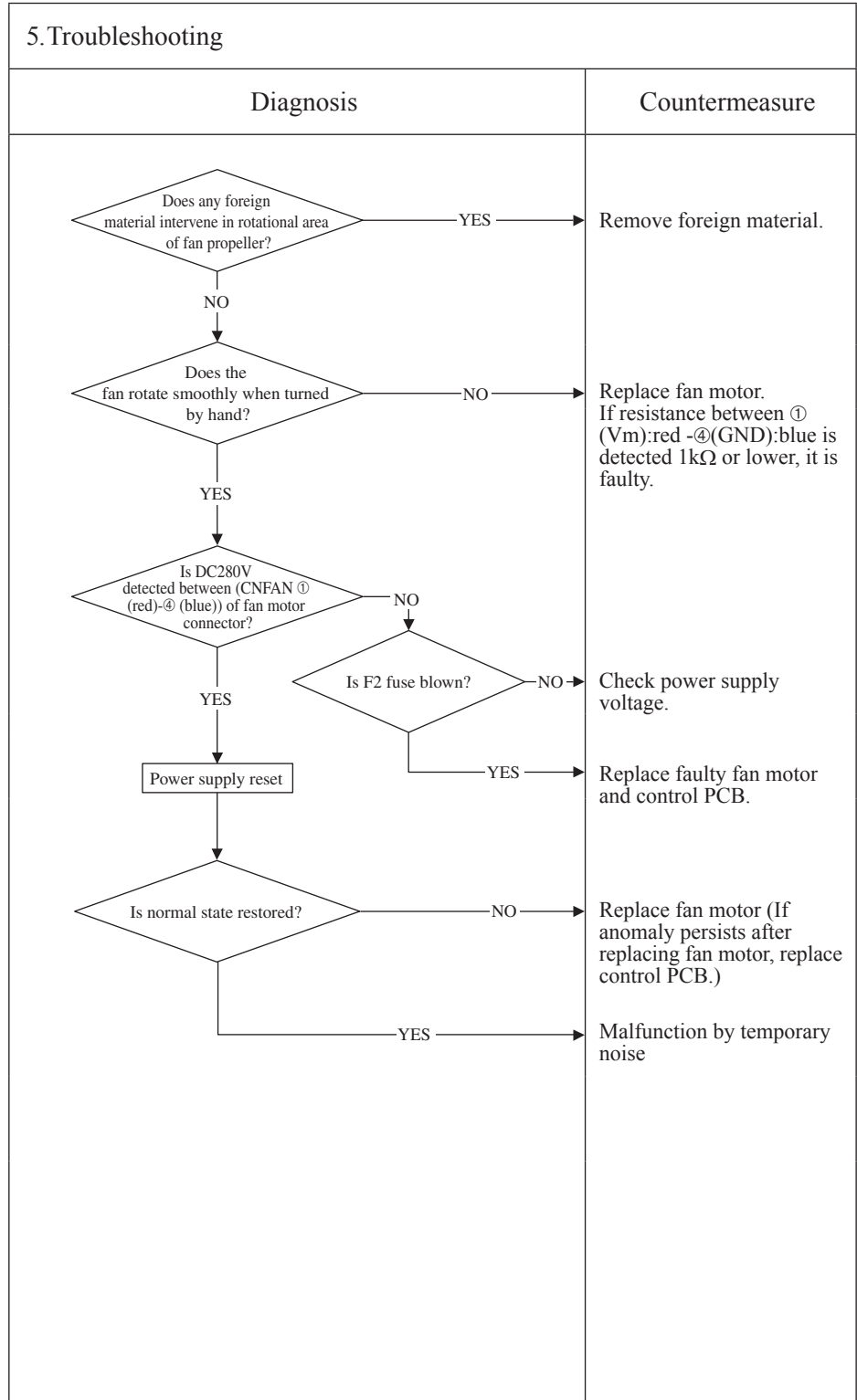

Note: When E48 error occurs, in almost cases F2 fuse (4A) on the outdoor control PCB is blown. There are a lot of cases that fuse is blown and E48 occurs due to defective fan motor. And even though only the outdoor control PCB (or fuse) is replaced, another trouble (*1) could occur. Therefore when fuse is blown, check whether the fan motor is OK or not. After confirming the fan motor normal, check by power ON. (Don't power ON without confirming the fan motor normal.) *1 The error which does not seem to relate E48 may occur like as "WAIT", Stay OFF of LED on outdoor control PCB, inverter communication error (E45) and etc.

Error code Remote control:E49	Indoor display	RUN light	TIMER light	Content Low pressure error or low pressure sensor anomaly (1/2)
	Outdoor control PCB	Green LED	Red LED	
		Keeps flashing	1-time flash	
	Outdoor inverter PCB	Yellow LED		
Keeps flashing				

1.Applicable model
All models

2.Error detection method
Detected by low pressure drop and suction superheat

3. Condition of Error displayed
<p>① When the low pressure sensor detects 0.079MPa or lower for 15 seconds continuously, compressor stops and it restarts automatically after 3-minutes delay. And if this anomaly occurs 3 times within 60 minutes,</p> <p>② 10 minutes after the compressor starts, if the low pressure sensor detects 0.15MPa or lower for 60 minutes continuously and compressor suction superheat is detected 30degC or higher for 60 minutes continuously. And if this anomaly occurs 3 times within 60 minutes,</p> <p>③ If low pressure sensor detects 0.079MPa or lower for 5 minutes continuously (including the compressor stop status),</p>

4.Presumable cause
<ul style="list-style-type: none"> • Defective outdoor control PCB • Defective low pressure sensor connector • Defective low pressure sensor • Defective suction pipe temperature thermistor connector • Defective suction pipe temperature thermistor

5.Troubleshooting	
Diagnosis	Countermeasure
<pre> graph TD Q1{Is the low pressure sensor connection OK (at PCB side)?} Q1 -- NO --> C1[Correct.] Q1 -- YES --> B1[Check the low pressure value during following state from the remote control ① Compressor is stopping ② Compressor is operating] B1 --> Q2{During both ① and ② state low pressure detected at around 0MPa without any fluctuation.} Q2 -- NO --> C1 Q2 -- YES --> B2[Check the insulation resistance of pressure sensor.] B2 --> Q3{Is the insulation resistance more than 100Ω? at DC500V?} Q3 -- NO --> C2[Replace low pressure sensor.] Q3 -- YES --> B3[After connecting the gauge manifold on the low pressure line, measure at the state ① above. Compare the result with the value indicated on the remote control.] B3 --> Q4{Is the pressure difference less than 0.2MPa?} Q4 -- NO --> B4[Connect the pressure sensor of spare part to outdoor control PCB in the condition open to atmosphere.] Q4 -- YES --> B5[To checking of refrigerant amount, refrigerant circuit, etc.] B4 --> Q5{Is the pressure 0MPa displayed on the remote control?} B5 --> Q5 Q5 -- NO --> C3[Defective outdoor control PCB → Replace.] Q5 -- YES --> C4[Replace low pressure sensor.] </pre>	

Note: * Connect the gauge manifold to the service valve check joint during cooling, or connect it to the check joint at internal piping of outdoor unit during heating.

Error code Remote control:E49	Indoor display	RUN light	TIMER light	Content Low pressure error or low pressure sensor anomaly (2/2)
	Outdoor control PCB	Green LED	Red LED	
		Keeps flashing	1-time flash	
	Outdoor inverter PCB	Yellow LED		
		Keeps flashing		

1.Applicable model
All models

2.Error detection method

3.Condition of Error displayed

4.Presumable cause

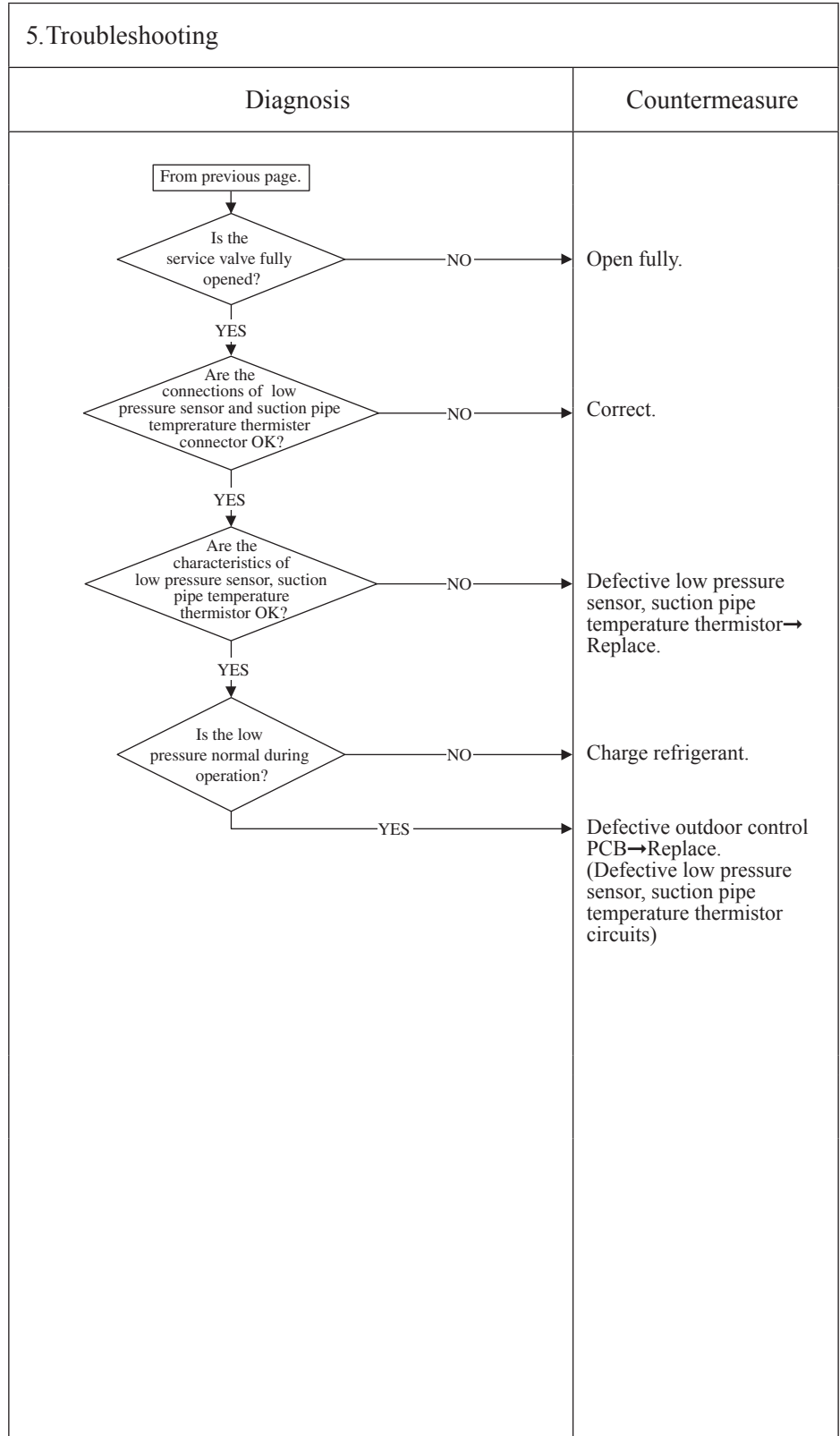

Note:

Error code Remote control:E51	Indoor display	RUN light ON	TIMER light 4-time flash	Content Inverter and fan motor anomaly
	Outdoor control PCB	Green LED Keeps flashing	Red LED 1-time flash	
		Yellow LED 6-time flash		
	Outdoor inverter PCB			

1. Applicable model
All models

2. Error detection method
When power transistor anomaly is detected for 15 minutes continuously

3. Condition of Error displayed
Same as above

4. Presumable cause
<ul style="list-style-type: none"> Defective outdoor fan motor Defective inverter PCB Defective outdoor control PCB

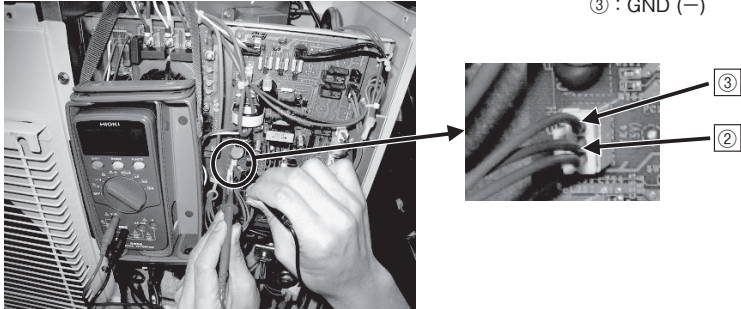
5. Troubleshooting	
Diagnosis	Countermeasure
<p>• Model FDC100-140VN</p> <pre> graph TD Q1{Is DC15V detected between ② and ③ on CNI3? (1) (2)} Q2{Is DC15V detected after disconnecting outdoor fan motor? (1)} Q1 -- YES --> C1[Replace inverter PCB If not solved, replace Noise filter PCB as well.] Q1 -- NO --> Q2 Q2 -- YES --> C2[Replace outdoor fan motor.] Q2 -- NO --> C3[Replace outdoor control PCB If not solved, replace inverter PCB as well.] </pre> <p>Note(1) Under anomalous conditions, the voltage becomes less than DC14V.</p> <p>Note(2) How to check the voltage between ② and ③ of CNI3?</p>	
<p>• Model FDC100-140VS Replace immediately the inverter PCB and the power transistor.</p>	
<p>② : 15V (+) ③ : GND (-)</p>	
	

Note:

Error code Remote control:E53	Indoor display	RUN light	TIMER light	Content Suction pipe temperature thermistor anomaly
		Keeps flashing	5-time flash	
	Outdoor control PCB	Green LED	Red LED	
		Keeps flashing	1-time flash	
Outdoor inverter PCB	Yellow LED			
	Keeps flashing			

1.Applicable model
All models

2. Error detection method
When the suction pipe temperature thermistor detects anomalously low temperature

3. Condition of Error displayed
If the temperature thermistor detects -50°C or lower for 5 seconds continuously within 10 minutes to 10 minutes 20 seconds after compressor ON, the compressor stops. When the compressor is restarted automatically after 3-minutes delay, if this anomaly occurs 3 times within 40 minute.

- 4. Presumable cause**
- Defective suction pipe temperature thermistor connection
 - Defective suction pipe temperature thermistor
 - Defective outdoor control PCB

5.Troubleshooting

Diagnosis	Countermeasure																
<pre> graph TD A{Is the connection of suction pipe temperature thermistor connector OK?} -- NO --> B[Correct connection of suction pipe temperature thermistor connector.] A -- YES --> C{Are the characteristics of suction pipe temperature thermistor OK?} C -- NO --> D[Defective suction pipe temperature thermistor -> Replace.] C -- YES --> E[Defective outdoor control PCB -> Replace. (Defective suction pipe temperature thermistor input circuit)] </pre>																	
<p>Temperature-resistance characteristics</p> <table border="1"> <caption>Temperature-resistance characteristics</caption> <thead> <tr> <th>Temperature (°C)</th> <th>Temperature thermistor resistance (kΩ)</th> </tr> </thead> <tbody> <tr> <td>0</td> <td>15</td> </tr> <tr> <td>10</td> <td>10</td> </tr> <tr> <td>20</td> <td>6</td> </tr> <tr> <td>25</td> <td>5</td> </tr> <tr> <td>30</td> <td>4</td> </tr> <tr> <td>40</td> <td>3</td> </tr> <tr> <td>50</td> <td>2</td> </tr> </tbody> </table>	Temperature (°C)	Temperature thermistor resistance (kΩ)	0	15	10	10	20	6	25	5	30	4	40	3	50	2	
Temperature (°C)	Temperature thermistor resistance (kΩ)																
0	15																
10	10																
20	6																
25	5																
30	4																
40	3																
50	2																

Note:

Error code Remote control:E54	Indoor display	RUN light	TIMER light	Content Low pressure sensor anomaly
	Outdoor control PCB	Green LED	Red LED	
		Keeps flashing	1-time flash	
	Outdoor inverter PCB	Yellow LED		
Keeps flashing				

1.Applicable model
All models

2.Error detection method
When anomalous voltage (pressure) is detected

3.Condition of Error displayed
If the pressure sensor detects 0V or lower and 4.0V or higher for 5 seconds continuously within 2 minutes to 2 minutes 20 seconds after compressor ON, the compressor stops. When the compressor is restarted automatically after 3-minuts delay, if this anomaly occurs 3 times within 40 minutes

4.Presumable cause
<ul style="list-style-type: none"> • Defective low pressure sensor connection • Defective low pressure sensor • Defective outdoor control PCB • Improper amount of refrigerant • Anomalous refrigeration circuit

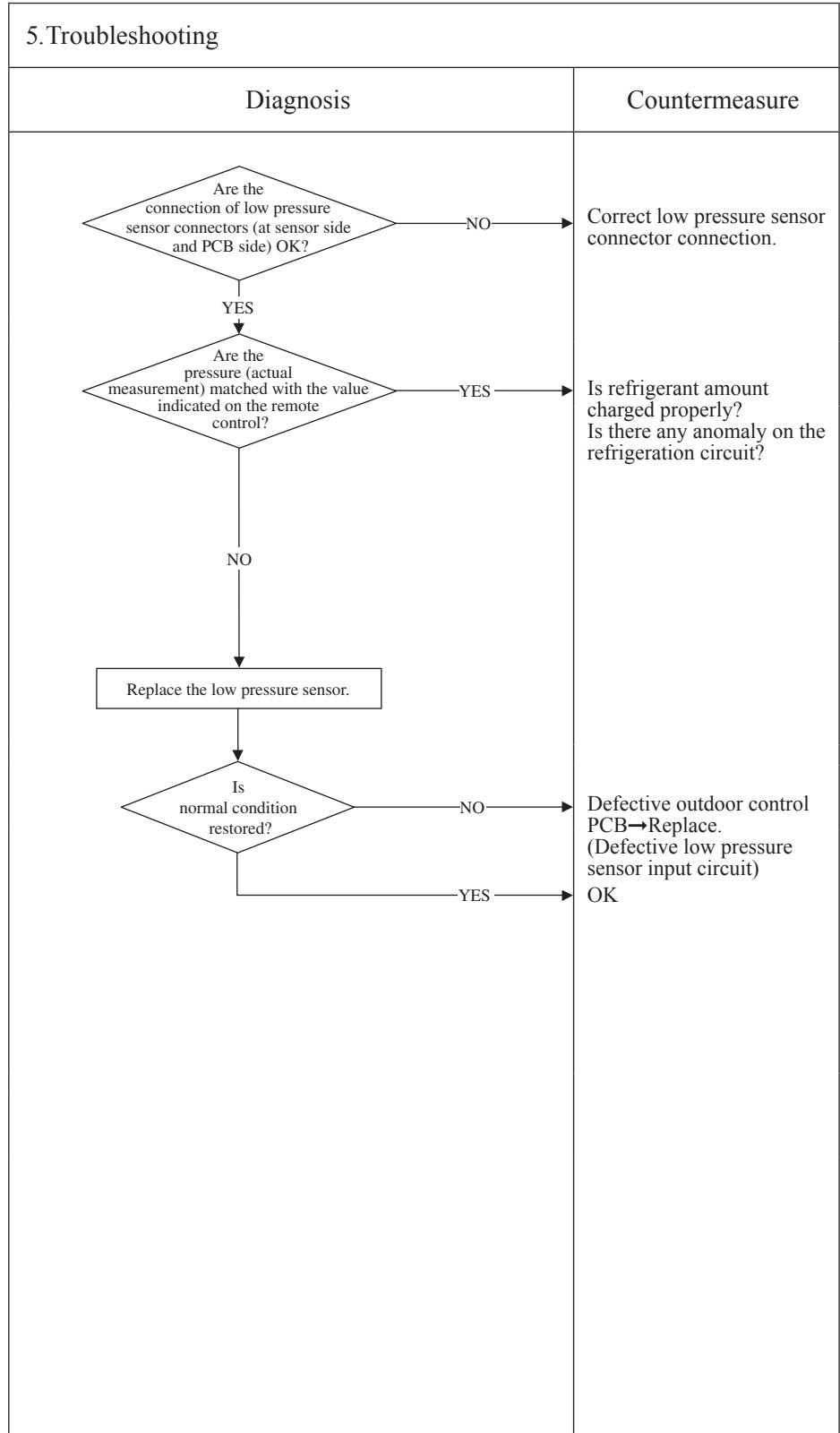

Note:

Error code Remote control:E57	Indoor display	RUN light 7-time flash	TIMER light ON	Content Insufficient refrigerant amount or detection of service valve closure
	Outdoor control PCB	Green LED Keeps flashing	Red LED 1-time flash	
		Yellow LED Keeps flashing		
	Outdoor inverter PCB			

1.Applicable model
All models

2. Error detection method
<ul style="list-style-type: none"> • Judge insufficient refrigerant amount by detecting the temperature difference between indoor heat exchanger (ThI-R) and indoor return air (ThI-A). • It detects at initial startup in cooling or dehumidifying mode after power ON.

3. Condition of Error displayed
Anomalous stop at initial detection

4. Presumable cause
<ul style="list-style-type: none"> • Defective indoor heat exchanger temperature thermistor • Defective indoor return air temperature thermistor • Defective indoor control PCB • Insufficient refrigerant amount

5. Troubleshooting

Diagnosis	Countermeasure
<p>Is the service valve fully opened?</p> <p>NO →</p> <p>YES ↓</p> <p>Are the connections of indoor heat exchanger and/or return air temperature thermistor connectors OK?</p> <p>NO →</p> <p>YES ↓</p> <p>Are the characteristics of indoor heat exchanger and/or return air temperature thermistor OK?</p> <p>NO →</p> <p>YES ↓</p> <p>Is the low pressure during operation normal?</p> <p>NO →</p> <p>YES →</p>	<p>Open fully.</p> <p>Correct indoor heat exchanger, return air temperature thermistor connector connections.</p> <p>Defective indoor heat exchanger, return air temperature thermistor → Replace.</p> <p>Charge refrigerant.</p> <p>Defective indoor control PCB → Replace. (Defective indoor heat exchanger, return air temperature thermistor input circuits)</p>

Indoor heat exchanger, return air temperature thermistor
Temperature-resistance characteristics

(Broken wire)

(Short circuit)

Note: Insufficient refrigerant amount preventive control makes compressor stopped, if it judges insufficient refrigerant amount by detecting the temperature difference between indoor heat exchanger (ThI-R) and return air temperature (ThI-A) for 1 minute after compressor ON in cooling or dehumidifying mode and for 9 minutes after compressor ON in heating mode. [in cooling mode: (ThI-A)-(ThI-R)>4degC, in heating mode: (ThI-R)-(ThI-A)<4degC]

Error code Remote control: E59	Indoor display	RUN light	TIMER light	Content Compressor startup failure (1/2)
	Outdoor control PCB	Green LED	Red LED	
		Keeps flashing	5-time flash	
	Outdoor inverter PCB	Yellow LED		
Stays OFF				

1. Applicable model
All models

2. Error detection method
When it fails to change over to the operation for rotor position detection of compressor motor (If the compressor speed cannot increase 11Hz or higher)

3. Condition of Error displayed
If the compressor fails to startup for 20 times (10 patterns x2 times) continuously.

4. Presumable cause
<ul style="list-style-type: none"> Faulty outdoor fan motor Faulty outdoor control PCB Faulty inverter PCB Anomalous power supply voltage Insufficient or Excessive refrigerant amount Faulty component for refrigerant circuit Compressor anomaly (Motor or bearing)

5. Troubleshooting	
Diagnosis	Countermeasure
<p>In case that the compressor does not start at all and no sound or vibration exists</p> <pre> graph TD Start([In case that the compressor does not start at all and no sound or vibration exists]) --> Q1{Is power supply voltage OK?} Q1 -- NO --> C1[Check the power supply voltage and correct it] Q1 -- YES --> Q2{Is DC15V detected between ② and ③ on CN13?} Q2 -- YES --> C2[Replace inverter PCB If not solved yet, replace Noise filter PCB] Q2 -- NO --> Q3{Is DC15V detected after disconnecting outdoor fan motor?} Q3 -- YES --> C3[Replace outdoor fan motor.] Q3 -- NO --> R1[Replace outdoor control PCB] R1 --> Q4{Can compressor startup?} Q4 -- YES --> C4[OK] Q4 -- NO --> Q5{Is the pressure equalized at starting OK?} Q5 -- NO --> C5[Check refrigerant amount and refrigerant circuit.] Q5 -- YES --> Q6{Is the insulation resistance and coil resistance of compressor OK?} Q6 -- NO --> C6[Replace compressor] Q6 -- YES --> End([To next page]) </pre> <p>Note(1) How to check voltage at CN13 ⇒ See E51</p> <p>Note(2) Under anomalous conditions, the voltage becomes less than DC14V</p>	

Note: Insulation resistance

- The unit is left for long period without power supply or soon after installation, insulation resistance may decrease to several MΩ or lower due to the liquid refrigerant migrated in the refrigerant oil in compressor. If the electric leakage breaker is activated due to low insulation resistance, check followings.
 - ① Check whether the insulation resistance can recover or not, after 6 hours has passed since power ON.
(By energize the crankcase heater, liquid refrigerant migrated in the refrigerant oil in compressor can be evaporated)
 - ② Check whether the electric leakage breaker conforms to high-harmonic specifications
(As INV PAC units has inverter, in order to prevent from improper operation, be sure to use the breaker of high-harmonic type)

Error code Remote control:E59	Indoor display	RUN light	TIMER light	Content Compressor startup failure (2/2)
	Outdoor control PCB	Green LED	Red LED	
		Keeps flashing	5-time flash	
	Outdoor inverter PCB	Yellow LED		
Stays OFF				

1.Applicable model
All models

2.Error detection method

3.Condition of Error displayed

4.Presumable cause

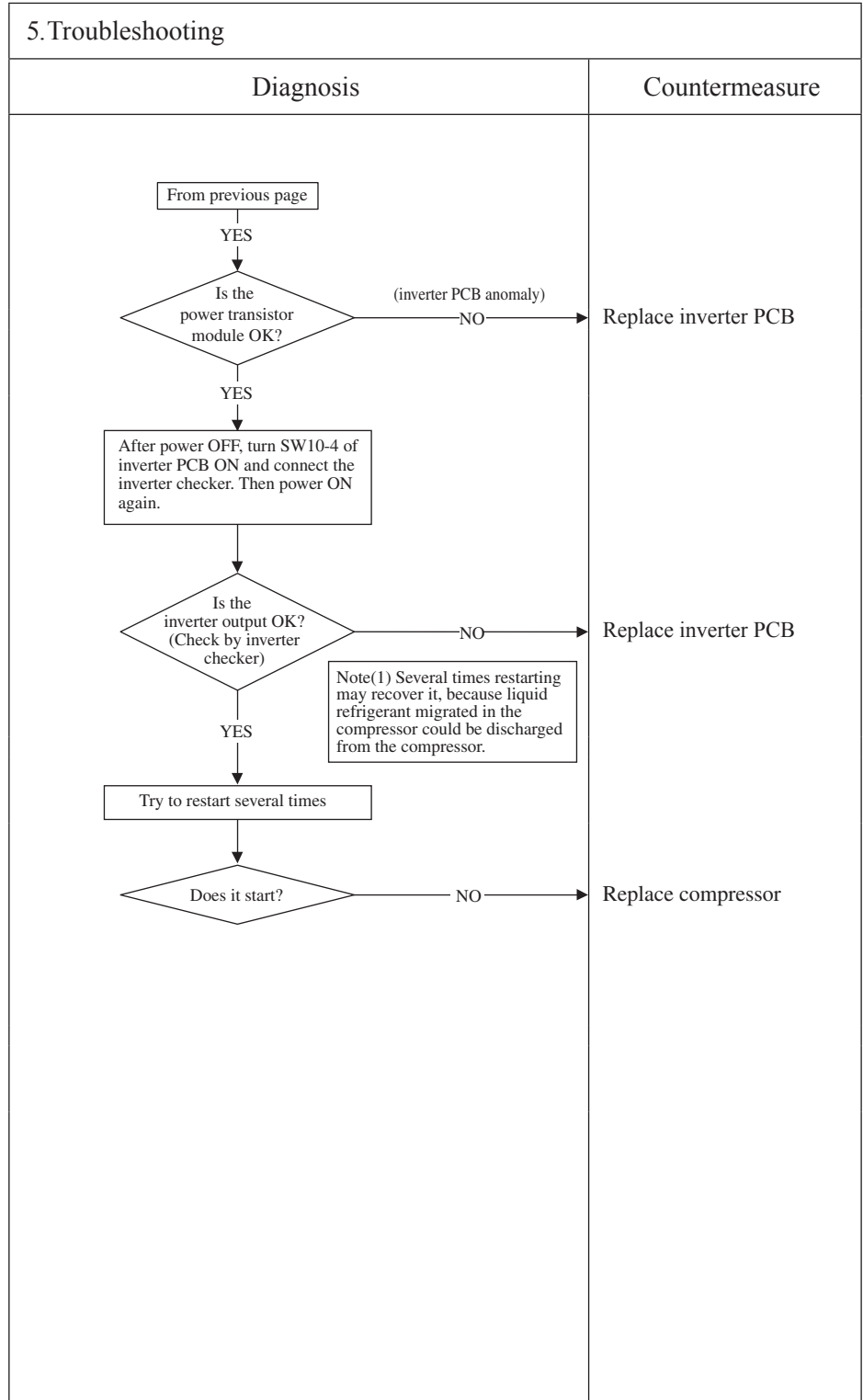

Note:

1.13 TECHNICAL INFORMATION

(1) Ceiling cassette-4way type (FDT)

Model FDT100VNVF1

Information to identify the model(s) to which the information relates to:				If function includes heating: Indicate the heating season the information relates to. Indicated values should relate to one heating season at a time. Include at least the heating season 'Average'.			
Indoor unit model name		FDT100VF1		Average(mandatory)		Yes	
Outdoor unit model name		FDC100VN		Warmer(if designated)		No	
Function(indicate if present)				Colder(if designated)			
cooling		Yes					
heating		Yes					
Item	symbol	value	unit	Item	symbol	value	class
Design load				Seasonal efficiency and energy efficiency class			
cooling	Pdesignc	10.0	kW	cooling	SEER	5.61	A+
heating / Average	Pdesignh	9.7	kW	heating / Average	SCOP/A	3.92	A
heating / Warmer	Pdesignh	-	kW	heating / Warmer	SCOP/W	-	-
heating / Colder	Pdesignh	-	kW	heating / Colder	SCOP/C	-	-
				unit			
Declared capacity at outdoor temperature Tdesignh				Back up heating capacity at outdoor temperature Tdesignh			
heating / Average (-10°C)	Pdh	8.05	kW	heating / Average (-10°C)	elbu	1.65	kW
heating / Warmer (2°C)	Pdh	-	kW	heating / Warmer (2°C)	elbu	-	kW
heating / Colder (-22°C)	Pdh	-	kW	heating / Colder (-22°C)	elbu	-	kW
Declared capacity for cooling, at indoor temperature 27(19)°C and outdoor temperature Tj				Declared energy efficiency ratio, at indoor temperature 27(19)°C and outdoor temperature Tj			
Tj=35°C	Pdc	10.00	kW	Tj=35°C	EERd	3.62	-
Tj=30°C	Pdc	7.37	kW	Tj=30°C	EERd	5.17	-
Tj=25°C	Pdc	4.74	kW	Tj=25°C	EERd	8.10	-
Tj=20°C	Pdc	4.30	kW	Tj=20°C	EERd	10.86	-
Declared capacity for heating / Average season, at indoor temperature 20°C and outdoor temperature Tj				Declared coefficient of performance / Average season, at indoor temperature 20°C and outdoor temperature Tj			
Tj=-7°C	Pdh	8.59	kW	Tj=-7°C	COPd	2.68	-
Tj=2°C	Pdh	5.20	kW	Tj=2°C	COPd	3.75	-
Tj=7°C	Pdh	3.41	kW	Tj=7°C	COPd	5.17	-
Tj=12°C	Pdh	3.50	kW	Tj=12°C	COPd	6.44	-
Tj=bivalent temperature	Pdh	8.59	kW	Tj=bivalent temperature	COPd	2.68	-
Tj=operating limit	Pdh	6.25	kW	Tj=operating limit	COPd	2.17	-
Declared capacity for heating / Warmer season, at indoor temperature 20°C and outdoor temperature Tj				Declared coefficient of performance / Warmer season, at indoor temperature 20°C and outdoor temperature Tj			
Tj=2°C	Pdh	-	kW	Tj=2°C	COPd	-	-
Tj=7°C	Pdh	-	kW	Tj=7°C	COPd	-	-
Tj=12°C	Pdh	-	kW	Tj=12°C	COPd	-	-
Tj=bivalent temperature	Pdh	-	kW	Tj=bivalent temperature	COPd	-	-
Tj=operating limit	Pdh	-	kW	Tj=operating limit	COPd	-	-
Declared capacity for heating / Colder season, at indoor temperature 20°C and outdoor temperature Tj				Declared coefficient of performance / Colder season, at indoor temperature 20°C and outdoor temperature Tj			
Tj=-7°C	Pdh	-	kW	Tj=-7°C	COPd	-	-
Tj=2°C	Pdh	-	kW	Tj=2°C	COPd	-	-
Tj=7°C	Pdh	-	kW	Tj=7°C	COPd	-	-
Tj=12°C	Pdh	-	kW	Tj=12°C	COPd	-	-
Tj=bivalent temperature	Pdh	-	kW	Tj=bivalent temperature	COPd	-	-
Tj=operating limit	Pdh	-	kW	Tj=operating limit	COPd	-	-
Tj=-15°C	Pdh	-	kW	Tj=-15°C	COPd	-	-
Bivalent temperature				Operating limit temperature			
heating / Average	Tbiv	-7	°C	heating / Average	Tol	-20	°C
heating / Warmer	Tbiv	-	°C	heating / Warmer	Tol	-	°C
heating / Colder	Tbiv	-	°C	heating / Colder	Tol	-	°C
Cycling interval capacity				Cycling interval efficiency			
for cooling	Pcycc	-	kW	for cooling	EERcyc	-	-
for heating	Pcyhc	-	kW	for heating	COPcyc	-	-
Degradation coefficient cooling				Degradation coefficient heating			
	Cdc	0.25	-		Cdh	0.25	-
Electric power input in power modes other than 'active mode'				Annual electricity consumption			
off mode	Poff	20	W	cooling	Qce	625	kWh/a
standby mode	Psb	20	W	heating / Average	Qhe	3466	kWh/a
thermostat-off mode	Pto	28	W	heating / Warmer	Qhe	-	kWh/a
crankcase heater mode	Pck	25	W	heating / colder	Qhe	-	kWh/a
Capacity control(indicate one of three options)				Other items			
fixed		No		Sound power level(indoor)	Lwa	65	dB(A)
staged		No		Sound power level(outdoor)	Lwa	70	dB(A)
variable		Yes		Global warming potential	GWP	1975	kgCO2eq.
				Rated air flow(indoor)	-	2220	m3/h
				Rated air flow(outdoor)	-	4500	m3/h
Contact details for obtaining more information	Name and address of the manufacturer or of its authorised representative. Mitsubishi Heavy Industries Air-Conditioning Europe, Ltd. 7 Roundwood Avenue, Stockley Park, Uxbridge, Middlesex, UB11 1AX, United Kingdom						

PJF000Z314 

Model FDT100VNVF2

Information to identify the model(s) to which the information relates to:		If function includes heating: Indicate the heating season the information relates to. Indicated values should relate to one heating season at a time. Include at least the heating season 'Average'.	
Indoor unit model name	FDT100VF2		
Outdoor unit model name	FDC100VN		
Function(indicate if present)		Average(mandatory)	
cooling	Yes	Warmer(if designated)	No
heating	Yes	Colder(if designated)	No
Item	symbol	value	unit
Design load			
cooling	Pdesignc	10.0	kW
heating / Average	Pdesignh	9.7	kW
heating / Warmer	Pdesignh	-	kW
heating / Colder	Pdesignh	-	kW
Declared capacity at outdoor temperature Tdesignh		Back up heating capacity at outdoor temperature Tdesignh	
heating / Average (-10°C)	Pdh	8.05	kW
heating / Warmer (2°C)	Pdh	-	kW
heating / Colder (-22°C)	Pdh	-	kW
Declared capacity for cooling, at indoor temperature 27(19)°C and outdoor temperature Tj		Declared energy efficiency ratio, at indoor temperature 27(19)°C and outdoor temperature Tj	
Tj=35°C	Pdc	10.00	kW
Tj=30°C	Pdc	7.37	kW
Tj=25°C	Pdc	4.74	kW
Tj=20°C	Pdc	4.30	kW
Declared capacity for heating / Average season, at indoor temperature 20°C and outdoor temperature Tj		Declared coefficient of performance / Average season, at indoor temperature 20°C and outdoor temperature Tj	
Tj=-7°C	Pdh	8.59	kW
Tj=2°C	Pdh	5.20	kW
Tj=7°C	Pdh	3.41	kW
Tj=12°C	Pdh	3.50	kW
Tj=bivalent temperature	Pdh	8.59	kW
Tj=operating limit	Pdh	6.25	kW
Declared capacity for heating / Warmer season, at indoor temperature 20°C and outdoor temperature Tj		Declared coefficient of performance / Warmer season, at indoor temperature 20°C and outdoor temperature Tj	
Tj=2°C	Pdh	-	kW
Tj=7°C	Pdh	-	kW
Tj=12°C	Pdh	-	kW
Tj=bivalent temperature	Pdh	-	kW
Tj=operating limit	Pdh	-	kW
Declared capacity for heating / Colder season, at indoor temperature 20°C and outdoor temperature Tj		Declared coefficient of performance / Colder season, at indoor temperature 20°C and outdoor temperature Tj	
Tj=-7°C	Pdh	-	kW
Tj=2°C	Pdh	-	kW
Tj=7°C	Pdh	-	kW
Tj=12°C	Pdh	-	kW
Tj=bivalent temperature	Pdh	-	kW
Tj=operating limit	Pdh	-	kW
Tj=-15°C	Pdh	-	kW
Bivalent temperature		Operating limit temperature	
heating / Average	Tbiv	-7	°C
heating / Warmer	Tbiv	-	°C
heating / Colder	Tbiv	-	°C
Cycling interval capacity		Cycling interval efficiency	
for cooling	Pcycc	-	kW
for heating	Pcyhc	-	kW
Degradation coefficient		Degradation coefficient	
cooling	Cdc	0.25	-
Electric power input in power modes other than 'active mode'		Annual electricity consumption	
off mode	Poff	20	W
standby mode	Psb	20	W
thermostat-off mode	Pto	28	W
crankcase heater mode	Pck	25	W
Capacity control(indicate one of three options)		Other items	
fixed	No	Sound power level(indoor)	Lwa 65 dB(A)
staged	No	Sound power level(outdoor)	Lwa 70 dB(A)
variable	Yes	Global warming potential	GWP 1975 kgCO2eq.
Contact details for obtaining more information		Name and address of the manufacturer or of its authorised representative.	
		Mitsubishi Heavy Industries Air-Conditioning Europe, Ltd. 7 Roundwood Avenue, Stockley Park, Uxbridge, Middlesex, UB11 1AX, United Kingdom	

PJF000Z314 

Model FDT100VSVF1

Information to identify the model(s) to which the information relates to:		If function includes heating: Indicate the heating season the information relates to. Indicated values should relate to one heating season at a time. Include at least the heating season 'Average'.	
Indoor unit model name	FDT100VF1		
Outdoor unit model name	FDC100VS		
Function(indicate if present)		Average(mandatory)	
cooling	Yes	Warmer(if designated)	No
heating	Yes	Colder(if designated)	No
Item	symbol	value	unit
Design load		Seasonal efficiency and energy efficiency class	
cooling	Pdesignc	10.0	kW
heating / Average	Pdesignh	9.7	kW
heating / Warmer	Pdesignh	-	kW
heating / Colder	Pdesignh	-	kW
Declared capacity at outdoor temperature Tdesignh		Back up heating capacity at outdoor temperature Tdesignh	
heating / Average (-10°C)	Pdh	8.05	kW
heating / Warmer (2°C)	Pdh	-	kW
heating / Colder (-22°C)	Pdh	-	kW
Declared capacity for cooling, at indoor temperature 27(19)°C and outdoor temperature Tj		Declared energy efficiency ratio, at indoor temperature 27(19)°C and outdoor temperature Tj	
Tj=35°C	Pdc	10.00	kW
Tj=30°C	Pdc	7.37	kW
Tj=25°C	Pdc	4.74	kW
Tj=20°C	Pdc	4.30	kW
Declared capacity for heating / Average season, at indoor temperature 20°C and outdoor temperature Tj		Declared coefficient of performance / Average season, at indoor temperature 20°C and outdoor temperature Tj	
Tj=-7°C	Pdh	8.59	kW
Tj=2°C	Pdh	5.20	kW
Tj=7°C	Pdh	3.41	kW
Tj=12°C	Pdh	3.50	kW
Tj=bivalent temperature	Pdh	8.59	kW
Tj=operating limit	Pdh	6.25	kW
Declared capacity for heating / Warmer season, at indoor temperature 20°C and outdoor temperature Tj		Declared coefficient of performance / Warmer season, at indoor temperature 20°C and outdoor temperature Tj	
Tj=2°C	Pdh	-	kW
Tj=7°C	Pdh	-	kW
Tj=12°C	Pdh	-	kW
Tj=bivalent temperature	Pdh	-	kW
Tj=operating limit	Pdh	-	kW
Declared capacity for heating / Colder season, at indoor temperature 20°C and outdoor temperature Tj		Declared coefficient of performance / Colder season, at indoor temperature 20°C and outdoor temperature Tj	
Tj=-7°C	Pdh	-	kW
Tj=2°C	Pdh	-	kW
Tj=7°C	Pdh	-	kW
Tj=12°C	Pdh	-	kW
Tj=bivalent temperature	Pdh	-	kW
Tj=operating limit	Pdh	-	kW
Tj=-15°C	Pdh	-	kW
Bivalent temperature		Operating limit temperature	
heating / Average	Tbiv	-7	°C
heating / Warmer	Tbiv	-	°C
heating / Colder	Tbiv	-	°C
Cycling interval capacity		Cycling interval efficiency	
for cooling	Pcycc	-	kW
for heating	Pcyhc	-	kW
Degradation coefficient		Degradation coefficient	
cooling	Cdc	0.25	-
Electric power input in power modes other than 'active mode'		Annual electricity consumption	
off mode	Poff	20	W
standby mode	Psb	20	W
thermostat-off mode	Pto	48	W
crankcase heater mode	Pck	25	W
Capacity control(indicate one of three options)		Other items	
fixed	No	Sound power level(indoor)	Lwa 65 dB(A)
staged	No	Sound power level(outdoor)	Lwa 70 dB(A)
variable	Yes	Global warming potential	GWP 1975 kgCO2eq.
Contact details for obtaining more information		Name and address of the manufacturer or of its authorised representative.	
		Mitsubishi Heavy Industries Air-Conditioning Europe, Ltd. 7 Roundwood Avenue, Stockley Park, Uxbridge, Middlesex, UB11 1AX, United Kingdom	

PJF000Z314 

Model FDT100VSF2

Information to identify the model(s) to which the information relates to:		If function includes heating: Indicate the heating season the information relates to. Indicated values should relate to one heating season at a time. Include at least the heating season 'Average'.	
Indoor unit model name	FDT100VF2		
Outdoor unit model name	FDC100VS		
Function(indicate if present)		Average(mandatory)	
cooling	Yes	Warmer(if designated)	No
heating	Yes	Colder(if designated)	No
Item	symbol	value	unit
Design load		Seasonal efficiency and energy efficiency class	
cooling	Pdesignc	10.0	kW
heating / Average	Pdesignh	9.7	kW
heating / Warmer	Pdesignh	-	kW
heating / Colder	Pdesignh	-	kW
Declared capacity at outdoor temperature Tdesignh		Back up heating capacity at outdoor temperature Tdesignh	
heating / Average (-10°C)	Pdh	8.05	kW
heating / Warmer (2°C)	Pdh	-	kW
heating / Colder (-22°C)	Pdh	-	kW
Declared capacity for cooling, at indoor temperature 27(19)°C and outdoor temperature Tj		Declared energy efficiency ratio, at indoor temperature 27(19)°C and outdoor temperature Tj	
Tj=35°C	Pdc	10.00	kW
Tj=30°C	Pdc	7.37	kW
Tj=25°C	Pdc	4.74	kW
Tj=20°C	Pdc	4.30	kW
Declared capacity for heating / Average season, at indoor temperature 20°C and outdoor temperature Tj		Declared coefficient of performance / Average season, at indoor temperature 20°C and outdoor temperature Tj	
Tj=-7°C	Pdh	8.59	kW
Tj=2°C	Pdh	5.20	kW
Tj=7°C	Pdh	3.41	kW
Tj=12°C	Pdh	3.50	kW
Tj=bivalent temperature	Pdh	8.59	kW
Tj=operating limit	Pdh	6.25	kW
Declared capacity for heating / Warmer season, at indoor temperature 20°C and outdoor temperature Tj		Declared coefficient of performance / Warmer season, at indoor temperature 20°C and outdoor temperature Tj	
Tj=2°C	Pdh	-	kW
Tj=7°C	Pdh	-	kW
Tj=12°C	Pdh	-	kW
Tj=bivalent temperature	Pdh	-	kW
Tj=operating limit	Pdh	-	kW
Declared capacity for heating / Colder season, at indoor temperature 20°C and outdoor temperature Tj		Declared coefficient of performance / Colder season, at indoor temperature 20°C and outdoor temperature Tj	
Tj=-7°C	Pdh	-	kW
Tj=2°C	Pdh	-	kW
Tj=7°C	Pdh	-	kW
Tj=12°C	Pdh	-	kW
Tj=bivalent temperature	Pdh	-	kW
Tj=operating limit	Pdh	-	kW
Tj=-15°C	Pdh	-	kW
Bivalent temperature		Operating limit temperature	
heating / Average	Tbiv	-7	°C
heating / Warmer	Tbiv	-	°C
heating / Colder	Tbiv	-	°C
Cycling interval capacity		Cycling interval efficiency	
for cooling	Pcycc	-	kW
for heating	Pcyhc	-	kW
Degradation coefficient		Degradation coefficient	
cooling	Cdc	0.25	-
Electric power input in power modes other than 'active mode'		Annual electricity consumption	
off mode	Poff	20	W
standby mode	Psb	20	W
thermostat-off mode	Pto	48	W
crankcase heater mode	Pck	25	W
Capacity control(indicate one of three options)		Other items	
fixed		No	
staged		No	
variable		Yes	
Contact details for obtaining more information		Name and address of the manufacturer or of its authorised representative. Mitsubishi Heavy Industries Air-Conditioning Europe, Ltd. 7 Roundwood Avenue, Stockley Park, Uxbridge, Middlesex, UB11 1AX, United Kingdom	

PJF000Z314 

Model FDT100VNPVF

Information to identify the model(s) to which the information relates to:				If function includes heating: Indicate the heating season the information relates to. Indicated values should relate to one heating season at a time. Include at least the heating season 'Average'.			
Indoor unit model name		FDT50VF x 2		Average(mandatory)		Yes	
Outdoor unit model name		FDC100VN		Warmer(if designated)		No	
Function(indicate if present)				Colder(if designated)			
cooling		Yes					
heating		Yes					
Item				Item			
symbol		value		symbol		value	
unit		unit		class		class	
Design load				Seasonal efficiency and energy efficiency class			
cooling		Pdesignc 10.0 kW		cooling		SEER 5.89 A+	
heating / Average		Pdesignh 9.5 kW		heating / Average		SCOP/A 3.81 A	
heating / Warmer		Pdesignh - kW		heating / Warmer		SCOP/W - -	
heating / Colder		Pdesignh - kW		heating / Colder		SCOP/C - -	
Declared capacity at outdoor temperature Tdesignh				Back up heating capacity at outdoor temperature Tdesignh			
heating / Average (-10°C)		Pdh 7.96 kW		heating / Average (-10°C)		elbu 1.54 kW	
heating / Warmer (2°C)		Pdh - kW		heating / Warmer (2°C)		elbu - kW	
heating / Colder (-22°C)		Pdh - kW		heating / Colder (-22°C)		elbu - kW	
Declared capacity for cooling, at indoor temperature 27(19)°C and outdoor temperature Tj				Declared energy efficiency ratio, at indoor temperature 27(19)°C and outdoor temperature Tj			
Tj=35°C		Pdc 10.00 kW		Tj=35°C		EERd 3.40 -	
Tj=30°C		Pdc 7.37 kW		Tj=30°C		EERd 5.38 -	
Tj=25°C		Pdc 4.74 kW		Tj=25°C		EERd 8.94 -	
Tj=20°C		Pdc 4.50 kW		Tj=20°C		EERd 12.33 -	
Declared capacity for heating / Average season, at indoor temperature 20°C and outdoor temperature Tj				Declared coefficient of performance / Average season, at indoor temperature 20°C and outdoor temperature Tj			
Tj=-7°C		Pdh 8.41 kW		Tj=-7°C		COPd 2.51 -	
Tj=2°C		Pdh 5.11 kW		Tj=2°C		COPd 3.57 -	
Tj=7°C		Pdh 3.29 kW		Tj=7°C		COPd 5.39 -	
Tj=12°C		Pdh 3.55 kW		Tj=12°C		COPd 6.51 -	
Tj=bivalent temperature		Pdh 8.41 kW		Tj=bivalent temperature		COPd 2.51 -	
Tj=operating limit		Pdh 6.45 kW		Tj=operating limit		COPd 2.35 -	
Declared capacity for heating / Warmer season, at indoor temperature 20°C and outdoor temperature Tj				Declared coefficient of performance / Warmer season, at indoor temperature 20°C and outdoor temperature Tj			
Tj=2°C		Pdh - kW		Tj=2°C		COPd - -	
Tj=7°C		Pdh - kW		Tj=7°C		COPd - -	
Tj=12°C		Pdh - kW		Tj=12°C		COPd - -	
Tj=bivalent temperature		Pdh - kW		Tj=bivalent temperature		COPd - -	
Tj=operating limit		Pdh - kW		Tj=operating limit		COPd - -	
Declared capacity for heating / Colder season, at indoor temperature 20°C and outdoor temperature Tj				Declared coefficient of performance / Colder season, at indoor temperature 20°C and outdoor temperature Tj			
Tj=-7°C		Pdh - kW		Tj=-7°C		COPd - -	
Tj=2°C		Pdh - kW		Tj=2°C		COPd - -	
Tj=7°C		Pdh - kW		Tj=7°C		COPd - -	
Tj=12°C		Pdh - kW		Tj=12°C		COPd - -	
Tj=bivalent temperature		Pdh - kW		Tj=bivalent temperature		COPd - -	
Tj=operating limit		Pdh - kW		Tj=operating limit		COPd - -	
Tj=-15°C		Pdh - kW		Tj=-15°C		COPd - -	
Bivalent temperature				Operating limit temperature			
heating / Average		Tbiv -7 °C		heating / Average		Tol -20 °C	
heating / Warmer		Tbiv - °C		heating / Warmer		Tol - °C	
heating / Colder		Tbiv - °C		heating / Colder		Tol - °C	
Cycling interval capacity				Cycling interval efficiency			
for cooling		Pcycc - kW		for cooling		EERcyc - -	
for heating		Pcyh - kW		for heating		COPcyc - -	
Degradation coefficient				Degradation coefficient			
cooling		Cdc 0.25 -		heating		Cdh 0.25 -	
Electric power input in power modes other than 'active mode'				Annual electricity consumption			
off mode		Poff 20 W		cooling		Qce 595 kWh/a	
standby mode		Psb 20 W		heating / Average		Qhe 3488 kWh/a	
thermostat-off mode		Pto 38 W		heating / Warmer		Qhe - kWh/a	
crankcase heater mode		Pck 25 W		heating / colder		Qhe - kWh/a	
Capacity control(indicate one of three options)				Other items			
fixed		No		Sound power level(indoor)		Lwa 55 dB(A)	
staged		No		Sound power level(outdoor)		Lwa 70 dB(A)	
variable		Yes		Global warming potential		GWP 1975 kgCO2eq.	
				Rated air flow(indoor)		- 1200 m3/h	
				Rated air flow(outdoor)		- 4500 m3/h	
Contact details for obtaining more information		Name and address of the manufacturer or of its authorised representative. Mitsubishi Heavy Industries Air-Conditioning Europe, Ltd. 7 Roundwood Avenue, Stockley Park, Uxbridge, Middlesex, UB11 1AX, United Kingdom					

PJF000Z314 

Model FDT100VSPVF

Information to identify the model(s) to which the information relates to: Indoor unit model name FDT50VF x 2 Outdoor unit model name FDC100VS				If function includes heating: Indicate the heating season the information relates to. Indicated values should relate to one heating season at a time. Include at least the heating season 'Average'.			
Function(indicate if present)				Average(mandatory) Yes Warmer(if designated) No Colder(if designated) No			
cooling Yes heating Yes							
Item symbol value unit				Item symbol value class			
Design load				Seasonal efficiency and energy efficiency class			
cooling	Pdesignc	10.0	kW	cooling	SEER	5.85	A+
heating / Average	Pdesignh	9.5	kW	heating / Average	SCOP/A	3.81	A
heating / Warmer	Pdesignh	-	kW	heating / Warmer	SCOP/W	-	-
heating / Colder	Pdesignh	-	kW	heating / Colder	SCOP/C	-	-
Declared capacity at outdoor temperature Tdesignh				Back up heating capacity at outdoor temperature Tdesignh			
heating / Average (-10°C)	Pdh	7.96	kW	heating / Average (-10°C)	elbu	1.54	kW
heating / Warmer (2°C)	Pdh	-	kW	heating / Warmer (2°C)	elbu	-	kW
heating / Colder (-22°C)	Pdh	-	kW	heating / Colder (-22°C)	elbu	-	kW
Declared capacity for cooling, at indoor temperature 27(19)°C and outdoor temperature Tj				Declared energy efficiency ratio, at indoor temperature 27(19)°C and outdoor temperature Tj			
Tj=35°C	Pdc	10.00	kW	Tj=35°C	EERd	3.40	-
Tj=30°C	Pdc	7.37	kW	Tj=30°C	EERd	5.38	-
Tj=25°C	Pdc	4.74	kW	Tj=25°C	EERd	8.94	-
Tj=20°C	Pdc	4.50	kW	Tj=20°C	EERd	12.33	-
Declared capacity for heating / Average season, at indoor temperature 20°C and outdoor temperature Tj				Declared coefficient of performance / Average season, at indoor temperature 20°C and outdoor temperature Tj			
Tj=-7°C	Pdh	8.41	kW	Tj=-7°C	COPd	2.51	-
Tj=2°C	Pdh	5.11	kW	Tj=2°C	COPd	3.57	-
Tj=7°C	Pdh	3.29	kW	Tj=7°C	COPd	5.39	-
Tj=12°C	Pdh	3.55	kW	Tj=12°C	COPd	6.51	-
Tj=bivalent temperature	Pdh	8.41	kW	Tj=bivalent temperature	COPd	2.51	-
Tj=operating limit	Pdh	6.45	kW	Tj=operating limit	COPd	2.35	-
Declared capacity for heating / Warmer season, at indoor temperature 20°C and outdoor temperature Tj				Declared coefficient of performance / Warmer season, at indoor temperature 20°C and outdoor temperature Tj			
Tj=2°C	Pdh	-	kW	Tj=2°C	COPd	-	-
Tj=7°C	Pdh	-	kW	Tj=7°C	COPd	-	-
Tj=12°C	Pdh	-	kW	Tj=12°C	COPd	-	-
Tj=bivalent temperature	Pdh	-	kW	Tj=bivalent temperature	COPd	-	-
Tj=operating limit	Pdh	-	kW	Tj=operating limit	COPd	-	-
Declared capacity for heating / Colder season, at indoor temperature 20°C and outdoor temperature Tj				Declared coefficient of performance / Colder season, at indoor temperature 20°C and outdoor temperature Tj			
Tj=-7°C	Pdh	-	kW	Tj=-7°C	COPd	-	-
Tj=2°C	Pdh	-	kW	Tj=2°C	COPd	-	-
Tj=7°C	Pdh	-	kW	Tj=7°C	COPd	-	-
Tj=12°C	Pdh	-	kW	Tj=12°C	COPd	-	-
Tj=bivalent temperature	Pdh	-	kW	Tj=bivalent temperature	COPd	-	-
Tj=operating limit	Pdh	-	kW	Tj=operating limit	COPd	-	-
Tj=-15°C	Pdh	-	kW	Tj=-15°C	COPd	-	-
Bivalent temperature				Operating limit temperature			
heating / Average	Tbiv	-7	°C	heating / Average	Tol	-20	°C
heating / Warmer	Tbiv	-	°C	heating / Warmer	Tol	-	°C
heating / Colder	Tbiv	-	°C	heating / Colder	Tol	-	°C
Cycling interval capacity				Cycling interval efficiency			
for cooling	Pcycc	-	kW	for cooling	EERcyc	-	-
for heating	Pcyh	-	kW	for heating	COPcyc	-	-
Degradation coefficient				Degradation coefficient			
cooling	Cdc	0.25	-	heating	Cdh	0.25	-
Electric power input in power modes other than 'active mode'				Annual electricity consumption			
off mode	Poff	20	W	cooling	Qce	599	kWh/a
standby mode	Psb	20	W	heating / Average	Qhe	3492	kWh/a
thermostat-off mode	Pto	58	W	heating / Warmer	Qhe	-	kWh/a
crankcase heater mode	Pck	25	W	heating / colder	Qhe	-	kWh/a
Capacity control(indicate one of three options)				Other items			
fixed		No		Sound power level(indoor)	Lwa	55	dB(A)
staged		No		Sound power level(outdoor)	Lwa	70	dB(A)
variable		Yes		Global warming potential	GWP	1975	kgCO2eq.
				Rated air flow(indoor)	-	1200	m3/h
				Rated air flow(outdoor)	-	4500	m3/h
Contact details for obtaining more information	Name and address of the manufacturer or of its authorised representative. Mitsubishi Heavy Industries Air-Conditioning Europe, Ltd. 7 Roundwood Avenue, Stockley Park, Uxbridge, Middlesex, UB11 1AX, United Kingdom						

PJF000Z314 

(2) Ceiling cassette-4way compact type (FDTC)

Model FDTC100VNPVF

Information to identify the model(s) to which the information relates to: Indoor unit model name FDTC50VF x 2 Outdoor unit model name FDC100VN				If function includes heating: Indicate the heating season the information relates to. Indicated values should relate to one heating season at a time. Include at least the heating season 'Average'.			
Function(indicate if present) cooling Yes heating Yes				Average(mandatory) Yes Warmer(if designated) No Colder(if designated) No			
Item	symbol	value	unit	Item	symbol	value	class
Design load				Seasonal efficiency and energy efficiency class			
cooling	Pdesignc	10.0	kW	cooling	SEER	5.17	A
heating / Average	Pdesignh	9.4	kW	heating / Average	SCOP/A	3.84	A
heating / Warmer	Pdesignh	-	kW	heating / Warmer	SCOP/W	-	-
heating / Colder	Pdesignh	-	kW	heating / Colder	SCOP/C	-	-
				unit			
Declared capacity at outdoor temperature Tdesignh				Back up heating capacity at outdoor temperature Tdesignh			
heating / Average (-10°C)	Pdh	7.87	kW	heating / Average (-10°C)	elbu	1.53	kW
heating / Warmer (2°C)	Pdh	-	kW	heating / Warmer (2°C)	elbu	-	kW
heating / Colder (-22°C)	Pdh	-	kW	heating / Colder (-22°C)	elbu	-	kW
Declared capacity for cooling, at indoor temperature 27(19)°C and outdoor temperature Tj				Declared energy efficiency ratio, at indoor temperature 27(19)°C and outdoor temperature Tj			
Tj=35°C	Pdc	10.00	kW	Tj=35°C	EERd	3.08	-
Tj=30°C	Pdc	7.37	kW	Tj=30°C	EERd	4.47	-
Tj=25°C	Pdc	4.74	kW	Tj=25°C	EERd	7.35	-
Tj=20°C	Pdc	4.20	kW	Tj=20°C	EERd	11.05	-
Declared capacity for heating / Average season, at indoor temperature 20°C and outdoor temperature Tj				Declared coefficient of performance / Average season, at indoor temperature 20°C and outdoor temperature Tj			
Tj=-7°C	Pdh	8.32	kW	Tj=-7°C	COPd	2.38	-
Tj=2°C	Pdh	5.06	kW	Tj=2°C	COPd	3.69	-
Tj=7°C	Pdh	3.25	kW	Tj=7°C	COPd	5.42	-
Tj=12°C	Pdh	3.60	kW	Tj=12°C	COPd	6.55	-
Tj=bivalent temperature	Pdh	8.32	kW	Tj=bivalent temperature	COPd	2.38	-
Tj=operating limit	Pdh	6.35	kW	Tj=operating limit	COPd	2.35	-
Declared capacity for heating / Warmer season, at indoor temperature 20°C and outdoor temperature Tj				Declared coefficient of performance / Warmer season, at indoor temperature 20°C and outdoor temperature Tj			
Tj=2°C	Pdh	-	kW	Tj=2°C	COPd	-	-
Tj=7°C	Pdh	-	kW	Tj=7°C	COPd	-	-
Tj=12°C	Pdh	-	kW	Tj=12°C	COPd	-	-
Tj=bivalent temperature	Pdh	-	kW	Tj=bivalent temperature	COPd	-	-
Tj=operating limit	Pdh	-	kW	Tj=operating limit	COPd	-	-
Declared capacity for heating / Colder season, at indoor temperature 20°C and outdoor temperature Tj				Declared coefficient of performance / Colder season, at indoor temperature 20°C and outdoor temperature Tj			
Tj=-7°C	Pdh	-	kW	Tj=-7°C	COPd	-	-
Tj=2°C	Pdh	-	kW	Tj=2°C	COPd	-	-
Tj=7°C	Pdh	-	kW	Tj=7°C	COPd	-	-
Tj=12°C	Pdh	-	kW	Tj=12°C	COPd	-	-
Tj=bivalent temperature	Pdh	-	kW	Tj=bivalent temperature	COPd	-	-
Tj=operating limit	Pdh	-	kW	Tj=operating limit	COPd	-	-
Tj=-15°C	Pdh	-	kW	Tj=-15°C	COPd	-	-
Bivalent temperature				Operating limit temperature			
heating / Average	Tbiv	-7	°C	heating / Average	Tol	-20	°C
heating / Warmer	Tbiv	-	°C	heating / Warmer	Tol	-	°C
heating / Colder	Tbiv	-	°C	heating / Colder	Tol	-	°C
Cycling interval capacity				Cycling interval efficiency			
for cooling	Pcycc	-	kW	for cooling	EERcyc	-	-
for heating	Pcyh	-	kW	for heating	COPcyc	-	-
Degradation coefficient				Degradation coefficient			
cooling	Cdc	0.25	-	heating	Cdh	0.25	-
Electric power input in power modes other than 'active mode'				Annual electricity consumption			
off mode	Poff	20	W	cooling	Qce	678	kWh/a
standby mode	Psb	20	W	heating / Average	Qhe	3424	kWh/a
thermostat-off mode	Pto	38	W	heating / Warmer	Qhe	-	kWh/a
crankcase heater mode	Pck	25	W	heating / colder	Qhe	-	kWh/a
Capacity control(indicate one of three options)				Other items			
fixed		No		Sound power level(indoor)	Lwa	60	dB(A)
staged		No		Sound power level(outdoor)	Lwa	70	dB(A)
variable		Yes		Global warming potential	GWP	1975	kgCO2eq.
				Rated air flow(indoor)	-	810	m3/h
				Rated air flow(outdoor)	-	4500	m3/h
Contact details for obtaining more information	Name and address of the manufacturer or of its authorised representative. Mitsubishi Heavy Industries Air-Conditioning Europe, Ltd. 7 Roundwood Avenue, Stockley Park, Uxbridge, Middlesex, UB11 1AX, United Kingdom						

PJA003Z401 

Model FDTC100VSPVF

Information to identify the model(s) to which the information relates to: Indoor unit model name FDTC50VF x 2 Outdoor unit model name FDC100VS				If function includes heating: Indicate the heating season the information relates to. Indicated values should relate to one heating season at a time. Include at least the heating season 'Average'.																																																																											
Function(indicate if present) cooling Yes heating Yes				Average(mandatory) Yes Warmer(if designated) No Colder(if designated) No																																																																											
<table border="1"> <thead> <tr> <th>Item</th> <th>symbol</th> <th>value</th> <th>unit</th> </tr> </thead> <tbody> <tr> <td>Design load</td> <td></td> <td></td> <td></td> </tr> <tr> <td>cooling</td> <td>Pdesignc</td> <td>10.0</td> <td>kW</td> </tr> <tr> <td>heating / Average</td> <td>Pdesignh</td> <td>9.4</td> <td>kW</td> </tr> <tr> <td>heating / Warmer</td> <td>Pdesignh</td> <td>-</td> <td>kW</td> </tr> <tr> <td>heating / Colder</td> <td>Pdesignh</td> <td>-</td> <td>kW</td> </tr> </tbody> </table>				Item	symbol	value	unit	Design load				cooling	Pdesignc	10.0	kW	heating / Average	Pdesignh	9.4	kW	heating / Warmer	Pdesignh	-	kW	heating / Colder	Pdesignh	-	kW	<table border="1"> <thead> <tr> <th>Item</th> <th>symbol</th> <th>value</th> <th>class</th> </tr> </thead> <tbody> <tr> <td>Seasonal efficiency and energy efficiency class</td> <td></td> <td></td> <td></td> </tr> <tr> <td>cooling</td> <td>SEER</td> <td>5.13</td> <td>A</td> </tr> <tr> <td>heating / Average</td> <td>SCOP/A</td> <td>3.84</td> <td>A</td> </tr> <tr> <td>heating / Warmer</td> <td>SCOP/W</td> <td>-</td> <td>-</td> </tr> <tr> <td>heating / Colder</td> <td>SCOP/C</td> <td>-</td> <td>-</td> </tr> </tbody> </table>				Item	symbol	value	class	Seasonal efficiency and energy efficiency class				cooling	SEER	5.13	A	heating / Average	SCOP/A	3.84	A	heating / Warmer	SCOP/W	-	-	heating / Colder	SCOP/C	-	-																								
Item	symbol	value	unit																																																																												
Design load																																																																															
cooling	Pdesignc	10.0	kW																																																																												
heating / Average	Pdesignh	9.4	kW																																																																												
heating / Warmer	Pdesignh	-	kW																																																																												
heating / Colder	Pdesignh	-	kW																																																																												
Item	symbol	value	class																																																																												
Seasonal efficiency and energy efficiency class																																																																															
cooling	SEER	5.13	A																																																																												
heating / Average	SCOP/A	3.84	A																																																																												
heating / Warmer	SCOP/W	-	-																																																																												
heating / Colder	SCOP/C	-	-																																																																												
<table border="1"> <thead> <tr> <th>Item</th> <th>symbol</th> <th>value</th> <th>unit</th> </tr> </thead> <tbody> <tr> <td>Declared capacity at outdoor temperature Tdesignh</td> <td></td> <td></td> <td></td> </tr> <tr> <td>heating / Average (-10°C)</td> <td>Pdh</td> <td>7.87</td> <td>kW</td> </tr> <tr> <td>heating / Warmer (2°C)</td> <td>Pdh</td> <td>-</td> <td>kW</td> </tr> <tr> <td>heating / Colder (-22°C)</td> <td>Pdh</td> <td>-</td> <td>kW</td> </tr> </tbody> </table>				Item	symbol	value	unit	Declared capacity at outdoor temperature Tdesignh				heating / Average (-10°C)	Pdh	7.87	kW	heating / Warmer (2°C)	Pdh	-	kW	heating / Colder (-22°C)	Pdh	-	kW	<table border="1"> <thead> <tr> <th>Item</th> <th>symbol</th> <th>value</th> <th>unit</th> </tr> </thead> <tbody> <tr> <td>Back up heating capacity at outdoor temperature Tdesignh</td> <td></td> <td></td> <td></td> </tr> <tr> <td>heating / Average (-10°C)</td> <td>elbu</td> <td>1.53</td> <td>kW</td> </tr> <tr> <td>heating / Warmer (2°C)</td> <td>elbu</td> <td>-</td> <td>kW</td> </tr> <tr> <td>heating / Colder (-22°C)</td> <td>elbu</td> <td>-</td> <td>kW</td> </tr> </tbody> </table>				Item	symbol	value	unit	Back up heating capacity at outdoor temperature Tdesignh				heating / Average (-10°C)	elbu	1.53	kW	heating / Warmer (2°C)	elbu	-	kW	heating / Colder (-22°C)	elbu	-	kW																																
Item	symbol	value	unit																																																																												
Declared capacity at outdoor temperature Tdesignh																																																																															
heating / Average (-10°C)	Pdh	7.87	kW																																																																												
heating / Warmer (2°C)	Pdh	-	kW																																																																												
heating / Colder (-22°C)	Pdh	-	kW																																																																												
Item	symbol	value	unit																																																																												
Back up heating capacity at outdoor temperature Tdesignh																																																																															
heating / Average (-10°C)	elbu	1.53	kW																																																																												
heating / Warmer (2°C)	elbu	-	kW																																																																												
heating / Colder (-22°C)	elbu	-	kW																																																																												
<table border="1"> <thead> <tr> <th>Item</th> <th>symbol</th> <th>value</th> <th>unit</th> </tr> </thead> <tbody> <tr> <td>Declared capacity for cooling, at indoor temperature 27(19)°C and outdoor temperature Tj</td> <td></td> <td></td> <td></td> </tr> <tr> <td>Tj=35°C</td> <td>Pdc</td> <td>10.00</td> <td>kW</td> </tr> <tr> <td>Tj=30°C</td> <td>Pdc</td> <td>7.37</td> <td>kW</td> </tr> <tr> <td>Tj=25°C</td> <td>Pdc</td> <td>4.74</td> <td>kW</td> </tr> <tr> <td>Tj=20°C</td> <td>Pdc</td> <td>4.20</td> <td>kW</td> </tr> </tbody> </table>				Item	symbol	value	unit	Declared capacity for cooling, at indoor temperature 27(19)°C and outdoor temperature Tj				Tj=35°C	Pdc	10.00	kW	Tj=30°C	Pdc	7.37	kW	Tj=25°C	Pdc	4.74	kW	Tj=20°C	Pdc	4.20	kW	<table border="1"> <thead> <tr> <th>Item</th> <th>symbol</th> <th>value</th> <th>unit</th> </tr> </thead> <tbody> <tr> <td>Declared energy efficiency ratio, at indoor temperature 27(19)°C and outdoor temperature Tj</td> <td></td> <td></td> <td></td> </tr> <tr> <td>Tj=35°C</td> <td>EERd</td> <td>3.08</td> <td>-</td> </tr> <tr> <td>Tj=30°C</td> <td>EERd</td> <td>4.47</td> <td>-</td> </tr> <tr> <td>Tj=25°C</td> <td>EERd</td> <td>7.35</td> <td>-</td> </tr> <tr> <td>Tj=20°C</td> <td>EERd</td> <td>11.05</td> <td>-</td> </tr> </tbody> </table>				Item	symbol	value	unit	Declared energy efficiency ratio, at indoor temperature 27(19)°C and outdoor temperature Tj				Tj=35°C	EERd	3.08	-	Tj=30°C	EERd	4.47	-	Tj=25°C	EERd	7.35	-	Tj=20°C	EERd	11.05	-																								
Item	symbol	value	unit																																																																												
Declared capacity for cooling, at indoor temperature 27(19)°C and outdoor temperature Tj																																																																															
Tj=35°C	Pdc	10.00	kW																																																																												
Tj=30°C	Pdc	7.37	kW																																																																												
Tj=25°C	Pdc	4.74	kW																																																																												
Tj=20°C	Pdc	4.20	kW																																																																												
Item	symbol	value	unit																																																																												
Declared energy efficiency ratio, at indoor temperature 27(19)°C and outdoor temperature Tj																																																																															
Tj=35°C	EERd	3.08	-																																																																												
Tj=30°C	EERd	4.47	-																																																																												
Tj=25°C	EERd	7.35	-																																																																												
Tj=20°C	EERd	11.05	-																																																																												
<table border="1"> <thead> <tr> <th>Item</th> <th>symbol</th> <th>value</th> <th>unit</th> </tr> </thead> <tbody> <tr> <td>Declared capacity for heating / Average season, at indoor temperature 20°C and outdoor temperature Tj</td> <td></td> <td></td> <td></td> </tr> <tr> <td>Tj=-7°C</td> <td>Pdh</td> <td>8.32</td> <td>kW</td> </tr> <tr> <td>Tj=2°C</td> <td>Pdh</td> <td>5.06</td> <td>kW</td> </tr> <tr> <td>Tj=7°C</td> <td>Pdh</td> <td>3.25</td> <td>kW</td> </tr> <tr> <td>Tj=12°C</td> <td>Pdh</td> <td>3.60</td> <td>kW</td> </tr> <tr> <td>Tj=bivalent temperature</td> <td>Pdh</td> <td>8.32</td> <td>kW</td> </tr> <tr> <td>Tj=operating limit</td> <td>Pdh</td> <td>6.35</td> <td>kW</td> </tr> </tbody> </table>				Item	symbol	value	unit	Declared capacity for heating / Average season, at indoor temperature 20°C and outdoor temperature Tj				Tj=-7°C	Pdh	8.32	kW	Tj=2°C	Pdh	5.06	kW	Tj=7°C	Pdh	3.25	kW	Tj=12°C	Pdh	3.60	kW	Tj=bivalent temperature	Pdh	8.32	kW	Tj=operating limit	Pdh	6.35	kW	<table border="1"> <thead> <tr> <th>Item</th> <th>symbol</th> <th>value</th> <th>unit</th> </tr> </thead> <tbody> <tr> <td>Declared coefficient of performance / Average season, at indoor temperature 20°C and outdoor temperature Tj</td> <td></td> <td></td> <td></td> </tr> <tr> <td>Tj=-7°C</td> <td>COPd</td> <td>2.38</td> <td>-</td> </tr> <tr> <td>Tj=2°C</td> <td>COPd</td> <td>3.69</td> <td>-</td> </tr> <tr> <td>Tj=7°C</td> <td>COPd</td> <td>5.42</td> <td>-</td> </tr> <tr> <td>Tj=12°C</td> <td>COPd</td> <td>6.55</td> <td>-</td> </tr> <tr> <td>Tj=bivalent temperature</td> <td>COPd</td> <td>2.38</td> <td>-</td> </tr> <tr> <td>Tj=operating limit</td> <td>COPd</td> <td>2.35</td> <td>-</td> </tr> </tbody> </table>				Item	symbol	value	unit	Declared coefficient of performance / Average season, at indoor temperature 20°C and outdoor temperature Tj				Tj=-7°C	COPd	2.38	-	Tj=2°C	COPd	3.69	-	Tj=7°C	COPd	5.42	-	Tj=12°C	COPd	6.55	-	Tj=bivalent temperature	COPd	2.38	-	Tj=operating limit	COPd	2.35	-								
Item	symbol	value	unit																																																																												
Declared capacity for heating / Average season, at indoor temperature 20°C and outdoor temperature Tj																																																																															
Tj=-7°C	Pdh	8.32	kW																																																																												
Tj=2°C	Pdh	5.06	kW																																																																												
Tj=7°C	Pdh	3.25	kW																																																																												
Tj=12°C	Pdh	3.60	kW																																																																												
Tj=bivalent temperature	Pdh	8.32	kW																																																																												
Tj=operating limit	Pdh	6.35	kW																																																																												
Item	symbol	value	unit																																																																												
Declared coefficient of performance / Average season, at indoor temperature 20°C and outdoor temperature Tj																																																																															
Tj=-7°C	COPd	2.38	-																																																																												
Tj=2°C	COPd	3.69	-																																																																												
Tj=7°C	COPd	5.42	-																																																																												
Tj=12°C	COPd	6.55	-																																																																												
Tj=bivalent temperature	COPd	2.38	-																																																																												
Tj=operating limit	COPd	2.35	-																																																																												
<table border="1"> <thead> <tr> <th>Item</th> <th>symbol</th> <th>value</th> <th>unit</th> </tr> </thead> <tbody> <tr> <td>Declared capacity for heating / Warmer season, at indoor temperature 20°C and outdoor temperature Tj</td> <td></td> <td></td> <td></td> </tr> <tr> <td>Tj=2°C</td> <td>Pdh</td> <td>-</td> <td>kW</td> </tr> <tr> <td>Tj=7°C</td> <td>Pdh</td> <td>-</td> <td>kW</td> </tr> <tr> <td>Tj=12°C</td> <td>Pdh</td> <td>-</td> <td>kW</td> </tr> <tr> <td>Tj=bivalent temperature</td> <td>Pdh</td> <td>-</td> <td>kW</td> </tr> <tr> <td>Tj=operating limit</td> <td>Pdh</td> <td>-</td> <td>kW</td> </tr> </tbody> </table>				Item	symbol	value	unit	Declared capacity for heating / Warmer season, at indoor temperature 20°C and outdoor temperature Tj				Tj=2°C	Pdh	-	kW	Tj=7°C	Pdh	-	kW	Tj=12°C	Pdh	-	kW	Tj=bivalent temperature	Pdh	-	kW	Tj=operating limit	Pdh	-	kW	<table border="1"> <thead> <tr> <th>Item</th> <th>symbol</th> <th>value</th> <th>unit</th> </tr> </thead> <tbody> <tr> <td>Declared coefficient of performance / Warmer season, at indoor temperature 20°C and outdoor temperature Tj</td> <td></td> <td></td> <td></td> </tr> <tr> <td>Tj=2°C</td> <td>COPd</td> <td>-</td> <td>-</td> </tr> <tr> <td>Tj=7°C</td> <td>COPd</td> <td>-</td> <td>-</td> </tr> <tr> <td>Tj=12°C</td> <td>COPd</td> <td>-</td> <td>-</td> </tr> <tr> <td>Tj=bivalent temperature</td> <td>COPd</td> <td>-</td> <td>-</td> </tr> <tr> <td>Tj=operating limit</td> <td>COPd</td> <td>-</td> <td>-</td> </tr> </tbody> </table>				Item	symbol	value	unit	Declared coefficient of performance / Warmer season, at indoor temperature 20°C and outdoor temperature Tj				Tj=2°C	COPd	-	-	Tj=7°C	COPd	-	-	Tj=12°C	COPd	-	-	Tj=bivalent temperature	COPd	-	-	Tj=operating limit	COPd	-	-																
Item	symbol	value	unit																																																																												
Declared capacity for heating / Warmer season, at indoor temperature 20°C and outdoor temperature Tj																																																																															
Tj=2°C	Pdh	-	kW																																																																												
Tj=7°C	Pdh	-	kW																																																																												
Tj=12°C	Pdh	-	kW																																																																												
Tj=bivalent temperature	Pdh	-	kW																																																																												
Tj=operating limit	Pdh	-	kW																																																																												
Item	symbol	value	unit																																																																												
Declared coefficient of performance / Warmer season, at indoor temperature 20°C and outdoor temperature Tj																																																																															
Tj=2°C	COPd	-	-																																																																												
Tj=7°C	COPd	-	-																																																																												
Tj=12°C	COPd	-	-																																																																												
Tj=bivalent temperature	COPd	-	-																																																																												
Tj=operating limit	COPd	-	-																																																																												
<table border="1"> <thead> <tr> <th>Item</th> <th>symbol</th> <th>value</th> <th>unit</th> </tr> </thead> <tbody> <tr> <td>Declared capacity for heating / Colder season, at indoor temperature 20°C and outdoor temperature Tj</td> <td></td> <td></td> <td></td> </tr> <tr> <td>Tj=-7°C</td> <td>Pdh</td> <td>-</td> <td>kW</td> </tr> <tr> <td>Tj=2°C</td> <td>Pdh</td> <td>-</td> <td>kW</td> </tr> <tr> <td>Tj=7°C</td> <td>Pdh</td> <td>-</td> <td>kW</td> </tr> <tr> <td>Tj=12°C</td> <td>Pdh</td> <td>-</td> <td>kW</td> </tr> <tr> <td>Tj=bivalent temperature</td> <td>Pdh</td> <td>-</td> <td>kW</td> </tr> <tr> <td>Tj=operating limit</td> <td>Pdh</td> <td>-</td> <td>kW</td> </tr> <tr> <td>Tj=-15°C</td> <td>Pdh</td> <td>-</td> <td>kW</td> </tr> </tbody> </table>				Item	symbol	value	unit	Declared capacity for heating / Colder season, at indoor temperature 20°C and outdoor temperature Tj				Tj=-7°C	Pdh	-	kW	Tj=2°C	Pdh	-	kW	Tj=7°C	Pdh	-	kW	Tj=12°C	Pdh	-	kW	Tj=bivalent temperature	Pdh	-	kW	Tj=operating limit	Pdh	-	kW	Tj=-15°C	Pdh	-	kW	<table border="1"> <thead> <tr> <th>Item</th> <th>symbol</th> <th>value</th> <th>unit</th> </tr> </thead> <tbody> <tr> <td>Declared coefficient of performance / Colder season, at indoor temperature 20°C and outdoor temperature Tj</td> <td></td> <td></td> <td></td> </tr> <tr> <td>Tj=-7°C</td> <td>COPd</td> <td>-</td> <td>-</td> </tr> <tr> <td>Tj=2°C</td> <td>COPd</td> <td>-</td> <td>-</td> </tr> <tr> <td>Tj=7°C</td> <td>COPd</td> <td>-</td> <td>-</td> </tr> <tr> <td>Tj=12°C</td> <td>COPd</td> <td>-</td> <td>-</td> </tr> <tr> <td>Tj=bivalent temperature</td> <td>COPd</td> <td>-</td> <td>-</td> </tr> <tr> <td>Tj=operating limit</td> <td>COPd</td> <td>-</td> <td>-</td> </tr> <tr> <td>Tj=-15°C</td> <td>COPd</td> <td>-</td> <td>-</td> </tr> </tbody> </table>				Item	symbol	value	unit	Declared coefficient of performance / Colder season, at indoor temperature 20°C and outdoor temperature Tj				Tj=-7°C	COPd	-	-	Tj=2°C	COPd	-	-	Tj=7°C	COPd	-	-	Tj=12°C	COPd	-	-	Tj=bivalent temperature	COPd	-	-	Tj=operating limit	COPd	-	-	Tj=-15°C	COPd	-	-
Item	symbol	value	unit																																																																												
Declared capacity for heating / Colder season, at indoor temperature 20°C and outdoor temperature Tj																																																																															
Tj=-7°C	Pdh	-	kW																																																																												
Tj=2°C	Pdh	-	kW																																																																												
Tj=7°C	Pdh	-	kW																																																																												
Tj=12°C	Pdh	-	kW																																																																												
Tj=bivalent temperature	Pdh	-	kW																																																																												
Tj=operating limit	Pdh	-	kW																																																																												
Tj=-15°C	Pdh	-	kW																																																																												
Item	symbol	value	unit																																																																												
Declared coefficient of performance / Colder season, at indoor temperature 20°C and outdoor temperature Tj																																																																															
Tj=-7°C	COPd	-	-																																																																												
Tj=2°C	COPd	-	-																																																																												
Tj=7°C	COPd	-	-																																																																												
Tj=12°C	COPd	-	-																																																																												
Tj=bivalent temperature	COPd	-	-																																																																												
Tj=operating limit	COPd	-	-																																																																												
Tj=-15°C	COPd	-	-																																																																												
<table border="1"> <thead> <tr> <th>Item</th> <th>symbol</th> <th>value</th> <th>unit</th> </tr> </thead> <tbody> <tr> <td>Bivalent temperature</td> <td></td> <td></td> <td></td> </tr> <tr> <td>heating / Average</td> <td>Tbiv</td> <td>-7</td> <td>°C</td> </tr> <tr> <td>heating / Warmer</td> <td>Tbiv</td> <td>-</td> <td>°C</td> </tr> <tr> <td>heating / Colder</td> <td>Tbiv</td> <td>-</td> <td>°C</td> </tr> </tbody> </table>				Item	symbol	value	unit	Bivalent temperature				heating / Average	Tbiv	-7	°C	heating / Warmer	Tbiv	-	°C	heating / Colder	Tbiv	-	°C	<table border="1"> <thead> <tr> <th>Item</th> <th>symbol</th> <th>value</th> <th>unit</th> </tr> </thead> <tbody> <tr> <td>Operating limit temperature</td> <td></td> <td></td> <td></td> </tr> <tr> <td>heating / Average</td> <td>Tol</td> <td>-20</td> <td>°C</td> </tr> <tr> <td>heating / Warmer</td> <td>Tol</td> <td>-</td> <td>°C</td> </tr> <tr> <td>heating / Colder</td> <td>Tol</td> <td>-</td> <td>°C</td> </tr> </tbody> </table>				Item	symbol	value	unit	Operating limit temperature				heating / Average	Tol	-20	°C	heating / Warmer	Tol	-	°C	heating / Colder	Tol	-	°C																																
Item	symbol	value	unit																																																																												
Bivalent temperature																																																																															
heating / Average	Tbiv	-7	°C																																																																												
heating / Warmer	Tbiv	-	°C																																																																												
heating / Colder	Tbiv	-	°C																																																																												
Item	symbol	value	unit																																																																												
Operating limit temperature																																																																															
heating / Average	Tol	-20	°C																																																																												
heating / Warmer	Tol	-	°C																																																																												
heating / Colder	Tol	-	°C																																																																												
<table border="1"> <thead> <tr> <th>Item</th> <th>symbol</th> <th>value</th> <th>unit</th> </tr> </thead> <tbody> <tr> <td>Cycling interval capacity</td> <td></td> <td></td> <td></td> </tr> <tr> <td>for cooling</td> <td>Pcycc</td> <td>-</td> <td>kW</td> </tr> <tr> <td>for heating</td> <td>Pcyh</td> <td>-</td> <td>kW</td> </tr> </tbody> </table>				Item	symbol	value	unit	Cycling interval capacity				for cooling	Pcycc	-	kW	for heating	Pcyh	-	kW	<table border="1"> <thead> <tr> <th>Item</th> <th>symbol</th> <th>value</th> <th>unit</th> </tr> </thead> <tbody> <tr> <td>Cycling interval efficiency</td> <td></td> <td></td> <td></td> </tr> <tr> <td>for cooling</td> <td>EERcyc</td> <td>-</td> <td>-</td> </tr> <tr> <td>for heating</td> <td>COPcyc</td> <td>-</td> <td>-</td> </tr> </tbody> </table>				Item	symbol	value	unit	Cycling interval efficiency				for cooling	EERcyc	-	-	for heating	COPcyc	-	-																																								
Item	symbol	value	unit																																																																												
Cycling interval capacity																																																																															
for cooling	Pcycc	-	kW																																																																												
for heating	Pcyh	-	kW																																																																												
Item	symbol	value	unit																																																																												
Cycling interval efficiency																																																																															
for cooling	EERcyc	-	-																																																																												
for heating	COPcyc	-	-																																																																												
<table border="1"> <thead> <tr> <th>Item</th> <th>symbol</th> <th>value</th> <th>unit</th> </tr> </thead> <tbody> <tr> <td>Degradation coefficient</td> <td></td> <td></td> <td></td> </tr> <tr> <td>cooling</td> <td>Cdc</td> <td>0.25</td> <td>-</td> </tr> </tbody> </table>				Item	symbol	value	unit	Degradation coefficient				cooling	Cdc	0.25	-	<table border="1"> <thead> <tr> <th>Item</th> <th>symbol</th> <th>value</th> <th>unit</th> </tr> </thead> <tbody> <tr> <td>Degradation coefficient</td> <td></td> <td></td> <td></td> </tr> <tr> <td>heating</td> <td>Cdh</td> <td>0.25</td> <td>-</td> </tr> </tbody> </table>				Item	symbol	value	unit	Degradation coefficient				heating	Cdh	0.25	-																																																
Item	symbol	value	unit																																																																												
Degradation coefficient																																																																															
cooling	Cdc	0.25	-																																																																												
Item	symbol	value	unit																																																																												
Degradation coefficient																																																																															
heating	Cdh	0.25	-																																																																												
<table border="1"> <thead> <tr> <th>Item</th> <th>symbol</th> <th>value</th> <th>unit</th> </tr> </thead> <tbody> <tr> <td>Electric power input in power modes other than 'active mode'</td> <td></td> <td></td> <td></td> </tr> <tr> <td>off mode</td> <td>Poff</td> <td>20</td> <td>W</td> </tr> <tr> <td>standby mode</td> <td>Psb</td> <td>20</td> <td>W</td> </tr> <tr> <td>thermostat-off mode</td> <td>Pto</td> <td>58</td> <td>W</td> </tr> <tr> <td>crankcase heater mode</td> <td>Pck</td> <td>25</td> <td>W</td> </tr> </tbody> </table>				Item	symbol	value	unit	Electric power input in power modes other than 'active mode'				off mode	Poff	20	W	standby mode	Psb	20	W	thermostat-off mode	Pto	58	W	crankcase heater mode	Pck	25	W	<table border="1"> <thead> <tr> <th>Item</th> <th>symbol</th> <th>value</th> <th>unit</th> </tr> </thead> <tbody> <tr> <td>Annual electricity consumption</td> <td></td> <td></td> <td></td> </tr> <tr> <td>cooling</td> <td>Qce</td> <td>682</td> <td>kWh/a</td> </tr> <tr> <td>heating / Average</td> <td>Qhe</td> <td>3428</td> <td>kWh/a</td> </tr> <tr> <td>heating / Warmer</td> <td>Qhe</td> <td>-</td> <td>kWh/a</td> </tr> <tr> <td>heating / colder</td> <td>Qhe</td> <td>-</td> <td>kWh/a</td> </tr> </tbody> </table>				Item	symbol	value	unit	Annual electricity consumption				cooling	Qce	682	kWh/a	heating / Average	Qhe	3428	kWh/a	heating / Warmer	Qhe	-	kWh/a	heating / colder	Qhe	-	kWh/a																								
Item	symbol	value	unit																																																																												
Electric power input in power modes other than 'active mode'																																																																															
off mode	Poff	20	W																																																																												
standby mode	Psb	20	W																																																																												
thermostat-off mode	Pto	58	W																																																																												
crankcase heater mode	Pck	25	W																																																																												
Item	symbol	value	unit																																																																												
Annual electricity consumption																																																																															
cooling	Qce	682	kWh/a																																																																												
heating / Average	Qhe	3428	kWh/a																																																																												
heating / Warmer	Qhe	-	kWh/a																																																																												
heating / colder	Qhe	-	kWh/a																																																																												
Capacity control(indicate one of three options) fixed No staged No variable Yes				<table border="1"> <thead> <tr> <th>Item</th> <th>symbol</th> <th>value</th> <th>unit</th> </tr> </thead> <tbody> <tr> <td>Other items</td> <td></td> <td></td> <td></td> </tr> <tr> <td>Sound power level(indoor)</td> <td>Lwa</td> <td>60</td> <td>dB(A)</td> </tr> <tr> <td>Sound power level(outdoor)</td> <td>Lwa</td> <td>70</td> <td>dB(A)</td> </tr> <tr> <td>Global warming potential</td> <td>GWP</td> <td>1975</td> <td>kgCO₂eq.</td> </tr> <tr> <td>Rated air flow(indoor)</td> <td>-</td> <td>810</td> <td>m³/h</td> </tr> <tr> <td>Rated air flow(outdoor)</td> <td>-</td> <td>4500</td> <td>m³/h</td> </tr> </tbody> </table>				Item	symbol	value	unit	Other items				Sound power level(indoor)	Lwa	60	dB(A)	Sound power level(outdoor)	Lwa	70	dB(A)	Global warming potential	GWP	1975	kgCO ₂ eq.	Rated air flow(indoor)	-	810	m ³ /h	Rated air flow(outdoor)	-	4500	m ³ /h																																												
Item	symbol	value	unit																																																																												
Other items																																																																															
Sound power level(indoor)	Lwa	60	dB(A)																																																																												
Sound power level(outdoor)	Lwa	70	dB(A)																																																																												
Global warming potential	GWP	1975	kgCO ₂ eq.																																																																												
Rated air flow(indoor)	-	810	m ³ /h																																																																												
Rated air flow(outdoor)	-	4500	m ³ /h																																																																												
Contact details for obtaining more information	Name and address of the manufacturer or of its authorised representative. Mitsubishi Heavy Industries Air-Conditioning Europe, Ltd. 7 Roundwood Avenue, Stockley Park, Uxbridge, Middlesex, UB11 1AX, United Kingdom																																																																														

PJA003Z401 

(3) Ceiling suspended type (FDEN)

Model FDEN100VNVF1

Information to identify the model(s) to which the information relates to:				If function includes heating: Indicate the heating season the information relates to. Indicated values should relate to one heating season at a time. Include at least the heating season 'Average'.			
Indoor unit model name		FDEN100VF1		Average(mandatory)		Yes	
Outdoor unit model name		FDC100VN		Warmer(if designated)		No	
Function(indicate if present)				Colder(if designated)			
cooling		Yes					
heating		Yes					
Item	symbol	value	unit	Item	symbol	value	class
Design load cooling	Pdesignc	10.0	kW	Seasonal efficiency and energy efficiency class cooling	SEER	5.13	A
heating / Average	Pdesignh	9.2	kW	heating / Average	SCOP/A	3.80	A
heating / Warmer	Pdesignh	-	kW	heating / Warmer	SCOP/W	-	-
heating / Colder	Pdesignh	-	kW	heating / Colder	SCOP/C	-	-
Declared capacity at outdoor temperature Tdesignh				Back up heating capacity at outdoor temperature Tdesignh			
heating / Average (-10°C)		Pdh 7.80 kW		heating / Average (-10°C)		elbu 1.40 kW	
heating / Warmer (2°C)		Pdh - kW		heating / Warmer (2°C)		elbu - kW	
heating / Colder (-22°C)		Pdh - kW		heating / Colder (-22°C)		elbu - kW	
Declared capacity for cooling, at indoor temperature 27(19) °C and outdoor temperature Tj				Declared energy efficiency ratio, at indoor temperature 27(19) °C and outdoor temperature Tj			
Tj=35°C		Pdc 10.00 kW		Tj=35°C		EERd 3.51 -	
Tj=30°C		Pdc 7.37 kW		Tj=30°C		EERd 4.88 -	
Tj=25°C		Pdc 4.74 kW		Tj=25°C		EERd 7.35 -	
Tj=20°C		Pdc 4.50 kW		Tj=20°C		EERd 9.78 -	
Declared capacity for heating / Average season, at indoor temperature 20°C and outdoor temperature Tj				Declared coefficient of performance / Average season, at indoor temperature 20°C and outdoor temperature Tj			
Tj=-7°C		Pdh 8.20 kW		Tj=-7°C		COPd 2.56 -	
Tj=2°C		Pdh 5.00 kW		Tj=2°C		COPd 3.65 -	
Tj=7°C		Pdh 3.22 kW		Tj=7°C		COPd 5.24 -	
Tj=12°C		Pdh 3.76 kW		Tj=12°C		COPd 5.88 -	
Tj=bivalent temperature		Pdh 8.20 kW		Tj=bivalent temperature		COPd 2.56 -	
Tj=operating limit		Pdh 6.45 kW		Tj=operating limit		COPd 2.35 -	
Declared capacity for heating / Warmer season, at indoor temperature 20°C and outdoor temperature Tj				Declared coefficient of performance / Warmer season, at indoor temperature 20°C and outdoor temperature Tj			
Tj=2°C		Pdh - kW		Tj=2°C		COPd - -	
Tj=7°C		Pdh - kW		Tj=7°C		COPd - -	
Tj=12°C		Pdh - kW		Tj=12°C		COPd - -	
Tj=bivalent temperature		Pdh - kW		Tj=bivalent temperature		COPd - -	
Tj=operating limit		Pdh - kW		Tj=operating limit		COPd - -	
Declared capacity for heating / Colder season, at indoor temperature 20°C and outdoor temperature Tj				Declared coefficient of performance / Colder season, at indoor temperature 20°C and outdoor temperature Tj			
Tj=-7°C		Pdh - kW		Tj=-7°C		COPd - -	
Tj=2°C		Pdh - kW		Tj=2°C		COPd - -	
Tj=7°C		Pdh - kW		Tj=7°C		COPd - -	
Tj=12°C		Pdh - kW		Tj=12°C		COPd - -	
Tj=bivalent temperature		Pdh - kW		Tj=bivalent temperature		COPd - -	
Tj=operating limit		Pdh - kW		Tj=operating limit		COPd - -	
Tj=-15°C		Pdh - kW		Tj=-15°C		COPd - -	
Bivalent temperature				Operating limit temperature			
heating / Average		Tbiv -7 °C		heating / Average		Tol -20 °C	
heating / Warmer		Tbiv - °C		heating / Warmer		Tol - °C	
heating / Colder		Tbiv - °C		heating / Colder		Tol - °C	
Cycling interval capacity				Cycling interval efficiency			
for cooling		Pcycc - kW		for cooling		EERcyc - -	
for heating		Pcyh - kW		for heating		COPcyc - -	
Degradation coefficient cooling				Degradation coefficient heating			
		Cdc 0.25 -				Cdh 0.25 -	
Electric power input in power modes other than 'active mode'				Annual electricity consumption			
off mode		Poff 20 W		cooling		Qce 683 kWh/a	
standby mode		Psb 20 W		heating / Average		Qhe 3387 kWh/a	
thermostat-off mode		Pto 98 W		heating / Warmer		Qhe - kWh/a	
crankcase heater mode		Pck 25 W		heating / colder		Qhe - kWh/a	
Capacity control(indicate one of three options)				Other items			
fixed		No		Sound power level(indoor)		Lwa 64 dB(A)	
staged		No		Sound power level(outdoor)		Lwa 70 dB(A)	
variable		Yes		Global warming potential		GWP 1975 kgCO2eq.	
				Rated air flow(indoor)		- 1680 m3/h	
				Rated air flow(outdoor)		- 4500 m3/h	
Contact details for obtaining more information		Name and address of the manufacturer or of its authorised representative. Mitsubishi Heavy Industries Air-Conditioning Europe, Ltd. 7 Roundwood Avenue, Stockley Park, Uxbridge, Middlesex, UB11 1AX, United Kingdom					

PFA003Z973A

Model FDEN100VSVF1

Information to identify the model(s) to which the information relates to: Indoor unit model name FDEN100VF1 Outdoor unit model name FDC100VS				If function includes heating: Indicate the heating season the information relates to. Indicated values should relate to one heating season at a time. Include at least the heating season 'Average'.			
Function(indicate if present)				Average(mandatory)		Yes	
cooling				Warmer(if designated)		No	
heating				Colder(if designated)		No	
Item				Item			
symbol value unit				symbol value class			
Design load				Seasonal efficiency and energy efficiency class			
cooling Pdesignc 10.0 kW				cooling SEER 5.10 A			
heating / Average Pdesignh 9.2 kW				heating / Average SCOP/A 3.80 A			
heating / Warmer Pdesignh - kW				heating / Warmer SCOP/W - -			
heating / Colder Pdesignh - kW				heating / Colder SCOP/C - -			
Declared capacity at outdoor temperature Tdesignh				Back up heating capacity at outdoor temperature Tdesignh			
heating / Average (-10°C) Pdh 7.80 kW				heating / Average (-10°C) elbu 1.40 kW			
heating / Warmer (2°C) Pdh - kW				heating / Warmer (2°C) elbu - kW			
heating / Colder (-22°C) Pdh - kW				heating / Colder (-22°C) elbu - kW			
Declared capacity for cooling, at indoor temperature 27(19)°C and outdoor temperature Tj				Declared energy efficiency ratio, at indoor temperature 27(19)°C and outdoor temperature Tj			
Tj=35°C Pdc 10.00 kW				Tj=35°C EERd 3.51 -			
Tj=30°C Pdc 7.37 kW				Tj=30°C EERd 4.88 -			
Tj=25°C Pdc 4.74 kW				Tj=25°C EERd 7.35 -			
Tj=20°C Pdc 4.50 kW				Tj=20°C EERd 9.78 -			
Declared capacity for heating / Average season, at indoor temperature 20°C and outdoor temperature Tj				Declared coefficient of performance / Average season, at indoor temperature 20°C and outdoor temperature Tj			
Tj=-7°C Pdh 8.20 kW				Tj=-7°C COPd 2.56 -			
Tj=2°C Pdh 5.00 kW				Tj=2°C COPd 3.65 -			
Tj=7°C Pdh 3.22 kW				Tj=7°C COPd 5.24 -			
Tj=12°C Pdh 3.76 kW				Tj=12°C COPd 5.88 -			
Tj=bivalent temperature Pdh 8.20 kW				Tj=bivalent temperature COPd 2.56 -			
Tj=operating limit Pdh 6.45 kW				Tj=operating limit COPd 2.35 -			
Declared capacity for heating / Warmer season, at indoor temperature 20°C and outdoor temperature Tj				Declared coefficient of performance / Warmer season, at indoor temperature 20°C and outdoor temperature Tj			
Tj=2°C Pdh - kW				Tj=2°C COPd - -			
Tj=7°C Pdh - kW				Tj=7°C COPd - -			
Tj=12°C Pdh - kW				Tj=12°C COPd - -			
Tj=bivalent temperature Pdh - kW				Tj=bivalent temperature COPd - -			
Tj=operating limit Pdh - kW				Tj=operating limit COPd - -			
Declared capacity for heating / Colder season, at indoor temperature 20°C and outdoor temperature Tj				Declared coefficient of performance / Colder season, at indoor temperature 20°C and outdoor temperature Tj			
Tj=-7°C Pdh - kW				Tj=-7°C COPd - -			
Tj=2°C Pdh - kW				Tj=2°C COPd - -			
Tj=7°C Pdh - kW				Tj=7°C COPd - -			
Tj=12°C Pdh - kW				Tj=12°C COPd - -			
Tj=bivalent temperature Pdh - kW				Tj=bivalent temperature COPd - -			
Tj=operating limit Pdh - kW				Tj=operating limit COPd - -			
Tj=-15°C Pdh - kW				Tj=-15°C COPd - -			
Bivalent temperature				Operating limit temperature			
heating / Average Tbiv -7 °C				heating / Average Tol -20 °C			
heating / Warmer Tbiv - °C				heating / Warmer Tol - °C			
heating / Colder Tbiv - °C				heating / Colder Tol - °C			
Cycling interval capacity				Cycling interval efficiency			
for cooling Pcycc - kW				for cooling EERcyc - -			
for heating Pcych - kW				for heating COPcyc - -			
Degradation coefficient				Degradation coefficient			
cooling Cdc 0.25 -				heating Cdh 0.25 -			
Electric power input in power modes other than 'active mode'				Annual electricity consumption			
off mode Poff 20 W				cooling Qce 687 kWh/a			
standby mode Psb 20 W				heating / Average Qhe 3390 kWh/a			
thermostat-off mode Pto 118 W				heating / Warmer Qhe - kWh/a			
crankcase heater mode Pck 25 W				heating / colder Qhe - kWh/a			
Capacity control(indicate one of three options)				Other items			
fixed No				Sound power level(indoor) Lwa 64 dB(A)			
staged No				Sound power level(outdoor) Lwa 70 dB(A)			
variable Yes				Global warming potential GWP 1975 kgCO2eq.			
				Rated air flow(indoor) - 1680 m3/h			
				Rated air flow(outdoor) - 4500 m3/h			
Contact details for obtaining more information		Name and address of the manufacturer or of its authorised representative. Mitsubishi Heavy Industries Air-Conditioning Europe, Ltd. 7 Roundwood Avenue, Stockley Park, Uxbridge, Middlesex, UB11 1AX, United Kingdom					

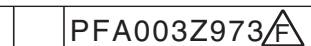

Model FDEN100VNPVF

Information to identify the model(s) to which the information relates to:				If function includes heating: Indicate the heating season the information relates to. Indicated values should relate to one heating season at a time. Include at least the heating season 'Average'.			
Indoor unit model name		FDEN50VF x 2		Average(mandatory)		Yes	
Outdoor unit model name		FDC100VN		Warmer(if designated)		No	
Function(indicate if present)				Colder(if designated)			
cooling		Yes					
heating		Yes					
Item	symbol	value	unit	Item	symbol	value	class
Design load				Seasonal efficiency and energy efficiency class			
cooling	Pdesignc	10.0	kW	cooling	SEER	4.80	B
heating / Average	Pdesignh	9.2	kW	heating / Average	SCOP/A	3.80	A
heating / Warmer	Pdesignh	-	kW	heating / Warmer	SCOP/W	-	-
heating / Colder	Pdesignh	-	kW	heating / Colder	SCOP/C	-	-
Declared capacity at outdoor temperature Tdesignh				Back up heating capacity at outdoor temperature Tdesignh			
heating / Average (-10°C)	Pdh	8.11	kW	heating / Average (-10°C)	elbu	1.09	kW
heating / Warmer (2°C)	Pdh	-	kW	heating / Warmer (2°C)	elbu	-	kW
heating / Colder (-22°C)	Pdh	-	kW	heating / Colder (-22°C)	elbu	-	kW
Declared capacity for cooling, at indoor temperature 27(19)°C and outdoor temperature Tj				Declared energy efficiency ratio, at indoor temperature 27(19)°C and outdoor temperature Tj			
Tj=35°C	Pdc	10.00	kW	Tj=35°C	EERd	3.21	-
Tj=30°C	Pdc	7.37	kW	Tj=30°C	EERd	4.61	-
Tj=25°C	Pdc	4.74	kW	Tj=25°C	EERd	6.58	-
Tj=20°C	Pdc	4.19	kW	Tj=20°C	EERd	9.11	-
Declared capacity for heating / Average season, at indoor temperature 20°C and outdoor temperature Tj				Declared coefficient of performance / Average season, at indoor temperature 20°C and outdoor temperature Tj			
Tj=-7°C	Pdh	8.65	kW	Tj=-7°C	COPd	2.51	-
Tj=2°C	Pdh	5.25	kW	Tj=2°C	COPd	3.62	-
Tj=7°C	Pdh	3.40	kW	Tj=7°C	COPd	5.35	-
Tj=12°C	Pdh	3.70	kW	Tj=12°C	COPd	5.97	-
Tj=bivalent temperature	Pdh	8.65	kW	Tj=bivalent temperature	COPd	2.51	-
Tj=operating limit	Pdh	6.30	kW	Tj=operating limit	COPd	2.21	-
Declared capacity for heating / Warmer season, at indoor temperature 20°C and outdoor temperature Tj				Declared coefficient of performance / Warmer season, at indoor temperature 20°C and outdoor temperature Tj			
Tj=2°C	Pdh	-	kW	Tj=2°C	COPd	-	-
Tj=7°C	Pdh	-	kW	Tj=7°C	COPd	-	-
Tj=12°C	Pdh	-	kW	Tj=12°C	COPd	-	-
Tj=bivalent temperature	Pdh	-	kW	Tj=bivalent temperature	COPd	-	-
Tj=operating limit	Pdh	-	kW	Tj=operating limit	COPd	-	-
Declared capacity for heating / Colder season, at indoor temperature 20°C and outdoor temperature Tj				Declared coefficient of performance / Colder season, at indoor temperature 20°C and outdoor temperature Tj			
Tj=-7°C	Pdh	-	kW	Tj=-7°C	COPd	-	-
Tj=2°C	Pdh	-	kW	Tj=2°C	COPd	-	-
Tj=7°C	Pdh	-	kW	Tj=7°C	COPd	-	-
Tj=12°C	Pdh	-	kW	Tj=12°C	COPd	-	-
Tj=bivalent temperature	Pdh	-	kW	Tj=bivalent temperature	COPd	-	-
Tj=operating limit	Pdh	-	kW	Tj=operating limit	COPd	-	-
Tj=-15°C	Pdh	-	kW	Tj=-15°C	COPd	-	-
Bivalent temperature				Operating limit temperature			
heating / Average	Tbiv	-7	°C	heating / Average	Tol	-20	°C
heating / Warmer	Tbiv	-	°C	heating / Warmer	Tol	-	°C
heating / Colder	Tbiv	-	°C	heating / Colder	Tol	-	°C
Cycling interval capacity				Cycling interval efficiency			
for cooling	Pcycc	-	kW	for cooling	EERcyc	-	-
for heating	Pcyh	-	kW	for heating	COPcyc	-	-
Degradation coefficient				Degradation coefficient			
cooling	Cdc	0.25	-	heating	Cdh	0.25	-
Electric power input in power modes other than 'active mode'				Annual electricity consumption			
off mode	Poff	23	W	cooling	Qce	730	kWh/a
standby mode	Psb	23	W	heating / Average	Qhe	3388	kWh/a
thermostat-off mode	Pto	66	W	heating / Warmer	Qhe	-	kWh/a
crankcase heater mode	Pck	25	W	heating / colder	Qhe	-	kWh/a
Capacity control(indicate one of three options)				Other items			
fixed		No		Sound power level(indoor)	Lwa	60	dB(A)
staged		No		Sound power level(outdoor)	Lwa	70	dB(A)
variable		Yes		Global warming potential	GWP	1975	kgCO2eq.
				Rated air flow(indoor)	-	660	m3/h
				Rated air flow(outdoor)	-	4500	m3/h
Contact details for obtaining more information	Name and address of the manufacturer or of its authorised representative. Mitsubishi Heavy Industries Air-Conditioning Europe, Ltd. 7 Roundwood Avenue, Stockley Park, Uxbridge, Middlesex, UB11 1AX, United Kingdom						

PFA003Z973/A

Model FDEN100VSPVF

Information to identify the model(s) to which the information relates to:				If function includes heating: Indicate the heating season the information relates to. Indicated values should relate to one heating season at a time. Include at least the heating season 'Average'.			
Indoor unit model name		FDEN50VF x 2		Average(mandatory)		Yes	
Outdoor unit model name		FDC100VS		Warmer(if designated)		No	
Function(indicate if present)				Colder(if designated)			
cooling		Yes					
heating		Yes					
Item	symbol	value	unit	Item	symbol	value	class
Design load				Seasonal efficiency and energy efficiency class			
cooling	Pdesignc	10.0	kW	cooling	SEER	4.77	B
heating / Average	Pdesignh	9.2	kW	heating / Average	SCOP/A	3.80	A
heating / Warmer	Pdesignh	-	kW	heating / Warmer	SCOP/W	-	-
heating / Colder	Pdesignh	-	kW	heating / Colder	SCOP/C	-	-
Declared capacity at outdoor temperature Tdesignh				Back up heating capacity at outdoor temperature Tdesignh			
heating / Average (-10°C)	Pdh	8.11	kW	heating / Average (-10°C)	elbu	1.09	kW
heating / Warmer (2°C)	Pdh	-	kW	heating / Warmer (2°C)	elbu	-	kW
heating / Colder (-22°C)	Pdh	-	kW	heating / Colder (-22°C)	elbu	-	kW
Declared capacity for cooling, at indoor temperature 27(19)°C and outdoor temperature Tj				Declared energy efficiency ratio, at indoor temperature 27(19)°C and outdoor temperature Tj			
Tj=35°C	Pdc	10.00	kW	Tj=35°C	EERd	3.21	-
Tj=30°C	Pdc	7.37	kW	Tj=30°C	EERd	4.61	-
Tj=25°C	Pdc	4.74	kW	Tj=25°C	EERd	6.58	-
Tj=20°C	Pdc	4.19	kW	Tj=20°C	EERd	9.11	-
Declared capacity for heating / Average season, at indoor temperature 20°C and outdoor temperature Tj				Declared coefficient of performance / Average season, at indoor temperature 20°C and outdoor temperature Tj			
Tj=-7°C	Pdh	8.65	kW	Tj=-7°C	COPd	2.51	-
Tj=2°C	Pdh	5.25	kW	Tj=2°C	COPd	3.62	-
Tj=7°C	Pdh	3.40	kW	Tj=7°C	COPd	5.35	-
Tj=12°C	Pdh	3.70	kW	Tj=12°C	COPd	5.97	-
Tj=bivalent temperature	Pdh	8.65	kW	Tj=bivalent temperature	COPd	2.51	-
Tj=operating limit	Pdh	6.30	kW	Tj=operating limit	COPd	2.21	-
Declared capacity for heating / Warmer season, at indoor temperature 20°C and outdoor temperature Tj				Declared coefficient of performance / Warmer season, at indoor temperature 20°C and outdoor temperature Tj			
Tj=2°C	Pdh	-	kW	Tj=2°C	COPd	-	-
Tj=7°C	Pdh	-	kW	Tj=7°C	COPd	-	-
Tj=12°C	Pdh	-	kW	Tj=12°C	COPd	-	-
Tj=bivalent temperature	Pdh	-	kW	Tj=bivalent temperature	COPd	-	-
Tj=operating limit	Pdh	-	kW	Tj=operating limit	COPd	-	-
Declared capacity for heating / Colder season, at indoor temperature 20°C and outdoor temperature Tj				Declared coefficient of performance / Colder season, at indoor temperature 20°C and outdoor temperature Tj			
Tj=-7°C	Pdh	-	kW	Tj=-7°C	COPd	-	-
Tj=2°C	Pdh	-	kW	Tj=2°C	COPd	-	-
Tj=7°C	Pdh	-	kW	Tj=7°C	COPd	-	-
Tj=12°C	Pdh	-	kW	Tj=12°C	COPd	-	-
Tj=bivalent temperature	Pdh	-	kW	Tj=bivalent temperature	COPd	-	-
Tj=operating limit	Pdh	-	kW	Tj=operating limit	COPd	-	-
Tj=-15°C	Pdh	-	kW	Tj=-15°C	COPd	-	-
Bivalent temperature				Operating limit temperature			
heating / Average	Tbiv	-7	°C	heating / Average	Tol	-20	°C
heating / Warmer	Tbiv	-	°C	heating / Warmer	Tol	-	°C
heating / Colder	Tbiv	-	°C	heating / Colder	Tol	-	°C
Cycling interval capacity				Cycling interval efficiency			
for cooling	Pcyc	-	kW	for cooling	EERcyc	-	-
for heating	Pcyc	-	kW	for heating	COPcyc	-	-
Degradation coefficient cooling				Degradation coefficient heating			
	Cdc	0.25	-		Cdh	0.25	-
Electric power input in power modes other than 'active mode'				Annual electricity consumption			
off mode	Poff	23	W	cooling	Qce	734	kWh/a
standby mode	Psb	23	W	heating / Average	Qhe	3392	kWh/a
thermostat-off mode	Pto	86	W	heating / Warmer	Qhe	-	kWh/a
crankcase heater mode	Pck	25	W	heating / colder	Qhe	-	kWh/a
Capacity control(indicate one of three options)				Other items			
fixed		No		Sound power level(indoor)	Lwa	60	dB(A)
staged		No		Sound power level(outdoor)	Lwa	70	dB(A)
variable		Yes		Global warming potential	GWP	1975	kgCO2eq.
				Rated air flow(indoor)	-	660	m3/h
				Rated air flow(outdoor)	-	4500	m3/h
Contact details for obtaining more information	Name and address of the manufacturer or of its authorised representative. Mitsubishi Heavy Industries Air-Conditioning Europe, Ltd. 7 Roundwood Avenue, Stockley Park, Uxbridge, Middlesex, UB11 1AX, United Kingdom						

PFA003Z973 

(4) Duct connected-High static pressure type (FDU)

Model FDU100VNVF1

Information to identify the model(s) to which the information relates to: Indoor unit model name FDU100VF1 Outdoor unit model name FDC100VN				If function includes heating: Indicate the heating season the information relates to. Indicated values should relate to one heating season at a time. Include at least the heating season 'Average'.																																											
Function(indicate if present) cooling Yes heating Yes				Average(mandatory) Yes Warmer(if designated) No Colder(if designated) No																																											
<table border="1"> <thead> <tr> <th>Item</th> <th>symbol</th> <th>value</th> <th>unit</th> </tr> </thead> <tbody> <tr> <td>Design load cooling</td> <td>Pdesignc</td> <td>10.0</td> <td>kW</td> </tr> <tr> <td>heating / Average</td> <td>Pdesignh</td> <td>9.3</td> <td>kW</td> </tr> <tr> <td>heating / Warmer</td> <td>Pdesignh</td> <td>-</td> <td>kW</td> </tr> <tr> <td>heating / Colder</td> <td>Pdesignh</td> <td>-</td> <td>kW</td> </tr> </tbody> </table>				Item	symbol	value	unit	Design load cooling	Pdesignc	10.0	kW	heating / Average	Pdesignh	9.3	kW	heating / Warmer	Pdesignh	-	kW	heating / Colder	Pdesignh	-	kW	<table border="1"> <thead> <tr> <th>Item</th> <th>symbol</th> <th>value</th> <th>class</th> </tr> </thead> <tbody> <tr> <td>Seasonal efficiency and energy efficiency class cooling</td> <td>SEER</td> <td>5.06</td> <td>B</td> </tr> <tr> <td>heating / Average</td> <td>SCOP/A</td> <td>3.94</td> <td>A</td> </tr> <tr> <td>heating / Warmer</td> <td>SCOP/W</td> <td>-</td> <td>-</td> </tr> <tr> <td>heating / Colder</td> <td>SCOP/C</td> <td>-</td> <td>-</td> </tr> </tbody> </table>				Item	symbol	value	class	Seasonal efficiency and energy efficiency class cooling	SEER	5.06	B	heating / Average	SCOP/A	3.94	A	heating / Warmer	SCOP/W	-	-	heating / Colder	SCOP/C	-	-
Item	symbol	value	unit																																												
Design load cooling	Pdesignc	10.0	kW																																												
heating / Average	Pdesignh	9.3	kW																																												
heating / Warmer	Pdesignh	-	kW																																												
heating / Colder	Pdesignh	-	kW																																												
Item	symbol	value	class																																												
Seasonal efficiency and energy efficiency class cooling	SEER	5.06	B																																												
heating / Average	SCOP/A	3.94	A																																												
heating / Warmer	SCOP/W	-	-																																												
heating / Colder	SCOP/C	-	-																																												
Declared capacity at outdoor temperature Tdesignh heating / Average (-10°C) Pdh 7.86 kW heating / Warmer (2°C) Pdh - kW heating / Colder (-22°C) Pdh - kW				Back up heating capacity at outdoor temperature Tdesignh heating / Average (-10°C) elbu 1.44 kW heating / Warmer (2°C) elbu - kW heating / Colder (-22°C) elbu - kW																																											
Declared capacity for cooling, at indoor temperature 27(19)°C and outdoor temperature Tj Tj=35°C Pdc 10.00 kW Tj=30°C Pdc 7.37 kW Tj=25°C Pdc 4.74 kW Tj=20°C Pdc 4.58 kW				Declared energy efficiency ratio, at indoor temperature 27(19)°C and outdoor temperature Tj Tj=35°C EERd 3.57 - Tj=30°C EERd 4.40 - Tj=25°C EERd 7.07 - Tj=20°C EERd 10.11 -																																											
Declared capacity for heating / Average season, at indoor temperature 20°C and outdoor temperature Tj Tj=-7°C Pdh 8.23 kW Tj=2°C Pdh 5.00 kW Tj=7°C Pdh 3.22 kW Tj=12°C Pdh 3.70 kW Tj=bivalent temperature Pdh 8.23 kW Tj=operating limit Pdh 6.64 kW				Declared coefficient of performance / Average season, at indoor temperature 20°C and outdoor temperature Tj Tj=-7°C COPd 2.68 - Tj=2°C COPd 3.70 - Tj=7°C COPd 5.45 - Tj=12°C COPd 6.64 - Tj=bivalent temperature COPd 2.68 - Tj=operating limit COPd 2.17 -																																											
Declared capacity for heating / Warmer season, at indoor temperature 20°C and outdoor temperature Tj Tj=2°C Pdh - kW Tj=7°C Pdh - kW Tj=12°C Pdh - kW Tj=bivalent temperature Pdh - kW Tj=operating limit Pdh - kW				Declared coefficient of performance / Warmer season, at indoor temperature 20°C and outdoor temperature Tj Tj=2°C COPd - - Tj=7°C COPd - - Tj=12°C COPd - - Tj=bivalent temperature COPd - - Tj=operating limit COPd - -																																											
Declared capacity for heating / Colder season, at indoor temperature 20°C and outdoor temperature Tj Tj=-7°C Pdh - kW Tj=2°C Pdh - kW Tj=7°C Pdh - kW Tj=12°C Pdh - kW Tj=bivalent temperature Pdh - kW Tj=operating limit Pdh - kW Tj=-15°C Pdh - kW				Declared coefficient of performance / Colder season, at indoor temperature 20°C and outdoor temperature Tj Tj=-7°C COPd - - Tj=2°C COPd - - Tj=7°C COPd - - Tj=12°C COPd - - Tj=bivalent temperature COPd - - Tj=operating limit COPd - - Tj=-15°C COPd - -																																											
Bivalent temperature heating / Average Tbiv -7 °C heating / Warmer Tbiv - °C heating / Colder Tbiv - °C				Operating limit temperature heating / Average Tol -20 °C heating / Warmer Tol - °C heating / Colder Tol - °C																																											
Cycling interval capacity for cooling Pcycc - kW for heating Pcych - kW				Cycling interval efficiency for cooling EERcyc - - for heating COPcyc - -																																											
Degradation coefficient cooling Cdc 0.25 -				Degradation coefficient heating Cdh 0.25 -																																											
Electric power input in power modes other than 'active mode' off mode Poff 20 W standby mode Psb 20 W thermostat-off mode Pto 45 W crankcase heater mode Pck 25 W				Annual electricity consumption cooling Qce 692 kWh/a heating / Average Qhe 3303 kWh/a heating / Warmer Qhe - kWh/a heating / colder Qhe - kWh/a																																											
Capacity control(indicate one of three options) fixed No staged No variable Yes				Other items Sound power level(indoor) Lwa 65 dB(A) Sound power level(outdoor) Lwa 70 dB(A) Global warming potential GWP 1975 kgCO2eq. Rated air flow(indoor) - 2160 m3/h Rated air flow(outdoor) - 4500 m3/h																																											
Contact details for obtaining more information	Name and address of the manufacturer or of its authorised representative. Mitsubishi Heavy Industries Air-Conditioning Europe, Ltd. 7 Roundwood Avenue, Stockley Park, Uxbridge, Middlesex, UB11 1AX, United Kingdom																																														

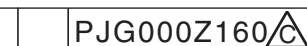

Model FDU100VNVF2

Information to identify the model(s) to which the information relates to:		If function includes heating: Indicate the heating season the information relates to. Indicated values should relate to one heating season at a time. Include at least the heating season 'Average'.	
Indoor unit model name	FDU100VF2		
Outdoor unit model name	FDC100VN		
Function(indicate if present)		Average(mandatory)	
cooling	Yes	Warmer(if designated)	No
heating	Yes	Colder(if designated)	No
Item	symbol	value	unit
Design load			
cooling	Pdesignc	10.0	kW
heating / Average	Pdesignh	9.3	kW
heating / Warmer	Pdesignh	-	kW
heating / Colder	Pdesignh	-	kW
Declared capacity at outdoor temperature Tdesignh		Back up heating capacity at outdoor temperature Tdesignh	
heating / Average (-10°C)	Pdh	7.86	kW
heating / Warmer (2°C)	Pdh	-	kW
heating / Colder (-22°C)	Pdh	-	kW
Declared capacity for cooling, at indoor temperature 27(19)°C and outdoor temperature Tj		Declared energy efficiency ratio, at indoor temperature 27(19)°C and outdoor temperature Tj	
Tj=35°C	Pdc	10.00	kW
Tj=30°C	Pdc	7.37	kW
Tj=25°C	Pdc	4.74	kW
Tj=20°C	Pdc	4.58	kW
Declared capacity for heating / Average season, at indoor temperature 20°C and outdoor temperature Tj		Declared coefficient of performance / Average season, at indoor temperature 20°C and outdoor temperature Tj	
Tj=-7°C	Pdh	8.23	kW
Tj=2°C	Pdh	5.00	kW
Tj=7°C	Pdh	3.22	kW
Tj=12°C	Pdh	3.70	kW
Tj=bivalent temperature	Pdh	8.23	kW
Tj=operating limit	Pdh	6.64	kW
Declared capacity for heating / Warmer season, at indoor temperature 20°C and outdoor temperature Tj		Declared coefficient of performance / Warmer season, at indoor temperature 20°C and outdoor temperature Tj	
Tj=2°C	Pdh	-	kW
Tj=7°C	Pdh	-	kW
Tj=12°C	Pdh	-	kW
Tj=bivalent temperature	Pdh	-	kW
Tj=operating limit	Pdh	-	kW
Declared capacity for heating / Colder season, at indoor temperature 20°C and outdoor temperature Tj		Declared coefficient of performance / Colder season, at indoor temperature 20°C and outdoor temperature Tj	
Tj=-7°C	Pdh	-	kW
Tj=2°C	Pdh	-	kW
Tj=7°C	Pdh	-	kW
Tj=12°C	Pdh	-	kW
Tj=bivalent temperature	Pdh	-	kW
Tj=operating limit	Pdh	-	kW
Tj=-15°C	Pdh	-	kW
Bivalent temperature		Operating limit temperature	
heating / Average	Tbiv	-7	°C
heating / Warmer	Tbiv	-	°C
heating / Colder	Tbiv	-	°C
Cycling interval capacity		Cycling interval efficiency	
for cooling	Pcyc	-	kW
for heating	Pcyc	-	kW
Degradation coefficient		Degradation coefficient	
cooling	Cdc	0.25	-
Electric power input in power modes other than 'active mode'		Annual electricity consumption	
off mode	Poff	20	W
standby mode	Psb	20	W
thermostat-off mode	Pto	45	W
crankcase heater mode	Pck	25	W
Capacity control(indicate one of three options)		Other items	
fixed		Sound power level(indoor)	Lwa 65 dB(A)
staged	No	Sound power level(outdoor)	Lwa 70 dB(A)
variable	Yes	Global warming potential	GWP 1975 kgCO2eq.
Contact details for obtaining more information		Name and address of the manufacturer or of its authorised representative.	
		Mitsubishi Heavy Industries Air-Conditioning Europe, Ltd. 7 Roundwood Avenue, Stockley Park, Uxbridge, Middlesex, UB11 1AX, United Kingdom	

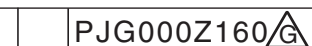

Model FDU100VSVF1

Information to identify the model(s) to which the information relates to:				If function includes heating: Indicate the heating season the information relates to. Indicated values should relate to one heating season at a time. Include at least the heating season 'Average'.			
Indoor unit model name		FDU100VF1		Average (mandatory)		Yes	
Outdoor unit model name		FDC100VS		Warmer (if designated)		No	
Function (indicate if present)				Colder (if designated)			
cooling		Yes					
heating		Yes					
Item symbol value unit				Item symbol value class			
Design load				Seasonal efficiency and energy efficiency class			
cooling		Pdesignc	10.0 kW	cooling		SEER	5.03 B
heating / Average		Pdesignh	9.3 kW	heating / Average		SCOP/A	3.94 A
heating / Warmer		Pdesignh	- kW	heating / Warmer		SCOP/W	- -
heating / Colder		Pdesignh	- kW	heating / Colder		SCOP/C	- -
Declared capacity at outdoor temperature Tdesignh				Back up heating capacity at outdoor temperature Tdesignh			
heating / Average (-10°C)		Pdh	7.86 kW	heating / Average (-10°C)		elbu	1.44 kW
heating / Warmer (2°C)		Pdh	- kW	heating / Warmer (2°C)		elbu	- kW
heating / Colder (-22°C)		Pdh	- kW	heating / Colder (-22°C)		elbu	- kW
Declared capacity for cooling, at indoor temperature 27(19)°C and outdoor temperature Tj				Declared energy efficiency ratio, at indoor temperature 27(19)°C and outdoor temperature Tj			
Tj=35°C		Pdc	10.00 kW	Tj=35°C		EERd	3.57 -
Tj=30°C		Pdc	7.37 kW	Tj=30°C		EERd	4.40 -
Tj=25°C		Pdc	4.74 kW	Tj=25°C		EERd	7.07 -
Tj=20°C		Pdc	4.58 kW	Tj=20°C		EERd	10.11 -
Declared capacity for heating / Average season, at indoor temperature 20°C and outdoor temperature Tj				Declared coefficient of performance / Average season, at indoor temperature 20°C and outdoor temperature Tj			
Tj=-7°C		Pdh	8.23 kW	Tj=-7°C		COPd	2.68 -
Tj=2°C		Pdh	5.00 kW	Tj=2°C		COPd	3.70 -
Tj=7°C		Pdh	3.22 kW	Tj=7°C		COPd	5.45 -
Tj=12°C		Pdh	3.70 kW	Tj=12°C		COPd	6.64 -
Tj=bivalent temperature		Pdh	8.23 kW	Tj=bivalent temperature		COPd	2.68 -
Tj=operating limit		Pdh	6.64 kW	Tj=operating limit		COPd	2.17 -
Declared capacity for heating / Warmer season, at indoor temperature 20°C and outdoor temperature Tj				Declared coefficient of performance / Warmer season, at indoor temperature 20°C and outdoor temperature Tj			
Tj=2°C		Pdh	- kW	Tj=2°C		COPd	- -
Tj=7°C		Pdh	- kW	Tj=7°C		COPd	- -
Tj=12°C		Pdh	- kW	Tj=12°C		COPd	- -
Tj=bivalent temperature		Pdh	- kW	Tj=bivalent temperature		COPd	- -
Tj=operating limit		Pdh	- kW	Tj=operating limit		COPd	- -
Declared capacity for heating / Colder season, at indoor temperature 20°C and outdoor temperature Tj				Declared coefficient of performance / Colder season, at indoor temperature 20°C and outdoor temperature Tj			
Tj=-7°C		Pdh	- kW	Tj=-7°C		COPd	- -
Tj=2°C		Pdh	- kW	Tj=2°C		COPd	- -
Tj=7°C		Pdh	- kW	Tj=7°C		COPd	- -
Tj=12°C		Pdh	- kW	Tj=12°C		COPd	- -
Tj=bivalent temperature		Pdh	- kW	Tj=bivalent temperature		COPd	- -
Tj=operating limit		Pdh	- kW	Tj=operating limit		COPd	- -
Tj=-15°C		Pdh	- kW	Tj=-15°C		COPd	- -
Bivalent temperature				Operating limit temperature			
heating / Average		Tbiv	-7 °C	heating / Average		Tol	-20 °C
heating / Warmer		Tbiv	- °C	heating / Warmer		Tol	- °C
heating / Colder		Tbiv	- °C	heating / Colder		Tol	- °C
Cycling interval capacity				Cycling interval efficiency			
for cooling		Pcycc	- kW	for cooling		EERcyc	- -
for heating		Pcyhc	- kW	for heating		COPcyc	- -
Degradation coefficient				Degradation coefficient			
cooling		Cdc	0.25 -	heating		Cdh	0.25 -
Electric power input in power modes other than 'active mode'				Annual electricity consumption			
off mode		Poff	40 W	cooling		Qce	696 kWh/a
standby mode		Psb	20 W	heating / Average		Qhe	3307 kWh/a
thermostat-off mode		Pto	65 W	heating / Warmer		Qhe	- kWh/a
crankcase heater mode		Pck	25 W	heating / colder		Qhe	- kWh/a
Capacity control (indicate one of three options)				Other items			
fixed		No		Sound power level (indoor)		Lwa	65 dB(A)
staged		No		Sound power level (outdoor)		Lwa	70 dB(A)
variable		Yes		Global warming potential		GWP	1975 kgCO2eq.
				Rated air flow (indoor)		-	2160 m3/h
				Rated air flow (outdoor)		-	4500 m3/h
Contact details for obtaining more information		Name and address of the manufacturer or of its authorised representative. Mitsubishi Heavy Industries Air-Conditioning Europe, Ltd. 7 Roundwood Avenue, Stockley Park, Uxbridge, Middlesex, UB11 1AX, United Kingdom					

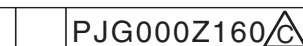

Model FDU100VSF2

Information to identify the model(s) to which the information relates to:				If function includes heating: Indicate the heating season the information relates to. Indicated values should relate to one heating season at a time. Include at least the heating season 'Average'.			
Indoor unit model name		FDU100VF2		Average(mandatory)		Yes	
Outdoor unit model name		FDC100VS		Warmer(if designated)		No	
Function(indicate if present)				Colder(if designated)			
cooling		Yes					
heating		Yes					
Item symbol value unit				Item symbol value class			
Design load				Seasonal efficiency and energy efficiency class			
cooling		Pdesignc	10.0 kW	cooling		SEER	5.03 B
heating / Average		Pdesignh	9.3 kW	heating / Average		SCOP/A	3.94 A
heating / Warmer		Pdesignh	- kW	heating / Warmer		SCOP/W	- -
heating / Colder		Pdesignh	- kW	heating / Colder		SCOP/C	- -
Declared capacity at outdoor temperature Tdesignh				Back up heating capacity at outdoor temperature Tdesignh			
heating / Average (-10°C)		Pdh	7.86 kW	heating / Average (-10°C)		elbu	1.44 kW
heating / Warmer (2°C)		Pdh	- kW	heating / Warmer (2°C)		elbu	- kW
heating / Colder (-22°C)		Pdh	- kW	heating / Colder (-22°C)		elbu	- kW
Declared capacity for cooling, at indoor temperature 27(19)°C and outdoor temperature Tj				Declared energy efficiency ratio, at indoor temperature 27(19)°C and outdoor temperature Tj			
Tj=35°C		Pdc	10.00 kW	Tj=35°C		EERd	3.57 -
Tj=30°C		Pdc	7.37 kW	Tj=30°C		EERd	4.40 -
Tj=25°C		Pdc	4.74 kW	Tj=25°C		EERd	7.07 -
Tj=20°C		Pdc	4.58 kW	Tj=20°C		EERd	10.11 -
Declared capacity for heating / Average season, at indoor temperature 20°C and outdoor temperature Tj				Declared coefficient of performance / Average season, at indoor temperature 20°C and outdoor temperature Tj			
Tj=-7°C		Pdh	8.23 kW	Tj=-7°C		COPd	2.68 -
Tj=2°C		Pdh	5.00 kW	Tj=2°C		COPd	3.70 -
Tj=7°C		Pdh	3.22 kW	Tj=7°C		COPd	5.45 -
Tj=12°C		Pdh	3.70 kW	Tj=12°C		COPd	6.64 -
Tj=bivalent temperature		Pdh	8.23 kW	Tj=bivalent temperature		COPd	2.68 -
Tj=operating limit		Pdh	6.64 kW	Tj=operating limit		COPd	2.17 -
Declared capacity for heating / Warmer season, at indoor temperature 20°C and outdoor temperature Tj				Declared coefficient of performance / Warmer season, at indoor temperature 20°C and outdoor temperature Tj			
Tj=2°C		Pdh	- kW	Tj=2°C		COPd	- -
Tj=7°C		Pdh	- kW	Tj=7°C		COPd	- -
Tj=12°C		Pdh	- kW	Tj=12°C		COPd	- -
Tj=bivalent temperature		Pdh	- kW	Tj=bivalent temperature		COPd	- -
Tj=operating limit		Pdh	- kW	Tj=operating limit		COPd	- -
Declared capacity for heating / Colder season, at indoor temperature 20°C and outdoor temperature Tj				Declared coefficient of performance / Colder season, at indoor temperature 20°C and outdoor temperature Tj			
Tj=-7°C		Pdh	- kW	Tj=-7°C		COPd	- -
Tj=2°C		Pdh	- kW	Tj=2°C		COPd	- -
Tj=7°C		Pdh	- kW	Tj=7°C		COPd	- -
Tj=12°C		Pdh	- kW	Tj=12°C		COPd	- -
Tj=bivalent temperature		Pdh	- kW	Tj=bivalent temperature		COPd	- -
Tj=operating limit		Pdh	- kW	Tj=operating limit		COPd	- -
Tj=-15°C		Pdh	- kW	Tj=-15°C		COPd	- -
Bivalent temperature				Operating limit temperature			
heating / Average		Tbiv	-7 °C	heating / Average		Tol	-20 °C
heating / Warmer		Tbiv	- °C	heating / Warmer		Tol	- °C
heating / Colder		Tbiv	- °C	heating / Colder		Tol	- °C
Cycling interval capacity				Cycling interval efficiency			
for cooling		Pcycc	- kW	for cooling		EERcyc	- -
for heating		Pcyhc	- kW	for heating		COPcyc	- -
Degradation coefficient				Degradation coefficient			
cooling		Cdc	0.25 -	heating		Cdh	0.25 -
Electric power input in power modes other than 'active mode'				Annual electricity consumption			
off mode		Poff	40 W	cooling		Qce	696 kWh/a
standby mode		Psb	20 W	heating / Average		Qhe	3307 kWh/a
thermostat-off mode		Pto	65 W	heating / Warmer		Qhe	- kWh/a
crankcase heater mode		Pck	25 W	heating / colder		Qhe	- kWh/a
Capacity control(indicate one of three options)				Other items			
fixed		No		Sound power level(indoor)		Lwa	65 dB(A)
staged		No		Sound power level(outdoor)		Lwa	70 dB(A)
variable		Yes		Global warming potential		GWP	1975 kgCO2eq.
				Rated air flow(indoor)		-	2160 m3/h
				Rated air flow(outdoor)		-	4500 m3/h
Contact details for obtaining more information		Name and address of the manufacturer or of its authorised representative. Mitsubishi Heavy Industries Air-Conditioning Europe, Ltd. 7 Roundwood Avenue, Stockley Park, Uxbridge, Middlesex, UB11 1AX, United Kingdom					

PJG000Z160 

(5) Duct connected-Low / Middle static pressure type (FDUM)

Model FDUM100VNVF1

Information to identify the model(s) to which the information relates to:		If function includes heating: Indicate the heating season the information relates to. Indicated values should relate to one heating season at a time. Include at least the heating season 'Average'.					
Indoor unit model name		FDUM100VF1					
Outdoor unit model name		FDC100VN					
Function(indicate if present)		Average(mandatory) Yes					
cooling		Warmer(if designated) No					
heating		Colder(if designated) No					
Item	symbol	value	unit	Item	symbol	value	class
Design load				Seasonal efficiency and energy efficiency class			
cooling	Pdesignc	10.0	kW	cooling	SEER	5.06	B
heating / Average	Pdesignh	9.3	kW	heating / Average	SCOP/A	3.94	A
heating / Warmer	Pdesignh	-	kW	heating / Warmer	SCOP/W	-	-
heating / Colder	Pdesignh	-	kW	heating / Colder	SCOP/C	-	-
				unit			
Declared capacity at outdoor temperature Tdesignh				Back up heating capacity at outdoor temperature Tdesignh			
heating / Average (-10°C)		Pdh		heating / Average (-10°C)		elbu	
		7.86				1.44	
heating / Warmer (2°C)		Pdh		heating / Warmer (2°C)		elbu	
		-				-	
heating / Colder (-22°C)		Pdh		heating / Colder (-22°C)		elbu	
		-				-	
Declared capacity for cooling, at indoor temperature 27(19)°C and outdoor temperature Tj				Declared energy efficiency ratio, at indoor temperature 27(19)°C and outdoor temperature Tj			
Tj=35°C		Pdc		Tj=35°C		EERd	
		10.00				3.57	
Tj=30°C		Pdc		Tj=30°C		EERd	
		7.37				4.40	
Tj=25°C		Pdc		Tj=25°C		EERd	
		4.74				7.07	
Tj=20°C		Pdc		Tj=20°C		EERd	
		4.58				10.11	
Declared capacity for heating / Average season, at indoor temperature 20°C and outdoor temperature Tj				Declared coefficient of performance / Average season, at indoor temperature 20°C and outdoor temperature Tj			
Tj=-7°C		Pdh		Tj=-7°C		COPd	
		8.23				2.68	
Tj=2°C		Pdh		Tj=2°C		COPd	
		5.00				3.70	
Tj=7°C		Pdh		Tj=7°C		COPd	
		3.22				5.45	
Tj=12°C		Pdh		Tj=12°C		COPd	
		3.70				6.64	
Tj=bivalent temperature		Pdh		Tj=bivalent temperature		COPd	
		8.23				2.68	
Tj=operating limit		Pdh		Tj=operating limit		COPd	
		6.64				2.17	
Declared capacity for heating / Warmer season, at indoor temperature 20°C and outdoor temperature Tj				Declared coefficient of performance / Warmer season, at indoor temperature 20°C and outdoor temperature Tj			
Tj=2°C		Pdh		Tj=2°C		COPd	
		-				-	
Tj=7°C		Pdh		Tj=7°C		COPd	
		-				-	
Tj=12°C		Pdh		Tj=12°C		COPd	
		-				-	
Tj=bivalent temperature		Pdh		Tj=bivalent temperature		COPd	
		-				-	
Tj=operating limit		Pdh		Tj=operating limit		COPd	
		-				-	
Declared capacity for heating / Colder season, at indoor temperature 20°C and outdoor temperature Tj				Declared coefficient of performance / Colder season, at indoor temperature 20°C and outdoor temperature Tj			
Tj=-7°C		Pdh		Tj=-7°C		COPd	
		-				-	
Tj=2°C		Pdh		Tj=2°C		COPd	
		-				-	
Tj=7°C		Pdh		Tj=7°C		COPd	
		-				-	
Tj=12°C		Pdh		Tj=12°C		COPd	
		-				-	
Tj=bivalent temperature		Pdh		Tj=bivalent temperature		COPd	
		-				-	
Tj=operating limit		Pdh		Tj=operating limit		COPd	
		-				-	
Tj=-15°C		Pdh		Tj=-15°C		COPd	
		-				-	
Bivalent temperature				Operating limit temperature			
heating / Average		Tbiv		heating / Average		Tol	
		-7				-20	
heating / Warmer		Tbiv		heating / Warmer		Tol	
		-				-	
heating / Colder		Tbiv		heating / Colder		Tol	
		-				-	
Cycling interval capacity				Cycling interval efficiency			
for cooling		Pcyc		for cooling		EERcyc	
		-				-	
for heating		Pcyc		for heating		COPcyc	
		-				-	
Degradation coefficient				Degradation coefficient			
cooling		Cdc		heating		Cdh	
		0.25				0.25	
Electric power input in power modes other than 'active mode'				Annual electricity consumption			
off mode		Poff		cooling		Qce	
		20				692	
standby mode		Psb		heating / Average		Qhe	
		20				3303	
thermostat-off mode		Pto		heating / Warmer		Qhe	
		45				-	
crankcase heater mode		Pck		heating / colder		Qhe	
		25				-	
Capacity control(indicate one of three options)				Other items			
fixed		No		Sound power level(indoor)		Lwa	
		No				65	
staged		No		Sound power level(outdoor)		Lwa	
		No				70	
variable		Yes		Global warming potential		GWP	
		Yes				1975	
				Rated air flow(indoor)		-	
						2160	
				Rated air flow(outdoor)		-	
						4500	
Contact details for obtaining more information		Name and address of the manufacturer or of its authorised representative. Mitsubishi Heavy Industries Air-Conditioning Europe, Ltd. 7 Roundwood Avenue, Stockley Park, Uxbridge, Middlesex, UB11 1AX, United Kingdom					
						PJG000Z159 	

Model FDUM100VNVF2

Information to identify the model(s) to which the information relates to:		If function includes heating: Indicate the heating season the information relates to. Indicated values should relate to one heating season at a time. Include at least the heating season 'Average'.					
Indoor unit model name		FDUM100VF2					
Outdoor unit model name		FDC100VN					
Function(indicate if present)		Average(mandatory)					
cooling		Yes		Yes			
heating		Yes		No			
				No			
Item	symbol	value	unit	Item	symbol	value	class
Design load				Seasonal efficiency and energy efficiency class			
cooling	Pdesignc	10.0	kW	cooling	SEER	5.06	B
heating / Average	Pdesignh	9.3	kW	heating / Average	SCOP/A	3.94	A
heating / Warmer	Pdesignh	-	kW	heating / Warmer	SCOP/W	-	-
heating / Colder	Pdesignh	-	kW	heating / Colder	SCOP/C	-	-
				unit			
Declared capacity at outdoor temperature Tdesignh				Back up heating capacity at outdoor temperature Tdesignh			
heating / Average (-10°C)		Pdh	7.86 kW	heating / Average (-10°C)		elbu	1.44 kW
heating / Warmer (2°C)		Pdh	- kW	heating / Warmer (2°C)		elbu	- kW
heating / Colder (-22°C)		Pdh	- kW	heating / Colder (-22°C)		elbu	- kW
Declared capacity for cooling, at indoor temperature 27(19)°C and outdoor temperature Tj				Declared energy efficiency ratio, at indoor temperature 27(19)°C and outdoor temperature Tj			
Tj=35°C		Pdc	10.00 kW	Tj=35°C		EERd	3.57 -
Tj=30°C		Pdc	7.37 kW	Tj=30°C		EERd	4.40 -
Tj=25°C		Pdc	4.74 kW	Tj=25°C		EERd	7.07 -
Tj=20°C		Pdc	4.58 kW	Tj=20°C		EERd	10.11 -
Declared capacity for heating / Average season, at indoor temperature 20°C and outdoor temperature Tj				Declared coefficient of performance / Average season, at indoor temperature 20°C and outdoor temperature Tj			
Tj=-7°C		Pdh	8.23 kW	Tj=-7°C		COPd	2.68 -
Tj=2°C		Pdh	5.00 kW	Tj=2°C		COPd	3.70 -
Tj=7°C		Pdh	3.22 kW	Tj=7°C		COPd	5.45 -
Tj=12°C		Pdh	3.70 kW	Tj=12°C		COPd	6.64 -
Tj=bivalent temperature		Pdh	8.23 kW	Tj=bivalent temperature		COPd	2.68 -
Tj=operating limit		Pdh	6.64 kW	Tj=operating limit		COPd	2.17 -
Declared capacity for heating / Warmer season, at indoor temperature 20°C and outdoor temperature Tj				Declared coefficient of performance / Warmer season, at indoor temperature 20°C and outdoor temperature Tj			
Tj=2°C		Pdh	- kW	Tj=2°C		COPd	- -
Tj=7°C		Pdh	- kW	Tj=7°C		COPd	- -
Tj=12°C		Pdh	- kW	Tj=12°C		COPd	- -
Tj=bivalent temperature		Pdh	- kW	Tj=bivalent temperature		COPd	- -
Tj=operating limit		Pdh	- kW	Tj=operating limit		COPd	- -
Declared capacity for heating / Colder season, at indoor temperature 20°C and outdoor temperature Tj				Declared coefficient of performance / Colder season, at indoor temperature 20°C and outdoor temperature Tj			
Tj=-7°C		Pdh	- kW	Tj=-7°C		COPd	- -
Tj=2°C		Pdh	- kW	Tj=2°C		COPd	- -
Tj=7°C		Pdh	- kW	Tj=7°C		COPd	- -
Tj=12°C		Pdh	- kW	Tj=12°C		COPd	- -
Tj=bivalent temperature		Pdh	- kW	Tj=bivalent temperature		COPd	- -
Tj=operating limit		Pdh	- kW	Tj=operating limit		COPd	- -
Tj=-15°C		Pdh	- kW	Tj=-15°C		COPd	- -
Bivalent temperature				Operating limit temperature			
heating / Average		Tbiv	-7 °C	heating / Average		Tol	-20 °C
heating / Warmer		Tbiv	- °C	heating / Warmer		Tol	- °C
heating / Colder		Tbiv	- °C	heating / Colder		Tol	- °C
Cycling interval capacity				Cycling interval efficiency			
for cooling		Pcyc	- kW	for cooling		EERcyc	- -
for heating		Pcyc	- kW	for heating		COPcyc	- -
Degradation coefficient				Degradation coefficient			
cooling		Cdc	0.25 -	heating		Cdh	0.25 -
Electric power input in power modes other than 'active mode'				Annual electricity consumption			
off mode		Poff	20 W	cooling		Qce	692 kWh/a
standby mode		Psb	20 W	heating / Average		Qhe	3303 kWh/a
thermostat-off mode		Pto	45 W	heating / Warmer		Qhe	- kWh/a
crankcase heater mode		Pck	25 W	heating / colder		Qhe	- kWh/a
Capacity control(indicate one of three options)				Other items			
fixed		No		Sound power level(indoor)		Lwa	65 dB(A)
staged		No		Sound power level(outdoor)		Lwa	70 dB(A)
variable		Yes		Global warming potential		GWP	1975 kgCO2eq.
				Rated air flow(indoor)		-	2160 m3/h
				Rated air flow(outdoor)		-	4500 m3/h
Contact details for obtaining more information		Name and address of the manufacturer or of its authorised representative. Mitsubishi Heavy Industries Air-Conditioning Europe, Ltd. 7 Roundwood Avenue, Stockley Park, Uxbridge, Middlesex, UB11 1AX, United Kingdom					
						PJG000Z159 	

Model FDUM100VSF1

Information to identify the model(s) to which the information relates to:				If function includes heating: Indicate the heating season the information relates to. Indicated values should relate to one heating season at a time. Include at least the heating season 'Average'.			
Indoor unit model name		FDUM100VF1					
Outdoor unit model name		FDC100VS					
Function(indicate if present)				Average(mandatory)			
cooling		Yes		Warmer(if designated)		No	
heating		Yes		Colder(if designated)		No	
Item				Item			
symbol		value		symbol		value	
unit		unit		class		class	
Design load				Seasonal efficiency and energy efficiency class			
cooling		Pdesignc 10.00 kW		cooling		SEER 5.03 B	
heating / Average		Pdesignh 9.3 kW		heating / Average		SCOP/A 3.94 A	
heating / Warmer		Pdesignh - kW		heating / Warmer		SCOP/W - -	
heating / Colder		Pdesignh - kW		heating / Colder		SCOP/C - -	
				unit			
Declared capacity at outdoor temperature Tdesignh				Back up heating capacity at outdoor temperature Tdesignh			
heating / Average (-10°C)		Pdh 7.86 kW		heating / Average (-10°C)		elbu 1.44 kW	
heating / Warmer (2°C)		Pdh - kW		heating / Warmer (2°C)		elbu - kW	
heating / Colder (-22°C)		Pdh - kW		heating / Colder (-22°C)		elbu - kW	
Declared capacity for cooling, at indoor temperature 27(19)°C and outdoor temperature Tj				Declared energy efficiency ratio, at indoor temperature 27(19)°C and outdoor temperature Tj			
Tj=35°C		Pdc 10.00 kW		Tj=35°C		EERd 3.57 -	
Tj=30°C		Pdc 7.37 kW		Tj=30°C		EERd 4.40 -	
Tj=25°C		Pdc 4.74 kW		Tj=25°C		EERd 7.07 -	
Tj=20°C		Pdc 4.58 kW		Tj=20°C		EERd 10.11 -	
Declared capacity for heating / Average season, at indoor temperature 20°C and outdoor temperature Tj				Declared coefficient of performance / Average season, at indoor temperature 20°C and outdoor temperature Tj			
Tj=-7°C		Pdh 8.23 kW		Tj=-7°C		COPd 2.68 -	
Tj=2°C		Pdh 5.00 kW		Tj=2°C		COPd 3.70 -	
Tj=7°C		Pdh 3.22 kW		Tj=7°C		COPd 5.45 -	
Tj=12°C		Pdh 3.70 kW		Tj=12°C		COPd 6.64 -	
Tj=bivalent temperature		Pdh 8.23 kW		Tj=bivalent temperature		COPd 2.68 -	
Tj=operating limit		Pdh 6.64 kW		Tj=operating limit		COPd 2.17 -	
Declared capacity for heating / Warmer season, at indoor temperature 20°C and outdoor temperature Tj				Declared coefficient of performance / Warmer season, at indoor temperature 20°C and outdoor temperature Tj			
Tj=2°C		Pdh - kW		Tj=2°C		COPd - -	
Tj=7°C		Pdh - kW		Tj=7°C		COPd - -	
Tj=12°C		Pdh - kW		Tj=12°C		COPd - -	
Tj=bivalent temperature		Pdh - kW		Tj=bivalent temperature		COPd - -	
Tj=operating limit		Pdh - kW		Tj=operating limit		COPd - -	
Declared capacity for heating / Colder season, at indoor temperature 20°C and outdoor temperature Tj				Declared coefficient of performance / Colder season, at indoor temperature 20°C and outdoor temperature Tj			
Tj=-7°C		Pdh - kW		Tj=-7°C		COPd - -	
Tj=2°C		Pdh - kW		Tj=2°C		COPd - -	
Tj=7°C		Pdh - kW		Tj=7°C		COPd - -	
Tj=12°C		Pdh - kW		Tj=12°C		COPd - -	
Tj=bivalent temperature		Pdh - kW		Tj=bivalent temperature		COPd - -	
Tj=operating limit		Pdh - kW		Tj=operating limit		COPd - -	
Tj=-15°C		Pdh - kW		Tj=-15°C		COPd - -	
Bivalent temperature				Operating limit temperature			
heating / Average		Tbiv -7 °C		heating / Average		Tol -20 °C	
heating / Warmer		Tbiv - °C		heating / Warmer		Tol - °C	
heating / Colder		Tbiv - °C		heating / Colder		Tol - °C	
Cycling interval capacity				Cycling interval efficiency			
for cooling		Pcycc - kW		for cooling		EERcyc - -	
for heating		Pcyhc - kW		for heating		COPcyc - -	
Degradation coefficient				Degradation coefficient			
cooling		Cdc 0.25 -		heating		Cdh 0.25 -	
Electric power input in power modes other than 'active mode'				Annual electricity consumption			
off mode		Poff 20 W		cooling		Qce 696 kWh/a	
standby mode		Psb 20 W		heating / Average		Qhe 3307 kWh/a	
thermostat-off mode		Pto 65 W		heating / Warmer		Qhe - kWh/a	
crankcase heater mode		Pck 25 W		heating / colder		Qhe - kWh/a	
Capacity control(indicate one of three options)				Other items			
fixed		No		Sound power level(indoor)		Lwa 65 dB(A)	
staged		No		Sound power level(outdoor)		Lwa 70 dB(A)	
variable		Yes		Global warming potential		GWP 1975 kgCO2eq.	
				Rated air flow(indoor)		- 2160 m3/h	
				Rated air flow(outdoor)		- 4500 m3/h	
Contact details for obtaining more information		Name and address of the manufacturer or of its authorised representative. Mitsubishi Heavy Industries Air-Conditioning Europe, Ltd. 7 Roundwood Avenue, Stockley Park, Uxbridge, Middlesex, UB11 1AX, United Kingdom					



Model FDUM100VSVF2

Information to identify the model(s) to which the information relates to:				If function includes heating: Indicate the heating season the information relates to. Indicated values should relate to one heating season at a time. Include at least the heating season 'Average'.			
Indoor unit model name		FDUM100VF2					
Outdoor unit model name		FDC100VS					
Function(indicate if present)				Average(mandatory)			
cooling		Yes		Warmer(if designated)		No	
heating		Yes		Colder(if designated)		No	
Item				Item			
symbol		value		symbol		value	
unit				class			
Design load				Seasonal efficiency and energy efficiency class			
cooling		Pdesignc 10.00 kW		cooling		SEER 5.03 B	
heating / Average		Pdesignh 9.3 kW		heating / Average		SCOP/A 3.94 A	
heating / Warmer		Pdesignh - kW		heating / Warmer		SCOP/W - -	
heating / Colder		Pdesignh - kW		heating / Colder		SCOP/C - -	
				unit			
Declared capacity at outdoor temperature Tdesignh				Back up heating capacity at outdoor temperature Tdesignh			
heating / Average (-10°C)		Pdh 7.86 kW		heating / Average (-10°C)		elbu 1.44 kW	
heating / Warmer (2°C)		Pdh - kW		heating / Warmer (2°C)		elbu - kW	
heating / Colder (-22°C)		Pdh - kW		heating / Colder (-22°C)		elbu - kW	
Declared capacity for cooling, at indoor temperature 27(19)°C and outdoor temperature Tj				Declared energy efficiency ratio, at indoor temperature 27(19)°C and outdoor temperature Tj			
Tj=35°C		Pdc 10.00 kW		Tj=35°C		EERd 3.57 -	
Tj=30°C		Pdc 7.37 kW		Tj=30°C		EERd 4.40 -	
Tj=25°C		Pdc 4.74 kW		Tj=25°C		EERd 7.07 -	
Tj=20°C		Pdc 4.58 kW		Tj=20°C		EERd 10.11 -	
Declared capacity for heating / Average season, at indoor temperature 20°C and outdoor temperature Tj				Declared coefficient of performance / Average season, at indoor temperature 20°C and outdoor temperature Tj			
Tj=-7°C		Pdh 8.23 kW		Tj=-7°C		COPd 2.68 -	
Tj=2°C		Pdh 5.00 kW		Tj=2°C		COPd 3.70 -	
Tj=7°C		Pdh 3.22 kW		Tj=7°C		COPd 5.45 -	
Tj=12°C		Pdh 3.70 kW		Tj=12°C		COPd 6.64 -	
Tj=bivalent temperature		Pdh 8.23 kW		Tj=bivalent temperature		COPd 2.68 -	
Tj=operating limit		Pdh 6.64 kW		Tj=operating limit		COPd 2.17 -	
Declared capacity for heating / Warmer season, at indoor temperature 20°C and outdoor temperature Tj				Declared coefficient of performance / Warmer season, at indoor temperature 20°C and outdoor temperature Tj			
Tj=2°C		Pdh - kW		Tj=2°C		COPd - -	
Tj=7°C		Pdh - kW		Tj=7°C		COPd - -	
Tj=12°C		Pdh - kW		Tj=12°C		COPd - -	
Tj=bivalent temperature		Pdh - kW		Tj=bivalent temperature		COPd - -	
Tj=operating limit		Pdh - kW		Tj=operating limit		COPd - -	
Declared capacity for heating / Colder season, at indoor temperature 20°C and outdoor temperature Tj				Declared coefficient of performance / Colder season, at indoor temperature 20°C and outdoor temperature Tj			
Tj=-7°C		Pdh - kW		Tj=-7°C		COPd - -	
Tj=2°C		Pdh - kW		Tj=2°C		COPd - -	
Tj=7°C		Pdh - kW		Tj=7°C		COPd - -	
Tj=12°C		Pdh - kW		Tj=12°C		COPd - -	
Tj=bivalent temperature		Pdh - kW		Tj=bivalent temperature		COPd - -	
Tj=operating limit		Pdh - kW		Tj=operating limit		COPd - -	
Tj=-15°C		Pdh - kW		Tj=-15°C		COPd - -	
Bivalent temperature				Operating limit temperature			
heating / Average		Tbiv -7 °C		heating / Average		Tol -20 °C	
heating / Warmer		Tbiv - °C		heating / Warmer		Tol - °C	
heating / Colder		Tbiv - °C		heating / Colder		Tol - °C	
Cycling interval capacity				Cycling interval efficiency			
for cooling		Pcycc - kW		for cooling		EERcyc - -	
for heating		Pcyhc - kW		for heating		COPcyc - -	
Degradation coefficient				Degradation coefficient			
cooling		Cdc 0.25 -		heating		Cdh 0.25 -	
Electric power input in power modes other than 'active mode'				Annual electricity consumption			
off mode		Poff 20 W		cooling		Qce 696 kWh/a	
standby mode		Psb 20 W		heating / Average		Qhe 3307 kWh/a	
thermostat-off mode		Pto 65 W		heating / Warmer		Qhe - kWh/a	
crankcase heater mode		Pck 25 W		heating / colder		Qhe - kWh/a	
Capacity control(indicate one of three options)				Other items			
fixed		No		Sound power level(indoor)		Lwa 65 dB(A)	
staged		No		Sound power level(outdoor)		Lwa 70 dB(A)	
variable		Yes		Global warming potential		GWP 1975 kgCO2eq.	
				Rated air flow(indoor)		- 2160 m3/h	
				Rated air flow(outdoor)		- 4500 m3/h	
Contact details for obtaining more information		Name and address of the manufacturer or of its authorised representative. Mitsubishi Heavy Industries Air-Conditioning Europe, Ltd. 7 Roundwood Avenue, Stockley Park, Uxbridge, Middlesex, UB11 1AX, United Kingdom					

PJG000Z159 

Model FDUM100VNPVF

Information to identify the model(s) to which the information relates to:				If function includes heating: Indicate the heating season the information relates to. Indicated values should relate to one heating season at a time. Include at least the heating season 'Average'.			
Indoor unit model name		FDUM50VF x 2					
Outdoor unit model name		FDC100VN					
Function(indicate if present)				Average(mandatory)			
cooling		Yes		Warmer(if designated)		No	
heating		Yes		Colder(if designated)		No	
Item				Item			
		symbol value unit				symbol value class	
Design load				Seasonal efficiency and energy efficiency class			
cooling		Pdesignc 10.0 kW		cooling		SEER 4.81 B	
heating / Average		Pdesignh 9.3 kW		heating / Average		SCOP/A 3.82 A	
heating / Warmer		Pdesignh - kW		heating / Warmer		SCOP/W - -	
heating / Colder		Pdesignh - kW		heating / Colder		SCOP/C - -	
				unit			
Declared capacity at outdoor temperature Tdesignh				Back up heating capacity at outdoor temperature Tdesignh			
heating / Average (-10°C)		Pdh 7.81 kW		heating / Average (-10°C)		elbu 1.49 kW	
heating / Warmer (2°C)		Pdh - kW		heating / Warmer (2°C)		elbu - kW	
heating / Colder (-22°C)		Pdh - kW		heating / Colder (-22°C)		elbu - kW	
Declared capacity for cooling, at indoor temperature 27(19)°C and outdoor temperature Tj				Declared energy efficiency ratio, at indoor temperature 27(19)°C and outdoor temperature Tj			
Tj=35°C		Pdc 10.00 kW		Tj=35°C		EERd 3.52 -	
Tj=30°C		Pdc 7.40 kW		Tj=30°C		EERd 4.35 -	
Tj=25°C		Pdc 4.75 kW		Tj=25°C		EERd 6.33 -	
Tj=20°C		Pdc 4.10 kW		Tj=20°C		EERd 9.32 -	
Declared capacity for heating / Average season, at indoor temperature 20°C and outdoor temperature Tj				Declared coefficient of performance / Average season, at indoor temperature 20°C and outdoor temperature Tj			
Tj=-7°C		Pdh 8.25 kW		Tj=-7°C		COPd 2.50 -	
Tj=2°C		Pdh 5.05 kW		Tj=2°C		COPd 3.66 -	
Tj=7°C		Pdh 3.25 kW		Tj=7°C		COPd 5.24 -	
Tj=12°C		Pdh 3.55 kW		Tj=12°C		COPd 6.23 -	
Tj=bivalent temperature		Pdh 8.25 kW		Tj=bivalent temperature		COPd 2.50 -	
Tj=operating limit		Pdh 6.35 kW		Tj=operating limit		COPd 2.35 -	
Declared capacity for heating / Warmer season, at indoor temperature 20°C and outdoor temperature Tj				Declared coefficient of performance / Warmer season, at indoor temperature 20°C and outdoor temperature Tj			
Tj=2°C		Pdh - kW		Tj=2°C		COPd - -	
Tj=7°C		Pdh - kW		Tj=7°C		COPd - -	
Tj=12°C		Pdh - kW		Tj=12°C		COPd - -	
Tj=bivalent temperature		Pdh - kW		Tj=bivalent temperature		COPd - -	
Tj=operating limit		Pdh - kW		Tj=operating limit		COPd - -	
Declared capacity for heating / Colder season, at indoor temperature 20°C and outdoor temperature Tj				Declared coefficient of performance / Colder season, at indoor temperature 20°C and outdoor temperature Tj			
Tj=-7°C		Pdh - kW		Tj=-7°C		COPd - -	
Tj=2°C		Pdh - kW		Tj=2°C		COPd - -	
Tj=7°C		Pdh - kW		Tj=7°C		COPd - -	
Tj=12°C		Pdh - kW		Tj=12°C		COPd - -	
Tj=bivalent temperature		Pdh - kW		Tj=bivalent temperature		COPd - -	
Tj=operating limit		Pdh - kW		Tj=operating limit		COPd - -	
Tj=-15°C		Pdh - kW		Tj=-15°C		COPd - -	
Bivalent temperature				Operating limit temperature			
heating / Average		Tbiv -7 °C		heating / Average		Tol -20 °C	
heating / Warmer		Tbiv - °C		heating / Warmer		Tol - °C	
heating / Colder		Tbiv - °C		heating / Colder		Tol - °C	
Cycling interval capacity				Cycling interval efficiency			
for cooling		Pcycc - kW		for cooling		EERcyc - -	
for heating		Pcyh - kW		for heating		COPcyc - -	
Degradation coefficient cooling				Degradation coefficient heating			
		Cdc 0.25 -				Cdh 0.25 -	
Electric power input in power modes other than 'active mode'				Annual electricity consumption			
off mode		Poff 18 W		cooling		Qce 728 kWh/a	
standby mode		Psb 18 W		heating / Average		Qhe 3413 kWh/a	
thermostat-off mode		Pto 64 W		heating / Warmer		Qhe - kWh/a	
crankcase heater mode		Pck 25 W		heating / colder		Qhe - kWh/a	
Capacity control(indicate one of three options)				Other items			
fixed		No		Sound power level(indoor)		Lwa 60 dB(A)	
staged		No		Sound power level(outdoor)		Lwa 70 dB(A)	
variable		Yes		Global warming potential		GWP 1975 kgCO2eq.	
				Rated air flow(indoor)		- 780 m3/h	
				Rated air flow(outdoor)		- 4500 m3/h	
Contact details for obtaining more information		Name and address of the manufacturer or of its authorised representative. Mitsubishi Heavy Industries Air-Conditioning Europe, Ltd. 7 Roundwood Avenue, Stockley Park, Uxbridge, Middlesex, UB11 1AX, United Kingdom					

PJG000Z159

Model FDUM100VSPVF

Information to identify the model(s) to which the information relates to:		If function includes heating: Indicate the heating season the information relates to. Indicated values should relate to one heating season at a time. Include at least the heating season 'Average'.	
Indoor unit model name	FDUM50VF x 2		
Outdoor unit model name	FDC100VS		
Function(indicate if present)		Average(mandatory)	
cooling	Yes	Warmer(if designated)	No
heating	Yes	Colder(if designated)	No
Item	symbol	value	unit
Design load			
cooling	Pdesignc	10.0	kW
heating / Average	Pdesignh	9.3	kW
heating / Warmer	Pdesignh	-	kW
heating / Colder	Pdesignh	-	kW
Declared capacity at outdoor temperature Tdesignh		Back up heating capacity at outdoor temperature Tdesignh	
heating / Average (-10°C)	Pdh	7.81	kW
heating / Warmer (2°C)	Pdh	-	kW
heating / Colder (-22°C)	Pdh	-	kW
Declared capacity for cooling, at indoor temperature 27(19)°C and outdoor temperature Tj		Declared energy efficiency ratio, at indoor temperature 27(19)°C and outdoor temperature Tj	
Tj=35°C	Pdc	10.00	kW
Tj=30°C	Pdc	7.40	kW
Tj=25°C	Pdc	4.75	kW
Tj=20°C	Pdc	4.10	kW
Declared capacity for heating / Average season, at indoor temperature 20°C and outdoor temperature Tj		Declared coefficient of performance / Average season, at indoor temperature 20°C and outdoor temperature Tj	
Tj=-7°C	Pdh	8.25	kW
Tj=2°C	Pdh	5.05	kW
Tj=7°C	Pdh	3.25	kW
Tj=12°C	Pdh	3.55	kW
Tj=bivalent temperature	Pdh	8.25	kW
Tj=operating limit	Pdh	6.35	kW
Declared capacity for heating / Warmer season, at indoor temperature 20°C and outdoor temperature Tj		Declared coefficient of performance / Warmer season, at indoor temperature 20°C and outdoor temperature Tj	
Tj=2°C	Pdh	-	kW
Tj=7°C	Pdh	-	kW
Tj=12°C	Pdh	-	kW
Tj=bivalent temperature	Pdh	-	kW
Tj=operating limit	Pdh	-	kW
Declared capacity for heating / Colder season, at indoor temperature 20°C and outdoor temperature Tj		Declared coefficient of performance / Colder season, at indoor temperature 20°C and outdoor temperature Tj	
Tj=-7°C	Pdh	-	kW
Tj=2°C	Pdh	-	kW
Tj=7°C	Pdh	-	kW
Tj=12°C	Pdh	-	kW
Tj=bivalent temperature	Pdh	-	kW
Tj=operating limit	Pdh	-	kW
Tj=-15°C	Pdh	-	kW
Bivalent temperature		Operating limit temperature	
heating / Average	Tbiv	-7	°C
heating / Warmer	Tbiv	-	°C
heating / Colder	Tbiv	-	°C
Cycling interval capacity		Cycling interval efficiency	
for cooling	Pcycc	-	kW
for heating	Pcyh	-	kW
Degradation coefficient		Degradation coefficient	
cooling	Cdc	0.25	-
Electric power input in power modes other than 'active mode'		Annual electricity consumption	
off mode	Poff	18	W
standby mode	Psb	18	W
thermostat-off mode	Pto	84	W
crankcase heater mode	Pck	25	W
Capacity control(indicate one of three options)		Other items	
fixed	No	Sound power level(indoor)	Lwa 60 dB(A)
staged	No	Sound power level(outdoor)	Lwa 70 dB(A)
variable	Yes	Global warming potential	GWP 1975 kgCO2eq.
Contact details for obtaining more information		Name and address of the manufacturer or of its authorised representative.	
		Mitsubishi Heavy Industries Air-Conditioning Europe, Ltd. 7 Roundwood Avenue, Stockley Park, Uxbridge, Middlesex, UB11 1AX, United Kingdom	

PJG000Z159 

(6) Floor standing type (FDF)**Model FDF100VNVD1**

Information to identify the model(s) to which the information relates to:				If function includes heating: Indicate the heating season the information relates to. Indicated values should relate to one heating season at a time. Include at least the heating season 'Average'.			
Indoor unit model name		FDF100VD1		Average(mandatory)		Yes	
Outdoor unit model name		FDC100VN		Warmer(if designated)		No	
Function(indicate if present)				Colder(if designated)			
cooling		Yes					
heating		Yes					
Item	symbol	value	unit	Item	symbol	value	class
Design load				Seasonal efficiency and energy efficiency class			
cooling	Pdesignc	10.0	kW	cooling	SEER	5.02	B
heating / Average	Pdesignh	9.3	kW	heating / Average	SCOP/A	3.80	A
heating / Warmer	Pdesignh	-	kW	heating / Warmer	SCOP/W	-	-
heating / Colder	Pdesignh	-	kW	heating / Colder	SCOP/C	-	-
				unit			
Declared capacity at outdoor temperature Tdesignh				Back up heating capacity at outdoor temperature Tdesignh			
heating / Average (-10°C)	Pdh	7.87	kW	heating / Average (-10°C)	elbu	1.43	kW
heating / Warmer (2°C)	Pdh	-	kW	heating / Warmer (2°C)	elbu	-	kW
heating / Colder (-22°C)	Pdh	-	kW	heating / Colder (-22°C)	elbu	-	kW
Declared capacity for cooling, at indoor temperature 27(19)°C and outdoor temperature Tj				Declared energy efficiency ratio, at indoor temperature 27(19)°C and outdoor temperature Tj			
Tj=35°C	Pdc	10.00	kW	Tj=35°C	EERd	3.21	-
Tj=30°C	Pdc	7.37	kW	Tj=30°C	EERd	4.49	-
Tj=25°C	Pdc	4.74	kW	Tj=25°C	EERd	7.29	-
Tj=20°C	Pdc	4.50	kW	Tj=20°C	EERd	9.68	-
Declared capacity for heating / Average season, at indoor temperature 20°C and outdoor temperature Tj				Declared coefficient of performance / Average season, at indoor temperature 20°C and outdoor temperature Tj			
Tj=-7°C	Pdh	8.14	kW	Tj=-7°C	COPd	2.54	-
Tj=2°C	Pdh	4.95	kW	Tj=2°C	COPd	3.79	-
Tj=7°C	Pdh	3.20	kW	Tj=7°C	COPd	4.88	-
Tj=12°C	Pdh	3.75	kW	Tj=12°C	COPd	5.67	-
Tj=bivalent temperature	Pdh	8.14	kW	Tj=bivalent temperature	COPd	2.54	-
Tj=operating limit	Pdh	6.95	kW	Tj=operating limit	COPd	2.32	-
Declared capacity for heating / Warmer season, at indoor temperature 20°C and outdoor temperature Tj				Declared coefficient of performance / Warmer season, at indoor temperature 20°C and outdoor temperature Tj			
Tj=2°C	Pdh	-	kW	Tj=2°C	COPd	-	-
Tj=7°C	Pdh	-	kW	Tj=7°C	COPd	-	-
Tj=12°C	Pdh	-	kW	Tj=12°C	COPd	-	-
Tj=bivalent temperature	Pdh	-	kW	Tj=bivalent temperature	COPd	-	-
Tj=operating limit	Pdh	-	kW	Tj=operating limit	COPd	-	-
Declared capacity for heating / Colder season, at indoor temperature 20°C and outdoor temperature Tj				Declared coefficient of performance / Colder season, at indoor temperature 20°C and outdoor temperature Tj			
Tj=-7°C	Pdh	-	kW	Tj=-7°C	COPd	-	-
Tj=2°C	Pdh	-	kW	Tj=2°C	COPd	-	-
Tj=7°C	Pdh	-	kW	Tj=7°C	COPd	-	-
Tj=12°C	Pdh	-	kW	Tj=12°C	COPd	-	-
Tj=bivalent temperature	Pdh	-	kW	Tj=bivalent temperature	COPd	-	-
Tj=operating limit	Pdh	-	kW	Tj=operating limit	COPd	-	-
Tj=-15°C	Pdh	-	kW	Tj=-15°C	COPd	-	-
Bivalent temperature				Operating limit temperature			
heating / Average	Tbiv	-7	°C	heating / Average	Tol	-20	°C
heating / Warmer	Tbiv	-	°C	heating / Warmer	Tol	-	°C
heating / Colder	Tbiv	-	°C	heating / Colder	Tol	-	°C
Cycling interval capacity				Cycling interval efficiency			
for cooling	Pcycc	-	kW	for cooling	EERcyc	-	-
for heating	Pcyh	-	kW	for heating	COpcyc	-	-
Degradation coefficient				Degradation coefficient			
cooling	Cdc	0.25	-	heating	Cdh	0.25	-
Electric power input in power modes other than 'active mode'				Annual electricity consumption			
off mode	Poff	20	W	cooling	Qce	697	kWh/a
standby mode	Psb	20	W	heating / Average	Qhe	3423	kWh/a
thermostat-off mode	Pto	60	W	heating / Warmer	Qhe	-	kWh/a
crankcase heater mode	Pck	25	W	heating / colder	Qhe	-	kWh/a
Capacity control(indicate one of three options)				Other items			
fixed		No		Sound power level(indoor)	Lwa	65	dB(A)
staged		No		Sound power level(outdoor)	Lwa	70	dB(A)
variable		Yes		Global warming potential	GWP	1975	kgCO2eq.
				Rated air flow(indoor)	-	1740	m3/h
				Rated air flow(outdoor)	-	4500	m3/h
Contact details for obtaining more information	Name and address of the manufacturer or of its authorised representative. Mitsubishi Heavy Industries Air-Conditioning Europe, Ltd. 7 Roundwood Avenue, Stockley Park, Uxbridge, Middlesex, UB11 1AX, United Kingdom						

PGA000Z812 

Model FDF100VNVD2

Information to identify the model(s) to which the information relates to:				If function includes heating: Indicate the heating season the information relates to. Indicated values should relate to one heating season at a time. Include at least the heating season 'Average'.			
Indoor unit model name		FDF100VD2		Average(mandatory)		Yes	
Outdoor unit model name		FDC100VN		Warmer(if designated)		No	
Function(indicate if present)				Colder(if designated)		No	
cooling		Yes					
heating		Yes					
Item	symbol	value	unit	Item	symbol	value	class
Design load				Seasonal efficiency and energy efficiency class			
cooling	Pdesignc	10.0	kW	cooling	SEER	5.02	B
heating / Average	Pdesignh	9.3	kW	heating / Average	SCOP/A	3.80	A
heating / Warmer	Pdesignh	-	kW	heating / Warmer	SCOP/W	-	-
heating / Colder	Pdesignh	-	kW	heating / Colder	SCOP/C	-	-
				unit			
Declared capacity at outdoor temperature Tdesignh				Back up heating capacity at outdoor temperature Tdesignh			
heating / Average (-10°C)		Pdh 7.87 kW		heating / Average (-10°C)		elbu 1.43 kW	
heating / Warmer (2°C)		Pdh - kW		heating / Warmer (2°C)		elbu - kW	
heating / Colder (-22°C)		Pdh - kW		heating / Colder (-22°C)		elbu - kW	
Declared capacity for cooling, at indoor temperature 27(19)°C and outdoor temperature Tj				Declared energy efficiency ratio, at indoor temperature 27(19)°C and outdoor temperature Tj			
Tj=35°C		Pdc 10.00 kW		Tj=35°C		EERd 3.21 -	
Tj=30°C		Pdc 7.37 kW		Tj=30°C		EERd 4.49 -	
Tj=25°C		Pdc 4.74 kW		Tj=25°C		EERd 7.29 -	
Tj=20°C		Pdc 4.50 kW		Tj=20°C		EERd 9.68 -	
Declared capacity for heating / Average season, at indoor temperature 20°C and outdoor temperature Tj				Declared coefficient of performance / Average season, at indoor temperature 20°C and outdoor temperature Tj			
Tj=-7°C		Pdh 8.14 kW		Tj=-7°C		COPd 2.54 -	
Tj=2°C		Pdh 4.95 kW		Tj=2°C		COPd 3.79 -	
Tj=7°C		Pdh 3.20 kW		Tj=7°C		COPd 4.88 -	
Tj=12°C		Pdh 3.75 kW		Tj=12°C		COPd 5.67 -	
Tj=bivalent temperature		Pdh 8.14 kW		Tj=bivalent temperature		COPd 2.54 -	
Tj=operating limit		Pdh 6.95 kW		Tj=operating limit		COPd 2.32 -	
Declared capacity for heating / Warmer season, at indoor temperature 20°C and outdoor temperature Tj				Declared coefficient of performance / Warmer season, at indoor temperature 20°C and outdoor temperature Tj			
Tj=2°C		Pdh - kW		Tj=2°C		COPd - -	
Tj=7°C		Pdh - kW		Tj=7°C		COPd - -	
Tj=12°C		Pdh - kW		Tj=12°C		COPd - -	
Tj=bivalent temperature		Pdh - kW		Tj=bivalent temperature		COPd - -	
Tj=operating limit		Pdh - kW		Tj=operating limit		COPd - -	
Declared capacity for heating / Colder season, at indoor temperature 20°C and outdoor temperature Tj				Declared coefficient of performance / Colder season, at indoor temperature 20°C and outdoor temperature Tj			
Tj=-7°C		Pdh - kW		Tj=-7°C		COPd - -	
Tj=2°C		Pdh - kW		Tj=2°C		COPd - -	
Tj=7°C		Pdh - kW		Tj=7°C		COPd - -	
Tj=12°C		Pdh - kW		Tj=12°C		COPd - -	
Tj=bivalent temperature		Pdh - kW		Tj=bivalent temperature		COPd - -	
Tj=operating limit		Pdh - kW		Tj=operating limit		COPd - -	
Tj=-15°C		Pdh - kW		Tj=-15°C		COPd - -	
Bivalent temperature				Operating limit temperature			
heating / Average		Tbiv -7 °C		heating / Average		Tol -20 °C	
heating / Warmer		Tbiv - °C		heating / Warmer		Tol - °C	
heating / Colder		Tbiv - °C		heating / Colder		Tol - °C	
Cycling interval capacity				Cycling interval efficiency			
for cooling		Pcycc - kW		for cooling		EERcyc - -	
for heating		Pcyh - kW		for heating		COPcyc - -	
Degradation coefficient				Degradation coefficient			
cooling		Cdc 0.25 -		heating		Cdh 0.25 -	
Electric power input in power modes other than 'active mode'				Annual electricity consumption			
off mode		Poff 20 W		cooling		Qce 697 kWh/a	
standby mode		Psb 20 W		heating / Average		Qhe 3423 kWh/a	
thermostat-off mode		Pto 60 W		heating / Warmer		Qhe - kWh/a	
crankcase heater mode		Pck 25 W		heating / colder		Qhe - kWh/a	
Capacity control(indicate one of three options)				Other items			
fixed		No		Sound power level(indoor)		Lwa 65 dB(A)	
staged		No		Sound power level(outdoor)		Lwa 70 dB(A)	
variable		Yes		Global warming potential		GWP 1975 kgCO2eq.	
				Rated air flow(indoor)		- 1740 m3/h	
				Rated air flow(outdoor)		- 4500 m3/h	
Contact details for obtaining more information		Name and address of the manufacturer or of its authorised representative. Mitsubishi Heavy Industries Air-Conditioning Europe, Ltd. 7 Roundwood Avenue, Stockley Park, Uxbridge, Middlesex, UB11 1AX, United Kingdom					

PGA000Z812 

Model FDF100VSVD1

Information to identify the model(s) to which the information relates to:				If function includes heating: Indicate the heating season the information relates to. Indicated values should relate to one heating season at a time. Include at least the heating season 'Average'.			
Indoor unit model name		FDF100VD1		Average (mandatory)		Yes	
Outdoor unit model name		FDC100VS		Warmer (if designated)		No	
Function (indicate if present)				Colder (if designated)			
cooling		Yes					
heating		Yes					
Item	symbol	value	unit	Item	symbol	value	class
Design load				Seasonal efficiency and energy efficiency class			
cooling	Pdesignc	10.0	kW	cooling	SEER	4.99	B
heating / Average	Pdesignh	9.3	kW	heating / Average	SCOP/A	3.80	A
heating / Warmer	Pdesignh	-	kW	heating / Warmer	SCOP/W	-	-
heating / Colder	Pdesignh	-	kW	heating / Colder	SCOP/C	-	-
				unit			
Declared capacity at outdoor temperature Tdesignh				Back up heating capacity at outdoor temperature Tdesignh			
heating / Average (-10°C)		Pdh 7.87 kW		heating / Average (-10°C)		elbu 1.43 kW	
heating / Warmer (2°C)		Pdh - kW		heating / Warmer (2°C)		elbu - kW	
heating / Colder (-22°C)		Pdh - kW		heating / Colder (-22°C)		elbu - kW	
Declared capacity for cooling, at indoor temperature 27(19)°C and outdoor temperature Tj				Declared energy efficiency ratio, at indoor temperature 27(19)°C and outdoor temperature Tj			
Tj=35°C		Pdc 10.00 kW		Tj=35°C		EERd 3.21 -	
Tj=30°C		Pdc 7.37 kW		Tj=30°C		EERd 4.49 -	
Tj=25°C		Pdc 4.74 kW		Tj=25°C		EERd 7.29 -	
Tj=20°C		Pdc 4.50 kW		Tj=20°C		EERd 9.68 -	
Declared capacity for heating / Average season, at indoor temperature 20°C and outdoor temperature Tj				Declared coefficient of performance / Average season, at indoor temperature 20°C and outdoor temperature Tj			
Tj=-7°C		Pdh 8.14 kW		Tj=-7°C		COPd 2.54 -	
Tj=2°C		Pdh 4.95 kW		Tj=2°C		COPd 3.79 -	
Tj=7°C		Pdh 3.20 kW		Tj=7°C		COPd 4.88 -	
Tj=12°C		Pdh 3.75 kW		Tj=12°C		COPd 5.67 -	
Tj=bivalent temperature		Pdh 8.14 kW		Tj=bivalent temperature		COPd 2.54 -	
Tj=operating limit		Pdh 6.95 kW		Tj=operating limit		COPd 2.32 -	
Declared capacity for heating / Warmer season, at indoor temperature 20°C and outdoor temperature Tj				Declared coefficient of performance / Warmer season, at indoor temperature 20°C and outdoor temperature Tj			
Tj=2°C		Pdh - kW		Tj=2°C		COPd - -	
Tj=7°C		Pdh - kW		Tj=7°C		COPd - -	
Tj=12°C		Pdh - kW		Tj=12°C		COPd - -	
Tj=bivalent temperature		Pdh - kW		Tj=bivalent temperature		COPd - -	
Tj=operating limit		Pdh - kW		Tj=operating limit		COPd - -	
Declared capacity for heating / Colder season, at indoor temperature 20°C and outdoor temperature Tj				Declared coefficient of performance / Colder season, at indoor temperature 20°C and outdoor temperature Tj			
Tj=-7°C		Pdh - kW		Tj=-7°C		COPd - -	
Tj=2°C		Pdh - kW		Tj=2°C		COPd - -	
Tj=7°C		Pdh - kW		Tj=7°C		COPd - -	
Tj=12°C		Pdh - kW		Tj=12°C		COPd - -	
Tj=bivalent temperature		Pdh - kW		Tj=bivalent temperature		COPd - -	
Tj=operating limit		Pdh - kW		Tj=operating limit		COPd - -	
Tj=-15°C		Pdh - kW		Tj=-15°C		COPd - -	
Bivalent temperature				Operating limit temperature			
heating / Average		Tbiv -7 °C		heating / Average		Tol -20 °C	
heating / Warmer		Tbiv - °C		heating / Warmer		Tol - °C	
heating / Colder		Tbiv - °C		heating / Colder		Tol - °C	
Cycling interval capacity				Cycling interval efficiency			
for cooling		Pcycc - kW		for cooling		EERcyc - -	
for heating		Pcyh - kW		for heating		COPcyc - -	
Degradation coefficient				Degradation coefficient			
cooling		Cdc 0.25 -		heating		Cdh 0.25 -	
Electric power input in power modes other than 'active mode'				Annual electricity consumption			
off mode		Poff 20 W		cooling		Qce 701 kWh/a	
standby mode		Psb 20 W		heating / Average		Qhe 3427 kWh/a	
thermostat-off mode		Pto 80 W		heating / Warmer		Qhe - kWh/a	
crankcase heater mode		Pck 25 W		heating / Colder		Qhe - kWh/a	
Capacity control (indicate one of three options)				Other items			
fixed		No		Sound power level (indoor)		Lwa 65 dB(A)	
staged		No		Sound power level (outdoor)		Lwa 70 dB(A)	
variable		Yes		Global warming potential		GWP 1975 kgCO2eq.	
				Rated air flow (indoor)		- 1740 m3/h	
				Rated air flow (outdoor)		- 4500 m3/h	
Contact details for obtaining more information		Name and address of the manufacturer or of its authorised representative. Mitsubishi Heavy Industries Air-Conditioning Europe, Ltd. 7 Roundwood Avenue, Stockley Park, Uxbridge, Middlesex, UB11 1AX, United Kingdom					

PGA000Z812 

Model FDF100VSVD2

Information to identify the model(s) to which the information relates to:				If function includes heating: Indicate the heating season the information relates to. Indicated values should relate to one heating season at a time. Include at least the heating season 'Average'.			
Indoor unit model name		FDF100VD2		Average (mandatory)		Yes	
Outdoor unit model name		FDC100VS		Warmer (if designated)		No	
Function (indicate if present)				Colder (if designated)		No	
cooling		Yes					
heating		Yes					
Item	symbol	value	unit	Item	symbol	value	class
Design load				Seasonal efficiency and energy efficiency class			
cooling	Pdesignc	10.0	kW	cooling	SEER	4.99	B
heating / Average	Pdesignh	9.3	kW	heating / Average	SCOP/A	3.80	A
heating / Warmer	Pdesignh	-	kW	heating / Warmer	SCOP/W	-	-
heating / Colder	Pdesignh	-	kW	heating / Colder	SCOP/C	-	-
				unit			
Declared capacity at outdoor temperature Tdesignh				Back up heating capacity at outdoor temperature Tdesignh			
heating / Average (-10°C)		Pdh 7.87 kW		heating / Average (-10°C)		elbu 1.43 kW	
heating / Warmer (2°C)		Pdh - kW		heating / Warmer (2°C)		elbu - kW	
heating / Colder (-22°C)		Pdh - kW		heating / Colder (-22°C)		elbu - kW	
Declared capacity for cooling, at indoor temperature 27(19)°C and outdoor temperature Tj				Declared energy efficiency ratio, at indoor temperature 27(19)°C and outdoor temperature Tj			
Tj=35°C		Pdc 10.00 kW		Tj=35°C		EERd 3.21 -	
Tj=30°C		Pdc 7.37 kW		Tj=30°C		EERd 4.49 -	
Tj=25°C		Pdc 4.74 kW		Tj=25°C		EERd 7.29 -	
Tj=20°C		Pdc 4.50 kW		Tj=20°C		EERd 9.68 -	
Declared capacity for heating / Average season, at indoor temperature 20°C and outdoor temperature Tj				Declared coefficient of performance / Average season, at indoor temperature 20°C and outdoor temperature Tj			
Tj=-7°C		Pdh 8.14 kW		Tj=-7°C		COPd 2.54 -	
Tj=2°C		Pdh 4.95 kW		Tj=2°C		COPd 3.79 -	
Tj=7°C		Pdh 3.20 kW		Tj=7°C		COPd 4.88 -	
Tj=12°C		Pdh 3.75 kW		Tj=12°C		COPd 5.67 -	
Tj=bivalent temperature		Pdh 8.14 kW		Tj=bivalent temperature		COPd 2.54 -	
Tj=operating limit		Pdh 6.95 kW		Tj=operating limit		COPd 2.32 -	
Declared capacity for heating / Warmer season, at indoor temperature 20°C and outdoor temperature Tj				Declared coefficient of performance / Warmer season, at indoor temperature 20°C and outdoor temperature Tj			
Tj=2°C		Pdh - kW		Tj=2°C		COPd - -	
Tj=7°C		Pdh - kW		Tj=7°C		COPd - -	
Tj=12°C		Pdh - kW		Tj=12°C		COPd - -	
Tj=bivalent temperature		Pdh - kW		Tj=bivalent temperature		COPd - -	
Tj=operating limit		Pdh - kW		Tj=operating limit		COPd - -	
Declared capacity for heating / Colder season, at indoor temperature 20°C and outdoor temperature Tj				Declared coefficient of performance / Colder season, at indoor temperature 20°C and outdoor temperature Tj			
Tj=-7°C		Pdh - kW		Tj=-7°C		COPd - -	
Tj=2°C		Pdh - kW		Tj=2°C		COPd - -	
Tj=7°C		Pdh - kW		Tj=7°C		COPd - -	
Tj=12°C		Pdh - kW		Tj=12°C		COPd - -	
Tj=bivalent temperature		Pdh - kW		Tj=bivalent temperature		COPd - -	
Tj=operating limit		Pdh - kW		Tj=operating limit		COPd - -	
Tj=-15°C		Pdh - kW		Tj=-15°C		COPd - -	
Bivalent temperature				Operating limit temperature			
heating / Average		Tbiv -7 °C		heating / Average		Tol -20 °C	
heating / Warmer		Tbiv - °C		heating / Warmer		Tol - °C	
heating / Colder		Tbiv - °C		heating / Colder		Tol - °C	
Cycling interval capacity				Cycling interval efficiency			
for cooling		Pcycc - kW		for cooling		EERcyc - -	
for heating		Pcyh - kW		for heating		COPcyc - -	
Degradation coefficient				Degradation coefficient			
cooling		Cdc 0.25 -		heating		Cdh 0.25 -	
Electric power input in power modes other than 'active mode'				Annual electricity consumption			
off mode		Poff 20 W		cooling		Qce 701 kWh/a	
standby mode		Psb 20 W		heating / Average		Qhe 3427 kWh/a	
thermostat-off mode		Pto 80 W		heating / Warmer		Qhe - kWh/a	
crankcase heater mode		Pck 25 W		heating / Colder		Qhe - kWh/a	
Capacity control (indicate one of three options)				Other items			
fixed		No		Sound power level (indoor)		Lwa 65 dB(A)	
staged		No		Sound power level (outdoor)		Lwa 70 dB(A)	
variable		Yes		Global warming potential		GWP 1975 kgCO2eq.	
				Rated air flow (indoor)		- 1740 m3/h	
				Rated air flow (outdoor)		- 4500 m3/h	
Contact details for obtaining more information		Name and address of the manufacturer or of its authorised representative. Mitsubishi Heavy Industries Air-Conditioning Europe, Ltd. 7 Roundwood Avenue, Stockley Park, Uxbridge, Middlesex, UB11 1AX, United Kingdom					

PGA000Z812

(7) Wall mounted type (SRK)

Model SRK100VNPZMX

Information to identify the model(s) to which the information relates to				If function includes heating: Indicate the heating season the information relates to. Indicated values should relate to one heating season at a time. Include at least the heating season 'Average'			
Indoor unit model name		SRK50ZMX-S x2		Average(mandatory)		Yes	
Outdoor unit model name		FDC100VN		Warmer(if designated)		No	
Function(indicate if present)				Colder(if designated)		No	
cooling		Yes					
heating		Yes					
Item	symbol	value	unit	Item	symbol	value	class
Design load cooling	Pdesignc	10.0	kW	Seasonal efficiency and energy efficiency class cooling	SEER	5.46	A
heating / Average	Pdesignh	8.2	kW	heating / Average	SCOP/A	4.00	A+
heating / Warmer	Pdesignh	-	kW	heating / Warmer	SCOP/W	-	-
heating / Colder	Pdesignh	-	kW	heating / Colder	SCOP/C	-	-
				unit			
Declared capacity at outdoor temperature Tdesignf				Back up heating capacity at outdoor temperature Tdesignf			
heating / Average (-10°C)		Pdh 8.20 kW		heating / Average (-10°C)		elbu 0.00 kW	
heating / Warmer (2°C)		Pdh - kW		heating / Warmer (2°C)		elbu - kW	
heating / Colder (-22°C)		Pdh - kW		heating / Colder (-22°C)		elbu - kW	
Declared capacity for cooling, at indoor temperature 27(19)°C and outdoor temperature Tj				Declared energy efficiency ratio, at indoor temperature 27(19)°C and outdoor temperature Tj			
Tj=35°C		Pdc 10.00 kW		Tj=35°C		EERd 3.62 -	
Tj=30°C		Pdc 7.37 kW		Tj=30°C		EERd 4.98 -	
Tj=25°C		Pdc 5.20 kW		Tj=25°C		EERd 8.39 -	
Tj=20°C		Pdc 4.90 kW		Tj=20°C		EERd 11.40 -	
Declared capacity for heating / Average season, at indoor temperature 20°C and outdoor temperature Tj				Declared coefficient of performance / Average season, at indoor temperature 20°C and outdoor temperature Tj			
Tj=-7°C		Pdh 6.80 kW		Tj=-7°C		COPd 2.72 -	
Tj=2°C		Pdh 4.41 kW		Tj=2°C		COPd 3.68 -	
Tj=7°C		Pdh 2.90 kW		Tj=7°C		COPd 5.80 -	
Tj=12°C		Pdh 3.76 kW		Tj=12°C		COPd 7.09 -	
Tj=bivalent temperature		Pdh 8.20 kW		Tj=bivalent temperature		COPd 2.33 -	
Tj=operating limit		Pdh 7.00 kW		Tj=operating limit		COPd 2.24 -	
Declared capacity for heating / Warmer season, at indoor temperature 20°C and outdoor temperature Tj				Declared coefficient of performance / Warmer season, at indoor temperature 20°C and outdoor temperature Tj			
Tj=2°C		Pdh - kW		Tj=2°C		COPd - -	
Tj=7°C		Pdh - kW		Tj=7°C		COPd - -	
Tj=12°C		Pdh - kW		Tj=12°C		COPd - -	
Tj=bivalent temperature		Pdh - kW		Tj=bivalent temperature		COPd - -	
Tj=operating limit		Pdh - kW		Tj=operating limit		COPd - -	
Declared capacity for heating / Colder season, at indoor temperature 20°C and outdoor temperature Tj				Declared coefficient of performance / Colder season, at indoor temperature 20°C and outdoor temperature Tj			
Tj=-7°C		Pdh - kW		Tj=-7°C		COPd - -	
Tj=2°C		Pdh - kW		Tj=2°C		COPd - -	
Tj=7°C		Pdh - kW		Tj=7°C		COPd - -	
Tj=12°C		Pdh - kW		Tj=12°C		COPd - -	
Tj=bivalent temperature		Pdh - kW		Tj=bivalent temperature		COPd - -	
Tj=operating limit		Pdh - kW		Tj=operating limit		COPd - -	
Tj=-15°C		Pdh - kW		Tj=-15°C		COPd - -	
Bivalent temperature				Operating limit temperature			
heating / Average		Tbiv -10 °C		heating / Average		Tol -20 °C	
heating / Warmer		Tbiv - °C		heating / Warmer		Tol - °C	
heating / Colder		Tbiv - °C		heating / Colder		Tol - °C	
Cycling interval capacity				Cycling interval efficiency			
for cooling		Pcycc - kW		for cooling		EERcyc - -	
for heating		Pcyh - kW		for heating		COPcyc - -	
Degradation coefficient cooling				Degradation coefficient heating			
cooling		Cdc 0.25 -		heating		Cdh 0.25 -	
Electric power input in power modes other than 'active mode'				Annual electricity consumption			
off mode		Poff 20 W		cooling		Qce 642 kWh/a	
standby mode		Psb 20 W		heating / Average		Qhe 2869 kWh/a	
thermostat-off mode		Pto 125 W		heating / Warmer		Qhe - kWh/a	
crankcase heater mode		Pck 25 W		heating / colder		Qhe - kWh/a	
Capacity control(indicate one of three options)				Other items			
fixed		No		Sound power level(indoor)		Lwa 60 dB(A)	
staged		No		Sound power level(outdoor)		Lwa 70 dB(A)	
variable		Yes		Global warming potential		GWP 1975 kgCO2eq.	
				Rated air flow(indoor)		- 810 m3/h	
				Rated air flow(outdoor)		- 4500 m3/h	
Contact details for obtaining more information		Name and address of the manufacturer or of its authorised representative					
		Mitsubishi Heavy Industries Air-Conditioning Europe, Ltd					
		7 Roundwood Avenue, Stockley Park, Uxbridge, Middlesex, UB11 1AX					
		United Kingdom					

A PCA001Z717 

Model SRK100VSPZMX

Information to identify the model(s) to which the information relates to		If function includes heating: Indicate the heating season the information relates to. Indicated values should relate to one heating season at a time. Include at least the heating season 'Average'	
Indoor unit model name	SRK50ZMX-S x2		
Outdoor unit model name	FDC100VS		
Function(indicate if present)		Average(mandatory)	
cooling	Yes	Warmer(if designated)	No
heating	Yes	Colder(if designated)	No
Item	symbol	value	unit
Design load			
cooling	Pdesignc	10.0	kW
heating / Average	Pdesignh	8.2	kW
heating / Warmer	Pdesignh	-	kW
heating / Colder	Pdesignh	-	kW
Declared capacity at outdoor temperature Tdesignf		Back up heating capacity at outdoor temperature Tdesignf	
heating / Average (-10°C)	Pdh	8.20	kW
heating / Warmer (2°C)	Pdh	-	kW
heating / Colder (-22°C)	Pdh	-	kW
Declared capacity for cooling, at indoor temperature 27(19°C and outdoor temperature Tj		Declared energy efficiency ratio, at indoor temperature 27(19°C and outdoor temperature Tj	
Tj=35°C	Pdc	10.00	kW
Tj=30°C	Pdc	7.37	kW
Tj=25°C	Pdc	5.20	kW
Tj=20°C	Pdc	4.90	kW
Declared capacity for heating / Average season, at indoor temperature 20°C and outdoor temperature Tj		Declared coefficient of performance / Average season, at indoor temperature 20°C and outdoor temperature Tj	
Tj=-7°C	Pdh	6.80	kW
Tj=2°C	Pdh	4.41	kW
Tj=7°C	Pdh	2.90	kW
Tj=12°C	Pdh	3.76	kW
Tj=bivalent temperature	Pdh	8.20	kW
Tj=operating limit	Pdh	7.00	kW
Declared capacity for heating / Warmer season, at indoor temperature 20°C and outdoor temperature Tj		Declared coefficient of performance / Warmer season, at indoor temperature 20°C and outdoor temperature Tj	
Tj=2°C	Pdh	-	kW
Tj=7°C	Pdh	-	kW
Tj=12°C	Pdh	-	kW
Tj=bivalent temperature	Pdh	-	kW
Tj=operating limit	Pdh	-	kW
Declared capacity for heating / Colder season, at indoor temperature 20°C and outdoor temperature Tj		Declared coefficient of performance / Colder season, at indoor temperature 20°C and outdoor temperature Tj	
Tj=-7°C	Pdh	-	kW
Tj=2°C	Pdh	-	kW
Tj=7°C	Pdh	-	kW
Tj=12°C	Pdh	-	kW
Tj=bivalent temperature	Pdh	-	kW
Tj=operating limit	Pdh	-	kW
Tj=-15°C	Pdh	-	kW
Bivalent temperature		Operating limit temperature	
heating / Average	Tbiv	-10	°C
heating / Warmer	Tbiv	-	°C
heating / Colder	Tbiv	-	°C
heating / Average		heating / Average	
heating / Warmer		heating / Warmer	
heating / Colder		heating / Colder	
Cycling interval capacity		Cycling interval efficiency	
for cooling	Pccyc	-	kW
for heating	Pchyc	-	kW
for cooling		for cooling	
for heating		for heating	
Degradation coefficient		Degradation coefficient	
cooling	Cdc	0.25	-
cooling		heating	
heating		heating	
Electric power input in power modes other than 'active mode		Annual electricity consumption	
off mode	Poff	20	W
standby mode	Psb	20	W
thermostat-off mode	Pto	145	W
crankcase heater mode	Pck	25	W
cooling		cooling	
heating / Average		heating / Average	
heating / Warmer		heating / Warmer	
heating / colder		heating / colder	
Capacity control(indicate one of three options)		Other items	
fixed	No	Sound power level(indoor)	Lwa 60 dB(A)
staged	No	Sound power level(outdoor)	Lwa 70 dB(A)
variable	Yes	Global warming potential	GWP 1975 kgCO2eq.
		Rated air flow(indoor)	- 810 m3/h
		Rated air flow(outdoor)	- 4500 m3/h
Contact details for obtaining more information	Name and address of the manufacturer or of its authorised representative Mitsubishi Heavy Industries Air-Conditioning Europe, Ltd 7 Roundwood Avenue, Stockley Park, Uxbridge, Middlesex, UB11 1AX United Kingdom		

A PCA001Z717 

2. V MULTI SYSTEM

CONTENTS

2.1 GENERAL INFORMATION	490
2.1.1 How to read the model name	490
2.1.2 Table of models	491
2.1.3 Table of system combinations	491
2.2 SPECIFICATIONS	492
(1) Indoor units	492
(a) Ceiling cassette-4way type (FDT)	492
(b) Ceiling suspended type (FDEN)	497
(2) Outdoor units	502
(3) Operation chart.....	510
2.3 EXTERIOR DIMENSIONS	513
2.4 ELECTRICAL WIRING	513
2.5 NOISE LEVEL	513
2.6 TEMPERATURE AND VELOCITY DISTRIBUTION	513
2.7 PIPING SYSTEM	513
2.8 RANGE OF USAGE & LIMITATIONS	513
2.9 SELECTION CHART	513
2.10 APPLICATION DATE	513

2.1 GENERAL INFORMATION

2.1.1 How to read the model name

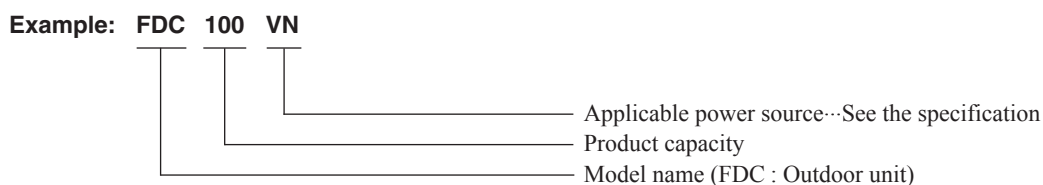
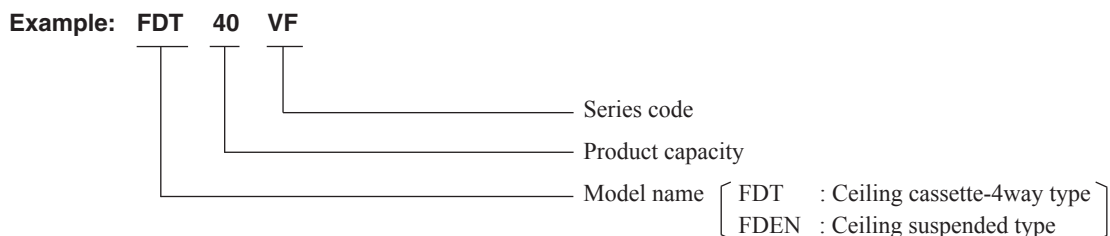

2.1.2 Table of models

Model \ Capacity	50	60	71	100	125
Ceiling cassette-4way type (FDT)	○	○	○	○	○
Ceiling suspended type (FDEN)	○	○	○	○	○
Outdoor unit to be combined (FDC)	FDC100VN FDC100VS (4 Horse Power)	FDC125VN FDC125VS (5 Horse Power)	FDC140VN FDC140VS (6 Horse Power)	FDC200VS (8 Horse Power)	FDC250VS (10 Horse Power)

2.1.3 Table of system combinations

Outdoor unit	Type	Indoor unit assembly capacity	Branch pipe set (Option)
FDC100VN FDC100VS	Twin	50+50	DIS-WA1
		FDC125VN FDC125VS	
FDC140VN FDC140VS	Twin	71+71	
	Triple	50+50+50	DIS-TA1 or DIS-WA1 × 2set
FDC200VS	Twin	100+100	DIS-WB1
		71+125	
	Triple	71+71+71	DIS-TB1 or DIS-WA1 × 1set DIS-WB1 × 1set
	Double Twin	50+50+50+50	DIS-WA1 × 2set DIS-WB1 × 1set
FDC250VS	Twin	125+125	DIS-WB1
	Triple	60+60+125	DIS-TB1 or DIS-WA1 × 1set DIS-WB1 × 1set
		71+71+100	
	Double Twin	60+60+60+60	DIS-WA1 × 2set DIS-WB1 × 1set

Notes(1) Always use the branch piping set (option) at branches in the refrigerant piping.

(2) If wireless specifications are used, use 1 wireless indoor unit in combination with wired indoor units.

(3) The combinations except the above table forbids.

2.2 SPECIFICATIONS

(1) Indoor units

(a) Ceiling cassette-4way type (FDT)

Item		Model	FDT50VF
Power source			1 Phase 220-240V 50Hz / 220V 60Hz
Operation data	Sound power level	Cooling	55
		Heating	
	Sound pressure level	Cooling	P-Hi : 39 Hi : 33 Me : 31 Lo : 30
		Heating	
Silent mode sound pressure level			—
Exterior dimensions (Height × Width × Depth)		mm	Unit 246 × 840 × 840 Panel 35 × 950 × 950
Exterior appearance (Munsell color)			Plaster White (6.8Y8.9/0.2) near equivalent
Net weight		kg	UNIT 22 PANEL 5.5
Heat exchanger			Louver fin & inner grooved tubing
Fan type & Q'ty			Turbo fan ×1
Fan motor (Starting method)		W	50 < Direct line start >
Air flow	Cooling	m ³ /min	P-Hi : 20 Hi : 18 Me : 16 Lo : 14
	Heating		
Available external static pressure		Pa	0
Outside air intake			Possible
Air filter, Quality / Quantity			Pocket plastic net ×1(Washable)
Shock & vibration absorber			Rubber sleeve (for fan motor)
Operation control	Remote control		(option) wired : RC-EX1A , RC-E5 , RCH-E3 wireless : RCN-T-36W-E
	Room temperature control		Thermostat by electronics
	Operation display		—
Safety equipments			Overload protection for fan motor. Frost protection thermostat.
Installation data	Refrigerant piping size (O.D.)	mm	Liquid line: ϕ 6.35(1/4") Gas line: ϕ 12.7 (1/2")
	Connecting method		Flare piping
	Attached length of piping	m	—
	Insulation for piping		Necessary (both Liquid & Gas lines)
Drain hose			Hose connectable VP25 (O.D.32)
Drain pump, max lift height		mm	Built-in Drain pump, 700
IP number			IPX0
Standard accessories			Mounting kit, Drain hose
Option parts			—

Note (1) The data are measured at the following conditions.

The pipe length is 7.5m.

Operation	Indoor air temperature		Outdoor air temperature		Standards
	DB	WB	DB	WB	
Cooling	27°C	19°C	35°C	24°C	ISO5151-T1
Heating	20°C	—	7°C	6°C	

(2) This air-conditioner is manufactured and tested in conformity with the ISO.

(3) Sound level indicates the value in an anechoic chamber. During operation these value are somewhat higher due to ambient conditions.

(4) When wireless remote control is used, fan is 3 speed setting (Hi-Me-Lo) only.

(5) The operation data indicate when the air-conditioner is operated at 230V50Hz or 220V60Hz.

Item		Model		FDT60VF		
Power source				1 Phase 220-240V 50Hz / 220V 60Hz		
Operation data	Sound power level	Cooling	dB(A)	60		
		Heating				
	Sound pressure level	Cooling		P-Hi : 46 Hi : 33 Me : 31 Lo : 30		
		Heating				
Silent mode sound pressure level				—		
Exterior dimensions (Height × Width × Depth)		mm		Unit 246 × 840 × 840 Panel 35 × 950 × 950		
Exterior appearance (Munsell color)				Plaster White (6.8Y8.9/0.2) near equivalent		
Net weight		kg		UNIT 24 PANEL 5.5		
Heat exchanger				Louver fin & inner grooved tubing		
Fan type & Q'ty				Turbo fan ×1		
Fan motor (Starting method)		W		50 < Direct line start >		
Air flow		Cooling	m ³ /min	P-Hi : 28 Hi : 18 Me : 16 Lo : 14		
		Heating				
Available external static pressure		Pa		0		
Outside air intake				Possible		
Air filter, Quality / Quantity				Pocket plastic net ×1(Washable)		
Shock & vibration absorber				Rubber sleeve (for fan motor)		
Operation control	Remote control			(option) wired : RC-EX1A , RC-E5 , RCH-E3 wireless : RCN-T-36W-E		
	Room temperature control			Thermostat by electronics		
	Operation display			—		
Safety equipments				Overload protection for fan motor. Frost protection thermostat.		
Installation data	Refrigerant piping size (O.D.)	mm		Liquid line: ϕ 6.35(1/4") Gas line: ϕ 12.7 (1/2")		
	Connecting method			Flare piping		
	Attached length of piping	m		—		
	Insulation for piping			Necessary (both Liquid & Gas lines)		
	Drain hose			Hose connectable VP25 (O.D.32)		
Drain pump, max lift height		mm		Built-in Drain pump, 700		
IP number				IPX0		
Standard accessories				Mounting kit, Drain hose		
Option parts				—		
Note (1) The data are measured at the following conditions.				The pipe length is 7.5m.		
Item		Indoor air temperature		Outdoor air temperature		
Operation	DB	WB	DB	WB	Standards ISO5151-T1	
	Cooling	27°C	19°C	35°C		24°C
	Heating	20°C	—	7°C		6°C
(2) This air-conditioner is manufactured and tested in conformity with the ISO.						
(3) Sound level indicates the value in an anechoic chamber. During operation these value are somewhat higher due to ambient conditions.						
(4) When wireless remote control is used, fan is 3 speed setting (Hi-Me-Lo) only.						
(5) The operation data indicate when the air-conditioner is operated at 230V50Hz or 220V60Hz.						

Item		Model		FDT71VF1		
Power source				1 Phase 220-240V 50Hz / 220V 60Hz		
Operation data	Sound power level	Cooling	dB(A)	64		
		Heating				
	Sound pressure level	Cooling		P-Hi : 46 Hi : 35 Me : 33 Lo : 31		
		Heating				
Silent mode sound pressure level				—		
Exterior dimensions (Height × Width × Depth)		mm		Unit 246 × 840 × 840 Panel 35 × 950 × 950		
Exterior appearance (Munsell color)				Plaster White (6.8Y8.9/0.2) near equivalent		
Net weight		kg		UNIT 24 PANEL 5.5		
Heat exchanger				Louver fin & inner grooved tubing		
Fan type & Q'ty				Turbo fan ×1		
Fan motor (Starting method)		W		50 < Direct line start >		
Air flow		Cooling	m ³ /min	P-Hi : 28 Hi : 21 Me : 19 Lo : 17		
		Heating				
Available external static pressure		Pa		0		
Outside air intake				Possible		
Air filter, Quality / Quantity				Pocket plastic net ×1(Washable)		
Shock & vibration absorber				Rubber sleeve (for fan motor)		
Operation control	Remote control			(option) wired : RC-EX1A , RC-E5 , RCH-E3 wireless : RCN-T-36W-E		
	Room temperature control			Thermostat by electronics		
	Operation display			—		
Safety equipments				Overload protection for fan motor. Frost protection thermostat.		
Installation data	Refrigerant piping size (O.D.)	mm		Liquid line: ϕ 9.52(3/8") Gas line: ϕ 15.88 (5/8")		
	Connecting method			Flare piping		
	Attached length of piping	m		—		
	Insulation for piping			Necessary (both Liquid & Gas lines)		
	Drain hose			Hose connectable VP25 (O.D.32)		
Drain pump, max lift height		mm		Built-in Drain pump, 700		
IP number				IPX0		
Standard accessories				Mounting kit, Drain hose		
Option parts				—		
Note (1) The data are measured at the following conditions.				The pipe length is 7.5m.		
Operation	Item	Indoor air temperature		Outdoor air temperature		Standards
		DB	WB	DB	WB	
Cooling		27°C	19°C	35°C	24°C	ISO5151-T1
Heating		20°C	—	7°C	6°C	
(2) This air-conditioner is manufactured and tested in conformity with the ISO.						
(3) Sound level indicates the value in an anechoic chamber. During operation these value are somewhat higher due to ambient conditions.						
(4) When wireless remote control is used, fan is 3 speed setting (Hi-Me-Lo) only.						
(5) The operation data indicate when the air-conditioner is operated at 230V50Hz or 220V60Hz.						

Item		Model		FDT100VF1		
Power source				1 Phase 220-240V 50Hz / 220V 60Hz		
Operation data	Sound power level	Cooling	dB(A)	65		
		Heating				
	Sound pressure level	Cooling		P-Hi : 51 Hi : 40 Me : 37 Lo : 35		
		Heating				
Silent mode sound pressure level				—		
Exterior dimensions (Height × Width × Depth)		mm		Unit 298 × 840 × 840 Panel 35 × 950 × 950		
Exterior appearance (Munsell color)				Plaster White (6.8Y8.9/0.2) near equivalent		
Net weight		kg		UNIT 27 PANEL 5.5		
Heat exchanger				Louver fin & inner grooved tubing		
Fan type & Q'ty				Turbo fan ×1		
Fan motor (Starting method)		W		140 < Direct line start >		
Air flow		Cooling	m³/min	P-Hi : 37 Hi : 27 Me : 24 Lo : 20		
		Heating				
Available external static pressure		Pa		0		
Outside air intake				Possible		
Air filter, Quality / Quantity				Pocket plastic net ×1(Washable)		
Shock & vibration absorber				Rubber sleeve (for fan motor)		
Operation control	Remote control			(option) wired : RC-EX1A , RC-E5 , RCH-E3 wireless : RCN-T-36W-E		
	Room temperature control			Thermostat by electronics		
	Operation display			—		
Safety equipments				Overload protection for fan motor. Frost protection thermostat.		
Installation data	Refrigerant piping size (O.D.)	mm		Liquid line: φ 9.52(3/8") Gas line: φ 15.88 (5/8")		
	Connecting method			Flare piping		
	Attached length of piping	m		—		
	Insulation for piping			Necessary (both Liquid & Gas lines)		
	Drain hose			Hose connectable VP25 (O.D.32)		
Drain pump, max lift height		mm		Built-in Drain pump, 700		
IP number				IPX0		
Standard accessories				Mounting kit, Drain hose		
Option parts				—		
Note (1) The data are measured at the following conditions.				The pipe length is 7.5m.		
Operation	Cooling	Indoor air temperature		Outdoor air temperature		Standards ISO5151-T1
		DB	WB	DB	WB	
	27°C	19°C	35°C	24°C		
	Heating	20°C	—	7°C	6°C	

(2) This air-conditioner is manufactured and tested in conformity with the ISO.
(3) Sound level indicates the value in an anechoic chamber. During operation these value are somewhat higher due to ambient conditions.
(4) When wireless remote control is used, fan is 3 speed setting (Hi-Me-Lo) only.
(5) The operation data indicate when the air-conditioner is operated at 230V50Hz or 220V60Hz.

Item		Model		FDT100VF2			
Power source				1 Phase 220-240V 50Hz / 220V 60Hz			
Operation data	Sound power level	Cooling	dB(A)	65			
		Heating					
	Sound pressure level	Cooling		P-Hi : 51 Hi : 40 Me : 37 Lo : 35			
		Heating					
Silent mode sound pressure level				—			
Exterior dimensions (Height × Width × Depth)		mm		Unit 298 × 840 × 840 Panel 35 × 950 × 950			
Exterior appearance (Munsell color)				Plaster White (6.8Y8.9/0.2) near equivalent			
Net weight		kg		UNIT 27 PANEL 5.5			
Heat exchanger				Louver fin & inner grooved tubing			
Fan type & Q'ty				Turbo fan ×1			
Fan motor (Starting method)		W		140 < Direct line start >			
Air flow		Cooling	m ³ /min	P-Hi : 37 Hi : 27 Me : 24 Lo : 20			
		Heating					
Available external static pressure		Pa		0			
Outside air intake				Possible			
Air filter, Quality / Quantity				Pocket plastic net ×1(Washable)			
Shock & vibration absorber				Rubber sleeve (for fan motor)			
Operation control	Remote control			(option) wired : RC-EX1A , RC-E5 , RCH-E3 wireless : RCN-T-36W-E			
	Room temperature control			Thermostat by electronics			
	Operation display			—			
Safety equipments				Overload protection for fan motor. Frost protection thermostat.			
Installation data	Refrigerant piping size (O.D.)	mm		Liquid line: ϕ 9.52(3/8") Gas line: ϕ 15.88 (5/8")			
	Connecting method			Flare piping			
	Attached length of piping	m		—			
	Insulation for piping			Necessary (both Liquid & Gas lines)			
	Drain hose			Hose connectable VP25 (O.D.32)			
Drain pump, max lift height		mm		Built-in Drain pump, 700			
IP number				IPX0			
Standard accessories				Mounting kit, Drain hose			
Option parts				—			
Note (1) The data are measured at the following conditions.				The pipe length is 7.5m.			
Operation	Item	Indoor air temperature		Outdoor air temperature		Standards	
		DB	WB	DB	WB		
	Cooling	27°C	19°C	35°C	24°C		ISO5151-T1
	Heating	20°C	—	7°C	6°C		
(2) This air-conditioner is manufactured and tested in conformity with the ISO.							
(3) Sound level indicates the value in an anechoic chamber. During operation these value are somewhat higher due to ambient conditions.							
(4) When wireless remote control is used, fan is 3 speed setting (Hi-Me-Lo) only.							
(5) The operation data indicate when the air-conditioner is operated at 230V50Hz or 220V60Hz.							

Item		Model		FDT125VF		
Power source				1 Phase 220-240V 50Hz / 220V 60Hz		
Operation data	Sound power level	Cooling	dB(A)	68		
		Heating		P-Hi : 51 Hi : 42 Me : 40 Lo : 37		
	Sound pressure level			Cooling	—	
Silent mode sound pressure level		Heating				
Exterior dimensions (Height × Width × Depth)		mm		Unit 298 × 840 × 840 Panel 35 × 950 × 950		
Exterior appearance (Munsell color)				Plaster White (6.8Y8.9/0.2) near equivalent		
Net weight		kg		UNIT 27 PANEL 5.5		
Heat exchanger				Louver fin & inner grooved tubing		
Fan type & Q'ty				Turbo fan ×1		
Fan motor (Starting method)		W		140 < Direct line start >		
Air flow		Cooling	m ³ /min	P-Hi : 37 Hi : 30 Me : 27 Lo : 23		
		Heating				
Available external static pressure		Pa		0		
Outside air intake				Possible		
Air filter, Quality / Quantity				Pocket plastic net ×1(Washable)		
Shock & vibration absorber				Rubber sleeve (for fan motor)		
Operation control	Remote control				(option) wired : RC-EX1A , RC-E5 , RCH-E3 wireless : RCN-T-36W-E	
	Room temperature control				Thermostat by electronics	
	Operation display				—	
Safety equipments				Overload protection for fan motor. Frost protection thermostat.		
Installation data	Refrigerant piping size (O.D.)	mm		Liquid line: ϕ 9.52(3/8") Gas line: ϕ 15.88 (5/8")		
	Connecting method			Flare piping		
	Attached length of piping	m		—		
	Insulation for piping			Necessary (both Liquid & Gas lines)		
	Drain hose			Hose connectable VP25 (O.D.32)		
Drain pump, max lift height		mm		Built-in Drain pump, 700		
IP number				IPX0		
Standard accessories				Mounting kit, Drain hose		
Option parts				—		
Note (1) The data are measured at the following conditions.				The pipe length is 7.5m.		
Item		Indoor air temperature		Outdoor air temperature		
Operation	DB	WB	DB	WB	Standards ISO5151-T1	
	Cooling	27°C	19°C	35°C		24°C
	Heating	20°C	—	7°C		6°C
(2) This air-conditioner is manufactured and tested in conformity with the ISO.						
(3) Sound level indicates the value in an anechoic chamber. During operation these value are somewhat higher due to ambient conditions.						
(4) When wireless remote control is used, fan is 3 speed setting (Hi-Me-Lo) only.						
(5) The operation data indicate when the air-conditioner is operated at 230V50Hz or 220V60Hz.						

(b) Ceiling suspended type (FDEN)

Item		Model		FDEN50VF	
Power source				1 Phase 220-240V 50Hz / 220V 60Hz	
Operation data	Sound power level	Cooling	dB(A)	60	
		Heating			
	Sound pressure level	Cooling		P-Hi : 46 Hi : 39 Me : 38 Lo : 37	
	Silent mode sound pressure level	Heating	—		
Exterior dimensions (Height × Width × Depth)		mm		210 × 1,070 × 690	
Exterior appearance (Munsell color)				Plaster White (6.8Y8.9/0.2) near equivalent	
Net weight		kg		28	
Heat exchanger				Louver fin & inner grooved tubing	
Fan type & Q'ty				Centrifugal fan x2	
Fan motor (Starting method)		W		25 < Direct line start >	
Air flow		Cooling	m ³ /min	P-Hi : 11 Hi : 10 Me : 9 Lo : 7	
		Heating			
Available external static pressure		Pa		0	
Outside air intake				Not possible	
Air filter, Quality / Quantity				Pocket plastic net x2 (Washable)	
Shock & vibration absorber				Rubber sleeve (for fan motor)	
Operation control	Remote control			(option) wired : RC-EX1A , RC-E5 , RCH-E3 wireless : RCN-E1R	
	Room temperature control			Thermostat by electronics	
	Operation display			RUN: Green, TIMER: Yellow, CHECK: Yellow	
Safety equipments				Internal thermostat for fan motor. Frost protection thermostat.	
Installation data	Refrigerant piping size (O.D.)	mm		Liquid line: ϕ 6.35 (1/4") Gas line: ϕ 12.7 (1/2")	
	Connecting method			Flare piping	
	Attached length of piping	m		—	
	Insulation for piping			Necessary (both Liquid & Gas lines)	
Drain hose				Hose connectable VP20 (O.D.26)	
Drain pump, max lift height		mm		—	
IP number				IPX0	
Standard accessories				Mounting kit, Drain hose	
Option parts				—	
Note (1) The data are measured at the following conditions.			The pipe length is 7.5m.		
	Item	Indoor air temperature		Outdoor air temperature	
Operation		DB	WB	DB	WB
	Cooling	27°C	19°C	35°C	24°C
	Heating	20°C	—	7°C	6°C
		Standards			
		ISO5151-T1			
(2) This air-conditioner is manufactured and tested in conformity with the ISO.					
(3) Sound level indicates the value in an anechoic chamber. During operation these value are somewhat higher due to ambient conditions.					
(4) When wireless remote control is used, fan is 3 speed setting (Hi-Me-Lo) only.					
(5) The operation data indicate when the air-conditioner is operated at 230V50Hz or 220V60Hz.					

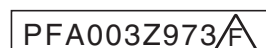

Item		Model	FDEN60VF			
Power source			1 Phase 220-240V 50Hz / 220V 60Hz			
Operation data	Sound power level	Cooling Heating	dB(A)	60		
	Sound pressure level	Cooling Heating		P-Hi : 48 Hi : 41 Me : 39 Lo : 38		
	Silent mode sound pressure level			—		
Exterior dimensions (Height × Width × Depth)		mm	210 × 1,320 × 690			
Exterior appearance (Munsell color)			Plaster White (6.8Y8.9/0.2) near equivalent			
Net weight		kg	37			
Heat exchanger			Louver fin & inner grooved tubing			
Fan type & Q'ty			Centrifugal fan ×4			
Fan motor (Starting method)		W	20×2 < Direct line start >			
Air flow		Cooling	m ³ /min	P-Hi : 20 Hi : 16 Me : 14 Lo : 12		
		Heating				
Available external static pressure		Pa	0			
Outside air intake			Not possible			
Air filter, Quality / Quantity			Pocket plastic net ×2 (Washable)			
Shock & vibration absorber			Rubber sleeve (for fan motor)			
Operation control	Remote control		(option) wired : RC-EX1A , RC-E5 , RCH-E3 wireless : RCN-E1R			
	Room temperature control		Thermostat by electronics			
	Operation display		RUN: Green, TIMER: Yellow, CHECK: Yellow			
Safety equipments			Internal thermostat for fan motor. Frost protection thermostat.			
Installation data	Refrigerant piping size (O.D.)	mm	Liquid line: ϕ 6.35 (1/4") Gas line: ϕ 12.7 (1/2")			
	Connecting method		Flare piping			
	Attached length of piping	m	—			
	Insulation for piping		Necessary (both Liquid & Gas lines)			
Drain hose			Hose connectable VP20 (O.D.26)			
Drain pump, max lift height		mm	—			
IP number			IPX0			
Standard accessories			Mounting kit, Drain hose			
Option parts			—			
Note (1) The data are measured at the following conditions.			The pipe length is 7.5m.			
	Item	Indoor air temperature		Outdoor air temperature		Standards ISO5151-T1
Operation		DB	WB	DB	WB	
	Cooling	27°C	19°C	35°C	24°C	
	Heating	20°C	—	7°C	6°C	
<p>(2) This air-conditioner is manufactured and tested in conformity with the ISO.</p> <p>(3) Sound level indicates the value in an anechoic chamber. During operation these value are somewhat higher due to ambient conditions.</p> <p>(4) When wireless remote control is used, fan is 3 speed setting (Hi-Me-Lo) only.</p> <p>(5) The operation data indicate when the air-conditioner is operated at 230V50Hz or 220V60Hz.</p>						

Item		Model		FDEN71VF1	
Power source				1 Phase 220-240V 50Hz / 220V 60Hz	
Operation data	Sound power level	Cooling	dB(A)	62	
		Heating			
	Sound pressure level	Cooling		P-Hi : 50 Hi : 41 Me : 39 Lo : 38	
		Heating			
Silent mode sound pressure level				—	
Exterior dimensions (Height × Width × Depth)		mm		210 × 1,320 × 690	
Exterior appearance (Munsell color)				Plaster White (6.8Y8.9/0.2) near equivalent	
Net weight		kg		37	
Heat exchanger				Louver fin & inner grooved tubing	
Fan type & Q'ty				Centrifugal fan ×4	
Fan motor (Starting method)		W		20×2 < Direct line start >	
Air flow		Cooling	m³/min	P-Hi : 20 Hi : 16 Me : 14 Lo : 12	
		Heating			
Available external static pressure		Pa		0	
Outside air intake				Not possible	
Air filter, Quality / Quantity				Pocket plastic net ×2 (Washable)	
Shock & vibration absorber				Rubber sleeve (for fan motor)	
Operation control	Remote control			(option) wired : RC-EX1A , RC-E5 , RCH-E3 wireless : RCN-E1R	
	Room temperature control			Thermostat by electronics	
	Operation display			RUN: Green, TIMER: Yellow, CHECK: Yellow	
Safety equipments				Internal thermostat for fan motor. Frost protection thermostat.	
Installation data	Refrigerant piping size (O.D.)	mm		Liquid line: φ 9.52 (3/8") Gas line: φ 15.88 (5/8")	
	Connecting method			Flare piping	
	Attached length of piping	m		—	
	Insulation for piping			Necessary (both Liquid & Gas lines)	
Drain hose				Hose connectable VP20 (O.D.26)	
Drain pump, max lift height		mm		—	
IP number				IPX0	
Standard accessories				Mounting kit, Drain hose	
Option parts				—	
Note (1) The data are measured at the following conditions.				The pipe length is 7.5m.	
Item	Indoor air temperature		Outdoor air temperature		Standards
Operation	DB	WB	DB	WB	
Cooling	27°C	19°C	35°C	24°C	
Heating	20°C	—	7°C	6°C	
<p>(2) This air-conditioner is manufactured and tested in conformity with the ISO.</p> <p>(3) Sound level indicates the value in an anechoic chamber. During operation these value are somewhat higher due to ambient conditions.</p> <p>(4) When wireless remote control is used, fan is 3 speed setting (Hi-Me-Lo) only.</p> <p>(5) The operation data indicate when the air-conditioner is operated at 400V50Hz or 380V60Hz.</p>					

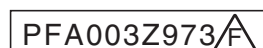

Item		Model		FDEN100VF1	
Power source				1 Phase 220-240V 50Hz / 220V 60Hz	
Operation data	Sound power level	Cooling	dB(A)	64	
		Heating			
	Sound pressure level	Cooling		P-Hi : 46 Hi : 44 Me : 41 Lo : 39	
		Heating			
Silent mode sound pressure level				—	
Exterior dimensions (Height × Width × Depth)		mm		250 × 1,620 × 690	
Exterior appearance (Munsell color)				Plaster White (6.8Y8.9/0.2) near equivalent	
Net weight		kg		49	
Heat exchanger				Louver fin & inner grooved tubing	
Fan type & Q'ty				Centrifugal fan ×4	
Fan motor (Starting method)		W		30×2 < Direct line start >	
Air flow		Cooling	m³/min	P-Hi : 28 Hi : 26 Me : 23 Lo : 21	
		Heating			
Available external static pressure		Pa		0	
Outside air intake				Not possible	
Air filter, Quality / Quantity				Pocket plastic net ×2 (Washable)	
Shock & vibration absorber				Rubber sleeve (for fan motor)	
Operation control	Remote control			(option) wired : RC-EX1A , RC-E5 , RCH-E3 wireless : RCN-E1R	
	Room temperature control			Thermostat by electronics	
	Operation display			RUN: Green, TIMER: Yellow, CHECK: Yellow	
Safety equipments				Internal thermostat for fan motor. Frost protection thermostat.	
Installation data	Refrigerant piping size (O.D.)	mm		Liquid line: φ 9.52 (3/8") Gas line: φ 15.88 (5/8")	
	Connecting method			Flare piping	
	Attached length of piping	m		—	
	Insulation for piping			Necessary (both Liquid & Gas lines)	
Drain hose				Hose connectable VP20 (O.D.26)	
Drain pump, max lift height		mm		—	
IP number				IPX0	
Standard accessories				Mounting kit, Drain hose	
Option parts				—	
Note (1) The data are measured at the following conditions.				The pipe length is 7.5m.	
Item		Indoor air temperature		Outdoor air temperature	
Operation		DB	WB	DB	WB
	Cooling	27°C	19°C	35°C	24°C
	Heating	20°C	—	7°C	6°C
				Standards	
				ISO5151-T1	
(2) This air-conditioner is manufactured and tested in conformity with the ISO.					
(3) Sound level indicates the value in an anechoic chamber. During operation these value are somewhat higher due to ambient conditions.					
(4) When wireless remote control is used, fan is 3 speed setting (Hi-Me-Lo) only.					
(5) The operation data indicate when the air-conditioner is operated at 230V50Hz or 220V60Hz.					

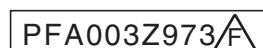

Item		Model	FDEN125VF		
Power source			1 Phase 220-240V 50Hz / 220V 60Hz		
Operation data	Sound power level	Cooling Heating	dB(A)	67	
	Sound pressure level	Cooling Heating		P-Hi : 50 Hi : 46 Me : 44 Lo : 43	
	Silent mode sound pressure level			—	
Exterior dimensions (Height × Width × Depth)		mm	250 × 1,620 × 690		
Exterior appearance (Munsell color)			Plaster White (6.8Y8.9/0.2) near equivalent		
Net weight		kg	49		
Heat exchanger			Louver fin & inner grooved tubing		
Fan type & Q'ty			Centrifugal fan ×4		
Fan motor (Starting method)		W	40×2 < Direct line start >		
Air flow		Cooling	m ³ /min	P-Hi : 32 Hi : 29 Me : 26 Lo : 23	
		Heating			
Available external static pressure		Pa	0		
Outside air intake			Not possible		
Air filter, Quality / Quantity			Pocket plastic net ×2 (Washable)		
Shock & vibration absorber			Rubber sleeve (for fan motor)		
Operation control	Remote control		(option) wired : RC-EX1A , RC-E5 , RCH-E3 wireless : RCN-E1R		
	Room temperature control		Thermostat by electronics		
	Operation display		RUN: Green, TIMER: Yellow, CHECK: Yellow		
Safety equipments			Internal thermostat for fan motor. Frost protection thermostat.		
Installation data	Refrigerant piping size (O.D.)	mm	Liquid line: φ 9.52 (3/8") Gas line: φ 15.88 (5/8")		
	Connecting method		Flare piping		
	Attached length of piping	m	—		
	Insulation for piping		Necessary (both Liquid & Gas lines)		
Drain hose			Hose connectable VP20 (O.D.26)		
Drain pump, max lift height		mm	—		
IP number			IPX0		
Standard accessories			Mounting kit, Drain hose		
Option parts			—		
Note (1) The data are measured at the following conditions.			The pipe length is 7.5m.		
Item	Indoor air temperature		Outdoor air temperature		Standards
Operation	DB	WB	DB	WB	
Cooling	27°C	19°C	35°C	24°C	
Heating	20°C	—	7°C	6°C	
(2) This air-conditioner is manufactured and tested in conformity with the ISO.					
(3) Sound level indicates the value in an anechoic chamber. During operation these value are somewhat higher due to ambient conditions.					
(4) When wireless remote control is used, fan is 3 speed setting (Hi-Me-Lo) only.					
(5) The operation data indicate when the air-conditioner is operated at 230V50Hz or 220V60Hz.					

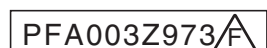

(2) Outdoor units

Item		Model	FDC100VN																					
Power source			1 Phase 220-240V 50Hz / 220V 60Hz																					
Operation data	Nominal cooling capacity (range)	kW	10.0 [4.0(Min.)~11.2(Max.)]																					
	Nominal heating capacity (range)	kW	11.2 [4.0(Min.)~12.5(Max.)]																					
	Sound power level	Cooling	dB(A)	70																				
		Heating																						
	Sound pressure level	Cooling	49																					
Heating																								
Silent mode sound pressure level			Cooling : 46 / Heating : 46																					
Exterior dimensions (Height × Width × Depth)		mm	845×970×370																					
Exterior appearance (Munsell color)			Stucco White (4.2Y7.5/1.1) near equivalent																					
Net weight		kg	81																					
Compressor type & Q'ty			RMT5126MDE2×1																					
Compressor motor (Starting method)		kW	Direct line start																					
Refrigerant oil (Amount, type)		ℓ	0.9 M-MA68																					
Refrigerant (Type, amount, pre-charge length)		kg	R410A 3.8kg in outdoor unit (incl. the amount for the piping of : 30m)																					
Heat exchanger			Straight fin & inner grooved tubing																					
Refrigerant control			Electronic expansion valve																					
Fan type & Q'ty			Propeller fan ×1																					
Fan motor (Starting method)		W	86 < Direct line start >																					
Air flow	Cooling	m ³ /min	75																					
	Heating		73																					
Shock & vibration absorber			Rubber sleeve (for compressor)																					
Electric heater		W	20 (Crank case heater)																					
Safety equipments			Internal thermostat for fan motor. Abnormal discharge temperature protection.																					
Installation data	Refrigerant piping size (O.D.)	mm	Liquid line: φ 9.52 (3/8") Gas line: φ 15.88 (5/8")																					
	Connecting method		Flare piping																					
	Attached length of piping	m	—																					
	Insulation for piping		Necessary (both Liquid & Gas lines)																					
	Refrigerant line (one way) length	m	Max.50m																					
	Vertical height diff. between O.U. and I.U.	m	Max.30m (Outdoor unit is higher) Max.15m (Outdoor unit is lower)																					
Drain hose			Holes size φ 20 × 3pcs																					
IP number			IP24																					
Standard accessories			Edging																					
Option parts			—																					
Note (1) The data are measured at the following conditions.			The pipe length is 7.5m.																					
<table border="1"> <thead> <tr> <th rowspan="2">Operation</th> <th colspan="2">Indoor air temperature</th> <th colspan="2">Outdoor air temperature</th> <th rowspan="2">Standards</th> </tr> <tr> <th>DB</th> <th>WB</th> <th>DB</th> <th>WB</th> </tr> </thead> <tbody> <tr> <td>Cooling</td> <td>27°C</td> <td>19°C</td> <td>35°C</td> <td>24°C</td> <td rowspan="2">ISO5151-T1</td> </tr> <tr> <td>Heating</td> <td>20°C</td> <td>—</td> <td>7°C</td> <td>6°C</td> </tr> </tbody> </table>		Operation	Indoor air temperature		Outdoor air temperature		Standards	DB	WB	DB	WB	Cooling	27°C	19°C	35°C	24°C	ISO5151-T1	Heating	20°C	—	7°C	6°C		
Operation	Indoor air temperature		Outdoor air temperature		Standards																			
	DB	WB	DB	WB																				
Cooling	27°C	19°C	35°C	24°C	ISO5151-T1																			
Heating	20°C	—	7°C	6°C																				
(2) This air-conditioner is manufactured and tested in conformity with the ISO.																								
(3) Sound level indicates the value in an anechoic chamber. During operation these value are somewhat higher due to ambient conditions.																								
(4) The operation data indicate when the air-conditioner is operated at 230V50Hz or 220V60Hz.																								

Item		Model	FDC100VS																					
Power source			3 Phase 380-415V 50Hz / 380V 60Hz																					
Operation data	Nominal cooling capacity (range)	kW	10.0 [4.0(Min.)~11.2(Max.)]																					
	Nominal heating capacity (range)	kW	11.2 [4.0(Min.)~12.5(Max.)]																					
	Sound power level	Cooling	dB(A)	70																				
		Heating																						
	Sound pressure level	Cooling	49																					
Heating																								
Silent mode sound pressure level			Cooling : 46 / Heating : 46																					
Exterior dimensions (Height × Width × Depth)		mm	845×970×370																					
Exterior appearance (Munsell color)			Stucco White (4.2Y7.5/1.1) near equivalent																					
Net weight		kg	83																					
Compressor type & Q'ty			RMT5126MDE3×1																					
Compressor motor (Starting method)		kW	Direct line start																					
Refrigerant oil (Amount, type)		ℓ	0.9 M-MA68																					
Refrigerant (Type, amount, pre-charge length)		kg	R410A 3.8kg in outdoor unit (incl. the amount for the piping of : 30m)																					
Heat exchanger			Straight fin & inner grooved tubing																					
Refrigerant control			Electronic expansion valve																					
Fan type & Q'ty			Propeller fan ×1																					
Fan motor (Starting method)		W	86 < Direct line start >																					
Air flow	Cooling Heating	m ³ /min	75																					
			73																					
Shock & vibration absorber			Rubber sleeve (for compressor)																					
Electric heater		W	20 (Crank case heater)																					
Safety equipments			Internal thermostat for fan motor. Abnormal discharge temperature protection.																					
Installation data	Refrigerant piping size (O.D.)	mm	Liquid line: φ 9.52 (3/8") Gas line: φ 15.88 (5/8")																					
	Connecting method		Flare piping																					
	Attached length of piping	m	—																					
	Insulation for piping		Necessary (both Liquid & Gas lines)																					
	Refrigerant line (one way) length	m	Max.50m																					
	Vertical height diff. between O.U. and I.U.	m	Max.30m (Outdoor unit is higher) Max.15m (Outdoor unit is lower)																					
Drain hose			Holes size φ 20 × 3pcs																					
IP number			IP24																					
Standard accessories			Edging																					
Option parts			—																					
Note (1) The data are measured at the following conditions.			The pipe length is 7.5m.																					
<table border="1"> <thead> <tr> <th rowspan="2">Operation</th> <th colspan="2">Indoor air temperature</th> <th colspan="2">Outdoor air temperature</th> <th rowspan="2">Standards</th> </tr> <tr> <th>DB</th> <th>WB</th> <th>DB</th> <th>WB</th> </tr> </thead> <tbody> <tr> <td>Cooling</td> <td>27°C</td> <td>19°C</td> <td>35°C</td> <td>24°C</td> <td rowspan="2">ISO5151-T1</td> </tr> <tr> <td>Heating</td> <td>20°C</td> <td>—</td> <td>7°C</td> <td>6°C</td> </tr> </tbody> </table>		Operation	Indoor air temperature		Outdoor air temperature		Standards	DB	WB	DB	WB	Cooling	27°C	19°C	35°C	24°C	ISO5151-T1	Heating	20°C	—	7°C	6°C		
Operation	Indoor air temperature		Outdoor air temperature		Standards																			
	DB	WB	DB	WB																				
Cooling	27°C	19°C	35°C	24°C	ISO5151-T1																			
Heating	20°C	—	7°C	6°C																				
(2) This air-conditioner is manufactured and tested in conformity with the ISO.																								
(3) Sound level indicates the value in an anechoic chamber. During operation these value are somewhat higher due to ambient conditions.																								
(4) The operation data indicate when the air-conditioner is operated at 400V50Hz or 380V60Hz.																								

Item		Model	FDC125VN																					
Power source			1 Phase 220-240V 50Hz / 220V 60Hz																					
Operation data	Nominal cooling capacity (range)	kW	12.5 [5.0(Min.)~14.0(Max.)]																					
	Nominal heating capacity (range)	kW	14.0 [4.0(Min.)~16.0(Max.)]																					
	Sound power level	Cooling	dB(A)	72																				
		Heating		50																				
	Sound pressure level	Cooling		51																				
Heating		Cooling : 46 / Heating : 48																						
Silent mode sound pressure level																								
Exterior dimensions (Height × Width × Depth)		mm	845×970×370																					
Exterior appearance (Munsell color)			Stucco White (4.2Y7.5/1.1) near equivalent																					
Net weight		kg	81																					
Compressor type & Q'ty			RMT5126MDE2×1																					
Compressor motor (Starting method)		kW	Direct line start																					
Refrigerant oil (Amount, type)		ℓ	0.9 M-MA68																					
Refrigerant (Type, amount, pre-charge length)		kg	R410A 3.8kg in outdoor unit (incl. the amount for the piping of : 30m)																					
Heat exchanger			Straight fin & inner grooved tubing																					
Refrigerant control			Electronic expansion valve																					
Fan type & Q'ty			Propeller fan ×1																					
Fan motor (Starting method)		W	86 < Direct line start >																					
Air flow	Cooling Heating	m ³ /min	75																					
			73																					
Shock & vibration absorber			Rubber sleeve (for compressor)																					
Electric heater		W	20 (Crank case heater)																					
Safety equipments			Internal thermostat for fan motor. Abnormal discharge temperature protection.																					
Installation data	Refrigerant piping size (O.D.)	mm	Liquid line: φ 9.52 (3/8") Gas line: φ 15.88 (5/8")																					
	Connecting method		Flare piping																					
	Attached length of piping	m	—																					
	Insulation for piping		Necessary (both Liquid & Gas lines)																					
	Refrigerant line (one way) length	m	Max.50m																					
	Vertical height diff. between O.U. and I.U.	m	Max.30m (Outdoor unit is higher) Max.15m (Outdoor unit is lower)																					
Drain hose			Holes size φ 20 × 3pcs																					
IP number			IP24																					
Standard accessories			Edging																					
Option parts			—																					
Note (1) The data are measured at the following conditions.			The pipe length is 7.5m.																					
<table border="1"> <thead> <tr> <th rowspan="2">Operation</th> <th colspan="2">Indoor air temperature</th> <th colspan="2">Outdoor air temperature</th> <th rowspan="2">Standards</th> </tr> <tr> <th>DB</th> <th>WB</th> <th>DB</th> <th>WB</th> </tr> </thead> <tbody> <tr> <td>Cooling</td> <td>27°C</td> <td>19°C</td> <td>35°C</td> <td>24°C</td> <td rowspan="2">ISO5151-T1</td> </tr> <tr> <td>Heating</td> <td>20°C</td> <td>—</td> <td>7°C</td> <td>6°C</td> </tr> </tbody> </table>		Operation	Indoor air temperature		Outdoor air temperature		Standards	DB	WB	DB	WB	Cooling	27°C	19°C	35°C	24°C	ISO5151-T1	Heating	20°C	—	7°C	6°C		
Operation	Indoor air temperature		Outdoor air temperature		Standards																			
	DB	WB	DB	WB																				
Cooling	27°C	19°C	35°C	24°C	ISO5151-T1																			
Heating	20°C	—	7°C	6°C																				
(2) This air-conditioner is manufactured and tested in conformity with the ISO.																								
(3) Sound level indicates the value in an anechoic chamber. During operation these value are somewhat higher due to ambient conditions.																								
(4) The operation data indicate when the air-conditioner is operated at 230V50Hz or 220V60Hz.																								

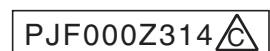

Item		Model	FDC125VS																					
Power source			3 Phase 380-415V 50Hz / 380V 60Hz																					
Operation data	Nominal cooling capacity (range)	kW	12.5 [5.0(Min.)~14.0(Max.)]																					
	Nominal heating capacity (range)	kW	14.0 [4.0(Min.)~16.0(Max.)]																					
	Sound power level	Cooling	dB(A)	72																				
		Heating		50																				
	Sound pressure level	Cooling		51																				
Heating		Cooling : 46 / Heating : 48																						
Silent mode sound pressure level																								
Exterior dimensions (Height × Width × Depth)		mm	845×970×370																					
Exterior appearance (Munsell color)			Stucco White (4.2Y7.5/1.1) near equivalent																					
Net weight		kg	83																					
Compressor type & Q'ty			RMT5126MDE3×1																					
Compressor motor (Starting method)		kW	Direct line start																					
Refrigerant oil (Amount, type)		ℓ	0.9 M-MA68																					
Refrigerant (Type, amount, pre-charge length)		kg	R410A 3.8kg in outdoor unit (incl. the amount for the piping of : 30m)																					
Heat exchanger			Straight fin & inner grooved tubing																					
Refrigerant control			Electronic expansion valve																					
Fan type & Q'ty			Propeller fan ×1																					
Fan motor (Starting method)		W	86 < Direct line start >																					
Air flow	Cooling	m ³ /min	75																					
	Heating		73																					
Shock & vibration absorber			Rubber sleeve (for compressor)																					
Electric heater		W	20 (Crank case heater)																					
Safety equipments			Internal thermostat for fan motor. Abnormal discharge temperature protection.																					
Installation data	Refrigerant piping size (O.D.)	mm	Liquid line: φ 9.52 (3/8") Gas line: φ 15.88 (5/8")																					
	Connecting method		Flare piping																					
	Attached length of piping	m	—																					
	Insulation for piping		Necessary (both Liquid & Gas lines)																					
	Refrigerant line (one way) length	m	Max.50m																					
	Vertical height diff. between O.U. and I.U.	m	Max.30m (Outdoor unit is higher) Max.15m (Outdoor unit is lower)																					
Drain hose			Holes size φ 20 × 3pcs																					
IP number			IP24																					
Standard accessories			Edging																					
Option parts			—																					
Note (1) The data are measured at the following conditions.			The pipe length is 7.5m.																					
<table border="1"> <thead> <tr> <th rowspan="2">Operation</th> <th colspan="2">Indoor air temperature</th> <th colspan="2">Outdoor air temperature</th> <th rowspan="2">Standards</th> </tr> <tr> <th>DB</th> <th>WB</th> <th>DB</th> <th>WB</th> </tr> </thead> <tbody> <tr> <td>Cooling</td> <td>27°C</td> <td>19°C</td> <td>35°C</td> <td>24°C</td> <td rowspan="2">ISO5151-T1</td> </tr> <tr> <td>Heating</td> <td>20°C</td> <td>—</td> <td>7°C</td> <td>6°C</td> </tr> </tbody> </table>		Operation	Indoor air temperature		Outdoor air temperature		Standards	DB	WB	DB	WB	Cooling	27°C	19°C	35°C	24°C	ISO5151-T1	Heating	20°C	—	7°C	6°C		
Operation	Indoor air temperature		Outdoor air temperature		Standards																			
	DB	WB	DB	WB																				
Cooling	27°C	19°C	35°C	24°C	ISO5151-T1																			
Heating	20°C	—	7°C	6°C																				
(2) This air-conditioner is manufactured and tested in conformity with the ISO.																								
(3) Sound level indicates the value in an anechoic chamber. During operation these value are somewhat higher due to ambient conditions.																								
(4) The operation data indicate when the air-conditioner is operated at 400V50Hz or 380V60Hz.																								

Item		Model	FDC140VN		
Power source			1 Phase 220-240V 50Hz / 220V 60Hz		
Operation data	Nominal cooling capacity (range)	kW	14.0 [5.0(Min.)~14.5(Max.)]		
	Nominal heating capacity (range)	kW	16.0 [4.0(Min.)~16.5(Max.)]		
	Sound power level	Cooling	dB(A)	73	
		Heating			
	Sound pressure level	Cooling	51		
Heating					
Silent mode sound pressure level			Cooling : 47 / Heating : 50		
Exterior dimensions (Height × Width × Depth)		mm	845×970×370		
Exterior appearance (Munsell color)			Stucco White (4.2Y7.5/1.1) near equivalent		
Net weight		kg	81		
Compressor type & Q'ty			RMT5126MDE2×1		
Compressor motor (Starting method)		kW	Direct line start		
Refrigerant oil (Amount, type)		ℓ	0.9 M-MA68		
Refrigerant (Type, amount, pre-charge length)		kg	R410A 3.8kg in outdoor unit (incl. the amount for the piping of : 30m)		
Heat exchanger			Straight fin & inner grooved tubing		
Refrigerant control			Electronic expansion valve		
Fan type & Q'ty			Propeller fan ×1		
Fan motor (Starting method)		W	86 < Direct line start >		
Air flow	Cooling Heating	m ³ /min	75		
			73		
Shock & vibration absorber			Rubber sleeve (for compressor)		
Electric heater		W	20 (Crank case heater)		
Safety equipments			Internal thermostat for fan motor. Abnormal discharge temperature protection.		
Installation data	Refrigerant piping size (O.D.)	mm	Liquid line: φ 9.52 (3/8") Gas line: φ 15.88 (5/8")		
	Connecting method		Flare piping		
	Attached length of piping	m	—		
	Insulation for piping		Necessary (both Liquid & Gas lines)		
	Refrigerant line (one way) length	m	Max.50m		
	Vertical height diff. between O.U. and I.U.	m	Max.30m (Outdoor unit is higher) Max.15m (Outdoor unit is lower)		
Drain hose			Holes size φ 20 × 3pcs		
IP number			IP24		
Standard accessories			Edging		
Option parts			—		
Note (1) The data are measured at the following conditions.			The pipe length is 7.5m.		
Operation	Indoor air temperature	Outdoor air temperature		Standards	
Cooling	DB	WB	DB		WB
	27°C	19°C	35°C		24°C
Heating	20°C	—	7°C	6°C	
ISO5151-T1					
(2) This air-conditioner is manufactured and tested in conformity with the ISO.					
(3) Sound level indicates the value in an anechoic chamber. During operation these value are somewhat higher due to ambient conditions.					
(4) The operation data indicate when the air-conditioner is operated at 230V50Hz or 220V60Hz.					

Item		Model	FDC140VS																					
Power source			3 Phase 380-415V 50Hz / 380V 60Hz																					
Operation data	Nominal cooling capacity (range)	kW	14.0 [5.0(Min.)~14.5(Max.)]																					
	Nominal heating capacity (range)	kW	16.0 [4.0(Min.)~16.5(Max.)]																					
	Sound power level	Cooling	dB(A)	73																				
		Heating																						
	Sound pressure level	Cooling	51																					
Heating																								
Silent mode sound pressure level			Cooling : 47 / Heating : 50																					
Exterior dimensions (Height × Width × Depth)		mm	845×970×370																					
Exterior appearance (Munsell color)			Stucco White (4.2Y7.5/1.1) near equivalent																					
Net weight		kg	83																					
Compressor type & Q'ty			RMT5126MDE3×1																					
Compressor motor (Starting method)		kW	Direct line start																					
Refrigerant oil (Amount, type)		ℓ	0.9 M-MA68																					
Refrigerant (Type, amount, pre-charge length)		kg	R410A 3.8kg in outdoor unit (incl. the amount for the piping of : 30m)																					
Heat exchanger			Straight fin & inner grooved tubing																					
Refrigerant control			Electronic expansion valve																					
Fan type & Q'ty			Propeller fan ×1																					
Fan motor (Starting method)		W	86 < Direct line start >																					
Air flow	Cooling Heating	m ³ /min	75																					
			73																					
Shock & vibration absorber			Rubber sleeve (for compressor)																					
Electric heater		W	20 (Crank case heater)																					
Safety equipments			Internal thermostat for fan motor. Abnormal discharge temperature protection.																					
Installation data	Refrigerant piping size (O.D.)	mm	Liquid line: φ 9.52 (3/8") Gas line: φ 15.88 (5/8")																					
	Connecting method		Flare piping																					
	Attached length of piping	m	—																					
	Insulation for piping		Necessary (both Liquid & Gas lines)																					
	Refrigerant line (one way) length	m	Max.50m																					
	Vertical height diff. between O.U. and I.U.	m	Max.30m (Outdoor unit is higher) Max.15m (Outdoor unit is lower)																					
Drain hose			Holes size φ 20 × 3pcs																					
IP number			IP24																					
Standard accessories			Edging																					
Option parts			—																					
Note (1) The data are measured at the following conditions.			The pipe length is 7.5m.																					
<table border="1"> <thead> <tr> <th rowspan="2">Operation</th> <th colspan="2">Indoor air temperature</th> <th colspan="2">Outdoor air temperature</th> <th rowspan="2">Standards</th> </tr> <tr> <th>DB</th> <th>WB</th> <th>DB</th> <th>WB</th> </tr> </thead> <tbody> <tr> <td>Cooling</td> <td>27°C</td> <td>19°C</td> <td>35°C</td> <td>24°C</td> <td rowspan="2">ISO5151-T1</td> </tr> <tr> <td>Heating</td> <td>20°C</td> <td>—</td> <td>7°C</td> <td>6°C</td> </tr> </tbody> </table>		Operation	Indoor air temperature		Outdoor air temperature		Standards	DB	WB	DB	WB	Cooling	27°C	19°C	35°C	24°C	ISO5151-T1	Heating	20°C	—	7°C	6°C		
Operation	Indoor air temperature		Outdoor air temperature		Standards																			
	DB	WB	DB	WB																				
Cooling	27°C	19°C	35°C	24°C	ISO5151-T1																			
Heating	20°C	—	7°C	6°C																				
(2) This air-conditioner is manufactured and tested in conformity with the ISO.																								
(3) Sound level indicates the value in an anechoic chamber. During operation these value are somewhat higher due to ambient conditions.																								
(4) The operation data indicate when the air-conditioner is operated at 400V50Hz or 380V60Hz.																								

Item		Model	FDC200VS																					
Power source			3 Phase 380-415V 50Hz / 380V 60Hz																					
Operation data	Nominal cooling capacity (range)	kW	20.0 [7.0(Min.)~22.4(Max.)]																					
	Nominal heating capacity (range)	kW	22.4 [7.6(Min.)~25.0(Max.)]																					
	Sound power level	Cooling	dB(A)	74																				
		Heating																						
	Sound pressure level	Cooling	57																					
Heating																								
Silent mode sound pressure level			Cooling : 56 / Heating : 56																					
Exterior dimensions (Height × Width × Depth)		mm	1,300×970×370																					
Exterior appearance (Munsell color)			Stucco White (4.2Y7.5/1.1) near equivalent																					
Net weight		kg	122																					
Compressor type & Q'ty			GTC5150ND70K×1																					
Compressor motor (Starting method)		kW	Direct line start																					
Refrigerant oil (Amount, type)		ℓ	1.45 M-MA32R																					
Refrigerant (Type, amount, pre-charge length)		kg	R410A 5.4kg (Pre-charged up to the piping length of 30m) Outdoor unit																					
Heat exchanger			Straight fin & inner grooved tubing																					
Refrigerant control			Electronic expansion valve																					
Fan type & Q'ty			Propeller fan ×2																					
Fan motor (Starting method)		W	86x2 < Direct line start >																					
Air flow	Cooling	m ³ /min	150																					
	Heating		145																					
Shock & vibration absorber			Rubber sleeve (for compressor)																					
Electric heater		W	33 (Crank case heater)																					
Safety equipments			Internal thermostat for fan motor. Abnormal discharge temperature protection.																					
Installation data	Refrigerant piping size (O.D.)	mm	Liquid line: φ 9.52 (3/8") Gas line: I/U φ 22.22 (7/8")																					
	Connecting method		Liquid line : Flare / Gas : Brazing																					
	Attached length of piping	m	—																					
	Insulation for piping		Necessary (both Liquid & Gas lines)																					
	Refrigerant line (one way) length	m	Max.70m																					
	Vertical height diff. between O.U. and I.U.	m	Max.30m (Outdoor unit is higher) Max.15m (Outdoor unit is lower)																					
Drain hose			Holes size φ 20 × 3pcs																					
IP number			IP24																					
Standard accessories			Connecting pipe, Edging																					
Option parts			—																					
Note (1) The data are measured at the following conditions.			The pipe length is 7.5m.																					
<table border="1"> <thead> <tr> <th rowspan="2">Operation</th> <th colspan="2">Indoor air temperature</th> <th colspan="2">Outdoor air temperature</th> <th rowspan="2">Standards</th> </tr> <tr> <th>DB</th> <th>WB</th> <th>DB</th> <th>WB</th> </tr> </thead> <tbody> <tr> <td>Cooling</td> <td>27°C</td> <td>19°C</td> <td>35°C</td> <td>24°C</td> <td rowspan="2">ISO5151-T1</td> </tr> <tr> <td>Heating</td> <td>20°C</td> <td>—</td> <td>7°C</td> <td>6°C</td> </tr> </tbody> </table>		Operation	Indoor air temperature		Outdoor air temperature		Standards	DB	WB	DB	WB	Cooling	27°C	19°C	35°C	24°C	ISO5151-T1	Heating	20°C	—	7°C	6°C		
Operation	Indoor air temperature		Outdoor air temperature		Standards																			
	DB	WB	DB	WB																				
Cooling	27°C	19°C	35°C	24°C	ISO5151-T1																			
Heating	20°C	—	7°C	6°C																				
(2) This air-conditioner is manufactured and tested in conformity with the ISO.																								
(3) Sound level indicates the value in an anechoic chamber. During operation these value are somewhat higher due to ambient conditions.																								
(4) The operation data indicate when the air-conditioner is operated at 400V50Hz or 380V60Hz.																								

Item		Model	FDC250VS		
Power source			3 Phase 380-415V 50Hz / 380V 60Hz		
Operation data	Nominal cooling capacity (range)	kW	25.0 [10.0(Min.)~28.0(Max.)]		
	Nominal heating capacity (range)	kW	28.0 [9.5(Min.)~31.5(Max.)]		
	Sound power level	Cooling	dB(A)	74	
		Heating		57	
	Sound pressure level	Cooling		58	
Heating		57			
Silent mode sound pressure level			Cooling : 56 / Heating : 57		
Exterior dimensions (Height × Width × Depth)		mm	1,505×970×370		
Exterior appearance (Munsell color)			Stucco White (4.2Y7.5/1.1) near equivalent		
Net weight		kg	140		
Compressor type & Q'ty			GTC5150ND70K×1		
Compressor motor (Starting method)		kW	Direct line start		
Refrigerant oil (Amount, type)		ℓ	1.45 M-MA32R		
Refrigerant (Type, amount, pre-charge length)		kg	R410A 7.2kg (Pre-charged up to the piping length of 30m) Outdoor unit		
Heat exchanger			Straight fin & inner grooved tubing		
Refrigerant control			Electronic expansion valve		
Fan type & Q'ty			Propeller fan ×2		
Fan motor (Starting method)		W	86x2 < Direct line start >		
Air flow	Cooling Heating	m ³ /min	150		
			145		
Shock & vibration absorber			Rubber sleeve (for compressor)		
Electric heater		W	33 (Crank case heater)		
Safety equipments			Internal thermostat for fan motor. Abnormal discharge temperature protection.		
Installation data	Refrigerant piping size (O.D.)	mm	Liquid line: φ 12.7 (1/2") Gas line: φ 22.22 (7/8")		
	Connecting method		Liquid line : Flare / Gas : Brazing		
	Attached length of piping	m	—		
	Insulation for piping		Necessary (both Liquid & Gas lines)		
	Refrigerant line (one way) length	m	Max.70m		
	Vertical height diff. between O.U. and I.U.	m	Max.30m (Outdoor unit is higher) Max.15m (Outdoor unit is lower)		
Drain hose			Holes size φ 20 × 3pcs		
IP number			IP24		
Standard accessories			Connecting pipe, Edging		
Option parts			—		
Note (1) The data are measured at the following conditions.			The pipe length is 7.5m.		
Operation	Indoor air temperature	Outdoor air temperature		Standards	
Cooling	DB	WB	DB		WB
	27°C	19°C	35°C		24°C
Heating	20°C	—	7°C	6°C	
ISO5151-T1					
(2) This air-conditioner is manufactured and tested in conformity with the ISO.					
(3) Sound level indicates the value in an anechoic chamber. During operation these value are somewhat higher due to ambient conditions.					
(4) The operation data indicate when the air-conditioner is operated at 400V50Hz or 380V60Hz.					

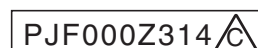

(3) Operation chart

The V Multi is a system that allows for different models and capacities of indoor units to be connected so the individual operating characteristics of the indoor and outdoor are provided. Use the procedure shown in Item (c) to calculate the combined operating characteristics.

(a) Operating characteristic of outdoor unit

(220-240V 50Hz/220V 60Hz)

Item		Model	FDC100VN	FDC125VN	FDC140VN
Cooling power consumption	kW		2.62/2.62	3.91/3.91	4.51/4.51
Heating power consumption			2.60/2.60	3.63/3.63	4.40/4.40
Cooling running current	A		11.7/12.3	17.3/18.2	20.4/21.4
Heating running current			11.6/12.2	16.2/16.9	19.5/20.4
Inrush current (L.R.A) <Max. running current>	A		5 <24>		

(380-415V 50Hz/380V 60Hz)

Item		Model	FDC100VS	FDC125VS	FDC140VS
Cooling power consumption	kW		2.62/2.62	3.91/3.91	4.51/4.51
Heating power consumption			2.60/2.60	3.63/3.63	4.40/4.40
Cooling running current	A		3.8/4.0	5.5/5.9	6.5/6.9
Heating running current			3.8/4.0	5.1/5.5	6.3/7.0
Inrush current (L.R.A) <Max. running current>	A		5 <15>		

(380-415V 50Hz/380V 60Hz)

Item		Model	FDC200VS	FDC250VS
Cooling power consumption	kW		6.34/6.34	8.71/8.71
Heating power consumption			6.20/6.20	7.75/7.75
Cooling running current	A		9.1/9.1	12.7/12.7
Heating running current			9.0/9.0	11.4/11.4
Inrush current (L.R.A) <Max. running current>	A		5 <19>	5 <22>

Note(1) This packaged air-conditioner is manufactured and tested in conformity with the following standard.
ISO-T1 "UNITARY AIR-CONDITIONERS"

(b) Operating characteristic of indoor unit**FDT Series**

(220-240V 50Hz/220V 60Hz)

Item		Model	FDT50VF	FDT60VF	FDT71VF1	FDT100VF1 100VF2	FDT125VF
Cooling power consumption	kW		0.04-0.04/0.04	0.07-0.07/0.07	0.08-0.08/0.08	0.15-0.15/0.15	
Heating power consumption			0.04-0.04/0.04	0.07-0.07/0.07	0.08-0.08/0.08	0.15-0.15/0.15	
Cooling running current	A		0.20-0.19/0.20	0.35-0.32/0.35	0.40-0.37/0.40	0.76-0.69/0.76	
Heating running current			0.20-0.19/0.20	0.35-0.32/0.35	0.40-0.37/0.40	0.76-0.69/0.76	

FDEN Series

(220-240V 50Hz/220V 60Hz)

Item		Model	FDEN50VF	FDEN60VF	FDEN71VF1	FDEN100VF1	FDEN125VF
Cooling power consumption	kW		0.05-0.06/0.06	0.10-0.11/0.11	0.11-0.12/0.14	0.14-0.16/0.16	0.16-0.18/0.20
Heating power consumption			0.05-0.06/0.06	0.09-0.10/0.10	0.10-0.11/0.13	0.13-0.15/0.15	0.15-0.17/0.18
Cooling running current	A		0.25-0.26/0.29	0.46-0.48/0.50	0.50-0.53/0.67	0.65-0.67/0.77	0.77-0.78/0.91
Heating running current			0.23-0.25/0.28	0.42-0.44/0.46	0.46-0.48/0.63	0.59-0.63/0.70	0.70-0.72/0.80

Notes(1) This packaged air-conditioner is manufactured and tested in conformity with the following standard.
ISO-T1 "UNITARY AIR-CONDITIONERS"

(2) The values shown in the above table are common to both cooling and heating operations.

2.3 EXTERIOR DIMENSIONS

- (1) Indoor units
 - (a) Ceiling cassette-4way type (FDT)See page 93
 - (b) Ceiling suspended type (FDEN)See page 96
- (2) Outdoor unitsSee page 107
- (3) Remote control (Option parts)See page 110

2.4 ELECTRICAL WIRING

- (1) Indoor units
 - (a) Ceiling cassette-4way type (FDT)See page 113
 - (b) Ceiling suspended type (FDEN)See page 115
- (2) Outdoor unitsSee page 125

2.5 NOISE LEVEL

- (1) Indoor units
 - (a) Ceiling cassette-4way compact type (FDT)See page 128
 - (b) Ceiling suspended type (FDEN)See page 129
- (2) Outdoor unitsSee page 132

2.6 TEMPERATURE AND VELOCITY DISTRIBUTION

- (1) Indoor units
 - (a) Ceiling cassette-4way type (FDT)See page 141
 - (b) Ceiling suspended type (FDEN)See page 145

2.7 PIPING SYSTEMSee page 150

2.8 RANGE OF USAGE & LIMITATIONSSee page 155

2.9 SELECTION CHARTSee page 159

2.10 APPLICATION DATE

2.10.1 Installation of indoor unit

- (1) Ceiling cassette-4way type (FDT)See page 209
- (2) Ceiling suspended type (FDEN)See page 222

2.10.2 Electric wiring work installationSee page 251

2.10.3 Installation of wired remote controlSee page 263

2.10.4 Installation of outdoor unit

- (1) Models FDC100-140VN,100-140VSSee page 277
- (2) Models FDC200,250VSSee page 286
- (3) Method for connecting the accessory pipe
(Models FDC200,250)See page 295

2.10.5 Instructions for branching pipe set (DIS-WA1,WB1,TA1,TB1)See page 297

2.11 OUTLINE OF OPERATION CONTROL BY MICROCOMPUTERSee page 300

2.12 MAINTENANCE DATASee page 338

3. OPTION PARTS

CONTENTS

3.1 WIRELESS KIT	515
3.1.1 FDT series (RCN-T-36W-E)	515
3.1.2 FDTC series (RCN-TC-24W-ER)	517
3.1.3 FDEN series (RCN-E1R)	519
3.1.4 FDU,FDUM,FDI series (RCN-KIT3-E)	523
3.2 SIMPLE WIRED REMOTE CONTROL (RCH-E3)	525
3.3 OA SPACER (FDTC series)	531
3.4 DUCT JOINT (FDTC series)	535
3.5 FAN CONTROLLER KIT (FDU series)	536
3.6 FILTER KIT (FDUM series)	537
3.7 BASE HEATER KIT (CW-H-E1)	539
3.8 INTERFACE KIT (SC-BIKN-E)	545
3.8.1 Cable connection for SRK twin/triple installation	549
3.9 SUPER LINK E BOARD (SC-ADNA-E)	550

3.1 WIRELESS KIT

3.1.1 FDT series (RCN-T-36W-E)

PJF012D010

Notes :

Following functions of FDT Type-F indoor unit series are not able to be set with this wireless remote control (RCN-T-36W-E).

1. Individual flap control system
2. 4-fan speed setting (P-Hi/Hi/Me/Lo) → 3-fan speed setting (Hi/Me/Lo)

⚠ WARNING

- Fasten the wiring to the terminal securely and hold the cable securely so as not to apply unexpected stress on the terminal. Loose connection or hold will cause abnormal heat generation or fire.
- Make sure the power supply is turned off when electric wiring work. Otherwise, electric shock, malfunction and improper running may occur.

⚠ CAUTION

- DO NOT install the wireless kit at the following places in order to avoid malfunction.

(1) Places exposed to direct sunlight	(8) Places where the receiver is influenced by the fluorescent lamp (especially inverter type) or sunlight.
(2) Places near heat devices	(9) Places where the receiver is affected by infrared rays of any other communication devices
(3) High humidity places	(10) Places where some object may obstruct the communication with the remote control
(4) Hot surface or cold surface enough to generate condensation	
(5) Places exposed to oil mist or steam directly	
(6) Uneven surface	
(7) Places affected by the direct airflow of the AC unit.	
- DO NOT leave the wireless kit without the cover. In case the cover needs to be detached, protect the receiver with a packaging box or bag in order to keep it away from water and dust.

Attention

- Instruct the customer how to operate it correctly referring to the instruction manual.
- For the installation method of the air conditioner itself, refer to the installation manual enclosed in the package.

① Accessories

Please make sure that you have all of the following accessories.

Receiver		1	Remote control holder		1
Wireless remote control		1	Wood screw for holder		2
Parts set		1	AAA dry cell battery (RO3)		2

② How to install the receiver

The receiver can be installed by replacing with a corner panel on the applicable decorative panel.

Preparation before installation

- ① Attach the decorative panel onto the air conditioner according to the installation manual for the panel.
- ② Remove the air return grille.
- ③ Remove a corner panel located on the refrigerant pipes side.
- ④ Remove three screws and detach the cover (indicated as shadowed area) from the control box of the air conditioner.

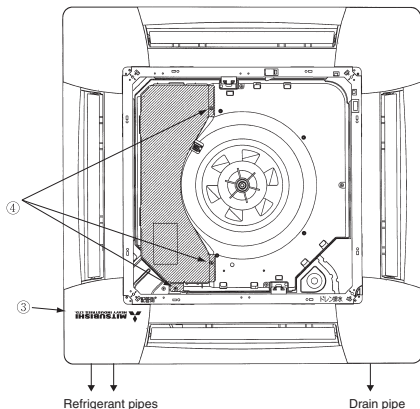

Setting on site

① PCB on the receiver has the following switches to set the functions. Default setting is shown with mark.

SW 1	Customized signal setting to avoid mixed communication	<input type="checkbox"/> ON : Normal <input type="checkbox"/> OFF : Remote
SW 2	Receiver master/slave setting	<input type="checkbox"/> ON : Master <input type="checkbox"/> OFF : Slave
SW 3	Buzzer valid/Invalid	<input type="checkbox"/> ON : Valid <input type="checkbox"/> OFF : Invalid
SW 4	Auto restart	<input type="checkbox"/> ON : Valid <input type="checkbox"/> OFF : Invalid

<To change the settings>

- ② Remove the cover by unscrewing two screws from the back of receiver.
- ③ Change the setting by the switch on PCB.

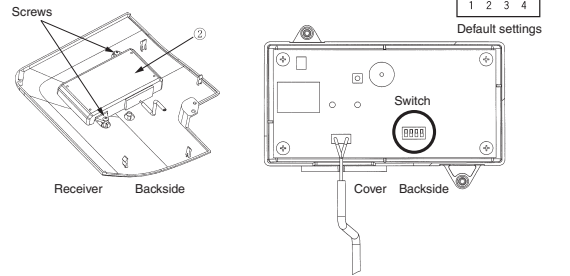

④ When SW1 is turned to OFF position, change the corresponding remote control setting as follows:

How to change the remote control setting

Pressing [ACL] and [AIR FLOW] button at the same time or inserting the batteries with pressing [AIR FLOW] button will customize the signal.

Note

※ When the batteries are removed, the setting will return to the default setting. Please make sure to reset it when the batteries are replaced.

Caution

Instruct the customer to set the mentioned above when replacing the batteries. (How to set is also mentioned in the user's manual attached on the air conditioner.)

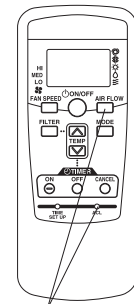

Installation of the receiver

- ① Loosen the bolts which fix the panel and make a gap between the panel and the indoor unit
- ② Put the wiring of the receiver through the opening.
- ③ Put the wiring on the notch on the control box so as not to be pinched by the control box and lid as shown below.
- ④ Connect the wiring to the terminal block provided in the control box. (Non- polarized)
- ⑤ Attach the receiver to the panel according to the panel installation manual.
- ⑥ Fix the wiring with the clamp so that the wiring do not contact the edge of control box's metal sheet.
- ⑦ Reattach the control box lid with 3 screws removed.

※ Note: Make sure the wires not to be pinched by any other parts like panel, control box and indoor unit.

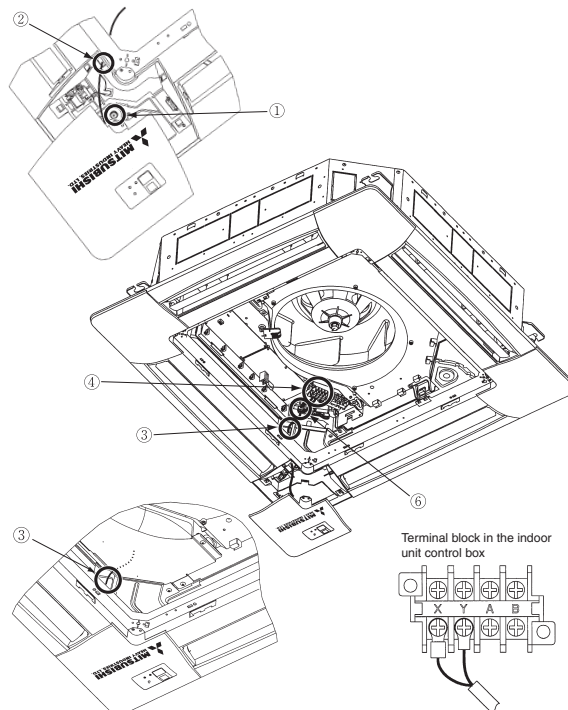

3 Remote control

Installation of the control holder

Caution

- DO NOT install it on the following places
1. Places exposed to direct sunlight
 2. Places near heat devices
 3. High humidity places
 4. Hot surface or cold surface enough to generate condensation
 5. Places exposed to oil mist or steam directly.
 6. Uneven surface

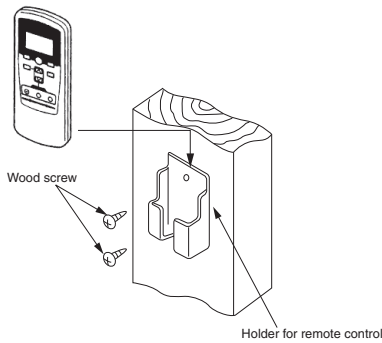

Installation tips for the remote control holder

- Adjust and keep the holder upright
- Tighten the screw to the end to avoid scratching the remote control.
- DO NOT attach the holder on plaster wall.

How to insert batteries

- 1 Detach the back lid.
- 2 Insert the batteries. (two AAA batteries)
- 3 Reattach the back lid.

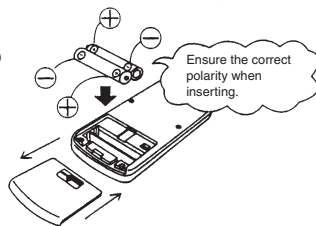

Control plural indoor units with one remote control

Up to 16 indoor units can be connected.

- 1 Connect the XY terminal with 2-core wire. As for the size, refer to the following note.
- 2 For Packaged air conditioner series, set the indoor unit address with SW2 on the indoor unit PCB from [0] to [F] so as not to duplicate.

Restrictions on the thickness and length of wire
(Maximum total extension 600m.)

Standard	Within
	100m x 0.3 mm ²
	200m x 0.5 mm ²
	300m x 0.75mm ²
	400m x 1.25mm ²
	600m x 2.0 mm ²

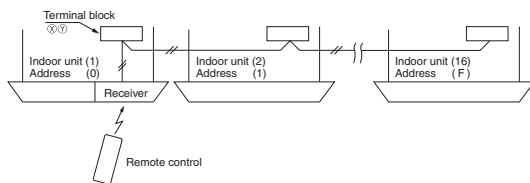

- 3 For VRF series, set the indoor unit address with SW1, SW2 and SW5-2 on the indoor unit PCB from [000] to [127] so as not to duplicate.

Master/Slave setting when using plural remote controls

Up to two receivers can be installed in one indoor unit group. When two receivers are used, it is necessary for a receiver to turn OFF SW2 on the receiver PCB to set it as slave.

(For the method of switching, please see **Setting on site** in the section of

- 2 How to install the receiver in this manual.)

Wireless remote control's operable area

- 1 Standard reachable area of the signal
[condition] Illuminance at the receiver: 300lux
(When no lighting is installed within 1m of the receiver in an ordinary office.)

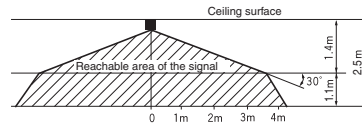

- 2 Correlation between illuminance at the receiver and reachable area of the signal in a plain view.

The drawing in the right shows the correlation between the reachable area of the signal and illuminance at the receiver when the remote control is operated at 1.1m high under the condition of ceiling height of 2.5m. When the illuminance becomes double, the area is narrowed down to two thirds.

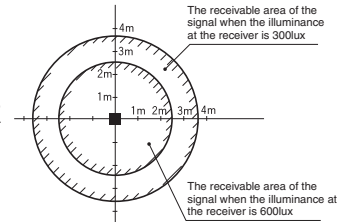

- 3 Installation tips when several receivers are installed close
Minimum distance between the indoor units which can avoid cross communication is 5m under the condition of 300lux of illuminance at the receiver.
(When no lighting is installed within 1m of the receiver in an ordinary office.)

4 How to disable the Auto mode operation

VRF system (except heat recovery 3-pipe systems) cannot be operated in Auto mode. Make sure to set the remote control for the models so as not to be able to choose Auto mode.

Pushing **[ACL]** and **[MODE]** button at the same time or inserting the batteries with pressing **[MODE]** button will make auto mode operation.

Attention

※ When the batteries are removed, the setting will return to the default setting (Auto mode is valid).

Caution

Instruct the customer to set the mentioned above when replacing the batteries. (How to set is also mentioned in the user's manual attached on the air conditioner.)

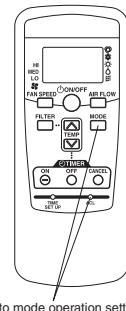

5 Backup button

A Backup button is provided on the receiver. Even when the operation from the wireless remote control is not possible (due to flat batteries, controller lost, or control failure), still it possible to operate as temporary means. Press the button directly when operating it.

- 1 The air conditioner starts the operation with the condition of Auto mode, 23°C of set point, High fan speed and horizontal louver position.
- 2 The air conditioner stops the operation when the button is pressed when in operation.

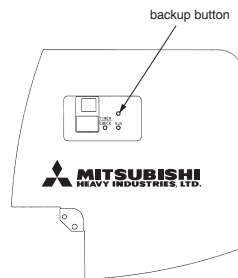

6 Cooling test run operation

- After safety confirmation, turn on the power.
- Transmit a cooling operation command with wireless remote control, while the backup button on the receiver is pressed.
- If the backup button on the receiver is pressed during a test run, it will end the test run.
- If you cannot operate the unit properly during a test run, please check by consulting with inspection guides on the wiring diagram of outdoor units.

7 How to read the two-digit display

On the receiver of a wireless kit, a two-digit (7-segment) display is provided.

- 1 An indication will be displayed for one hour after power on.
- 2 An indication will be displayed for 3.5 seconds after transmitting a "STOP" command from the wireless remote control or the operation of the backup button to stop the unit.
- 3 An indication appearing in (1) or (2) above will go off as soon as the unit starts operation.
- 4 When there are no error records to indicate, addresses of all the connected units are displayed.
- 5 When there are some error records remaining, the error records are displayed.
- 6 Error records can be cleared by transmitting a "STOP" command from the wireless remote control, while the backup button is pressed.

3.1.2 FDTC series (RCN-TC-24W-ER)

PJA012D758

Notes :

Following functions of FDTC Type-F indoor unit series are not able to be set with this wireless remote control (RCN-TC-24W-E).

1. Individual flap control system
2. 4-fan speed setting (P-Hi/Hi/Me/Lo) → 3-fan speed setting (Hi/Me/Lo)

⚠ WARNING

- Fasten the wiring to the terminal securely and hold the cable securely so as not to apply unexpected stress on the terminal. !
Loose connection or hold will cause abnormal heat generation or fire.
- Make sure the power supply is turned off when electric wiring work. !
Otherwise, electric shock, malfunction and improper running may occur.

⚠ CAUTION

- DO NOT install the wireless kit at the following places in order to avoid malfunction.

(1) Places exposed to direct sunlight (2) Places near heat devices (3) High humidity places (4) Hot surface or cold surface enough to generate condensation (5) Places exposed to oil mist or steam directly (6) Uneven surface (7) Places affected by the direct airflow of the AC unit.	(8) Places where the receiver is influenced by the fluorescent lamp (especially inverter type) or sunlight. (9) Places where the receiver is affected by infrared rays of any other communication devices (10) Places where some object may obstruct the communication with the remote control
---	--
- DO NOT leave the wireless kit without the cover. !
In case the cover needs to be detached, protect the receiver with a packaging box or bag in order to keep it away from water and dust.

Note

- Instruct the customer how to operate it correctly referring to the instruction manual.
- For the installation method of the air conditioner itself, refer to the installation manual enclosed in the package.

① Accessories

Please make sure that you have all of the following accessories.

Receiver		1	Remote control holder		1
Wireless remote control		1	Wood screw for holder		2
Parts set		1	AAA dry cell battery (RO3)		2

② How to install the receiver

The receiver can be installed by replacing with a corner panel on the applicable decorative panel.

Preparation before installation

- ① Attach the decorative panel onto the air conditioner according to the installation manual for the panel.
- ② Remove the air return grille.
- ③ Remove a corner panel located on the refrigerant pipes side.
- ④ Remove two screws and detach the lid from the control box of the air conditioner.

Setting on site

① PCB on the receiver has the following switches to set the functions. Default setting is shown with mark.

SW 1	Customized signal setting to avoid mixed communication	<input type="checkbox"/> ON : Normal <input type="checkbox"/> OFF : Remote
SW 2	Receiver master/slave setting	<input type="checkbox"/> ON : Master <input type="checkbox"/> OFF : Slave
SW 3	Buzzer valid/invalid	<input type="checkbox"/> ON : Valid <input type="checkbox"/> OFF : Invalid
SW 4	Auto restart	<input type="checkbox"/> ON : Valid <input type="checkbox"/> OFF : Invalid

<To change the settings>

- ② Remove the cover by unscrewing two screws from the back of receiver.
- ③ Change the setting by the switch on PCB.

ON
 OFF
 Default settings: 1 2 3 4

- ④ When SW1 is turned to OFF position, change the corresponding remote control setting as follows:
How to change the remote control setting
 Pressing [ACL] switch with [AIR FLOW] button kept pressing or inserting the batteries with pressing [AIR FLOW] button will customize the signal.

Note

- ※ When the batteries are removed, the setting will return to the default setting. Please make sure to reset it when the batteries are replaced.

Caution

Instruct the customer to set the mentioned above when replacing the batteries.
 (How to set is also mentioned in the user's manual attached on the air conditioner.)

Radio interference prevention mode

Installation of the receiver

- ① Attach the receiver to the panel according to the panel installation manual.
- ② Remove two screws and detach the lid from the control box.
- ③ Put the wiring in the control box with other wiring as shown below.
- ④ Connect the wiring to the terminal block (X,Y) provided in the control box. (Non-polarized)
- ⑤ Fix the wiring with the clamp as shown below.
- ⑥ Reattach the control box lid with 2 screws removed.

※ Note: Make sure wires not to be pinched by any other parts like panel and control box.

③ Remote control

Installation of the control holder

Caution

- DO NOT install it on the following places
1. Places exposed to direct sunlight
 2. Places near heat devices
 3. High humidity places
 4. Hot surface or cold surface enough to generate condensation
 5. Places exposed to oil mist or steam directly.
 6. Uneven surface

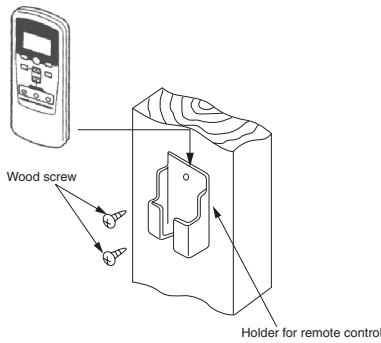

Installation tips for the remote control holder

- Adjust and keep the holder upright
- Tighten the screw to the end to avoid scratching the remote control.
- DO NOT attach the holder on plaster wall.

How to insert batteries

- ① Detach the back lid.
- ② Insert the batteries. (two AAA batteries)
- ③ Reattach the back lid.

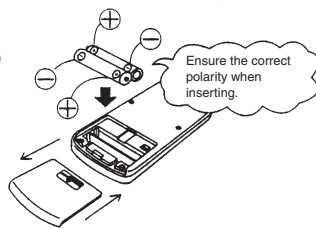

Control plural indoor units with one remote control

Up to 16 indoor units can be connected.

- ① Connect the XY terminal with 2-core wire. As for the size, refer to the following note.
- ② For Single packaged air conditioner series, set the indoor unit address with SW2 on the indoor unit PCB from [0] to [F] so as not to duplicate.

Restrictions on the thickness and length of wire (Maximum total extension 600m.)	
Standard	Within 100m x 0.3 mm ²
	Within 200m x 0.5 mm ²
	Within 300m x 0.75mm ²
	Within 400m x 1.25mm ²
	Within 600m x 2.0 mm ²

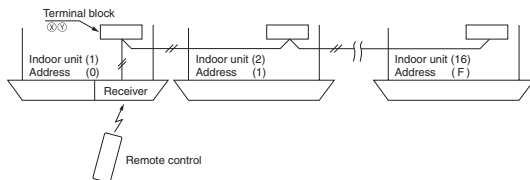

- ③ For VRF series, set the indoor unit address with SW1, SW2 and SW5-2 on the indoor unit PCB from [000] to [127] so as not to duplicate.

Master/Slave setting when using plural remote controls

Up to two receivers can be installed in one indoor unit group. When two receivers are used, it is necessary for a receiver to turn OFF SW2 on the receiver PCB to set it as slave.

(For the method of switching, please see **Setting on site** in the section of

- ② **How to install the receiver** in this manual.)

Wireless remote control's operable area

- ① Standard reachable area of the signal
[condition] Illuminance at the receiver: 300lux
(when no lighting is installed within 1m of the receiver in an ordinary office.)

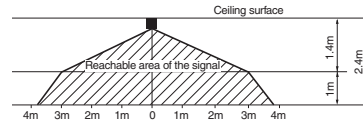

- ② Correlation between illuminance at the receiver and reachable area of the signal in a plain view.

The drawing in the right shows the correlation between the reachable area of the signal and illuminance at the receiver when the remote control is operated at 1m high under the condition of ceiling height of 2.4m.

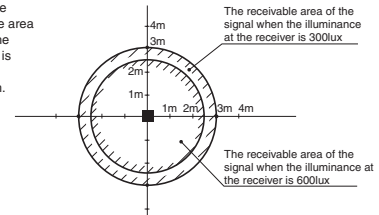

- ③ Installation tips when several receivers are installed close
Minimum distance between the indoor units which can avoid cross communication is 5m under the condition of 300lux of illuminance at the receiver.
(When no lighting is installed within 1m of the receiver in an ordinary office)

④ How to disable the Auto mode operation

VRF series (except heat recovery 3-pipe systems) cannot be operated in Auto mode.
Make sure to set the remote control for the models so as not to be able to choose Auto mode.

Pressing **[ACL]** switch with **[MODE]** button kept pressing or inserting the batteries with pressing **[MODE]** button will make auto mode operation.

Note

※ When the batteries are removed, the setting will return to the default setting (Auto mode is valid).

Caution

Instruct the customer to set the mentioned above when replacing the batteries. (How to set is also mentioned in the user's manual attached on the air conditioner.)

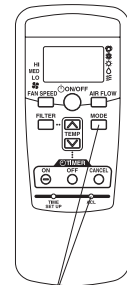

⑤ Backup button

A Backup button is provided on the receiver. Even when the operation from the wireless remote control is not possible (due to flat batteries, controller lost, or controller failure), still it possible to operate as temporary means. Press the button directly when operating it.

- (1) The air conditioner starts the operation with the condition of Auto mode, 23°C of set point, High fan speed and horizontal louver position.
- (2) The air conditioner stops the operation when the button is pressed when in operation.

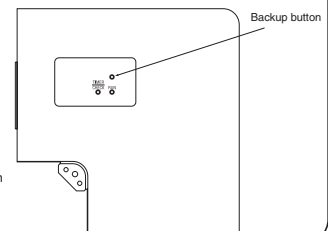

⑥ Cooling test run operation

- After safety confirmation, turn on the power.
- Transmit a cooling operation command with wireless remote control, while the backup button on the receiver is pressed.
- If the backup button on the receiver is pressed during a test run, it will end the test run.
- If you cannot operate the unit properly during a test run, please check by consulting with inspection guides on the wiring diagram of outdoor units.

⑦ How to read the two-digit display

On the receiver of a wireless kit, a two-digit (7-segment) display is provided.



- (1) An indication will be displayed for one hour after power on.
- (2) An indication will be displayed for 3.5 seconds after transmitting a "STOP" command from the wireless remote control or the operation of the backup button to stop the unit.
- (3) An indication appearing in (1) or (2) above will go off as soon as the unit starts operation.
- (4) When there are no error records to indicate, addresses of all the connected units are displayed.
- (5) When there are some error records remaining, the error records are displayed.
- (6) Error records can be cleared by transmitting a "STOP" command from the wireless remote control, while the backup button is pressed.

3.1.3 FDEN series (RCN-E1R)

PFA012D620 

Notes :
 Following functions of FDEN Type-F indoor unit series are not able to be set with this wireless remote control (RCN-E1R).
 1. Flap control system
 2. 4-fan speed setting (P-Hi/Hi/Me/Lo) → 3-fan speed setting (Hi/Me/Lo)

WARNING





- Fasten the wiring to the terminal securely and hold the cable securely so as not to apply unexpected stress on the terminal. Loose connection or hold will cause abnormal heat generation or fire. 
- Make sure the power supply is turned off when electric wiring work. Otherwise, electric shock, malfunction and improper running may occur. 

CAUTION

- Install a receiver unit where it is not exposed to direct sunrays or intense light from lighting fixtures. 

① Accessories

Please make sure that you have all of the following accessories.

Remoto control holder	AAA dry cell battery (RO3)	Wood screw for holder	Wireless remote control
			
1	2	2	1

② Installation of the remote control holder

 **CAUTION DO NOT install it on the following places.**

- | | |
|--------------------------------------|--|
| 1. Places exposed to direct sunlight | 2. Hot surface or cold surface enough to generate condensation |
| 3. Places near heat devices | 4. Places exposed to oil mist or steam directly. |
| 5. High humidity places | 6. Uneven surface |

Installation tips for the remote control holder

- Adjust and keep the holder up right.
- Tighten the screw to the end to avoid scratching the remote control.
- DO NOT attach the holder on plaster wall.

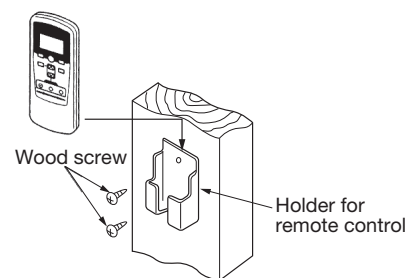

How to insert batteries

- ① Detach the back lid.
- ① Insert the batteries. (two AAA batteries)
- ① Reattach the back lid.

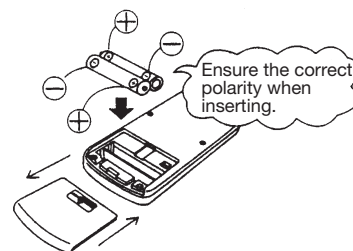

③ FDEN

Setting on site

PCB on the receiver has the following switches to set the function.

Default setting is shown with mark.

SW1	Prevents interference during plural setting	<input type="checkbox"/> ON : Normal (1ch) <input type="checkbox"/> OFF : Customized (2ch)
SW2	Receiver master/slave setting	<input type="checkbox"/> ON : Master <input type="checkbox"/> OFF : Slave
SW3	Buzzer valid/Invalid	<input type="checkbox"/> ON : Valid <input type="checkbox"/> OFF : Invalid
SW4	Auto restart	<input type="checkbox"/> ON : Valid <input type="checkbox"/> OFF : Invalid

To change setting

1. Remove the front panel.
2. Remove four screws located on the back of the receiver and detach the board.
3. Change the setting by the switch on PCB.

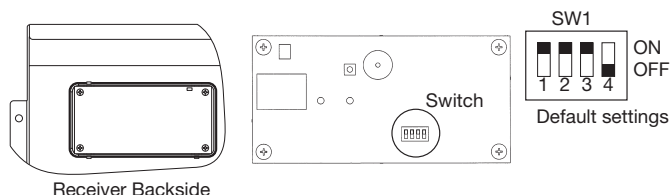

4. When switch 1 is turned to off position, change the wireless remote control setting.
(For the method of changing the setting, refer to [Setting to avoid mixed communication](#) on page 4)
Refer to [Wireless remote control unit operation distance](#) of **③ FDEN** in case of plural setting.

Master/Slave setting when using plural remote controls

Up to two receiver or wired remote control can be installed in one indoor unit group.

When two receivers or wired remote control are used, it is necessary to change SW on the PCB to set it as slave.

Control plural indoor units with one remote control

Up to 16 indoor units can be connected.

- ① Connect indoor units with each other with 2-core wires. As for size, refer to the following note.
- ② The receiver wires must be connected only with the indoor unit that will be operated by the remote control directly.
- ③ Set the indoor unit address with SW2 on the indoor unit PCB from [0] to [F] so as not to duplicate.

Restrictions on the thickness and length of wire (Maximum total extension 600m.)	
Standard	Within 100m x 0.3 mm ² Within 200m x 0.5 mm ² Within 300m x 0.75 mm ² Within 400m x 1.25 mm ² Within 600m x 2.0 mm ²

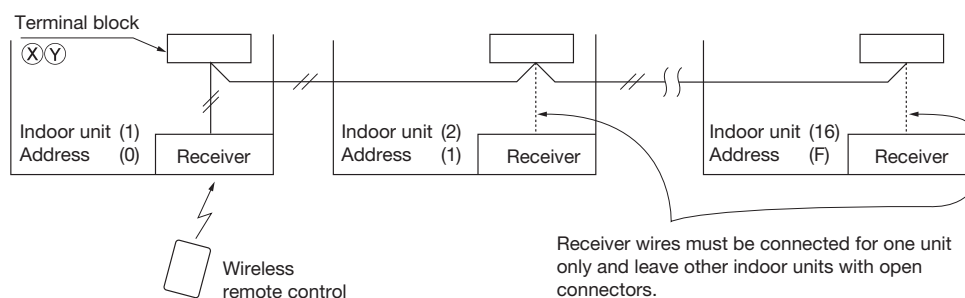

※ATTENTION

In a system configured as shown above, up to two receivers are usable. If two receivers are used, it is necessary to designate one of them as a slave by setting SW2. (For the method of changing the setting, refer to [Setting on site](#) .) Since other receivers are not usable, do not couple the connectors for them. (Unless the connector is coupled for a receiver, the LED will not be able to make any indication)

③ FDEN (continued)

Wireless remote control operation distance

① Standard signal receiving range

[Condition]

Illuminance at the receiver area: 360 lux.
(When no lighting fixture is located within 1m of indoor unit in an ordinary office)

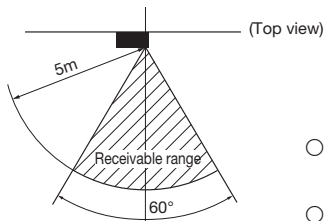
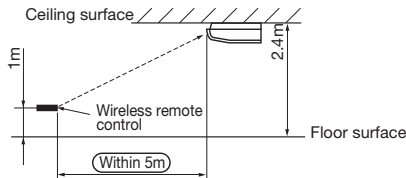

② Points for attention in connecting a plural number of indoor units

[Condition]

Illuminance at the receiver area: 360 lux.
(When no lighting fixture is located within 1m of indoor unit in an ordinary office)

When the remote control is used with the aforementioned interference-prevention setting, a minimum distance guaranteeing the prevention of unintended unit responses is 5m.

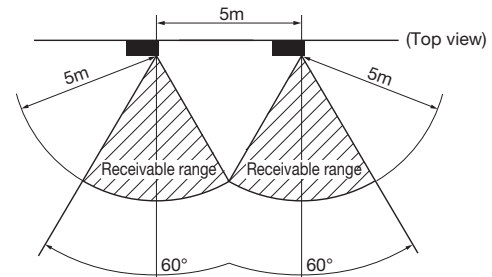

- Please operate remote control switches with the unit faced correctly toward the indoor unit's receiver section.
- Effective operation distance can vary with the luminance around the receiver and the reflection from walls of the room.
- When the receiver is exposed to intensive light such as from the direct sun or a strong light, it may become operable only from a short distance or unable to receive signals at all.

Backup button

A backup switch is provided on the receiver section of the panel surface.

When operation from the wireless remote control is not possible (due to flat batteries, a mislaid unit, a unit failure), you can use it as an emergency means. You should operate this switch manually.

- (1) If pressed while the air conditioner is in a halt, it will cause the air conditioner to start operation in the automatic mode.

Wind speed: Hi fan, Temperature setting: 23°C, Louver: horizontal

- (2) If pressed while the air conditioner is in operation, it will stop the air conditioner.

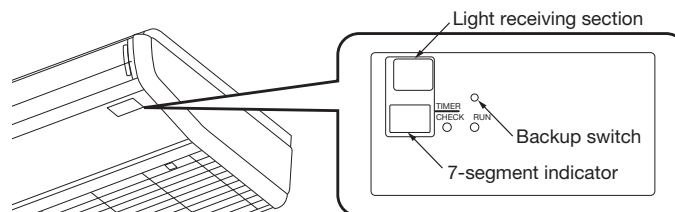

Cooling test run operation

- After safety confirmation, turn on the power.
 - Transmit a cooling operation command with the wireless remote control, while the backup switch on the receiver is depressed.
 - If the backup switch on the receiver is pressed during a test run, it will end the test run.
- ※ If you cannot operate the unit properly during a test run, please check wiring by consulting with inspection guides.

③ FDEN (continued)

How to read the two-digit display

A two-digit indicator (7-segment indicator) is provided on the receiver section.

- (1) An indication will be displayed for one hour after power on.
- (2) An indication appears for 3.5 seconds when a "Stop" command is sent from the wireless remote control while the air conditioner is not running.
- (3) An indication appearing in (1) or (2) above will go off as soon as the unit starts operation.
- (4) When there are no error records to indicate, addresses are displayed for all of the connected units.
- (5) When there are some error records remaining, the error records are displayed.
- (6) Error records can be cleared by transmitting a "Stop" command from the wireless remote control, while the backup switch is depressed.

④ Remote control

Setting to avoid mixed communication

Pressing **ACL** and **AIR FLOW** button at the same time or inserting the batteries with pressing **AIR FLOW** button will customize the signal.

Setting to disable the Auto mode operation

VRF system (except heat recovery 3-pipe system) cannot be operated in Auto mode.

Make sure to set the remote control for the models so as not to be able to choose Auto mode.

Pushing **ACL** and **MODE** button at the same time or inserting the batteries with pressing **MODE** button will make auto mode operation.

Radio prevention mode

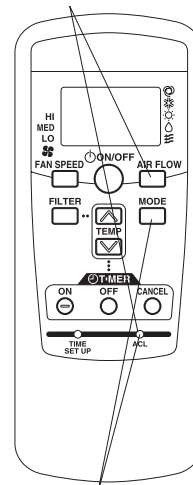

Auto mode operation setting

※ATTENTION

When the batteries are removed, the setting will return to the default setting.
Please make sure to reset it when the batteries are replaced.

⚠ Caution

Instruct the customer to set the mentioned above when replacing the batteries.
(How to set is also mentioned in the user's manual attached on the air conditioner.)

3.1.4 FDU, FDUM, FDF series (RCN-KIT3-E)

Notes:

Following functions of FDU,FDUM,FDF indoor unit series are not able to be set with this wireless remote control (RCN-KIT3-E).

- 4-fan speed setting (PHI/Hi/Me/Lo) → 3-fan speed setting (Hi/Me/Lo)

Read this manual together with the installation manual attached to the air conditioner.



WARNING

- Fasten the wiring to the terminal securely and hold the cable securely so as not to apply unexpected stress on the terminal. Loose connection or hold will cause abnormal heat generation or fire.
- Make sure the power supply is turned off when electric wiring work. Otherwise, electric shock, malfunction and improper running may occur.

CAUTION

- DO NOT install the wireless kit at the following places in order to avoid malfunction.
 - Places exposed to direct sunlight
 - Places near heat devices
 - High humidity places
 - Hot surface or cold surface enough to generate condensation
 - Places exposed to oil mist or steam directly
 - Uneven surface
 - Places affected by the direct airflow of the AC unit.
 - Places where the receiver is influenced by the fluorescent lamp (especially in verter type) or sunlight.
 - Places where the receiver is affected by infrared rays of any other communication devices.
 - Places where some object may obstruct the communication with the remote control
- DO NOT leave the wireless kit without the cover. In case the cover needs to be detached, protect the receiver with a packaging box or bag in order to keep it away from water and dust.

Attention

- Instruct the customer how to operate it correctly referring to the instruction manual.
- User's manual of a wireless remote control is attached to a indoor unit or a outside unit.
- Read this together with a manual attached to this kit.

1 Accessories

Please make sure that you have all of the following accessories.

① Receiver	1	① Remote control holder	1
② Wiring (3m)	1	② Screw for holder	2
③ Parts set (A)	1	③ AAA dry cell battery (R03)	2
④ Parts set (B)	1	① Screw for receiver	2
⑤ Parts set (C)	1	② Fixing band	1
⑥ Wireless remote control	1	③ Clamp	5
⑦ User's manual	1	④ Screw for clamp	5
		① Receiver installation bracket	1
		② Screw for the bracket	2
		③ Installation fitting	2

2 Wireless remote control's operable area

(1) When installed on ceiling

① Standard reachable area of the signal

condition Illuminance at the receiver : 300lux (when no lighting is installed within 1m of the receiver in an ordinary of ce.)

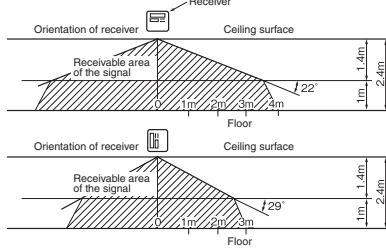

② Correlation between illuminance at the receiver and reachable area of the signal in a plain view.

condition Correlation between the reachable area of the signal and illuminance at the receiver when the remote control is operated at 1.1m high under the condition of ceiling height of 2.5m. When the illuminance becomes double, the area is narrowed down to two third.

(2) When installed on wall

condition Illuminance at the receiver : 800lux.

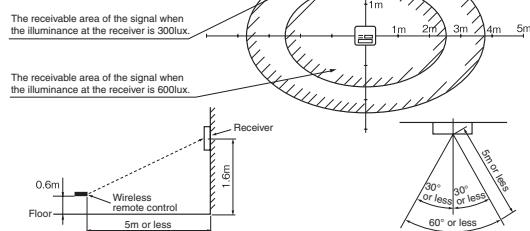

3 How to install the receiver

The following two methods can be used to install the receiver onto a ceiling or a wall. Select a method according to the installation position.

<Installation position>

- (A) Direct installation onto the ceiling with wood screws.
- (B) Installation with accessory's bracket

(1) Drilling of the ceiling (ceiling opening)

Drill the receiver installation holes with the following dimensions at the ceiling position where wires can be connected.

(A) Direct installation onto the ceiling with wood screws.	88mm(H)×101mm(W)
(B) Installation with enclosed bracket.	108mm(H)×108mm(W)

(2) Wiring connection of receiver

Caution

Do not connect the wiring to the power source of the terminal block. If it is connected, printed board will be damaged.

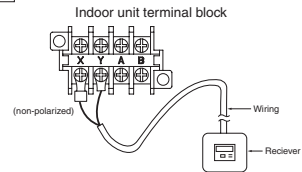

(3) Installation of the receiver

Remove the screw on the side of the receiver and sprit it into the upper case and lower case. Install the receiver with one of the two installation methods (A) or (B) shown below.

(A) Direct installation onto the ceiling with screws

Use this installation method when the ceiling is wooden, and there is no problem for strength in installing directly with wood screws.

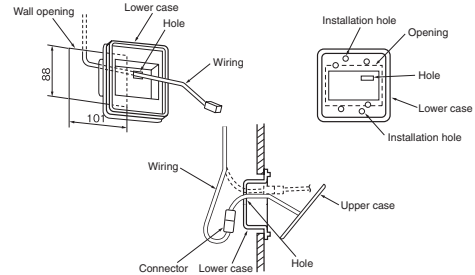

- Put through the wiring from the back side to the hole of the lower case.
- Fit the lower case into the ceiling opening. Make sure that the clearance between the convex part of the back of the lower case and the ceiling opening must be as equal as possible on both sides.
- Using the two installation holes shown above, fix the lower case onto the ceiling with the enclosed wood screws. (The other four holes are not used.)
- Connect the wiring with the wiring from the upper case by the connector.
- Take out the connector to the backside from the hole of the lower case putting through the wiring at ①.
- Fit the upper case and the lower case, and tighten the screws.

(B) Installation with enclosed bracket

Use this method when installaing onto a gypsum board (7 to 18mm), etc.

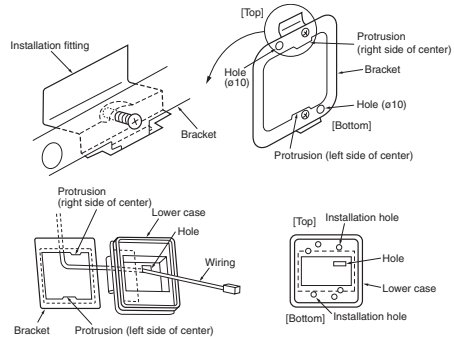

- Catch the two protrusion of the enclosed bracket onto the fitting as shown above, and temporarily fix with the screws. (The bracket has an up/down and front/back orientation. Confirm the top/bottom protrusion positions and the positional relation of the 10 holes on the bracket and the installation hole on the lower case with the above drawing.)
- Insert the end of the installation fitting into the back of the ceiling from the opening, and tighten the screws to fix the bracket onto the ceiling.
- Pass the wiring from the rear side through the hole on the lower case.
- Fit the lower case onto the bracket, and fix the lower case to the bracket using the two installation holes shown above. (The other four holes are not used.)
- Follow step ① to ⑥ for (A) to complete the installation.

④ Remote control

Installation of the remote control holder

Caution

DO NOT install it on the following places

- 1) Places exposed to direct sunlight
- 2) Places near heat devices
- 3) High humidity places
- 4) Hot surface or cold surface enough to generate condensation
- 5) Places exposed to oil mist or steam directly
- 6) Uneven surface

Installation tips for the remote control holder

- Adjust and keep the holder upright.
- Tighten the screw to the end to avoid scratching the remote control.
- DO NOT attach the holder to plaster wall.

How to insert batteries

- ① Detach the back lid.
- ② Insert the batteries. (two AAA batteries)
- ③ Reattach the back lid.

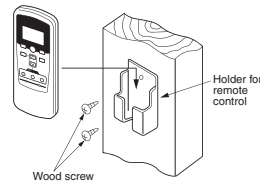

⑤ Cooling test run operation

- After safety confirmation, turn on the power.
- Transmit a cooling operation command with wireless remote control, while the backup button on the receiver is pressed.
- If the backup button on the receiver is pressed during a test run, it will end the test run.
- If you cannot operate the unit properly during a test run, please check by consulting with inspection guides on the wiring diagram of outdoor units.

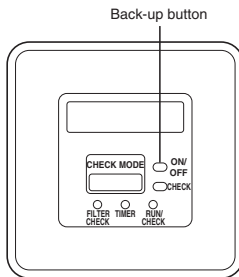

⑥ Setting of wireless remote control and receiver

(A) Methods of avoiding the malfunction due to the mixed communication

Do both procedures ① and ②.

This setting is to avoid the mixed communication with other household electric appliances or the mixed communication when two receivers are located closely.

① Setting change of the wireless remote control

Pressing **[ACL]** and **[AIRFLOW]** button at the same time or inserting the batteries with pressing **[AIRFLOW]** button will customize the signal.

Note *When the batteries are removed, the setting will return to the default setting. Make sure to reset it when the batteries are replaced.

② Setting the PCB of the receiver

Turn SW1-1 off.

• Wireless remote control

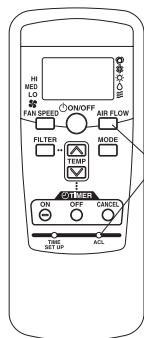

• PCB of the receiver

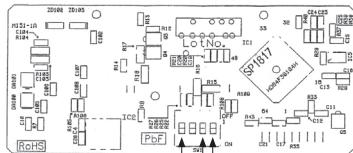

SW1-1	Customized signal setting to avoid mixed communication	ON : Normal OFF : Remote
SW1-2	Receiver master/slave setting	ON : Master OFF : Slave
SW1-4	Auto restart	ON : Valid OFF : Invalid

□ : Default setting

(B) Control plural indoor units with one remote control

Up to 16 indoor units can be connected.

① Connect the XY terminal with 2-core wire.

As for the size, refer to the following note.

② For Packaged air conditioner series, set the indoor unit address with SW2 on the indoor unit PCB from [0] to [F] so as not to duplicate.

Restrictions on the thickness and length of wire (Maximum total extension 600m.)	
Standard	Within 100m x 0.3 mm ²
	Within 200m x 0.5 mm ²
	Within 300m x 0.75mm ²
	Within 400m x 1.25mm ²
	Within 600m x 2.0 mm ²

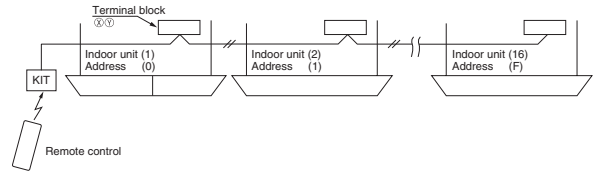

③ For VRF series, set the indoor unit address with SW1, SW2 and SW5-2 on the indoor unit PCB from [000] to [127] so as not to duplicate.

(C) Master/Slave setting when using plural remote control

Up to two receivers can be installed in one indoor unit group.

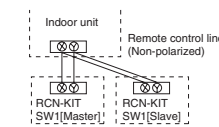

Switch	Setting	Function
SW1-2	ON	Master
	OFF	Slave

(D) Change setting of auto mode operation

Auto mode operation is prohibited to be selected for KX models (except for KXR models).

Therefore be sure to change setting of remote control to disable the auto mode operation for these models according to the following procedure.

While pressing the **[MODE]** button, press the **[ACL]** switch, or while pressing the **[MODE]** button, insert the batteries to the remote control. Then the auto mode can be invalid.

Attention

When the batteries are removed, it is returned to initial setting (Auto mode becomes valid).

Accordingly when replacing the batteries, be sure to perform the above operation once again.

(E) Change setting of fan speed

While pressing the **[FAN SPEED]** button, press the **[ACL]** switch, or while pressing the **[FAN SPEED]** button, insert the batteries to the remote control. Then the fan speed can be changed from 2-speed setting to 3-speed setting.

When changing fan speed setting of remote control, be sure to perform the same fan speed setting as that of the indoor unit model to be used.

Attention

When the batteries are removed, it is returned to initial setting (Fan speed setting is 2-speed).

Accordingly when replacing the batteries, be sure to perform the above operation once again.

3.2 SIMPLE WIRED REMOTE CONTROL (RCH-E3)

Notes:
 Following functions of indoor unit series are not able to be set with this simple wired remote control (RCH-E3).
 1. 4-fan speed setting (PHi/Hi/Me/Lo) →3-fan speed setting (Hi/Me/Lo)

Names and functions of sections

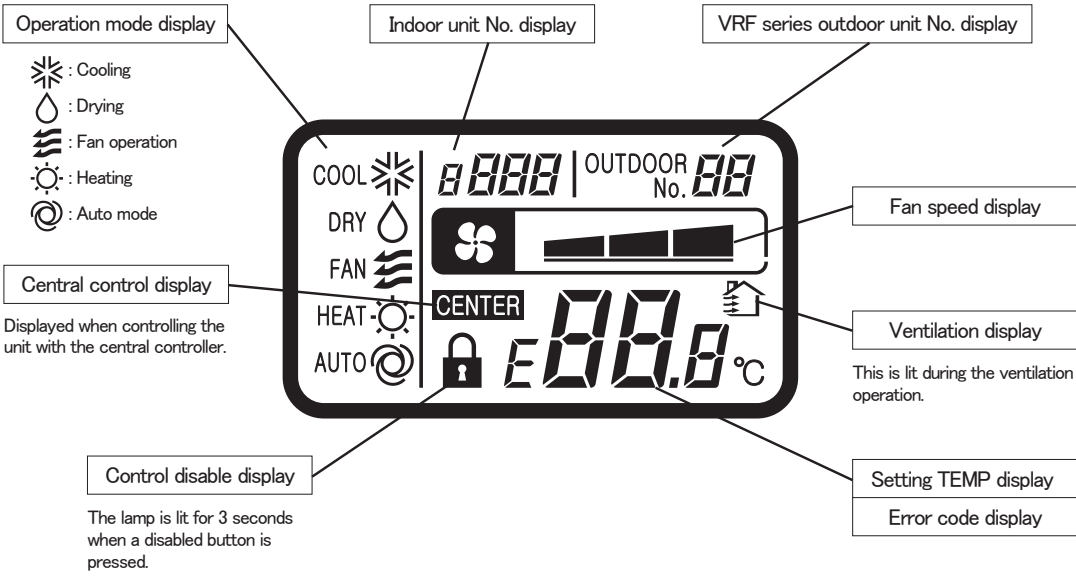
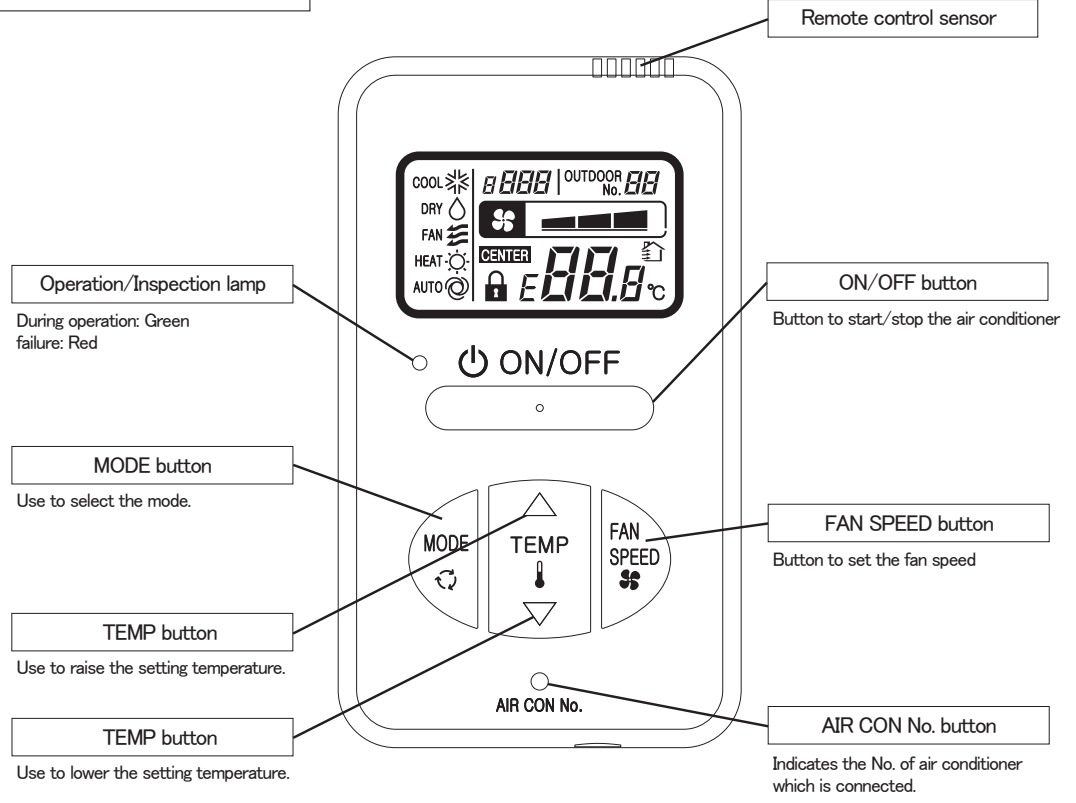

Installation of remote control

- DO NOT install the remote control at the following places in order to avoid malfunction.
- (1) Places exposed to direct sunlight
 - (2) Places near heat devices
 - (3) High humidity places
 - (4) Hot surface or cold surface enough to generate condensation
 - (5) Places exposed to oil mist or steam directly
 - (6) Uneven surface

PJZ000Z272

Remote control installation dimensions

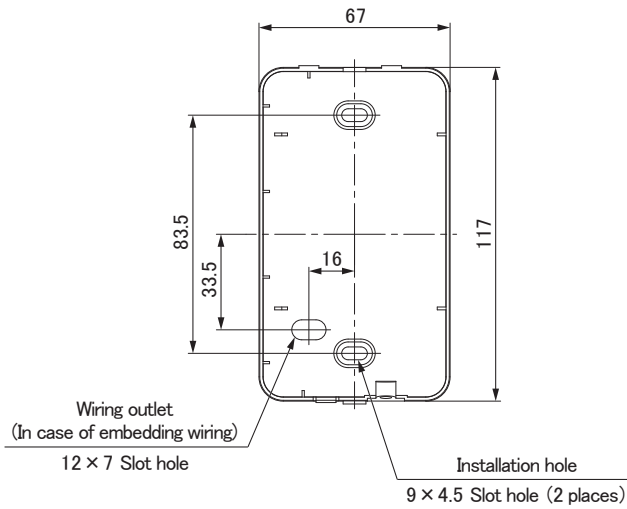

Note: Installation screw for remote control
M4 Screw (2 pieces)

In case of embedding wiring

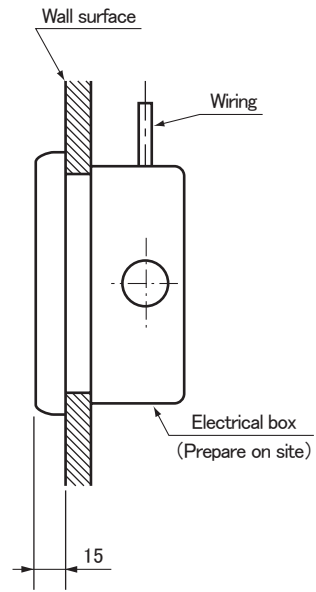

In case of exposing wiring

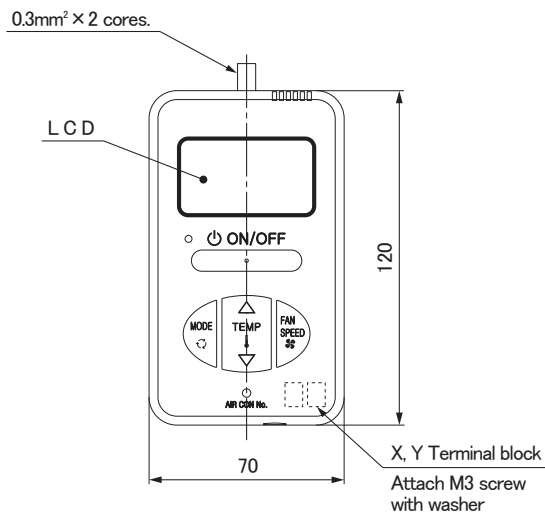

The remote control wiring can be extracted from the upper center. After the thin part in the upper side of the remote control upper case is scraped with a nipper or knife, remove burr with a file.

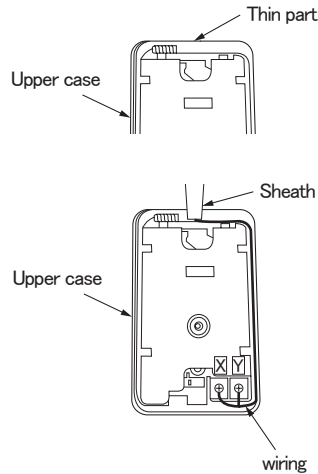

The peeling length of each wiring is as follows:

- X wiring : 160mm
- Y wiring : 150mm

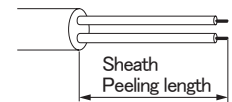

Wiring specifications

- (1) Wiring of remote control should use 0.3mm² × 2 core wires or cables. (on-site configuration)
- (2) Maximum prolongation of remote control wiring is 600m.
If the prolongation is over 100m, change to the size below.
But, the wiring in the remote control case should be 0.3mm² (recommended) to 0.5mm².
Change the wire size outside of the case according to wire connecting. Waterproof treatment is necessary at the wire connecting section. Be careful about contact failure.

Unit:mm

Length	Wiring thickness
100 to 200m	0.5mm ² × 2 cores
Under 300m	0.75mm ² × 2 cores
Under 400m	1.25mm ² × 2 cores
Under 600m	2.0mm ² × 2 cores

Adapted to **RoHS** directive

Simple Remote Control Installation Manual

PJZ012D069

Read together with indoor unit's installation manual.

WARNING

● **Fasten the wiring to the terminal securely and hold the cable securely so as not to apply unexpected stress on the terminal.**



Loose connection or hold will cause abnormal heat generation or fire.

● **Make sure the power supply is turned off when electric wiring work.**



Otherwise, electric shock, malfunction and improper running may occur.

CAUTION

● **DO NOT install the remote control at the following places in order to avoid malfunction.**

- | | |
|---------------------------------------|---|
| (1) Places exposed to direct sunlight | (4) Hot surface or cold surface enough to generate condensation |
| (2) Places near heat devices | (5) Places exposed to oil mist or steam directly |
| (3) High humidity places | (6) Uneven surface |



● **DO NOT leave the remote control without the upper case.**

In case the upper case needs to be detached, protect the remote control with a packaging box or bag in order to keep it away from water and dust.



Accessories	Remote control, wood screw (φ 3.5 × 16) 2 pieces
Prepare on site	Remote control cord (2 cores) (Refer to [2. Installation and wiring of remote control]) [In case of embedding cord] Electrical box, M4 screw (2 pieces) [In case of exposing cord] Cord clamp (if needed)

1. Installation procedure

In case of embedding cord

- (1) **Make certain to remove** the screw on the bottom surface of the remote control.

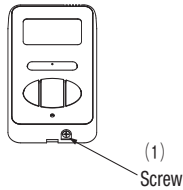

- (2) Remove the upper case of the remote control.
Insert a flat-blade screwdriver to a concave portion of the bottom surface of the remote control and slightly twist it, and the case is removed.

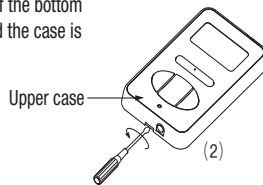

- (3) Pre-bury the electrical box and remote control cord.

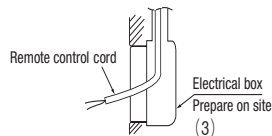

- (4) Prepare two M4 screws (recommended length: 12 – 16mm), and install the lower case to the electrical box. Do not use a screw whose screw head is larger than the height of the wall around the screw hole.

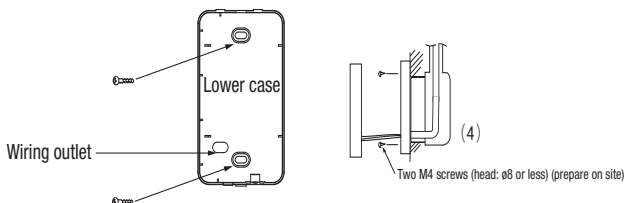

- (5) Connect the remote control cord to the terminal block.
Connect the terminals (X and Y) of the remote control and the terminals (X and Y) of the indoor unit. (No polarity of X and Y)

- (6) Mount the upper case for restoring to its former state so as not to crimp the remote control cord, and secure with the removed screw.

In case of exposing cord

- (1) **Make certain to remove** a screw on the bottom surface of the remote control.

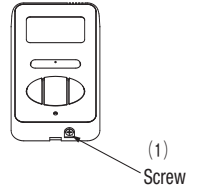

- (2) Remove the upper case of the remote control.
Insert a flat-blade screwdriver to a concave portion of the bottom surface of the remote control and slightly twist it, and the case is removed.

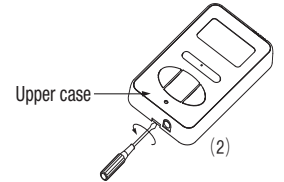

- (3) The remote control cord can be extracted from the upper center.
After the thin part in the upper side of the remote control upper case is scraped with a nipper or knife, remove burr with a file.

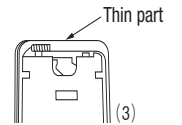

- (4) The lower case of the remote control is mounted to a flat wall with two accessory wood screws.

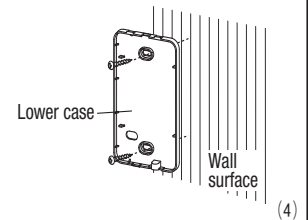

- (5) Connect the remote control cord to the terminal block.
Connect the terminals (X and Y) of the remote control and the terminals (X and Y) of the indoor unit. (No polarity of X and Y)
The wiring route is as shown in the right.

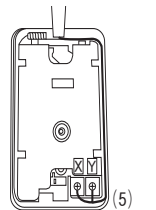

The wiring in the remote control case should be 0.3 mm² (recommended) to 0.5 mm² at maximum.

Further, peel off the sheath.

The peeling length of each wiring is as follows:

X wiring : 160mm
Y wiring : 150mm

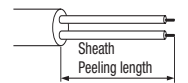

- (6) Mount the upper case for restoring to its former state so as not to crimp the remote control cord, and secure with the removed screw.

- (7) In the case of exposing installation, secure the remote control cord to the wall surface with a cord clamp so as not to loosen the remote control cord.

2. Installation and wiring of remote control

- (1) Wiring of remote control should use 0.3mm² × 2 core wires or cables. (on-site configuration)
- (2) Maximum prolongation of remote control wiring is 600 m.
If the prolongation is over 100m, change to the size below.
But, the wiring in the remote control case should be 0.3mm² (recommended) to 0.5mm².
Change the wire size outside of the case according to wire connecting. Waterproof treatment is necessary at the wire connecting section. Be careful about contact failure.
- | | |
|------------|-------------------------------|
| 100 - 200m | 0.5mm ² × 2 cores |
| Under 300m | 0.75mm ² × 2 cores |
| Under 400m | 1.25mm ² × 2 cores |
| Under 600m | 2.0mm ² × 2 cores |

3. Master/ slave setting when more than one remote control are used

- (1) Up to two remote controls can be connected to one unit (or one group) of indoor unit.

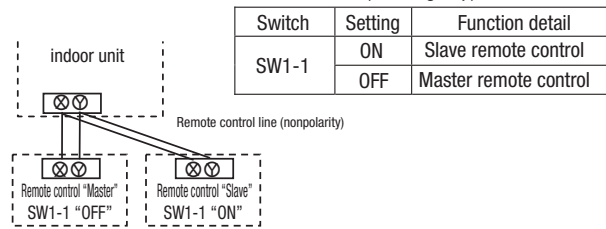

- (2) Set the switch SW1-1 of the slave remote control is "Slave" (ON). The factory default is set as "Master" (OFF).

- (Note) • The remote control thermistor enabled setting can be set only to the master remote control.
- Install the master remote control at the position to detect room temperature.
 - The air conditioner operation follows the last operation of the remote control in case of the master / slave setting.

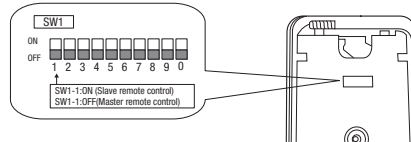

4. The indication when power source is supplied

- (1) At the time of turning the power source on, after the light is on for the first 2 seconds, the display becomes as shown below.

The number displayed on the upper side of LCD in the remote control is the software number, and this is not an error code.

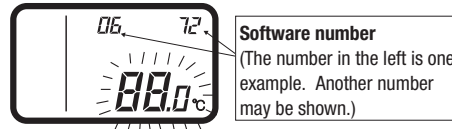

- (2) Then, "88.0 °C" blinks on the remote control until the communication between the remote control and the indoor unit is established.
- (3) In the case of connecting one remote control with one unit (or one group) of indoor unit, make certain to set the master remote control (factory default). If the slave remote control is set, a communication cannot be established.
- (4) If a state where the communication between the remote control and the indoor unit cannot be established continues about for 30 minutes, "E" is displayed. Confirm the wiring of the indoor unit and the outdoor unit and master/slave setting of the remote control.



5. Confirmation method for return air temperature

Return air temperature can be confirmed by the remote control operation.

- (1) Press **AIR CON NO.** button for over 5 seconds.
 "88" blinks on the temperature setting indicator.
 ("88" blinks for approximately 2 seconds while data is read.)



Then, the return air temperature is displayed.
 (Example) return air temperature: "27 °C" (blinking)

(Note) For the return air temperature, in the normal case, the return air temperature of the indoor unit is displayed; however, in the case that the remote control thermistor is effective, detected temperature by the remote control thermistor is displayed.

- (2) Press **ON/OFF** button.
 End.

[In the case that the remote thermistor is ineffective and plural indoor units are connected to one remote control]

- (1) Press **AIR CON NO.** button for over 5 seconds.
 indoor unit No. indicator: "U 000" (blinking)
 (Among the connected indoor units, the lowest number is displayed.)



- (2) Press **TEMP Δ** or **TEMP ▽** button.
 Select the indoor unit No.

- (3) Press **MODE** button.
 Decider the indoor unit No.
 (Example) indoor unit No. indicator: "U 000"

"88" blinks on the temperature setting indicator. (blinking for approximately 2 to 10 seconds while data is read) Then, the return air temperature is displayed. When **AIR CON NO.** is pressed, return to the indoor unit selection display (example, "U 000").

- (4) Press **ON/OFF** button.
 End.

6. Function setting

Each function of the remote control and the indoor unit is automatically set to the initial setting, which is the standard use, on the occasion of connecting the remote control with the indoor unit. In the case of the standard use, the setting change is unnecessary. However, if you would like to change the initial setting "○", change the setting for only the item of the function number. **Record the setting contents and stored them.**

(1) Function setting item by switch on PCB

Switch No.	Setting	Setting detail	Initial setting	Switch No.	Setting	Setting detail	Initial setting
SW1-1	ON	Slave remote control		SW1-5	ON	"TEMP" button prohibited	
	OFF	Master remote control	○		OFF	"TEMP" button enabled	○
SW1-2	ON	Remote control thermistor enabled		SW1-6	ON	"FAN SPEED" button prohibited	※ Note 1
	OFF	Remote control thermistor disabled	○		OFF	"FAN SPEED" button enabled	※ Note 1
SW1-3	ON	"MODE" button prohibited		SW1-7	ON	Auto restart function enabled	
	OFF	"MODE" button enabled	○		OFF	Auto restart function disabled	○
SW1-4	ON	"ON/OFF" button prohibited		SW1-8, 9, 0	ON	Not used	
	OFF	"ON/OFF" button enabled	○		OFF		

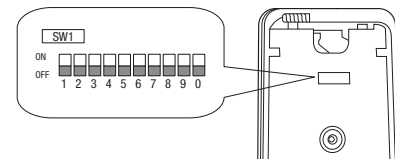

- As for the slave remote control, function setting is impossible other than SW1-1.
- In the indoor unit with only one fan speed, "FAN SPEED" button cannot be enabled.

(2) Function setting item by button operation

Classification	Function No.	Function	Setting No.	Setting	Initial setting	Remarks	
Remote control function	01	Indoor unit fan speed	01	Fan speed: three steps	※ Note 1	The fan speed is three steps, ※■■■-※■■-※■.	
			02	Fan speed: two steps (Hi-Lo)	※ Note 1	The fan speed is two steps, ※■■■-※■.	
			03	Fan speed: two steps (Hi-Me)		The fan speed is two steps, ※■■■-※■■.	
			04	Fan: one step	※ Note 1	The fan speed is fixed to one step.	
	03	Remote control thermistor at the time of cooling	01	Remote control thermistor: no offset	○		
			02	Remote control thermistor: +3.0 °C		At the time of cooling, in the case of remote control thermistor enabled, offset temperature at +3.0°C.	
			03	Remote control thermistor: +2.0 °C		At the time of cooling, in the case of remote control thermistor enabled, offset temperature at +2.0°C.	
			04	Remote control thermistor: +1.0 °C		At the time of cooling, in the case of remote control thermistor enabled, offset temperature at +1.0°C.	
			05	Remote control thermistor: -1.0 °C		At the time of cooling, in the case of remote control thermistor enabled, offset temperature at -1.0°C.	
			06	Remote control thermistor: -2.0 °C		At the time of cooling, in the case of remote control thermistor enabled, offset temperature at -2.0°C.	
			07	Remote control thermistor: -3.0 °C		At the time of cooling, in the case of remote control thermistor enabled, offset temperature at -3.0°C.	
	04	Remote control thermistor at the time of heating	01	Remote control thermistor: no offset	○		
			02	Remote control thermistor: +3.0 °C		At the time of heating, in the case of remote control thermistor enabled, offset temperature at +3.0°C.	
			03	Remote control thermistor: +2.0 °C		At the time of heating, in the case of remote control thermistor enabled, offset temperature at +2.0°C.	
			04	Remote control thermistor: +1.0 °C		At the time of heating, in the case of remote control thermistor enabled, offset temperature at +1.0°C.	
			05	Remote control thermistor: -1.0 °C		At the time of heating, in the case of remote control thermistor enabled, offset temperature at -1.0°C.	
			06	Remote control thermistor: -2.0 °C		At the time of heating, in the case of remote control thermistor enabled, offset temperature at -2.0°C.	
			07	Remote control thermistor: -3.0 °C		At the time of heating, in the case of remote control thermistor enabled, offset temperature at -3.0°C.	
	05	Ventilation setting	01	No ventilator connection	○		
			02	Ventilator links air-conditioner		In case of Single split series, by connecting ventilation device to CNT of the indoor printed circuit board (in case of VRF series, by connecting it to CND of the indoor printed circuit board), the operation of ventilation device is linked with the operation of indoor unit.	
	06	"Auto" operation setting	01	"Auto" operation enabled	※ Note 1		
			02	"Auto" operation disabled	※ Note 1	"Auto" operation disabled	
	Indoor unit function	07	Operation permission/prohibition	01	Disabled	○	
				02	Enabled		Operation permission/prohibition controller is enabled.
08		External input	01	Level input	○		
			02	Pulse input			
09		Fan speed setting	01	Standard	Note2		
			02	High speed 1	Note2		
			03	High speed 2	Note2		
10		Fan remaining operation at the time of cooling	01	No remaining operation	○	After cooling stopped, no fan remaining operation	
			02	0.5 hours		After cooling stopped, fan remaining operation for 0.5 hours	
			03	1 hour		After cooling stopped, fan remaining operation for 1 hour	
			04	6 hours		After cooling stopped, fan remaining operation for 6 hours	
11		Fan remaining operation at the time of heating	01	No remaining operation	○	After heating stopped or after heating thermostat OFF, no fan remaining operation	
			02	0.5 hours		After heating stopped or after heating thermostat OFF, fan remaining operation for 0.5 hours	
			03	2 hours		After heating stopped or after heating thermostat OFF, fan remaining operation for 2 hours	
			04	6 hours		After heating stopped or after heating thermostat OFF, fan remaining operation for 6 hours	
12		Setting temperature offset at the time of heating	01	No offset	○		
			02	Setting temperature offset + 3.0 °C		The setting temperature at the time of heating is offset by +3.0 °C.	
			03	Setting temperature offset + 2.0 °C		The setting temperature at the time of heating is offset by +2.0 °C.	
			04	Setting temperature offset + 1.0 °C		The setting temperature at the time of heating is offset by +1.0 °C.	
13		Heating fan controller	01	Low fan speed	※ Note 1	At the time of heating thermostat OFF, operate with low fan speed.	
			02	Setting fan speed		At the time of heating thermostat OFF, operate with the setting fan speed.	
			03	Intermittent operation	※ Note 1	At the time of heating thermostat OFF, intermittently operate.	
			04	Fan off		At the time of heating thermostat OFF, a fan will be stopped. When the remote control thermistor is enabled, automatically set to "Fan off". Do not set at the time of the indoor unit thermistor.	
14		Return air temperature offset	01	No offset	○		
	02		Return air temperature offset +2.0 °C		Offset the return air temperature of the indoor unit by +2.0 °C.		
	03		Return air temperature offset +1.5 °C		Offset the return air temperature of the indoor unit by +1.5 °C.		
	04		Return air temperature offset +1.0 °C		Offset the return air temperature of the indoor unit by +1.0 °C.		
	05		Return air temperature offset -1.0 °C		Offset the return air temperature of the indoor unit by -1.0 °C.		
	06		Return air temperature offset -1.5 °C		Offset the return air temperature of the indoor unit by -1.5 °C.		
	07		Return air temperature offset -2.0 °C		Offset the return air temperature of the indoor unit by -2.0 °C.		

Note 1: The symbol "※" in the initial setting varies depending upon the indoor unit and the outdoor unit to be connected, and this is automatically determined as follows:

Swth No. Function No.	Function	Setting	Product model
SW1-6	"FAN SPEED" button	"FAN SPEED" button prohibited	Product model whose indoor fan speed is only one step
		"FAN SPEED" button enabled	Product model whose indoor fan speed is two steps or three steps
Remote control function 01	Indoor unit fan speed	Fan speed: three steps	Product model whose indoor unit fan speed is three steps
		Fan speed: two steps (Hi-Lo)	Product model whose indoor unit fan speed is two steps
		Fan speed: two steps (Hi-Me)	
		Fan: one step	Product model whose indoor unit fan speed is only one step
Remote control function 06	"Auto" operation setting	"Auto" operation enabled	Product model where "Auto" mode is selectable
		"Auto" operation disabled	Product model without "Auto" mode
Indoor unit function 13	Heating fan control	Low fan speed	Product model except FDUS
		Intermittent operation	FDUS

Note 2: Fan speed of "High speed" setting

Fan speed setting	Indoor unit fan speed setting		
	※■■■-※■■-※■	※■■■-※■	※■■■-※■■
Standard	Hi - Mid - Lo	Hi - Lo	Hi - Mid
High speed 1・2	UHi - Hi - Mid	UHi - Mid	UHi - Hi

Initial setting of some indoor unit is "High speed".

Note 3: As for plural indoor unit, set indoor functions to each master and slave indoor unit. But only master indoor unit is received the setting change of indoor unit function "07 Operation permission/prohibition" and "08 External input".

7. How to set functions by button operation

- (1) Stop air-conditioning, and simultaneously press **AIR CON NO.** and **MODE** buttons at the same time for over three seconds.

The function number "01" blinks in the upper right.

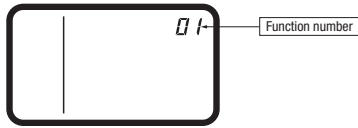

- (2) Press **TEMP▲** or **TEMP▼** button. Select the function number.

- (3) Press **MODE** button. Decide the function number.

- (4) [In the case of selecting the remote control function (01-06)]

- ① The current setting number of the selected function number blinks

(Example)

Function number: "01" (lighting)
Setting number: "01" (blinking)

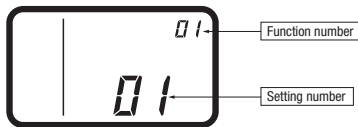

- ② Press **TEMP▲** or **TEMP▼** button. Select the setting number.

- ③ Press **MODE** button. The setting is completed.

Light is on for approximately 3 to 20 seconds while data of the decided function No. and setting No. is transmitted.

(Example)

Function number: "01" (lighting for 3 to 20 seconds)
Setting number: "01" (lighting for 3 to 20 seconds)

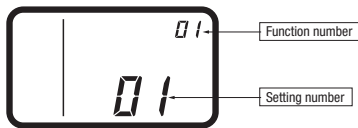

Then, the screen goes back to the function number blinking indication (1), if the setting is sequentially conducted, continue with the same procedures. If the setting is finished, proceed to (5).

- (5) Press **ON/OFF** button. The setting is completed.

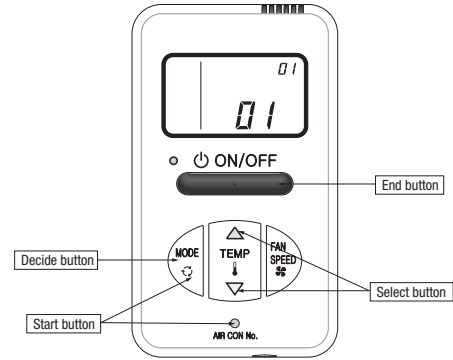

- [In the case of selecting the indoor unit function (07-14)]

- ① "88" blinks on the temperature setting indicators.

(blinking for approximately 2 to 10 seconds while data is read)



After that, the current setting number of the selected function number blinks.

(Example)

Function number: "07" (lighting)
Setting number: "01" (blinking)

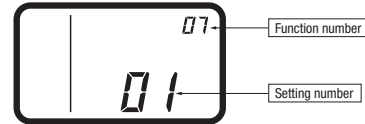

Proceed to ②.

[Note]

- a. In the case of connecting one remote control to plural indoor units, the display will be as follows:

Indoor unit No. display: "U 000" (blinking)

(Display the lowest number among the connected indoor units.)

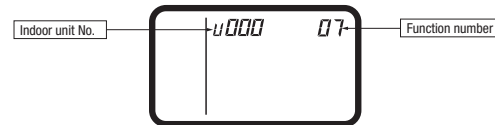

- b. Press **TEMP▲** or **TEMP▼** button.

Select the indoor unit No. to be set.

If "U ALL" is selected, the same setting can be set to all units.

- c. Press **MODE** button.

Decide the indoor unit No.

"88" blinks on the temperature setting indicators. (blinking for 2 to 10 seconds while data is read)

When **AIR CON NO.** button is pressed, go back to the indoor unit selection display (for example, "U 000" blinking).

- ② Press **TEMP▲** or **TEMP▼** button. Select the setting number

- ③ Press **MODE** button.

The setting is completed.

Light is on for approximately 3 to 20 seconds while data of the decided function No. and setting No. is transmitted.

(Example)

Indoor unit No.: "U 000" (lighting for 3 to 20 seconds)

Function number: "07" (lighting for 3 to 20 seconds)

Setting number: "01" (lighting for 3 to 20 seconds)

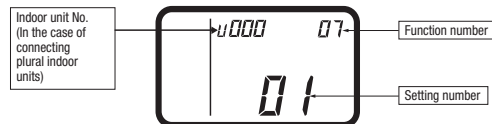

Then, the screen goes back to the function number blinking indication (1), if the setting is sequentially conducted, continue with the same procedures. If the setting is finished, proceed to (5).

- Even if **ON/OFF** button is pressed during setting, the setting is ended. However, any details where the setting has not been completed will be ineffective.
- The setting contents are stored in the controller, and even if the power failure occur, this will not be lost.

[Confirmation method for current setting]

According to the operation, the "setting number" displayed first after selecting "function number" and pressing **MODE** button is the currently set content. (However, in the case of selecting "U ALL" (all units), the setting number of the lowest number among the indoor units is displayed.)

3.3 OA SPACER (FDTC series)

This manual describes the installation methods for OA spacer (TC-OAS-E) and the duct joint (TC-OAD-E).
 ◎This OA spacer is designed for assembling on the indoor unit (FDTC Series), not for being used independently.

PJZ012D074 





Application model	FDTCA151R, 201R, FDTC A22~56KXE4R, FDTC22~56KXE6 FDTC22~56KXE6A, FDTC22~56KXE6B, FDTC22~56KXE6D FDTC40V, 50V, FDTC40~60VB, FDTC25~60VD
-------------------	--

- ◎Prepare the duct (size: ø75) and the booster fan at site.
- ◎For the installation of indoor unit, refer to the installation manual attached to the indoor unit.

SAFETY PRECAUTIONS

- Read the "SAFETY PRECAUTIONS" carefully first of all and then strictly follow it during the installation work in order to protect yourself.

WARNING

- **Installation should be performed by the specialist.**
If you install the unit by yourself, it may lead to serious trouble such as water leakage, electric shock, fire, and injury due to overturn of the unit. 
- **Install the system correctly according to these installation manuals.**
Improper installation may cause explosion, injury, water leakage, electric shock, and fire. 
- **Use the genuine accessories and the specified parts for installation.**
If parts unspecified by our company are used it could cause water leakage, electric shock, fire, and injury due to overturn of the unit. 
- **Turn off the power source during servicing or inspection work.**
If the power is supplied during servicing or inspection work, it could cause electric shock and injury by the operating fan. 
- **Shut off the power before electrical wiring work.**
It could cause electric shock, unit failure and improper running. 







CAUTION

- **Do not install and use the unit where corrosive gas (such as sulfurous acid gas etc.) or flammable gas (such as thinner, petroleum etc.) may be generated or accumulated, or volatile flammable substances are handled.**
It could cause the corrosion of heat exchanger, breakage of plastic parts etc. And inflammable gas could cause fire. 





1 Before installation

- Confirm the following parts are included:

OA spacer (TC-OAS-E)

Spacer	Bracket 1	Bracket 2	Bracket 3	Bracket 4	Bolt
					
1	2	2	2	2	8

Duct joint (TC-OAD-E)

Duct Joint	Screw	Insulation 1 (120 × 54)	Insulation 2 (40 × 60)
			
1	6	1	2

② Prior study before installation (Usage limitation)

(1) Temperature conditions for OA spacer

- Adjust the temperature conditions of mixed air with outdoor air and indoor air within the usage range of suction air temperature for the air conditioner.
- The usage temperature conditions of intake outdoor air and indoor air around the ducts are shown in the following table.
- If the temperature conditions of intake outdoor air do not meet, process the outdoor air before intaking.

Operation mode	Usage temperature conditions	
	Intake outdoor air	Indoor air around the ducts
In heating	5°C DB or higher	18.5°C WB or lower and 60% RH or lower
In cooling	29°C DB or lower and 80% RH or lower	20°C DB or higher

(2) Intake outdoor air volume

- Intake outdoor air volume is 2.6 m³/min at the maximum (when two sets of duct joints are used). Up to two sets of duct joint can be installed on OA spacer.
- In case one set of duct joint is installed: 1.3 m³/min max.
- In case two sets of duct joint is installed: 2.6 m³/min max.

(3) Selection of booster fan

- Select the booster fan based on the duct resistance plus the pressure loss at the duct joint. (See the figure)

(4) Other conditions

- Determine the capacity of air conditioner based on the calculation of air conditioning load including the heat load of intake outdoor air.
- Install the filter for the intake outdoor air and the reverse flow prevention dumper during the duct work at site.
- Insulate the duct and duct joint in order to prevent dewing.
- Interlock the operation of booster fan with ON/OFF operation of the indoor unit. (See Section 7.)

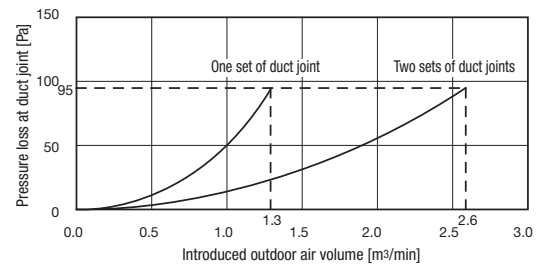
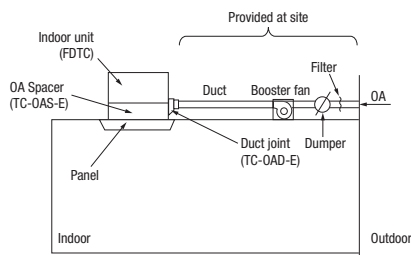
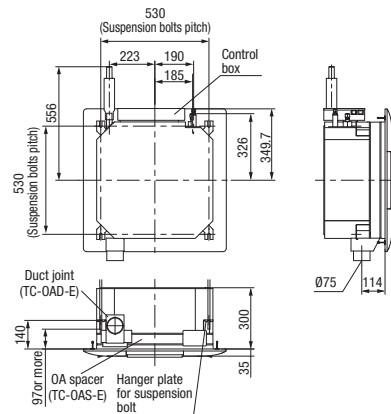

③ Installation of duct joint (TC-OAD-E) onto OA spacer

- There are two places where the duct joint can be installed.

When installing one duct joint

Install OA spacer at either one of two installation places on the duct joint.

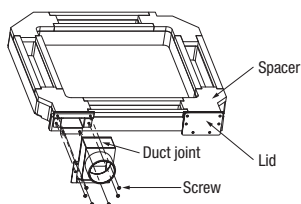

To install the duct joint, screw it in as shown at left.

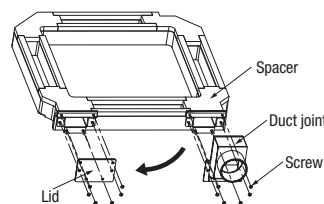

When installing the duct joint at the lid side, remove the lid and reinstall it at the other end before installing the duct joint.

When installing two duct joints

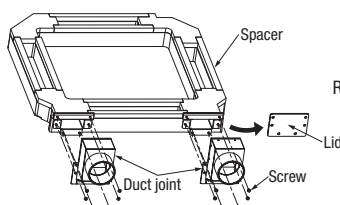

Remove the lid and then install two pieces of duct joint.

4 Installation of OA spacer on the indoor unit

OA spacer can be installed regardless whether the indoor unit has already been hanged or not.
(It is recommended to install before hanging the unit for convenience of installation.)

1-1. When installing OA spacer before hanging the indoor unit

- ① Placing OA spacer on the indoor unit, fix the brackets 1 and 2 (2 pieces each) with bolts.
Install OA spacer in the appropriate position that the duct joint side of OA spacer becomes opposite to the control box of indoor unit (FDTC).

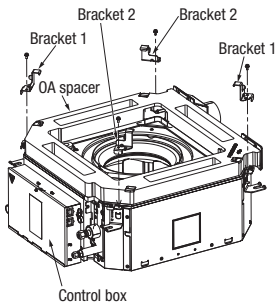

- ② Fix the brackets 3 and 4 (2 pieces each) with bolts.

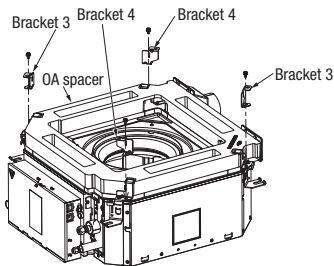

2. Applying insulation

Applying the insulation attached to duct joint set (TC-OAD-E)

- ① Applying the insulation 1 as shown in the figure.
- ② Applying the insulation 2 as shown in the figure.

* Be sure to cover the entire surface of sheet metal of the duct joint with the insulation.

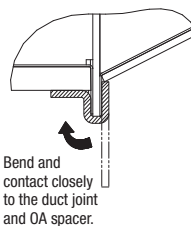
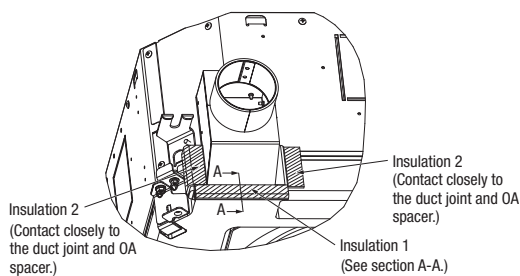

A-A

1-2. When installing OA spacer after hanging the indoor unit

- ① After hanging the indoor unit (*), fix the bracket 1 (2 pieces) temporarily with bolt by 2 turns as shown in the figure.
* For the height (position) of hanging the indoor unit, refer to Section 5.

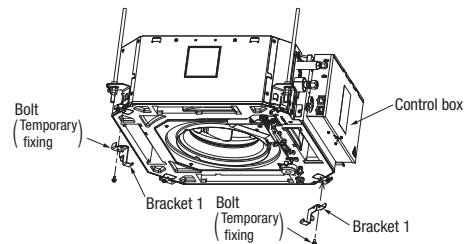

- ② Install OA spacer.
 - i. Install it in the way that the recess of OA spacer will fit on the bracket 1 fixed temporarily at the step ①.
 - ii. Tighten the bolt of bracket 1.
 - iii. Fix the bracket 2 with bolt. (Tighten up)

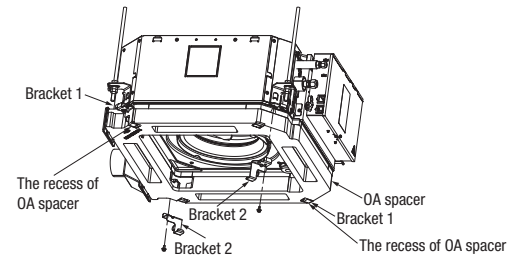

- ③ Fix the brackets 3 and 4 (2 pieces each) with bolts.

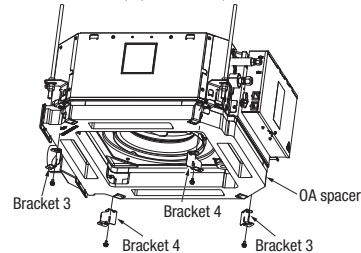

⑤ Installation of indoor unit

Work procedure

- This unit is designed for 2 x 2 grid ceiling.
If necessary, please detach the T bar temporarily before you install it.
If it is installed on a ceiling other than 2 x 2 grid ceiling, provide an inspection port on the control box side.
 - Arrange the suspension bolt at the right position (530mmx530mm).
 - Make sure to use four suspension bolts and fix them so as to be able to hold 500N load.
 - Ensure that the lower end of the suspension bolt should be 97mm above the ceiling plane. Temporarily put the four lower nuts 140mm above the ceiling plane and the upper nuts on distant place from the lower nuts in order not to obstruct hanging the indoor unit or adjust the indoor unit position, and then hang the indoor unit.
 - Adjust the indoor unit position after hanging it by inserting the level gauge (Packed together with the indoor unit.) attached on the package into the air supply port and checking if the gap between the ceiling plane and the indoor unit is appropriate. (*) In order to adjust the indoor unit position, adjust the lower nuts while the upper nuts are put on distant place. Confirm there is no backlash between the hanger plate for suspension bolt and the lower nut and washer.
- * Use the level gauge only when OA spacer has been installed before hanging (④ 1-1 only).

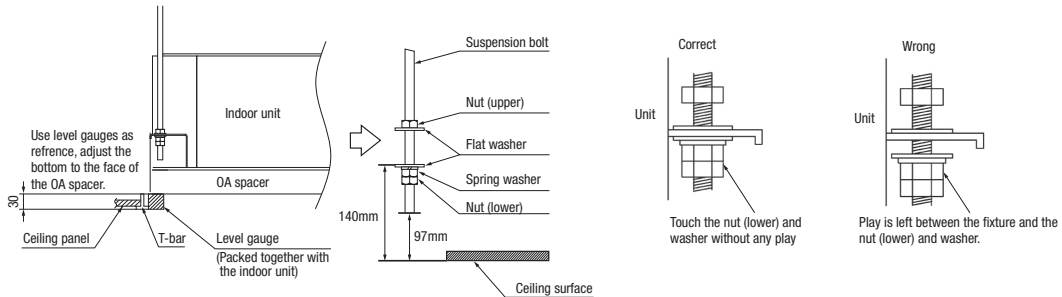

⑥ Installation of panel

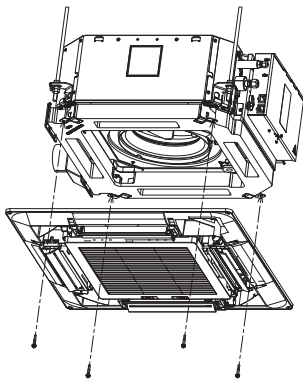

Tighten the panels to the brackets 3 and 4 with bolts.
For further details, refer to the installation manual of panel.
(Caution) Connect the connector of lower motor within the control box.

⑦ Interlocking with the indoor unit fan

- Connect the Single split series and the VRF series to CNT on the indoor PCB and to CND on the indoor PCB respectively. If a ventilation device is connected been geared with the motion of indoor device (ON: DC12V output, OFF: 0V output), the ventilation device is operated/stopped.
- Set it at "VENT LINK" by selecting "No. 11 VENT LINK SET" from the Functional setting by Remote Controller. For details, refer to the "ELECTRIC WIRNG WORK INSTRUCTION" of indoor unit.

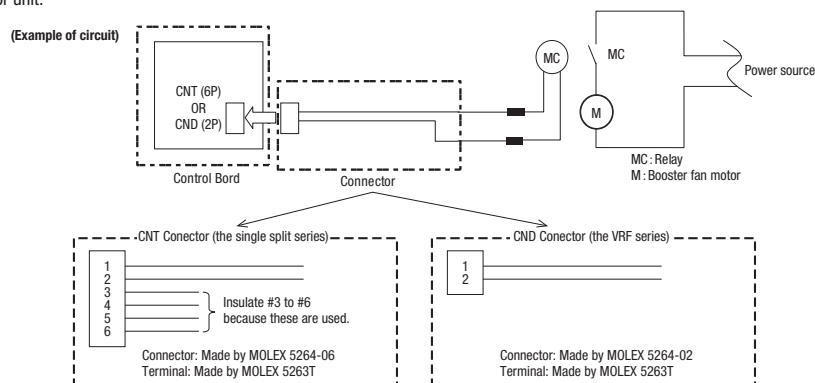

(Caution) Although the indoor unit fan stops during the defrosting or oil return operation, the booster fan is operating.
Use a total heat exchanger, if necessary.



3.4 DUCT JOINT (FDTC series)

PJZ012D073

- This product is used by assembling on the spacer (TC-OAS-E)

1. Before installation

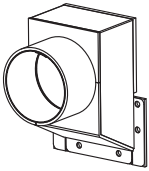
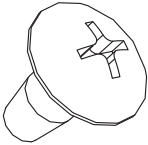
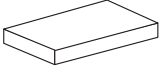
- Confirm the following parts are included:

Duct joint	Screw	Insulation 1 (120 × 54)	Insulation 2 (40 × 60)
			
1	6	1	2

2. Regarding the use of this product

- Fix the product on the spacer (TC-OAS-E) as shown below.
- For the installation method, refer to the installation manual of the spacer.

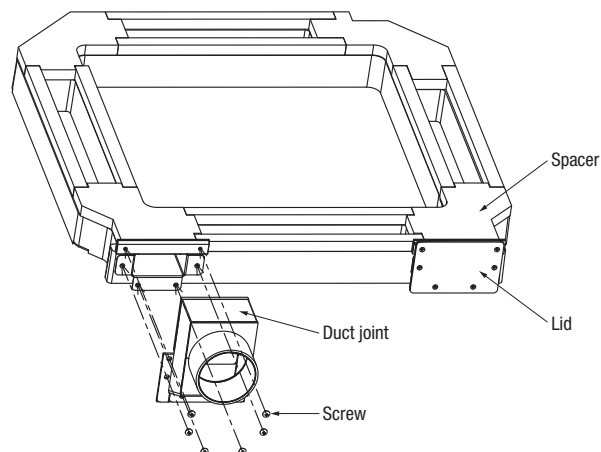

3.5 FAN CONTROLLER KIT (FDU series)

PJD012D049

This manual instructs the way of installing the optional fan controller for high static pressure ducts. Install the controller in accordance with the following procedure.

WARNING

- (1) Consult your dealer for the installation of the controller.
- (2) Only qualified electrician must install the controller.
- (3) Remove the control box before the installation.
Before installing the product, take it out from the package and place it on the floor.
- (4) Be sure to turn off the power supply during installation.
Unless the above precautions are observed, it could cause electrical shocks or fire.

<Precautions for wiring>

- Connect wires correctly as shown by the electric wiring diagram. Be sure to tighten set screws firmly to prevent them generating heat or causing other troubles after becoming loose.
- Number of wires connected to the terminal block must be 2 wires or less. Never connect 3 more wires in any event.

4. Installation procedure

- (1) Remove the lid from the control box.
- (2) Remove the wiring (fuse~CNF2,3) and wiring (TB(X)Y~CNB).

CAUTION Confirm that electricity has been discharged before touching the capacitor terminals. There is risk of electric shocks.

- (3) Install the fan controller.
- (4) Referring to "3. Electric circuit diagram", connect wires as illustrated and fix with bands @.
- (5) Reinstall the removed lid on the control box.

1. Applicable models and corresponding fan controller kit

Standard type	FDU200VF, 250VF
Fan controller kit	U-FCRA (PJZ006A102A)

2. Component parts list

Fan controller	Band	Tapping Screw
1 piece	@ (L=92) : 5 pieces	(M3: 2 pcs.) 2 pieces
Wiring A		
Wiring B		

3. Electric circuit diagram (Change the sections indicated with bald lines.)

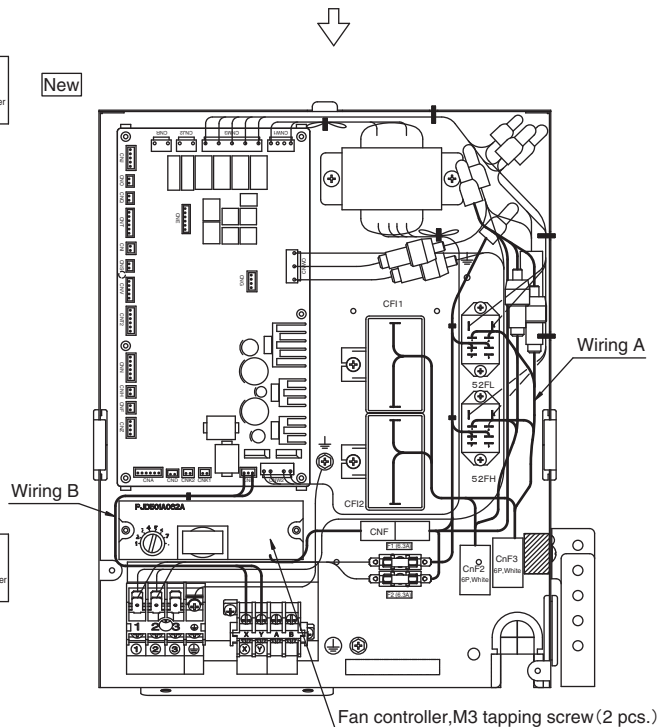
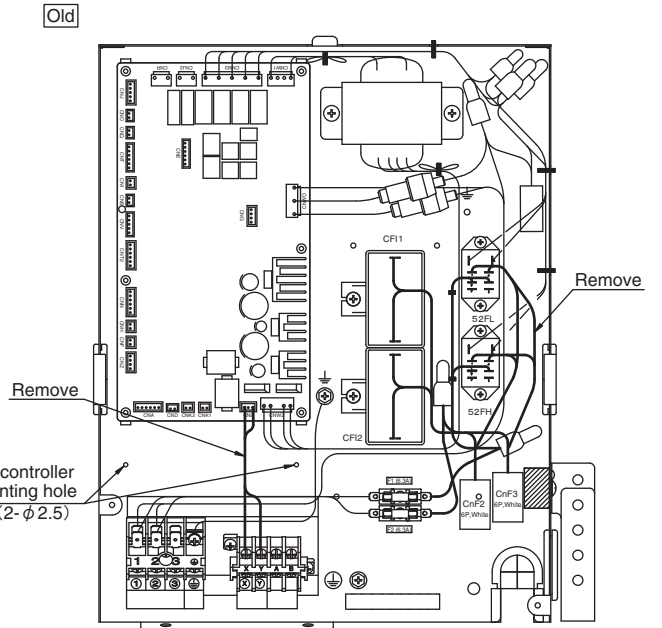
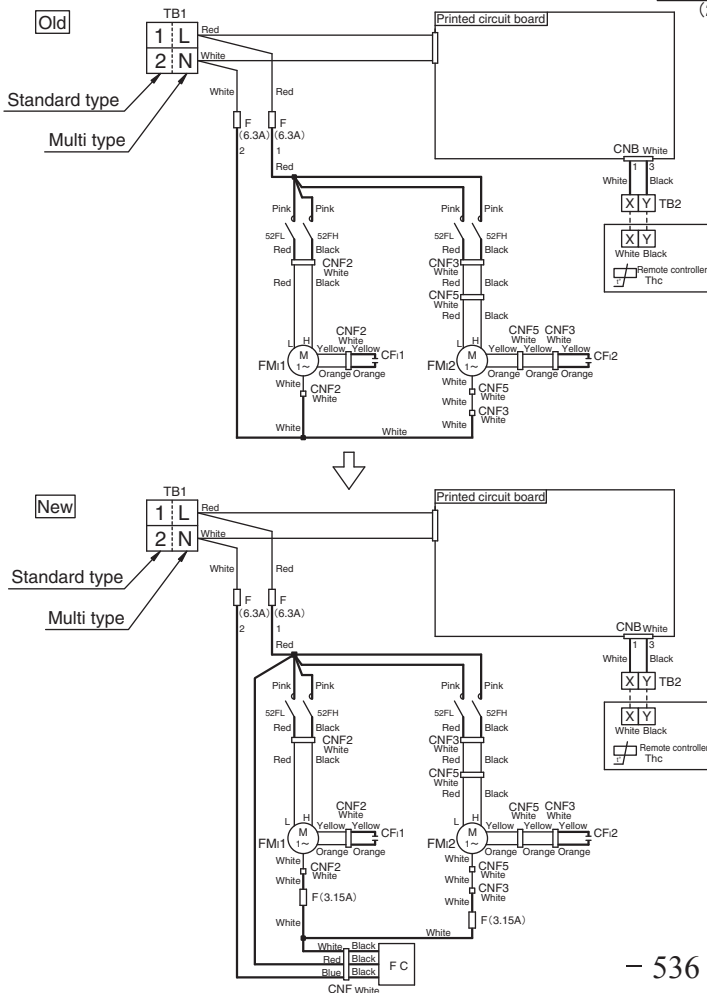

Regarding the Characteristics fan please see to page 136, 137

3.6 FILTER KIT (FDUM series)

PJZ012D076

This manual contains installation points and operating instructions for the filter kit manufactured by MHI. Carry out the work following the instructions below.

This manual also contains information on the usage after installation, so keep this manual properly with USER'S MANUAL provided with the indoor unit.





 **CAUTION**

- After unpacking, carry out this work on the ground.
- Do not carry out the work during operation, or there is a danger of being entangled in the rotating parts and getting injured.
- Clean the air filter regularly.
- Be sure to entrust qualified serviceman to performance on the air filter.
- Be sure to cut off the power and stop the unit before performing maintenance.

1. Table of filter kit parts No. and corresponding object models

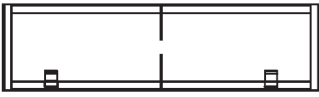
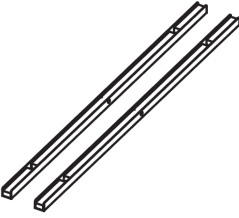
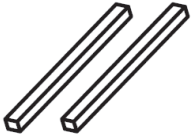
	Small model	Medium model	Large model
Single type	50	60, 71	100 - 140
Multi type	22 - 56	71, 90	112 - 160
Filter Kit	UM-FL1EF	UM-FL2EF	UM-FL3EF

2. Parts list of filter kit

Filter	Rail	Insulation
 1pc	 2pc	 2pc
Bracket	Parts set (screw)	
 1pc	 (small and medium-sized model : 5pcs.)	 (large model : 7pcs.)
	1pc	

3. Installation Points

(1) Stick the insulation on both inner sides of the duct, leaving no space up and down.

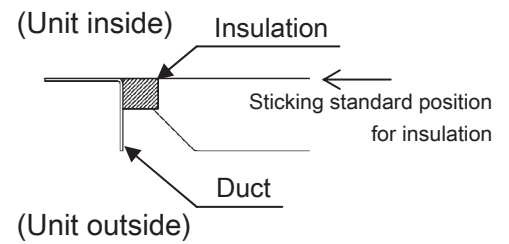
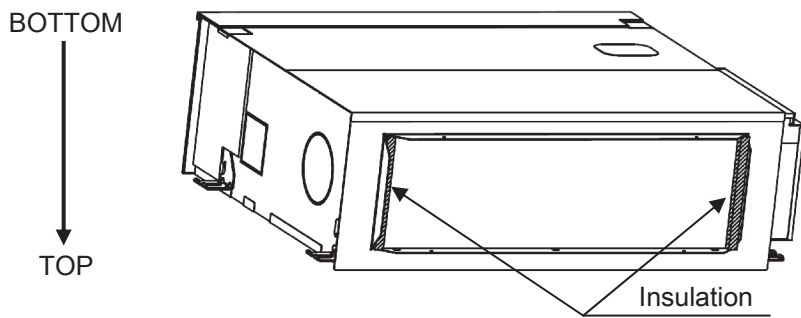

(*) After unpacking, bottom side of the unit is located at the upper side.

(2) Install the rail on both inner sides of the duct with the screw.

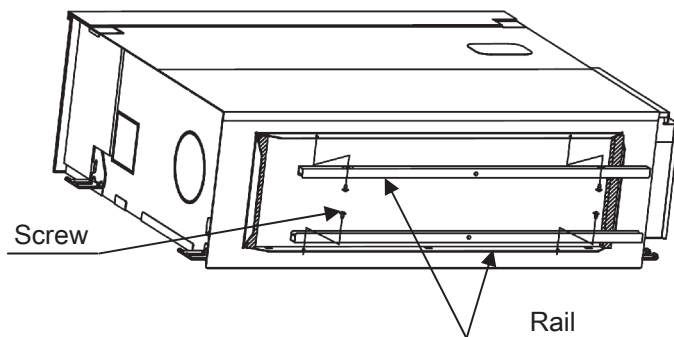

(3) Install the air filter on the rails.

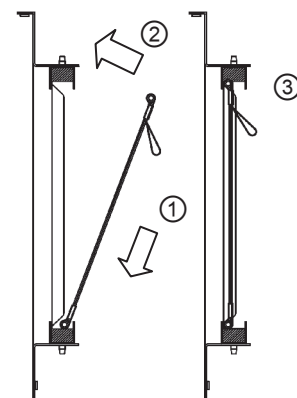
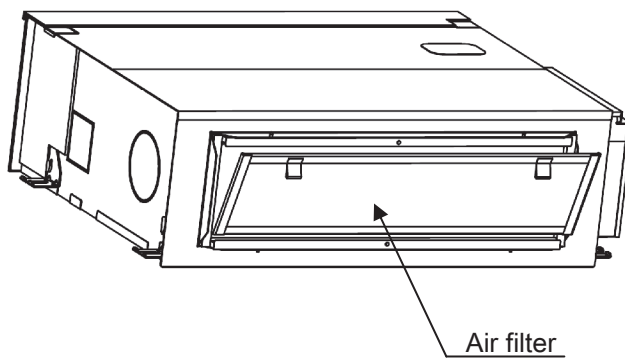

Installation procedure

(4) Install the bracket on the rail with the screw.

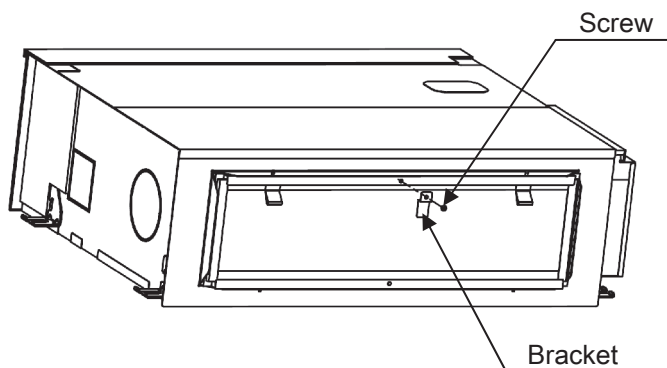

(**) When the unit is installed, bottom side of the unit is located at the lower side.

3.7 BASE HEATER KIT (CW-H-E1)

PCZ012D007A

Model Name: CW-H-E1

⚠ WARNING

- Follow the instruction and installation manual for outdoor unit when installing the heater.
- This heater must be installed by authorized personnel.
- Turn off the power supply when the kit is installed.
- Failure to follow the above will result in serious accident like electrical shock or fire.

⚠ CAUTION

- Follow the law or regulation of the country where it is installed.
- Do not alter the heater.
- Lay down the heater so that the edge of the sheet metal does not damage the heater.
- Bending radius must be bigger than 25mm.
- Do not use the heater near flammable substances.
- Be sure to check the electrical insulation before use.
- Be sure to check the drain is not trapped by the heater.
- Do not leave refrigerant oil on the base.

AREAS TO BE APPLIED

This kit is to be used in an area where the lowest temperature drops below zero.

⚠ Caution: In case the heater is not applied on the unit which is installed in an area mentioned above, it may be regarded as installation failure and warranty may not be given.

Components

- Heater : 1pc
- Bracket A : 4pcs
- Bracket B : 1pcs
- Bracket C : 1pcs
- Tapping screw (OD5) : 4pcs
- Tapping screw (OD4) : 4pcs
- Plastic band with clip : 2pcs
- Plastic band : 5pcs

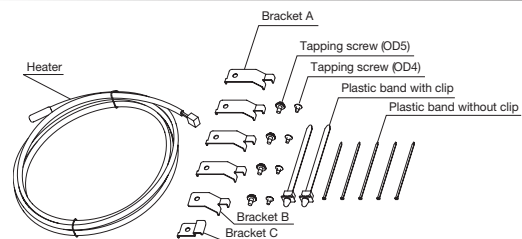

Applicable model

This heater kit is applicable for 3 different models.

<Model A>
Single fan with plastic fan guard model

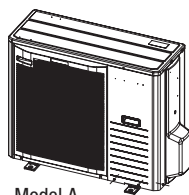

Model A

<Model B>
Single fan model

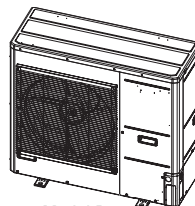

Model B

<Model C>
Double fan model

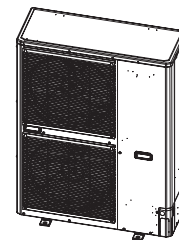

Model C

Installation procedure

Step 1

1. Remove the top panel of the outdoor unit

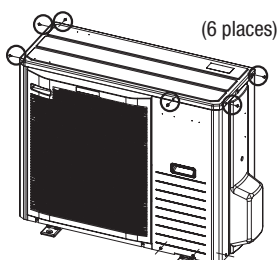

Model A

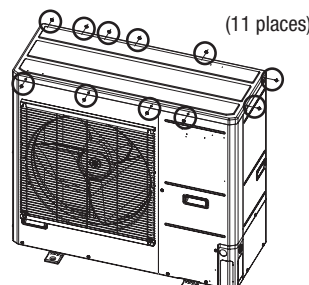

Model B

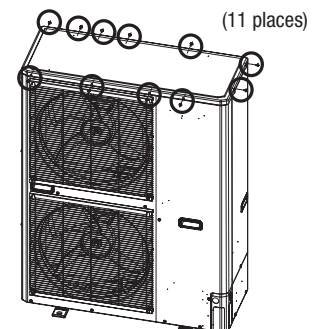

Model C

Step 2 2. Remove the service panel

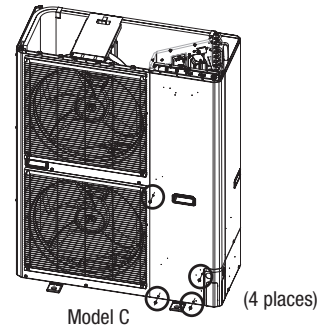
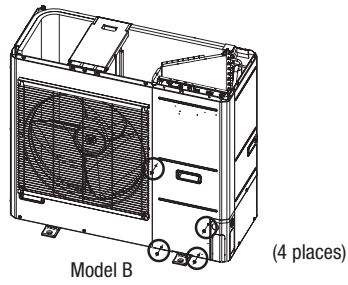
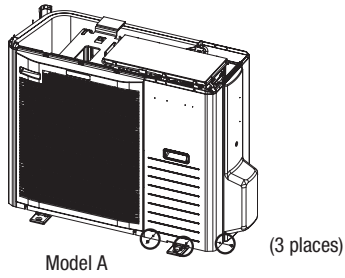

Step 3 3. Remove the front panel
Pull the panel straightforward so that the panel doesn't touch the fan blade.

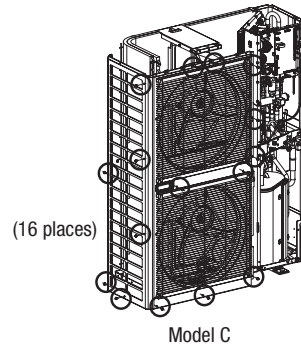
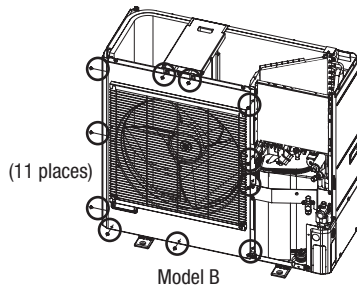
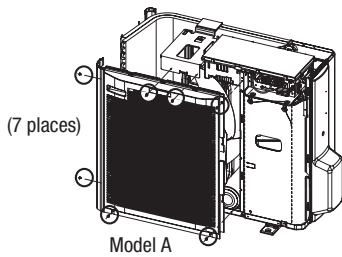

Step 4 4. Remove the fan blade if necessary. **<Note>**

Do not rotate the axis of fan motor when removing the fan blade. It may cause malfunction of the fan motor.

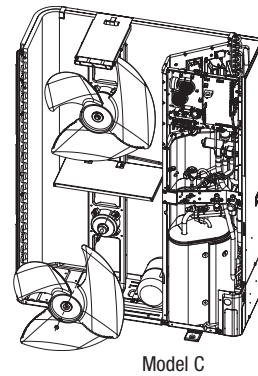
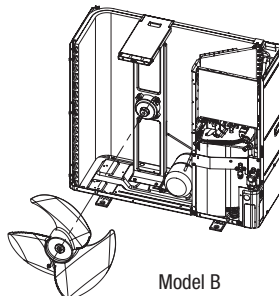
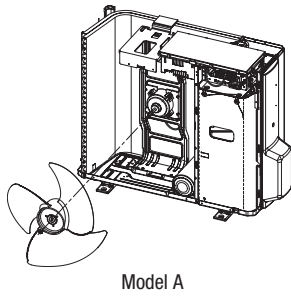

Step 5 5. Lay down the drain pan heater on the base.
For model A, put the cables rear the fan motor bracket.

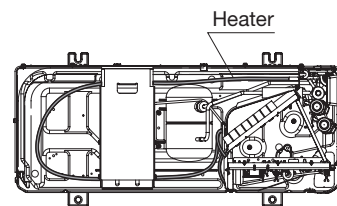
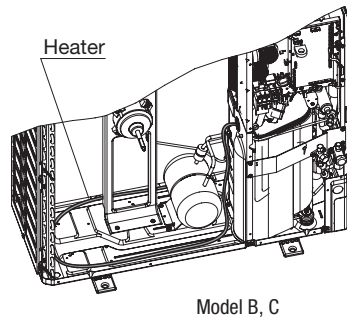
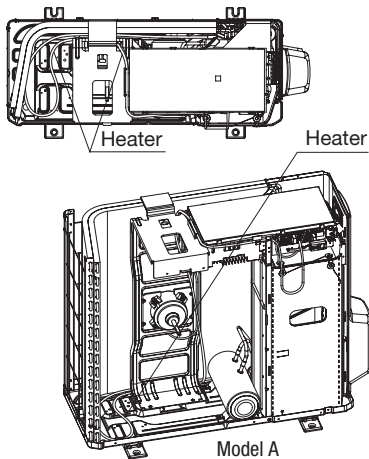

Step 6

6. Put the heater underneath the heat exchanger and align the end of heater with the end plate of heat exchanger.

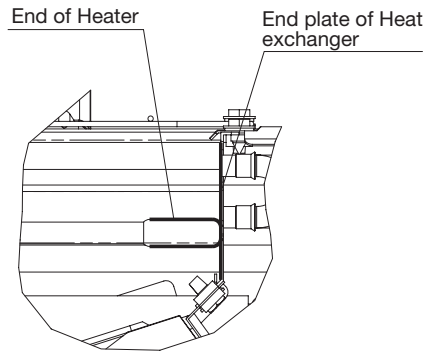

Step 7

7. Fix the heater with brackets.

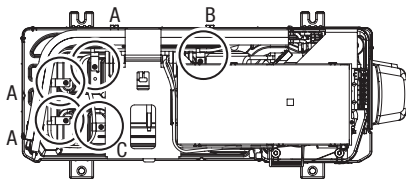

For model A, use 3 pcs of bracket A, 1 pc of bracket B and C. Fix bracket A and C with the attached screw (OD4), and fix bracket B with the removed screw which is fastened at the same place.

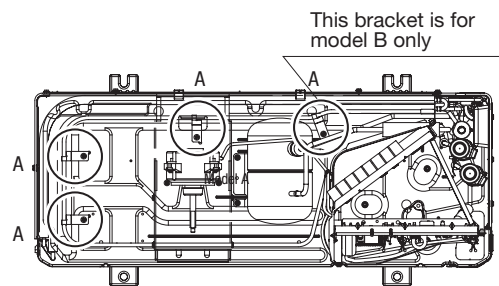

For model B and C, fix bracket A with the attached screw (OD5).

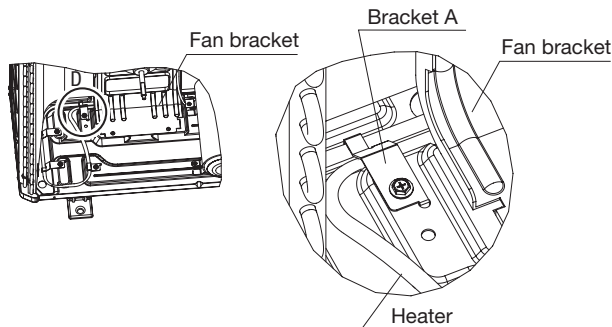

Model A

Detail view D

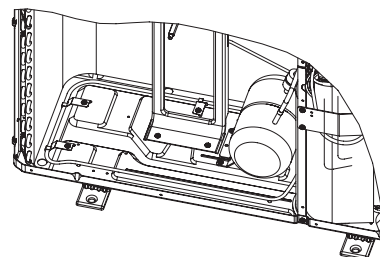

Model B, C

<Note for model A>

- 1) Put the end of heating part just after the bracket C
- 2) Fix the incoming and out going cable with one bracket A on the left of fan bracket as figure shows.

<Note>

- 1) Fix the heater so that the bracket doesn't pinch the heater as figure shows.
- 2) Place the heater so as to touch the base completely.
- 3) In bending position, twist the heater to make it easier to bend, and get back to be able to fix it with bracket.
- 4) Be careful not to be injured by aluminum fin when fixing the heater with screw.

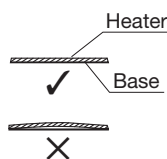
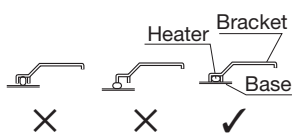

Step 8

8. Insert the plastic band with clip on the designated place (2 places), and fix the heater.(Model B,C only)

<Note>

1) Do not fasten the heating part with the plastic band.
There is a marking on the end of heating part.

2) When the heater is laid down correctly, the end of heating part comes to the corner of the base.

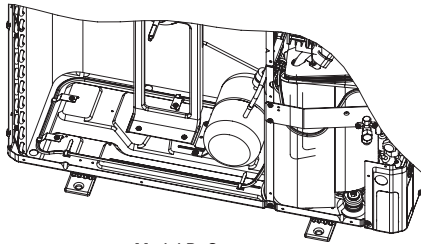
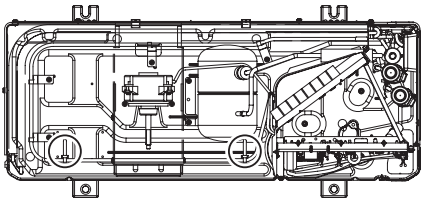

Model B, C

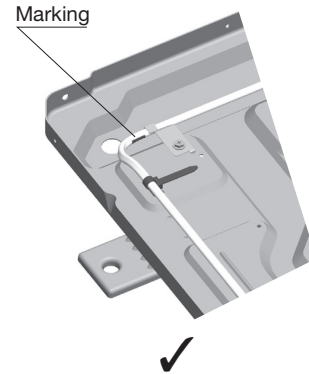
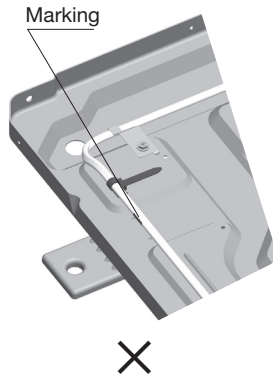

Step 9

9. Lay down the wiring on the same route of fan motor wiring, and fix the wire with attached plastic band at the same place where the fan motor wiring is banded.

Model A

Model B

Model C

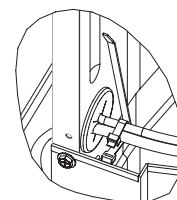
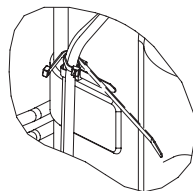
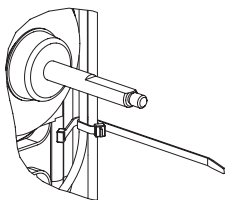
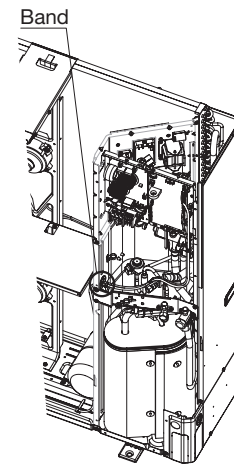
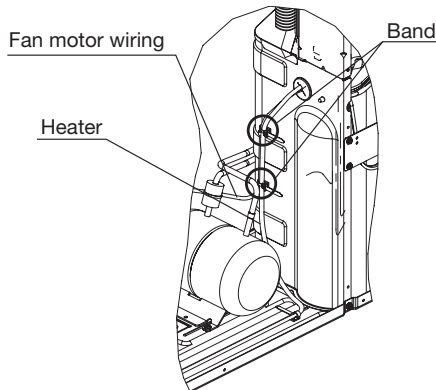
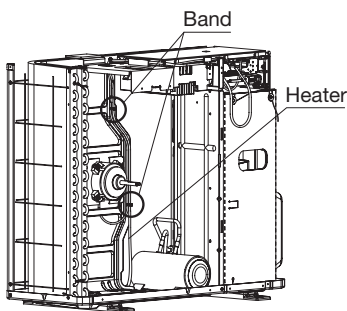

<Note>

Fan motor wiring is banded on the bracket so that it doesn't loosen.
Do not loose the band for the motor wiring to band the heater wire together but use the attached plastic band.

Step 10

10. Insert the connector to the port (Model A: CNN, Model B,C:CNF) on the PCB, and fix the wire with bands. Excess part of the wire should be dropped naturally.

<Note>

Be sure to cut the excess part of plastic band. It may cause abnormal noise when hit by fan blade or misassembling of panels. Do not bundle excess part of the wire. It may damage the heater.

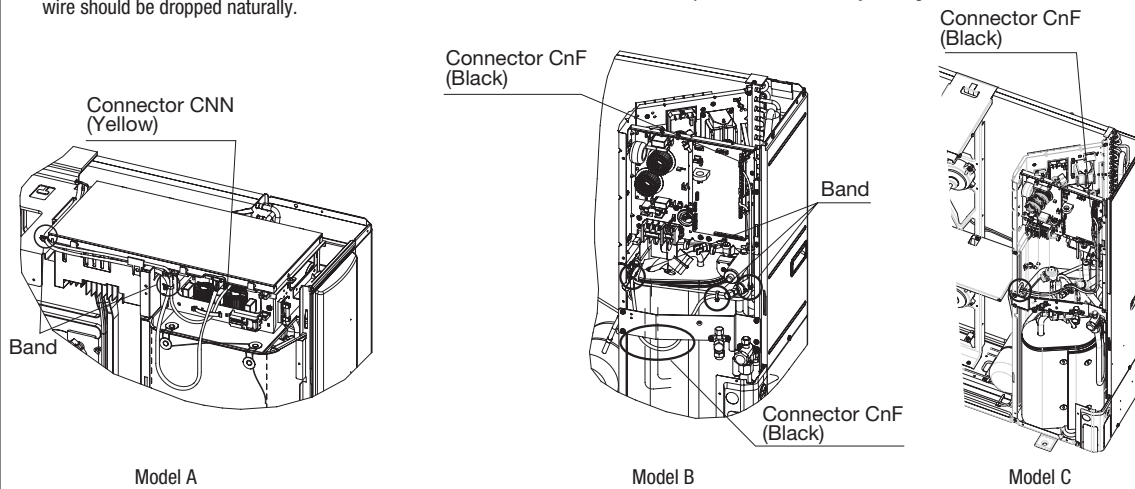

Step 11

11. Reassemble the fan blade. Take care to align the D-cut of motor shaft and the fan blade. ▽ mark on the center of the fan shows the position of D-cut.

<Note>

1. Tightening torque of the nut is 4.0-4.9 N·m.
2. Do not rotate the axis of fan motor when tightening the nut. It may cause malfunction of the fan motor.

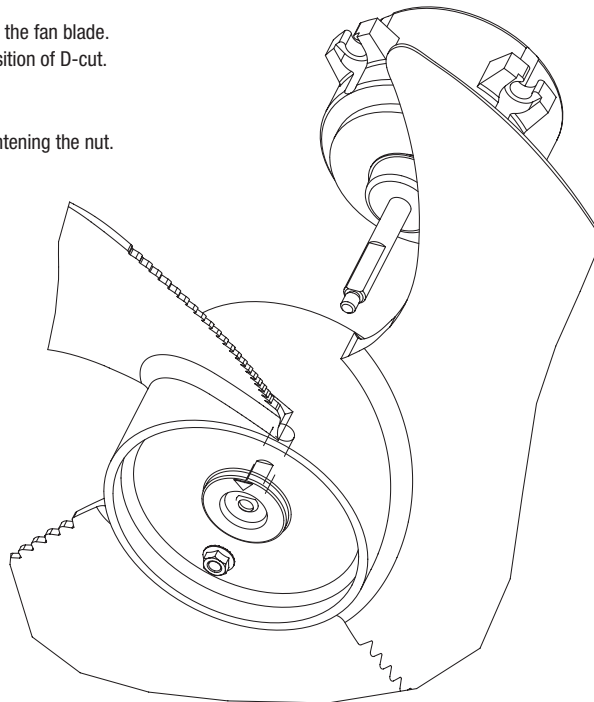

<Note>

- This heater should have bending radius of at least 25mm including non-heating part. Do not bundle the excess part of the wire. It may cause disconnection of the heater or insufficient capacity.
- Be sure to prevent the heater from touching any refrigerant piping. Especially, pay close attention not to make it touch with pipes which are close to the wiring route such as suction pipe, check valve and check joint.

Step 12

12. Reassemble the panels.

[Model A]

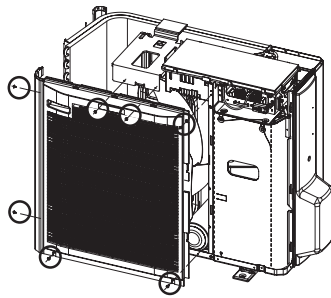

Front panel

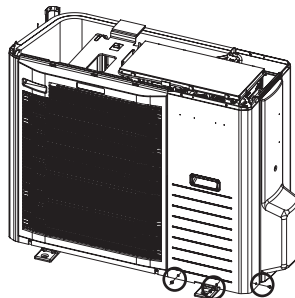

Service panel

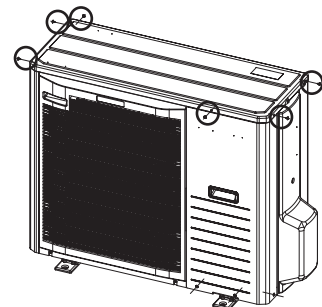

Top panel

[Model B]

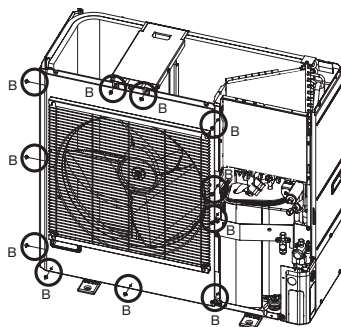

Front panel

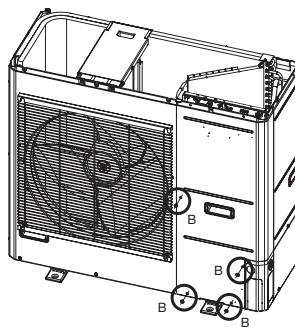

Service panel

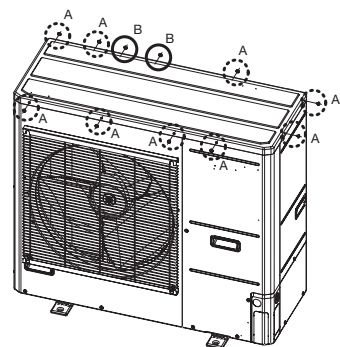

Top panel

[Model C]

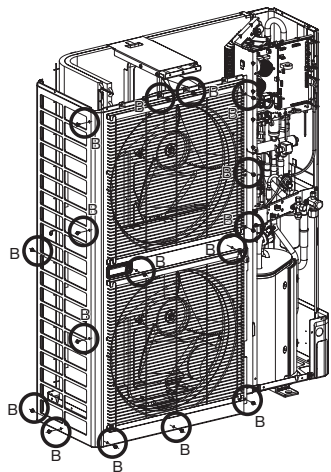

Front panel

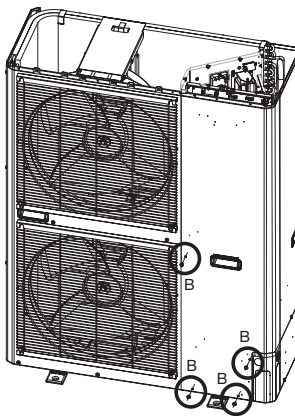

Service panel

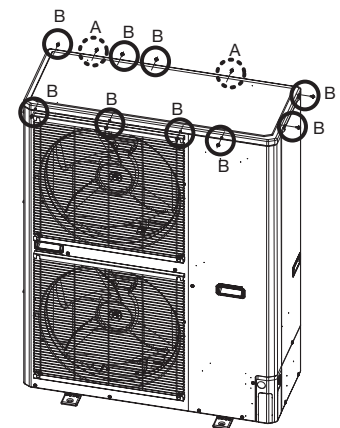

Top panel

<Note>

- 1) When reassembling the service panel, take care not to damage the front panel with the edge.
- 2) Top panel of model B and model C is fixed with two different screws.
Be sure to use correct screw as figure shows.



A



B

3.8 INTERFACE KIT (SC-BIKN-E)

RKZ012A088B

Accessories included in package

Be sure to check all the accessories included in package.

No.	Part name	Quantity
①	Indoor unit's connection cable (cable length: 1.8m)	1
②	Wood screws (for mounting the interface: φ4X 25)	2
③	Tapping screws (for the cable clamp and the interface mounting bracket)	3
④	Interface mounting bracket	1
⑤	Cable clamp (for the indoor unit's connection cable)	1
⑥*	CNT terminal connection cable (total cable length: 0.5m)	1

* SC-BIKN-EA only

Safety precautions

Before use, please read these Safety Precautions thoroughly before installation.

- All the cautionary items mentioned below are important safety related items to be taken into consideration, so be sure to observe them at all times.

Warning Incorrect installation could lead to serious consequences such as death, major injury or environmental destruction.

- Symbols used in these precautions

! Always go along these instruction.

- After completed installation, carry out trial operation to confirm no anomaly, and ask the user to keep this installation manual in a good place for future reference.

Warnings



- **Installation must be carried out by a qualified installer.**
If you install it by yourself, it may cause an electric shock, fire and personal injury, as a result of a system malfunction.
- **Install it in full accordance with the instruction manual.**
Incorrect installation may cause an electric shock, fire and personal injury.
- **Electrical work must be carried out by a qualified electrician in accordance with the technical standard for electrical equipment, the indoor wiring standard and this instruction manual.**
Incorrect installation may cause an electric shock, fire and personal injury.
- **Use the specific cables for wiring. And connect all the cables to terminals or connectors securely and clamp them with cable clamps in order for external forces not to be transmitted to the terminals directly.**
Incomplete connection may cause malfunction, and lead to heat generation and fire.
- **Use the original accessories and specified components for installation.**
If the parts other than those prescribed by us are used, it may cause an electric shock, fire and personal injury.

Connecting the indoor unit's connection cable to the interface

- ① Remove the upper case of the interface.
 - Remove 2 screws from the interface casing before removal of upper casing.
- ② Connect the indoor unit's connection cable to the interface.
 - Connect the connector of the indoor unit connection cable to the connector on the interface's circuit board.
- ③ Fix the indoor unit's connection cable with the cable clamp.
 - Cable can be brought in from the top or from the back.
 - Cut out the punch-outs for the connection cables running into the casing with cutter.
- ④ Connect the indoor unit's connection cable to the indoor control PCB.
 - Connect the indoor unit's connection cable to the indoor control PCB securely.
 - Clamp the connection cable to the indoor control box securely with the cable clamp provided as an accessory.
 - Regarding the cable connection to the indoor unit, refer to the instruction manual for indoor unit.

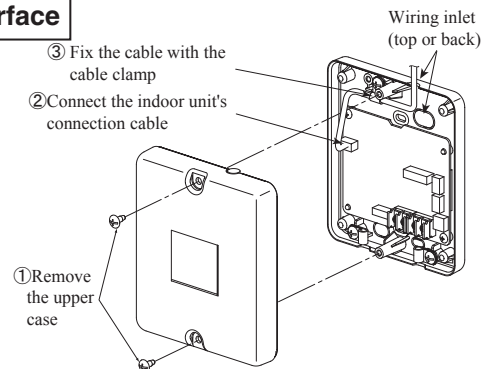

Name of each part of the interface

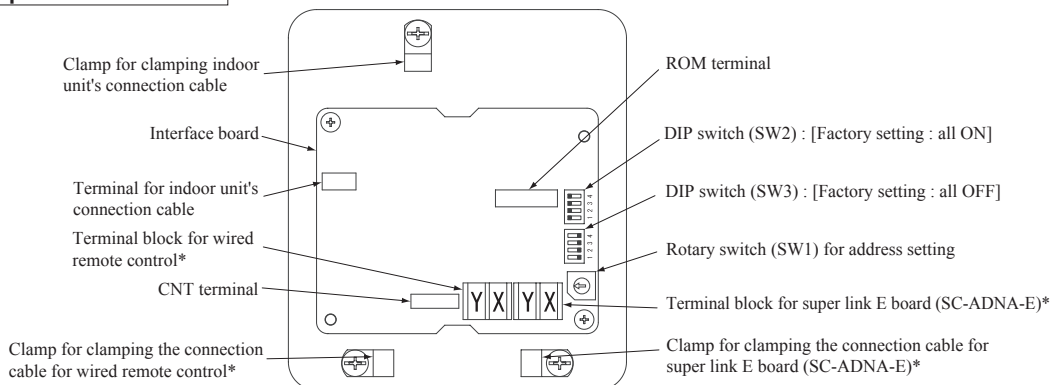

*Either the connection cables of super link E board (SC-ADNA-E) or of wired remote control is connectable.

Switch	Setting	Function	Switch	Setting	Function
SW2-1	ON**	CNT level input	SW2-3	ON**	External input (CNT input)
	OFF	CNT Pulse input		OFF	Operation permission/prohibition (CNT input)
SW2-2	ON**	Wired remote control : Enable	SW2-4	ON**	Annual cooling : Enable***
	OFF	Wired remote control : Disable		OFF	Annual cooling : Disable***

** Factory setting

*** Indoor fan control at low outdoor air temperature in cooling

Installation of the interface

- Install the interface within the range of the connection cable length (approximately 1.3m) from the indoor unit.
- Be sure not to extend the connection cable on site. If the connection cable is extended, malfunction may occur.
- Fix the interface on the wall, pillar or the like.

- DO NOT install the interface and wired remote control at the following places.
 - Places exposed to direct sunlight
 - Places near heating devices
 - High humidity places
 - Surfaces where are enough hot or cold to generate condensation
 - Places exposed to oil mist or steam directly
 - Uneven surface

Mounting the interface directly on a wall

- ① Mount the lower casing of the interface on a flat surface with wood screws provided as standard accessory.
- ② Mount the upper casing.

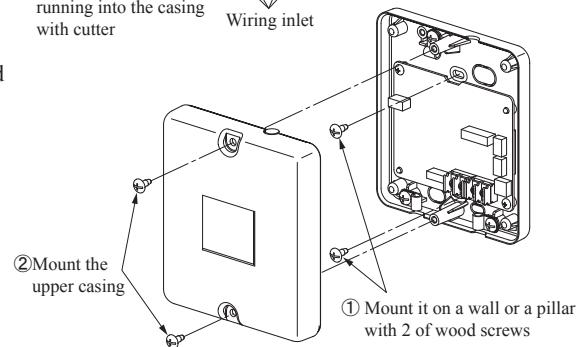
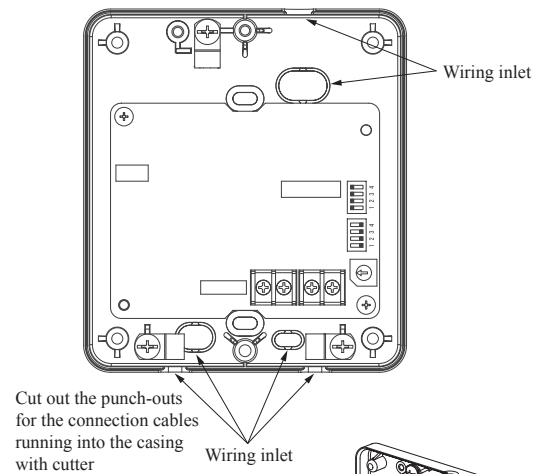

Recessing the interface in the wall

- ① Recess the electrical box (procured locally) and connection cables in the wall.
- ② Mount the lower casing of the interface to the electrical box with M4 screws (procured locally).
- ③ Mount the upper casing.

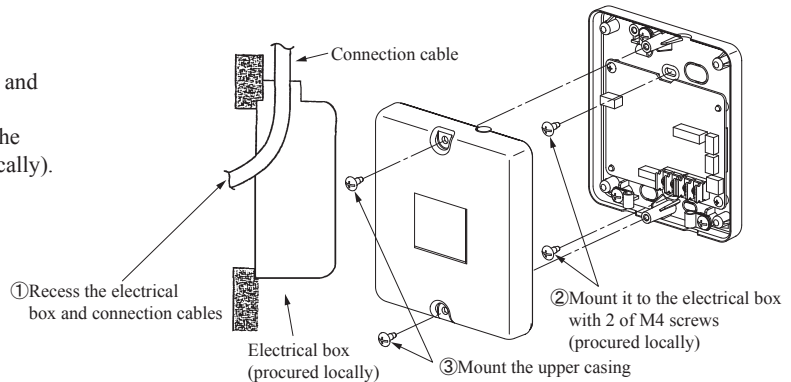

Mounting the interface with the mounting bracket

- ① Mount the mounting bracket to the interface with tapping screws provided as standard accessory.
- ② Mount the mounting bracket on wall or the like with wood screws provided as standard accessory.
- ③ Mount the mounting bracket to a wall surface, etc. using the wood screws provided.

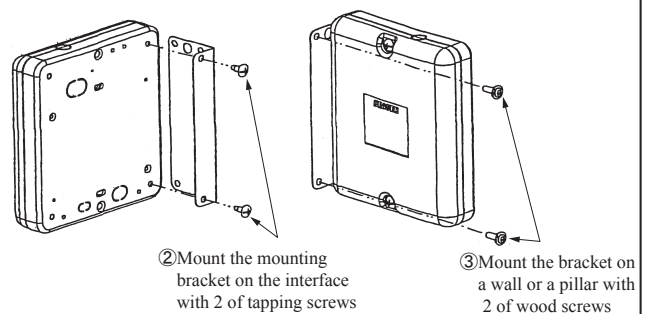

Installation check items

- Are the connection cables connected securely to the terminal blocks and connectors?
- Are the thickness and length of the connection cables conformed with the standard?

Functions of CNT connector

It is available to operate the air conditioning unit and to monitor the operation status with the external control unit (remote display) by sending the input/output signal through CNT connector on the indoor control PCB.

- ① Connect an external remote control unit (procured locally) to CNT terminal.
- ② In case of the pulse input, switch OFF the DIP switch SW2-1 on the interface PCB.
- ③ When setting operation permission/prohibition mode, switch OFF the DIP switch SW2-3 on the interface PCB.

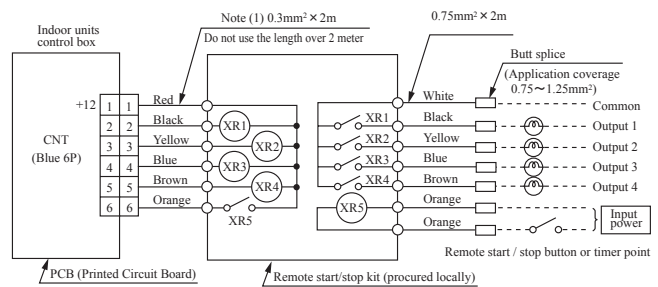

Input/Output	Function	Output signal		Content
		Relay	ON/OFF	
Output 1	Operation output	XR1	ON	During air-conditioner operation
Output 2	Heating output	XR2	ON	During heating operation
Output 3	Compressor operation output	XR3	ON	During compressor running
Output 4	Malfunction output	XR4	ON	During anomalous stop

- XR1~4 are for the DC 12V relay
- XR5 is a DC 12/24V or AC 220~240V relay
- CNT connector (local) maker, model

Connector	Molex	5264-06
Terminals	Molex	5263T

Input/Output	Function	SW2-1		SW2-3		Air-Conditioner	Operation by Remote Control				
		Setting	Setting	Input signal Level/Pulse	XR5			Content			
Input	External control input	ON*	Level input	ON*	Level	OFF→ON	External input	ON	Allowed		
					Level	ON→OFF	Operation permission	OFF			
					Level	OFF→ON	Operation prohibition	OFF			
		OFF	Pulse input	ON*	Pulse	ON*	Level	OFF→ON	External input	OFF→ON	Allowed
							Level	ON→OFF	Operation permission	ON	
							Level	ON→OFF	Operation prohibition	OFF	

* Factory setting

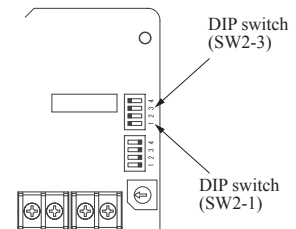

Connection of super link E board

Regarding the connection of super link E board, refer to the instruction manual of super link E board.

For electrical work, power supply for all of units in the super link system must be turned OFF.

- ① Switch ON the DIP switch SW2-2 (Factory setting: ON) on the interface PCB.
Caution: Wireless remote control attached to the indoor unit can be used in parallel, after connecting the wired remote control. However, some of functions other than the basic functions such as RUN/STOP, Temperature Setting, etc. may not work properly and may have a mismatch between the display and the actual behavior.

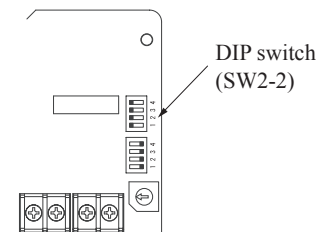

- ② Wiring connection between the interface and the super link E board.

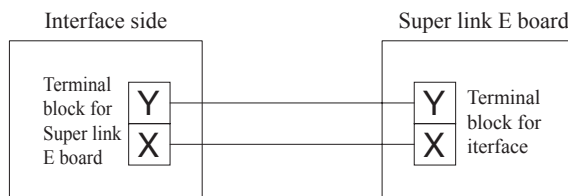

No.	Names of recommended signal wires
1	Shielded wire
2	Vinyl cabtyre round cord
3	Vinyl cabtyre round cable
4	Vinyl insulated wire/vinyl sheathed cable for control

Within 200 m 0.5 mm² × 2 cores
 Within 300 m 0.75 mm² × 2 cores
 Within 400 m 1.25 mm² × 2 cores
 Within 600 m 2.0 mm² × 2 cores

- ③ Clamp the connection cables with cable clamps.

Connection of wired remote control

Regarding the connection of wired remote control, refer to the instruction manual of wired remote control.

- Switch ON the DIP switch SW2-2 (Factory setting : ON) on the interface PCB.

Caution: Wireless remote control attached to the indoor unit can be used in parallel, after connecting the wired remote control. However, some of functions other than the basic functions such as RUN/STOP, Temperature Setting, etc. may not work properly and may have a mismatch between the display and the actual behavior.

- Wiring connection between the interface and the wired remote control.

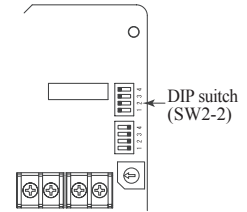

Installation and wiring of wired remote control

- Install the wired remote control with reference to the attached instruction manual of wired remote control.
 - 0.3mm² × 2-core cable should be used for the wiring of wired remote control.
 - Maximum length of wiring is 600m.
If the length of wiring exceeds 100m, change the size of cable as mentioned below.
100m-200m: 0.5mm² × 2-core, 300m or less: 0.75mm² × 2-core, 400m or less: 1.25mm² × 2-core, 600m or less: 2.0mm² × 2-core
However, cable size connecting to the terminal of wired remote control should not exceed 0.5mm². Accordingly if the size of connection cable exceeds 0.5mm², be sure to downsize it to 0.5mm² at the nearest section of the wired remote control and waterproof treatment should be done at the connecting section in order to avoid contact failure.
 - Don't use the multi-core cable to avoid malfunction.
 - Keep the wiring of wired remote control away from grounding (Don't touch it to any metal frame of building, etc.).
 - Connect the connection cables to the terminal blocks of the wired remote control and the interface securely (no polarity).
- Clamp the connection cables with cable clamps.

Control of multiple units by a single wired remote control

Multiple units (up to 16) can be controlled by a single wired remote control. In this case, all units connected with a single wired remote control will operate under the same mode and same setting temperature.

- Connect all the interface with 2-core cables of wired remote control line.
- Set the address of indoor unit for remote control communication from "0" to "F" with the rotary switch SW1 on the interface PCB.
- After turning the power ON, the address of indoor unit can be displayed by pressing [AIR CON] button on the wired remote control.
Make sure all indoor units connected are displayed in order by pressing [▲] or [▼] button.

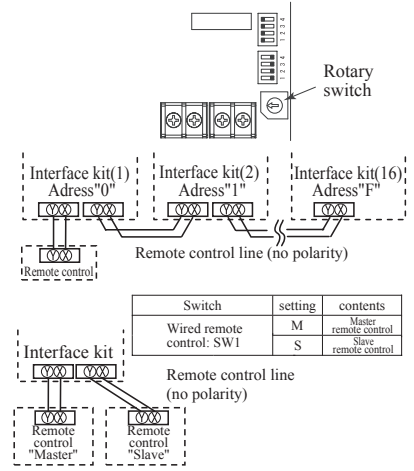

Master/Slave setting wired when 2 of wired remote control are used

- Maximum two wired remote control can be connected to one indoor unit (or one group of indoor units)
- Set the DIP switch SW1 on the wired remote control to "Slave" for the slave remote control. (Factory setting : Master)
○ Caution : Remote control sensor is invalid.

- When using the wireless remote control in parallel with the wired remote control; Since temperature setting range of wired remote control is different from that of wireless remote control, please adjust the setting range of wired remote control to be the same setting range of wireless remote control by following procedure. (The set temperature may not be displayed correctly on the wireless remote control, unless change of temperature setting range is done.)
Changing procedure of temperature setting range is as follows.

How to set upper and lower limit of temperature sting range

- Stop the air-conditioner, and press [○] (SET) and [◁] (MODE) button at the same time for 3 seconds or more.
The indication changes to "FUNCTION SET ▼"
- Press [▼] button once, and change to the "TEMP RANGE ▲" indication.
- Press [○] (SET) button, and enter the temperature range setting mode.
- Confirm that the "Upper limit ▼" is shown on the display.
- Press [○] (SET) button to fix.
- ① Indication: "↕ ∇ ^ SET UP" → "UPPER 28°C ∇ ^"
② Select the upper limit value 30°C with temperature setting button [◻]. "UPPER 30°C ∇" (blinking)
③ Press [○] (SET) button to fix. "UPPER 30°C" (Displayed for two seconds)
After the fixed upper limit value displayed for two seconds, the indication will return to "UPPER LIMIT ▼".
- Press [▼] button once, "LOWER LIMIT ▲" is selected, press [○] (SET) button to fix.
① Indication: "↕ ∇ ^ SET UP" → "LOWER 20°C ∇ ^"
② Select the lower limit value 18°C with temperature setting button [◻]. "LOWER 18°C ^" (blinking)
③ Press [○] (SET) button to fix. "LOWER 18°C" (Displayed for two seconds)
After the fixed lower limit value displayed for two seconds, the indication will return to "LOWER LIMIT ▼"
- Press [ON/OFF] button to finish.
Temperature setting range

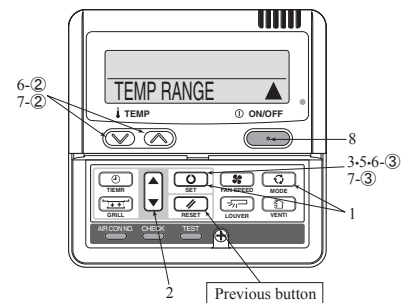

- It is possible to quit in the middle by pressing [ON/OFF] button, but the change of setting is incomplete.
- During setting, if pressing [◻] (RESET) button, it returns to the previous screen.

Mode	Temperature setting range
Cooling, Heating, Dry, Auto	18-30°C

3.8.1 Cable connection for SRK twin/triple installation

- ① Connect the same pairs number of terminal block "①,②,and ③"and "ⓧ and Ⓨ " between master and slave indoor units.
- ② Do the same address setting of all inside units belong to same refrigerant system by rotary switch SW1 on SC-BIKN-E's PCB (Printed circuit board).
- ③ Set slave indoor unit as "slave 1" through "slave 3" by address switch SW3-1, 3-2 on SC-BIKN-E's PCB.
- ④ When the AIR CON NO. button on the remote control unit is pressed after turning on the power, an indoor unit's address number will be displayed. Do not fail to confirm that the connected indoor unit's numbers are displayed on the remote control unit by pressing the ▲ or ▼ button.

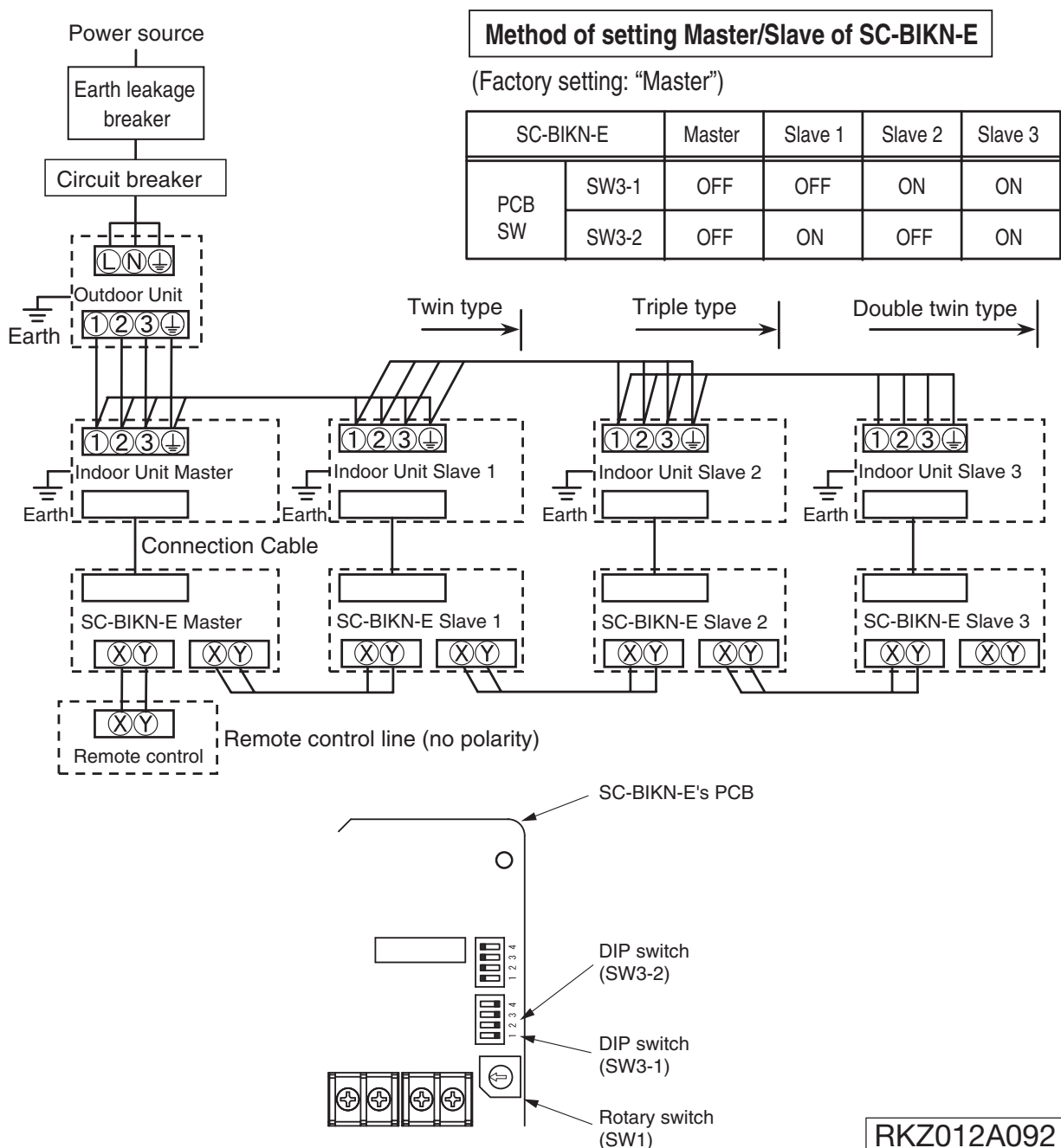

PJZ012D029F

3.9 SUPER LINK E BOARD (SC-ADNA-E)

- Read and understand the instructions completely before starting installation.
- Refer to the instructions for both indoor and outdoor units.

Safety precautions

- Carefully read “Safety precautions” first. Follow the instructions for installation.
- Precautions are grouped into “Warning⚠” and “Caution⚠”. The “Warning⚠” group includes items that may lead to serious injury or death if not observed. The items included in the “Caution⚠” group also may lead to serious results under certain conditions. Both groups are crucial for safety installation. Read and understand them carefully.
- After installation, conduct the test operation of the device to check for any abnormalities. Describe how to operate the device to the customer following the installation instruction manual. Instruct the customer to keep this installation instruction for future reference.

⚠Warning

- This device should be installed by the dealer where you purchase the device or a licensed professional shop. If the device is incorrectly installed by the customer, it may result in electric shock or fire.
- Install the device carefully following the installation instruction. If the device is incorrectly installed, it may result in electric shock or fire.
- Use the accessory parts and specified parts for installation. If any parts that do not match the specifications are used, it may result in electric shock or fire.
- A person with the electrical service certification should conduct the service based on the “Technical standards for electrical facilities”, “Electrical Wiring Code”, and the installation instruction. If the work is done incorrectly, it may result in electric shock or fire.
- Wiring should be securely connected using the specified types of wire. No external force on the wire should be applied to any terminals. If a secure connection is not achieved, it may result in electric shock or fire.

⚠Caution

- Provide ground connection.
The ground line should never be connected to the gas supply piping, the water supply piping, the lightning conductor rod, nor the telephone ground. If the grounding is improper, it may result in electric shock.
- Do not install the device in the following locations.
 1. Where there is mist/spray of oil or steam such as kitchens.
 2. Where there is corrosive gases such as sulfurous acid gas.
 3. Where there is a device generating electromagnetic waves.
These may interfere with the control system resulting in the device becoming uncontrollable.
 4. Where flammable volatile materials such as paint thinner and gasoline may exist or where they are handled. This may cause a fire.

1 Application

Indoor-to-outdoor three core communication specification type 3 (since October 2007)

2 Accessories

SL E board	Metal box	Metal cover	Screw for Ground
			M4x8L 2 pieces
Pan head screws	Locking supports	Binding band	Grommet
φ4x8L 2 pieces	To secure the print board and the metal box Made of nylon 4 pieces		

5 Connection Outline

Note for setting the address

- Set the address between 00 and 47 for the previous Super Link connection and between 000 and 127 for the new Super Link connection. (*1)
- Do not set the address overlapping with those of the other devices in the network. (The default is 000)

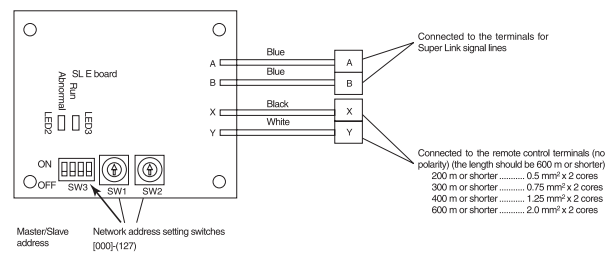

(*1) Whether the actual link is either the new Super Link or the previous Super Link depends on the models of the connected outdoor and indoor units. Consult the agent or the dealer.

3 Function

Allowing the center console SL1N-E, SL2NA-E, and SL3N-AE/BE to control and monitor the commercial air conditioning unit.

4 Control switching

Settings can be changed by the switch SW3 on the SL E board as in the following.

Switch	Symbol	Switch	Remarks
SW3	1	ON	Master
		OFF (default)	Slave
	2	ON	Fixed previous protocol
		OFF (default)	Automatic adjustment of Super Link protocol
	3	ON	Indicates the forced operation stop when abnormality has occurred.
		OFF (default)	Indicates the status of running/stop as it is, when abnormality has occurred.
	4	ON	The hundredth address activated “1”
		OFF (default)	The hundredth address activated “0”

Signal line specification

Communication method	Previous Super Link	New Super Link
Line type	MVVS	MVVS
Line diameter	0.75 - 1.25mm ²	0.75/1.25mm ²
Signal line (total length)	up to 1000m	up to 1500/1000m (*2)
Signal line (maximum length)	up to 1000m	up to 1000m

(*2) Up to 1500 m for 0.75 mm², and up to 1000 m for 1.25 mm². Do not use 2.0 mm². It may cause an error.

(*3) Connect grounding on both ends of the shielding wire. For the grounding method, refer to the section “6 Installation”.

- Set the Super Link network address with SW1 (tens place), SW2 (ones place), and SW3 (hundreds place).
- Set the SL E board SW3-1 to be ON (Master) when using this without any remote control (no wired remote control nor wireless remote control).
- Set up the plural master/slave device using the dip switches on the indoor unit board.
- Set up the remote control master/slave device using the slide switch on the remote control board.
- Set up "0" to "F" using the address rotary switch on the indoor unit board when controlling the indoor unit with the multiple remote control.

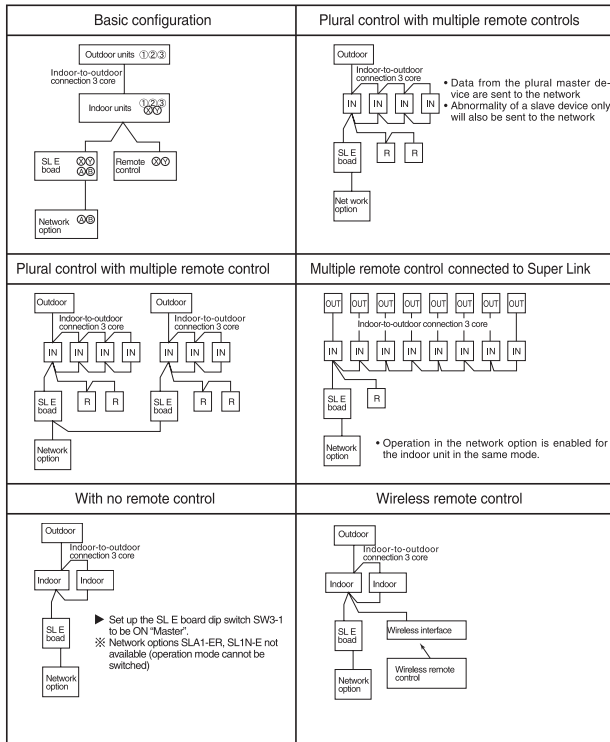

Connect grounding. Connect grounding for the power line to Ground ①, and grounding for the signal line to Ground ② or to the Ground on the indoor unit control box.

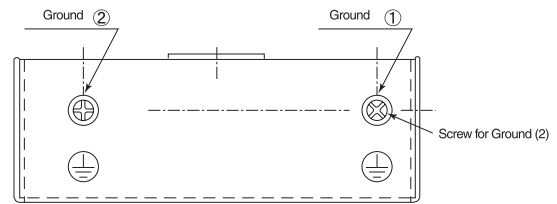

- When connecting to the indoor unit control box (ceiling-concealed type and FDT type only):

- Mount the SL E board in the control box using the locking supports.
- Remove 6 bands from the box and put the wiring through the bands to be secured.

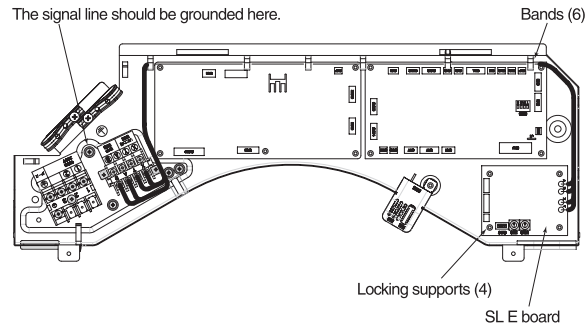

Electrical shock hazard! Make sure to turn the power off for servicing. Be cautious so that no abnormal force should be applied to the wiring. Do not damage the board with a screw driver.

The board is sensitive to static electricity. Release the static electricity of your body before servicing.
(you can do this by touching the control board which is grounded).

Location of installation

Install the device at the location where there are no electromagnetic waves nor where there is water and dust. The specified temperature range of the device is 0 to 40°C. Install the device at the location where the ambient temperature stays within the range. If it exceeds the specification, make sure to provide solution such as installing a cooling fan. When used outside of the range, it may cause abnormal operation.

6 Installation

- When using the metal box (mounted on the indoor unit / mounted on the back of the remote control):
 - Mount the SL E board in the metal box using the locking supports.
 - Wiring should go through the provided grommet since then through the wiring to the hole on the Metal box.
Secure the grommet after inserting the grommet into the Metal box as shown in below figure, then tie the wiring at the outlet of the unit using a binding band.

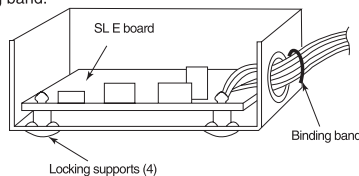

- ▲ When installed outside the indoor unit, put the metal cover on.

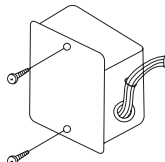

- ▲ When installed on the back of the remote control, mount it directly on the remote control bottom case.

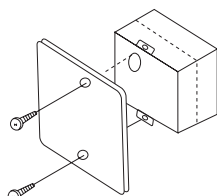

7 Indicator display

Check the LED 3 (green) and LED 2 (red) on the SL E board for flashing.

SL E board LEDs		Inspection mode	Display on the integrated network control device
Red	Green		
Off	Flashing	Normal communication	
Off	Off	<ul style="list-style-type: none"> Disconnection in the remote control communication line (X or Y) Short-circuit in the remote control communication line (between X and Y) Faulty indoor unit remote control power Faulty remote control communication circuit Faulty CPU on SL E board 	No corresponding unit number
One flash	Flashing	<ul style="list-style-type: none"> Disconnection in the Super Link signal line (A or B) Short-circuit in the Super Link signal line (between A and B) Faulty Super Link signal circuit 	
Two flashes	Flashing	<ul style="list-style-type: none"> Faulty address setting for the SL E board (Set up the address for previous SL E board : more than 48 new SL E board : more than 128) 	
Three flashes	Flashing	<ul style="list-style-type: none"> SL E board parent not set up when used without a remote control Faulty remote control communication circuit 	E1
Four flashes	Flashing	<ul style="list-style-type: none"> Address overlapping for the SL E board and the Super Link network connected indoor unit 	E2
Off	Flashing	<ul style="list-style-type: none"> Number of connected devices exceeds the specification for the multiple indoor unit control 	E10

PJZ012D029C

MICRO INVERTER PACKAGED AIR-CONDITIONERS



MITSUBISHI HEAVY INDUSTRIES THERMAL SYSTEMS, LTD.

16-5 Konan 2-chome, Minato-ku, Tokyo, 108-8215, Japan
<http://www.mhi-mth.co.jp/>

Because of our policy of continuous improvement, we reserve the right to make changes in all specifications without notice.

© Copyright MITSUBISHI HEAVY INDUSTRIES THERMAL SYSTEMS, LTD.