



SERVICE MANUAL

HYPER INVERTER PACKAGED AIR-CONDITIONERS (Split system, air to air heat pump type)

CEILING CASSETTE-4 WAY TYPE

Single type	Twin type	Triple type
FDT100VNXWVH	FDT100VNXWVPVH	FDT140VNXWTVH
100VSXWVH	100VSXWVPVH	140VSXWTVH
125VNXWVH	125VNXWVPVH	
125VSXWVH	125VSXWVPVH	
140VNXWVH	140VNXWVPVH	
140VSXWVH	140VSXWVPVH	

CEILING CASSETTE-4 WAY COMPACT TYPE

Twin type	Triple type
FDTC100VNXWVPVH	FDTC140VNXWTVH
100VSXWVPVH	140VSXWTVH
125VNXWVPVH	
125VSXWVPVH	

DUCT CONNECTED-HIGH STATIC PRESSURE TYPE

Single type
FDU100VNXWVH
100VSXWVH
125VNXWVH
125VSXWVH
140VNXWVH
140VSXWVH

DUCT CONNECTED-LOW/MIDDLE STATIC PRESSURE TYPE

Single type	Twin type	Triple type
FDUM100VNXWVH	FDUM100VNXWVPVH	FDUM140VNXWTVH
100VSXWVH	100VSXWVPVH	140VSXWTVH
125VNXWVH	125VNXWVPVH	
125VSXWVH	125VSXWVPVH	
140VNXWVH	140VNXWVPVH	
140VSXWVH	140VSXWVPVH	

CEILING SUSPENDED TYPE

Single type	Twin type	Triple type
FDE100VNXWVH	FDE100VNXWVPVH	FDE140VNXWTVH
100VSXWVH	100VSXWVPVH	140VSXWTVH
125VNXWVH	125VNXWVPVH	
125VSXWVH	125VSXWVPVH	
140VNXWVH	140VNXWVPVH	
140VSXWVH	140VSXWVPVH	

WALL MOUNTED TYPE

Single type	Twin type	Triple type
SRK100VNXWZR	SRK100VNXWPZSX	SRK140VNXWTZSX
100VSXWZR	100VSXWPZSX	140VSXWTZSX
	125VNXWPZSX	
	125VSXWPZSX	

V Multi System

(OUTDOOR UNIT)	(INDOOR UNIT)	
FDC100VNX-W	FDT50VH	FDE50VH
100VSX-W	60VH	60VH
125VNX-W	71VH	71VH
125VSX-W		
140VNX-W		
140VSX-W		

TABLE OF CONTENTS

1. HYPER INVERTER PACKAGED AIR-CONDITIONERS	2
2. V MULTI SYSTEM	199

1. HYPER INVERTER PACKAGED AIR-CONDITIONERS

CONTENTS

1.1 OUTLINE OF OPERATION CONTROL BY MICROCOMPUTER.....	5
1.1.1 Remote control (Option parts).....	5
1.1.2 Operation control function by the wired remote control	10
1.1.3 Operation control function by the indoor control	13
(I) FDT, FDTC, FDU, FDUM, FDE series	13
(1) Auto operation	13
(2) Operations of functional items during cooling/heating	14
(3) Dehumidifying (DRY) operation.....	14
(4) Timer operation	15
(5) Hot start (Cold draft prevention at heating)	16
(6) Hot keep	17
(7) Auto swing control (FDT, FDTC, FDE only).....	17
(8) Thermostat operation	18
(9) Filter sign.....	19
(10) Compressor inching prevention control.....	19
(11) Drain pump control	20
(12) Drain pump motor (DM) control.....	20
(13) Operation check/drain pump test run operation mode	20
(14) Cooling, dehumidifying frost protection	21
(15) Heating overload protection	21
(16) Anomalous fan motor	21
(17) Plural unit control - Control of 16 units group by one remote control	22
(18) High ceiling control	22
(19) Abnormal temperature sensor (return air/indoor heat exchanger) broken wire/short-circuit detection	23
(20) External input/output control (CnT or CnTA)	23
(21) Operation permission/prohibition.....	25
(22) Temporary stop input.....	27
(23) Selection of cooling/heating external input function	27
(24) Fan control at heating startup.....	28
(25) Room temperature detection temperature compensation during heating.....	28
(26) Return air temperature compensation.....	28
(27) High power operation (RC-EX3A only).....	28
(28) Energy-saving operation (RC-EX3A only).....	28
(29) Warm-up control (RC-EX3A only)	28
(30) Home leave mode (RC-EX3A only).....	28
(31) Auto temperature setting (RC-EX3A only).....	28
(32) Fan circulator operation (RC-EX3A only)	29
(33) The operation judgment is executed every 5 minutes (RC-EX3A only)	29

(34) Auto fan speed control (RC-EX3A only)	29
(35) Indoor unit overload alarm (RC-EX3A only)	29
(36) Peak-cut timer (RC-EX3A only)	29
(37) Motion sensor control (RC-EX3A and RCN-E2 only)	30
(II) SRK Seris	32
(1) Unit ON/OFF button	32
(2) Auto restart function	32
(3) Auto swing control	33
(4) Timer operation	34
(5) Outline of heating or cooling operation.....	35
(6) Indoor fan motor protection	35
(7) Serial signal transmission error protection	35
(8) Plural unit control - Control of 16 units group by one remote control	35
(9) Filter sign.....	36
(10) Outline of automatic operation	36
(11) Frost prevention control.....	37
(12) Dew prevention control	37
(13) Outline of dehumidifying (DRY) operation.....	39
1.1.4 Operation control function by the outdoor control.....	40
(1) Determination of compressor speed (Frequency).....	40
(2) Compressor start control	40
(3) Compressor soft start control	41
(4) Outdoor fan control.....	42
(5) Defrost operation.....	44
(6) Protective control/anomalous stop control by compressor's number of revolutions.....	45
(7) Silent mode	49
(8) Test run.....	49
(9) Pump-down control	49
(10) Base heater ON/OFF output control (Option).....	50
(11) Manual defrost.....	50
(12) Limit the number of compressor start.....	50
1.2 MAINTENANCE DATA.....	51
1.2.1 Diagnosing of microcomputer circuit.....	51
(1) Selfdiagnosis function	51
(2) Troubleshooting procedure.....	56
(3) Troubleshooting at the indoor unit.....	56
(4) Troubleshooting at the outdoor unit.....	68
(5) Check of anomalous operation data with the remote control	73
(6) Power transistor module (Including the driver PCB) inspection procedure ...	75
(7) Inverter checker for diagnosis of inverter output	76
(8) Outdoor unit control failure diagnosis circuit diagram	77

1.2.2 Troubleshooting flow 79
 (1) List of troubles 79
 (2) Troubleshooting..... 81
1.3 DISASSEMBLY PROCEDURE172
 (1) Indoor units.....172
 (2) Outdoor units.....184
1.4 ELECTRICAL WIRING186
 (1) Indoor units.....186
 (2) Outdoor units.....195
1.5 PIPING SYSTEM197

1.1 OUTLINE OF OPERATION CONTROL BY MICROCOMPUTER

1.1.1 Remote control (Option parts)

(1) Wired remote control

Model RC-EX3A

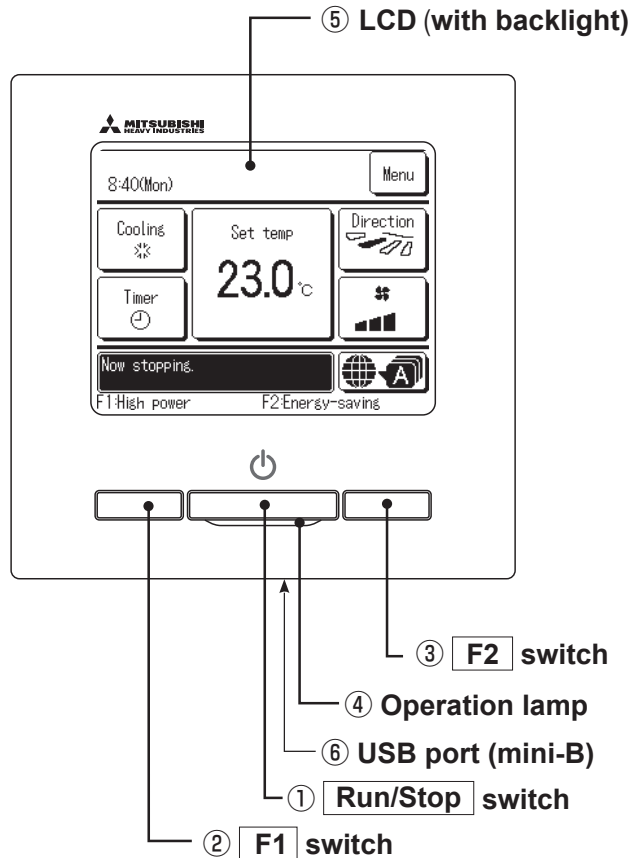

Touch panel system, which is operated by tapping the LCD screen with a finger, is employed for any operations other than the ①Run/Stop, ②F1 and ③F2 switches.

① Run/Stop switch

One push on the button starts operation and another push stops operation.

If the backlight is ON setting, when the screen is tapped while the backlight is turned off, the backlight only is turned on. (Operations with switches ①, ② and ③ are excluded.)

② F1 switch ③ F2 switch

This switch starts operation that is set in F1/F2 function change.

⑥ USB port

USB connector (mini-B) allows connecting to a personal computer.

④ Operation lamp

This lamp lights in green (yellow-green) during operation. It changes to red (orange) if any error occurs.

For operating methods, refer to the instruction manual attached to the software for personal computer (remote control utility software).

Operation lamp luminance can be changed.

Note(1) When connecting to a personal computer, do not connect simultaneously with other USB devices.

⑤ LCD (with backlight)

A tap on the LCD lights the backlight.

The backlight turns off automatically if there is no operation for certain period of time. Lighting period of the backlight lighting can be changed.

Please be sure to connect to the computer directly, without going through a hub, etc.

Model RC-E5

The figure below shows the remote control with the cover opened. Note that all the items that may be displayed in the liquid crystal display area are shown in the figure for the sake of explanation. Characters displayed with dots in the liquid crystal display area are abbreviated.

The figure below shows the remote control with the cover opened.

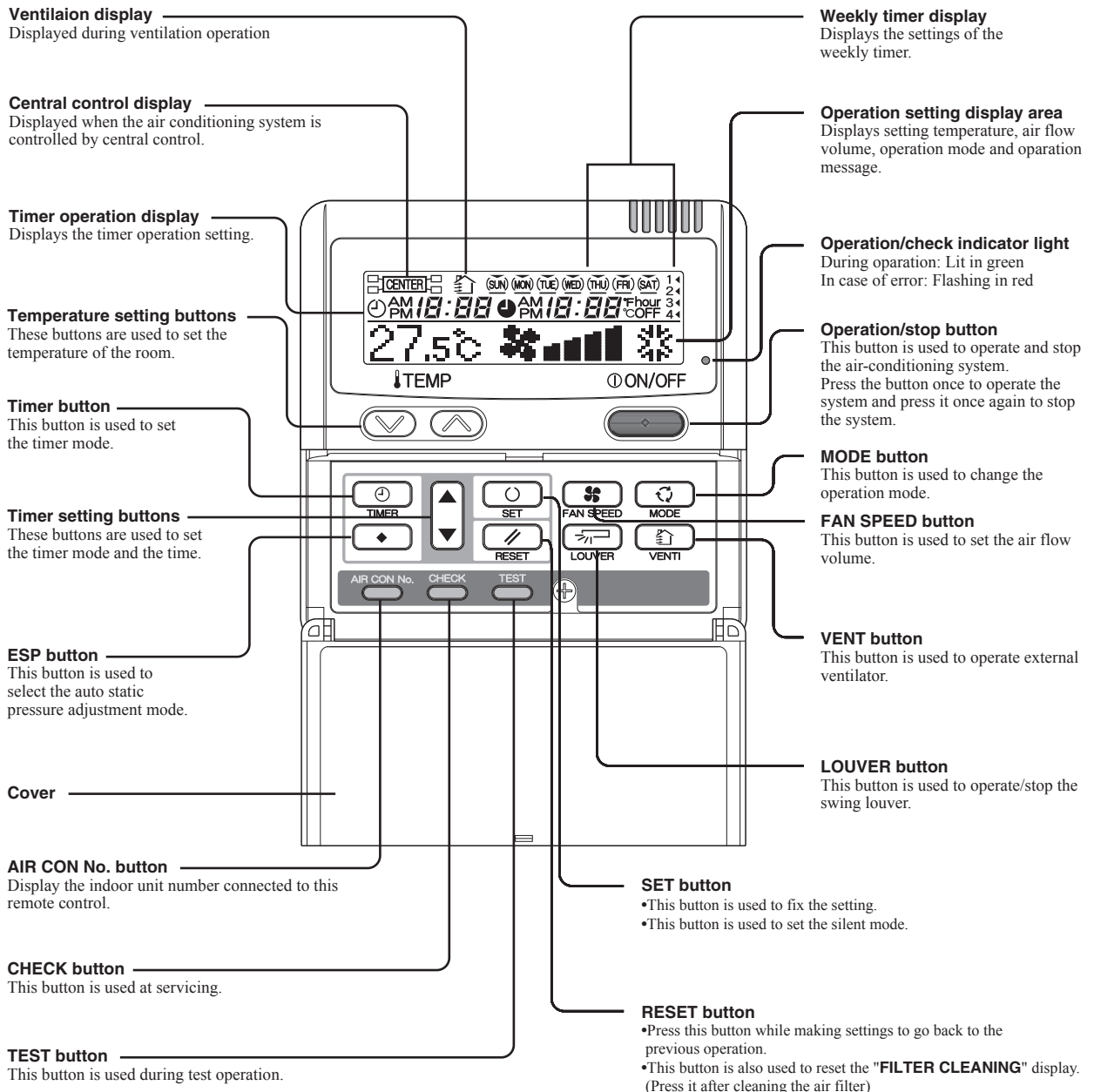

* All displays are described in the liquid crystal display for explanation.

**(2) Wireless remote control
RCN-E2 (Except SRK series)**

Indication section

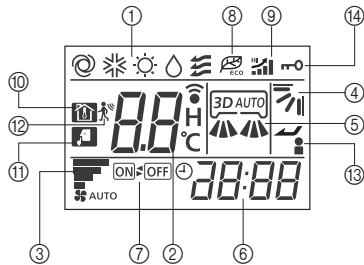

①	OPERATION MODE display SET TEMP display	Indicates selected operation mode. Indicates set temperature.
②	SLEEP TIMER time display Indoor function setting number display	Indicates the amount of time remaining on the sleep timer. Indicates the setting number of the indoor function setting.
③	FAN SPEED display	Indicates the selected air flow volume.
④	UP/DOWN AIR FLOW display	Indicates the up/down louver position.
⑤	LEFT/RIGHT AIR FLOW display	Indicates the left/right louver position.
⑥	Clock display	Indicates the current time. If the timer is set, the ON TIMER and OFF TIMER setting times are indicated.
⑦	ON/OFF TIMER display	Displayed when the timer is set.
⑧	ECO mode display	Displayed when the energy-saving operation is active.
⑨	HI POWER display	Displayed when the high power operation is active.
⑩	NIGHT SETBACK display	Displayed when the home leave mode is active.
⑪	SILENT display	Displayed when the silent mode control is active.
⑫	Motion sensor display	Displayed when the infrared sensor control(motion sensor control) is enabled.
⑬	Anti draft setting display	Displayed when anti draft setting is enabled.
⑭	Child lock display	Displayed when child lock is enabled.

Operation section

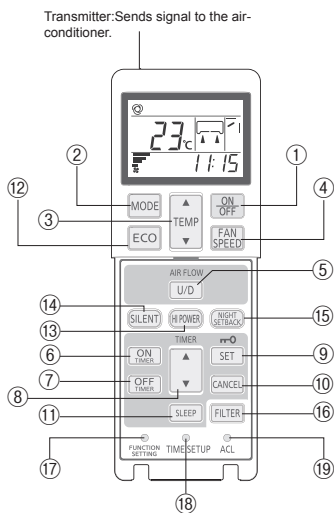

①	ON/OFF button	When this is pressed once, the air-conditioner starts to operate and when this is pressed once again, it stops operating.
②	MODE button	Every time this button is pressed, displays switch as below
③	TEMP button	Change the set temperature by pressing ▲ or ▼ button.
④	FAN SPEED button	The fan speed is switched in the following order: 1-speed → 2-speed → 3-speed → 4-speed → AUTO → 1-speed.
⑤	U/D button	Used to determine the up/down louver position.
⑥	ON TIMER button	Used to set the ON TIMER.
⑦	OFF TIMER button	Used to set the OFF TIMER.
⑧	SELECT button	Used to switch the time when setting the timer or adjusting the time. Used to switch the settings of the indoor function.
⑨	SET button	Used to determine the setting when setting the timer or adjusting the time. Used to determine the settings of the indoor function. When press and hold SET button ,Child Lock is enabled.
⑩	CANCEL button	Used to cancel the timer setting.
⑪	SLEEP button	Used to set the sleep timer.
⑫	ECO button	Pressing this button starts the energy-saving operation. Pressing this button again cancels it.
⑬	HI POWER button	Pressing this button starts the high power operation. Pressing this button again cancels it.
⑭	SILENT button	Pressing this button starts the silent mode control. Pressing this button again cancels it.
⑮	NIGHT SETBACK button	Pressing this button starts the home leave mode. Pressing this button again cancels it.
⑯	FILTER button	Pressing this button resets FILTER SIGN.
⑰	FUNCTION SETTING switch	Used to set the indoor function.
⑱	TIME SETUP switch	Used to set the current time.
⑲	ACL switch	Used to reset the microcomputer.

SRK series only

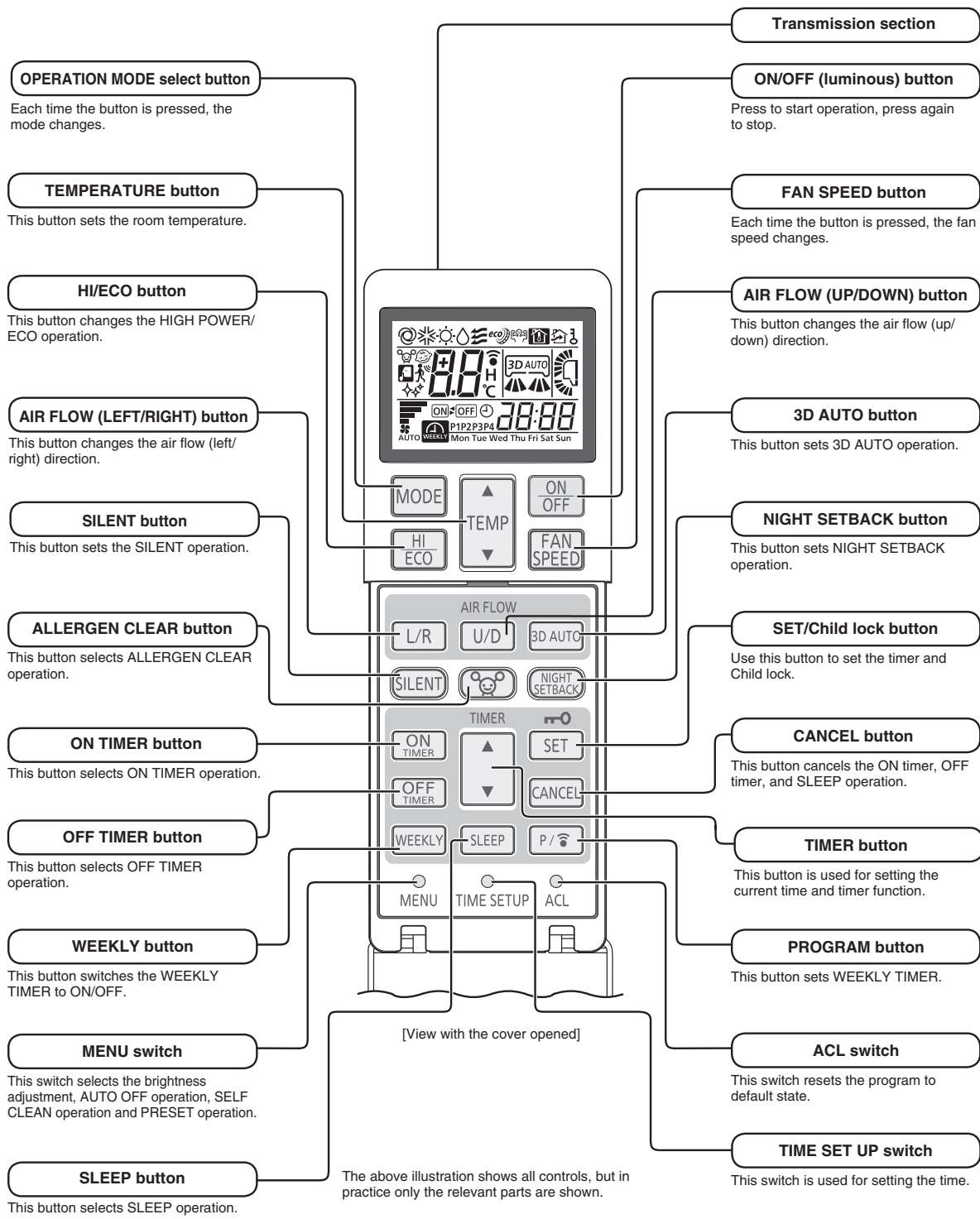

(a) Models SRK50ZSX-W, 60ZSX-W

Unit display section

Unit ON/OFF button
This button can be used for turning on/off the unit when a remote control is not available.

Wireless remote control signal receiver

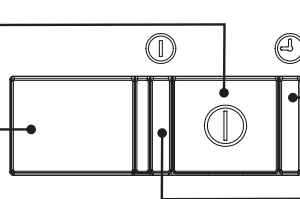

TIMER light (yellow)

Illuminates during TIMER operation.

RUN light (green)

- Illuminates during operation.
- Blinks slowly when SELF CLEAN operation (3 seconds ON, 1 second OFF).
- Blinks when airflow is stopped to prevent blowing out of cold air in heating operation. (1.5 seconds ON, 0.5 seconds OFF)
- Blinks slowly when AUTO OFF operation during stand by (3.5 seconds ON, 0.5 second OFF).

- RUN lights blink quickly during invalid operation mode.

(b) Models SRK 100ZR-W

Unit display section

Unit ON/OFF button

This button can be used for turning on/off the unit when a remote control is not available.

ON/OFF

Remote control signal receiver

RUN (HOT KEEP) light (green)

- Illuminates during operation.
- Blinks when airflow stops due to the 'HOT KEEP', 'CLEAN operation' and 'operation mode invalid'.

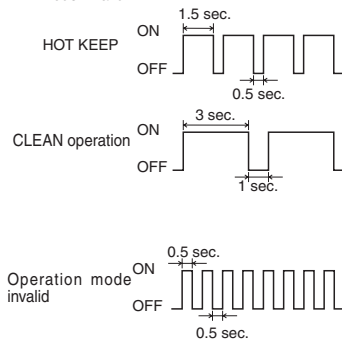

RUN ⓘ
TIMER ⌚
HI POWER 🔥
3D AUTO ↻

TIMER light (yellow)

Illuminates during TIMER operation.

HI POWER light (green)

Illuminates during HIGH POWER operation.

3D AUTO light (green)

Illuminates during 3D AUTO operation.

1.1.2 Operation control function by the wired remote control

●Model RC-EX3A

(1) Switching sequence of the operation mode switches of remote control

- Tap the change operation mode button on the TOP screen.
- When the change operation mode screen is displayed, tap the button of desired mode.
- When the operation mode is selected, the display returns to the TOP screen.

Icons displayed have the following meanings.

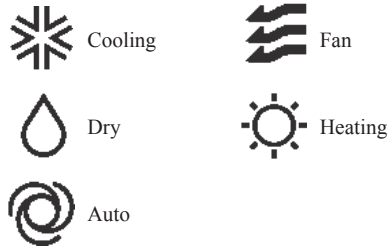

Notes (1) Operation modes which cannot be selected depending on combinations of indoor unit and outdoor unit are not displayed.

- When the Auto is selected, the cooling and heating switching operation is performed automatically according to indoor and outdoor temperatures.

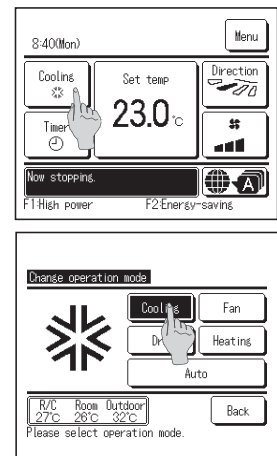

(2) CPU reset

Reset CPU from the remote control as follows.

TOP screen ⇒ ⇒ ⇒

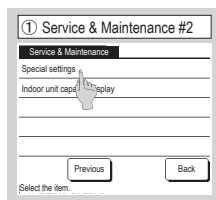

The selected screen is displayed.

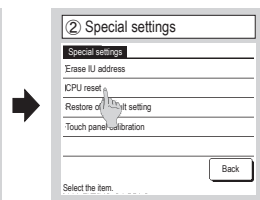

The selected screen is displayed.

Microcomputers of indoor unit and outdoor unit connected are reset (State of restoration after power failure).

(3) Power failure compensation function (Electric power source failure)

Enable the Auto-restart function from the remote control as follows.

TOP screen ⇒ ⇒ ⇒

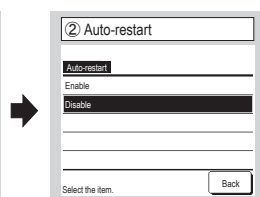
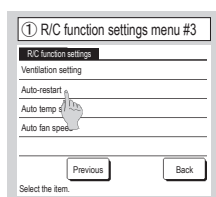

If the unit stops during operation,

It returns to the state before the power failure as soon as the power source is restored (After the end of the primary control at the power on).

It stops after the restoration of power source.

- Since the status of remote control is retained in memory always, it restarts operations according to the contents of memory as soon as the power source is restored. Although the timer mode is cancelled, the weekly timer, peak cut timer and silent mode timer operate according to the following contents:

- When the clock setting is valid : These timer settings are also valid.
- When the clock setting is invalid : These timer settings become “Invalid” since the clock setting is invalid. These timer settings have to be changed to “Valid” after the timer setting.

- Content memorized with the power failure compensation are as follows.

Note(1) Items (f) and (g) are memorized regardless whether the power failure compensation is effective or not while the setting of silent mode is cancelled regardless whether the power failure compensation is effective or not.

- (a) At power failure – Operating/stopped
If it had been operating under the off timer mode, sleep timer mode, the state of stop is memorized.
- (b) Operation mode
- (c) Air flow volume mode
- (d) Room temperature setting
- (e) Louver auto swing/stop
However, the stop position (4-position) is cancelled so that it returns to Position (1).
- (f) “Remote control function items” which have been set with the administrator or installation function settings (“Indoor function items” are saved in the memory of indoor unit.)
- (g) Weekly timer, peak-cut timer or silent mode timer settings
- (h) Remote control function setting

(4) Alert displays

If the following (a) to (c) appear, check and repair as follows.

(a) Communication check between indoor unit and remote control



- This appears if communications cannot be established between the remote control and the indoor unit.
Check whether the system is correctly connected (indoor unit, outdoor unit, remote control) and whether the power source for the outdoor unit is connected.

(b) Clock setting check

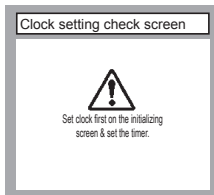

- This appears when the timer settings are done without clock setting.
Set the clock setting before the timer settings.

(c) Misconnection

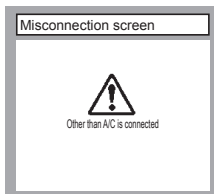

- This appears when something other than the air-conditioner has been connected to the remote control.
Check the location to which the remote control is connected.

● Model RC-E5

(1) Switching sequence of the operation mode switches of remote control



(2) CPU reset

This functions when “CHECK” and “ESP” buttons on the remote control are pressed simultaneously. Operation is same as that of the power source reset.

(3) Power failure compensation function (Electric power source failure)

- This becomes effective if “Power failure compensation effective” is selected with the setting of remote control function.
- Since it memorizes always the condition of remote control, it starts operation according to the contents of memory no sooner than normal state is recovered after the power failure. Although the auto swing stop position and the timer mode are cancelled, the weekly timer setting is restored with the holiday setting for all weekdays. After recovering from the power failure, it readjusts the clock and resets the holiday setting for each weekday so that the setting of weekly timer becomes effective.
- Content memorized with the power failure compensation are as follows.

Note (1) Items (f), (g) and (h) are memorized regardless whether the power failure compensation is effective or not while the setting of silent mode is cancelled regardless whether the power failure compensation is effective or not.

- (a) At power failure – Operating/stopped
If it had been operating under the off timer mode, sleep timer mode, the state of stop is memorized. (Although the timer mode is cancelled at the recovery from power failure, the setting of weekly timer is changed to the holiday setting for all weekdays.)
- (b) Operation mode
- (c) Air flow volume mode
- (d) Room temperature setting
- (e) Louver auto swing/stop
However, the stop position (4-position) is cancelled so that it returns to Position (1).
- (f) “Remote control function items” which have been set with the remote control function setting (“Indoor function items” are saved in the memory of indoor unit.)
- (g) Upper limit value and lower limit value which have been set with the temperature setting control
- (h) Sleep timer and weekly timer settings (Other timer settings are not memorized.)

[Parts layout on remote control PCB]

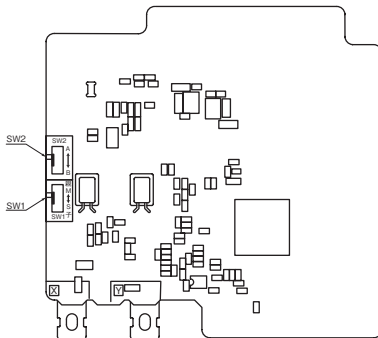

Master/ slave setting when more than one remote controls are used

A maximum of two remote controls can be connected to one indoor unit (or one group of indoor units.)

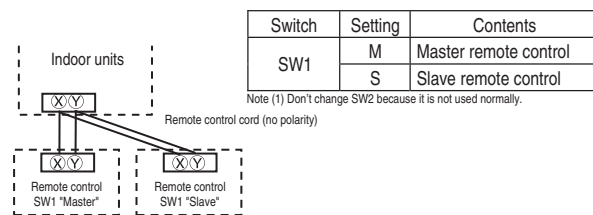

Caution

When using multiple remote controls, the following displays or settings cannot be done with the slave remote control. It is available only with the master remote control.

- ① Louver position setting (set upper or lower limit of swinging range)
- ② Setting indoor unit functions
- ③ Setting temperature range
- ④ Operation data display
- ⑤ Error data display
- ⑥ Silent mode setting
- ⑦ Test operation of drain pump
- ⑧ Remote control sensor setting

1.1.3 Operation control function by the indoor control

(I) FDT, FDTC, FDU, FDUM, FDE series

(1) Auto operation

- (a) If "Auto" mode is selected by the remote control, the heating and the cooling are automatically switched according to the difference between outdoor air temperature and setting temperature and the difference between setting temperature and return air temperature. (When the switching of cooling mode ↔ heating mode takes place within 3 minutes, the compressor does not operate for 3 minutes by the control of 3-minute timer.) This will facilitate the cooling/heating switching operation in intermediate seasons and the adaptation to unmanned operation at stores, etc (ATM corner of bank).

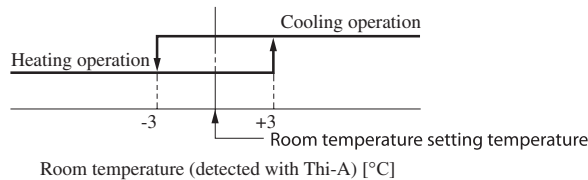

Notes (1) Temperature range of switching cooling/heating mode can be changed by RC-EX3A from ±1.0 – ±4.0.

(2) Room temperature control during auto cooling/auto heating is performed according to the room temperature setting temperature. (DIFF: ±1 deg)

(3) If the indoor heat exchanger temperature rises to 59°C or higher during heating operation, it is switched automatically to cooling operation. In addition, for 1 hour after this switching, the heating operation is not performed, regardless of the temperature shown at right.

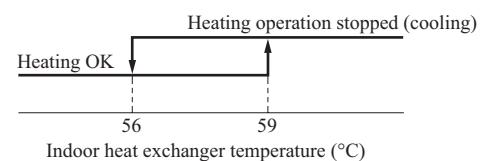

- (b) The following automatic controls are performed other than (a) above.

(i) Cooling or heating operation mode is judged according to the conditions of the "Judgment based on Setting temperature + Cooling select temperature and Indoor return air temperature" and the "Judgment based on Outdoor temperature".

- 1) In "Setting temperature - Cooling select temperature < Indoor return air temperature" and "Outdoor temperature/Cooling < Outdoor return air temperature" ⇒ Operation mode: Cooling
- 2) "Setting temperature + Heating select temperature > Indoor return air temperature" and "Outdoor temperature/Heating > Outdoor air temperature" ⇒ Operation mode: Heating
- 3) The outdoor air temperature of the above judgment conditions is sampled at every 10 minutes.
- 4) In the range where the above cooling and heating zones are overlapped ⇒ Forced thermostat OFF

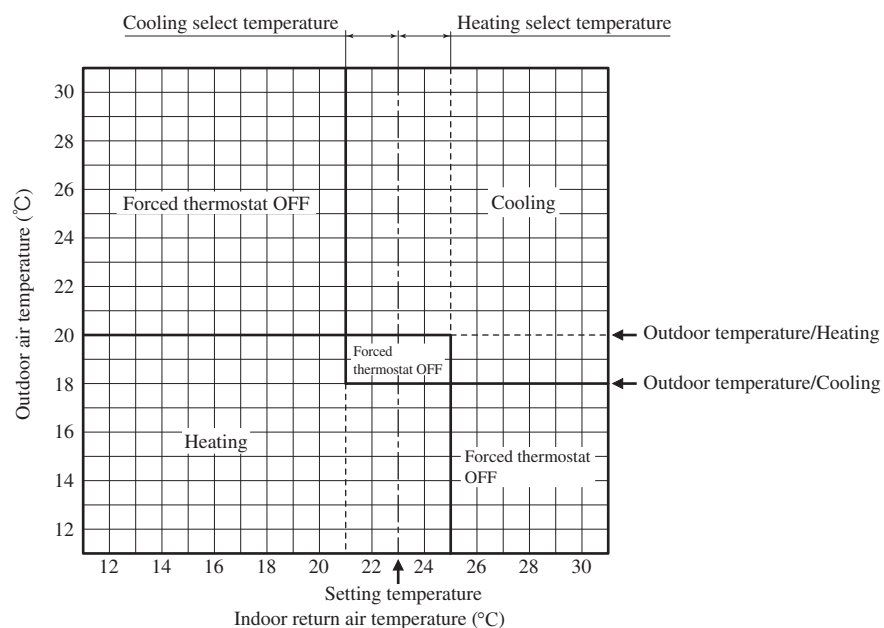

(ii) Regardless of the setting temperature, the cooling or heating operation mode is judged according to the "Judgment based on Room temperature/Cooling or Heating and Outdoor temperature/Cooling or Heating".

- 1) In case of "Room temperature/Cooling < Indoor return air temperature" and "Outdoor temperature/Cooling < Outdoor air temperature" ⇒ Operation mode: Cooling
- 2) In case of "Room temperature/Heating > Indoor return air temperature" and "Outdoor temperature /Heating > Outdoor air temperature" ⇒ Operation mode: Heating
- 3) The outdoor air temperature of the above judgment conditions is sampled at every 10 minutes.
- 4) In the range where the above cooling and heating zones are overlapped ⇒ Forced thermostat OFF

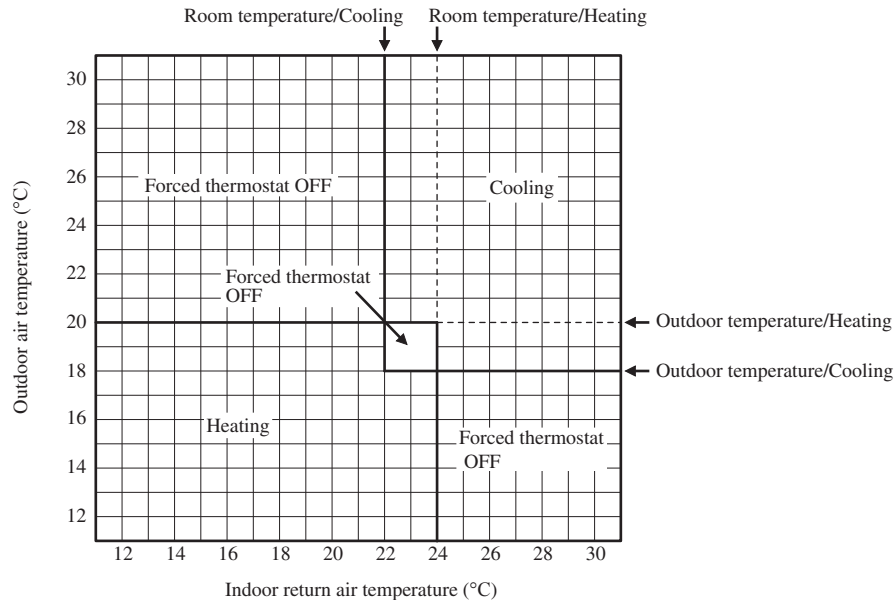

(2) Operations of functional items during cooling/heating

Operation Functional item	Cooling		Fan	Heating			Dehumidifying
	Thermostat ON	Thermostat OFF		Thermostat ON	Thermostat OFF	Hot start (Defrost)	
Compressor	○	×	×	○	×	○	○/×
4-way valve	×	×	×	○	○	○(×)	×
Outdoor unit fan	○	×	×	○	×	○(×)	○/×
Indoor unit fan	○	○	○	○/×	○/×	○/×	○/×
Drain pump ⁽³⁾	○	× ⁽²⁾	× ⁽²⁾	○/× ⁽²⁾			Thermostat ON: ○ Thermostat OFF: × ⁽²⁾

Notes (1) ○: Operation ×: Stop ○/×: Turned ON/OFF by the control other than the room temperature control.
 (2) ON during the drain pump motor delay control.
 (3) Drain pump ON setting may be selected with the indoor unit function setting of the wired remote control.

(3) Dehumidifying (DRY) operation

(a) FDT, FDTC series

Indoor ambient temperatures and humidity are controlled simultaneously with the relative humidity sensor (HS) and the suction temperature sensor [Thi-A (or the remote control temperature sensor when it is activated)], which are installed at the suction inlet.

- (i) When the operation has been started with cooling, if there is a difference of 2°C or less between the suction and setting temperatures, the tap of indoor fan is lowered by one tap. This tap is retained for 3 minutes after changing the tap.
- (ii) After the above condition, when a difference between suction and setting temperature is lower than 3°C, and the relative humidity is high, the tap of indoor fan is lowered by one tap.
 When the difference between suction and setting temperature is larger than 3°C, the tap of indoor fan is raised by one tap. This tap is retained for 3 minutes after changing the tap.
- (iii) When relative humidity becomes lower, the indoor fan tap is retained.
- (iv) In case of the thermostat OFF, the indoor fan tap at the thermostat ON is retained.

(b) FDU, FDUM, FDE series

Return air temperature sensor [Thi-A (by the remote control when the remote control temperature sensor is enabled)] controls the indoor temperature environment simultaneously.

- (i) Operation is started in the cooling mode. When the difference between the return air temperature and the setting temperature is 2°C or less, the indoor fan tap is brought down by one tap. That tap is retained for 3 minutes after changing the indoor fan tap.
- (ii) If the return air temperature exceeds the setting temperature by 3°C during dehumidifying operation, the indoor fan tap is raised by one tap. That tap is retained for 3 minutes after changing the indoor fan tap.
- (iii) If the thermostat OFF is established during the above control, the indoor fan tap at the thermostat ON is retained so far as the thermostat is turned OFF.

(4) Timer operation

(a) RC-EX3A

- (i) Sleep timer
Set the time from the start to stop of operation. The time can be selected in the range from 30 to 240 minutes (in the unit of 10-minute).
Note (1) Enable the “Sleep timer” setting from the remote control. If the setting is enabled, the timer operates at every time.
- (ii) Set OFF timer by hour
Set the time to stop the unit after operation, in the range from 1 to 12 hours (in the unit of hour).
- (iii) Set ON timer by hour
Set the time to start the unit after the stop of operation, in the range from 1 to 12 hours (in the unit of hour). It is allowed also to set simultaneously the indoor temperature, operation mode, air flow rate and warm-up enabled/disabled.
- (iv) Set ON timer by clock
Set the time to start operation. The time can be set in the unit of 5-minute. This setting can be activated only once each time. It is allowed also to set simultaneously the indoor temperature, operation mode, air flow rate and warm-up enabled/disabled.
Note (1) It is necessary to set the clock to use this timer.
- (v) Set OFF timer by clock
Set the time to stop operation. The time can be set in the unit of 5-minute. This setting can be activated only once each time.
Note (1) It is necessary to set the clock to use this timer.
- (vi) Weekly timer
Set the ON or OFF timer for a week. Up to 8 patterns can be set for a day. The day-off setting is provided for holidays and non-business days.
Note (1) It is necessary to set the clock to use the weekly timer.

(vii) Combination of patterns which can be set for the timer operations

	Sleep timer	Set OFF timer by hour	Set ON timer by hour	Set OFF timer by clock	Set ON timer by clock	Weekly timer
Sleep timer		×	×	○	○	○
Set OFF timer by hour	×		×	×	×	×
Set ON timer by hour	×	×		×	×	×
Set OFF timer by clock	○	×	×		○	×
Set ON timer by clock	○	×	×	○		×
Weekly timer	○	×	×	×	×	

Note (1) ○: Allowed ×: Not

(b) RC-E5

- (i) Sleep timer
Set the duration of time from the present to the time to turn off the air-conditioner.
It can be selected from 10 steps in the range from “OFF 1 hour later” to “OFF 10 hours later”. After the sleep timer setting, the remaining time is displayed with progress of time in the unit of hour.
- (ii) OFF timer
Time to turn OFF the air-conditioner can be set in the unit of 10 minutes.
- (iii) ON timer
Time to turn ON the air-conditioner can be set in the unit of 10 minutes. Indoor temperature can be set simultaneously.
- (iv) Weekly timer
Timer operation (ON timer, OFF timer) can be set up to 4 times a day for each weekday.

(v) **Combination of patterns which can be set for the timer operations**

Item \ Item	Sleep timer	OFF timer	ON timer	Weekly timer
Sleep timer		×	○	×
OFF timer	×		○	×
ON timer	○	○		×
Weekly timer	×	×	×	

Notes (1) ○: Allowed ×: Not

(2) Since the ON timer, sleep timer and OFF timer are set in parallel, when the times to turn ON and OFF the air-conditioner are duplicated, the setting of the OFF timer has priority.

(5) Hot start (Cold draft prevention at heating)**(a) Operating conditions**

When either one of following conditions is satisfied, the hot start control is performed.

- (i) From stop to heating operation
- (ii) From cooling to heating operation
- (iii) Form heating thermostat OFF to ON
- (iv) After completing the defrost operation (only on units with thermostat ON)

(b) Contents of operation

(i) Indoor fan motor control at hot start

- 1) Within 7 minutes after starting heating operation, the fan mode is determined depending on the condition of thermostat (fan control with heating thermostat OFF).

a) Thermostat OFF

- i) Operates according to the fan control setting at heating thermostat OFF.
- ii) Even if it changes from thermostat OFF to ON, the fan continues to operate with the fan control at thermostat OFF till the heat exchanger temperature sensor (Thi-R1 or R2, whichever higher) detects 35°C or higher.
- iii) When the heat exchanger temperature sensor (Thi-R1 or R2, whichever higher) detects 35°C or higher, the fan operates with the set air flow volume.

b) Thermostat ON

- i) When the heat exchanger temperature sensor (Thi-R1 or R2, whichever higher) detects 25°C or lower, the fan is turned OFF and does not operate.
 - ii) When the heat exchanger temperature sensor (Thi-R1 or R2, whichever higher) detects 25°C or higher, the fan operates with the fan control at heating thermostat OFF.
 - iii) When the heat exchanger temperature sensor (Thi-R1 or R2, whichever higher) detects 35°C or higher, the fan operates with the set air flow volume.
- c) If the fan control at heating thermostat OFF is set at the “Set air flow volume” (from the remote control), the fan operates with the set air flow volume regardless of the thermostat ON/OFF.

- 2) Once the fan motor is changed from OFF to ON during the thermostat ON, the indoor fan motor is not turned OFF even if the heat exchanger temperature sensor detects lower than 25°C.

Note (1) When the defrost control signal is received, it complies with the fan control during defrost operation.

- 3) Once the hot start is completed, it will not restart even if the temperature on the heat exchanger temperature sensor drops.

(ii) During the hot start, the louver is kept at the horizontal position.

- (iii) When the fan motor is turned OFF for 7 minutes continuously after defrost operation, the fan motor is turned ON regardless of the temperatures detected with the indoor heat exchanger temperature sensors (Thi-R1, R2).

(c) Ending condition

- (i) If one of following conditions is satisfied during the hot start control, this control is terminated, and the fan is operated with the set air flow volume.
 - 1) Heat exchanger temperature sensor (Thi-R1 or R2, whichever higher) detects 35°C or higher.
 - 2) It has elapsed 7 minutes after starting the hot start control.

(6) Hot keep

Hot keep control is performed at the start of the defrost operation.

(a) Contents of operation

- (i) When the indoor heat exchanger temperature (detected with Thi-R1 or R2) drops to less than 35°C, the speed of indoor fan follows fan setting at the time of thermostat OFF.
- (ii) During the hot keep, the louver is kept at the horizontal position.

(7) Auto swing control (FDT, FDTC, FDE only)

Note Even if [Auto Swing] is selected, the louver position with anti draft function is fixed to position 1.

(a) RC-EX3A**(i) Louver control**

- 1) To operate the swing louver when the air-conditioner is operating, press the “Direction” button on the TOP screen of remote control. The wind direction select screen will be displayed.
- 2) To swing the louver, touch the “Auto swing” button. The lover will move up and down. To fix the swing louver at a position, touch one of [1] - [4] buttons. The swing louver will stop at the selected position.
- 3) Louver operation at the power on with a unit having the louver 4-position control function
The louver swings one time automatically (without operating the remote control) at the power on.
This allows the microcomputer recognizing and inputting the louver motor (LM) position.

(ii) Automatic louver level setting during heating

At the hot start and the heating thermostat OFF, regardless whether the auto swing switch is operated or not (auto swing or louver stop), the louver takes the level position (in order to prevent blowing of cool wind). The louver position display LCD continues to show the display which has been shown before entering this control.

(iii) Louver free stop control

If you touch the “Menu” → “Service setting” → “R/C settings” → “Service password” buttons one after another on the TOP screen of remote control, the “Flap control” screen is displayed. If the free stop is selected on this screen, the louver motor stops upon receipt of the stop signal from the remote control. If the auto swing signal is received from the remote control, the auto swing will start from the position before the stop.

(b) RC-E5**(i) Louver control**

- 1) Press the “LOUVER” button to operate the swing louver when the air-conditioner is operating.
“SWING 

Note (1) If you press the “LOUVER” button, the swing motion is displayed on the louver position LCD for 10 seconds. The display changes to the “SWING **(ii) Automatic louver level setting during heating**

At the hot start with the heating thermostat OFF, regardless whether the auto swing switch is operated or not (auto swing or louver stop), the louver takes the level position (In order to prevent the cold start). The louver position display LCD continues to show the display which has been shown before entering this control.

(iii) Louver-free stop control

When the louver-free stop has been selected with the indoor function of wired remote control “

Note (1) When the indoor function of wired remote control “- 17 -

(8) Thermostat operation

(a) Cooling

- (i) Thermostat is operated with the room temperature control.
- (ii) Thermostat is turned ON or OFF relative to the setting room temperature as shown below.

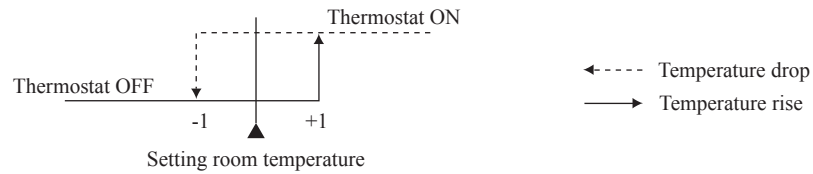

- (iii) Thermostat is turned ON when the room temperature is in the range of $-1 < \text{Setting room temperature} < +1$ at the start of cooling operation (including from heating to cooling).

(b) Heating

- (i) Thermostat is operated with the room temperature control.
- (ii) Thermostat is turned ON or OFF relative to the setting room temperature as shown below.

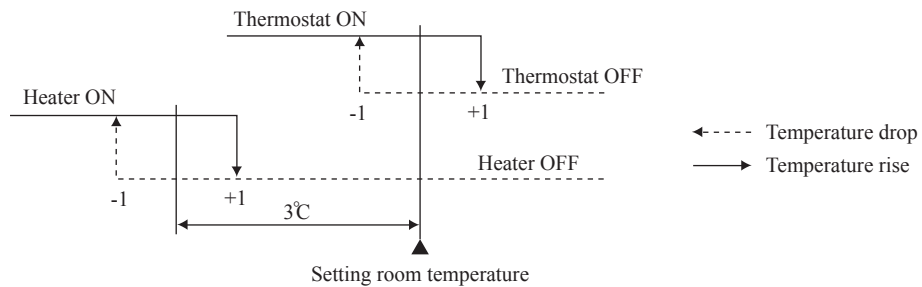

- (iii) Thermostat is turned ON when the room temperature is in the range of $-1 < \text{Setting room temperature} < +1$ at the start of heating operation (including from cooling to heating).

(c) Fan control during heating thermostat OFF

- (i) Following fan controls during the heating thermostat OFF can be selected with the indoor function setting of the wired remote control.
 - ① Low fan speed (Factory default), ② Set fan speed, ③ Intermittence, ④ Fan OFF
- (ii) When the “Low fan speed (Factory default)” is selected, the following taps are used for the indoor fans.
 - For DC motor : ULo tap
- (iii) When the “Set fan speed” is selected, it is operated with the set fan speed also in the thermostat OFF condition.
- (iv) If the “Intermittence” is selected, following controls are performed:
 - 1) If the thermostat is turned OFF during the heating operation, the indoor unit moves to the hot control and turns OFF the indoor fan if the heat exchanger temperature sensors (both Thi-R1 and R2) detect 25°C or lower.
 - 2) Indoor fan OFF is fixed for 5 minutes. After the 5 minutes, the indoor fan is operated at ULo for 2 minutes. In the meantime the louver is controlled at level.
 - 3) After operating at ULo for 2 minutes, the indoor fan moves to the state of 1) above.
 - 4) If the thermostat is turned ON, it moves to the hot start control.
 - 5) When the heating thermostat is turned OFF, the remote control displays the temperature detected at the fan stop and revises the temperature later when the indoor fan changes from ULo to stop.

The remote control uses the operation data display function to display temperatures and updates values of temperature even when the indoor fan is turned OFF.
 - 6) When the defrost operation starts while the heating thermostat is turned OFF or the thermostat is turned OFF during defrost operation, the indoor fan is turned OFF. (Hot keep or hot start control takes priority.) However, the suction temperature is updated at every 7-minute.
 - 7) When the heating thermostat is turned ON or the operation is changed to another mode (including stop), this control is stopped immediately, and the operating condition is restored.
- (v) When the “Fan OFF” is selected, the fan on the indoor unit of which the thermostat has been turned OFF, is turned OFF. The same occurs also when the remote control sensor is effective.

(d) Fan control during cooling thermostat OFF

- (i) Following fan controls during the cooling thermostat OFF can be selected with the indoor function setting of the wired remote control.
 - ① Low fan speed, ② Set fan speed (Factory default), ③ Intermittence, ④ Fan OFF
- (ii) When the “Low fan speed” is selected, the following taps are used for the indoor fans.
 - For DC motor : ULo tap
- (iii) When the “Set fan speed” is selected, it is operated with the set fan speed also in the thermostat OFF condition.
- (iv) If the “Intermittence” is selected, following controls are performed:
 - 1) If the thermostat is turned OFF during the cooling operation, the indoor fan motor stops.
 - 2) Indoor fan OFF is fixed for 5 minutes. After the 5 minutes, the indoor fan is operated at ULo for 2 minutes. In the meantime the louver is controlled at level.
 - 3) After operating at ULo for 2 minutes, the indoor fan moves to the state of 1) above.
 - 4) If the thermostat is turned ON, the fan starts operation at set fan speed.
 - 5) When the cooling thermostat is turned OFF, the remote control displays the temperature detected at the fan stop and revises the temperature later when the indoor fan changes from ULo to stop.
By using operation data display function at wireless remote control, the temperature as displayad and the value is updated including the fan stops.
 - 6) When the cooling thermostat is turned ON or the operation is changed to another mode (including stop), this control is stopped immediately, and the operating condition is restored.
- (v) When the “Fan OFF” is selected, the fan on the indoor unit of which the thermostat has been turned OFF, is turned OFF. The same occurs also when the remote control sensor is effective.

(9) Filter sign

As the operation time (Total ON time of ON/OFF switch) accumulates to 180 hours (1), “FILTER CLEANING” is displayed on the remote control. (This is displayed when the unit is in trouble and under the central control, regardless of ON/OFF.)

Notes (1) Time setting for the filter sign can be made as shown below using the indoor function of wired remote control “Filter sign”. (It is set at setting 1 at the shipping from factory.)

Filter sign setting	Function
Setting 1	Setting time: 180 hrs (Factory default)
Setting 2	Setting time: 600 hrs
Setting 3	Setting time: 1,000 hrs
Setting 4	Setting time: 1,000 hrs (Unit stop) ⁽²⁾

(2) After the setting time has elapsed, the “FILTER CLEANING” is displayed and, after operating for 24 hours further (counted also during the stop), the unit stops.

(10) Compressor inching prevention control

(a) 3-minute timer

When the compressor has been stopped by the thermostat, remote control operation switch or anomalous condition, its restart will be inhibited for 3 minutes. However, the 3-minute timer is invalidated at the power on the electric power source for the unit.

(b) 3-minute forced operation timer

- (i) Compressor will not stop for 3 minutes after the compressor ON. However, it stops immediately when the unit is stopped by means of the ON/OFF switch or when the thermostat is turned OFF by the change of operation mode.
- (ii) If the thermostat is turned OFF during the forced operation control of heating compressor, the louver position (with the auto swing) is returned to the level position.

Note (1) The compressor stops when it has entered the protective control.

(11) Drain pump control

- (a) This control is operated when the inverter frequency is other than 0 Hz during the cooling operation and automatic cooling and dehumidifying operations.
- (b) Drain pump ON condition continues for 5 minutes even when it enters the OFF range according to (a) above after turning the drain pump ON, and then stops. The 5-minute delay continues also in the event of anomalous stop.
- (c) The drain pump is operated with the 5-minute delay operation when the compressor is changed from ON to OFF.
- (d) Even in conditions other than the above (such as heating, fan, stop, cooling thermostat OFF), the drain pump control is performed by the drain detection.
- (e) Following settings can be made using the indoor function setting of the wired remote control.
 - (i) 𠄎 [Standard (in cooling)] : Drain pump is run during cooling.
 - (ii) 𠄎 AND 𠄎 [Operate in standard & heating] : Drain pump is run during cooling and heating.
 - (iii) 𠄎 AND 𠄎 AND 𠄎 [Operate in heating & fan] : Drain pump is run during cooling, heating and fan.
 - (iv) 𠄎 AND 𠄎 [Operate in standard & fan] : Drain pump is run during cooling and fan.

Note (1) Values in [] are for the RC-EX3A model.

(12) Drain pump motor (DM) control

- (a) Drain detection switch is turned ON or OFF with the float switch (FS) and the timer.

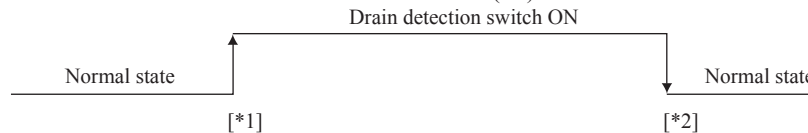

[*1] Drain detection switch is turned “ON” when the float switch “Open” is detected for 3 seconds continuously in the drain detectable space.

[*2] Drain detection switch is turned “OFF” when the float switch “Close” is detected for 10 seconds continuously.

- (i) It detects always from 30 seconds after turning the power ON.
 - 1) There is no detection of anomalous draining for 10 seconds after turning the drain pump OFF.
 - 2) Turning the drain detection switch “ON” causes to turn ON the drain pump forcibly.
 - 3) Turning the drain detection switch “OFF” releases the forced drain pump ON condition.

- (b) Indoor unit performs the control A or B depending on each operating condition.

		Indoor unit operation mode				
		Stop ⁽¹⁾	Cooling	Dry	Fan ⁽²⁾	Heating
Compressor ON		Control A				
Compressor OFF		Control B				

Notes (1) Including the stop from the cooling, dehumidifying, fan and heating, and the anomalous stop
 (2) Including the “Fan” operation according to the mismatch of operation modes

- (i) Control A
 - 1) If the float switch detects any anomalous draining condition, the unit stops with the anomalous stop (displays E9) and the drain pump starts. After detecting the anomalous condition, the drain pump motor continues to be ON.
 - 2) It keeps operating while the float switch is detecting the anomalous condition.
- (ii) Control B

If the float switch detects any anomalous drain condition, the drain pump motor is turned ON for 5 minutes, and at 10 seconds after the drain pump motor OFF it checks the float switch. If it is normal, the unit is stopped under the normal mode or, if there is any anomalous condition, E9 is displayed and the drain pump motor is turned ON. (The ON condition is maintained during the drain detection.)

(13) Operation check/drain pump test run operation mode

- (a) If the power is turned on by the DIP switch (SW7-1) on the indoor unit control PCB when electric power source is supplied, it enters the mode of operation check/drain pump test run. It is ineffective (prohibited) to change the switch after turning power on.
- (b) When the communication with the remote control has been established within 60 seconds after turning power on by the DIP switch (SW7-1) ON, it enters the operation check mode. Unless the remote control communication is established, it enters the drain pump test run mode.

Note (1) To select the drain pump test run mode, disconnect the remote control connector (CnB) on the indoor unit PCB to shut down the remote control communication.

(c) Operation check mode

There is no communication with the outdoor unit but it allows performing operation in respective modes by operating the remote control.

(d) Drain pump test run mode

As the drain pump test run is established, the drain pump only operates and during the operation protective functions by the microcomputer of indoor unit become ineffective.

(14) Cooling, dehumidifying frost protection

- (a) To prevent frosting during cooling mode or dehumidifying mode operation, the compressor-OFF if the indoor heat exchanger temperature (detected with Thi-R) drops to 1.0 °C or lower at 4 minutes after the compressor-ON. If the indoor unit heat exchanger temperature is 1.0 °C or lower after 5 minutes, the indoor unit is controlled compressor-OFF. If it becomes 10°C or higher, the control terminates.

- Frost prevention temperature setting can be selected with the indoor unit function setting of the wired remote control.

	Symbol	A
Item		
Temperature - Low (Factory default)		1.0
Temperature - High		2.5

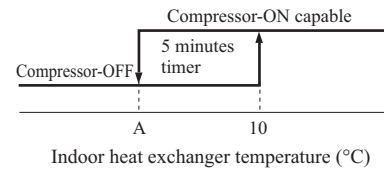

- Compressor forced off temperature (FDT&FDTC only)

Hs > 50%

	Item	Low	High
Symbol			
A		1.0	2.5

Hs ≤ 50%

	Item	Low	High
Symbol			
A		-0.5	1.0

(b) Selection of indoor fan speed

If it enters the frost prevention control during cooling operation (including dehumidifying), the indoor fan speed is switched.

- When the indoor return air temperature (Thi-A) is 18°C or higher and the indoor heat exchanger temperature (detected with Thi-R) detects the compressor frequency drop start temperature A°C+1°C, indoor fan speed is increased by 20min⁻¹.
- If the phenomenon of (i) above is detected again after the acceleration of indoor fan, indoor fan speed is increased further by 20min⁻¹.

Note (1) Indoor fan speed can be increased by up to P-Hi.

(15) Heating overload protection

- (a) If the indoor heat exchanger temperature (detected with Thi-R) at 63°C or higher is detected for 2 seconds continuously, the compressor stops. When the compressor is restarted after a 3-minute delay, if a temperature at 63°C or higher is detected for 2 seconds continuously within 60 minutes after initial detection and if this is detected 5 times consecutively, the compressor stops with the anomalous stop (E8). Anomalous stop occurs also when the indoor heat exchanger temperature at 63°C or higher is detected for 6 minutes continuously.

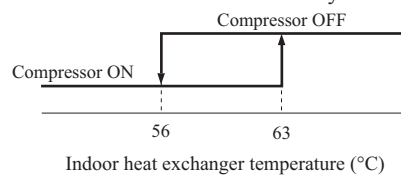

(b) Indoor fan speed selection

If, after second detection of heating overload protection up to fourth, the indoor fan is set at below Hi tap when the compressor is turned ON, the indoor fan speed is increased by 1 tap.

(16) Anomalous fan motor

- After starting the fan motor, if the fan motor speed is 200 min⁻¹ or less is detected for 30 seconds continuously and 4 times within 60 minutes, then fan motor stops with the anomalous stop (E16).
- If the fan motor fails to reach at -50 min⁻¹(FDU:-500 min⁻¹) less than the required speed, it stops with the anomalous stop (E20).

(17) Plural unit control – Control of 16 units group by one remote control

(a) Function

One remote control can control a group of multiple number of unit (Max. 16 indoor units). “Operation mode” which is set by the remote control can operate or stop all units in the group one after another in the order of unit No.⁽¹⁾. Thermostat and protective function of each unit function independently.

Note (1) Unit No. is set by SW2 on the indoor unit control PCB. Unit No. setting by SW2 is necessary for the indoor unit only. In cases of the twin, triple and double twin specification, it is necessary set for the master and the slave units. This can be selected by SW5. (All are set for the master unit at the shipping from factory.)

SW2: For setting of 0 – 9, A – F
 SW5: For setting of master and slave units
 (See table shown at right.)

Unit \ Switch	SW5-1	SW5-2
Master unit	OFF	OFF
Slave unit a	OFF	ON
Slave unit b	ON	OFF
Slave unit c	ON	ON

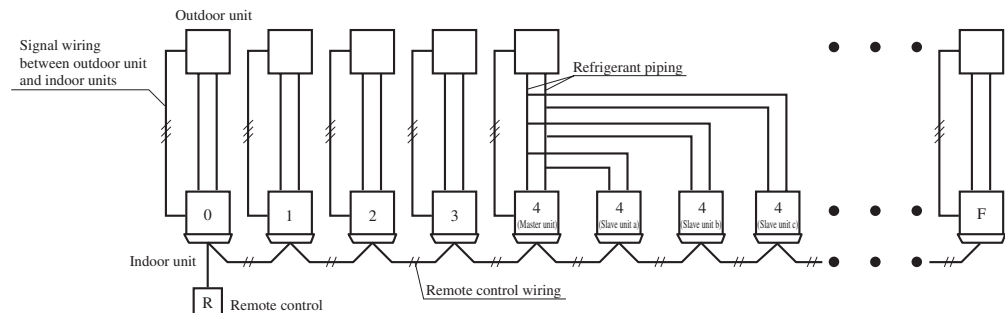

(2) Unit No. may be set at random unless duplicated, it should be better to set orderly like 0, 1, 2..., F to avoid mistake.

(b) Display to the remote control

- (i) Central or each remote control basis, heating preparation
 The smallest unit No. among the operating units in the remote mode (or the center mode unless the remote mode is available) is displayed.
- (ii) Inspection display, filter sign
 Any of unit that starts initially is displayed.

(c) Confirmation of connected units

- (i) In case of RC-EX3A remote control
 If you touch the buttons in the order of “Menu” → “Service setting” → “Service & Maintenance” → “Service password” → “IU address” on the TOP screen of remote control, the indoor units which are connected are displayed.
- (ii) In case of RC-E5 remote control
 Pressing “AIR CON No.” button on the remote control displays the indoor unit address. If “▲” “▼” button is pressed at the next, it is displayed orderly starting from the unit of smallest No..

(d) In case of anomaly

If any anomaly occurs on a unit in a group (a protective function operates), that unit stops with the anomalous stop but any other normal units continue to run as they are.

(e) Signal wiring procedure

Signal wiring between indoor and outdoor units should be made on each unit same as the normal wiring. For the group control, connect the remote control wiring to each indoor unit via terminal block for the remote control.

Connect the remote control wiring separately from the power source cable or wires of other electric devices (AC220V or higher).

(18) High ceiling control

When sufficient air flow rate cannot be obtained from the indoor unit which is installed at a room with high ceiling, the air flow rate can be increased by changing the fan tap. To change the fan tap, use the indoor unit function “FAN SPEED SET” on the wired remote control.

Fan tap		Indoor unit air flow rate setting				Series
		Standard - Standard - Standard - Standard	Standard - Standard - Standard	Standard - Standard	Standard - Standard	
FAN SPEED SET	STANDARD	P-Hi1 - Hi - Me - Lo	Hi - Me - Lo	Hi - Lo	Hi - Me	Except FDT, FDE
		P-Hi2 - Hi - Me - UL0	Hi - Me - Lo	Hi - Lo	Hi - Me	Only FDT
		P-Hi2 - Hi - Me - Lo	Hi - Me - Lo	Hi - Lo	Hi - Me	Only FDE
	HIGH SPEED1	P-Hi1 - P-Hi1 - Hi - Me	P-Hi1 - Hi - Me	P-Hi1 - Me	P-Hi1 - Hi	Except FDT, FDE
		P-Hi2 - P-Hi1 - Hi - Me	P-Hi1 - Hi - Me	P-Hi1 - Me	P-Hi1 - Hi	Only FDT
		P-Hi1 - Hi - Me - Lo	Hi - Me - Lo	Hi - Lo	Hi - Me	Only FDE
HIGH SPEED2	P-Hi2 - Hi - Me - Lo	Hi - Me - Lo	Hi - Lo	Hi - Me	Only FDT, FDE	

Notes (1) Factory default is STANDARD.
 (2) At the hot-start and heating thermostat OFF, or other, the indoor fan is operated at the low speed tap of each setting.
 (3) This function is not able to be set with wireless remote control or simple remote control (RCH-E3).

(19) Abnormal temperature sensor (return air/indoor heat exchanger) broken wire/short-circuit detection

(a) Broken wire detection

When the return air temperature sensor detects -55°C or lower or the heat exchanger temperature sensor detect -55°C or lower for 5 seconds continuously, the compressor stops. After a 3-minute delay, the compressor restarts but, if it is detected again within 60 minutes after the initial detection for 6 minutes continuously, stops again (the return air temperature sensor: E7, the heat exchanger temperature sensor: E6).

(b) Short-circuit detection

If the heat exchanger temperature sensor detects short-circuit for 5 seconds continuously at 2 minutes and 20 seconds after the compressor ON during cooling operation, the compressor stops (E6).

(20) External input/output control (CnT or CnTA)

External input/output connectors are provided on the indoor unit control PCB, and each input/output is possible to be changed by RC-EX3A.

Be sure to connect the wired remote control to the indoor unit. Remote operation with CnT/CnTA only is not possible.

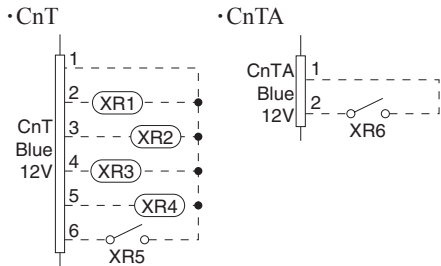

Input/Output	Connector	Factory default setting	RC-EX3A function name
Output	CnT-2 (XR1)	Operation output	External output 1
	CnT-3 (XR2)	Heating output	External output 2
	CnT-4 (XR3)	Compressor ON output	External output 3
	CnT-5 (XR4)	Inspection(Error) output	External output 4
"Input (Volt-free contact)"	CnT-6 (XR5)	Remote operation input	External input 1
	CnTA (XR6)	Remote operation input	External input 2

■ Priority order for combinations of CnT and CnTA input.

		CnTA					
		① Operation stop level	② Operation stop pulse	③ Operation permission/prohibition	④ Operation permission/prohibition pulse	⑤ Cooling/heating selection level	⑥ Cooling/heating selection pulse
CnT	① Operation stop level	CnT ①	CnT ①	CnT ① + CnTA ②	CnT ①	CnT ① / CnTA ⑤	CnT ① / CnTA ⑥
	② Operation stop pulse	CnT ②	CnT ②	CnT ② + CnTA ③	CnT ②	CnT ② / CnTA ⑤	CnT ② / CnTA ⑥
	③ Operation permission/prohibition level	CnT ③ > CnTA ①	CnT ③ > CnTA ②	CnT ③ + CnTA ③	CnT ③	CnT ③ / CnTA ⑤	CnT ③ / CnTA ⑥
	④ Operation permission/prohibition pulse	CnT ④	CnT ④	CnT ④ + CnTA ③※	CnT ④	CnT ④ / CnTA ⑤	CnT ④ / CnTA ⑥
	⑤ Cooling/heating selection level	CnT ⑤ / CnTA ①	CnT ⑤ / CnTA ②	CnT ⑤ / CnTA ③	CnT ⑤ / CnTA ④	CnT ⑤	CnT ⑤
	⑥ Cooling/heating selection pulse	CnT ⑥ / CnTA ①	CnT ⑥ / CnTA ②	CnT ⑥ / CnTA ③	CnT ⑥ / CnTA ④	CnT ⑥	CnT ⑥

Note (1) Following operation commands are accepted when the operation prohibition is set with CnTA as indicated with *.

Individual operation command from remote control, test run command from outdoor unit and operation command from option device, CnT input.

Reference: Explanation on the codes and the combinations of codes in the table above

- In case of CnT "Number", the CnT "Number" is adopted and CnTA is invalidated.
- In case of CnTA "Number", the CnTA "Number" is adopted and CnT is invalidated.
- In case of CnT "Number"/CnTA "Number", the CnT "Number" and the CnTA "Number" become independent functions each other.
- In case of CnT "Number" + CnTA "Number", the CnT "Number" and the CnTA "Number" become competing functions each other.
- In case of CnT "Number" > CnTA "Number", the function of CnT "Number" supersedes that of CnTA "Number".
- In case of CnT "Number" < CnTA "Number", the function of CnTA "Number" supersedes that of CnT "Number".
(The "Number" above means ① - ⑥ in the table.)

(a) Output for external control (remote display)

Indoor unit outputs the following signal for operation status monitoring.

	Output name	Condition
1	Operation output	During operation
2	Heating output	During heating operation
3	Compressor ON output	During compressor operation
4	Inspection(Error) output	When anomalous condition occurs.
5	Cooling output	During cooling operation
6	Fan operation output 1	When indoor unit's fan is operating
7	Fan operation output 2	When indoor unit's fan is operating, and fan speed is higher than Hi speed.
8	Fan operation output 3	When indoor unit's fan is operating, and fan speed is Lower than Me speed.
9	Defrost/oil return output	When indoor unit receive defrost/oil return signal from the outdoor unit.
10	Ventilation output	When "Venti.ON" is selected from remote control
11	Free cooling output	When the ambient temperature is between 10 - 18°C in cooling and fan operation
12	Indoor unit overload alarm output	Refer to "IU overload alarm"
13	Heater output	Refer to "(8) Thermostat operation (b) Heating"

(b) Input for external control

The external input for the indoor unit can be selected from the following input.

	Input name	Content
1	Run/Stop	Refer to [(20) (c) Remote operation input]
2	Permission/Prohibition	Refer to [(21) Operation permission/prohibition]
3	Cooling/Heating	Refer to [(23) Selection of cooling/heating external input function]
4	Emergency stop	Indoor/outdoor units stop the operation, and [E63] is displayed.
5	Setting temperature shift	Set temperature is shifted by +2/-2°C in cooling/heating.
6	Forced thermo-OFF	Unit goes thermo off.
7	Temporary stop	Refer to [(22) Temporary stop input]
8	Silent mode	Outdoor unit silent mode is activated.

(i) In case of “Level input” setting (Factory default)

Input signal to CnT-6 or CnTA is OFF→ON unit ON

Input signal to CnT-6 or CnTA is ON→OFF unit OFF

Operation is not inverted.

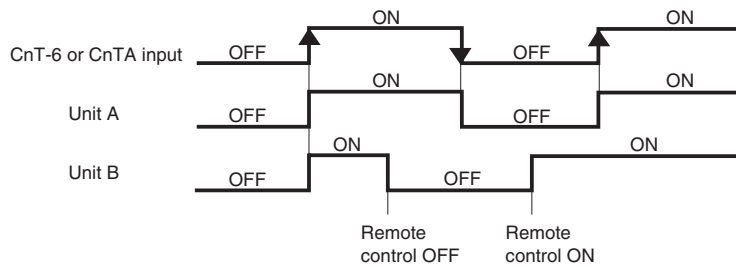

Note (1) The latest operation has priority

It is available to operate/stop by remote control or central control.

(ii) In case of “Pulse input” setting (Local setting)

It is effective only when the input signal to CnT-6 or CnTA is changed OFF→ON, and at that time unit operation [ON/OFF] is inverted.

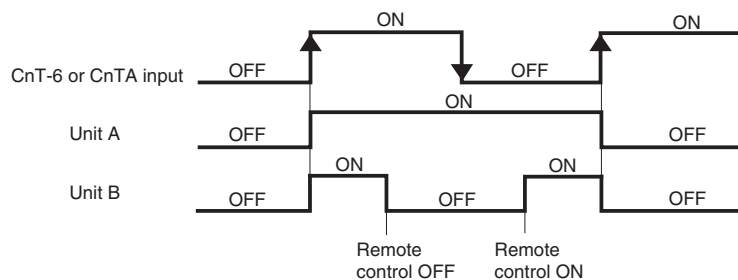

(c) Remote operation

(i) In case of multiple units (Max. 16 indoor units group) are connected to one wired remote control

When the R/C function setting of wired remote control for “External control set” is changed from “Individual (Factory default)” to “For all units”, all units connected in one wired remote control system can be controlled by external operation input.

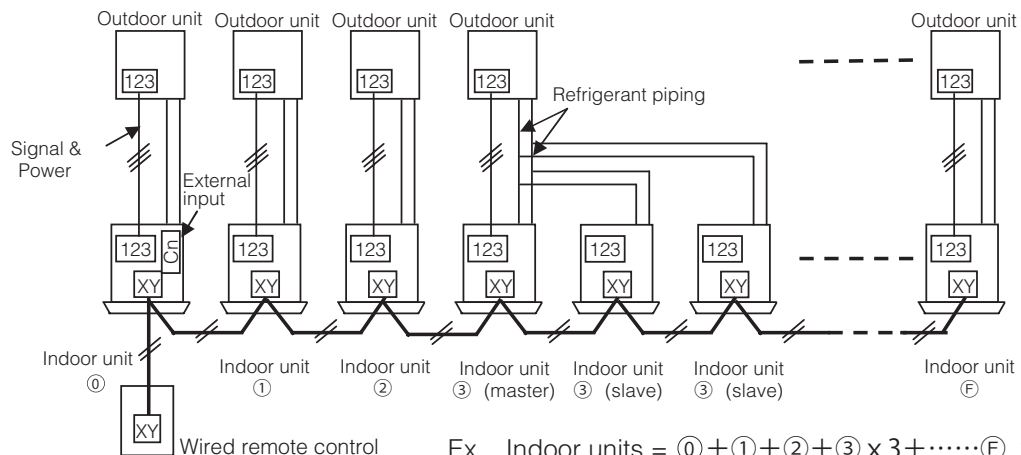

Ex. Indoor units = ① + ② + ③ × 3 + ⑥ ≤ 16 units

CnT-6 or CnTA	Individual operation (Factory default)		All units operation (Local setting)	
	ON	OFF	ON	OFF
	Only the unit directly connected to the remote control can be operated.	Only the unit directly connected to the remote control can be stopped operation.	All units in one remote control system can be operated.	All units in one remote control system can be stopped operation.
	Unit ① only	Unit ① only	Units ① – ㉞	Units ① – ㉞

When more than one indoor unit (Max. 16 indoor units) are connected in one wired remote control system:

- (1) With the factory default, external input to CnT-6 or CnTA is effective for only the unit ①.
- (2) When setting “For all unit” (Local setting), all units in one remote control system can be controlled by external input to CnT-6 or CnTA on the indoor unit ①.
- (3) External input to CnT-6 or CnTA on the other indoor unit than the unit ① is not effective.

(21) Operation permission/prohibition

(In case of adopting card key switches or commercially available timers)

When the indoor function setting of wired remote control for “Operation permission/prohibition” is changed from “Invalid (Factory default)” to “Valid”, following control becomes effective.

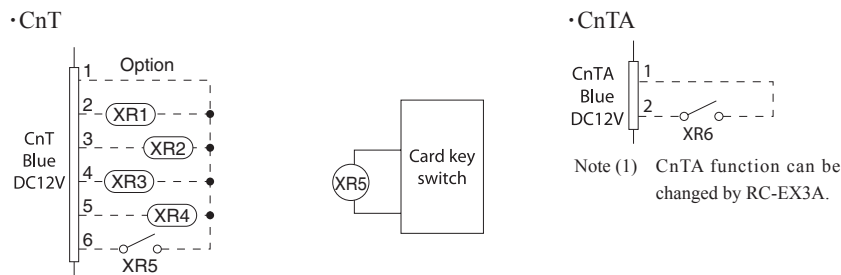

CnT-6 or CnTA	Normal operation (Factory default)		Operation permission/prohibition mode “Valid” (Local setting)	
	ON	OFF	ON	OFF
	Operation	Stop	Operation permission*1	Operation prohibition (Unit stops)

*1 **Only the “LEVEL INPUT” is acceptable for external input**, however when the indoor function setting of “Level input (Factory default)” or “Pulse input” is selected by the function for “External input” of the wired remote control, operation status will be changed as follows.

In case of “Level input” setting	In case of “Pulse input” setting
Unit operation from the wired remote control becomes available※1	Unit starts operation ※2

※1) In case that “Operation permission/prohibition mode” setting is “Valid” and “External input” setting is “Level input (Factory default)”;

- ① When card key switch is ON (CnT-6 or CnTA ON: Operation permission), start/stop operation of the unit from the wired remote control becomes available.
- ② When card key switch is OFF (CnT-6 or CnTA OFF: Operation prohibition), the unit stops operation in conjunction with OFF signal, and start/stop operation of the unit from the wired remote control becomes unavailable.

※2) In case that “Operation permission/prohibition mode” setting is “Valid” and “External input” setting is “Pulse input (Local setting)”;

- ① When card key switch is ON (Operation permission), the unit starts operation in conjunction with ON signal, and also start/stop operation of the unit from the wired remote control becomes available.
- ② When card key switch is OFF (Operation prohibition), the unit stops operation in conjunction with OFF signal, and start/stop operation of the unit from the wired remote control becomes unavailable.

3) This function is invalid only at “Center mode” setting done by central control.

(a) In case of CnT ① Operation stop level > CnTA ③ Operation permission/prohibition level

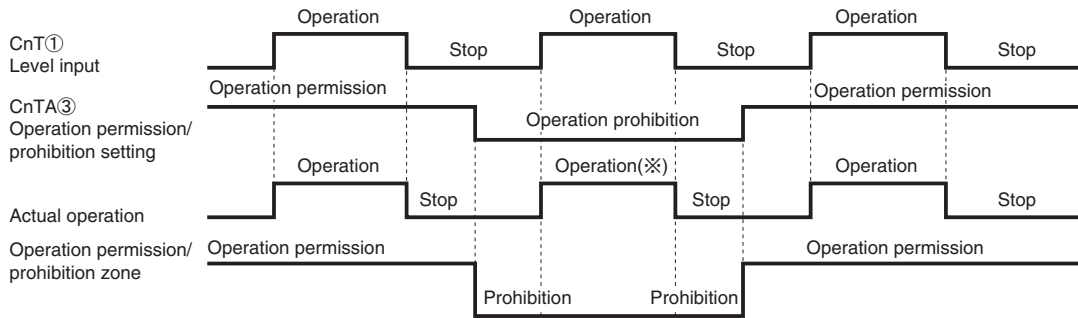

(※) CnT level input supersedes CnTA operation prohibition.

(b) In case of CnT ③ Operation permission/prohibition level + CnTA ③ Operation permission/prohibition level

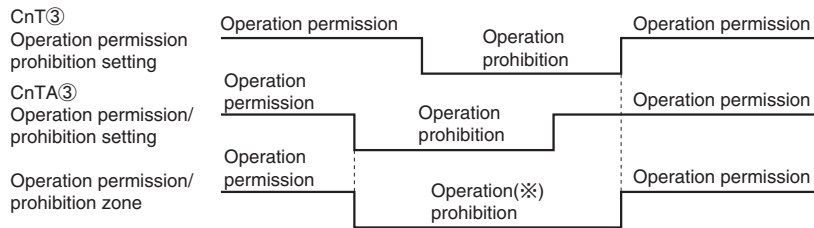

(※) Operation prohibition zone is determined by the OR judgment between CnT operation prohibition zone and CnTA operation prohibition zone.

(c) In case of CnT ③ Operation permission/prohibition level > CnTA ② Operation stop pulse

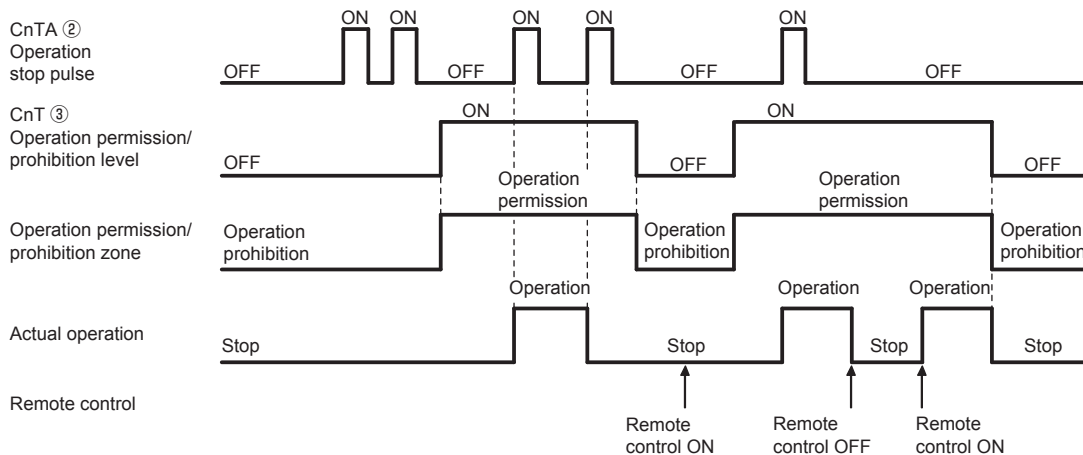

Note (1) If it is prohibited by CnT, all "Operation" and "Stop" commands are not accepted.

(d) In case of CnT ② Operation stop pulse + CnTA ③ Operation permission/prohibition level

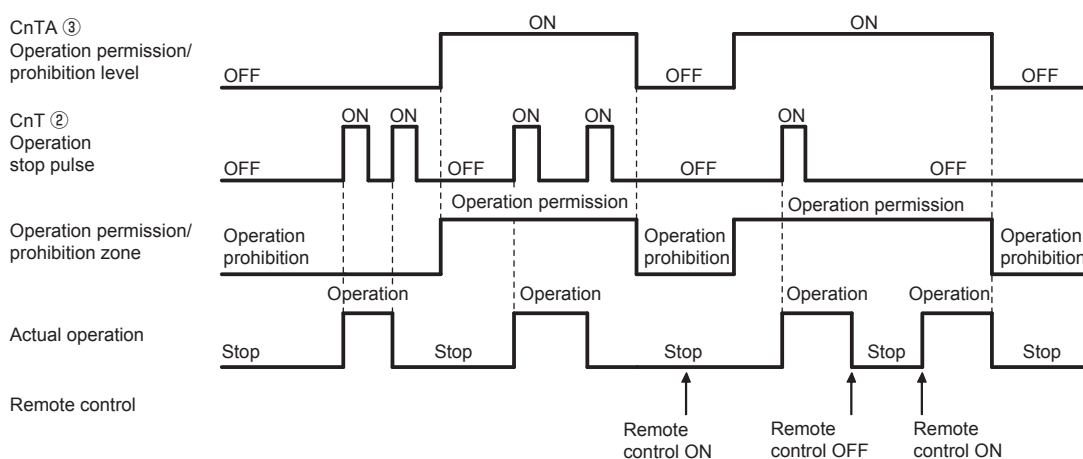

(22) Temporary stop input

In case of temporary stop, operation lamp of remote control lights, but indoor/outdoor unit stop the operation.

(a) In case of “level input” setting (Factory default)

Input signal to CnT-6 or CnTA is OFF → ON : Temporary stop
 Input signal to CnT-6 or CnTA is OFF → ON : Normal operation

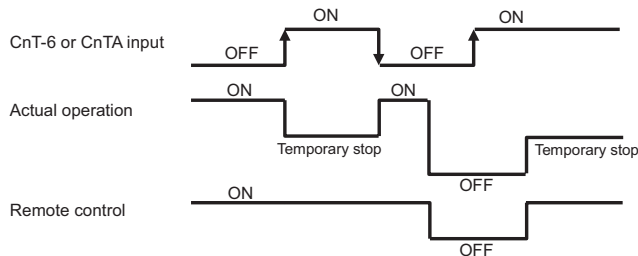

(b) In case of “pulse input” setting (Local setting)

It is effective only when the input signal is changed OFF→ON, and “temporary stop/normal operation” is inverted.

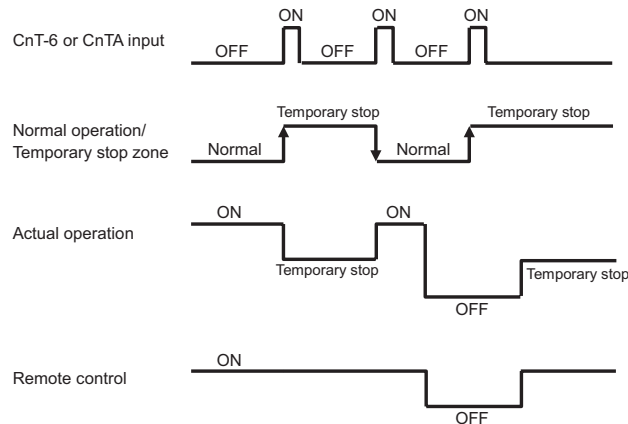

(23) Selection of cooling/heating external input function

- (a) When “External input 1 setting: Cooling/heating” is set by the indoor unit function from remote control, the cooling or heating is selected with CnT-6 or CnTA.
- (b) When the external input 1 method selection: Level input is set by the indoor unit function:
 - CnT-6 or CnTA: OPEN → Cooling operation mode
 - CnT-6 or CnTA: CLOSE → Heating operation mode
- (c) When the external input 1 method selection: Pulse input is set by the indoor unit function:
 - If the external input is changed OPEN → CLOSE, operation modes are inverted (Cooling → Heating or Heating → Cooling).
- (d) If the cooling/heating selection signal is given by the external input, the operation mode is transmitted to the remote control.

■ Selection of cooling/heating external input function

External input selection	External input method	Operation	
External input selection Cooling/heating selection	⑤ Level	External terminal input (CnT or CnTA)	
		Cooling/heating	
	⑥ Pulse	External terminal input (CnT or CnTA)	
		Cooling/heating	
		Cooling/heating (Competitive)	

Note (1) Regarding the priority order for combinations of CnT and CnTA, refer to Page 23.

(24) Fan control at heating startup**(a) Starting conditions**

At the start of heating operation and after the end of hot start control, if the difference of setting temperature and return air temperature is 5°C or higher, this control is performed.

(b) Contents of control

- (i) Sampling is made at each minute and, when the indoor heat exchanger temperature (detected with Thi-R) is 37°C or higher, present number of revolutions of indoor fan speed is increased by 10min⁻¹.
- (ii) If the indoor heat exchanger temperature drops below 37°C at next sampling, present number of revolutions of indoor fan speed is reduced by 10min⁻¹.

(c) Ending conditions

Indoor fan speed is reduced to the setting air flow rate when the compressor OFF is established and at 30 minutes after the start of heating operation.

(25) Room temperature detection temperature compensation during heating

With the standard specification, the compressor is turned ON/OFF with the thermostat setting temperature. When the thermostat is likely to turn OFF earlier because the unit is installed at the ceiling where warm air tends to accumulate, the setting can be changed with the wired remote control indoor unit function “~~SP~~ SP OFFSET”. The compressor and the heater are turned ON/OFF at one of the setting temperature +3, +2 or +1°C in order to improve the feeling of heating. The setting temperature, however, has the upper limit of 30°C.

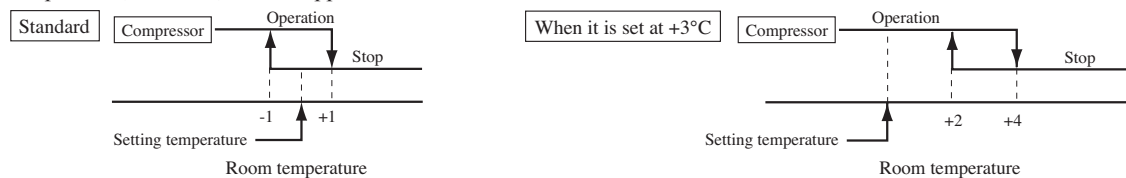
**(26) Return air temperature compensation**

This is the function to compensate the deviation between the detection temperature by the return air temperature sensor and the measured temperature after installing the unit.

- (a) It is adjustable in the unit of 0.5°C with the wired remote control indoor unit function “RETURN AIR TEMP”.
 - +1.0°C, +1.5°C, +2.0°C
 - -1.0°C, -1.5°C, -2.0°C
- (b) Compensated temperature is transmitted to the remote control and the compressor to control them.

Note (1) The detection temperature compensation is effective on the indoor unit temperature sensor only.

(27) High power operation (RC-EX3A only)

It operates at with the set temperature fixed at 16°C for cooling, 30°C for heating and maximum indoor fan speed for 15 minutes maximum.

(28) Energy-saving operation (RC-EX3A only)

It operates with the setting temperature fixed at 28°C for cooling, 22°C for heating or 25°C for auto. When fan control in cooling/heating thermo-OFF setting is “Set fan speed”, fan speed during thermo-OFF is changed to “Low”. (Maximum capacity is restricted at 80%.)

(29) Warm-up control (RC-EX3A only)

Operation will be started 5 to 60 minutes before use according to the forecast made by the microcomputer which calculates when the operation should be started in order to warm up the indoor temperature near the setting temperature at the setting time of operation start.

(30) Home leave mode (RC-EX3A only)

When the unit is not used for a long period of time, the room temperature is maintained at a moderate level, avoiding extremely hot or cool temperature.

- (a) Cooling or heating is operated according to the outdoor temperature (factory setting 35°C for cooling, 0°C for heating) and the setting temperature. (factory setting 33°C for cooling, 10°C for heating)
- (b) Setting temperature and indoor fan speed can be set by RC-EX3A.

(31) Auto temperature setting (RC-EX3A only)

Setting temperature is adjusted automatically at the adequate temperature the center setting temperature is 24°C by correcting the outdoor air temperature.

(32) Fan circulator operation (RC-EX3A only)

When the fan is used for circulation, the unit is operated as follows depending on the setting with the remote control.

- (a) If the invalid is selected with the remote control, the fan is operated continuously during the fan operation. (normal fan mode)
- (b) If the valid is selected with the remote control, the fan is operated or stopped when on the difference of the remote control temperature sensor and the return air temperature sensor becomes bigger than 3°C.

(33) The operation judgment is executed every 5 minutes (RC-EX3A only)

Setting temperature T_s is changed according to outdoor temperature.

This control is valid with cooling and heating mode. (Not auto mode)

- (a) Operate 5 minutes forcedly.
- (b) Setting temperature is adjusted every 10 minutes.
 - (i) Cooling mode.
 $T_s = \text{outdoor temperature} - \text{offset value}$
 - (ii) Heating mode.
 $T_s = \text{outdoor temperature} - \text{offset value}$
- (c) If the return air temperature lower than 18°C in cooling or return air temperature becomes higher than 25°C in heating, unit goes thermostat OFF.

(34) Auto fan speed control (RC-EX3A only)

In order to reach the room temperature to the set temperature as quickly as possible, the air flow rate is increased when the set temperature of thermostat differs largely from the return air temperature. According to temperature difference between set temperature and return air temperature, indoor fan tap are controlled automatically.

- Auto 1: Changes the indoor fan tap within the range of Hi ↔ Me ↔ Lo.
- Auto 2: Changes the indoor fan tap within the range of P-Hi ↔ Hi ↔ Me ↔ Lo.

(35) Indoor unit overload alarm (RC-EX3A only)

If the following condition is satisfied at 30 minutes after starting operation, RC-EX3A shows maintenance code "M07" and the signal is transmitted to the external output (CnT-2-5).

- Cooling, Dry, Auto(Cooling) : Indoor air temperature = Set room temperature by remote control + Alarm temperature difference
 - Heating, Auto(Heating) : Indoor air temperature = Set room temperature by remote control - Alarm temperature difference
- Alarm temperature difference is selectable between 5 to 10°C.

If the following condition is satisfied or unit is stopped, the signal is disappeared.

- Cooling, Dry, Auto(Cooling) : Indoor air temperature = Set room temperature + Alarm temperature difference - 2°C
- Heating, Auto(Heating) : Indoor air temperature = Set room temperature - Alarm temperature difference + 2°C

(36) Peak-cut timer (RC-EX3A only)

Power consumption can be reduced by restricting the maximum capacity.

Set the [Start time], the [End time] and the capacity limit % (Peak-cut %).

- 4-operation patterns per day can be set at maximum.
- The setting time can be changed by 5-minute interval.
- The selectable range of capacity limit % (Peak-cut %) is from 0% to 40-80% (20% interval).
- Holiday setting is available.

(37) Motion sensor control (RC-EX3A and RCN-E2 only)

The sensor determines the presence of people and the amount of activity, and the following controls are done by the motion sensor.

Following settings are necessary to activate motion sensor control.

- (a) Infrared (motion) sensor setting: Installation setting of remote control
The indoor unit which is set to “Enable” become valid.
- (b) Infrared (motion) sensor control: Energy-saving setting of remote control
The function which is set to “Enable” become valid.

RC-EX3A

TOP screen **Menu** ⇒ **Service setting** ⇒ **Installation settings** ⇒ **Service password**

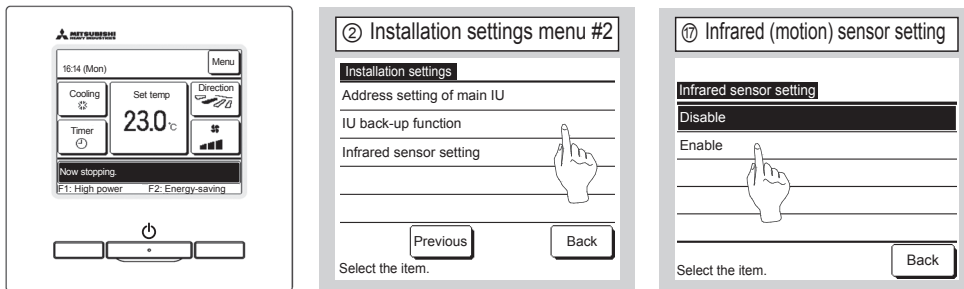

TOP screen **Menu** ⇒ **Energy-saving setting** ⇒ **Infrared sensor control** or **Motion sensor control**

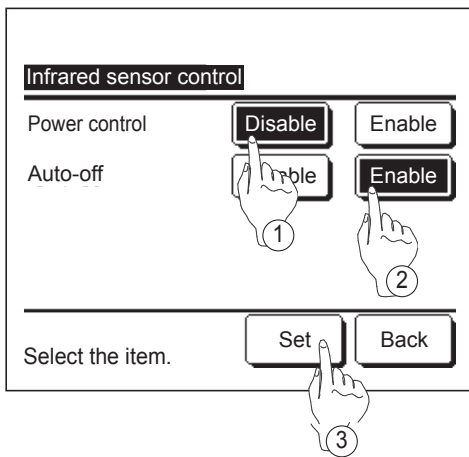

The Infrared sensor control screen and contents of the current settings are displayed.

- ① Enable/disable power control.
- ② Enable/disable auto-off.
- ③ After you set each item, tap the **Set** button.
The display returns to the Energy-saving setting menu screen.

RCN-E2

1. Set indoor functions

- ① Press the ON/OFF button to stop the unit.
- ② Press the desired one of the buttons shown item 2. while holding down the FUNCTION SETTING switch.
- ③ Use the selection buttons, ▲ and ▼, to change the setting.
- ④ Press the SET button.
The buzzer on the remote control signal receiver beeps twice, and the LED lamp flashes four times at two-second intervals.

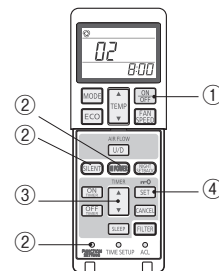

2. Setting details

Button	Number indicator	Function setting
SILENT	00	Infrared sensor setting (Motion sensor setting) : Disable
	01	Infrared sensor setting (Motion sensor setting) : Enable
HI POWER	00	Infrared sensor control (Motion sensor control) : Disable
	01	Infrared sensor control (Motion sensor control) : Power control only
	02	Infrared sensor control (Motion sensor control) : Auto OFF only
	03	Infrared sensor control (Motion sensor control) : Power control and Auto OFF

(i) Power saving / comfort control

The set temperature is adjusted according to the presence of people and their amount of activity detected by the infrared (motion) sensor.

MODE:AUTO/COOL/HEAT mode operation

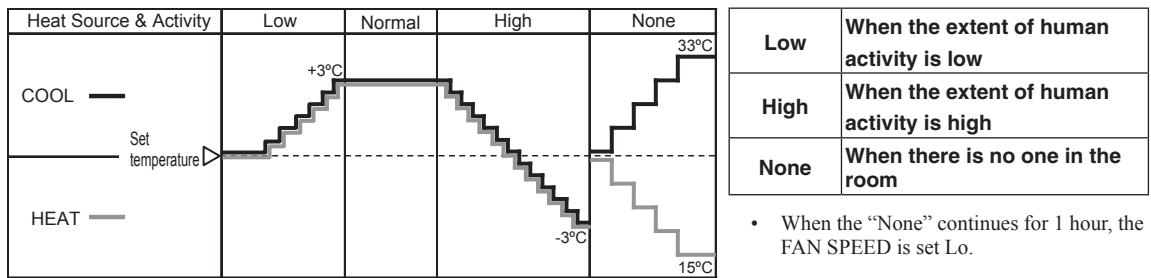

Notes (1) When the following operations are set, power saving control will be canceled.

- ① Energy-saving, Home leave mode, Warm-up control, Cooling operation check.
- ② When the operation mode is changed DRY or FAN.

(2) Not operable while the air-conditioner is OFF.

(ii) Auto-off control

When no activity is detected for 1 hour, unit will go stand-by mode.※ Unit will re-start operation automatically with the original set temperature by activity detection during the stand-by mode. When stand-by mode continues for 12 hours, unit stops.

※ Compressor keeps stopped regardless of the set temperature.

(II) SRK series

(1) Unit ON/OFF button

When the wireless remote control batteries become weak, or if the wireless remote control is lost or malfunctioning, this button may be used to turn the unit on and off.

(a) Operation

Push the button once to place the unit in the automatic mode. Push it once more to turn the unit off.

(b) Details of operation

The unit will go into the automatic mode in which it automatically determines, from room temperature (as detected by sensor), whether to go into the COOL, DRY or HEAT modes.

(i) SRK-ZSX series

Function Operation mode	Room temperature setting	Fan speed	Flap/Louver	Timer switch
Cooling	About 24°C	Auto	Auto	Continuous
DRY	About 25°C			
Heating	About 26°C			

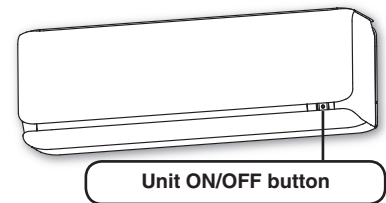

(ii) SRK-ZR series

Function Operation mode	Room temperature setting	Fan speed	Swing control	Timer switch
Cooling	About 24°C	Auto	Auto	Continuous
DRY				
Heating				

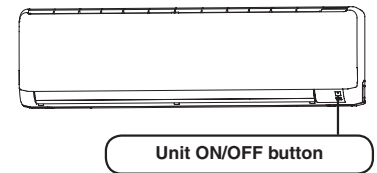

(2) Auto restart function

(a) Auto restart function records the operational status of the air-conditioner immediately prior to be switched off by a power cut, and then automatically resumes operations after the power has been restored.

(b) The following settings will be cancelled:

- (i) Timer settings
- (ii) HIGH POWER operation (Only SRK-ZSX series)

- Notes
- (1) Auto restart function is set at on when the air-conditioner is shipped from the factory. Consult with your dealer if this function needs to be switched off.
 - (2) When power failure occurs, the timer setting is cancelled. Once power is resumed, reset the timer.
 - (3) If the jumper wire (J1: SRK-ZSX, JA1:SRK-ZR) "AUTO RESTART" is cut, auto restart is disabled. (See the diagram at right)

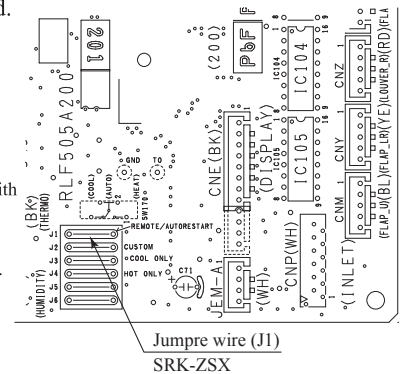

Jumper wire (JA1)
SRK-ZR

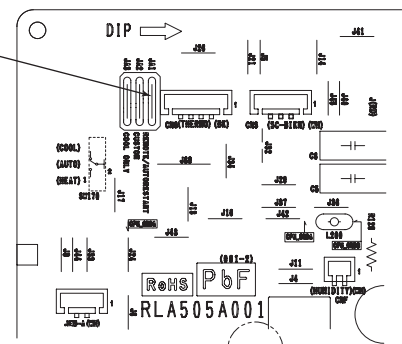

(3) Auto swing control

[Note] Even if [Auto Swing] is selected, the louver position with anti draft function is fixed to position 1.

(a) RC-EX3A**(i) Louver control**

- 1) To operate the swing louver when the air-conditioner is operating, press the “Direction” button on the TOP screen of remote control. The wind direction select screen will be displayed.
- 2) To swing the louver, touch the “Auto swing” button. The louver will move up and down. To fix the swing louver at a position, touch one of [1] - [4] buttons. The swing louver will stop at the selected position.
- 3) Louver operation at the power on with a unit having the louver 4-position control function
The louver swings one time automatically (without operating the remote control) at the power on.
This allows the microcomputer recognizing and inputting the louver motor (LM) position.



(ii) Automatic louver level setting during heating

At the hot start and the heating thermostat OFF, regardless whether the auto swing switch is operated or not (auto swing or louver stop), the louver takes the level position (in order to prevent blowing of cool wind). The louver position display LCD continues to show the display which has been shown before entering this control.

(iii) Louver free stop control

If you touch the “Menu” → “Service setting” → “R/C settings” → “Service password” buttons one after another on the TOP screen of remote control, the “Flap control” screen is displayed. If the free stop is selected on this screen, the louver motor stops upon receipt of the stop signal from the remote control. If the auto swing signal is received from the remote control, the auto swing will start from the position before the stop.

(b) RC-E5**(i) Louver control**

- 1) Press the “LOUVER” button to operate the swing louver when the air-conditioner is operating.
“SWING ” is displayed for 3 seconds and then the swing louver moves up and down continuously.
- 2) To fix the swing louver at a position, press one time the “LOUVER” button while the swing louver is moving so that four stop positions are displayed one after another per second.
When a desired stop position is displayed, press the “LOUVER” button again. The display stops, changes to show the “STOP 1 ” for 5 seconds and then the swing louver stops.
- 3) Louver operation at the power on with a unit having the louver 4-position control function
The louver swings one time automatically (without operating the remote control) at the power on.
This allows inputting the louver motor (LM) position, which is necessary for the microcomputer to recognize the louver position.



Note (1) If you press the “LOUVER” button, the swing motion is displayed on the louver position LCD for 10 second. The display changes to the “SWING ” display 3 seconds later.

(ii) Automatic louver level setting during heating

At the hot start with the heating thermostat OFF, regardless whether the auto swing switch is operated or not (auto swing or louver stop), the louver takes the level position (In order to prevent the cold start). The louver position display LCD continues to show the display which has been shown before entering this control.

(iii) Louver free stop control

When the louver-free stop has been selected with the indoor function of wired remote control “ POSITION”, the louver motor stops when it receives the stop signal from the remote control. If the auto swing signal is received from the remote control, the auto swing will start from the position where it was before the stop.

Note (1) When the indoor function of wired remote control “ POSITION” has been switched, switch also the remote control function “ POSITION” in the same way.

(4) Timer operation

(a) RC-EX3A

- (i) **Sleep timer**
Set the time from the start to stop of operation. The time can be selected in the range from 30 to 240 minutes (in the unit of 10-minute).
Note (1) Enable the “Sleep timer” setting from the remote control. If the setting is enabled, the timer operates at every time.
- (ii) **Set OFF timer by hour**
Set the time to stop the unit after operation, in the range from 1 to 12 hours (in the unit of hour).
- (iii) **Set ON timer by hour**
Set the time to start the unit after the stop of operation, in the range from 1 to 12 hours (in the unit of hour). It is allowed also to set simultaneously the indoor temperature, operation mode, air flow rate and warm-up enabled/disabled.
- (iv) **Set ON timer by clock**
Set the time to start operation. The time can be set in the unit of 5-minute. This setting can be activated only once each time. It is allowed also to set simultaneously the indoor temperature, operation mode, air flow rate and warm-up enabled/disabled.
Note (1) It is necessary to set the clock to use this timer.
- (v) **Set OFF timer by clock**
Set the time to stop operation. The time can be set in the unit of 5-minute. This setting can be activated only once each time.
Note (1) It is necessary to set the clock to use this timer.
- (vi) **Weekly timer**
Set the ON or OFF timer for a week. Up to 8 patterns can be set for a day. The day-off setting is provided for holidays and non-business days.
Note (1) It is necessary to set the clock to use the weekly timer.

(vii) Combination of patterns which can be set for the timer operations

	Sleep timer	Set OFF timer by hour	Set ON timer by hour	Set OFF timer by clock	Set ON timer by clock	Weekly timer
Sleep timer		×	×	○	○	○
Set OFF timer by hour	×		×	×	×	×
Set ON timer by hour	×	×		×	×	×
Set OFF timer by clock	○	×	×		○	×
Set ON timer by clock	○	×	×	○		×
Weekly timer	○	×	×	×	×	

Note (1) ○: Allowed ×: Not

(b) RC-E5

- (i) **Sleep timer**
Set the duration of time from the present to the time to turn off the air-conditioner.
It can be selected from 10 steps in the range from “OFF 1 hour later” to “OFF 10 hours later”. After the sleep timer setting, the remaining time is displayed with progress of time in the unit of hour.
- (ii) **OFF timer**
Time to turn OFF the air-conditioner can be set in the unit of 10 minutes.
- (iii) **ON timer**
Time to turn ON the air-conditioner can be set in the unit of 10 minutes. Indoor temperature can be set simultaneously.
- (iv) **Weekly timer**
Timer operation (ON timer, OFF timer) can be set up to 4 times a day for each weekday.
- (v) **Combination of patterns which can be set for the timer operations**

Item	Sleep timer	OFF timer	ON timer	Weekly timer
Sleep timer		×	○	×
OFF timer	×		○	×
ON timer	○	○		×
Weekly timer	×	×	×	

Notes (1) ○: Allowed ×: Not

(2) Since the ON timer, sleep timer and OFF timer are set in parallel, when the times to turn ON and OFF the air-conditioner are duplicated, the setting of the OFF timer has priority.

(5) Outline of heating or cooling operation

(a) Operation of major functional components in heating mode

	Heating		
	Thermostat ON	Thermostat OFF	Failure
Compressor	ON	OFF	OFF
Indoor fan	ON	ON(HOT KEEP)	OFF
Outdoor fan	ON	OFF (few minutes ON)	OFF
4-way valve	ON	ON	OFF (3 minutes ON)

(b) Operation of major functional components in cooling mode

	Cooling		
	Thermostat ON	Thermostat OFF	Failure
Compressor	ON	OFF	OFF
Indoor fan	ON	ON	OFF
Outdoor fan	ON	OFF (few minutes ON)	OFF (few minutes ON)
4-way valve	OFF	OFF	OFF

(6) Indoor fan motor protection

When the air-conditioner is operating and the indoor fan motor is turned ON, if the indoor fan motor has operated at 300 min⁻¹ or lower for more than 30 seconds, the unit enters first in the stop mode and then stops the entire system.

(7) Serial signal transmission error protection (Only SRK-ZSX series)

(a) Purpose

Prevents malfunction resulting from error on the indoor ↔ outdoor signals.

(b) Detail of operation

If the compressor is operating and a serial signal cannot be received from the indoor control with outdoor control having serial signals continues for 7 minutes and 35 seconds, the compressor is stopped. After the compressor has been stopped, it will be re-started after the compressor start delay if a serial signal can be received again from the indoor control.

(8) Plural unit control – Control of 16 units group by one remote control

(a) Function

One remote control can control a group of multiple number of unit (Max. 16 indoor units). “Operation mode” which is set by the remote control switch can operate or stop all units in the group one after another in the order of unit No.⁽¹⁾. Thermostat and protective function of each unit function independently.

Note (1) Unit No. is set by SW1 on the interface PCB. Unit No. setting by SW1 is necessary for the interface only. In cases of the twin and triple specification, it is necessary set for the master and the slave units. This can be selected by SW3. (All are set for the master unit at the shipping from factory.)

SW1: For setting of 0 – 9, A – F

SW3: For setting of master and slave units

(See table shown at right.)

SW3 setting (For interface PCB)

Unit	Switch	SW3-1	SW3-2
	Master		OFF
Slave1		OFF	ON
Slave2		ON	OFF

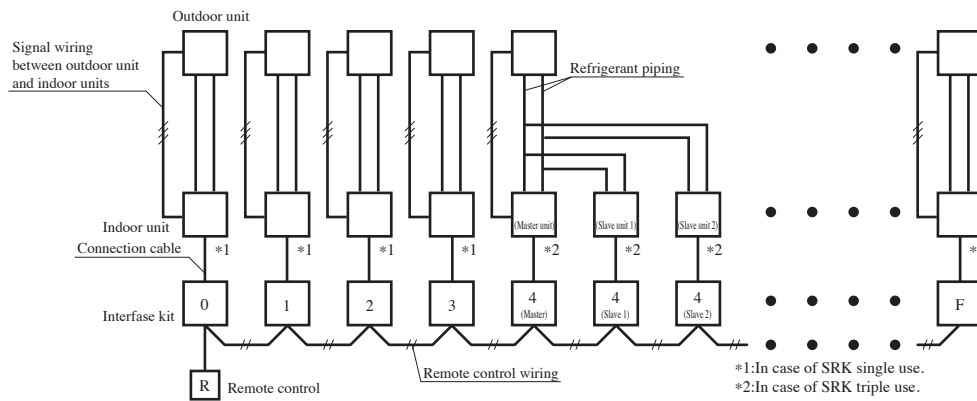

(2) Unit No. may be set at random unless duplicated, it should be better to set orderly like 0, 1, 2..., F to avoid mistake.

(b) Display to the remote control

(i) Central or each remote control basis, heating preparation

The smallest unit No. among the operating units in the remote mode (or the center mode unless the remote mode is available) is displayed.

(ii) Inspection display, filter sign

Any of unit that starts initially is displayed.

(iii) Confirmation of connected units

1) In case of RC-EX3A remote control

If you touch the buttons in the order of “Menu” → “Service setting” → “Service & Maintenance” → “Service password” → “IU address” on the TOP screen of remote control, the indoor units which are connected are displayed.

2) In case of RC-E5 remote control

Pressing “AIR CON No.” button on the remote control displays the indoor unit address. If “▲” “▼” button is pressed at the next, it is displayed orderly starting from the unit of smallest No..

(c) In case of anomaly

If any anomaly occurs on a unit in a group (a protective function operates), that unit stops with the anomalous stop but any other normal units continue to run as they are.

(d) Signal wiring procedure

Signal wiring between indoor and outdoor units should be made on each unit same as the normal wiring. For the group control, connect with wiring between rooms using terminal blocks (X, Y) of interface kit.

Connect the remote control communication wire separately from the power source cable or wires of other electric devices (AC220V or higher).

(9) Filter sign

As the operation time (Total ON time of ON/OFF switch) accumulates to 180 hours (1), “FILTER CLEANING” is displayed on the remote control. (This is displayed when the unit is in trouble and under the central control, regardless of ON/OFF)

Note (1) Time setting for the filter sign can be made as shown below using the indoor function of wired remote control “FILTER SIGN SET”. (It is set at 1 at the shipping from factory.)

Filter sign setting	Function
Setting 1	Setting time: 180 hrs (Factory default)
Setting 2	Setting time: 600 hrs
Setting 3	Setting time: 1,000 hrs
Setting 4	Setting time: 1,000 hrs (Unit stop) ⁽²⁾

(2) After the setting time has elapsed, the “FILTER CLEANING” is displayed and, after operating for 24 hours further (counted also during the stop), the unit stops.

(10) Outline of automatic operation

(a) Determination of operation mode

Operation mode is determined by indoor air temperature and outdoor air temperature as following.

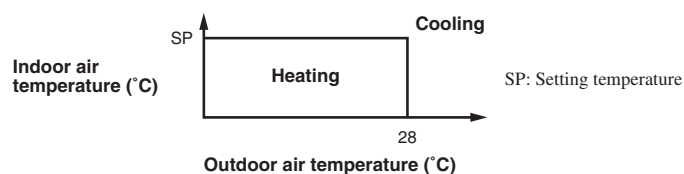

- (b) Operation mode is changes when keep cooling and heating thermostat off 20 minutes and be satisfied following conditions. If the setting temperature is changed with the remote control, the operation mode is judged immediately.

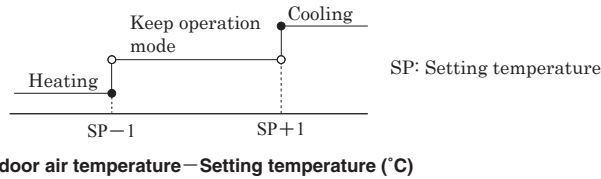

※It can not be changed to heating mode if outdoor air temperature is 28°C or higher.

- (c) When the unit is started again within one hour after the stop of automatic operation or when the automatic operation is selected during heating, cooling or dehumidifying operation, the unit is operated in the previous operation mode.
- (d) Setting temperature can be adjusted within the following range. There is the relationship as shown below between the signals of the wireless remote control and the setting temperature.

Unit : °C

		Signals of wireless remote control (Display)												
		18	19	20	21	22	23	24	25	26	27	28	29	30
Setting temperature	Cooling	18	19	20	21	22	23	24	25	26	27	28	29	30
	Heating	18	19	20	21	22	23	24	25	26	27	28	29	30

(11) Frost prevention control (During cooling or dehumidifying)

(a) Operating conditions

- 1) More than 8 minutes after starting the compressor.
- 2) Indoor heat exchanger temperature (detected with Th2) is lower than 2.5 °C .

(b) Contents of frosting operation

	During this control	Reset
Compressor ON/OFF command	Forced stop	Operation command
Indoor fan motor	Depending on the air flow setting with the remote control	

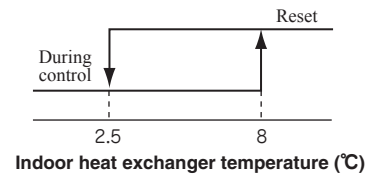

(c) Resetting condition

Indoor heat exchanger temperature (Th2) is higher than 8 °C .

(12) Dew prevention control (During cooling or dehumidifying)

(a) SRK-ZSX series

Prevents dewing on the indoor unit.

(i) Operating conditions

When the following conditions have been satisfied for more than 30 minutes after starting operation

- 1) Compressor's speed is 22 rps or higher.
- 2) Detected value of humidity is 60% or higher.

(ii) Contents of operation

1) Air capacity control

Item		Model	SRK50, 60ZSX-W
Twin type	ULo	Upper limit of compressor's speed	RangeA: 50 rps, RangeB: 50 rps, RangeC: 24 rps
		Indoor fan	4th speed
	Lo	Upper limit of compressor's speed	RangeA: 50 rps, RangeB: 50 rps, RangeC: 24 rps
		Indoor fan	Adaptable to compressor speed
	Auto, Me	Upper limit of compressor's speed	RangeA: 50 rps, RangeB: 50 rps, RangeC: 30 rps
		Indoor fan	Adaptable to compressor speed
Hi	Upper limit of compressor's speed	RangeA: 70 rps (SRK60: 80 rps), RangeB: 50 rps, RangeC: 30 rps	
	Indoor fan	Adaptable to compressor speed	
Triple type	ULo	Upper limit of compressor's speed	RangeA: 50 rps, RangeB: 50 rps, RangeC: 24 rps
		Indoor fan	4th speed
	Lo	Upper limit of compressor's speed	RangeA: 50 rps, RangeB: 50 rps, RangeC: 24 rps
		Indoor fan	Adaptable to compressor speed
	Auto, Me	Upper limit of compressor's speed	RangeA: 50 rps, RangeB: 50 rps, RangeC: 30 rps
		Indoor fan	Adaptable to compressor speed
Hi	Upper limit of compressor's speed	RangeA: 70 rps (SRK60: 80 rps), RangeB: 50 rps, RangeC: 30 rps	
	Indoor fan	Adaptable to compressor speed	

Note (1) Ranges A and B are as shown below.

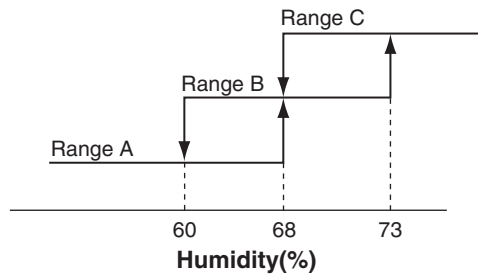

- 2) When this control has continued for more than 30 minutes continuously, the following wind direction control is performed.
 - a) When the vertical wind direction is set at other than the vertical swing, the flaps change to the horizontal position.
 - b) When the horizontal wind direction is set at other than the horizontal swing, the louver changes to the vertical position.

(iii) Reset condition

Humidity is less than 55%.

(b) SRK-ZR series

(i) Operating conditions

When the following conditions have been satisfied for more than 30 minutes after starting operation

- 1) Compressor's command speed is 28 rps (SRK100: 20 rps) or higher.
- 2) Detected value of humidity is 68% or higher.

(ii) Contents of operation

1) Air capacity control

Item	Model	SRK 100ZR-W
Upper limit of compressor's command speed ⁽¹⁾	Range A: As per following table, Range B: 54 rps (SRK100: 40 rps)	

Note (1) Ranges A and B are as shown below.

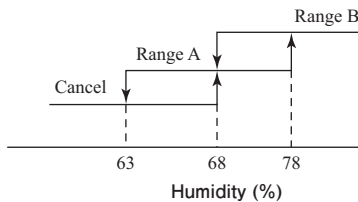

● Condition for range A

Compressor's command speed is controlled according to the indoor unit heat exchanger temperature (Th2) and the indoor unit room temperature (Th1).

Condition	Compressor's command speed
$Th2 \leq Th1 - 10$	<ul style="list-style-type: none"> Decreases the compressor's target max speed by 4 rps. If the condition is satisfied still 20 seconds later, the speed is decreased further by 4 rps. This process is repeated further so far as the condition is satisfied. [Lower limit is 30 rps (SRK100: 20 rps).]
$Th1 - 10 < Th2 \leq Th1 - 6$	Compressor's target max. speed or changed value of the same is maintained.
$Th1 - 6 < Th2$	Changed compressor's target max. speed is increased at a rate of 1 rps/20 seconds.

- 2) When this control has continued for more than 30 minutes continuously, the following wind direction control is performed.

When the vertical wind direction is set at other than the vertical swing, the flaps change to the horizontal position.

(iii) Reset conditions

When either of the following conditions is satisfied.

- Compressor's command speed is less than 28 (SRK100: 20 rps) rps.
- Detected value of humidity is less than 63%.

(13) Outline of dehumidifying (DRY) operation

(a) Purpose of DRY mode

The purpose is "Dehumidification", and not to control the humidity to the target condition. Indoor/outdoor unit control the operation condition to reduce the humidity, and also prevent over cooling.

(b) Outline of control

- (i) Indoor fan speed and compressor are controlled by the area which is selected by the temperature difference.

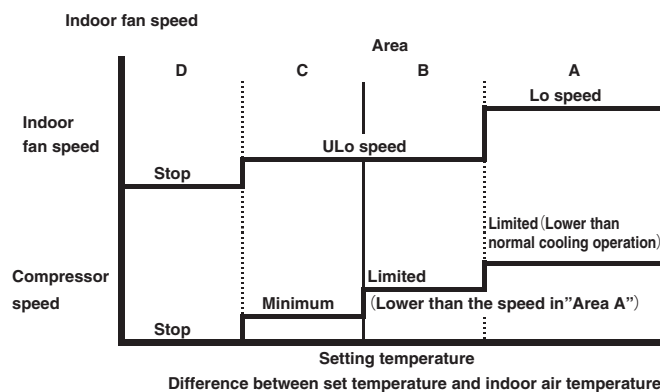

- (ii) The indoor unit check the current area by every 5 minutes, and operate by the next checking.

1.1.4 Operation control function by the outdoor control

(1) Determination of compressor speed (Frequency)

Required frequency

(a) Cooling/dehumidifying operation Unit: rps

Model		FDC100	FDC125	FDC140
Max. required frequency	Usual operation	75	95	95
	Silent mode, outdoor air temperature $\leq 15^{\circ}\text{C}$	40	50	58
	Silent mode II (When SW4-1 ON)	36	36	36
Min. required frequency		11	11	11

(b) Heating operation Unit: rps

Model		FDC100	FDC125	FDC140
Max. required frequency	Usual operation	100	120	120
	Silent mode	39	50	59
	Silent mode II (When SW4-1 ON)	36	36	36
Min. required frequency		11	11	11

(c) If the indoor fan speed becomes “Me” or “Lo”, Max required frequency goes down accordingly depending on indoor unit model.

(d) Max. required frequency under high outdoor air temperature in cooling mode
Maximum required frequency is selected according to the outdoor air temperature (Tho-A).

Unit: rps

Model		FDC100	FDC125	FDC140
Max. required frequency	Outdoor air temperature is 40°C or higher	75	75	75
	Outdoor air temperature is 46°C or higher	70	70	70

(e) Max. required frequency under outdoor air temperature in heating mode.
Maximum required frequency is selected according to the outdoor air temperature (Tho-A).

Unit: rps

Model		FDC100	FDC125	FDC140
Max. required frequency	Outdoor air temperature is 18°C or higher	80	80	85
	Outdoor air temperature is 10°C or higher	75	95[92]	95[92]

Note (1) Value in [] are for the 3 phase models.

(f) Selection of max. required frequency by heat exchanger temperature

(i) Maximum required frequency is selected according to the outdoor heat exchanger temperature (Tho-R) during cooling/dehumidifying or according to the indoor heat exchanger temperature (Thi-R) during heating mode.

(ii) When there are 3 indoor heat exchanger temperatures (Thi-R), whichever the highest applies.
When there are 2 outdoor heat exchanger temperatures (Tho-R), whichever the higher applies.

Unit: rps



Model			FDC100	FDC125	FDC140
Max. required frequency	Cooling/dehumidifying	Outdoor heat exchanger temperature is 55°C or higher	70	95[92]	95[92]
	Heating	Indoor heat exchanger temperature is 55°C or higher	100	100	100

Note (1) Value in [] are for the 3 phase models.

(g) When any of the controls from (a) to (f) above may duplicate, whichever the smallest value among duplicated controls is taken as the maximum required frequency.

(h) During heating, it is operated with the maximum required frequency until the indoor heat exchanger temperature becomes 40°C or higher.

(2) Compressor start control

- (a) Compressor starts upon receipt of the thermostat ON signal from the indoor unit.
- (b) However, at initial start after turning the power source breaker, it may enter the standby state for maximum 30 minutes (“ PREPARATION” is displayed on the remote control) in order to prevent the oil loss in the compressor.
If the cooling/dehumidifying/heating operation is selected from the remote control when the outdoor unit is in the standby state, “ PREPARATION” is displayed for 3 seconds on the remote control.

(3) Compressor soft start control

(a) Compressor protection start I

[Control condition] Normally, the compressor operation frequency is raised in this start pattern.

- [Control contents] (i) Starts with the compressor’s target frequency at **A** rps.
However, when the outdoor air temperature (Tho-A) is 35°C or higher during cooling/dehumidifying or the indoor return air temperature (Thi-A) is 25°C or higher during heating, it starts at **C** rps.
- (ii) At 30 seconds after the start of compressor, its target frequency changes to **B** rps and the compressor is operated for 2 - 4 minutes with its operation frequency fixed at **B** rps.

Model	Operation mode	A rps	B rps	C rps
FDC100-140	Cooling/Dehumidifying	35	35	25
	Heating	35	35	25

(b) Compressor protection start III

[Control condition] Number of compressor starts is only 1 counted after the power source breaker ON.

[Control contents] Operates by selecting one of following start patterns according to the operation mode and the outdoor air temperature (Tho-A).

- (i) Low frequency operation control during cooling/dehumidifying
[Control condition] Upon establishing the conditions of compressor protection start III, the low frequency operation control is performed during cooling/dehumidifying.
[Control contents] 1) Starts with the compressor’s target frequency at **A** rps. When the outdoor air temperature (Tho-A) is 35°C or higher, it starts at **C** rps.
2) At 30 seconds after the compressor start, the compressor’s target frequency is changed to **B** rps and the compressor’s operation frequency is fixed for 10 minutes.

Model	Operation mode	A rps	B rps	C rps
FDC100-140	Cooling/Dehumidifying	35	35	25

- (ii) Low frequency operation control during heating
[Control condition] When the conditions of compressor protection start III are established and one of following conditions 1) is satisfied, the low number of revolutions operation control is performed during heating.
1) At 30 minutes or more after turning the power source breaker on.
[Control contents] 1) Starts the compressor with its target frequency at **A** rps. However, when the indoor return air temperature (Thi-A) is 25°C or higher, it starts at **C** rps.
2) At 30 seconds after the start of compressor, the compressor’s target frequency is changed to **B** rps and the compressor’s operation frequency is fixed for 10 minutes.

Model	Operation mode	A rps	B rps	C rps
FDC100-140	Heating	35	35	25

(4) Outdoor fan control

(a) Outdoor fan tap and fan motor speed

Unit: min⁻¹

Model	Mode	Fan motor tap						
		① speed	② speed	③ speed	④ speed	⑤ speed	⑥ speed	⑦ speed
FDC100-140	Cooling/Dehumidifying	200	370	560	640	745	870	910
	Heating	200	370	560	650	830	870	910

(b) Fan tap control during cooling/defumidifying operation

Fan taps are selected depending on the outdoor heat exchanger temperature (Tho-R1, R2) and the outdoor air temperature (Tho-A).

Note (1) It is detected by Tho-R1 or R2, whichever the higher.

• Silent mode only

	(A) zone	(B) zone	(C) zone	(D) zone
(a) zone	Tap 5	Tap 5	Tap 5	Tap 4
(b) zone	Tap 5	Tap 5	Tap 4	Tap 3
(c) zone	Tap 4	Tap 4	Tap 3	Tap 2
(d) zone	Tap 3	Tap 3	Tap 2	Tap 1

	(A) zone	(B) zone	(C) zone	(D) zone
(a) zone	Tap 5	Tap 5	Tap 5	Tap 4
(b) zone	Tap 5	Tap 4	Tap 3	Tap 3
(c) zone	Tap 4	Tap 3	Tap 3	Tap 2
(d) zone	Tap 3	Tap 3	Tap 2	Tap 1

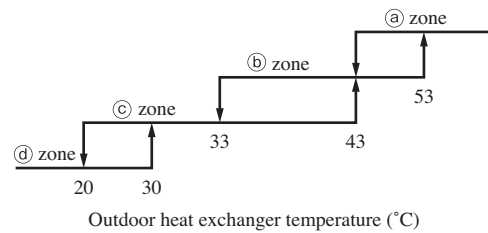
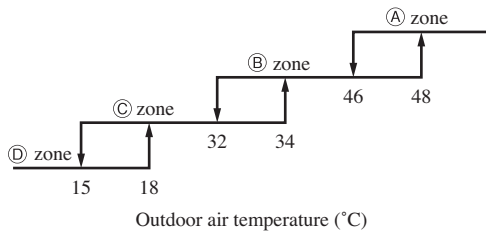

(c) Fan tap control during heating operation

Fan taps are selected depending on the outdoor heat exchanger temperature (Tho-R1, R2) and the outdoor air temperature (Tho-A).

Note (1) It is detected by Tho-R1 or R2, whichever the lower.

• Silent mode only

	(A) zone	(B) zone	(C) zone
(a) zone	Tap 3	Tap 3	Tap 4
(a) zone	Tap 3	Tap 3	Tap 4
(b) zone	Tap 3	Tap 4	Tap 5
(c) zone	Tap 4	Tap 5	Tap 6
(d) zone	Tap 5	Tap 6	Tap 7

	(A) zone	(B) zone	(C) zone
(a) zone	Tap 3	Tap 3	Tap 3
(a) zone	Tap 3	Tap 3	Tap 3
(b) zone	Tap 3	Tap 3	Tap 5
(c) zone	Tap 4	Tap 5	Tap 6
(d) zone	Tap 4	Tap 5	Tap 6

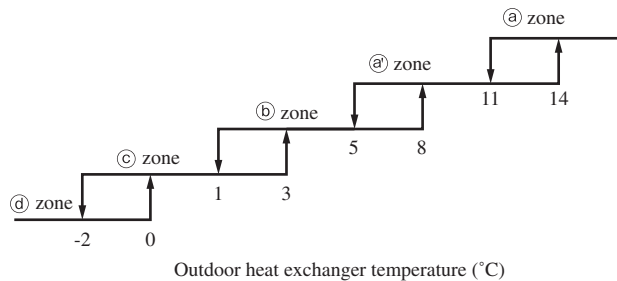
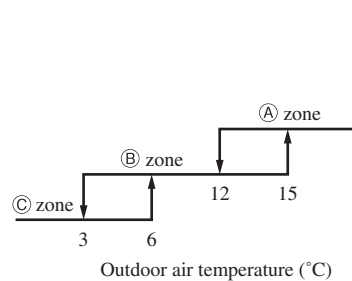

(d) Outdoor fan control at cooling low outdoor air temperature

The outdoor heat exchanger temperature is detected always and, when the number of revolutions of the outdoor fan speed has been increased or decreased, there is no change of fan speed for 20 seconds.

(e) Outdoor fan control by the power transistor radiator fin temperature

When all the following conditions are established later than 3 minutes after the start of compressor, the following control is implemented.

- (i) Cooling/dehumidifying
 - 1) Outdoor air temperature (Tho-A) $\geq 33^{\circ}\text{C}$
 - 2) Compressor's actual frequency $\geq \mathbf{A}$ rps
 - 3) Power transistor radiator fin temperature $\geq \mathbf{C}$ $^{\circ}\text{C}$
- (ii) Heating
 - 1) Outdoor air temperature (Tho-A) $\geq 16^{\circ}\text{C}$
 - 2) Compressor's actual frequency $\geq \mathbf{B}$ rps
 - 3) Power transistor radiator fin temperature $\geq \mathbf{C}$ $^{\circ}\text{C}$
- (iii) Control contents
 - 1) Raises the outdoor fan tap by 1 tap.
 - 2) When the sampling is for 60 minutes and the value of power transistor radiator fin temperature (Tho-P) is as follows.
 - a) When the power transistor radiator fin temperature (Tho-P) $\geq \mathbf{C}$ $^{\circ}\text{C}$, the outdoor fan tap is raised by 1 speed further.
 - b) When \mathbf{C} $^{\circ}\text{C} >$ power transistor radiator fin temperature (Tho-P) $> \mathbf{D}$ $^{\circ}\text{C}$, present outdoor fan tap is maintained.
 - c) When the power transistor radiator fin temperature (Tho-P) $\leq \mathbf{D}$ $^{\circ}\text{C}$, the outdoor fan tap is dropped by 1 speed.
- (iv) Ending conditions

When the operation under the condition of item 2), c) above and with the outdoor fan tap, which is determined by the item (b) is detected 2 times consecutively.

 - Compressor's frequency and power transistor radiator fin temperature

Item	A	B	C	D
Model FDC100-140	65	65	72	68

(f) Caution at the outdoor fan start control (3 phase model only)

When the outdoor fan is running at 400min^{-1} before operating the compressor, it may operate with the compressor only, without starting up the outdoor fan this is normal.

(g) Snow protection fan control

If the dip switch (SW3-2) on the outdoor control PCB is turned ON, the outdoor fan is operated for 30 seconds at 4 tap speed once in every 10 minutes depending on the outdoor air temperature (detected with Tho-A) in the stop mode or anomalous stop mode.

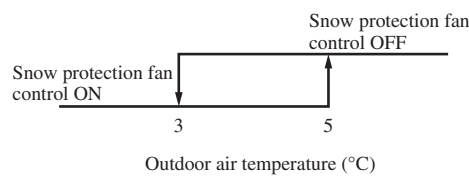

(5) Defrost operation

(a) Starting conditions

If all of the following defrost conditions A or conditions B are satisfied, the defrost operation starts.

(i) Defrost conditions A

- 1) Cumulative compressor operation time after the end of defrost operation has elapsed 37 minutes, and the cumulative compressor operation time after the start of heating operation (remote control ON) has elapsed 30 minutes.
- 2) After 5 minutes from the compressor ON
- 3) After 5 minutes from the start of outdoor fan
- 4) After satisfying all above conditions, if temperatures of the outdoor heat exchanger temperature sensor (Tho-R1, R2) and the outdoor air temperature sensor (Tho-A) become lower than the defrost operation starting temperature as shown by the right figure for 15 seconds continuously, or the suction gas saturation temperature (SST) and the outdoor air temperature (Tho-A), which are obtained from the value detected by the low pressure sensor (LPT) stay for 3 minutes within the range below the defrost operation start temperature as shown by the right figure. However, it excludes for 10 minutes after the start of compressor and the outdoor air temperature is as shown by the lower figure.

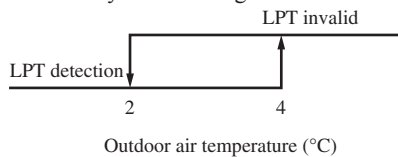

(ii) Defrost conditions B

- 1) When previous defrost ending condition is the time out of defrost operation and it is in the heating operation after the cumulative compressor operation time after the end of defrost operation has become 30 minutes.
- 2) After 5 minutes from the start of compressor
- 3) After 5 minutes from the start of outdoor fan

(b) Ending conditions

When any of the following conditions is satisfied, the heating operation starts.

- (i) When it has elapsed 13 minutes and 20 seconds after the start of defrost operation.
- (ii) When the outdoor heat exchanger temperatures (Tho-R1, R2), whichever the lower, becomes 12°C or higher for 60 seconds continuously.

Model FDC100-140

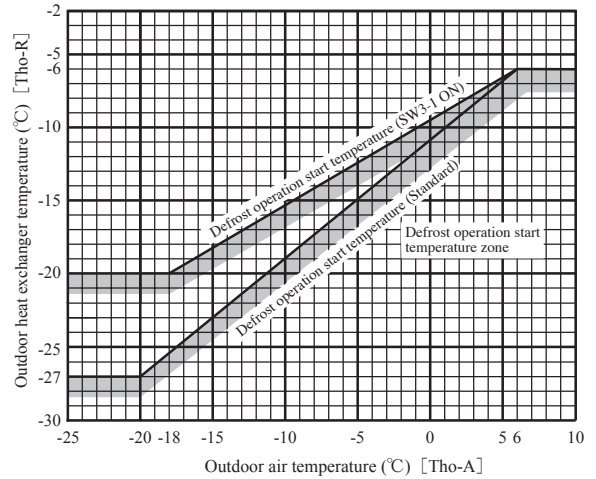

Model FDC100-140

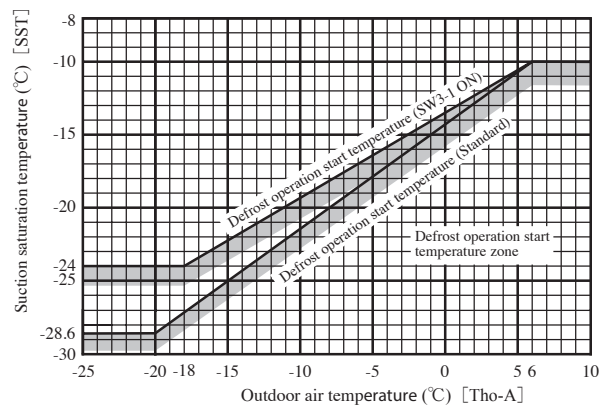

(c) Switching of defrost control with SW3-1

- (i) If SW3-1 on the outdoor control PCB is turned to ON, it becomes easier to enter the defrost operation. Use this when installing a unit at snowing regions.
- (ii) Control contents
 - 1) It allows entering the defrost operation under the defrost condition A when the cumulative heating operation time becomes 30 minutes. It is 37 minutes at SW3-1 OFF (Factory default).
 - 2) It allows entering the defrost operation under the defrost condition B when the cumulative heating operation time becomes 25 minutes. It is 30 minutes at SW3-1 OFF (Factory default).
 - 3) It allows the defrost operation with the outdoor heat exchanger temperature (Tho-R) and suction pressure saturation temperature (SST) being higher than normal.

(6) Protective control/anomalous stop control by compressor's number of revolutions

(a) Compressor discharge pipe temperature protection

- (i) Protective control
As the discharge pipe temperature (detected with Tho-D) exceeds the setting value, the compressor speed (frequency) is controlled to suppress the rise of discharge pipe temperature.

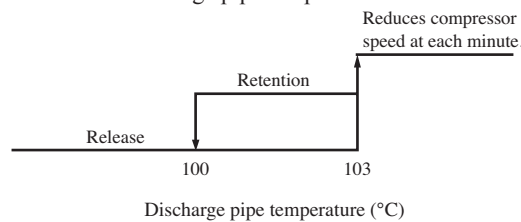

- (ii) Anomalous stop control

- 1) If the discharge pipe temperature (detected with Tho-D) exceeds the setting value, the compressor stops.
- 2) When it is detected 2 times within 60 minutes or after continuous 30 minutes, including the stop of compressor, E36 is displayed on the remote control and it enters the anomalous stop mode.

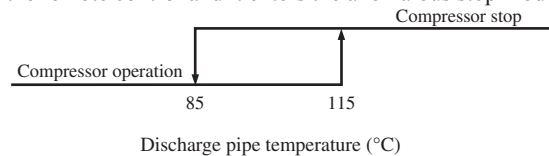

- (iii) Reset of anomalous stop mode

As it drops to the reset value of 85°C or lower for 45 minutes continuously, it becomes possible to restart from the remote control.

(b) Cooling high pressure protection

- (i) Protective control
 - 1) When the outdoor air temperature (Tho-A) is 40°C or higher and the outdoor heat exchanger temperature (Tho-R) exceeds the setting value, the compressor speed (frequency) is controlled to suppress the rise of high pressure.
 - 2) Control value A is updated to an optimum value automatically according to the operating conditions.

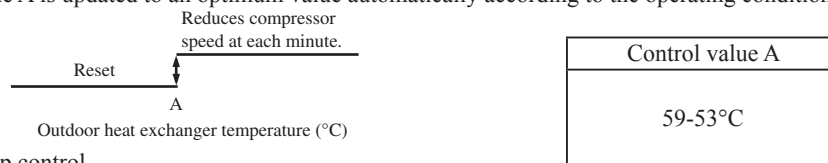

- (ii) Anomalous stop control

- 1) As the outdoor heat exchanger temperature (Tho-R) exceeds the setting value, the compressor stops.
- 2) If it is detected 5 times within 60 minutes or 63°C or higher continues for 30 minutes, including the stop of compressor, E35 is displayed on the remote control and it enters the anomalous stop mode.

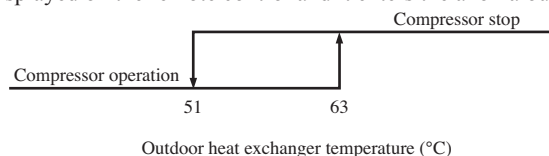

- (iii) Reset of anomalous stop mode

As it reaches the reset value of 51°C or lower, it becomes possible to restart from the remote control.

(c) Heating high pressure protection

- (i) Protective control
 - 1) As the indoor heat exchanger temperature (Thi-R) exceeds the setting value, the compressor speed (frequency) is controlled to suppress the rise of high pressure.
 - 2) Control value A is updated to an optimum value automatically according to the operating conditions.

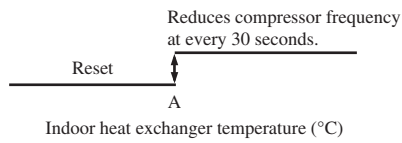

Model	Existing piping adaptation switch: SW5-1	
	OFF (Shipping)	ON
	Control value A (°C)	
FDC100-140	54-48	51-45

Note (1) Adaptation to existing piping is at ON.

- (ii) Anomalous stop control
Operation control function by the indoor unit control - See the heating overload protection, page 21.
- (iii) Adaptation to existing piping, stop control
If the existing piping adaptation switch, SW5-1 is turned ON, the compressor stops to protect existing piping when the indoor heat exchanger temperature (Thi-R) exceeds the setting value.

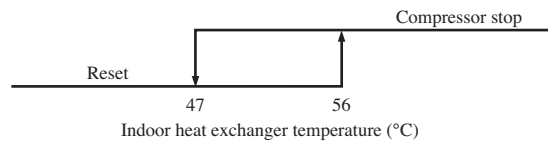

(d) Anomaly detection control by the high pressure switch (63H1)

- (i) If the pressure rises and operates the high pressure switch (opens at 4.15MPa/closes at 3.15MPa), the compressor stops.
- (ii) Under any of the following conditions, E40 is displayed and it enters the anomalous stop mode.
 - 1) When it occurs 5 times within 60 minutes that pressure rises and the compressor is stopped by 63H1.
 - 2) When 63H1 has been in the open state for 60 minutes continuously, including the stop of compressor.

(e) Low pressure control

- (i) Protective control
If the value detected by the low pressure sensor (LPT) exceeds the setting value, the compressor speed (frequency) is controlled to restrain the drop of pressure.

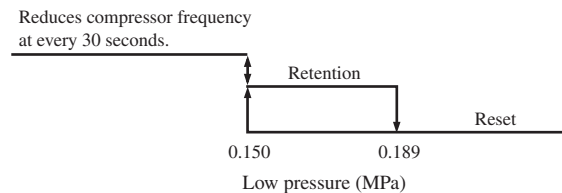

- (ii) Anomalous stop control
 - 1) When a value detected by the low pressure sensor (LPT) satisfies any of the following conditions, the compressor stops to run for its protection.
 - a) When the low pressure drops to 0.079MPa or under for 15 seconds continuously.
 - b) At 10 minutes after the start of compressor, the suction overheat becomes 30°C or higher and the low pressure becomes 0.15MPa or under for 60 seconds continuously.
 - 2) E49 is displayed under any of the following conditions and it enters the anomalous stop mode.
 - a) When the low pressure drops 3 times within 60 minutes and the compressor stops under any of the above conditions.
 - b) When a value detected with the low pressure sensor becomes 0.079MPa or under for 5 minutes continuously, including the stop of compressor.
 - 3) However, when the control condition 1). a) is established during the compressor protection start III, E49 is displayed at initial stop and it enters the anomalous stop mode.

(f) Over-current protection current safe controls I, II

Detecting the outdoor inverter input (primary) current and the output (secondary) current, if the current values exceed setting values, the compressor speed (frequency) is controlled to protect the inverter.

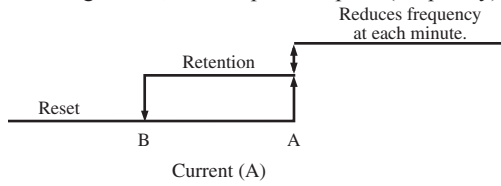

Model		Cooling		Heating	
		Control value A	Reset value B	Control value A	Reset value B
Primary current side	FDC100	11.0 (23.0)	10.0 (22.0)	11.0 (23.0)	10.0 (22.0)
	FDC125, 140	11.0 (23.0)	10.0 (22.0)	11.0 (25.0)	10.0 (24.0)
Secondary current side	FDC100	11.5 (Fig.C)	10.5 (Fig.C-1)	11.5 (Fig.C)	10.5 (Fig.C-1)
	FDC125, 140	11.5 (Fig.C)	10.5 (Fig.C-1)	11.5 (Fig.C)	10.5 (Fig.C-1)

(Fig. C) The control value “A” and the reset value vary depending on the compressor speed.

Note (1) Value in () are for the single phase models.

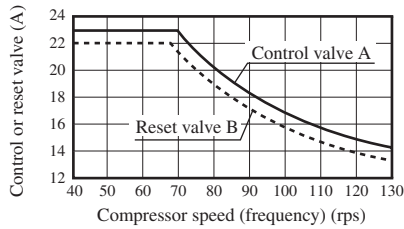

(g) Power transistor temperature protection

(i) Protective control

If the power transistor temperature (detected with TIP) exceeds the setting value, the compressor speed (frequency) is controlled to suppress the rise of power transistor temperature.

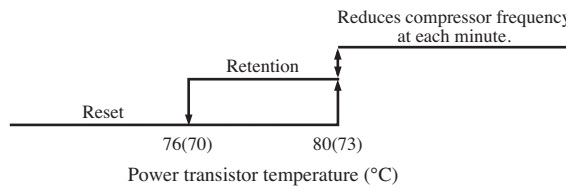

Note (1) Value in () are for the single phase model.

(h) Anomalous power transistor current

- (i) Prevents over-current on the inverter. If the current value in the power transistor exceeds the setting value, the compressor stops.
- (ii) If the current value in the power transistor exceeds the specified value and the compressor stops 4 times within 30 minutes, E42 is displayed on the remote control and it enters the anomalous stop mode.

(i) Anomalous inverter PCB

If the power transistor detects any anomaly for 15 minutes, including the stop of compressor, E51 is displayed on the remote control and it enters the anomalous stop mode.

(j) Anti-frost control by the compressor frequency control

- (i) If the indoor heat exchanger temperature (detected with Thi-R) exceeds the setting value at 4 minutes after the start of compressor, the compressor speed (frequency) is controlled to initiate the anti-frost control of indoor heat exchanger.
- (ii) When there are 3 indoor heat exchanger temperatures (Thi-R), the lowest temperature is detected.

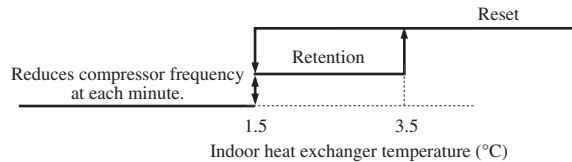

- (iii) Regarding the anti-frost control by the operation stop, refer to the operation control function by the indoor control and the cooling, dehumidifying frost prevention of page 21.

(k) Dewing prevention control

[Control condition]

During cooling and dehumidifying operation, if all the following conditions are established, the compressor speed (frequency) is reduced to prevent dewing and water splash.

- (i) Cooling electronic expansion valve aperture (EEVC) is 500 pulses.
- (ii) Suction overheat is 10°C or higher.
- (iii) Compressor speed (frequency) is **A** rps or higher.

[Control contents]

- (i) When the suction overheat is 10°C or higher, the compressor speed (frequency) is reduced at each 1 minute.
- (ii) Compressor speed (frequency) does not rise till the cooling expansion valve becomes 460 pulses.
- (iii) This control takes **A** rps as its lower limit so that compressor speed is not controlled when it is less than **A** rps.

Model	A rps
FDC100-140	60

(l) Refrigerant quantity shortage protection

Under the compressor protection start III control during cooling and dehumidifying operations, the following control is performed by detecting the indoor heat exchanger temperature (Thi-R) and the indoor return air temperature (Thi-A).

[Control condition]

When the state that the indoor heat exchanger temperature (Thi-R) does not become lower than the indoor return air temperature (Thi-A) by 4°C or more continues for 1 minute.

[Control contents]

It judges that the flowing of refrigerant in to the indoor unit is insufficient so that the compressor is stopped and E57 is displayed on the remote control.

(m) Broken wire detection on temperature sensor and low pressure sensor

- (i) Outdoor heat exchanger sensor, outdoor air temperature sensor and low pressure sensor
If the following is detected for 5 seconds continuously within 2 minutes to 2 minutes and 20 seconds after the compressor ON, the compressor stops. After a delay of 3 minutes, it restarts but, if the same is detected repeatedly 3 times within 40 minutes, the compressor stops with the anomalous stop.

Note (1) During defrost operation and for 3 minutes after the end of defrost operation, it is not detected.

- Outdoor heat exchanger sensor: -50°C or lower
- Outdoor air temperature sensor: -45°C or lower
- Low pressure sensor: 0V or under or 4.0V or over

- (ii) Discharge pipe temperature sensor, suction pipe temperature sensor
If the following is detected for 5 seconds continuously within 10 minutes to 10 minutes and 20 seconds after the compressor ON, the compressor stops. After a delay of 3 minutes, it restarts but, if the same is detected repeatedly 3 times within 40 minutes, the compressor stops with the anomalous stop.

Note (1) During defrost operation and for 3 minutes after the end of defrosting, it is not detected.

- Discharge pipe temperature sensor: -10°C or lower
- Suction pipe temperature sensor: -50°C or lower

(n) Fan motor error

- (i) If the fan speed of 100min⁻¹ or under is detected for 30 seconds continuously under the outdoor fan control (with the operation command of fan tap at ① speed or higher), the compressor stops.
- (ii) When the fan motor speed drops to 100min⁻¹ or under 5 times within 60 minutes and the compressor stops, it enters the anomalous stop mode with E48 displayed on the remote control.

(o) Anomalous stop by the compressor start stop

- (i) When it fails to shift to the compressor DC motor's rotor position defection operation at 5 seconds after establishing the compressor starting condition, the compressor stops temporarily and restarts 3 minutes later.
- (ii) If it fails to shift to the position detection operation again at second time, it judges the anomalous compressor start and stops the compressor by the anomalous stop (E59).

(7) Silent mode

- (a) As “Silent mode start” signal is received from the remote control, it operates by dropping the outdoor fan tap and the compressor speed (frequency).
- (b) For details, refer to items (1) and (4) above.

(8) Test run

- (a) It is possible to operate from the outdoor unit using the DIP switch on the outdoor unit control PCB.

SW3-3	ON	SW3-4	OFF	Cooling test run
			ON	Heating test run
	OFF	Normal and end of test run		

Make sure to turn SW3-3 to OFF after the end of operation.

(b) Test run control

- (i) Operation is performed at the maximum compressor speed (frequency), which is determined for each model.
- (ii) Each protective control and error detection control are effective.
- (iii) If SW3-4 (SW5-4) is switched during test run, the compressor is stopped for once by the stop control and the cooling/heating operation is switched.

Note (1) Value in () is for the model FDC71.

(iv) Setting and display of remote control during test run

Mode \ Item	Contents of remote control setting/display
Cooling test run	Setting temperature of cooling is 5°C.
Heating test run	Setting temperature of heating (preparation) is 30°C.

(9) Pump-down control

Turning ON the pump-down switch SW1 for 2 seconds during the operation stop or anomalous stop (excluding the thermostat OFF), the pump-down operation is performed. (This is invalid when the indoor unit is operating. This is effective even when the indoor unit is stopped by the anomalous stop or the power source is turned OFF.)

(a) Control procedure

- (i) Close the service valve at the liquid side. (It is left open at the gas side.)
- (ii) Compressor is started with the target speed (frequency) at 45 rps in the cooling mode.
- (iii) Red and green lamps (LED) flash continuously on the outdoor control PCB.
- (iv) Each of protection and error detection controls, excluding the low pressure control, anti-frost control and dewing prevention control, is effective.
- (v) Outdoor unit fan is controlled as usual.
- (vi) Electronic expansion valve is fully opened.

(b) Control ending conditions

Stop control is initiated depending on any of the following conditions.

- (i) Low pressure of 0.087MPa or lower is detected for 5 seconds continuously.
 - 1) Red LED: Light, Green LED: Flashing, Remote control: Displays stop.
 - 2) It is possible to restart when the low pressure is 0.087MPa or higher.
 - 3) Electronic expansion valve (cooling/heating) is kept fully open.
- (ii) Stop by the error detection control
 - 1) Red LED: Keeps flashing, Green LED: Flashing
 - 2) Restart is prohibited. To return to normal operation, reset the power source.
 - 3) Electronic expansion valve (cooling/heating) is left fully open.
- (iii) When the cumulative operation time of compressor under the pump-down control becomes 5 minutes.
 - 1) Red LED: Stays OFF, Green LED: Flashing, Remote control: Stop
 - 2) It is possible to pump-down again.
 - 3) Electronic expansion valve (cooling/heating) is left fully open.

Note (1) After the stop of compressor, close the service valve at the gas side.

Caution: Since pressing the pump-down switch cancels communications with the indoor unit, the indoor unit and the remote control display “Transmission error – E5”. This is normal.

(10) Base heater ON/OFF output control (Option)

(a) Base heater ON conditions

When all of following conditions are satisfied, the base heater is turned ON.

- Outdoor air temperature (detected with Tho-A) is 3°C or lower.
- In the heating mode
- When the compressor is turned ON

(b) Base heater OFF conditions

When either one of following conditions is satisfied, the base heater is turned OFF.

- Outdoor air temperature (detected with Tho-A) is 5°C or higher.
- When the compressor stop has been detected for 30 minutes continuously
- In the cooling or dehumidifying mode

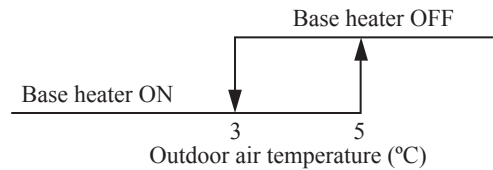

(11) Manual defrost (Need to activate SW4-4) *For maintenance only.

When unit is operated with SW4-4 ON, defrost operation will be activated in every 12 minutes.

Caution! This function is used for maintenance only.

Long term operation with this function will damage the compressor.

(12) Limit the number of compressor start (Need to activate SW7-2)

Maximum number of compressor start is to be limited up to 6 times per hour.

1.2 MAINTENANCE DATA

1.2.1 Diagnosing of microcomputer circuit

(1) Selfdiagnosis function

(a) Check indicator table

Whether a failure exists or not on the indoor unit and outdoor unit can be know by the contents of remote control error code, indoor/outdoor unit green LED (power pilot lamp and microcomputer normality pilot lamp) or red LED (check pilot lamp).

(i) Indoor unit

1) FDT, FDTC, FDU, FDUM, FDE series

Remote control		Indoor unit control PCB		Outdoor unit control PCB		Location of trouble	Description of trouble	Repair method	Reference page
Error code	Red LED	Red LED	Green LED (1)	Red LED	Green LED (1)				
No-indication	Stays OFF	Stays OFF	Keeps flashing	Stays OFF	Keeps flashing	—	• Normal operation	—	—
		Stays OFF	Stays OFF	2-time flash	Stays OFF	Indoor unit power source	• Power OFF, broken wire/blown fuse, broken transformer wire	Repair	88
		* 3-time flash	Keeps flashing	Stays OFF	Keeps flashing	Remote control wires Remote control	• Poor connection, breakage of remote control wire * For wire breaking at power ON, the LED is OFF. • Defective remote control PCB	Repair Replacement of remote control	89
WAIT or INSPECT I/U	Stays OFF	Keeps flashing	2-time flash	Keeps flashing	Indoor-outdoor units connection wire Remote control	• Poor connection, breakage of indoor-outdoor units connection wire • Improper setting of master and slave by remote control	Repair	90-94	
E1	Stays OFF	* Keeps flashing	Stays OFF	Keeps flashing	Remote control wires (Noise)	• Poor connection of remote control signal wire (White) * For wire breaking at power ON, the LED is OFF	Repair	96	
					Remote control indoor unit control PCB	• Intrusion of noise in remote control wire * Defective remote control or indoor unit control PCB (defective communication circuit)?	Replacement of remote control or PCB		
E5	2-time flash	Keeps flashing	2-time flash	Keeps flashing	Indoor-outdoor units connection wire	• Poor connection of wire between indoor-outdoor units during operation (disconnection, loose connection) • Anomalous communication between indoor-outdoor units by noise, etc.	Repair	97	
					(Noise)	• CPU-runaway on outdoor unit control PCB	Power reset or Repair		
					Outdoor unit control PCB	* Occurrence of defective outdoor unit control PCB on the way of power source (defective communication circuit)?	Replacement of PCB		
E6	1-time flash	Keeps flashing	Stays OFF	Keeps flashing	Outdoor unit control PCB	• Defective outdoor unit control PCB on the way of power source	Replacement	98	
					Fuse	• Blown fuse	Replacement, repair of temperature sensor		
E7	1-time flash	Keeps flashing	Stays OFF	Keeps flashing	Indoor heat exchanger temperature sensor	• Defective indoor heat exchanger temperature sensor (defective element, broken wire, short-circuit) • Poor contact of temperature sensor connector	Replacement, repair of temperature sensor	99	
					Indoor unit control PCB	* Defective indoor unit control PCB (Defective temperature sensor input circuit)?	Replacement of PCB		
E8	1-time flash	Keeps flashing	Stays OFF	Keeps flashing	Indoor return air temperature sensor	• Defective indoor return air temperature sensor (defective element, broken wire, short-circuit) • Poor contact of temperature sensor connector	Replacement, repair of temperature sensor	100	
					Indoor unit control PCB	* Defective indoor unit control PCB (Defective temperature sensor input circuit)?	Replacement of PCB		
E9	1-time flash	Keeps flashing	Stays OFF	Keeps flashing	Installation or operating condition	• Heating over-load (Anomalous high indoor heat exchanger temperature)	Repair	101	
					Indoor heat exchanger temperature sensor	• Defective indoor heat exchanger temperature sensor (short-circuit)	Replacement of temperature sensor		
					Indoor unit control PCB	* Defective indoor unit control PCB (Defective temperature sensor input circuit)?	Replacement of PCB		
E10	Stays OFF	Keeps flashing	Stays OFF	Keeps flashing	Drain trouble	• Defective drain pump (DM), broken drain pump wire, disconnected connector	Replacement, repair of DM	102	
					Float switch	• Anomalous float switch operation (malfunction)	Repair		
E11	Stays OFF	Keeps flashing	Stays OFF	Keeps flashing	Indoor unit control PCB	* Defective indoor unit control PCB (Defective float switch input circuit) * Defective indoor unit control PCB (Defective DM drive output circuit)?	Replacement of PCB	103	
					Option	• Defective option parts (At option anomalous input setting)	Repair		
E14	3-time flash	Keeps flashing	Stays OFF	Keeps flashing	Number of connected indoor units	• When multi-unit control by remote control is performed, the number of units is over	Repair	104	
					Address setting error	• Address setting error of indoor units	Repair		
E16	1(2)-time flash	Keeps flashing	Stays OFF	Keeps flashing	Indoor unit No. setting	*No master is assigned to slaves.	Repair	105	
					Remote control wires	*Anomalous remote control wire connection, broken wire between master and slave units	Replacement, repair		
E18	1-time flash	Keeps flashing	Stays OFF	Keeps flashing	Indoor fan motor	• Defective indoor fan motor	Replacement, repair	106	
					Indoor unit power PCB	• Defective indoor unit power PCB	Replacement		
E19	1-time flash	Keeps flashing	Stays OFF	Keeps flashing	Address setting error	• Address setting error of master and slave indoor units	Repair	107	
					Indoor unit control PCB	• Indoor unit operation check error	Repair		
E20	1(2)-time flash	Keeps flashing	Stays OFF	Keeps flashing	Indoor fan motor	• Indoor motor rotation speed anomaly	Replacement, repair	108	
					Indoor unit power PCB	• Defective indoor unit power PCB	Replacement		
E28	Stays OFF	Keeps flashing	Stays OFF	Keeps flashing	Remote control temperature sensor	• Broken wire of remote control temperature sensor	Repair	109	

Notes (1) Normal indicator lamp (Indoor, outdoor units: Green) extinguishes (or lights continuously) only when CPU is anomalous. It keeps flashing in any trouble other than anomalous CPU.

(2) * mark in the description of trouble means that, in ordinary diagnosis, it cannot identify the cause definitely, and, if the trouble is repaired by replacing the part, it is judged consequently that the replaced part was defective.

2) SRK series

Remote control		Indoor unit display		Outdoor unit control PCB		Location of trouble	Description of trouble	Repair method	Reference page
Error code	Red LED	RUN light	TIMER light	Red LED	Green LED				
No-indication	Stays OFF	ON	Stays OFF	Stays OFF	Keeps flashing	—	•Normal operation	—	—
		—	—	2-time flash	Stays OFF	Indoor unit power source	•Power OFF, broken wire/blown fuse, broken transformer wire	Repair	136
		—	—	Stays OFF	Keeps flashing	Remote control wires	•Poor connection, breakage of remote control wire * For wire breaking at power ON, the LED is OFF.	Repair	137
		—	—	Stays OFF	Keeps flashing	Remote control	• Defective remote control PCB	Replacement of remote control	
Stays OFF	Keeps flashing	Stays OFF	Keeps flashing	Keeps flashing	Limit switch, air inlet panel	•Limit switch operate •Defective limit switch (Poor contact of limit switch connector) •Set is defective air inlet panel	Replacement, repair	138	
					Indoor unit control PCB	•Defective indoor unit control PCB (Defective limit switch input circuit)?	Replacement of PCB		
WAIT or INSPECT I/U	—	—	—	2-time flash	Keeps flashing	Indoor-outdoor units connection wire	• Poor connection, breakage of indoor-outdoor units connection wire	Repair	139–143
						Remote control	• Improper setting of master and slave by remote control		
E1	—	—	—	Stays OFF	Keeps flashing	Remote control wires (Noise)	•Poor connection of remote control signal wire (White) * For wire breaking at power ON, the LED is OFF	Repair	145
						Remote control indoor unit control PCB	* Defective remote control or indoor unit control PCB (defective communication circuit)?		
E5	ON	6-time flash	2-time flash	2-time flash	Keeps flashing	Indoor-outdoor units connection wire	•Poor connection of wire between indoor-outdoor units during operation (disconnection, loose connection) •Anomalous communication between indoor-outdoor units by noise, etc.	Repair	146
		6-time flash	Stays OFF	Keeps flashing	(Noise)	•CPU-runaway on outdoor unit control PCB	Power reset or Repair		
		6-time flash	Stays OFF	Keeps flashing	Outdoor unit control PCB	* Occurrence of defective outdoor unit control PCB on the way of power source (defective communication circuit)?	Replacement of PCB		
E6	Keeps flashing	1-time flash	ON	Stays OFF	6-time flash	Indoor heat exchanger temperature sensor 1	•Defective indoor heat exchanger temperature sensor 1 (defective element, broken wire, short-circuit) • Poor contact of temperature sensor 1 connector	Replacement, repair of temperature sensor 1	147
						Indoor unit control PCB	•Defective indoor unit control PCB (Defective temperature sensor input circuit)?	Replacement of PCB	
No-indication	Keeps flashing	3-time flash	ON	Stays OFF	Keeps flashing	Indoor heat exchanger temperature sensor 2	•Defective indoor heat exchanger temperature sensor 2 (defective element, broken wire, short-circuit) • Poor contact of temperature sensor 2 connector	Replacement, repair of temperature sensor 2	148
						Indoor unit control PCB	•Defective indoor unit control PCB (Defective temperature sensor input circuit)?	Replacement of PCB	
E10	—	—	—	Stays OFF	Keeps flashing	Indoor room temperature sensor	•Defective indoor room temperature sensor(defective element, broken wire, short-circuit) •Poor contact of temperature sensor connector	Replacement, repair of temperature sensor	149
						Indoor unit control PCB	•Defective indoor unit control PCB (Defective temperature sensor input circuit)?	Replacement of PCB	
E14	—	—	—	Stays OFF	Keeps flashing	Number of connected indoor units	•When multi-unit control by remote control is performed, the number of units is over	Repair	150
						Indoor unit No. setting	•No master is assigned to slaves.		
E16	—	—	—	Stays OFF	Keeps flashing	Remote control wires	•Anomalous remote control wire connection, broken wire between master and slave units	Repair	151
						Fan motor	•Defective fan motor	Replacement, repair	
E28	—	—	—	Stays OFF	Keeps flashing	Indoor unit control PCB	•Defective indoor unit control PCB	Replacement	152
						Remote control temperature sensor	• Broken wire of remote control temperature sensor	Repair	

Note (1) *mark in the description of trouble means that, in ordinary diagnosis, it cannot identify the cause definitely, and, if the trouble is repaired by replacing the part, it is judged consequently that the replaced part was defective.

(ii) Outdoor unit
 1) FDT, FDTC, FDU, FDUM, FDE series
 FDC100-140VNX-W, 100-140VSX-W

Remote control		Indoor unit control PCB		Outdoor unit control PCB		Outdoor inverter PCB	Location of trouble	Description of trouble	Repair method	Reference page
Error code	Red LED	Red LED	Green LED (1)	Red LED	Green LED (1)	Yellow LED				
E35		Stays OFF	Keeps flashing	1-time flash	Keeps flashing		Installation or operating condition	• Higher outdoor heat exchanger temperature	Repair	110
							Outdoor heat exchanger temperature sensor	• Defective outdoor heat exchanger temperature sensor	Replacement of temperature sensor	
							Outdoor unit control PCB	*• Defective outdoor unit control PCB (Defective temperature sensor input circuit)?	Replacement of PCB	
E36		Stays OFF	Keeps flashing	1-time flash	Keeps flashing		Installation or operating condition	• Higher discharge temperature	Repair	111
							Discharge pipe temperature sensor	• Defective discharge pipe temperature sensor	Replacement, repair of temperature sensor	
							Outdoor unit control PCB	*• Defective outdoor unit control PCB (Defective temperature sensor input circuit)?	Replacement of PCB	
E37		Stays OFF	Keeps flashing	1-time flash	Keeps flashing	Keeps flashing	Outdoor heat exchanger temperature sensor	• Defective outdoor heat exchanger temperature sensor, broken wire or poor connector connection	Replacement, repair of temperature sensor	112
							Outdoor unit control PCB	*• Defective outdoor unit control PCB (Defective temperature sensor input circuit)?	Replacement of PCB	
E38		Stays OFF	Keeps flashing	1-time flash	Keeps flashing		Outdoor air temperature sensor	• Defective Outdoor air temperature sensor, broken wire or poor connector connection	Replacement, repair of temperature sensor	113
							Outdoor unit control PCB	*• Defective outdoor unit control PCB (Defective temperature sensor input circuit)?	Replacement of PCB	
E39		Stays OFF	Keeps flashing	1-time flash	Keeps flashing		Discharge pipe temperature sensor	• Defective discharge pipe temperature sensor, broken wire or poor connector connection	Replacement, repair of temperature sensor	114
							Outdoor unit control PCB	*• Defective outdoor unit control PCB (Defective temperature sensor input circuit)?	Replacement of PCB	
E40		Stays OFF	Keeps flashing	1-time flash	Keeps flashing		Installation or operating condition	• Rising high pressure (Operation of 63H1) • Service valve closing operation	Repair	115
							Outdoor unit control PCB	*• Defective outdoor unit control PCB (Defective 63H input circuit)?	Replacement of PCB	
E41		Stays OFF	Keeps flashing	1-time flash	Keeps flashing	6-time flash	Inverter PCB or radiator fin	• Power transistor overheat	Replacement of PCB or Repair	116
E42		Stays OFF	Keeps flashing	1-time flash	Keeps flashing	1-time flash	Outdoor unit control PCB compressor	• Current cut (Anomalous compressor over-current)	Replacement of PCB	117•118
							Installation or operating condition	• Service valve closing operation	Repair	
E45		Stays OFF	Keeps flashing	1-time flash	Keeps flashing	Keeps flashing	Outdoor unit control PCB	• Anomalous outdoor unit control PCB communication	Replacement of PCB	119
							Inverter PCB	• Anomalous inverter PCB communication		
E48		Stays OFF	Keeps flashing	1-time flash	Keeps flashing	Keeps flashing	Outdoor fan motor	• Anomalous outdoor fan motor	Replacement, repair	120
							Outdoor unit control PCB	*• Defective outdoor unit control PCB (Defective motor input circuit)?	Replacement of PCB	
E49		Stays OFF	Keeps flashing	1-time flash	Keeps flashing	Keeps flashing	Installation or operating condition	• Low pressure error • Service valve closing operation	Repair	121•122
							Low pressure sensor	• Anomalous low pressure, broken wire of low pressure sensor or poor connector connection	Replacement, repair of sensor	
							Outdoor unit control PCB	*• Defective outdoor unit control PCB (Defective sensor input circuit)?	Replacement of control PCB	
E51		Stays OFF	Keeps flashing	1-time flash	Keeps flashing	6-time flash	Inverter PCB	• Anomalous inverter PCB	Replacement of PCB	123
E53		Stays OFF	Keeps flashing	1-time flash	Keeps flashing	Keeps flashing	Suction pipe temperature sensor	• Defective suction pipe temperature sensor, broken wire or poor connector connection	Replacement, repair of temperature sensor	124
							Outdoor unit control PCB	*• Defective outdoor unit PCB (Defective sensor input circuit)?	Replacement of control PCB	
E54		Stays OFF	Keeps flashing	1-time flash	Keeps flashing	Keeps flashing	Low pressure sensor	• Defective low pressure sensor	Replacement of sensor	125
							Outdoor unit control PCB	• Defective outdoor unit control PCB (Defective sensor input circuit)?	Replacement of control PCB	
E57		Stays OFF	Keeps flashing	1-time flash	Keeps flashing		Operation status	• Shortage in refrigerant quantity	Repair	126
							Installation status	• Service valve closing operation	Service valve opening check	
E59		Stays OFF	Keeps flashing	5 time flash	Keeps flashing	Stays OFF	Compressor inverter PCB	• Anomalous compressor startup	Replacement	127•128

Note (1) * mark in the description of trouble means that, in ordinary diagnosis, it cannot identify the cause definitely, and, if the trouble is repaired by replacing the part, it is judged consequently that the replaced part was defective.

2) SRK series

Remote control		Indoor unit display		Outdoor unit control PCB		Outdoor inverter PCB	Location of trouble	Description of trouble	Repair method	Reference page
Error code	Red LED	RUN light	TIMER light	Red LED	Green LED	Yellow LED				
E35		ON	Keeps flashing	1-time flash	Keeps flashing		Installation or operating condition	• Higher outdoor heat exchanger temperature	Repair	153
							Outdoor heat exchanger temperature thermistor	• Defective outdoor heat exchanger temperature sensor	Replacement of temperature thermistor	
							Outdoor unit control PCB	• Defective outdoor unit control PCB (Defective temperature sensor input circuit)?	Replacement of PCB	
E36		ON	5-time flash	1-time flash	Keeps flashing		Installation or operating condition	• Higher discharge temperature	Repair	154
							temperature sensor	• Defective discharge pipe temperature sensor	Replacement, repair of temperature thermistor	
							Outdoor unit control PCB	• Defective outdoor unit control PCB (Defective temperature sensor input circuit)?	Replacement of PCB	
E37		Keeps flashing	2-time flash	1-time flash	Keeps flashing	Keeps flashing	Outdoor heat exchanger temperature thermistor	• Defective outdoor heat exchanger temperature sensor, broken wire or poor connector connection	Replacement, repair of temperature thermistor	155
							Outdoor unit control PCB	• Defective outdoor unit control PCB (Defective temperature sensor input circuit)?	Replacement of PCB	
E38		Keeps flashing	1-time flash	1-time flash	Keeps flashing		Outdoor air temperature thermistor	• Defective outdoor air temperature sensor broken wire or poor connector connection	Replacement, repair of temperature thermistor	156
							Outdoor unit control PCB	• Defective outdoor unit control PCB (Defective temperature sensor input circuit)?	Replacement of PCB	
E39		Keeps flashing	4-time flash	1-time flash	Keeps flashing		Discharge pipe temperature sensor	• Defective discharge pipe temperature sensor broken wire or poor connector connection	Replacement, repair of temperature thermistor	157
							Outdoor unit control PCB	• Defective outdoor unit control PCB (Defective temperature sensor input circuit)?	Replacement of PCB	
E40		—	—	1-time flash	Keeps flashing		Installation or operating condition	• Rising high pressure (Operation of 63H1) • Service valve closing operation	Repair	158
							Outdoor unit control PCB	• Defective outdoor unit control PCB (Defective 63H input circuit)?	Replacement of PCB	
E41	Keeps flashing	—	—	1-time flash	Keeps flashing	6-time flash	Inverter PCB or radiator fin	• Power transistor overheat	Replacement of PCB or Repair	159
E42		ON	1-time flash	1-time flash	Keeps flashing	1-time flash	Outdoor unit control PCB compressor	• Current cut (Anomalous compressor over-current)	Replacement of PCB	160•161
							Installation or operating condition	• Service valve closing operation	Repair	
E45		—	—	1-time flash	Keeps flashing		Outdoor unit control PCB	• Anomalous outdoor unit control PCB communication	Replacement of PCB	162
							Inverter PCB	• Anomalous inverter PCB communication		
E48		ON	7-time flash	1-time flash	Keeps flashing	Keeps flashing	Outdoor fan motor	• Anomalous outdoor fan motor	Replacement, repair	163
							Outdoor unit control PCB	• Defective outdoor unit control PCB (Defective motor input circuit)?	Replacement of PCB	
E49		—	—	1-time flash	Keeps flashing		Installation or operating condition	• Low pressure error • Service valve closing operation	Repair	164•165
							Low pressure sensor	• Anomalous low pressure, broken wire of low pressure sensor or poor connector connection	Replacement, repair of sensor	
							Outdoor unit control PCB	• Defective outdoor unit control PCB (Defective sensor input circuit)?	Replacement of control PCB	
E51	ON	4-time flash	1-time flash	Keeps flashing	6-time flash	Inverter PCB	• Anomalous inverter PCB	Replacement of PCB	166	
E53	Keeps flashing	5-time flash	1-time flash	Keeps flashing	Keeps flashing	Suction pipe temperature sensor	• Defective suction pipe temperature sensor, broken wire or poor connector connection	Replacement, repair of temperature thermistor	167	
						Outdoor unit control PCB	• Defective outdoor unit PCB (Defective sensor input circuit)?	Replacement of control PCB		
E54	—	—	1-time flash	Keeps flashing	Keeps flashing	Low pressure sensor	• Defective low pressure sensor	Replacement of sensor	168	
						Outdoor unit control PCB	• Defective outdoor unit control PCB (Defective sensor input circuit)?	Replacement of control PCB		
E57	7-time flash	ON	1-time flash	Keeps flashing		Operation status	• Shortage in refrigerant quantity	Repair	169	
						Installation status	• Service valve closing operation	Service valve opening check		
E59	—	—	5-time flash	Keeps flashing	Stays OFF	Compressor, inverter PCB	• Anomalous compressor startup	Replacement	170•171	

Note (1) * mark in the Description of trouble means that, in ordinary diagnosis, it cannot identify the cause definitely, and, if the trouble is repaired by replacing the part, it is judged consequently that the replaced part was defective.

(iii) Option control in-use

1) FDT, FDTC, FDU, FDUM, FDE series

Error code	Indoor unit control PCB			Outdoor unit control PCB		Description of trouble	Repair method
	Red LED	Red LED	Green LED	Red LED	Green LED		
E75	Keeps flashing	Stays OFF	Keeps flashing	Stays OFF	Keeps flashing	• Communication error (Defective communication circuit on the main unit of SC-SL2NA-E or SC-SL4-AE/BE) etc.	Replacement

2) SRK series

Error code	Indoor unit display panel			Outdoor unit control PCB		Description of trouble	Repair method
	Red LED	RUN light	TIMER light	Red LED	Green LED		
E75	Keeps flashing	—	—	Stays OFF	Keeps flashing	• Communication error (Defective communication circuit on the main unit of SL2NA-E or SC-SL4-AE/BE) etc.	Replacement

(iv) Display sequence of error codes or inspection indicator lamps**■ Occurrence of one kind of error**

Displays are shown respectively according to errors.

■ Occurrence of plural kinds of error

Section	Category of display
Error code on remote control	• Displays the error of higher priority (When plural errors are persisting)
Red LED on indoor unit control PCB	<i>E 1 > E 5 > > E 10 > E 32 > > E 60</i>
Red LED on outdoor unit control PCB	• Displays the present errors. (When a new error has occurred after the former error was reset.)

■ Error detecting timing

Section	Error description	Error code	Error detecting timing
Indoor	Drain trouble (Float switch activated)	<i>E 9</i>	Whenever float switch is activated after 30 seconds had past since power ON.
	Communication error at initial operation	“ WAIT ”	No communication between indoor and outdoor units is established at initial operation.
	Remote control communication circuit error	<i>E 1</i>	Communication between indoor unit and remote control is interrupted for more than 2 minutes continuously after initial communication was established.
	Communication error during operation	<i>E 5</i>	Communication between indoor and outdoor units is interrupted for more than 2 minutes continuously after initial communication was established.
	Excessive number of connected indoor units by controlling with one remote control	<i>E 10</i>	Whenever excessively connected indoor units is detected after power ON.
	Return air temperature sensor anomaly	<i>E 7</i>	-50°C or lower is detected for 5 seconds continuously within 60 minutes after initial detection of this anomalous temperature.
	Indoor heat exchanger temperature sensor anomaly	<i>E 6</i>	-50°C or lower is detected for 5 seconds continuously within 60 minutes after initial detection of this anomalous temperature. Or 70°C or higher is detected for 5 seconds continuously
Outdoor	Outdoor air temperature sensor anomaly	<i>E 38</i>	-45°C or lower is detected for 5 seconds continuously 3 times within 40 minutes after initial detection of this anomalous temperature. Or -45°C or lower is detected for 5 seconds continuously within 20 seconds after compressor ON.
	Outdoor heat exchanger temperature sensor anomaly	<i>E 37</i>	-50°C or lower is detected for 5 seconds continuously 3 times within 40 minutes after initial detection of this anomalous temperature. Or -50°C or lower is detected for 5 seconds continuously within 20 seconds after compressor ON.
	Discharge pipe temperature sensor anomaly	<i>E 39</i>	-10°C or lower is detected for 5 seconds continuously 3 times within 40 minutes after initial detection of this anomalous temperature.
	Suction pipe temperature sensor anomaly	<i>E 53</i>	-50°C or lower is detected for 5 seconds continuously 3 times within 40 minutes after initial detection of this anomalous temperature.
	Low pressure sensor anomaly	<i>E 54</i>	0V or lower or 4.0V or higher is detected for 5 seconds continuously 3 times within 40 minutes after initial detection of this anomalous pressure.

■ **Error log and reset**

Error indicator	Memorized error log	Reset
Remote control display	• Higher priority error is memorized.	• Stop the unit by pressing the ON/OFF switch of remote control. • If the unit has recovered from anomaly, it can be operated.
Red LED on indoor unit control PCB	• Not memorized.	
Red LED on outdoor unit control PCB	• Memorizes a mode of higher priority.	

■ **Resetting the error log**

- Resetting the memorized error log in the remote control
Holding down “CHECK” button, press “TIMER” button to reset the error log memorized in the remote control.
- Resetting the memorized error log in the indoor unit
The remote control transmits error log erase command to the indoor unit when “VENTI” button is pressed while holding down “CHECK” button.
Receiving the command, the indoor unit erase the log and answer the status of no error.

(2) **Troubleshooting procedure**

When any trouble has occurred, inspect as follows. Details of respective inspection method will be described on later pages.

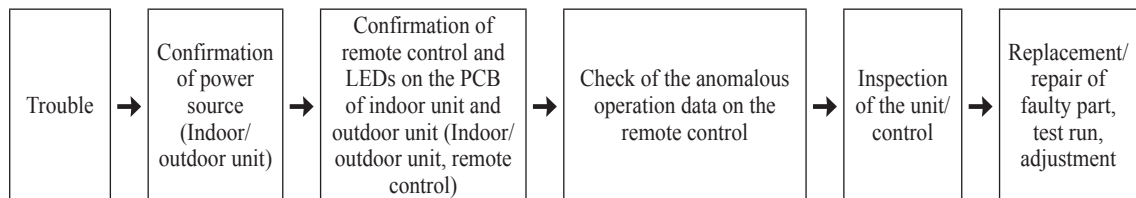

(3) **Troubleshooting at the indoor unit**

(a) **FDT, FDTC, FDU, FDUM, FDE series**

With the troubleshooting, find out any defective part by checking the voltage (AC, DC), resistance, etc. at respective connectors at around the indoor unit PCB, according to the inspection display or operation status of unit (the compressor does not run, fan does not run, the 4-way valve does not switch, etc.), and replace or repair in the unit of following part.

(i) **Replacement part related to indoor unit PCB's**

Control PCB, power source PCB, temperature sensor (return air, indoor heat exchanger), remote control switch, limit switch, transformer and fuse

Note (1) With regard to parts of high voltage circuits and refrigeration cycle, judge it according to ordinary inspection methods.

(ii) **Instruction of how to replace indoor unit control PCB**

SAFETY PRECAUTIONS

- Read the "SAFETY PRECAUTIONS" carefully first of all and then strictly follow it during the replacement in order to protect yourself.
- The precautionary items mentioned below are distinguished into two levels, WARNING and CAUTION.
Both mentions the important items to protect your health and safety so strictly follow them by any means.

WARNING	Wrong installation would cause serious consequences such as injuries or death.
CAUTION	Wrong installation might cause serious consequences depending on circumstances.

- After completing the replacement, do commissioning to confirm there are no anomaly.

WARNING

- Replacement should be performed by the specialist.
If you replace the PCB by yourself, it may lead to serious trouble such as electric shock or fire.
- Replace the PCB correctly according to these instructions.
Improper replacement may cause electric shock or fire.
- Shut off the power before electrical wiring work.
Replacement during the applying the current would cause the electric shock, unit failure or improper running.
It would cause the damage of connected equipment such as fan motor, etc.
- Fasten the wiring to the terminal securely, and hold the cable securely so as not to apply unexpected stress on the terminal.
Loose connections or hold could result in abnormal heat generation or fire.
- Check the connection of wiring to PCB correctly before turning on the power, after replacement.
Defectiveness of replacement may cause electric shock or fire.

CAUTION

- In connecting connector onto the PCB, connect not to deform the PCB. It may cause breakage or malfunction.
- Insert connector securely, and hook stopper. It may cause fire or improper running.
- Bundle the cables together so as not to be pinched or be tensioned. It may cause malfunction or electric shock for disconnection or deformation.

1) Model FDT series

- a) Replace the control PCB
 - i) Unscrew terminal (Arrow A) of the "E1" wiring (yellow/green) that is connected to PCB.
 - ii) Replace the PCB only after all the wirings connected to the connector are removed.
 - iii) Fix the board such that it will not pinch any of the wires.
 - iv) Switch setting must be same setting as that of the removed PCB.
 - v) Reconnect the all wirings to the PCB, that was removed in ii).
 - vi) Rescrew the terminal (Arrow A) of the "E1" wiring, that was removed in i).

- b) Control PCB (※Parts mounting are different by the kind of PCB.)

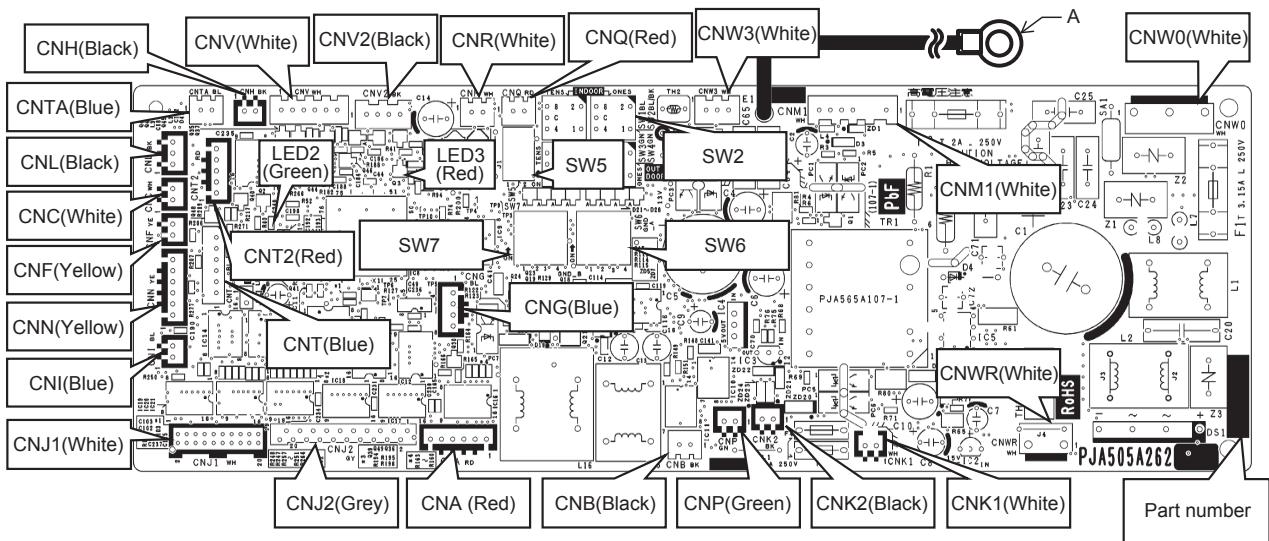

PSC012D050 

2) Model FDTC series

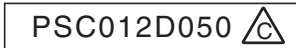

Replace and set up the PCB according to this instruction.

i) Set to an appropriate address and function using switch on PCB.

Select the same setting with the removed PCB.

Item	Switch	Content of control			
Address	SW2	Plural indoor units control by 1 remote control			
Master / Slave setting	SW5-1	Master	Slave 1	Slave 2	Slave 3
	SW5-2	—	—	○	○
Test run	SW7-1	—	○	—	○
		○	Normal		
		○	Operation check/drain pump motor test run		

○:ON —:OFF

ii) Set to an appropriate capacity using the model selector switch(SW6).

Select the same capacity with the PCB removed from the unit.

SW6	-1	-2	-3	-4
50VH	○	—	○	—
60VH	○	○	○	—

SW6

Example setting for 50VH

iii) Replace the PCB

- ① Unscrew terminal (Arrow A) of the "E1" wiring (yellow/green) that is connected to PCB.
- ② Replace the PCB only after all the wirings connected to the connector are removed.
- ③ Fix the board such that it will not pinch any of the wires.
- ④ Switch setting must be same setting as that of the removed PCB.
- ⑤ Reconnect the wirings to the PCB. Wiring connector color should match with the color of connector of the PCB.
- ⑥ Screw back the terminal(Arrow A) of the "E1" wiring, that was removed in ①.

iv) Control PCB

Parts mounting are different by the kind of PCB.

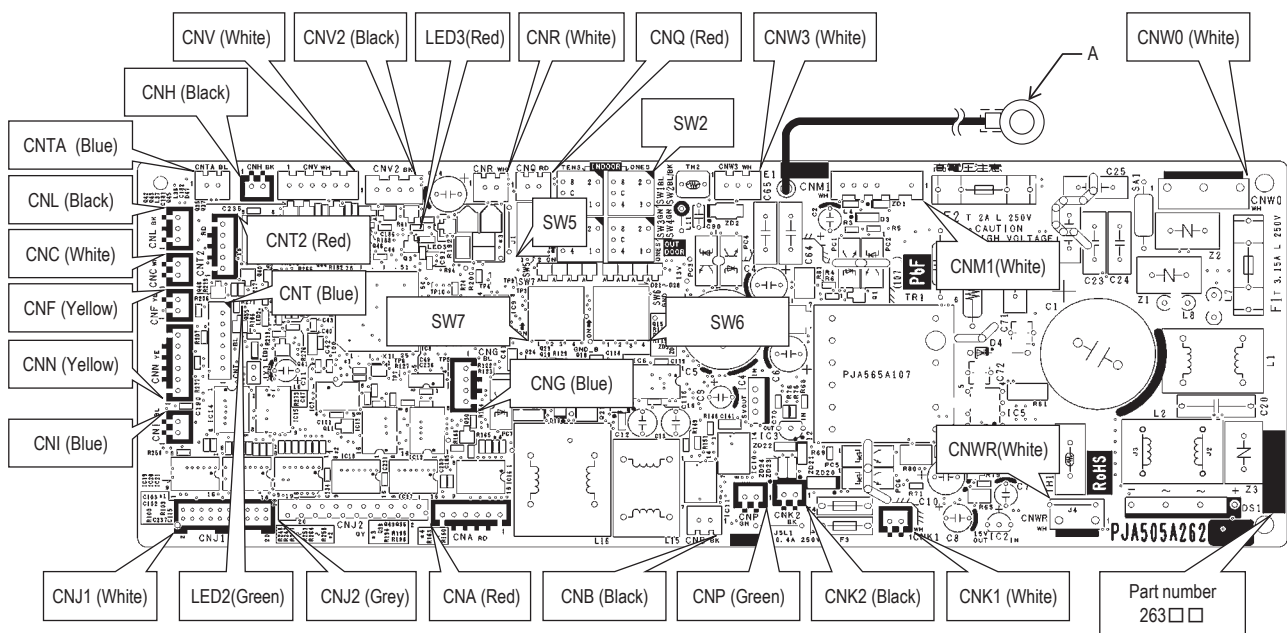

3) Models FDU, FDUM, FDE series

a) Control PCB

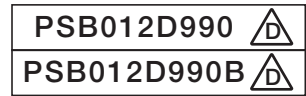

Replace and set up the PCB according to this instruction.

- i) Set to an appropriate address and function using switch on PCB.
Select the same setting with the removed PCB.

Item	Switch	Content of control			
Address	SW2	Plural indoor units control by 1 remote control			
Master /Slave setting		Master	Slave1	Slave2	Slave3
	SW5-1	—	—	○	○
	SW5-2	—	○	—	○
Test run	SW7-1	—	Normal		
		○	Operation check/drain motor test run		

○:ON —:OFF

- ii) Set to an appropriate capacity using the model selector switch(SW6).

Select the same capacity with the PCB removed from the unit.

SW6	-1	-2	-3	-4
50VH	○	—	○	—
60VH	○	○	○	—
71VH	○	—	—	○

SW6	-1	-2	-3	-4
100VH	○	○	—	○
125VH	—	—	○	○
140VH	○	—	○	○

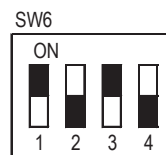

Example setting for 50VH

- iii) Replace the PCB

- ① Exchange PCB after detaching all connectors connected with the PCB.
- ② Fix the PCB so as not to pitch the wiring.
- ③ Connect connectors to the PCB. Match the wiring connector to the connector color on the PCB and connect it.

- iv) Control PCB

Parts mounting are different by the kind of PCB.

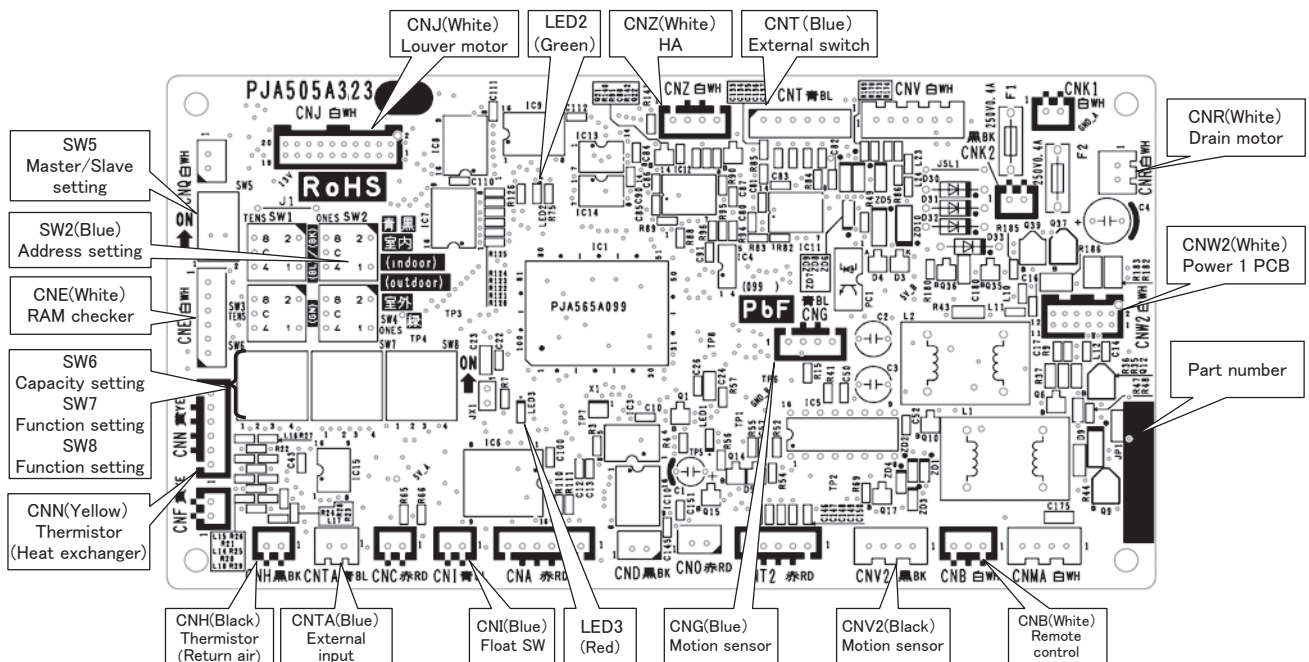

b) Power PCB

This PCB is a general PCB. Replace the PCB according to this instruction.

i) Replace the PCB

- ① Unscrew terminal of the wiring(yellow/green) connected to terminal block (CNWO) from the box.
- ② Replace the PCB only after all the wirings connected to the connector are removed.
- ③ Fix the board such that it will not pinch any of the wires.
- ④ Reconnect the wirings to the PCB. Wiring connector color should match with the color of connector of the PCB.
- ⑤ Screw back the terminal of wiring, that was removed in ①.

ii) Power PCB

Parts mounting are different by the kind of PCB.

• Models FDU100VH, 125VH, 140VH

PSC012D021 

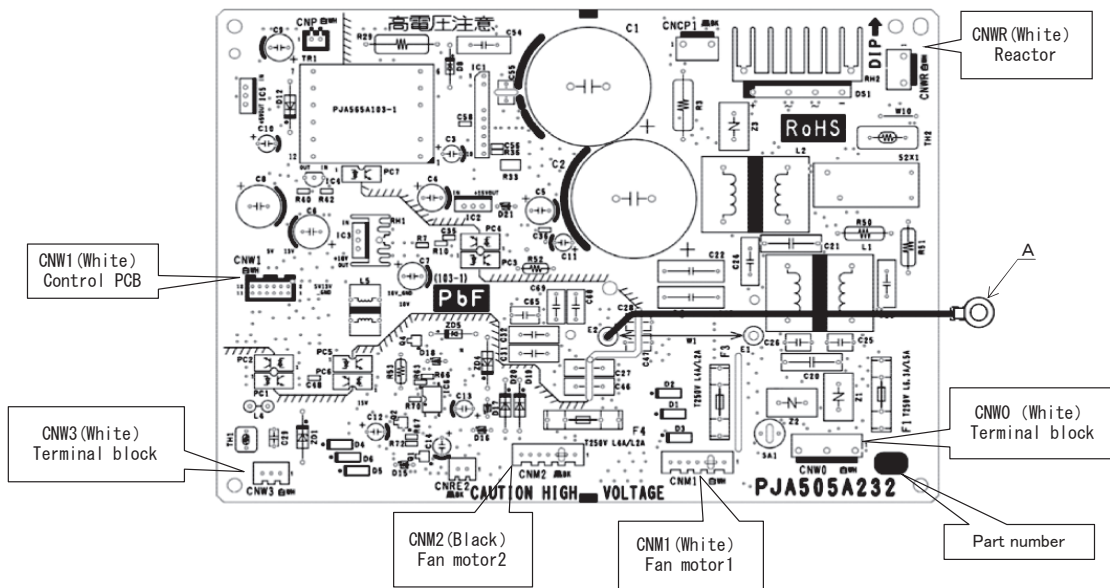

• Models FDUM60VH, 71VH, 100VH, 125VH, 140VH

PSB012D993

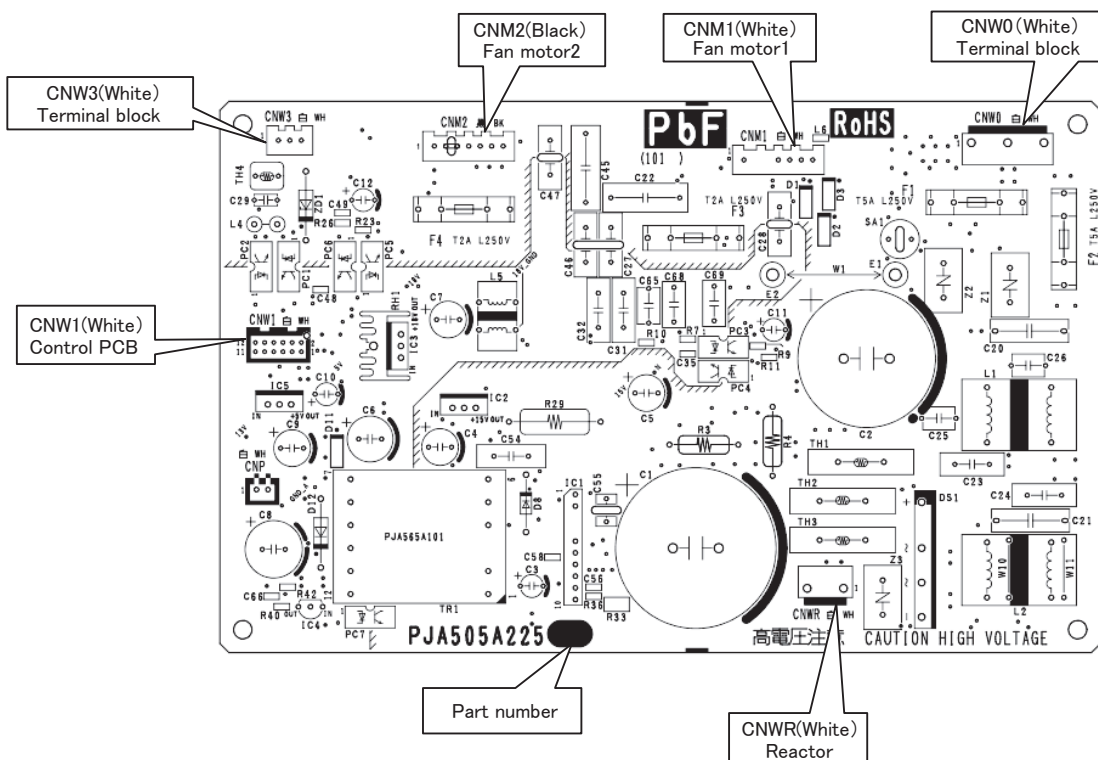

• Models FDE50-140VH, FDUM50VH

PSB012D992 

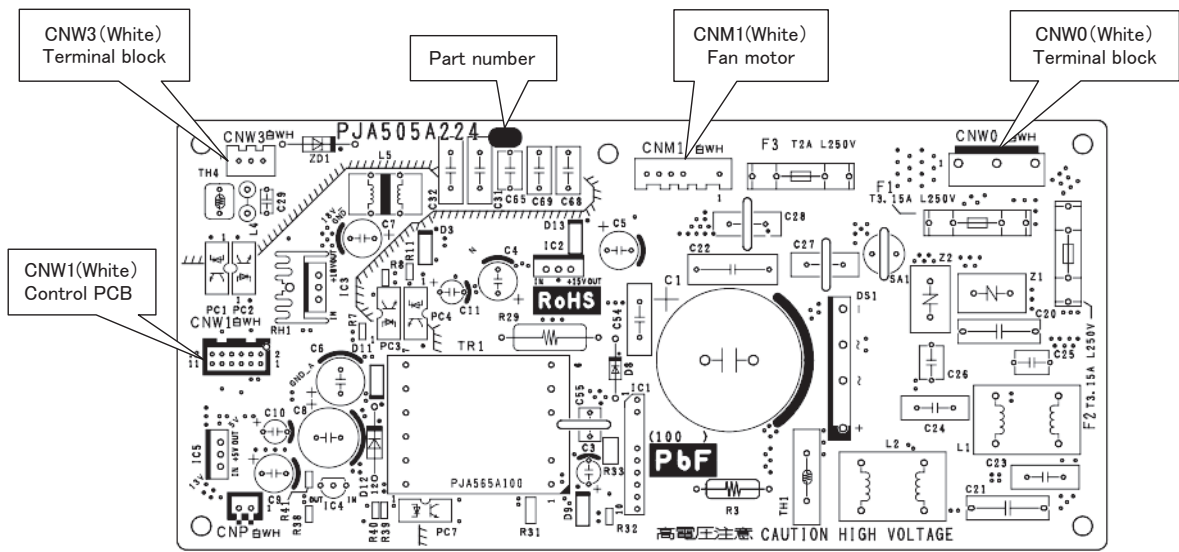

●DIP switch setting list

Switch	Description		Default setting		Remark
SW2	Address No. setting at plural indoor units control by 1 R/C		0		0-F
SW5-1	Master/Slave setting	Master*/Slave	OFF		See table 2.
SW5-2			OFF		
SW6-1	Model selection		As per model		See table 1.
SW6-2					
SW6-3					
SW6-4					
SW7-1	Test run, drain pump motor	Normal*/Test run	OFF	Normal	
SW7-2	Reserved		OFF		Keep OFF
SW7-3	Reserved		OFF		Keep OFF
SW7-4	Reserved		OFF		Keep OFF
SW8-1	Anti-freeze control	Valid/Invalid*	OFF	Invalid	
SW8-2	Reserved		OFF		Keep OFF
SW8-3	Reserved		OFF		Keep OFF
SW8-4	Reserved		OFF		Keep OFF
JSL1	Superlink terminal spare	Normal*/switch to spare	With		

Note(1) : SW8 : FDE only

* Default setting

Table 1: Indoor unit model selection with SW6-1-SW6-4

Switch	50VH	60VH	71VH	100VH	125VH	140VH
SW6-1	ON	ON	ON	ON	OFF	ON
SW6-2	OFF	ON	OFF	ON	OFF	OFF
SW6-3	ON	ON	OFF	OFF	ON	ON
SW6-4	OFF	OFF	ON	ON	ON	ON

Table 2: Indoor unit Master/Slave setting with SW5-1,SW5-2

Switch	SW5-1	SW5-2
Master	OFF	OFF
Slave1	OFF	ON
Slave2	ON	OFF
Slave3	ON	ON

(b) SRK series

(i) Cautions

- 1) If you are disassembling and checking an air-conditioner, be sure to turn off the power before beginning.
When working on indoor units, let the unit sit for about 1 minute after turning off the power before you begin work.
- 2) When taking out printed circuit boards, be sure to do so without exerting force on the circuit boards or package components.
- 3) When disconnecting and connecting connectors, take hold of the connector housing and do not pull on the lead wires.

(ii) Items to check before troubleshooting

- 1) Is the air-conditioner running? Is it displaying any self-diagnosis information?
- 2) Is a power source with the correct voltage connected?
- 3) Are the control lines connecting the indoor and outdoor units wired correctly and connected securely?
- 4) Is the outdoor unit's service valve open?

(iii) Troubleshooting procedure (If the air-conditioner does not run at all)

If the air-conditioner does not run at all, diagnose the trouble using the following troubleshooting procedure.

Important

When all the following conditions are satisfied, we say that the air-conditioner will not run at all.

- 1) The RUN light does not light up.
- 2) The flaps do not open.

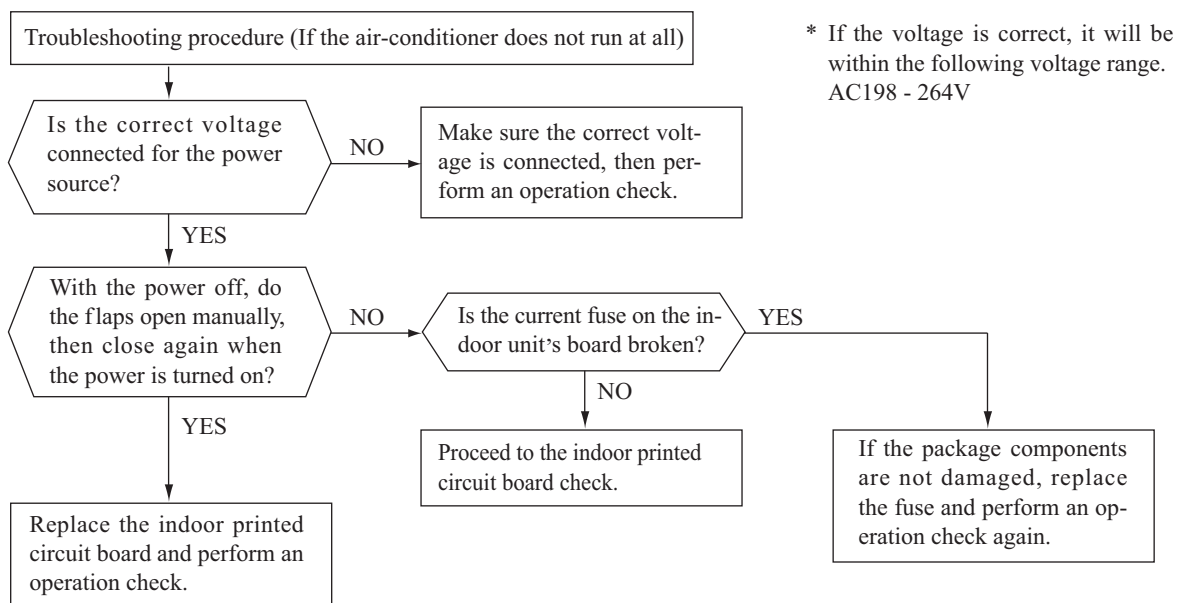

(iv) Inspection procedures corresponding to detail of trouble

Sensor error

[Broken sensor wire, connector poor connection]

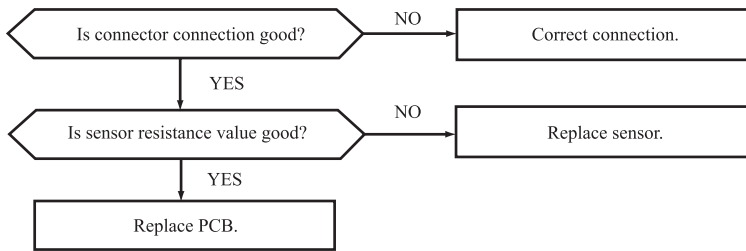

◆ **Sensor temperature characteristics (Room temperature, indoor heat exchanger temperature)**

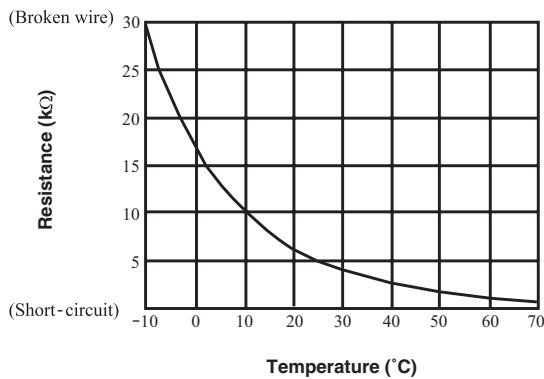

Indoor fan motor error

[Defective fan motor, connector poor connection, defective indoor unit PCB]

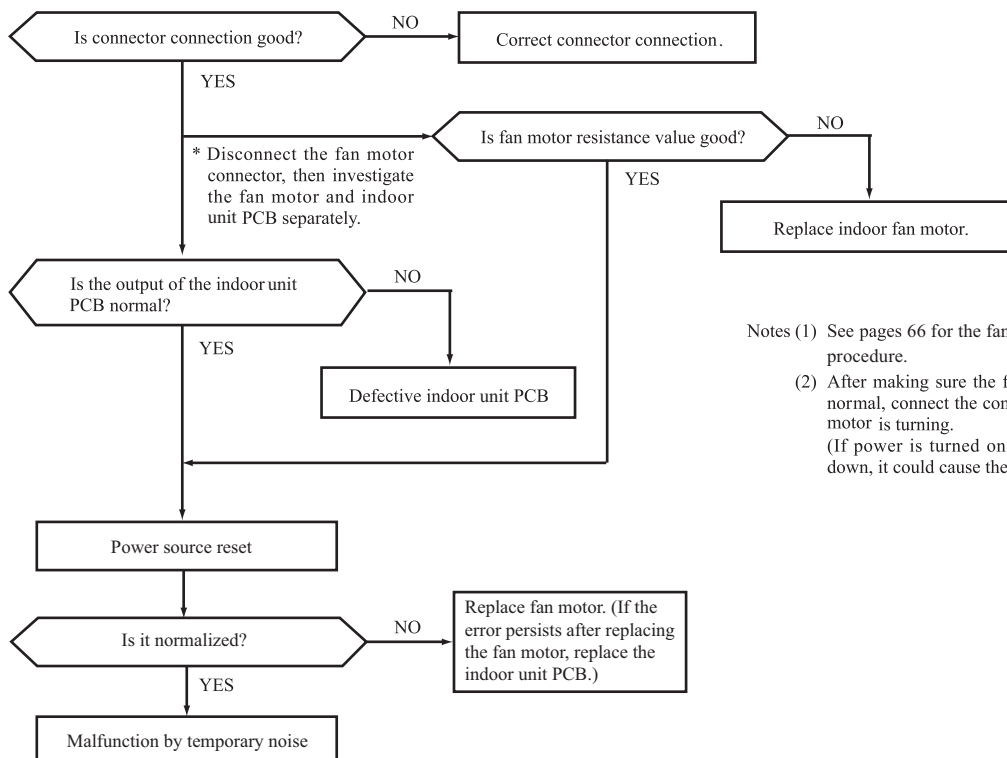

Notes (1) See pages 66 for the fan motor and indoor unit PCB check procedure.
 (2) After making sure the fan motor and indoor unit PCB are normal, connect the connectors and confirm that the fan motor is turning.
 (If power is turned on while one or the other is broken down, it could cause the other to break down also.)

Error of signal transmission

[Wiring error including power cable, defective indoor/
outdoor unit PCB]

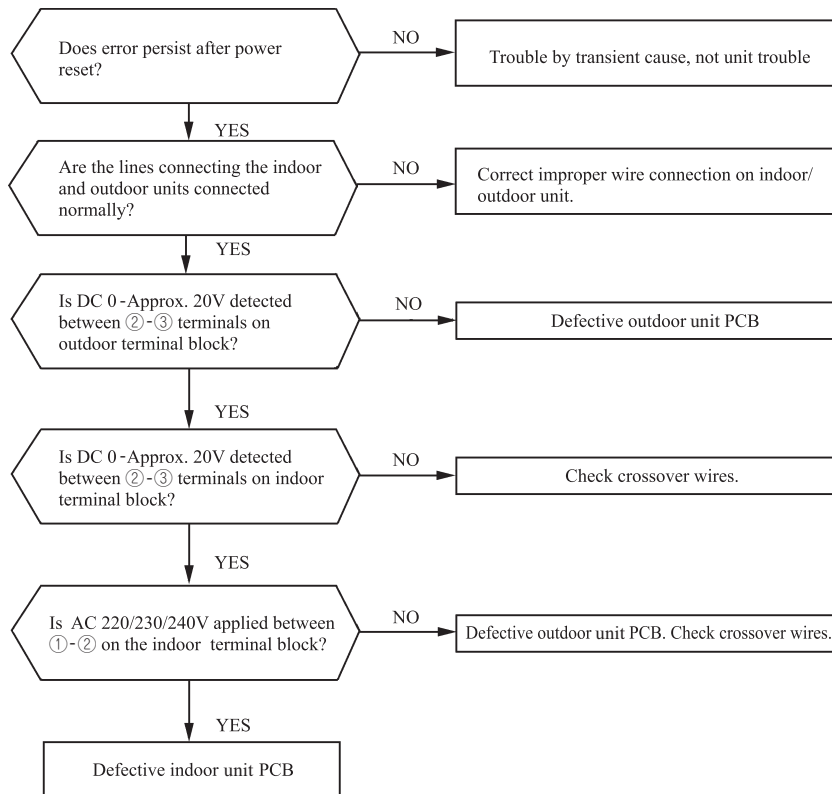

(v) Phenomenon observed after short-circuit, wire breakage on sensor

Sensor	Operation mode	Phenomenon	
		Short-circuit	Disconnected wire
Room temperature sensor	Cooling	Release of continuous compressor operation command.	Continuous compressor operation command is not released.
	Heating	Continuous compressor operation command is not released.	Release of continuous compressor operation command.
Heat exchanger temperature sensor	Cooling	Freezing cycle system protection trips and stops the compressor.	Continuous compressor operation command is not released. (Anti-frosting)
	Heating	High pressure control mode (Compressor stop command)	Hot keep (Indoor fan stop)
Humidity sensor	Cooling	Refer to the table below.	Refer to the table below.
	Heating	Normal system operation is possible.	

■ Humidity sensor operation

Failure mode	Control input circuit reading	Air-conditioning system operation
Disconnected wire	① Disconnected wire	Humidity reading is 0%
	② Disconnected wire	
	①② Disconnected wire	
Short-circuit	① and ② are short-circuited	Humidity reading is 100%

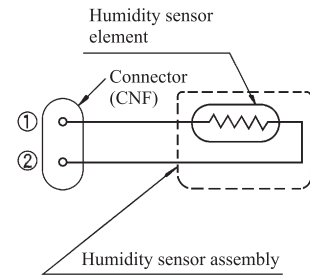

Remark: Do not perform a continuity check of the humidity sensor with a tester. If DC current is applied, it could damage the sensor.

(vi) Checking the indoor electrical equipment

1) Indoor unit PCB check procedure

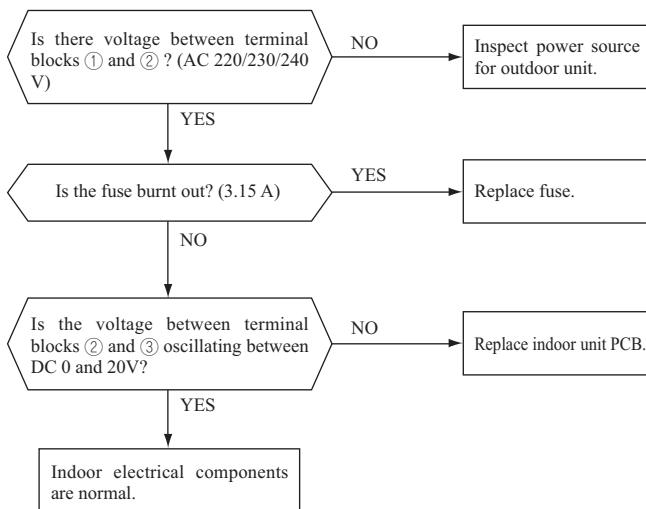

2) Indoor fan motor check procedure

This is a diagnostic procedure for determining if the indoor fan motor or the indoor unit PCB is broken down.

a) Indoor unit PCB output check

- i) Turn off the power.
- ii) Remove the front panel, then disconnect the fan motor lead wire connector.
- iii) Turn on the power. If the unit operates when the ON/OFF button is pressed, if trouble is detected after the voltages in the following figure are output for approximately 30 seconds, it means that the indoor unit PCB is normal and the fan motor is broken down.

If the voltages in the following figure are not output at connector pins No. ①, ④ and ⑤, the indoor unit PCB has failed and the fan motor is normal.

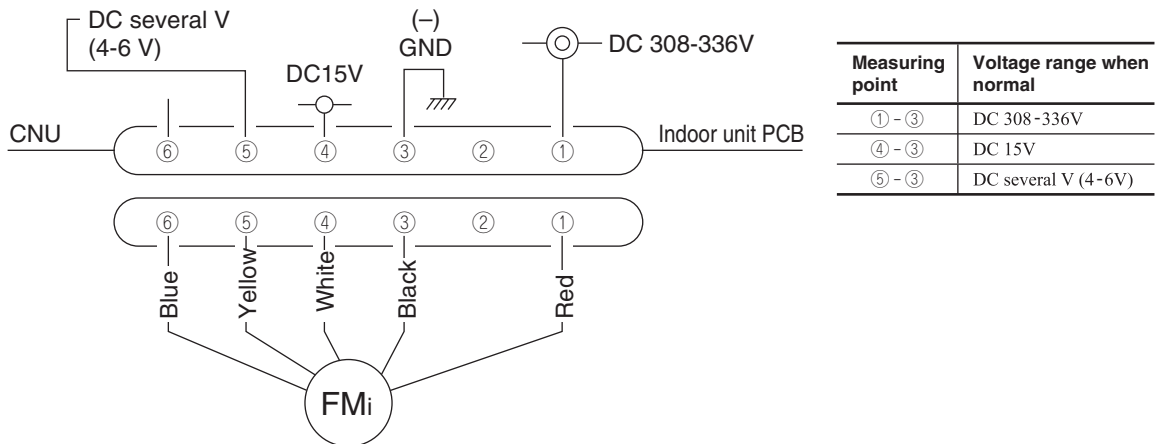

b) Fan motor resistance check

Measuring point	Resistance when normal
① - ③ (Red - Black)	20 MΩ or higher
④ - ③ (White - Black)	20 kΩ or higher

Notes (1) Remove the fan motor and measure it without power connected to it.
 (2) If the measured value is below the value when the motor is normal, it means that the fan motor is faulty.

(vii) Inspection procedure for blown fuse on the indoor unit PCB

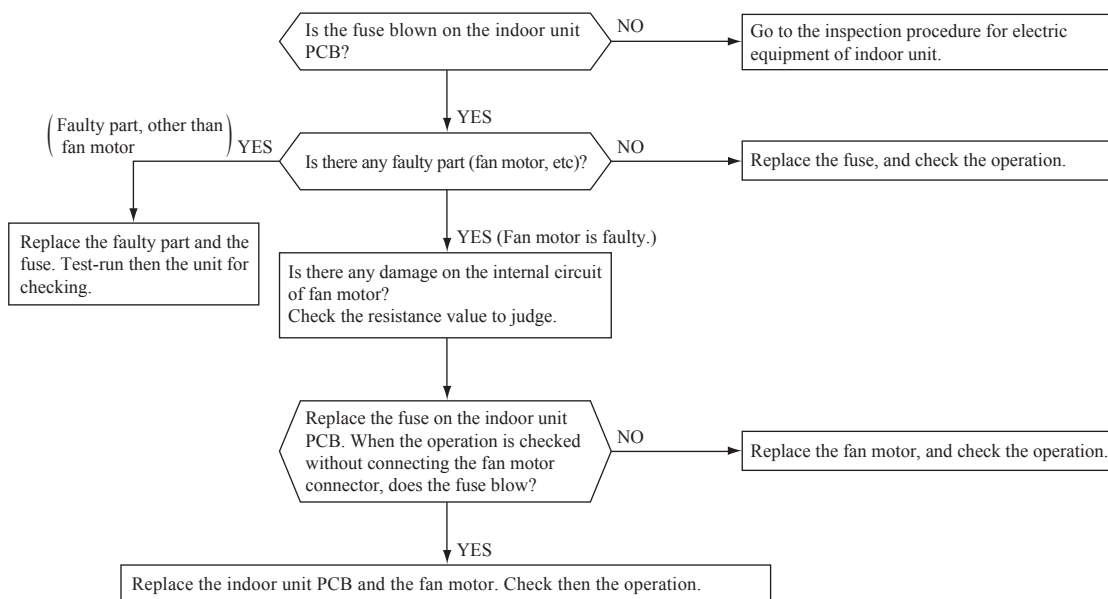

(4) Troubleshooting at the outdoor unit

When troubleshooting the outdoor unit, firstly assess the overview of malfunction and try to presume the cause and the faulty part by checking the error code displayed on the remote control and flashing pattern of indicator lamps (Red LED and Green LED), and then proceed further inspection and remedy it.

Self-diagnosis system by microcomputer on indoor unit and outdoor unit PCB can assist to find the cause of malfunction smoothly by making a diagnosis of not only the anomaly of microcomputer, but also the anomaly in power source system, installation space, overload resulting from improper charging amount of refrigerant and etc.

Unless the power is reset, the error log is saved in memory and the inspection indicator lamps on outdoor unit PCB keep flashing after automatical recovering from malfunction.

After automatical recovering from malfunction, if any another error mode which has a higher priority than the previous error saved in memory occurs, it is overwritten in memory and is displayed.

[Reset of power source]

Be sure to avoid electrical shock, when replacing or checking the outdoor unit control PCB, because some voltage is still retained in the electrolytic capacitor on the PCB even after shutting down the power source to the outdoor unit.

Be sure to start repairing work, after confirming that the red LED or green LED on the PCB has been extinguished for more than 10 seconds after more than 3 minutes had been passed since power shut down, and reconfirming that voltage has been discharged sufficiently by measuring the voltage (DC) between both terminals of electrolytic capacitor (C58) (Measurement of voltage may be disturbed by the moisture-proof coating. In such case, remove the coating and measure it by taking care of avoiding electrical shock.)

(a) Module of part to be replaced for outdoor unit control

Outdoor unit control PCB, Inverter PCB, Temperature sensor (of outdoor heat exchanger, discharge pipe, outdoor air, IPM, suction pipe and under dome), Fuses (for power source and control PCB), Noise filter, Capacitor and Reactor.

(b) Replacement procedure of outdoor unit control PCB

Precautions for Safety	
<ul style="list-style-type: none"> • Since the following precaution is the important contents for safety, be sure to observe them. WARNING and CAUTION are described as follows: 	
<div style="border: 1px solid black; padding: 2px; display: inline-block;"> WARNING</div>	Indicates an imminently hazardous situation which will result in death or serious injury if proper safety procedures and instructions are not adhered to.
<div style="border: 1px solid black; padding: 2px; display: inline-block;"> CAUTION</div>	Indicates a potentially hazardous situation which may result in minor or moderate injury if proper safety procedures and instructions are not adhered to.
WARNING	
<ul style="list-style-type: none"> • Securely replace the PCB according to this procedure. If the PCB is incorrectly replaced, it will cause an electric shock or fire. • Be sure to check that the power source for the outdoor unit is turned OFF before replacing the PCB. The PCB replacement under current-carrying will cause an electric shock or fire. • After finishing the PCB replacement, check that wiring is correctly connected with the PCB before power distribution. If the PCB is incorrectly replaced, it will cause an electric shock or fire. 	
CAUTION	
<ul style="list-style-type: none"> • Band the wiring so as not to tense because it will cause an electric shock. 	



(i) **Models FDC100VNX-W, 125VNX-W, 140VNX-W
FDC100VSX-W, 125VSX-W, 140VSX-W**

- 1) Replace the PCB after elapsing 3 minutes from power OFF.
(**Be sure to measure voltage (DC)** on both capacitor terminals located in control back, and **check that the voltage is discharged sufficiently.**)
- 2) Disconnect the connectors from the control PCB.
- 3) Disconnect the white wiring passing through CT1 on the PCB before replacing the PCB.
- 4) Match the setting switches (SW3-5, JSW) with the former PCB.
- 5) Tighten up a screw after passing white wiring through CT1 of the changed.
- 6) Connect the connectors with the control PCB referring to the parts arrangement of Fig.1.
(Confirm the **connectors are not half inserted.**)

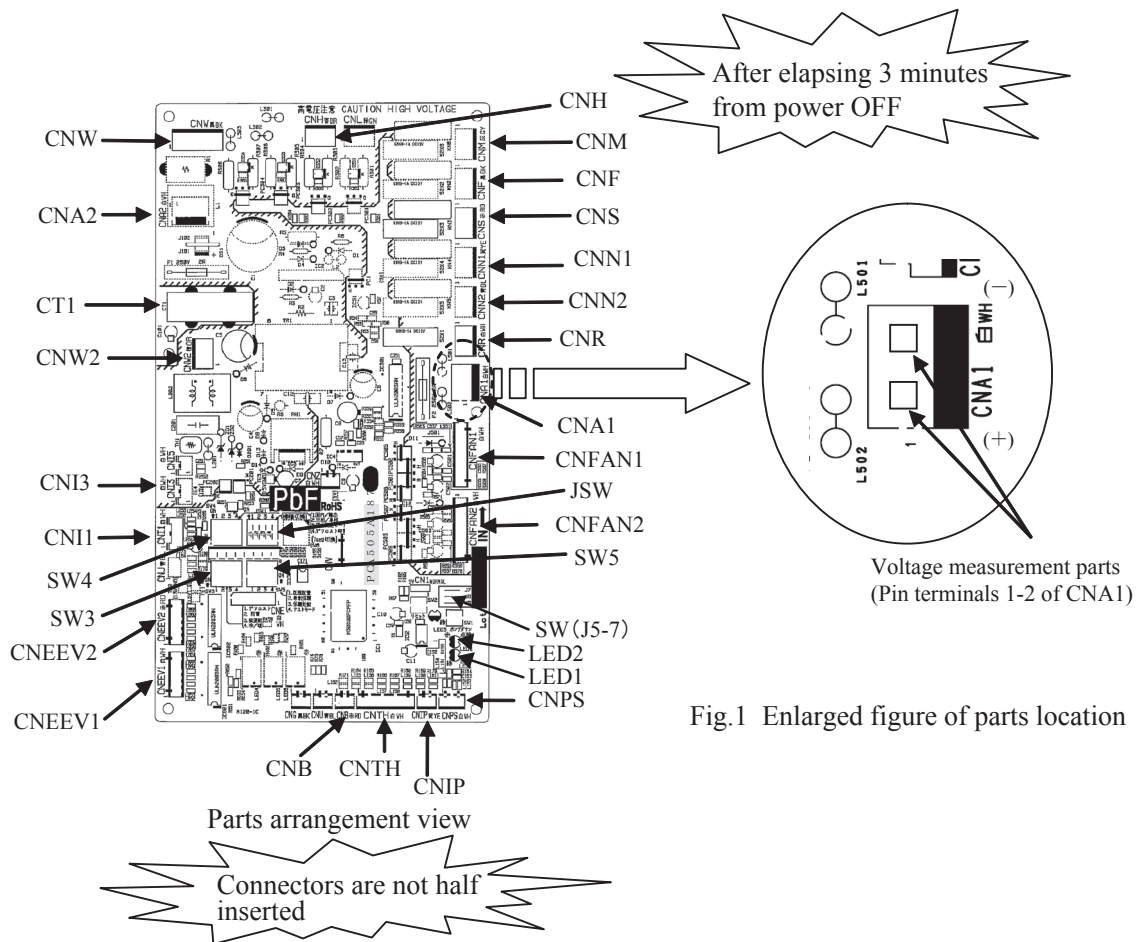

Fig.1 Enlarged figure of parts location

(c) Outdoor inverter PCB replacement procedure

Precautions for Safety

- Since the following precaution is the important contents for safety, be sure to observe them.
WARNING and CAUTION are described as follows:

WARNING

CAUTION

Indicates an imminently hazardous situation which will result in death or serious injury if proper safety procedures and instructions are not adhered to.

Indicates a potentially hazardous situation which may result in minor or moderate injury if proper safety procedures and instructions are not adhered to.

WARNING

- Securely replace the PCB according to this procedure.
If the PCB is incorrectly replaced, it will cause an electric shock or fire.
- Be sure to check that the power source for the outdoor unit is turned OFF before replacing the PCB. The PCB replacement under current-carrying will cause an electric shock or fire.
- After finishing the PCB replacement, check that wiring is correctly connected with the PCB before power distribution. If the PCB is incorrectly replaced, it will cause an electric shock or fire.

CAUTION

- Band the wiring so as not to tense because it will cause an electric shock.

Replace the inverter PCB according to the following procedure.

(i) Models FDC100VNX-W, 125VNX-W, 140VNX-W

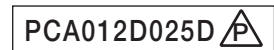

- 1) Replace the PCB **after elapsing 3 minutes from power OFF.**
(Be sure to measure voltage (DC) on both capacitor terminals located in control back, and check that the voltage is discharged sufficiently. (Refer to Fig.1))
- 2) Take off the connection of inverter PCB terminal block connector and remove the screw of power transistor then remove the PCB. Wipe off the silicon grease neatly on the control's radiation heat fins.
- 3) Match the setting switches (JSW10,11) of new PCB with the former PCB.
- 4) Before installing the power transistor on the new PCB, apply uniformly a bundled of silicon grease first on the surface of power transistor. Make sure it is applied to prevent damage on power transistor.
- 5) Tighten the screw of power transistor on inverter PCB and connect the terminal block. Confirm the connection and don't use soldering in the connection. Tighten properly the power transistor with a screw and make sure there is no slack. Power transistor can be damage if not properly tighten. (Recommended power transistor tightening torque: 0.98 – 1.47N·m)

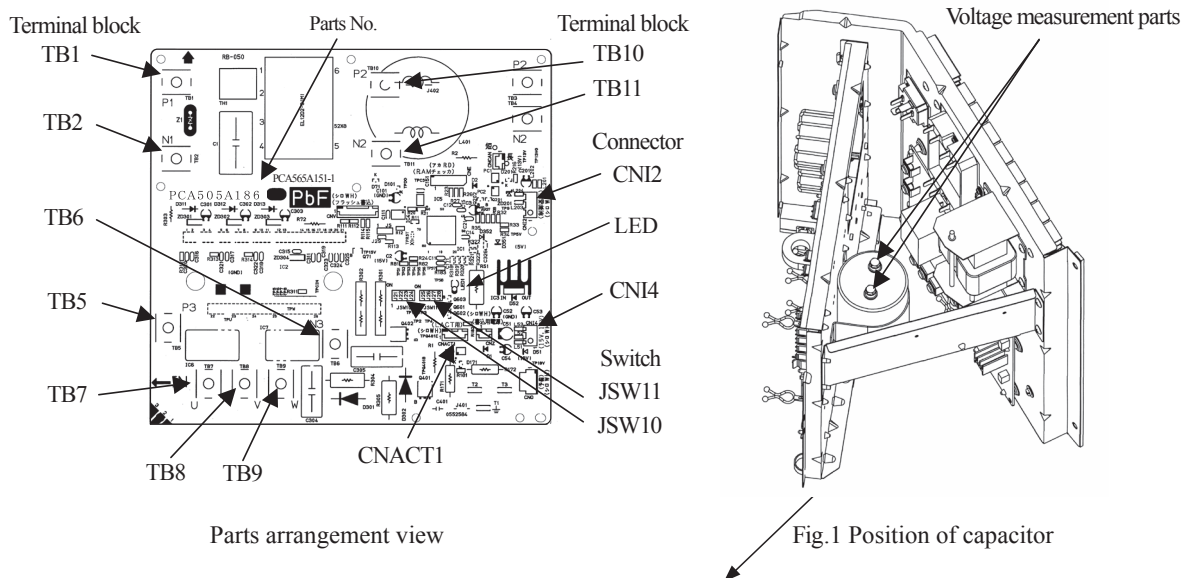
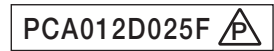

Table. 1 Switch setting
Models FDC100VNX-W, 125VNX-W, 140VNX-W

JSW 10	-1	OFF	JSW 11	-1	OFF
	-2	OFF		-2	OFF
	-3	OFF		-3	ON
	-4	OFF		-4	ON



(ii) Models FDC100VSX-W, 125VSX-W, 140VSX-W

- 1) Replace the PCB **after elapsing 3 minutes from power OFF**.
(**Be sure to measure voltage (DC)** on both capacitor terminals located in control back, and **check that the voltage is discharged sufficiently**.(Refer to Fig.1))
- 2) Take off the connection of inverter PCB terminal block connector and remove the screw of power transistor then remove the PCB. Wipe off the silicon grease neatly on the control's radiation heat fins.
- 3) Match the setting switches (JSW10,11) of new PCB with the former PCB.
- 4) Before installing the power transistor on the new PCB, apply uniformly a bundled of silicon grease first on the surface of power transistor.Make sure it is applied to prevent damage on power transistor.
- 5) Tighten the screw of power transistor on inverter PCB and connect the terminal block.Confirm the connection and don't use soldering in the connection.Tighten properly the power transistor with a screw and make sure there is no slack.Power transistor can be damage if not properly tighten.(Recommended power transistor tightening torque:0.98 – 1.47N·m)

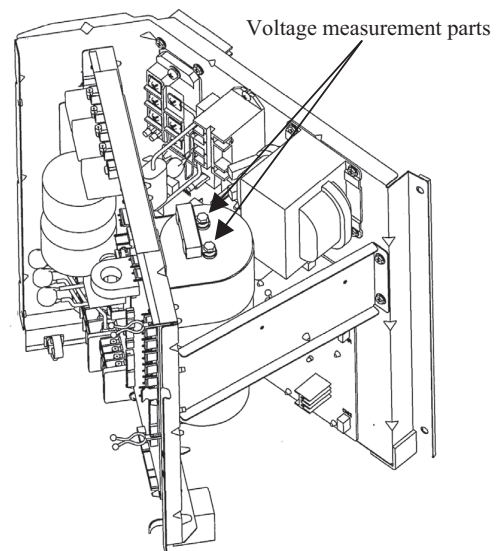
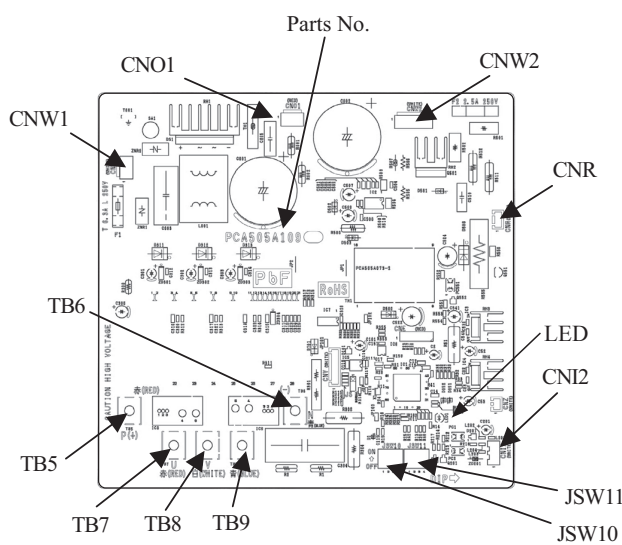

Table. 1 Switch setting
Models FDC100VSX-W, 125VSX-W, 140VSX-W

JSW10	-1	OFF	JSW11	-1	ON
	-2	OFF		-2	OFF
	-3	OFF		-3	ON
	-4	OFF		-4	ON

● DIP switch setting list (Outdoor unit)

Models FDC100, 125, 140VNX-W, 100, 125, 140VSX-W

(1) Control PCB

Switch	Description		Default setting		Remark
SW1	Pump down operation	Normal*/Pump down	OFF	Normal	
JSW 1-1	Model selection		As per model		See table 1
JSW 1-2					
JSW 1-3					
JSW 1-4	Reserved		OFF		Keep OFF
SW 3-1	Defrost condition	Normal*/Cold region	OFF	Normal	
SW 3-2	Snow protection control	Normal*/Snow protection	OFF	Normal	
SW 3-3	Test run switch	Normal*/Test run	OFF	Normal	
SW 3-4	Test run mode	Normal*/Heating	OFF	Cooling	
SW 4-1	Silent mode setting	Normal*/Silent	OFF	Normal	See page 40.
SW4-2	Model setting	3 phase/ Single phase	As per model		See table 1.
SW4-3	Reserved		OFF		Keep OFF
SW4-4	Manual defrost	Normal*/Control activated	OFF	Normal	See page 50.
SW5-1	Control for existing pipnig	Normal*/Control activated	OFF	Normal	See Note 1.
SW5-2	High head-difference control	Normal*/Control activated	OFF	Normal	When the outdoor unit is installed 30m or higher than indoor unit.
SW5-3	Reserved		OFF		Keep OFF
SW5-4	Reserved		OFF		Keep OFF
SW7-1	SW1 function selection		OFF		See table 1.
SW7-2	Limit the number of compressor start	Normal*/Control activated	OFF	Normal	See page 50.
SW7-3	Reserved		OFF		Keep OFF

Table 1: Outdoor unit model setting with JSW1-1-JSW1-3 and SW4-2

	100VNX-W	100VSX-W	125VNX-W	125VSX-W	140VNX-W	140VSX-W
JSW 1-1	OFF	OFF	ON	ON	OFF	OFF
JSW 1-2	OFF	OFF	OFF	OFF	ON	ON
JSW 1-3	OFF	OFF	OFF	OFF	OFF	OFF
SW 4-2	ON	OFF	ON	OFF	ON	OFF

Table 2 : SW1 fuction selection

SW7-1	SW1 function allocation	Remark
OFF	Pump down operation	Refer to page 49.
ON	Reset cumulative time of compressor operation	Reset of cumulative operation time in such case the compressor is replaced.

(2) Inverter PCB

Switch	FDC100, 125, 140VNX-W	FDC100, 125, 140VSX-W
	Single phase models	3 phase models
JSW10-1	OFF	OFF
JSW10-2	OFF	OFF
JSW10-3	OFF	OFF
JSW10-4	OFF *	OFF *
JSW11-1	OFF	ON
JSW11-2	OFF	OFF
JSW11-3	ON	ON
JSW11-4	ON	ON

* When checking inverter PCB of FDC100–140 models with inverter checker, turn JSW10-4 ON.
(Regarding the checking method of inverter PCB with inverter checker, refer to page 70, 71 for details)

(5) Check of anomalous operation data with the remote control

(a) In case of RC-EX3A remote control

[Operating procedure]

① On the TOP screen, touch the buttons in the order of “Menu” → “Service setting” → “Service & Maintenance” → “Service password” → “Set” → “Error display” → “Error history”.

② When only one indoor unit is connected to the remote control, followings will be displayed.

1. When there is any anomaly: “Loading. Wait a while” is displayed, followed by the operation data at the occurrence of anomaly

Contents of display

- Error code
- Number and data item

2. When there is no anomaly: “No anomaly” is displayed, and this mode is terminated.

③ When two or more indoor units are connected to the remote control, followings will be displayed.

1. When there is any anomaly: If the unit having anomaly is selected on the “Select IU” screen, “Loading. Wait a while” is displayed, followed by the operation data at the occurrence of anomaly.

Contents of display

- Indoor unit No.
- Error code
- Number and data item

2. When there is no anomaly: “No anomaly” is displayed, and this mode is terminated.

Note (1) When the number of connected units cannot be shown in a page, select “Next”.

④ If you press [RUN/STOP] button, the display returns to the TOP screen.

◎ **If you touch “Back” button on the way of setting, the display returns to the last precious screen.**

Note (1) When two remote controls are used to control indoor units, the check of anomaly operation data can be made on the master remote control only. (It cannot be operated from the slave remote control.)

■ Anomaly operation data (Corresponding data may not be provided depending on models. Such items will not be displayed.)

Number	Data Item
01	非 (Operation Mode)
02	SET TEMP (Set Temperature)
03	RETURN AIR (Return Air Temperature)
04	SENSOR (Remote Control Temperature Sensor)
05	THI-R1 (Indoor Heat Exchanger Temperature Sensor / U Bend)
06	THI-R2 (Indoor Heat Exchanger Temperature Sensor / Capillary)
07	THI-R3 (Indoor Heat Exchanger Temperature Sensor / Gas Header)
08	I/U FANSPEED (Indoor Unit Fan Speed)
09	DEMAND Hz (Frequency Requirements)
10	ANSWER Hz (Response Frequency)
11	I/U EEV P (Pulse of Indoor Unit Expansion Valve)
12	TOTAL I/U RUN H (Total Running Hours of The Indoor Unit)
13	SUPPLY AIR (Supply Air Temperature)
21	OUTDOOR (Outdoor Air Temperature)
22	THO-R1 (Outdoor Heat Exchanger Temperature Sensor)
23	THO-R2 (Outdoor Heat Exchanger Temperature Sensor)
24	COMP Hz (Compressor Frequency)
25	HP MPa (High Pressure)
26	LP MPa (Low Pressure)
27	Td (Discharge Pipe Temperature)
28	COMP BOTTOM (Comp Bottom Temperature)
29	CT AMP (Current)
30	TARGET SH (Target Super Heat)
31	SH (Super Heat)
32	TDSH (Discharge Pipe Super Heat)
33	PROTECTION No. (Protection State No. of The Compressor)
34	O/U FANSPEED (Outdoor Unit Fan Speed)
35	SH1 (63H1 On/Off)
36	DEFROST (Defrost Control On/Off)
37	TOTAL COMP RUN H (Total Running Hours of The Compressor)
38	O/U EEV1 P (Pulse of The Outdoor Unit Expansion Valve EEVC)
39	O/U EEV2 P (Pulse of The Outdoor Unit Expansion Valve EEVH)

● **Number 33 details of compressor protection status**
Models FDC100, 125, 140VNX-W, 100, 125, 140VSX-W

No.	Contents of display	Reference page
"0"	Normal	
"1"	Discharge pipe temperature protection control	P.45, (6).(a).(i)
"2"	Discharge pipe temperature anomaly	P.45, (6).(a).(ii)
"3"	Current safe control of inverter primary current	P.47, (6).(f)
"4"	High pressure protection control	P.45, (6).(b).(i), P.46, (6).(c).(i)
"5"	High pressure anomaly	P.45, (6).(b).(ii)
"6"	Low pressure protection control	P.46, (6).(e).(i)
"7"	Low pressure anomaly	P.46, (6).(e).(ii)
"8"	Anti-frost prevention control	P.47, (6).(j)
"9"	Current cut	P.47, (6).(f)
"10"	Power transistor protection control	P.47, (6).(g)
"11"	Power transistor anomaly (Overheat)	P.47, (6).(h)
"13"	Spare	
"14"	Dewing prevention control	P.48, (6).(k)
"15"	Current safe control of inverter secondary current	P.47, (6).(f)
"16"	Stop by compressor rotor lock	
"17"	Stop by compressor startup failure	P.48, (6).(o)
"18"	Active filter anomaly	

Note(1) Operation data display on the remote control.

• Data is displayed until canceling the protection control.

• In case of multiple protections controlled, only the younger No. is displayed.

Note(2) Common item.

① In heating mode.

During protection control by the command signal for reducing compressor frequency from indoor unit, No. "4" is displayed.

② In cooling and dehumidifying mode.

During protection control by the command signal for reducing compressor frequency from indoor unit, No. "8" is displayed.

(b) In case of RC-E5 remote control

Operation data can be checked with remote control unit operation.

- ① Press the **CHECK** button.
The display change “ OPER DATA ▼ ”
- ② Press the **(SET)** button while “ OPER DATA ▼ ” is displayed.

- ③ When only one indoor unit is connected to remote control, “ DATA LOADING ” is displayed (blinking indication during data loading).

Next, operation data of the indoor unit will be displayed.
Skip to step ⑦.

- ④ When plural indoor units is connected, the smallest address number of indoor unit among all connected indoor unit is displayed.

[Example]:

“ SELECT I/U ” (blinking 1 seconds) → “ I/U000 ▲ ” blinking.

- ⑤ Select the indoor unit number you would like to have data displayed with the **▲ ▼** button.

- ⑥ Determine the indoor unit number with the **(SET)** button.

(The indoor unit number changes from blinking indication to continuous indication)

“ I/U000 ” (The address of selected indoor unit is blinking for 2 seconds.)



“ DATA LOADING ” (A blinking indication appears while data loaded.)

Next, the operation data of the indoor unit is indicated.

- ⑦ Upon operation of the **▲ ▼** button, the current operation data is displayed in order from data number 01. The items displayed are in the above table.

*Depending on models, the items that do not have corresponding data are not displayed.

- ⑧ To display the data of a different indoor unit, press the **AIR CON No.** button, which allows you to go back to the indoor unit selection screen.

- ⑨ Pressing the **ON/OFF** button will stop displaying data.

Pressing the **(RESET)** button during remote control unit operation will undo your last operation and allow you to go back to the previous screen.

- ⑩ If two (2) remote controls are connected to one (1) inside unit, only the master control is available for trial operation and confirmation of operation data. (The slave remote control is not available.)

●Number 33 details of compressor protection status

Refer to page 73.

Number		Data Item
01		(Operation Mode)
02	SET TEMP	(Set Temperature)
03	RETURN AIR	(Return Air Temperature)
04	SENSOR	(Remote Control Temperature Sensor)
05	THI-R1	(Indoor Heat Exchanger Temperature Sensor / U Bend)
06	THI-R2	(Indoor Heat Exchanger Temperature Sensor /Capillary)
07	THI-R3	(Indoor Heat Exchanger Temperature Sensor /Gas Header)
08	I/U FANSPEED	(Indoor Unit Fan Speed)
09	DEMAND Hz	(Frequency Requirements)
10	ANSWER Hz	(Response Frequency)
11	I/U EEV P	(Pulse of Indoor Unit Expansion Value)
12	TOTAL I/U RUN H	(Total Running Hours of The Indoor Unit)
21	OUTDOOR	(Outdoor Air Temperature)
22	THO-R1	(Outdoor Heat Exchanger Temperature Sensor)
23	THO-R2	(Outdoor Heat Exchanger Temperature Sensor)
24	COMP Hz	(Compressor Frequency)
25	HP MPa	(High Pressure)
26	LP MPa	(Low Pressure)
27	Td	(Discharge Pipe Temperature)
28	COMP BOTTOM	(Compressor Bottom Temperature)
29	CT AMP	(Current)
30	TARGET SH	(Target Super Heat)
31	SH	(Super Heat)
32	TDSH	(Discharge Pipe Super Heat)
33	PROTECTION No.	(Protection State No. of The Compressor)
34	O/U FANSPEED	(Outdoor Unit Fan Speed)
35	63H1	(63H1 On/Off)
36	DEFROST	(Defrost Control On/Off)
37	TOTAL COMP RUN H	(Total Running Hours of The Compressor)
38	O/U EEV1 P	(Pulse of The Outdoor Unit Expansion Valve EEVC)
39	O/U EEV2 P	(Pulse of The Outdoor Unit Expansion Valve EEVH)

(6) Power transistor module (Including the driver PCB) inspection procedure

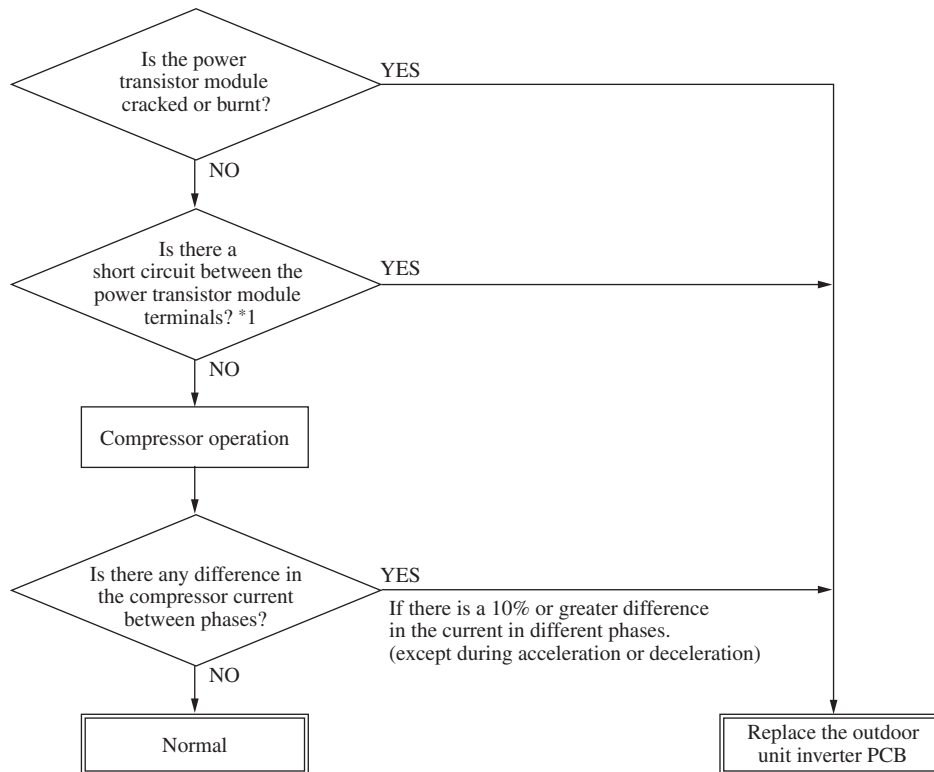

***1 Power transistor module terminal short circuit check procedure**

Disconnect the compressor wiring, then conduct a short circuit check.

P-U, P-V, P-W

N-U, N-V, N-W

Check between the P-N terminals.

Bring the tester probes in contact with the following places on each terminal.

P: Power transistor P terminal

N: Power transistor N terminal

U: End of red harness to compressor

V: End of white harness to compressor

W: End of black or blue harness to compressor

Check for a power transistor short-circuit.

- When you do not have a diagnostic checker for judging if the inverter is defective, measure between the terminal on the inverter PCB, judge whether the power transistor is defective or not.
- Disconnect the compressor, then measure with the control incorporated.

Models FDC100-140VNX-W, 100-140VSX-W

Tester		Normal value (Ω)	
Terminal (+)	Terminal (-)	FDC100-140VNX-W	FDC100-140VSX-W
P	N	Approx. 230 k	Approx. 50 k
N	P	Approx. 570 k	Approx. 525 k
P	U	Approx. 420 k	Approx. 260 k
P	V		
P	W		
N	U	Approx. 250 k	Approx. 215 k
N	V		
N	W		
U	P		Approx. 235 k
V	P		
W	P		
U	N	Approx. 480 k	Approx. 280 k
V	N		
W	N		

If the measured values range from 0 - several kW, there is a possibility that the elements are damaged, so replace the power transistor parts.

(7) Inverter checker for diagnosis of inverter output
Models FDC100, 125, 140VNX-W,100, 125, 140VSX-W

● Checking method

(i) Setup procedure of checker.

- 1) Power OFF (Turn off the breaker).
- 2) Remove the terminal cover of compressor and disconnect the wires (U, V, W) from compressor.
- 3) Connect the wires U (Red) , V (White) and W (Black) of checker to the terminal of disconnected wires (U, V, W) from compressor respectively.

(ii) Operation for judgment.

- 1) Power ON after JSW10-4 on outdoor inverter PCB was turned ON.
- 2) After 15 seconds since power has turned ON, LED start ON/OFF for 5 seconds cyclically and it repeats 10 times.
- 3) Check ON/OFF status of 6 LED's on the checker.
- 4) Judge the PCB by ON/OFF status of 6 LED's on the checker.

ON/OFF status of LED	If all of LED are ON/OFF according to following pattern	If all of LED stay OFF or some of LED are ON/OFF
Inverter PCB	Normal	Anomalous

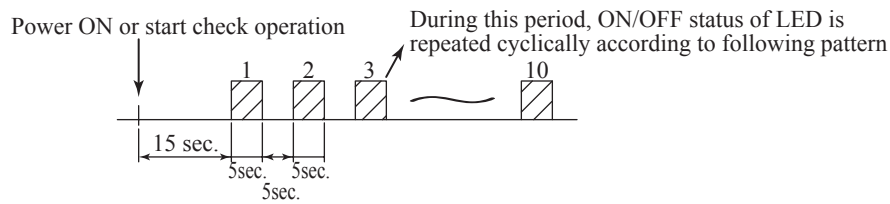

- 5) Be sure to turn off JSW10-4 on outdoor inverter PCB, after finishing the check operation.

<Inverter checker>

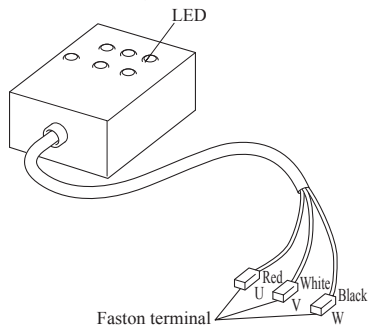

LED ON/OFF pattern

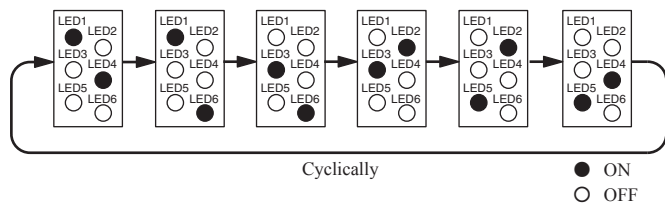

Connect to the terminal of the wires which are disconnected from compressor.

(8) Outdoor unit control failure diagnosis circuit diagram

Models FDC100VNX-W, 125VNX-W, 140VNX-W

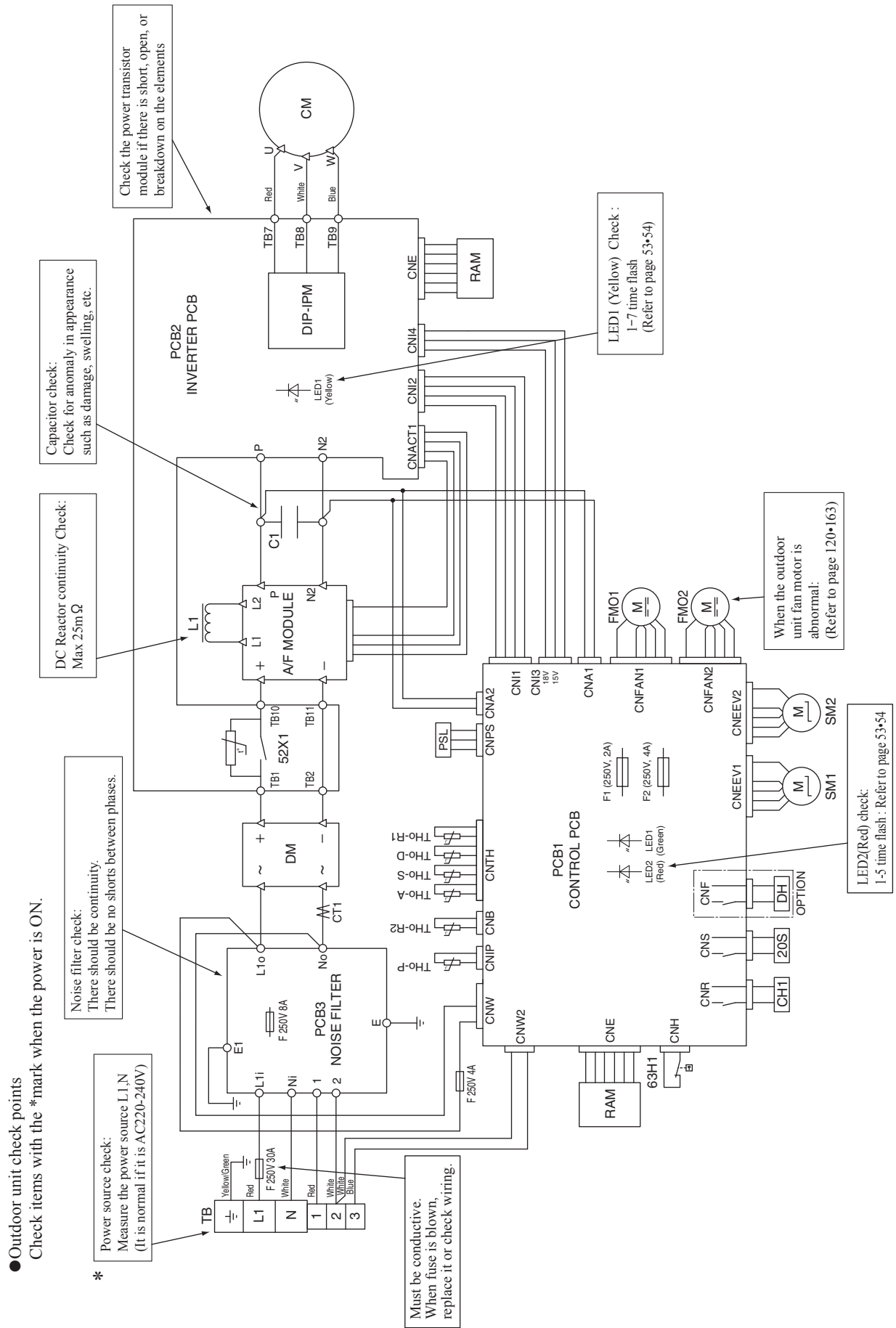

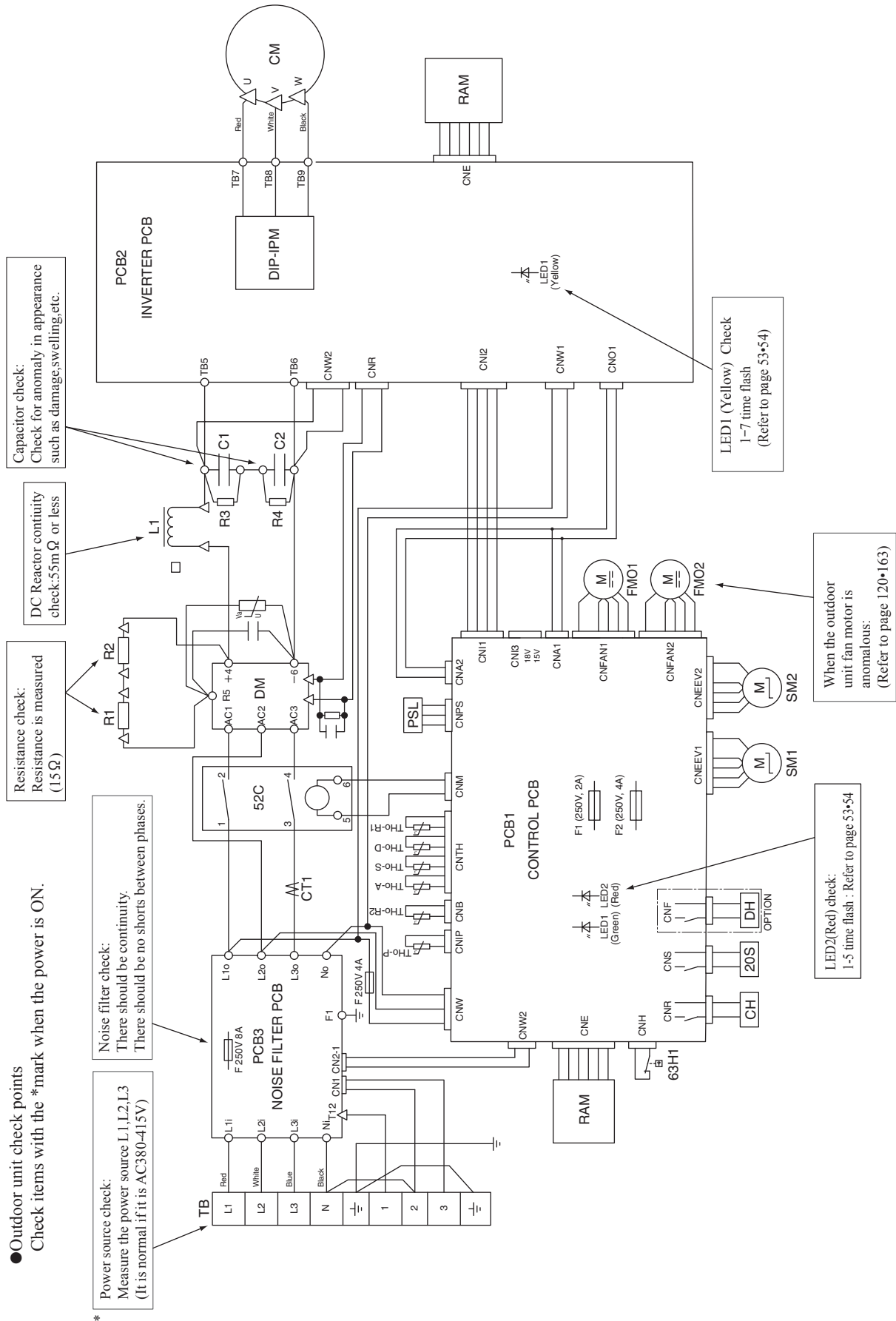

Models FDC100VSX-W, 125VSX-W, 140VSX-W



1.2.2 Troubleshooting flow

(1) List of troubles

(a) FDT, FDTC, FDU, FDUM, FDE series

Remote control display	Description of trouble	Reference page
None	Operates but does not cool	81
None	Operates but does not heat	82
None	Earth leakage breaker activated	83
None	Excessive noise/vibration (1/3)	84
None	Excessive noise/vibration (2/3)	85
None	Excessive noise/vibration (3/3)	86
None	Louver motor failure	87
None	Power source system error (Power source to indoor unit control PCB)	88
None	Power source system error (Power source to remote control)	89
INSPECT I/U	INSPECT I/U (When 1 or 2 remote controls are connected)	90
INSPECT I/U	INSPECT I/U (Connection of 3 units or more remote controls)	91
 WAIT 	Communication error at initial operation	92-94
None	No display	95
E1	Remote control communication circuit error	96
E5	Communication error during operation	97
E6	Indoor heat exchanger temperature sensor anomaly	98
E7	Return air temperature sensor anomaly	99
E8	Heating overload operation	100
E9	Drain trouble	101
E10	Excessive number of connected indoor units (more than 17 units) by controlling with one remote control	102
E11	Address setting error of indoor units	103
E14	Communication error between master and slave indoor units	104
E16	Indoor fan motor anomaly	105
E18	Address setting error of master and slave indoor units	106
E19	Indoor unit operation check, drain pump motor check setting error	107
E20	Indoor fan motor rotation speed anomaly	108
E28	Remote control temperature sensor anomaly	109
E35	Cooling overload operation	110
E36	Discharge pipe temperature error	111
E37	Outdoor heat exchanger temperature sensor anomaly	112
E38	Outdoor air temperature sensor anomaly	113
E39	Discharge pipe temperature sensor anomaly	114
E40	High pressure error (63H1 activated)	115
E41	Power transistor overheat	116
E42	Current cut	117 · 118
E45	Communication error between inverter PCB and outdoor unit control PCB	119
E48	Outdoor fan motor anomaly	120
E49	Low pressure error or low pressure sensor anomaly	121 · 122
E51	Inverter and fan motor anomaly	123
E53	Suction pipe temperature sensor anomaly	124
E54	Low pressure sensor anomaly	125
E57	Insufficient refrigerant amount or detection of service valve closure	126
E59	Compressor startup failure	127 · 128

(b) SRK series

Remote control display	Description of trouble	Reference page
None	Operates but does not cool.	129
None	Operates but does not heat.	130
None	Earth leakage breaker activated	131
None	Excessive noise/vibration (1/3)	132
None	Excessive noise/vibration (2/3)	133
None	Excessive noise/vibration (3/3)	134
None	Louver motor failure	135
None	Power source system error (Power source to indoor control PCB)	136
None	Power source system error (Power source to remote control)	137
None	Limit switch anomaly	138
INSPECT I/U	INSPECT I/U (When 1 or 2 remote controls are connected)	139
INSPECT I/U	INSPECT I/U (Connection of 3 units or more remote controls)	140
 WAIT 	Communication error at initial operation	141 - 143
None	No display	144
E1	Remote control communication circuit error	145
E5	Communication error during operation	146
E6	Indoor heat exchanger temperature sensor anomaly	147
None	Room temperature sensor anomaly	148
E10	Excessive number of connected indoor units (more than 17 units) by controlling with one remote control	149
E14	Communication error between master and slave indoor units	150
E16	Indoor fan motor anomaly	151
E28	Remote control temperature sensor anomaly	152
E35	Cooling overload operation	153
E36	Discharge pipe temperature error	154
E37	Outdoor heat exchanger temperature sensor anomaly	155
E38	Outdoor air temperature sensor anomaly	156
E39	Discharge pipe temperature sensor anomaly	157
E40	High pressure error (63H1 activated)	158
E41	Power transistor overheat	159
E42	Current cut	160 · 161
E45	Communication error between inverter PCB and outdoor control PCB	162
E48	Outdoor fan motor anomaly	163
E49	Low pressure error or low pressure sensor anomaly	164 · 165
E51	Inverter and fan motor anomaly	166
E53	Suction pipe temperature sensor anomaly	167
E54	Low pressure sensor anomaly	168
E57	Insufficient refrigerant amount or detection of service valve closure	169
E59	Compressor startup failure	170 · 171

(2) Troubleshooting

(a) FDT, FDTC, FDU, FDUM, FDE series

Error code Remote control: None	LED	Green	Red	Content Operates but does not cool
	Indoor	Keeps flashing	Stays OFF	
	Outdoor	Keeps flashing	Stays OFF	

<p>1. Applicable model</p>	5. Troubleshooting	
<p>2. Error detection method</p>	Diagnosis	Countermeasure
<p>3. Condition of error displayed</p>	<pre> graph TD Start[Check the indoor fan operation. Check the temperature difference between return and supply air.] --> D1{Is the temperature difference between return and supply air 10-20°C at cooling?} D1 -- YES --> D2{Does the heat load increase after installation?} D1 -- NO --> D3{Is the compressor operating?} D2 -- YES --> Box1[Mistake in model selection. Calculate heat load once more.] D2 -- NO --> C1[It is normal. (This unit is designed to start in the soft start mode by detecting the under dome temperature of compressor when it restart after power reset.)] D3 -- NO --> D4{"⌚ WAIT ⌚" message is displayed (for 3 seconds) when performing cooling, defrost and heating operations from the remote control.} D3 -- YES --> D4 D4 -- YES --> C2[It is necessary to replace to higher capacity one or to install additional unit.] D4 -- NO --> C3[Compressor refrigerant oil protection control at starting is activated. For the contents of control, refer to the compressor start control of the microcomputer control functions.] D4 -- NO --> C4[Compressor may be stopped by the error detection control. For the contents of control, refer to anomalous stop control by controlling compressor rotation speed of microcomputer control functions.] D4 -- NO --> C5[Inspect the followings. • Minor clogging of filter • Minor clogging of heat exchanger • Minor short-circuit • Minor shortage of refrigerant amount • Poor compression of compressor] D5{Is the compressor rotation speed low?} D5 -- NO --> C6[Inspect the followings. • Minor clogging of filter • Minor clogging of heat exchanger • Minor short-circuit • Minor shortage of refrigerant amount • Poor compression of compressor] D5 -- YES --> Box2[Check which control "Determination control of compressor rotation speed" or "Protective control by controlling compressor rotation speed" is appropriate to this phenomenon.] Box2 --> D6{Are the (1) temperature conditions of room and outdoor air close to the rated conditions?} D6 -- YES --> C7[Considering appropriate operation control, check suspicious points. Inspect the followings for reference. • Major clogging of filter • Major clogging of heat exchanger • Major short-circuit • Major shortage of refrigerant amount • Compressor protection ON • Indoor fan tap • Valid setting of silent mode] D6 -- NO --> Box3[The unit is operating normally but is operating under the control for protecting compressor or other respective parts.] Note1[Note (1) Outdoor : 35°C, Indoor : 27°C] </pre>	
<p>4. Presumable cause</p> <ul style="list-style-type: none"> • Poor compression of compressor • Faulty expansion valve operation 		

Note:

Error code Remote control: None	LED	Green	Red	Content Operates but does not heat
	Indoor	Keeps flashing	Stays OFF	
	Outdoor	Keeps flashing	Stays OFF	

1. Applicable model
2. Error detection method
3. Condition of error displayed
4. Presumable cause

- Faulty 4-way valve operation
- Poor compression of compressor
- Faulty expansion valve operation

5. Troubleshooting	
Diagnosis	Countermeasure
<p>Check the indoor fan operation. Check the temperature difference between return and supply air.</p> <p>Is the temperature difference between return and supply air 10-30°C at heating?</p> <p>NO</p> <p>Is the compressor operating?</p> <p>NO</p> <p>“WAIT” message is displayed (for 3 seconds) when performing cooling, defrost and heating operations from the remote control.</p> <p>NO</p> <p>Is the compressor rotation speed low?</p> <p>NO</p> <p>Check which control “Determination control of compressor rotation speed” or “Protective control by controlling compressor rotation speed” is appropriate to this phenomenon.</p> <p>Are the (1) temperature conditions of room and outdoor air close to the rated conditions?</p> <p>NO</p> <p>The unit is operating normally but is operating under the control for protecting compressor or other respective parts.</p>	<p>It is normal. (This unit is designed to start in the soft start mode by detecting the under dome temperature of compressor when it restart after power reset.)</p> <p>It is necessary to replace to higher capacity one or to install additional unit.</p> <p>Compressor refrigerant oil protection control at starting is activated. For the contents of control, refer to the compressor start control of the microcomputer control functions.</p> <p>Compressor may be stopped by the error detection control. For the contents of control, refer to anomalous stop control by controlling compressor rotation speed of microcomputer control functions.</p> <p>Inspect the followings.</p> <ul style="list-style-type: none"> • Minor clogging of filter • Minor clogging of heat exchanger • Minor short-circuit • Minor shortage of refrigerant amount • Poor compression of compressor <p>Considering appropriate operation control, check suspicious points. Inspect the followings for reference.</p> <ul style="list-style-type: none"> • Major clogging of filter • Major clogging of heat exchanger • Major short-circuit • Major shortage of refrigerant amount • Compressor protection ON • Indoor fan tap • Valid setting of silent mode

Note:

Error code Remote control: None	LED	Green	Red	Content Earth leakage breaker activated
	Indoor	Stays OFF	Stays OFF	
	Outdoor	Stays OFF	Stays OFF	

1. Applicable model
2. Error detection method
3. Condition of error displayed
4. Presumable cause
<ul style="list-style-type: none"> • Defective compressor • Noise

5. Troubleshooting	
Diagnosis	Countermeasure
	<p>Replace compressor.*</p> <p>Secure insulation resistance.</p>

Note:

Error code Remote control: None	LED	Green	Red	Content Excessive noise/vibration (1/3)
	Indoor	—	—	
	Outdoor	—	—	

1. Applicable model

2. Error detection method

3. Condition of error displayed

4. Presumable cause
- ① Improper installation work
 - Improper anti-vibration work at installation
 - Insufficient strength of mounting face
 - ② Defective product
 - Before/after shipping from factory
 - ③ Improper adjustment during commissioning
 - Excess/shortage of refrigerant, etc.

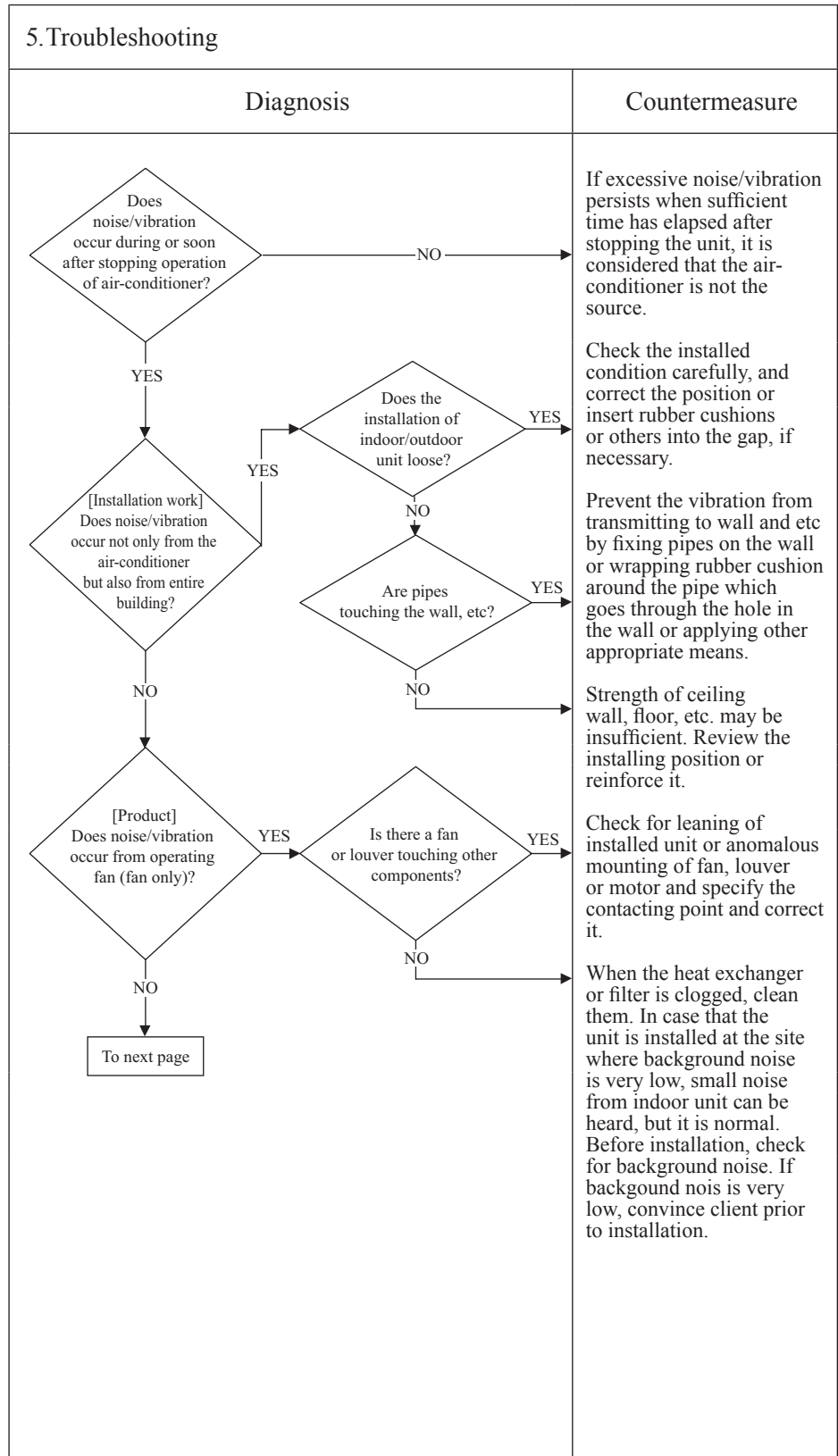

Note:

Error code Remote control: None	LED	Green	Red	Content Excessive noise/vibration (2/3)
	Indoor	-	-	
	Outdoor	-	-	

1. Applicable model
2. Error detection method
3. Condition of error displayed
4. Presumable cause

5. Troubleshooting	
Diagnosis	Countermeasure
	<p>Rearrange the piping to avoid contact with the casing.</p> <p>It is noise/vibration that is generated when the refrigerant gas or liquid flow through inside of piping of air-conditioner. It is likely to occur particularly during cooling or defrost operation in the heating mode. It is normal.</p> <p>The noise/vibration occurs when the refrigerant starts or stops flowing. It is normal.</p> <p>When the defrost operation starts or stops during heating, the refrigerant flow is reversed due to switching 4-way valve. This causes a large change in pressure which produces a blowing sound. It may accompany also the hissing sounds as mentioned above. They are normal.</p> <p>After the start or stop of heating operation or during defrost operation, abrupt changes in temperature cause resin parts to shrink or expand. This is normal.</p> <p>It is the sound produced by the drain pump that discharges drain from the indoor unit. The pump continues to run for 5 minutes after stopping the cooling operation. This is normal.</p> <p>Apply the damper sealant at places considered to be the sources such as the pressure reducing mechanism (expansion valve), capillary, etc.</p>

Note:

Error code Remote control: None	LED	Green	Red	Content Excessive noise/vibration (3/3)
	Indoor	—	—	
	Outdoor	—	—	

<p>1. Applicable model</p> <p>2. Error detection method</p> <p>3. Condition of error displayed</p> <p>4. Presumable cause</p> 	<p>5. Troubleshooting</p> <table border="1" style="width: 100%;"> <thead> <tr> <th style="width: 50%;">Diagnosis</th> <th style="width: 50%;">Countermeasure</th> </tr> </thead> <tbody> <tr> <td style="text-align: center;"> <div style="border: 1px solid black; padding: 5px; width: fit-content; margin: 0 auto;">From previous page</div> <p style="text-align: center;">↓</p> <div style="border: 1px solid black; padding: 10px; width: fit-content; margin: 0 auto;"> <p style="text-align: center;">[Adjustment during commissioning]</p> <p style="text-align: center;">Does noise/vibration occur when the cooling/heating operation is in anomalous condition?</p> </div> <p style="text-align: center;">↓</p> <p style="text-align: center;">YES →</p> </td> <td> <p>If insufficient cooling/heating problem happens due to anomalous operating conditions at cooling/heating, followings are suspicious.</p> <ul style="list-style-type: none"> • Overcharge of refrigerant • Insufficient charge of refrigerant • Intrusion of air, nitrogen, etc. <p>In such occasion, it is necessary to recover refrigerant, vacuum-dry and recharge refrigerant.</p> <p>* Since there could be many causes of noise/vibration, the above do not cover all. In such case, check the conditions when, where, how the noise/vibration occurs according to following check point.</p> <ul style="list-style-type: none"> • Indoor/outdoor unit • Cooling/heating/fan mode • Startup/stop/during operation • Operating condition (Indoor/outdoor air temperatures, pressure) • Time it occurred • Operation data retained by the remote control such as compressor rotation speed, heat exchanger temperature, EEV opening degree, etc. • Tone (If available, record the noise) • Any other anomalies </td> </tr> </tbody> </table>	Diagnosis	Countermeasure	<div style="border: 1px solid black; padding: 5px; width: fit-content; margin: 0 auto;">From previous page</div> <p style="text-align: center;">↓</p> <div style="border: 1px solid black; padding: 10px; width: fit-content; margin: 0 auto;"> <p style="text-align: center;">[Adjustment during commissioning]</p> <p style="text-align: center;">Does noise/vibration occur when the cooling/heating operation is in anomalous condition?</p> </div> <p style="text-align: center;">↓</p> <p style="text-align: center;">YES →</p>	<p>If insufficient cooling/heating problem happens due to anomalous operating conditions at cooling/heating, followings are suspicious.</p> <ul style="list-style-type: none"> • Overcharge of refrigerant • Insufficient charge of refrigerant • Intrusion of air, nitrogen, etc. <p>In such occasion, it is necessary to recover refrigerant, vacuum-dry and recharge refrigerant.</p> <p>* Since there could be many causes of noise/vibration, the above do not cover all. In such case, check the conditions when, where, how the noise/vibration occurs according to following check point.</p> <ul style="list-style-type: none"> • Indoor/outdoor unit • Cooling/heating/fan mode • Startup/stop/during operation • Operating condition (Indoor/outdoor air temperatures, pressure) • Time it occurred • Operation data retained by the remote control such as compressor rotation speed, heat exchanger temperature, EEV opening degree, etc. • Tone (If available, record the noise) • Any other anomalies
Diagnosis	Countermeasure				
<div style="border: 1px solid black; padding: 5px; width: fit-content; margin: 0 auto;">From previous page</div> <p style="text-align: center;">↓</p> <div style="border: 1px solid black; padding: 10px; width: fit-content; margin: 0 auto;"> <p style="text-align: center;">[Adjustment during commissioning]</p> <p style="text-align: center;">Does noise/vibration occur when the cooling/heating operation is in anomalous condition?</p> </div> <p style="text-align: center;">↓</p> <p style="text-align: center;">YES →</p>	<p>If insufficient cooling/heating problem happens due to anomalous operating conditions at cooling/heating, followings are suspicious.</p> <ul style="list-style-type: none"> • Overcharge of refrigerant • Insufficient charge of refrigerant • Intrusion of air, nitrogen, etc. <p>In such occasion, it is necessary to recover refrigerant, vacuum-dry and recharge refrigerant.</p> <p>* Since there could be many causes of noise/vibration, the above do not cover all. In such case, check the conditions when, where, how the noise/vibration occurs according to following check point.</p> <ul style="list-style-type: none"> • Indoor/outdoor unit • Cooling/heating/fan mode • Startup/stop/during operation • Operating condition (Indoor/outdoor air temperatures, pressure) • Time it occurred • Operation data retained by the remote control such as compressor rotation speed, heat exchanger temperature, EEV opening degree, etc. • Tone (If available, record the noise) • Any other anomalies 				

Note:

Error code Remote control: None	LED	Green	Red	Content Louver motor failure
	Indoor	Keeps flashing	Stays OFF	
	Outdoor	Keeps flashing	Stays OFF	

1. Applicable model
FDT, FDTC, FDE series

2. Error detection method

3. Condition of error displayed

4. Presumable cause

- Defective LM
- LM wire breakage
- Faulty indoor unit control PCB

5. Troubleshooting

Diagnosis	Countermeasure
<p>▲ Check at the indoor unit side.</p> <pre> graph TD Start[Operate after waiting for more than 1 minute.] --> Q1{Does the louver operate at the power on?} Q1 -- NO --> Q2{Is LM wiring broken?} Q2 -- YES --> C1[Repair wiring.] Q2 -- NO --> Q3{Is LM locked?} Q3 -- YES --> C2[Replace LM.] Q3 -- NO --> C3[Defective indoor unit control PCB → Replace.] Q1 -- YES --> Q4{Is the louver operable with the remote control?} Q4 -- YES --> C4[Normal] Q4 -- NO --> C5[Adjust LM lever and then check again.] </pre> <p>LM: louver motor</p>	<p>Repair wiring.</p> <p>Replace LM.</p> <p>Defective indoor unit control PCB → Replace.</p> <p>Normal</p> <p>Adjust LM lever and then check again.</p>

Note:

Error code Remote control: None	LED	Green	Red	Content Power source system error (Power source to indoor unit control PCB)
	Indoor	Stays OFF	Stays OFF	
	Outdoor	Keeps flashing	2-time flash	

1. Applicable model

2. Error detection method

3. Condition of error displayed

4. Presumable cause
- Misconnection or breakage of connecting wires
 - Blown fuse
 - Faulty transformer
 - Faulty indoor unit control PCB
 - Broken harness
 - Faulty outdoor unit control PCB (Noise filter)

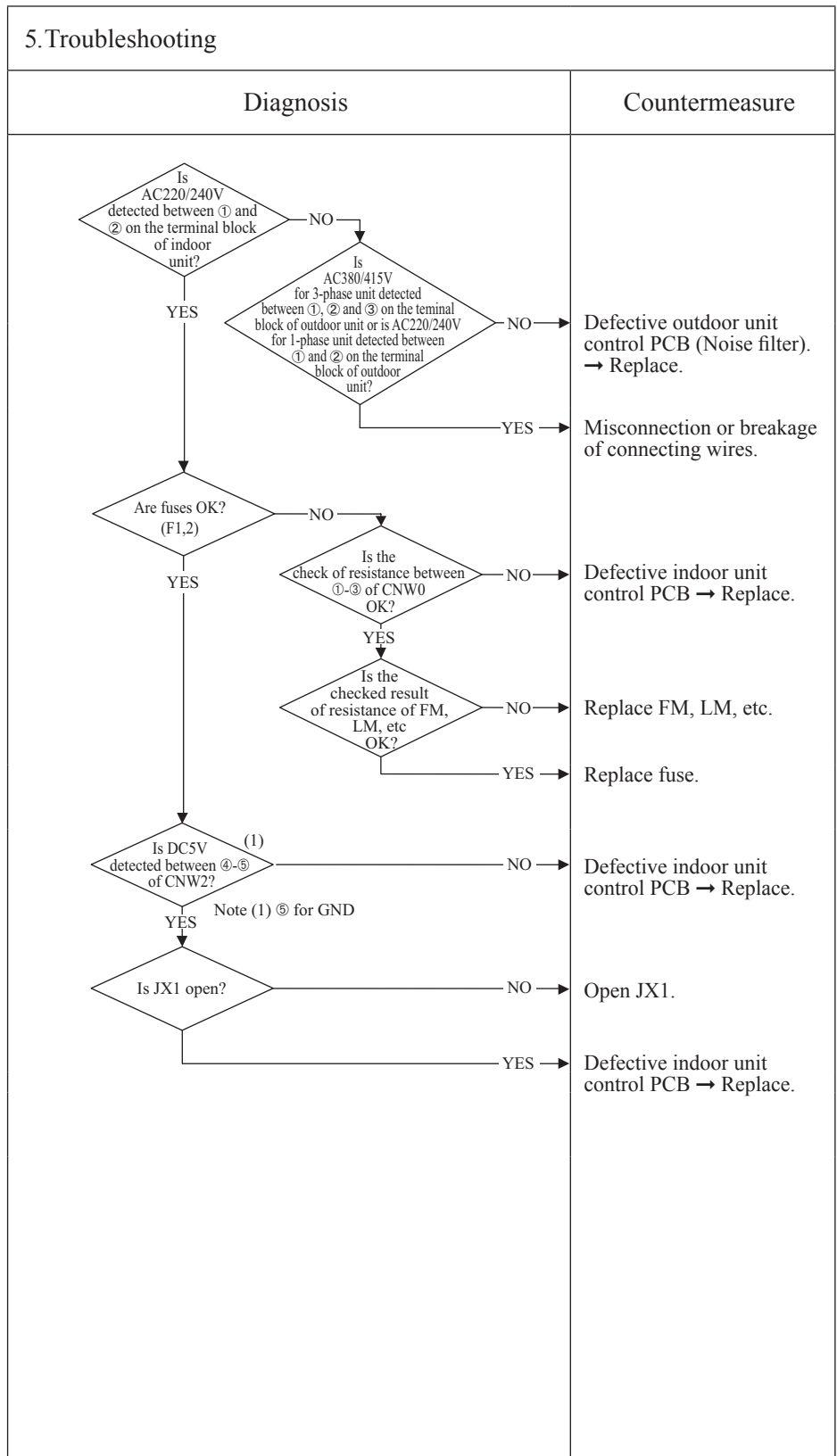

Note:

Error code Remote control: None	LED	Green	Red	Content Power source system error (Power source to remote control)
	Indoor	Keeps flashing	Stays OFF	
	Outdoor	Keeps flashing	2-time flash	

1. Applicable model

2. Error detection method

3. Condition of error displayed

4. Presumable cause

- Remote control wire breakage/short-circuit
- Defective remote control
- Malfunction by noise
- Broken harness
- Faulty indoor unit control PCB

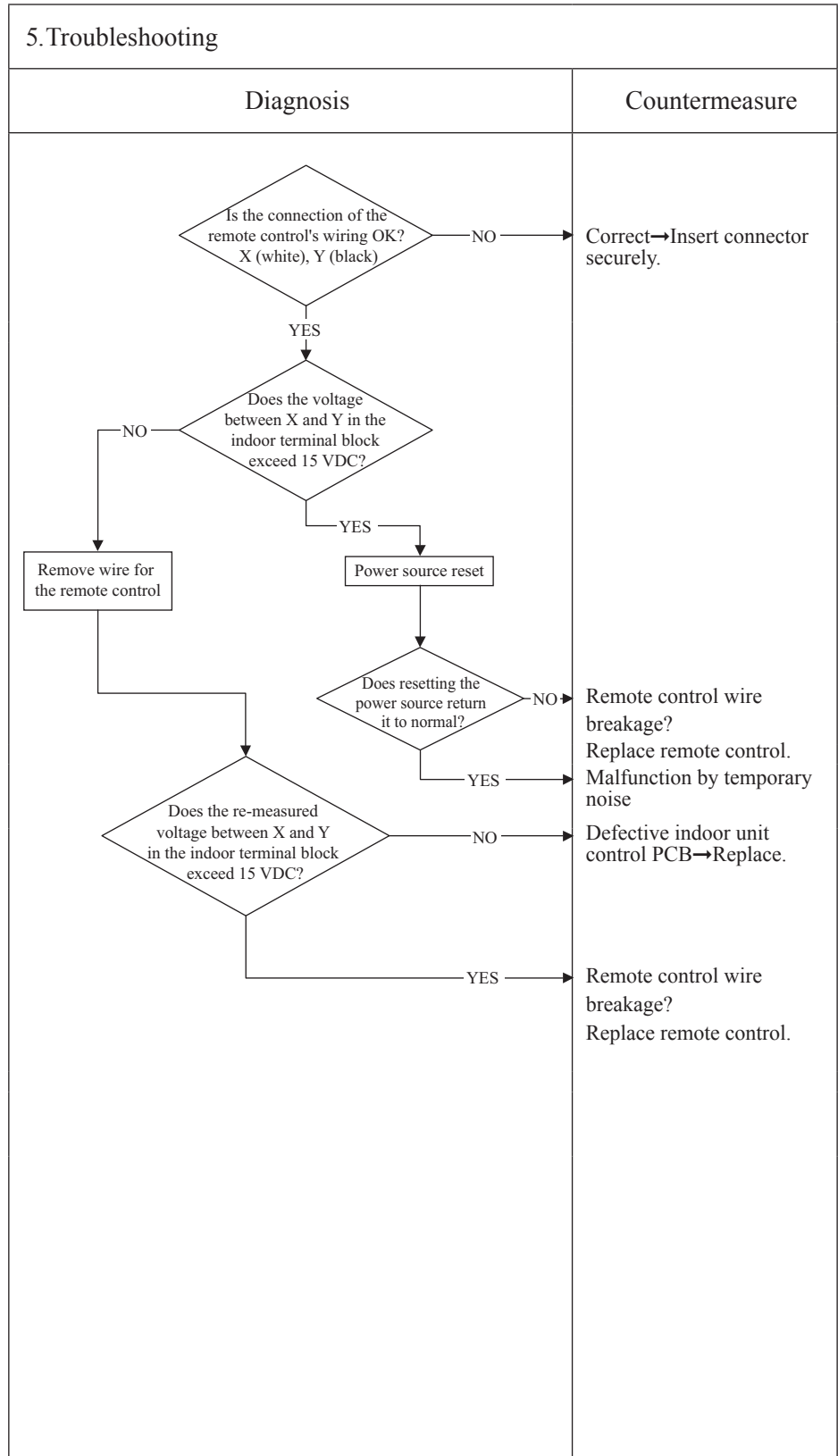

Note:

Error code Remote control: INSPECT I/U	LED	Green	Red	Content INSPECT I/U (When 1 or 2 remote controls are connected)
	Indoor	Keeps flashing	Stays OFF	
	Outdoor	Keeps flashing	2-time flash	

1. Applicable model
2. Error detection method
Communication between indoor unit and remote control is disabled for more than 30 minutes after the power on.
3. Condition of error displayed
Same as above
4. Presumable cause
<ul style="list-style-type: none"> • Improper setting • Surrounding environment • Defective remote control communication circuit • Faulty indoor unit control PCB

5. Troubleshooting	
Diagnosis	Countermeasure
<pre> graph TD Q1{Are 2 units of remote control connected?} Q2{Is it set at the slave remote control?} Q3{Does it become normal?} Q4{Do more than one indoor units have the same address?} Q5{Are remote control wires laid along high voltage wires?} Q6{Does DM start 60 seconds later automatically?} Q1 -- YES --> S1[Set one remote control for "Master" and the other for "Slave"] S1 --> Q3 Q3 -- YES --> C1[Normal] Q3 -- NO --> Q4 Q1 -- NO --> Q2 Q2 -- YES --> C2[Set SW1 on remote control PCB at "Master".] Q2 -- NO --> Q3 Q4 -- YES --> C3[Set address again. (SW2 on indoor unit control PCB)] Q4 -- NO --> Q5 Q5 -- YES --> C4[Separate remote control wires from high voltage wires.] Q5 -- NO --> S2[Disconnect the connecting wire ③ between the indoor and outdoor unit.] S2 --> S3[Power source reset] S3 --> Q6 Q6 -- YES --> C5[Defective indoor unit control PCB -> Replace.] Q6 -- NO --> C6[Defective remote control -> Change.] Note1[Note (1) Use SW1 to set at master or slave.] Note2[Note (2) "Slave" is displayed on the remote control LCD.] Note3[Note (3) Only indoor unit with drain pump] S1 --- Note1 Q2 --- Note2 S2 --- Note3 </pre>	

Note: If any error is detected 30 minutes after displaying “WAIT” on the remote control, the display changes to “INSPECT I/U”.

Error code Remote control: INSPECT I/U	LED	Green	Red	Content INSPECT I/U (Connection of 3 units or more remote controls)
	Indoor	Keeps flashing	Stays OFF	
	Outdoor	Keeps flashing	2-time flash	

1. Applicable model

2. Error detection method
Indoor unit cannot communicate for more than 30 minutes after the power on with remote control.

3. Condition of error displayed
Same as above

4. Presumable cause
- Improper setting
 - Surrounding environment
 - Defective remote control communication circuit
 - Faulty indoor unit control PCB
 - Faulty outdoor unit control PCB

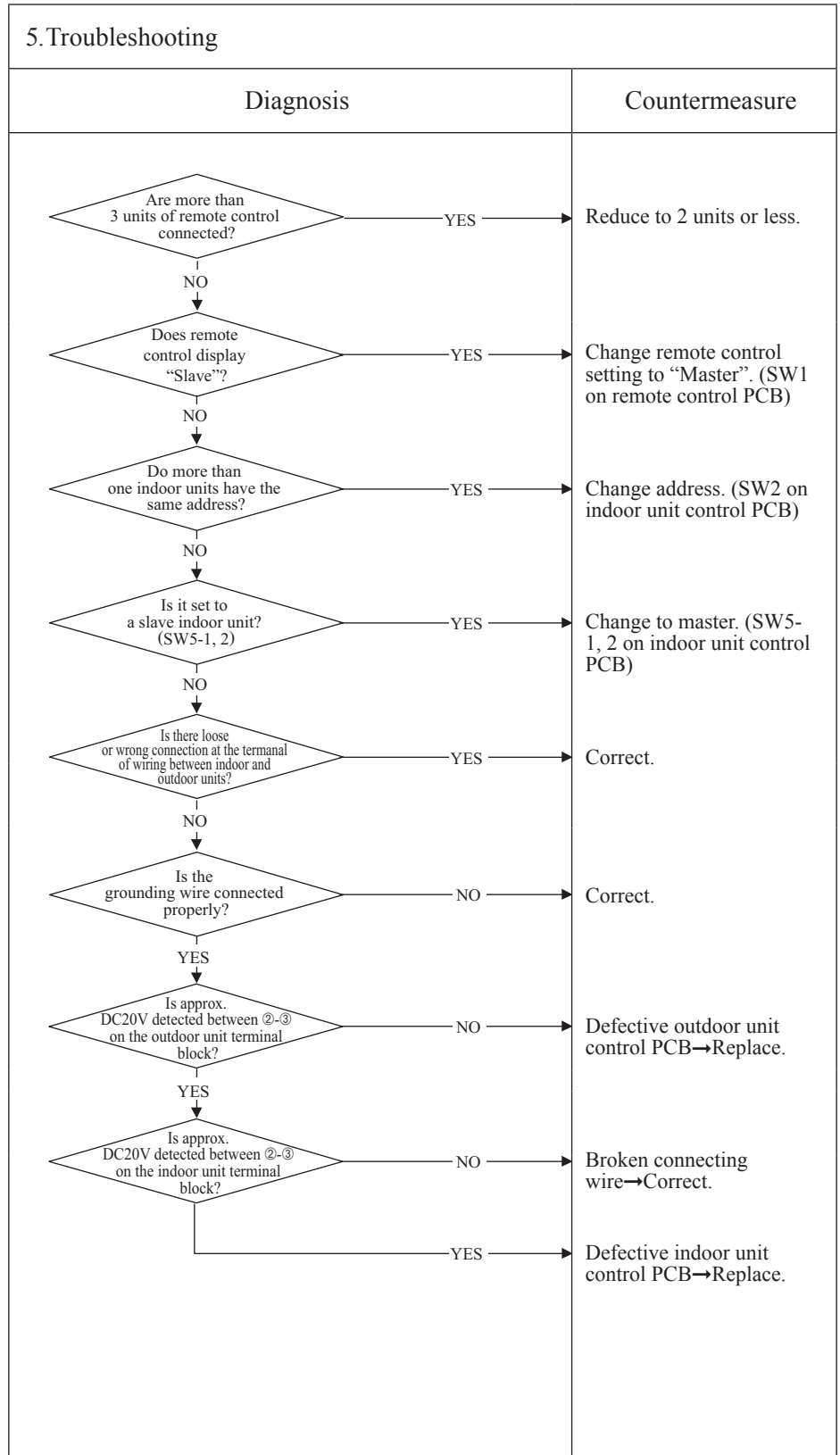

Note: If any error is detected 30 minutes after displaying "WAIT" on the remote control, the display changes to "INSPECT I/U".

Error code Remote control: WAIT	LED	Green	Red	Content Communication error at initial operation (1/3)
	Indoor	Keeps flashing	Stays OFF	
	Outdoor	Keeps flashing	2-time flash	

1. Applicable model

2. Error detection method

3. Condition of error displayed

4. Presumable cause
- Faulty indoor unit control PCB
 - Defective remote control
 - Broken remote control wire
 - Faulty outdoor unit control PCB
 - Broken connection wires

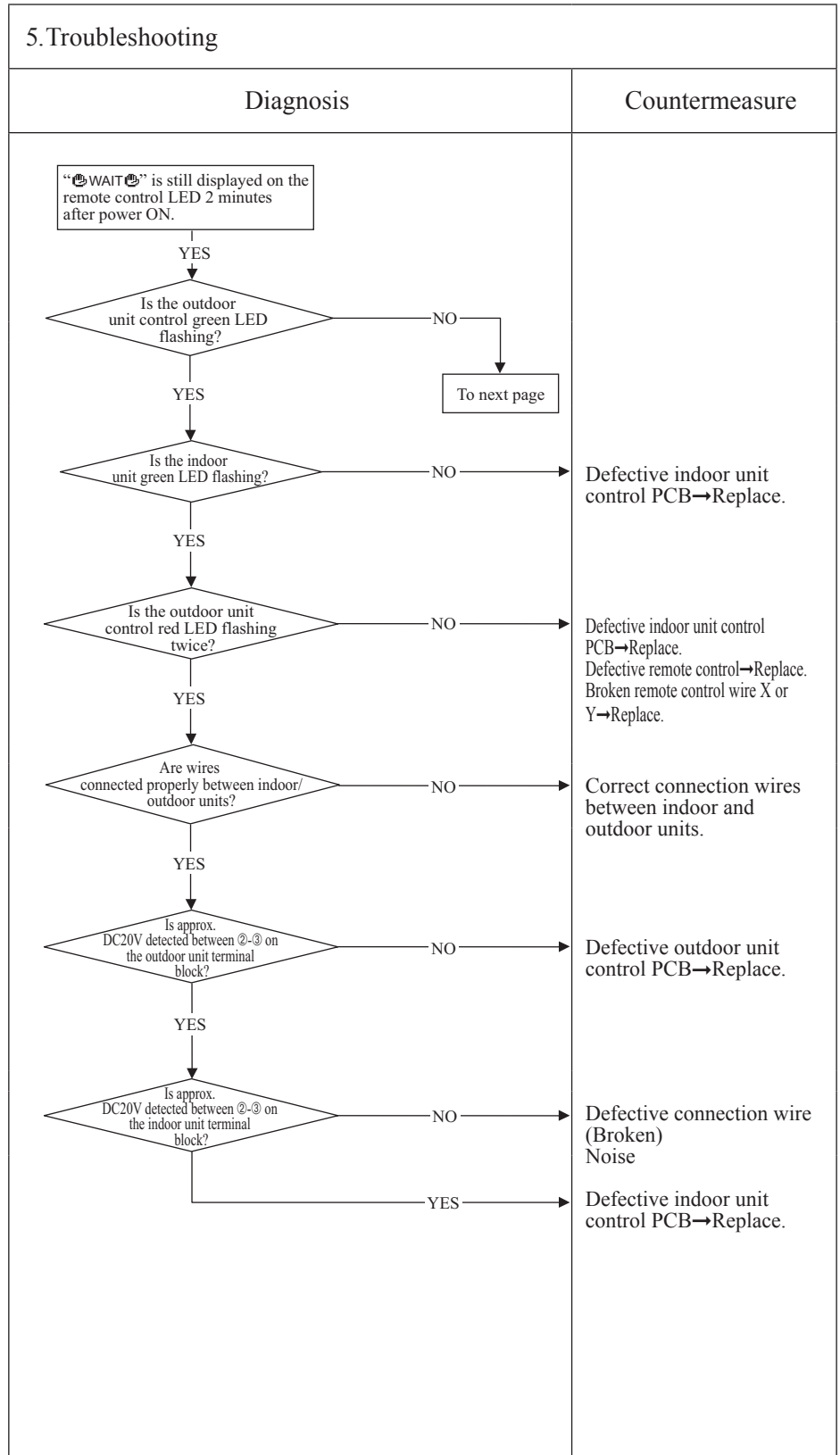

Note:

Error code Remote control: WAIT	LED	Green	Red	Content Communication error at initial operation (2/3)
	Indoor	Keeps flashing	Stays OFF	
	Outdoor	Keeps flashing	2-time flash	

1. Applicable model
2. Error detection method
3. Condition of error displayed
4. Presumable cause

- Faulty noise filter
- Faulty indoor unit control PCB
- Faulty outdoor unit control PCB
- Faulty inverter PCB
- Faulty fan motor

5. Troubleshooting	Diagnosis	Countermeasure
	<p>Diagnosis for when the outdoor unit control PCB LED is turned off</p> <pre> graph TD Start[From previous page] --> Step1[Shut down the breaker and back on again the breaker 3 minutes later.] Step1 --> Dec1{Does it reset normally?} Dec1 -- YES --> C1[Normal (Malfunction by noise)] Dec1 -- NO --> Dec2{Is the outdoor unit control power source fuse (71:20A) blown?} Dec2 -- YES --> Note1[Note (1) 1-phase model only] Note1 --> Step2[To check method for inverter PCB before replacment of blown power source fuse.] Step2 --> Dec3{Is AC220/240V or AC380/415V detected at the noise filter secondary side?} Dec3 -- NO --> C2[Replace noise filter.] Dec3 -- YES --> Dec4{Is DC255-310V detected at CNA2?} Dec4 -- NO --> C3[Check connection of diode stack and electrolytic capacitor by refering main electrical circuit diagram.] Dec4 -- YES --> Dec5{Is fuse [250V, 2A] on the outdoor unit control PCB blown?} Dec5 -- YES --> C4[Defective outdoor unit control PCB→Replace.] Dec5 -- NO --> Dec6{Is DC5V detected on the outdoor unit control PCB (Between ①-④ of CNV)?} Dec6 -- NO --> C5[Defective outdoor unit control PCB→Replace.] Dec6 -- YES --> Dec7{Is DC5V detected if the connector of outdoor fan motor is disconnected?} Dec7 -- NO --> C6[Defective outdoor fan motor] Dec7 -- YES --> Dec8{Is DC5V detected if the inverter power source connector (CN12) is disconnected?} Dec8 -- NO --> C7[Defective inverter PCB →Replace.] Dec8 -- YES --> C8[Defective outdoor unit control PCB→Replace.] </pre>	

Note:

Error code Remote control: 🏠 WAIT 🏠	LED	Green	Red	Content Communication error at initial operation (3/3)
	Indoor	Keeps flashing	Stays OFF	
	Outdoor	Keeps flashing	2-time flash	

1. Applicable model

2. Error detection method

3. Condition of error displayed

4. Presumable cause
- Blown fuse
 - Faulty noise filter
 - Faulty inverter PCB
 - Faulty reactor
 - Faulty electrolytic capacitor

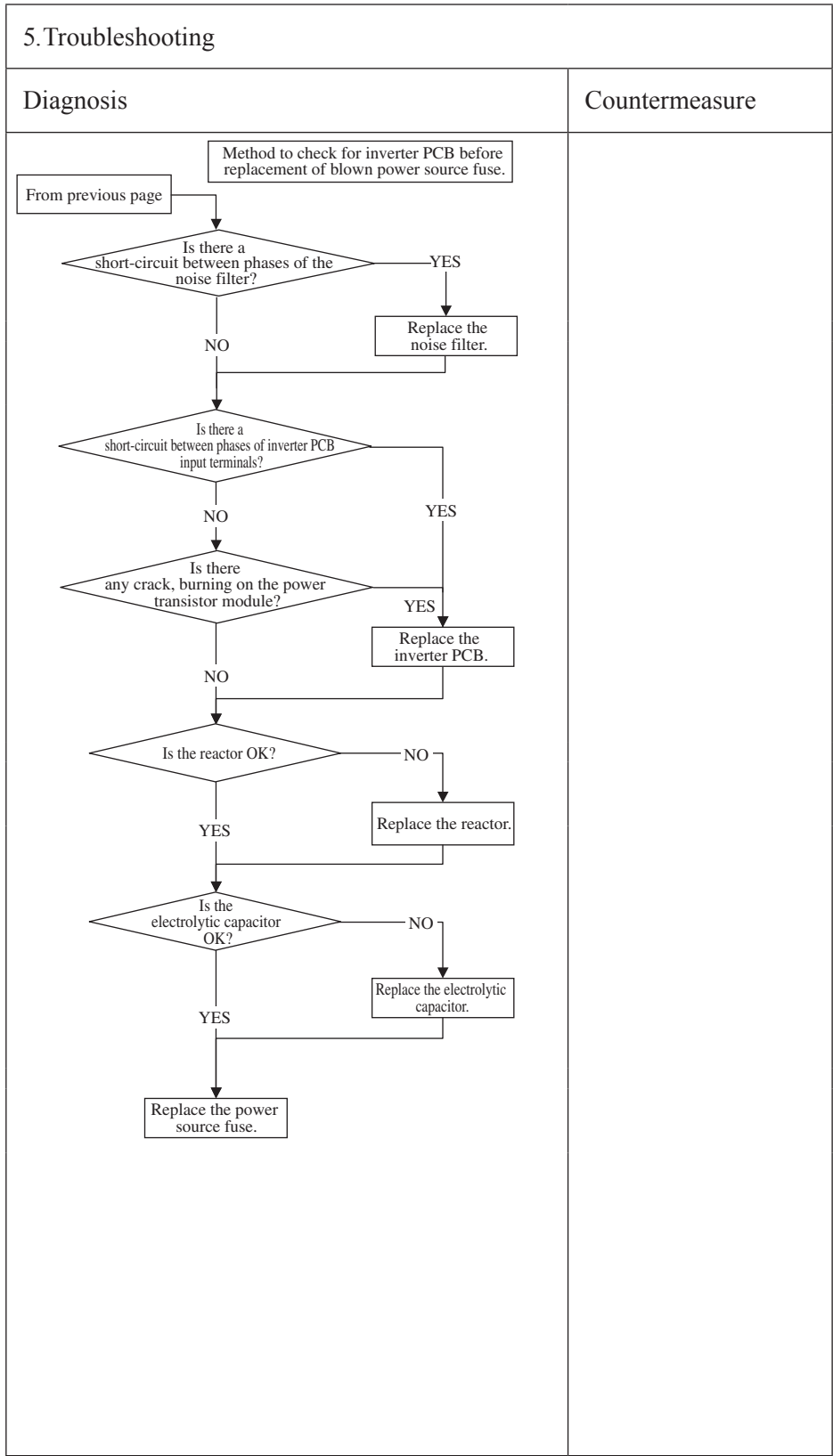

Note:

Error code Remote control: None	LED	Green	Red	Content No display
	Indoor	Stays OFF	Stays OFF	
	Outdoor	Stays OFF	Stays OFF	

1. Applicable model

2. Error detection method

3. Condition of error displayed

4. Presumable cause

- Faulty indoor unit control PCB
- Defective remote control
- Broken remote control wire

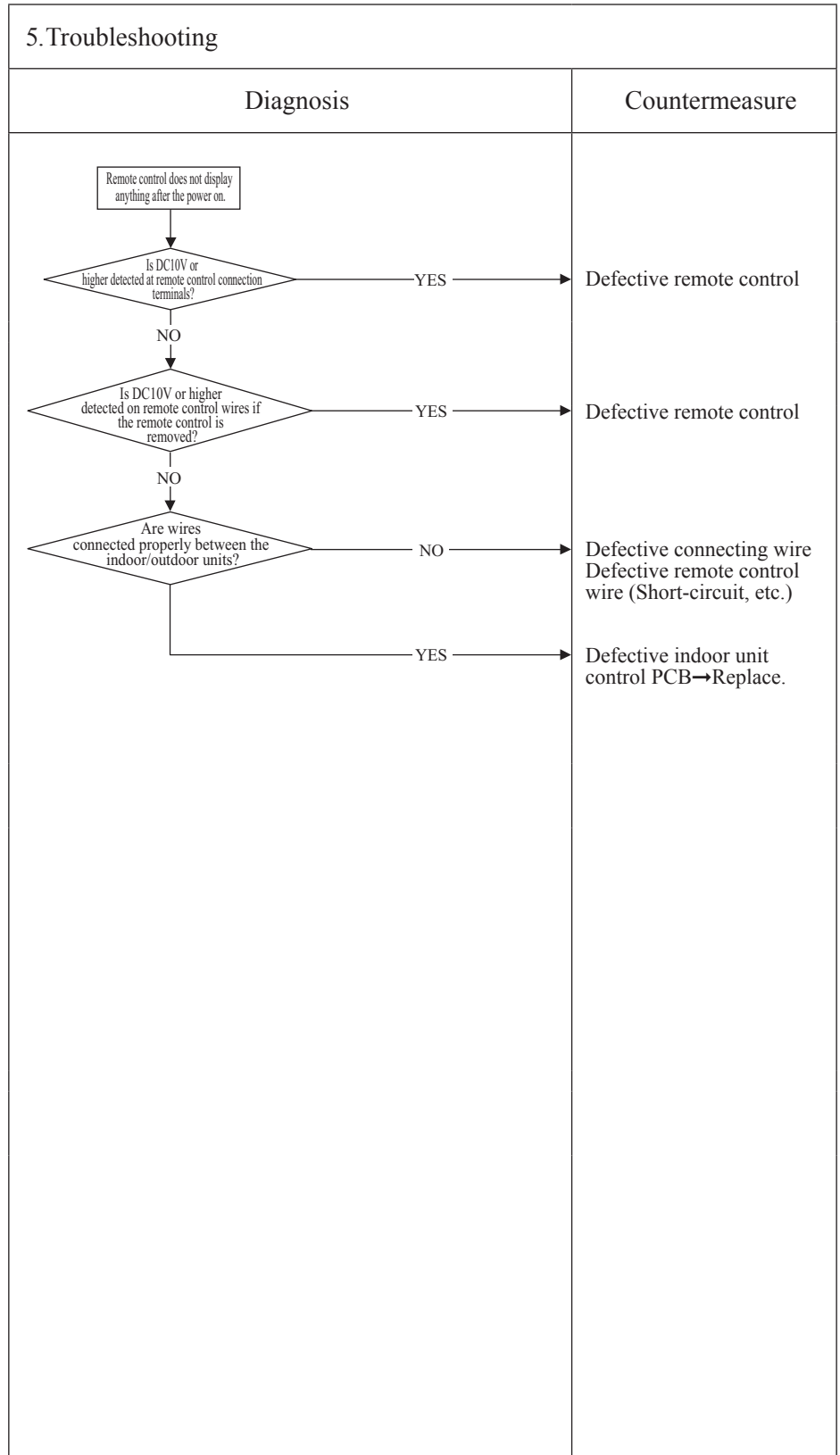

Note:

Error code Remote control: E1	LED	Green	Red	Content
	Indoor	Keeps flashing	Stays OFF	
	Outdoor	Keeps flashing	Stays OFF	

Remote control communication circuit error

1. Applicable model
2. Error detection method
When normal communication between the remote control and the indoor unit is interrupted for more than 2 minutes. (Detectable only with the remote control)
3. Condition of error displayed
Same as above
4. Presumable cause
<ul style="list-style-type: none"> • Defective communication circuit between remote control-indoor unit • Noise • Defective remote control • Faulty indoor unit control PCB

5. Troubleshooting	
Diagnosis	Countermeasure
<pre> graph TD A{Is it possible to reset normally by the power reset?} -- YES --> B[Malfunction by noise Check peripheral environment.] A -- NO --> C[Turn SW7-1 to OFF → ON. Remove the wire ③ connecting between indoor/outdoor units.] C --> D[Power source reset] D --> E{Does the drain pump restart automatically 1 minute later? (1)} E -- YES --> F[Defective indoor unit control PCB → Replace.] E -- NO --> G[Connect the wire ③ connecting between indoor/outdoor units.] G --> H[Move to E5. (Communication error during operation) Check.] </pre>	

Note: If the indoor unit cannot communicate normally with the remote control for 180 seconds, the indoor unit PCB starts to reset automatically.

Error code Remote control: E5	LED	Green	Red	Content Communication error during operation
	Indoor	Keeps flashing	2-time flash	
	Outdoor	Keeps flashing	See below	

1. Applicable model
2. Error detection method
When normal communication between indoor and outdoor unit is interrupted for more than 2 minutes.
3. Condition of error displayed
Same as above is detected during operation.
4. Presumable cause
<ul style="list-style-type: none"> • Unit No. setting error • Broken remote control wire • Faulty remote control wire connection • Faulty outdoor unit control PCB

5. Troubleshooting	
Diagnosis	Countermeasure
<p>● In case that the outdoor unit red LED flashes 2-time</p> <p>Note (1) Inspect faulty connections (disconnection, looseness) on the outdoor unit terminal block.</p> <p>Is the connection of signal wires at the outdoor unit side OK?</p> <p>NO → Repair signal wires.</p> <p>YES</p> <p>Note (2) Check for faulty connection or breakage of signal wires between indoor-outdoor units.</p> <p>Is the connection of signal wires between indoor-outdoor units OK?</p> <p>NO → Repair signal wires.</p> <p>YES</p> <p>Power source reset</p> <p>Has the remote control LCD returned to normal state?</p> <p>NO → To the diagnosis of “WAIT”.</p> <p>YES → Unit is normal. (Malfunction by temporary noise, etc.)</p> <p>● In case that the outdoor unit red LED stays OFF</p> <p>Power source reset</p> <p>Has the remote control LCD returned to normal state?</p> <p>NO → Defective outdoor unit PCB (Defective network communication circuit) → Replace.</p> <p>YES → Unit is normal. (Malfunction by temporary noise, etc.)</p>	

Note: Pressing the pump-down switch cancels communications between indoor and outdoor unit so that “communication error-E5” is displayed on indoor unit and remote control, but it is normal.

Error code Remote control: E6	LED	Green	Red	Content Indoor heat exchanger temperature sensor anomaly
	Indoor	Keeps flashing	1-time flash	
	Outdoor	Keeps flashing	Stays OFF	

1. Applicable model

2. Error detection method

Anomalously low temperature or high temperature (resistance) is detected on the indoor heat exchanger temperature sensor (Thi-R1, R2 or R3).

3. Condition of error displayed

- When the temperature sensor detects -50°C or lower for 5 seconds continuously, the compressor stops. After 3-minute delay, the compressor starts again automatically, but if this error occurs again within 60 minutes after the initial detection.
- Or if 70°C or higher is detected for 5 seconds continuously.

4. Presumable cause

- Defective indoor heat exchanger temperature sensor connector
- Indoor heat exchanger temperature sensor anomaly
- Faulty indoor unit control PCB

5. Troubleshooting

Diagnosis	Countermeasure
<p>Is the connection of indoor heat exchanger temperature sensor connector OK?</p> <p>NO →</p> <p>YES →</p>	<p>Correct. → Insert connector securely.</p>
<p>Are characteristics of indoor heat exchanger temperature sensor OK?</p> <p>NO →</p> <p>YES →</p>	

Defective indoor heat exchanger temperature sensor → Replace.

Defective indoor unit control PCB → Replace. (Defective indoor heat exchanger temperature sensor input circuit)

Temperature-resistance characteristic

Temperature (°C)	Temperature sensor resistance (kΩ)
0	15
10	10
20	6
25	5
30	4
40	3
50	2

Note:

Error code Remote control: E7	LED	Green	Red	Content Return air temperature sensor anomaly
	Indoor	Keeps flashing	1-time flash	
	Outdoor	Keeps flashing	Stays OFF	

1. Applicable model

2. Error detection method

Anomalously low temperature or high temperature (resistance) is detected by indoor return air temperature sensor (Thi-A)

3. Condition of error displayed

- When the temperature sensor detects -50°C or lower for 5 seconds continuously, the compressor stops. After 3-minute delay, the compressor starts again automatically, but if this error occurs again within 60 minutes after the initial detection.

4. Presumable cause

- Defective return air temperature sensor connector
- Defective return air temperature sensor
- Faulty indoor unit control PCB

5. Troubleshooting

Diagnosis	Countermeasure
<p>Is the connection of return air temperature sensor connector OK?</p> <p>NO →</p> <p>YES →</p> <p>Are the characteristics of return air temperature sensor OK?</p> <p>NO →</p> <p>YES →</p>	<p>Correct. → Connect connector.</p> <p>Defective return air temperature sensor → Replace.</p> <p>Defective indoor unit control PCB → Replace. (Defective return air temperature sensor input circuit)</p>

Temperature-resistance characteristic

Temperature (°C)	Temperature sensor resistance (kΩ)
0	15
10	10
20	7
25	5
30	4
40	3
50	2

Note:

Error code Remote control: E8	LED	Green	Red	Content Heating overload operation
	Indoor	Keeps flashing	1-time flash	
	Outdoor	Keeps flashing	Stays OFF	

1. Applicable model
2. Error detection method
Indoor heat exchanger temperature sensor (Thi-R1, R2, R3)
3. Condition of error displayed
When it is detected 5 times within 60 minutes from initial detection or when the overload condition is detected for 6 minutes continuously.
4. Presumable cause
<ul style="list-style-type: none"> • Clogged air filter • Defective indoor heat exchanger temperature sensor connector • Defective indoor heat exchanger temperature sensor • Anomalous refrigerant system

5. Troubleshooting	
Diagnosis	Countermeasure
<pre> graph TD A{Is the air filter clogged?} -- YES --> B[Wash.] A -- NO --> C{Is the indoor heat exchanger temperature sensor connection OK?} C -- YES --> D{Are the characteristics of indoor heat exchanger temperature sensor OK?} C -- NO --> E[Defective indoor heat exchanger temperature sensor connector -> Correct.] D -- YES --> F[Check the error data with the remote control.] D -- NO --> G[Defective indoor heat exchanger temperature sensor -> Replace.] F --> H{Is the unit operating in the state of heating overload?} H -- YES --> I[Adjust.] H -- NO --> J[Check refrigerant system.] </pre>	
<p>Note (1) Judge if it is in the state of overload or not as follows.</p> <ul style="list-style-type: none"> • Is there any short-circuit of air? • Isn't there any fouling or clogging on the indoor heat exchanger? • Is the outdoor fan control normal? • Isn't the room and outdoor air temperature too high? <p>Note (2) For characteristics of indoor heat exchanger temperature sensor, see the error display E6.</p>	
<p style="text-align: center;">Indoor heat exchanger temperature (°C)</p>	

Note: During heating operation; After starting compressor, compressor rotation speed is decreased by detecting indoor heat exchanger temperature (Thi-R) in order to control high pressure.

Error code Remote control: E9	LED	Green	Red	Content	Drain trouble
	Indoor	Keeps flashing	1-time flash		
	Outdoor	Keeps flashing	Stays OFF		

1. Applicable model
FDT, FDTC, FDU, FDUM series
2. Error detection method
Float switch is activated
3. Condition of error displayed
If the float switch OPEN is detected for 3 seconds continuously or if float switch connector or wire is disconnected.
4. Presumable cause
<ul style="list-style-type: none"> • Defective indoor unit control PCB • Float switch setting error • Humidifier drain pump motor interlock setting error • Option equipment setting error • Drain piping error • Defective drain pump motor • Disconnection of drain pump motor wiring

5. Troubleshooting	
Diagnosis	Countermeasure
<pre> graph TD Start[Check the error data in the remote control.] --> Q1{Is there any overflow?} Q1 -- NO --> Q2{Is DC12V at CNI connector?} Q2 -- YES --> C1[Check float switch.] Q2 -- NO --> Q3{Is the CNI connected firmly?} Q3 -- NO --> C2[Defective indoor unit control PCB → Replace.] Q3 -- YES --> Q4{Is there any anomaly on the option equipment?} Q4 -- NO --> C3[Defective indoor unit control PCB → Replace.] Q4 -- YES --> C4[Check option equipment.] Q1 -- YES --> Q5{Is the humidifier connected?} Q5 -- YES --> Q6{Is the humidifier drain pump motor interlocked by the indoor unit function setting of remote control?} Q6 -- YES --> Q7{Drain pump motor ON from the remote control} Q6 -- NO --> C5[Correct setting to "Humidifier drain pump motor interlock".] Q7 --> Q8{Does drain pump motor operate?} Q8 -- NO --> Q9{Is DC12V detected at CNR connector?} Q9 -- NO --> C6[Defective indoor unit control PCB → Replace.] Q9 -- YES --> C7[Check wiring of drain pump motor.] Q8 -- YES --> Q10{Is the drain piping unclogged? Is the drain pipe slope OK?} Q10 -- NO --> C8[Correct.] Q10 -- YES --> C9[Check drain pump motor.] </pre>	

Note: When this error occurred at power ON, disconnection of wire or connector of the float switch is suspected. Check and correct it (or replace it, if necessary).

Error code Remote control: E10	LED	Green	Red	Content Excessive number of connected indoor units (more than 17 units) by controlling with one remote control
	Indoor	Keeps flashing	Stays OFF	
	Outdoor	Keeps flashing	Stays OFF	

<p>1. Applicable model</p>	<p>5. Troubleshooting</p> <table border="1" style="width: 100%;"> <thead> <tr> <th style="width: 50%;">Diagnosis</th> <th style="width: 50%;">Countermeasure</th> </tr> </thead> <tbody> <tr> <td style="text-align: center;"> <pre> graph TD A{Are more than 17 indoor units connected to one remote control?} -- NO --> B[Defective remote control -> Replace.] A -- YES --> C[Reduce to 16 or less units.] </pre> </td> <td></td> </tr> </tbody> </table>		Diagnosis	Countermeasure	<pre> graph TD A{Are more than 17 indoor units connected to one remote control?} -- NO --> B[Defective remote control -> Replace.] A -- YES --> C[Reduce to 16 or less units.] </pre>	
Diagnosis	Countermeasure					
<pre> graph TD A{Are more than 17 indoor units connected to one remote control?} -- NO --> B[Defective remote control -> Replace.] A -- YES --> C[Reduce to 16 or less units.] </pre>						
<p>2. Error detection method</p> <p>When it detects more than 17 of indoor units connected to one remote control</p>						
<p>3. Condition of error displayed</p> <p>Same as above</p>						
<p>4. Presumable cause</p> <ul style="list-style-type: none"> • Excessive number of indoor units connected • Defective remote control 						

Note:

Error code Remote control: E11	LED	Green	Red	Content Address setting error of indoor units
	Indoor	Keeps flashing	Stays OFF	
	Outdoor	Keeps flashing	Stays OFF	

1. Applicable model

2. Error detection method

IU address has been set using the “Master IU address set” function of remote control.

3. Condition of error displayed

Same as above

4. Presumable cause

Mistake of address setting method
(Address setting from remote control can't be done)

5. Troubleshooting

Diagnosis	Countermeasure
<pre> graph TD A[E11 occurs] --> B{Is "Master IU address set" function of remote control used?} B -- YES --> C[Change of address setting method] </pre> <p>In case the wiring is below and “Master IU address set” is used, E11 is appeared.</p>	<p>Change of address setting method Set the address by DIP switch SW2 on indoor unit control PCB.</p>

Note:

Error code Remote control: E14	LED	Green	Red	Content Communication error between master and slave indoor units
	Indoor	Keeps flashing	3-time flash	
	Outdoor	Keeps flashing	Stays Off	

1. Applicable model

2. Error detection method

When communication error between master and slave indoor units occurs

3. Condition of error displayed

Same as above

4. Presumable cause

- Unit address setting error
- Broken remote control wire
- Defective remote control wire connection
- Defective indoor unit control PCB

5. Troubleshooting

Diagnosis	Countermeasure																	
<pre> graph TD D1{Is it OK the unit address setting for master and slave indoor units?} D2{Is the remote control wiring between indoor units defective?} D3{Is it restored by resetting the power source?} D1 -- NO --> C1[Correct unit address setting.] D1 -- YES --> D2 D2 -- YES --> C2[Correct wiring.] D2 -- NO --> D3 D3 -- NO --> C3[Defective indoor unit control PCB -> Replace.] D3 -- YES --> C4["• Malfunction by noise • Check surrounding environment."] </pre>																		
<p>Note (1) Set DIP switches SW5-1 and SW5-2 as shown in the following table. (Factory default setting – “Master”)</p> <table border="1"> <thead> <tr> <th colspan="2" rowspan="2"></th> <th colspan="3">Indoor unit</th> </tr> <tr> <th>Master</th> <th>Slave-a</th> <th>Slave-b</th> </tr> </thead> <tbody> <tr> <th rowspan="2">DIP switch</th> <th>SW5-1</th> <td>OFF</td> <td>OFF</td> <td>ON</td> </tr> <tr> <th>SW5-2</th> <td>OFF</td> <td>ON</td> <td>OFF</td> </tr> </tbody> </table>				Indoor unit			Master	Slave-a	Slave-b	DIP switch	SW5-1	OFF	OFF	ON	SW5-2	OFF	ON	OFF
				Indoor unit														
		Master	Slave-a	Slave-b														
DIP switch	SW5-1	OFF	OFF	ON														
	SW5-2	OFF	ON	OFF														

Note:

Error code Remote control: E16	LED	Green	Red	Content Indoor fan motor anomaly
	Indoor	Keeps flashing	1-time flash	
	Outdoor	Keeps flashing	Stays OFF	

1. Applicable model

2. Error detection method

Detected by rotation speed of indoor fan motor

3. Condition of error displayed

- When actual rotation speed of indoor fan motor drops to lower than 200min^{-1} for 30 seconds continuously, the compressor and the indoor fan motor stop.
- After 2-seconds, it starts again automatically, but if this error occurs 4 times within 60 minutes after the initial detection.

4. Presumable cause

- Defective indoor unit control PCB
- Foreign material at rotational area of fan propeller
- Defective fan motor
- Dust on indoor unit control PCB
- Blown fuse
- External noise, surge

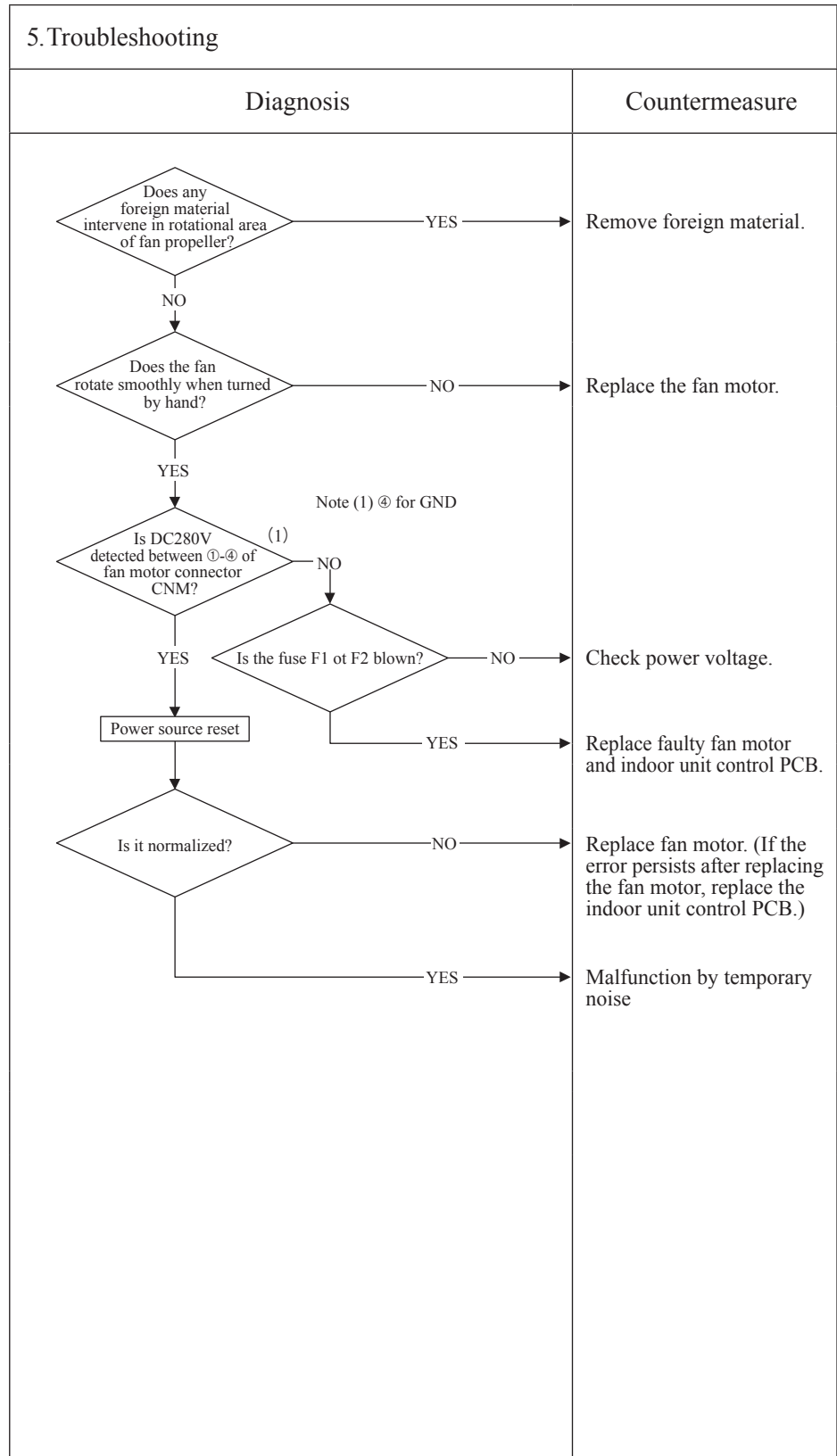

Note:

Error code Remote control: E18	LED	Green	Red	Content Address setting error of master and slave indoor units
	Indoor	Keeps flashing	1-time flash	
	Outdoor	Keeps flashing	Stays Off	

1. Applicable model

2. Error detection method

IU address has been set using the “Master IU address set” function of remote control.

3. Condition of error displayed

Same as above

4. Presumable cause

Same as above

5. Troubleshooting

Diagnosis	Countermeasure
<pre> graph TD A[E18 occurs] --> B{Is "Master IU address set" function of remote control used?} B -- YES --> C[] </pre>	<ul style="list-style-type: none"> • In cases of RC-EX3A Menu → Service setting → IU settings → Select IU • In cases of RC-E5 Return address No. to “IU ...” using [▲] or [▼] button.

Note:

Error code Remote control: E19	LED	Green	Red	Content Indoor unit operation check, drain pump motor check setting error
	Indoor	Keeps flashing	1-time flash	
	Outdoor	Keeps flashing	Stays OFF	

1. Applicable model

2. Error detection method

After indoor operation check, when the communication between indoor and outdoor unit is established and SW7-1 is still kept ON.

3. Condition of error displayed

Same as above

4. Presumable cause

Mistake in SW7-1 setting (Due to forgetting to turn OFF SW7-1 after indoor operation check)

5. Troubleshooting	
Diagnosis	Countermeasure
<pre> graph TD Start[E19 occurs when the power ON] --> Decision{Is SW7-1 on the indoor unit control PCB ON?} Decision -- NO --> Countermeasure1[Defective indoor unit control PCB (Defective SW7) -> Replace.] Decision -- YES --> Countermeasure2[Turn SW7-1 on the indoor unit control PCB OFF and reset the power.] </pre>	<p>Defective indoor unit control PCB (Defective SW7) → Replace.</p> <p>Turn SW7-1 on the indoor unit control PCB OFF and reset the power.</p>

Note:

Error code Remote control: E20	LED	Green	Red	Content Indoor fan motor rotation speed anomaly
	Indoor	Keeps flashing	1-time flash	
	Outdoor	Keeps flashing	Stays OFF	

1. Applicable model

2. Error detection method
Detected by rotation speed of indoor fan motor

3. Condition of error displayed
When the actual fan rotation speed does not reach to the speed of [required speed -50 min⁻¹(FDU: -500 min⁻¹)] after 2 minutes have been elapsed since the fan motor rotation speed command was output, the unit stops by detecting indoor fan motor anomaly.

- 4. Presumable cause**
- Defective indoor unit control PCB
 - Foreign material at rotational area of fan propeller
 - Defective fan motor
 - Dust on indoor unit control PCB
 - Blown fuse
 - External noise, surge

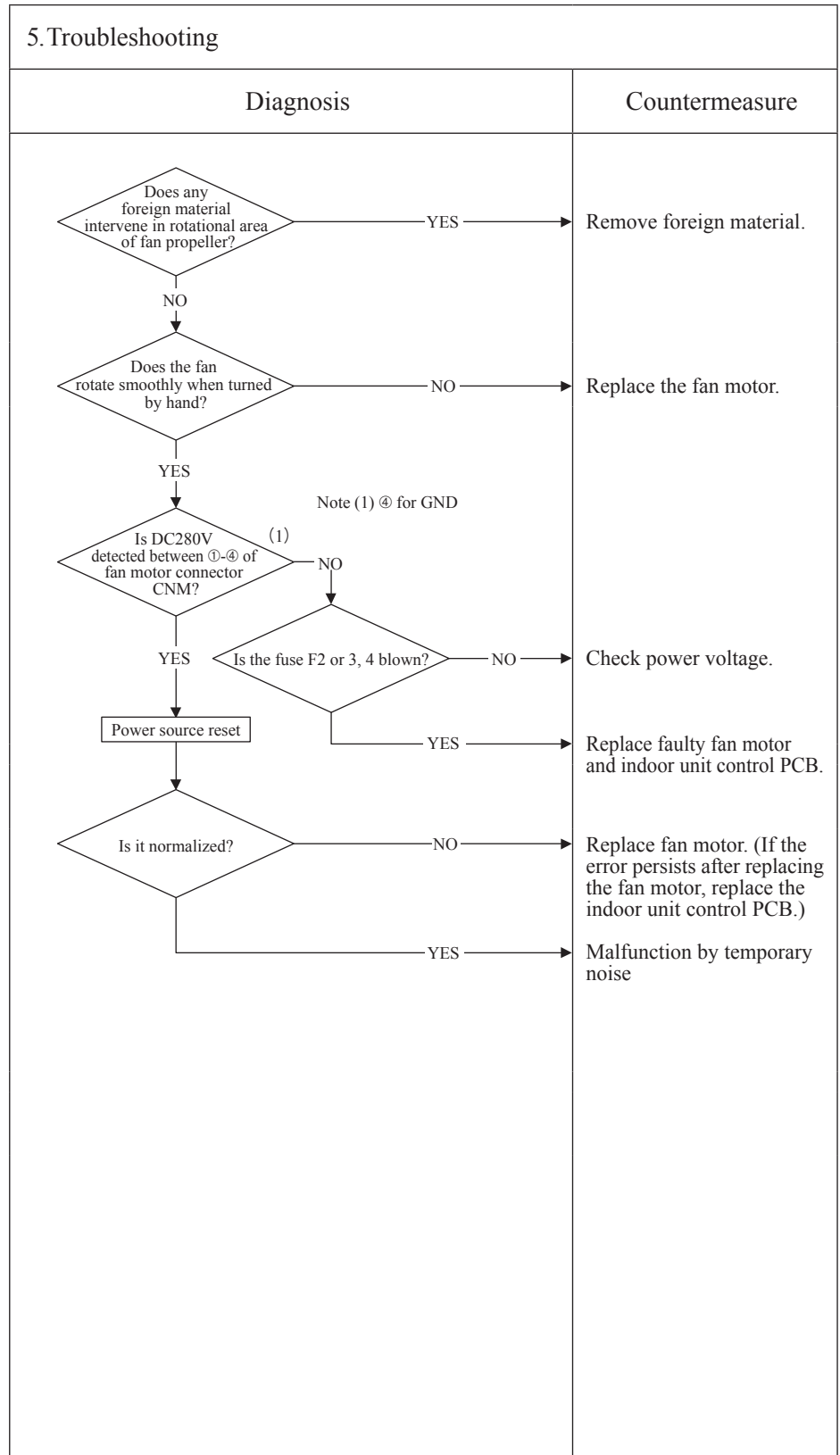

Note:

Error code Remote control: E28	LED	Green	Red	Content Remote control temperature sensor anomaly
	Indoor	Keeps flashing	Stays OFF	
	Outdoor	Keeps flashing	Stays OFF	

1. Applicable model

2. Error detection method
Detection of anomalously low temperature (resistance) of remote control temperature sensor (The)

3. Condition of error displayed
When the temperature sensor detects -50°C or lower for 5 seconds continuously, the compressor stops. After 3-minute delay, the compressor starts again automatically, but if this error occurs again within 60 minutes after the initial detection.

4. Presumable cause

- Faulty connection of remote control temperature sensor
- Defective remote control temperature sensor
- Defective remote control PCB

5. Troubleshooting

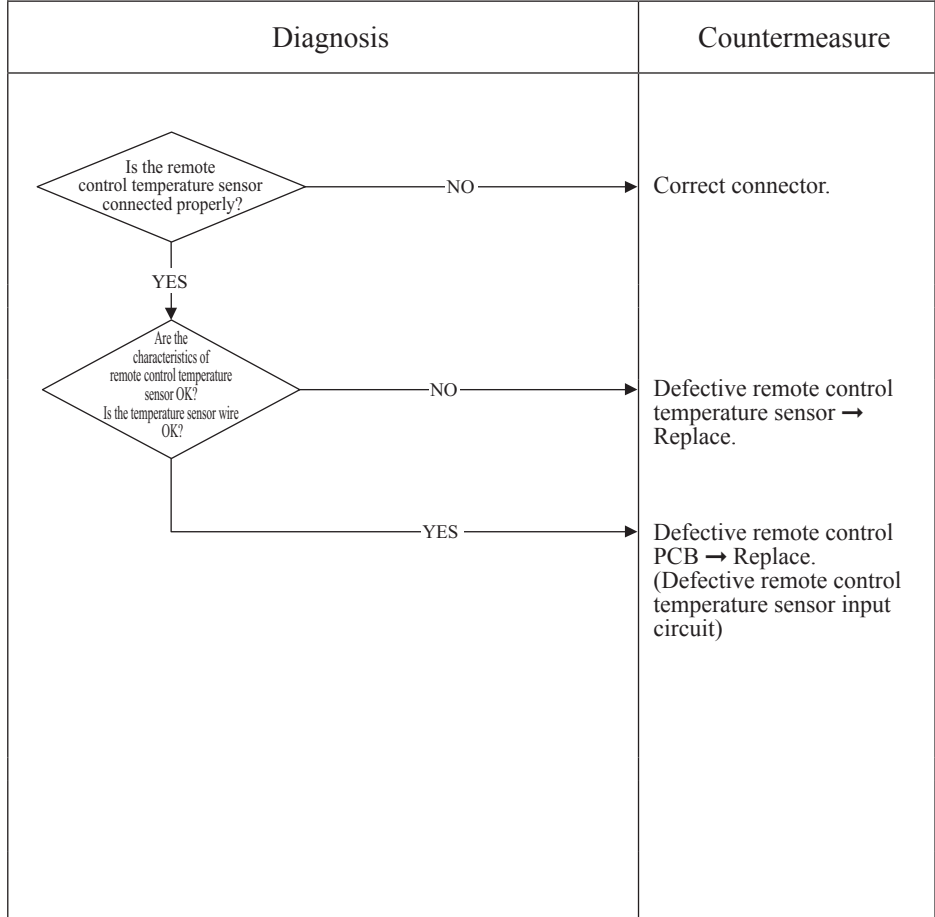

Temperature-resistance characteristics of remote control temperature sensor (The)

Temperature (°C)	Resistance value (kΩ)	Temperature (°C)	Resistance value (kΩ)
0	65	30	16
1	62	32	15
2	59	34	14
4	53	36	13
6	48	38	12
8	44	40	11
10	40	42	9.9
12	36	44	9.2
14	33	46	8.5
16	30	48	7.8
18	27	50	7.3
20	25	52	6.7
22	23	54	6.3
24	21	56	5.8
26	19	58	5.4
28	18	60	5.0

Note: After 10 seconds has passed since remote control temperature sensor was switched from valid to invalid, E28 will not be displayed even if the sensor harness is disconnected. At same time the temperature sensor, which is effective, is switched from remote control temperature sensor to indoor return air temperature sensor. Even though the remote control temperature sensor is set to be effective, the return air temperature displayed on remote control for checking still shows the value detected by indoor return air temperature sensor, not by remote control temperature sensor.

Error code Remote control: E35	LED	Green	Red	Content Cooling overload operation
	Indoor control PCB	Keeps flashing	Stays OFF	
	Outdoor control PCB	Keeps flashing	1-time flash	
	Outdoor inverter PCB	Yellow LED Keeps flashing		

1. Applicable model

2. Error detection method

For the error detection method, refer to the protective control by controlling compressor rotation speed and cooling high pressure protective control of micro-computer control function for corresponding models.

3. Condition of error displayed

When outdoor heat exchanger temperature anomaly is detected 5 times within 60 minutes or this anomalous state is detected 60 minutes continuously including compressor stop.

- 4. Presumable cause**
- Defective outdoor heat exchanger temperature sensor
 - Defective outdoor unit control PCB
 - Indoor, outdoor unit installation spaces
 - Short-circuit of air on indoor, outdoor units
 - Fouling, clogging of heat exchanger
 - Excessive refrigerant amount

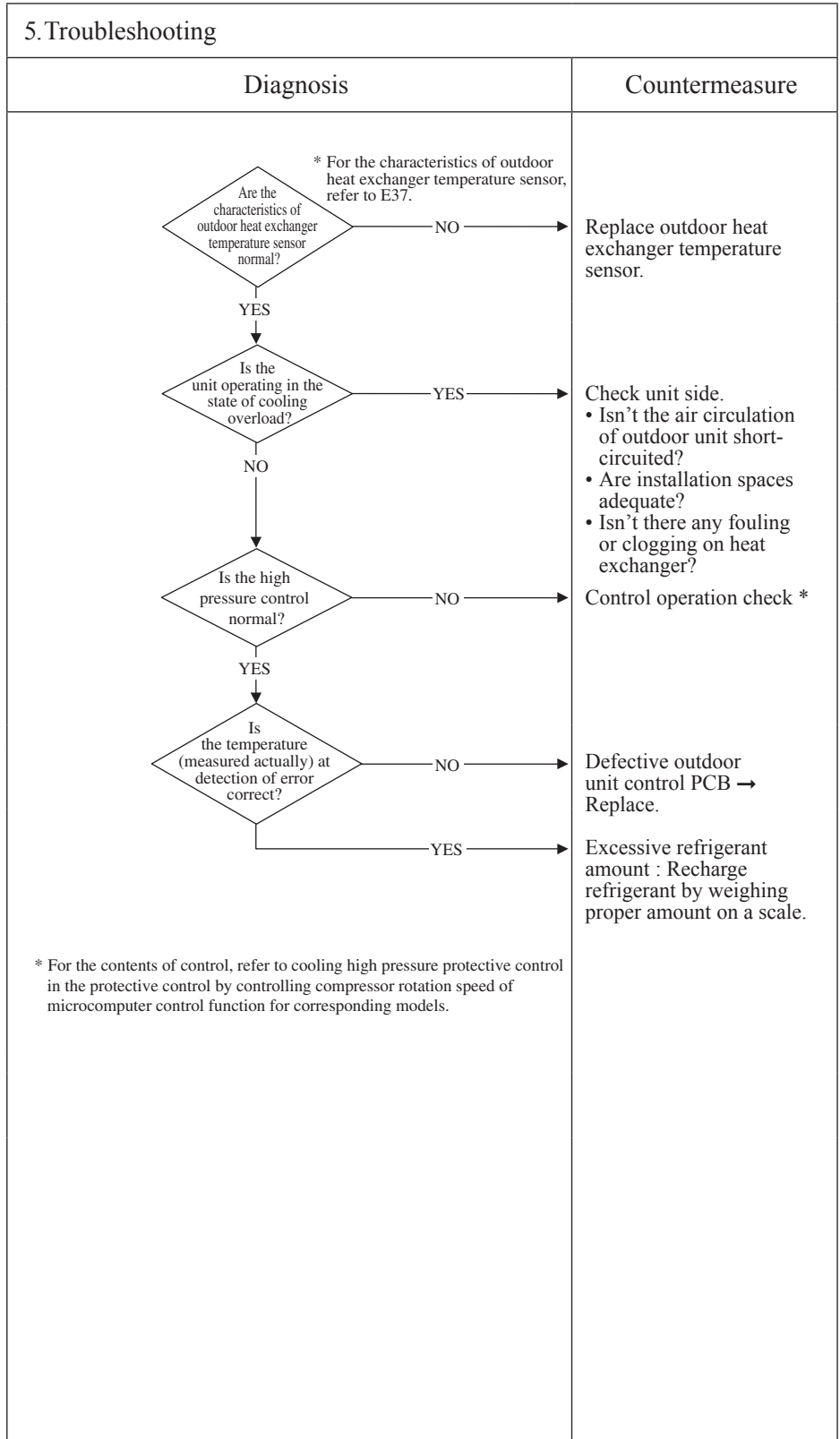

Note:

Error code Remote control: E36	LED	Green	Red	Content Discharge pipe temperature error
	Indoor control PCB	Keeps flashing	Stays OFF	
	Outdoor control PCB	Keeps flashing	1-time flash	
	Outdoor inverter PCB	Yellow LED Keeps flashing		

1. Applicable model

2. Error detection method

For the error detection method, refer to compressor overheat protective control in the protective control by controlling compressor rotation speed of microcomputer control function for corresponding models.

3. Condition of error displayed

When discharge pipe temperature anomaly is detected 2 times within 60 minutes or this anomalous state is detected 60 minutes continuously including compressor stop.

- 4. Presumable cause**
- Defective outdoor unit control PCB
 - Defective discharge pipe temperature sensor
 - Clogged filter
 - Indoor, outdoor unit installation spaces
 - Short-circuit of air on indoor, outdoor units
 - Fouling, clogging of heat exchanger

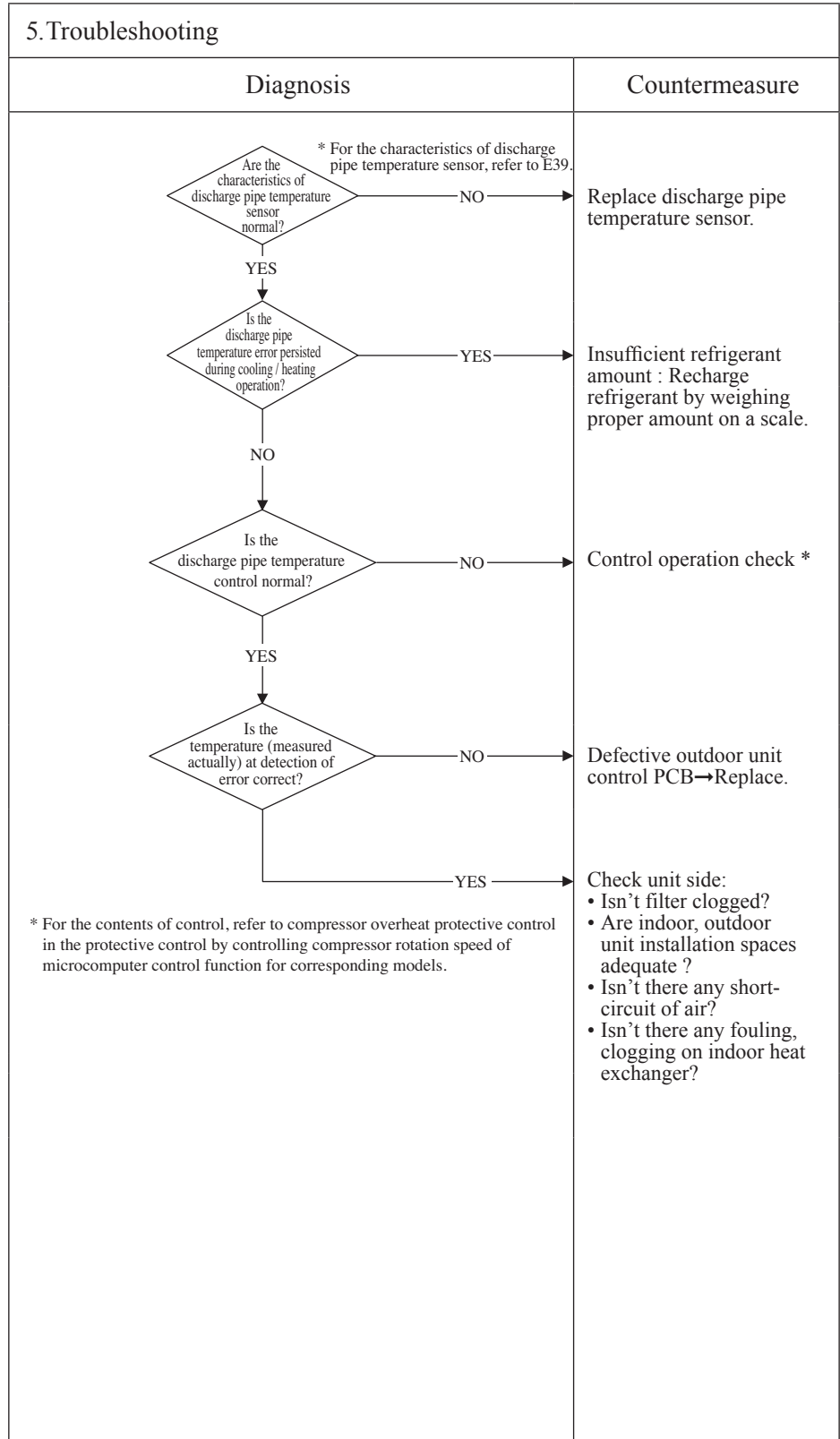

Note:

Error code Remote control: E37	LED	Green	Red	Content Outdoor heat exchanger temperature sensor anomaly
	Indoor control PCB	Keeps flashing	Stays OFF	
	Outdoor control PCB	Keeps flashing	1-time flash	
	Outdoor inverter PCB	Yellow LED Keeps flashing		

1.Applicable model

2.Error detection method

Detection of anomalously low temperature (resistance) on the outdoor heat exchanger temperature sensor

3. Condition of error displayed

- When the temperature sensor detects -50°C or lower for 5 seconds continuously within 2 minutes to 2 minutes 20 seconds after the compressor ON, the compressor stops. After 3-minute delay, the compressor starts again automatically, but if this anomalous temperature is detected 3 times within 40 minutes.
- When -50°C or lower is detected for 5 seconds continuously within 20 seconds after compressor ON.

4. Presumable cause

- Defective outdoor unit control PCB
- Broken sensor harness or temperature sensing section
- Disconnected wire connection (connector)

5.Troubleshooting

Diagnosis	Countermeasure
	<p>Correct connector.</p> <p>Defective outdoor heat exchanger temperature sensor → Replace.</p> <p>Defective outdoor unit control PCB → Replace. (Defective outdoor heat exchanger temperature sensor input circuit)</p>

Temperature-resistance characteristics

(Broken wire) (Short-circuit)

Temperature (°C)	Temperature sensor resistance (kΩ)
0	~18
10	~12
20	~7
25	5
30	~4
40	~3
50	~2

Note:

Error code Remote control: E38	LED	Green	Red	Content Outdoor air temperature sensor anomaly
	Indoor control PCB	Keeps flashing	Stays OFF	
	Outdoor control PCB	Keeps flashing	1-time flash	
	Outdoor inverter PCB	Yellow LED Keeps flashing		

1. Applicable model

2. Error detection method

Detection of anomalously low temperature (resistance) on outdoor air temperature sensor

3. Condition of error displayed

- When the temperature sensor detects -45°C or lower for 5 seconds continuously within 2 minutes to 2 minutes 20 seconds after the compressor ON, the compressor stops. After 3-minute delay, the compressor starts again automatically, but if this anomalous temperature is detected 3 times within 40 minutes.
- When -45°C or lower is detected for 5 seconds continuously within 20 seconds after compressor ON.

4. Presumable cause

- Defective outdoor unit control (or main) PCB
- Broken sensor harness or temperature sensing section (Check molding.)
- Disconnected wire connection (connector)

5. Troubleshooting

Diagnosis	Countermeasure
	<p>Correct connector.</p> <p>Defective outdoor air temperature sensor → Replace.</p> <p>Defective outdoor unit control (or main) PCB → Replace. (Defective outdoor air temperature sensor input circuit)</p>

Temperature-resistance characteristics

(Broken wire) 35

Temperature (°C)	Temperature sensor resistance (kΩ)
0	35
10	25
20	18
30	12
40	8
50	5

(Short-circuit) 0

Temperature (°C)

Note:

Error code Remote control: E39	LED	Green	Red	Content Discharge pipe temperature sensor anomaly
	Indoor control PCB	Keeps flashing	Stays OFF	
	Outdoor control PCB	Keeps flashing	1-time flash	
	Outdoor inverter PCB	Yellow LED Keeps flashing		

1. Applicable model

2. Error detection method

Detection of anomalously low temperature (resistance) on the discharge pipe temperature sensor

3. Condition of error displayed

When the temperature sensor detects -10°C or lower for 5 seconds continuously within 10 minutes to 10 minutes 20 seconds after the compressor ON, the compressor stops. After 3-minute delay, the compressor starts again automatically, but if this anomalous temperature is detected 3 times within 40 minutes.

4. Presumable cause

- Defective outdoor unit control (or main) PCB
- Broken sensor harness or temperature sensing section (Check molding.)
- Disconnected wire connection (connector)

5. Troubleshooting

Diagnosis	Countermeasure																				
<pre> graph TD Q1{Is the discharge pipe temperature sensor connector connected properly?} -- NO --> C1[Correct connector.] Q1 -- YES --> Q2{Are the characteristics of discharge pipe temperature sensor OK?} Q2 -- NO --> C2[Defective discharge pipe temperature sensor -> Replace.] Q2 -- YES --> C3[Defective outdoor unit control (or main) PCB -> Replace. (Defective discharge pipe temperature sensor input circuit)] </pre>																					
<p>(Broken wire) Temperature-resistance characteristics</p> <table border="1"> <caption>Temperature-resistance characteristics</caption> <thead> <tr> <th>Temperature (°C)</th> <th>Temperature sensor resistance (kΩ)</th> </tr> </thead> <tbody> <tr><td>0</td><td>180</td></tr> <tr><td>20</td><td>100</td></tr> <tr><td>40</td><td>60</td></tr> <tr><td>60</td><td>40</td></tr> <tr><td>80</td><td>30</td></tr> <tr><td>100</td><td>25</td></tr> <tr><td>120</td><td>22</td></tr> <tr><td>140</td><td>20</td></tr> <tr><td>160</td><td>18</td></tr> </tbody> </table>	Temperature (°C)	Temperature sensor resistance (kΩ)	0	180	20	100	40	60	60	40	80	30	100	25	120	22	140	20	160	18	
Temperature (°C)	Temperature sensor resistance (kΩ)																				
0	180																				
20	100																				
40	60																				
60	40																				
80	30																				
100	25																				
120	22																				
140	20																				
160	18																				

Note:

Error code Remote control: E40	LED	Green	Red	Content High pressure error (63H1 activated)
	Indoor control PCB	Keeps flashing	Stays OFF	
	Outdoor control PCB	Keeps flashing	1-time flash	
	Outdoor inverter PCB	Yellow LED Keeps flashing		

1. Applicable model

2. Error detection method

When the high pressure switch 63H1 is activated.

3. Condition of error displayed

If 63H1 turns OFF (opened), the compressor stops. After 3-minute delay, the compressor restarts. If this anomaly occurs 5 times within 60 minutes or continues for 60 minutes continuously.

4. Presumable cause

- Short-circuit of air flow, disturbance of air flow and clogging filter at outdoor heat exchanger/Breakdown of fan motor
- Defective outdoor unit control (or main) PCB
- Defective 63H1 connector
- Defective electronic expansion valve connector
- Closed service valve
- Mixing of non-condensing gas (nitrogen, etc.)

5. Troubleshooting

Diagnosis	Countermeasure
<p>If the power source breaker is turned OFF and ON too quickly, E40 may be displayed. (This is normal.)</p> <p>Is the service valve fully opened?</p> <p>NO → Open the service valve.</p> <p>YES</p> <p>Has 63H1 activated?</p> <p>NO → Is 63H1 connector connected properly?</p> <p>NO → Correct 63H1 connector.</p> <p>YES</p> <p>Is the electronic expansion valve connector connection OK?</p> <p>NO → Correct electronic expansion valve connector.</p> <p>YES → Defective outdoor unit control (or main) PCB → Replace. (Defective 63H1 input circuit)</p> <p>If any anomaly exists on the electronic expansion valve connector connection, the power source must be reset.</p> <p>On operation of 63H1</p> <p>1. During cooling</p> <ul style="list-style-type: none"> • Is the outdoor fan motor running? • Isn't any short-circuit of air on the outdoor unit? • Are sufficient return air/supply air space secured? <p>2. During heating</p> <ul style="list-style-type: none"> • Isn't the indoor heat exchanger temperature sensor disconnected from the sensor casing? • Isn't the filter clogged? <p>* Under the condition of overcharging refrigerant, 63H1 may activate due to delay of starting the preventive control by compressor speed control, because detected heat exchanger temperature, which conducts compressor speed control, becomes lower than normal condition due to excess sub-cooling degree.</p>	

Note: In the protective control range for compressor startup (initial startup after power ON), even if 63H1 is activated only once (63H1 turns OFF), immediately the error is displayed.

Error code Remote control: E41	LED	Green	Red	Content Power transistor overheat
	Indoor control PCB	Keeps flashing	Stays OFF	
	Outdoor control PCB	Keeps flashing	1-time flash	
	Outdoor inverter PCB	Yellow LED 6-time flash		

1. Applicable model

2. Error detection method

When less than DC14V of the output voltage is detected between ② and ③ on CNI3, E41 is displayed.
(See "Note" mentioned below.)

3. Condition of error displayed

Seme as above.

4. Presumable cause

- Inverter PCB anomaly
- Outdoor fan motor anomaly
- Outdoor unit control PCB anomaly
- Noise filter PCB anomaly

5. Troubleshooting

Diagnosis	Countermeasure
<p>• Single phase models (FDC71-140VNX-W)</p> <pre> graph TD Q1{Is DC15V detected between ② and ③ on CNI3? (1)(2)} Q2{Is DC15V detected after disconnecting outdoor fan motor? (1)} Q1 -- YES --> C1[Replace inverter PCB . If not solved, replace noise filter PCB as well.] Q1 -- NO --> N1[Note(1) Under anomalous conditions, the voltage becomes less than DC14V.] N1 --> Q2 Q2 -- YES --> C2[Replace outdoor fan motor.] Q2 -- NO --> C3[Replace outdoor unit control PCB . If not solved, replace inverter PCB as well.] </pre> <p>Note(2) How to check the voltage between ② and ③ of CNI3? ⇒See E51</p> <p>• 3 phase models (FDC100-140VSX-W) E41⇒Replace inverter PCB.</p>	<p>Replace inverter PCB . If not solved, replace noise filter PCB as well.</p> <p>Replace outdoor fan motor.</p> <p>Replace outdoor unit control PCB . If not solved, replace inverter PCB as well.</p>

Note: The "Single phase models" of inverter PAC have no function to output the signal for the power transistor overheat. However since the power source for the power transistor and the outdoor fan motor is in the same line, when the anomaly of the outdoor fan motor occurs, E41 is displayed.

Error code Remote control: E42	LED	Green	Red	Content Current cut (1/2)
	Indoor control PCB	Keeps flashing	Stays OFF	
	Outdoor control PCB	Keeps flashing	1-time flash	
	Outdoor inverter PCB	Yellow LED 1-time flash		

1. Applicable model

2. Error detection method

In order to prevent from overcurrent of inverter, if the current exceeds the specifications, it makes the compressor stopping.

3. Condition of error displayed

- If the output current of inverter exceeds the specifications, it makes the compressor stopping.
- After 3-minute delay, the compressor restarts, but if this anomaly occurs 4 times within 30 minutes after the initial detection.

4. Presumable cause

- The service valves closed
- Faulty power source
- Insufficient refrigerant amount
- Faulty compressor
- Faulty power transistor module

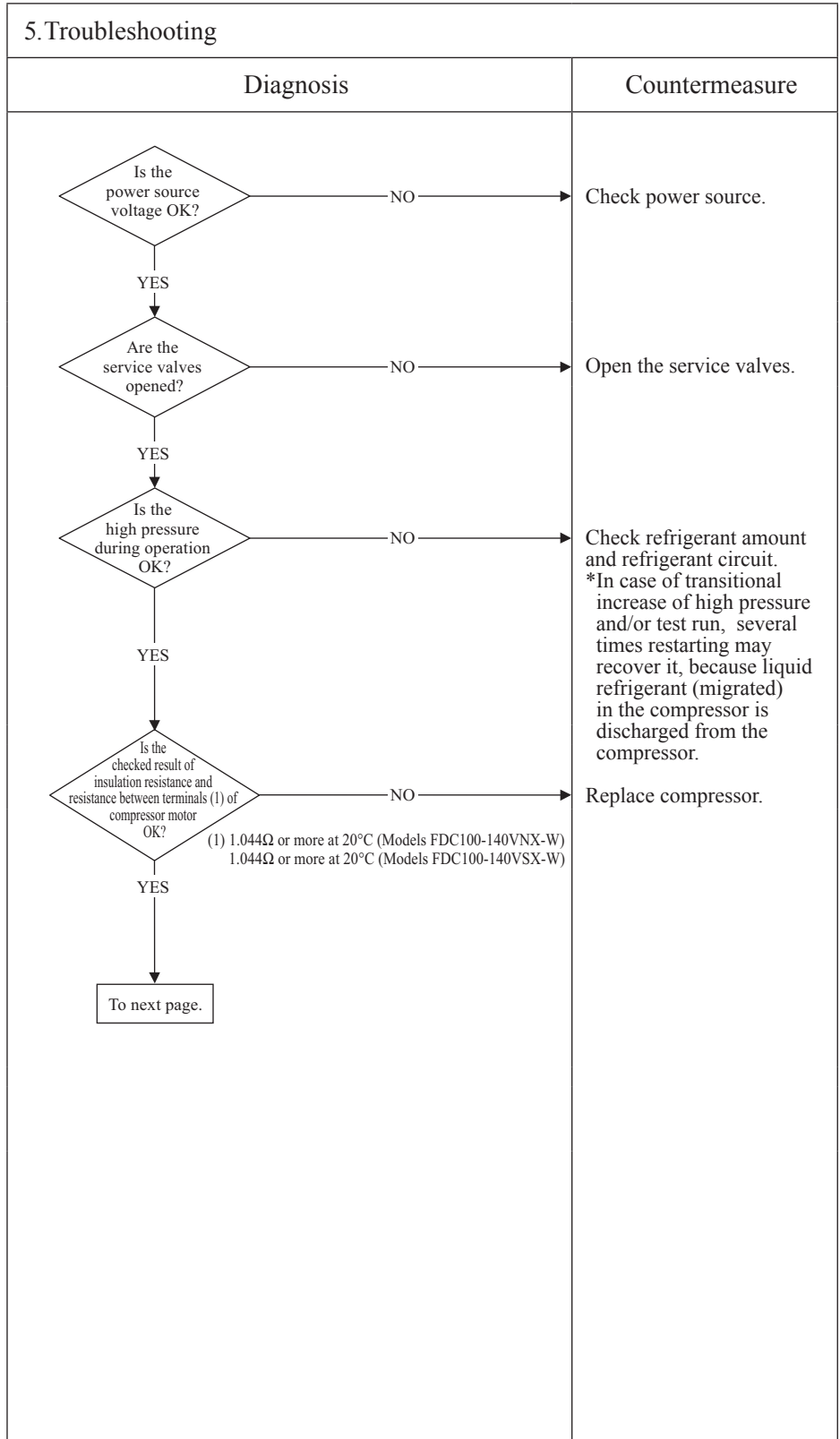

Note:

Error code Remote control: E42	LED	Green	Red	Content Current cut (2/2)
	Indoor	Keeps flashing	Stays OFF	
	Outdoor control PCB	Keeps flashing	1-time flash	
	Outdoor inverter PCB	Yellow LED 1-time flash		

1. Applicable model

2. Error detection method

In order to prevent from overcurrent of inverter, if the current exceeds the specifications, it makes the compressor stopping.

3. Condition of error displayed

- If the output current of inverter exceeds the specifications, it makes the compressor stopping.
- After 3-minute delay, the compressor restarts, but if this anomaly occurs 4 times within 30 minutes after the initial detection.

4. Presumable cause

- Defective inverter (or outdoor unit main) PCB
- Faulty power source
- Insufficient refrigerant amount
- Faulty compressor
- Faulty power transistor module

5. Troubleshooting

Diagnosis	Countermeasure
<p>From previous page</p> <p>Is the checked result of power transistor module OK?</p> <p>NO → Defective inverter (or outdoor unit main) PCB → Replace.</p> <p>YES</p> <div style="border: 1px dashed black; padding: 5px;"> <ul style="list-style-type: none"> • Is the space for installation of indoor and/or outdoor unit enough? • Is there any short-circuit of air on indoor and/or outdoor unit? • At cooling, does the outdoor fan motor run? Are the service valves fully opened? Is the filter clogged? • At heating, does the indoor fan motor run? Are the service valves fully opened? Is the filter clogged? • Is there any liquid flooding? Is the superheat within normal range? Is the low pressure sensor and suction pipe temperature sensor normal? • Is there any anomalous sound on the compressor? </div> <p>YES</p> <p>After resetting power for several times does it become normal?</p> <p>NO → Defective inverter (or outdoor unit main) PCB → Replace.</p> <p>YES</p> <p>Temporary noise may cause of anomaly. If noise source can be found, take countermeasure.</p>	

Note:

Error code Remote control: E45	LED	Green	Red	Content Communication error between inverter PCB and outdoor unit control PCB
	Indoor control PCB	Keeps flashing	Stays OFF	
	Outdoor control PCB	Keeps flashing	1-time flash	
	Outdoor inverter PCB	Yellow LED Keeps flashing		

1. Applicable model
All models

2. Error detection method
When the communication between inverter PCB and outdoor unit control PCB is not established.

3. Condition of error displayed
Same as above.

4. Presumable cause
<ul style="list-style-type: none"> • Inverter PCB anomaly • Anomalous connection of connector between the outdoor unit control PCB and inverter PCB • Outdoor unit control PCB anomaly • Outdoor fan motor anomaly

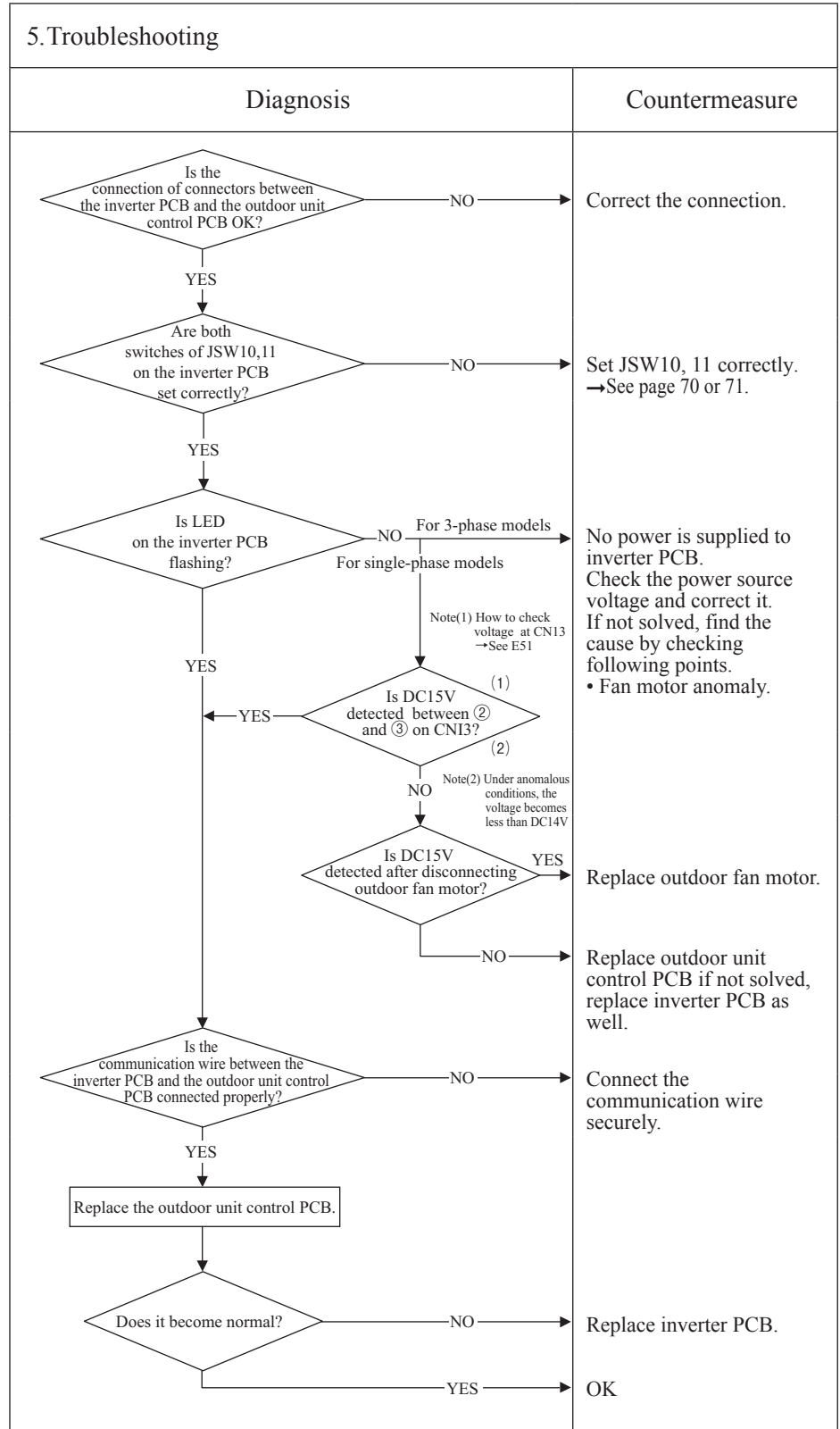

Note:

Error code Remote control: E48	LED	Green	Red	Content Outdoor fan motor anomaly
	Indoor control PCB	Keeps flashing	Stays OFF	
	Outdoor control PCB	Keeps flashing	1-time flash	
	Outdoor inverter PCB	Yellow LED Keeps flashing		

1.Applicable model

2. Error detection method
Detected by rotation speed of outdoor fan motor

3. Condition of error displayed
When actual rotation speed of outdoor fan motor (FMo1, 2) drops to 100min⁻¹ or lower for 30 seconds continuously, the compressor and the outdoor fan motor stop. After 3-minute delay, it starts again automatically, but if this anomaly occurs 5 times within 60 minutes after the initial detection.

- 4. Presumable cause**
- Defective outdoor unit control PCB
 - Foreign material at rotational area of fan propeller
 - Defective fan motor
 - Dust on outdoor unit control PCB
 - Blow fuse
 - External noise, surge

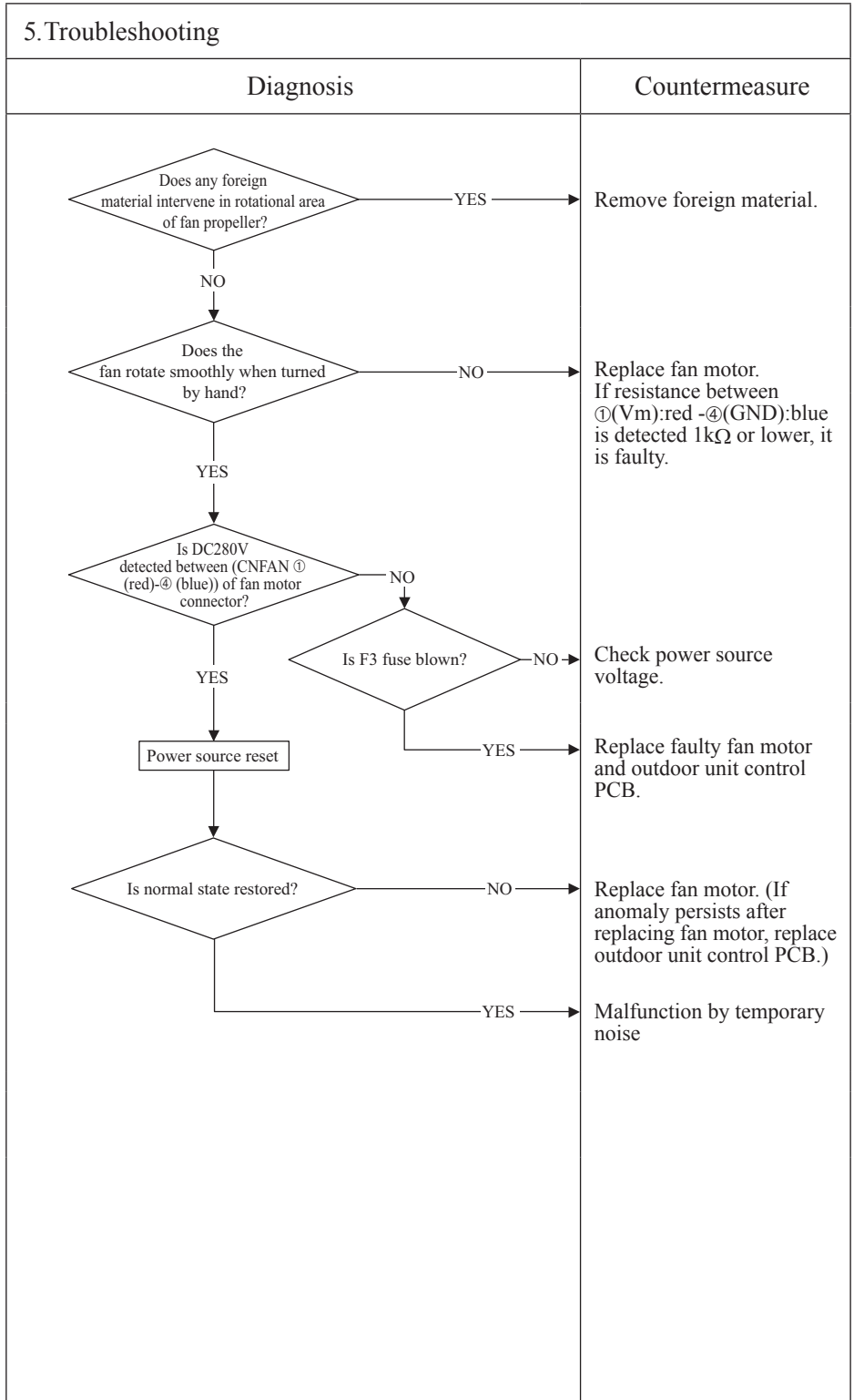

Note: When E48 error occurs, in almost cases F3 fuse (2A) on the outdoor unit control PCB is blown. There are a lot of cases that fuse is blown and E48 occurs due to defective fan motor. And even though only the outdoor unit control PCB (or fuse) is replaced, another trouble (*1) could occur. Therefore when fuse is blown, check whether the fan motor is OK or not.
After confirming the fan motor normal, check by power ON. (Don't power ON without confirming the fan motor normal.)
*1 The error which does not seem to relate E48 may occur like as “”, Stay OFF of LED on outdoor unit control PCB, inverter communication error (E45) and etc.

Error code Remote control: E49	LED	Green	Red	Content Low pressure error or low pressure sensor anomaly (1/2)
	Indoor control PCB	Keeps flashing	Stays OFF	
	Outdoor control PCB	Keeps flashing	1-time flash	
	Outdoor inverter PCB	Yellow LED Keeps flashing		

1. Applicable model

2. Error detection method
Detected by low pressure drop and suction superheat

3. Condition of error displayed

- ① When the low pressure sensor detects 0.079MPa or lower for 15 seconds continuously, compressor stops and it restarts automatically after 3-minute delay. And if this anomaly occurs 3 times within 60 minutes.
- ② 10 minutes after the compressor starts, if the low pressure sensor detects 0.15MPa or lower for 60 seconds continuously and compressor suction superheat is detected 30degC or higher for 60 seconds continuously. And if this anomaly occurs 3 times within 60 minutes.
- ③ If low pressure sensor detects 0.079MPa or lower for 5 minutes continuously (including the compressor stop status).

4. Presumable cause

- Defective outdoor unit control PCB
- Defective low pressure sensor connector
- Defective low pressure sensor
- Defective suction pipe temperature sensor connector
- Defective suction pipe temperature sensor

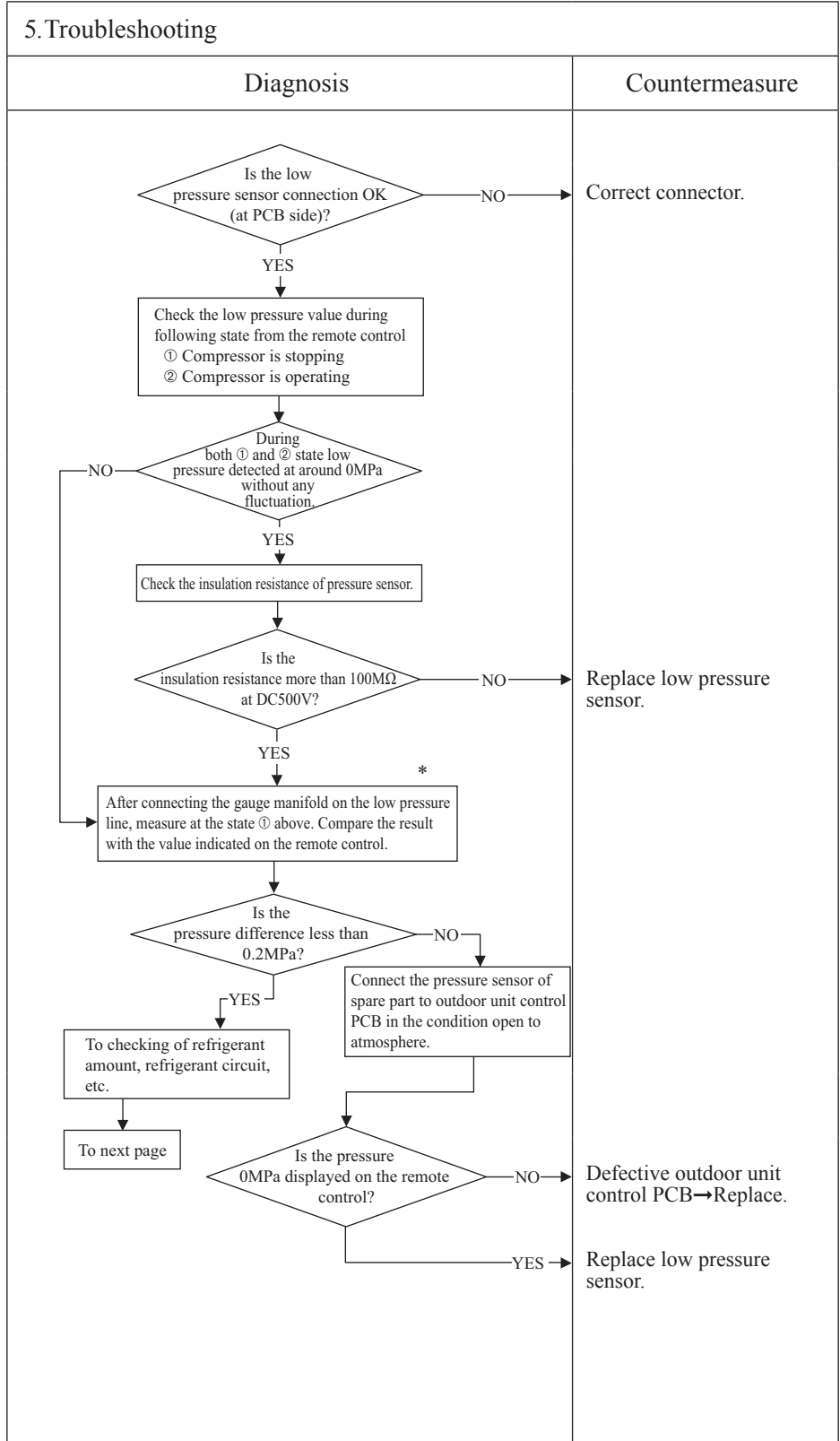

Note: * Connect the gauge manifold to the service valve check joint during cooling, or connect it to the check joint at internal piping of outdoor unit during heating.

Error code Remote control: E49	LED	Green	Red	Content Low pressure error or low pressure sensor anomaly (2/2)
	Indoor control PCB	Keeps flashing	Stays OFF	
	Outdoor control PCB	Keeps flashing	1-time flash	
	Outdoor inverter PCB	Yellow LED Keeps flashing		

1.Applicable model

2.Error detection method

3.Condition of error displayed

4.Presumable cause

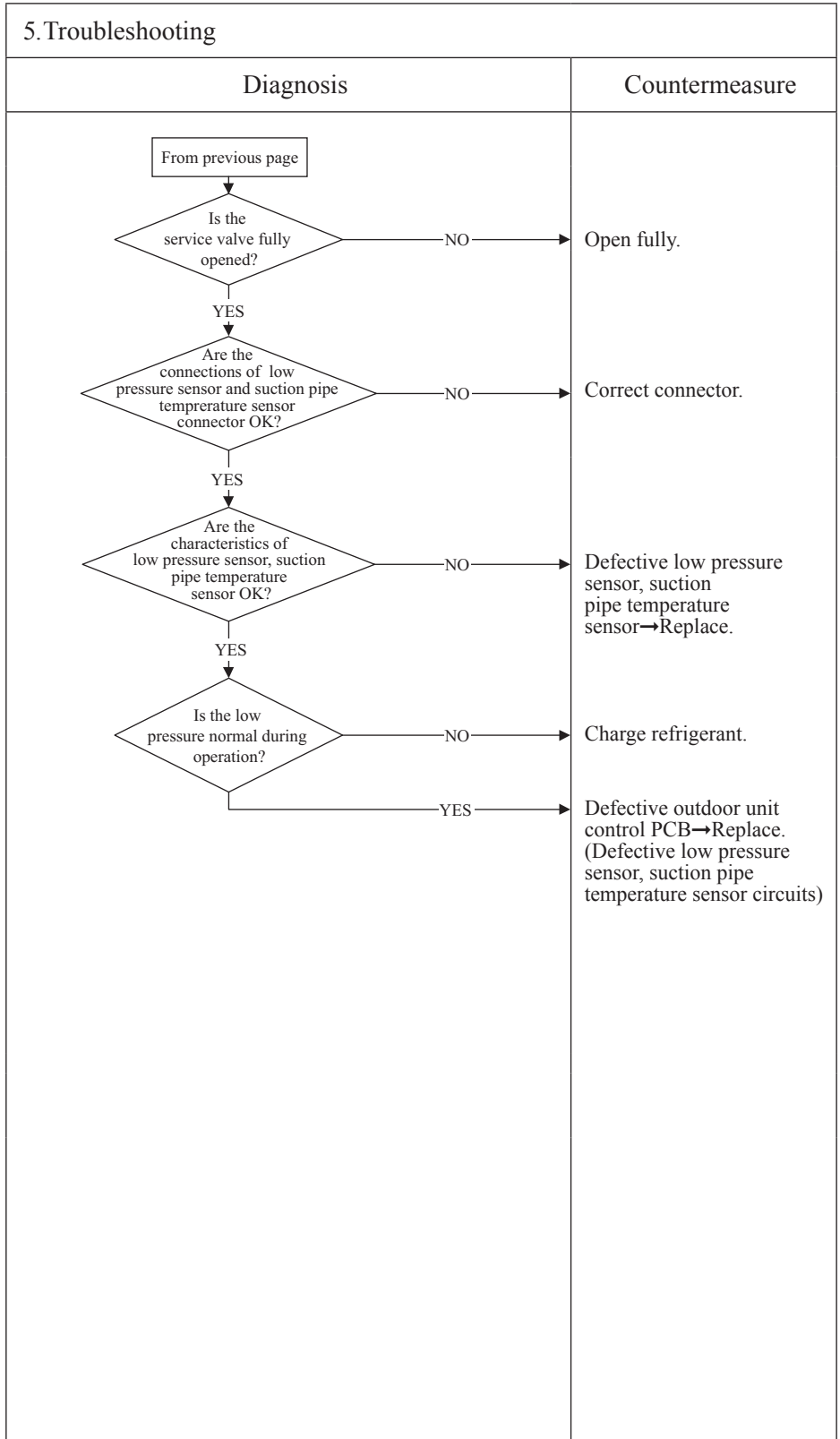

Note:

Error code Remote control: E51	LED	Green	Red	Content Inverter and fan motor anomaly
	Indoor control PCB	Keeps flashing	Stays OFF	
	Outdoor control PCB	Keeps flashing	1-time flash	
	Outdoor inverter PCB	Yellow LED 6-time flash		

1. Applicable model

2. Error detection method

When power transistor anomaly is detected for 15 minutes continuously

3. Condition of error displayed

Same as above

4. Presumable cause

- Outdoor fan motor anomaly
- Inverter PCB anomaly
- Outdoor unit control (or main) PCB anomaly

5. Troubleshooting

Diagnosis	Countermeasure
<p>• Models FDC100-140VNX-W</p> <pre> graph TD Q1{Is DC15V detected between ② and ③ on CNI3? (1)(2)} Q2{Is DC15V detected after disconnecting outdoor fan motor? (1)} Q1 -- YES --> C1[Replace inverter PCB. If not solved, replace noise filter PCB as well.] Q1 -- NO --> Note1[Note(1) Under anomalous conditions, the voltage becomes less than DC14V.] Note1 --> Q2 Q2 -- YES --> C2[Replace outdoor fan motor.] Q2 -- NO --> C3[Replace outdoor unit control PCB. If not solved, replace inverter PCB as well.] </pre> <p>• Models FDC100-140VSX-W Replace immediately the inverter PCB and the power transistor.</p> <p>Note(2) How to check the voltage between ② and ③ of CNI3</p> <p>② : DC15V (+) ③ : GND (-)</p>	

Note:

Error code Remote control: E53	LED	Green	Red	Content
	Indoor control PCB	Keeps flashing	Stays OFF	
	Outdoor control PCB	Keeps flashing	1-time flash	
	Outdoor inverter PCB	Yellow LED Keeps flashing		

Suction pipe temperature sensor anomaly

<p>1.Applicable model</p>	<p>5.Troubleshooting</p>	
<p>2. Error detection method</p> <p>When the suction pipe temperature sensor detects anomalously low temperature</p>	<p>Diagnosis</p>	<p>Countermeasure</p>
<p>3. Condition of error displayed</p> <p>If the temperature sensor detects -50°C or lower for 5 seconds continuously within 10 minutes to 10 minutes 20 seconds after compressor ON, the compressor stops. When the compressor is restarted automatically after 3-minute delay, if this anomaly occurs 3 times within 40 minutes.</p>		<p>Correct connection of suction pipe temperature sensor connector.</p> <p>Defective suction pipe temperature sensor → Replace.</p> <p>Defective outdoor unit control PCB → Replace. (Defective suction pipe temperature sensor input circuit)</p>
<p>4. Presumable cause</p> <ul style="list-style-type: none"> • Defective suction pipe temperature sensor connection • Defective suction pipe temperature sensor • Defective outdoor unit control PCB 	<p>Temperature-resistance characteristics</p>	

Note:

Error code Remote control: E54	LED	Green	Red	Content Low pressure sensor anomaly
	Indoor control PCB	Keeps flashing	Stays OFF	
	Outdoor control PCB	Keeps flashing	1-time flash	
	Outdoor inverter PCB	Yellow LED Keeps flashing		

1. Applicable model

2. Error detection method

When anomalous voltage (pressure) is detected

3. Condition of error displayed

If the pressure sensor detects DC0V or lower and DC4.0V or higher for 5 seconds continuously within 2 minutes to 2 minutes 20 seconds after compressor ON, the compressor stops. When the compressor is restarted automatically after 3-minute delay, if this anomaly occurs 3 times within 40 minutes.

4. Presumable cause

- Defective low pressure sensor connection
- Defective low pressure sensor
- Defective outdoor unit control PCB
- Improper amount of refrigerant
- Anomalous refrigeration circuit

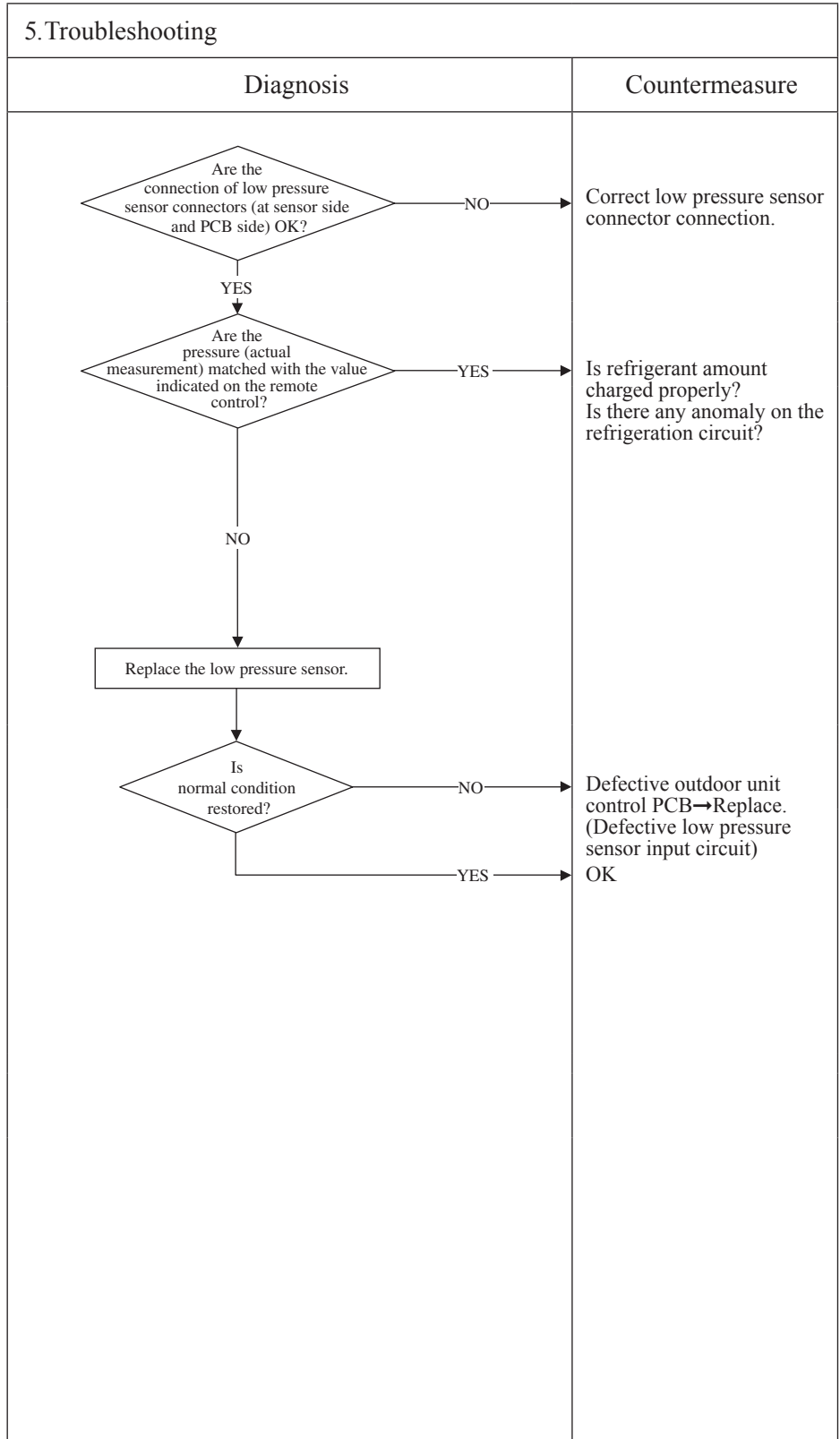

Note:

Error code Remote control: E57	LED	Green	Red	Content Insufficient refrigerant amount or detection of service valve closure
	Indoor control PCB	Keeps flashing	Stays OFF	
	Outdoor control PCB	Keeps flashing	1-time flash	
	Outdoor inverter PCB	Yellow LED Keeps flashing		

1. Applicable model

2. Error detection method

- Judge insufficient refrigerant amount by detecting the temperature difference between indoor heat exchanger (Thi-R) and indoor return air (Thi-A).
- It detects at initial startup in cooling or dehumidifying mode after power ON.

3. Condition of error displayed

Anomalous stop at initial detection

4. Presumable cause

- Defective indoor heat exchanger temperature sensor
- Defective indoor return air temperature sensor
- Defective indoor unit control PCB
- Insufficient refrigerant amount

5. Troubleshooting

Diagnosis	Countermeasure
<p>Is the service valve fully opened?</p> <p>NO →</p> <p>YES ↓</p> <p>Are the connections of indoor heat exchanger and/or return air temperature sensor connectors OK?</p> <p>NO →</p> <p>YES ↓</p> <p>For the characteristics of indoor heat exchanger, return air temperature sensor, see the following graph.</p> <p>Are the characteristics of indoor heat exchanger and/or return air temperature sensor OK?</p> <p>NO →</p> <p>YES ↓</p> <p>Is the low pressure during operation normal?</p> <p>NO →</p> <p>YES →</p>	<p>Open fully.</p> <p>Correct indoor heat exchanger, return air temperature sensor connector connections.</p> <p>Defective indoor heat exchanger, return air temperature sensor → Replace.</p> <p>Charge refrigerant.</p> <p>Defective indoor unit control PCB → Replace. (Defective indoor heat exchanger, return air temperature sensor input circuits)</p>

Indoor heat exchanger, return air temperature sensor
Temperature-resistance characteristics

Temperature (°C)	Temperature sensor resistance (kΩ)
0	~16
10	~11
20	~7
25	5
30	~4
40	~3
50	~2

Note: Insufficient refrigerant amount preventive control makes compressor stopped, if it judges insufficient refrigerant amount by detecting the temperature difference between indoor heat exchanger (Thi-R) and return air temperature (Thi-A) for 5 minutes after compressor ON in cooling or dehumidifying mode and for 9 minutes after compressor ON in heating mode. [in cooling mode: (Thi-A)-(Thi-R)<4degC, in heating mode: (Thi-R)-(Thi-A)<4degC]

Error code Remote control: E59	LED	Green	Red	Content Compressor startup failure (1/2)
	Indoor control PCB	Keeps flashing	Stays OFF	
	Outdoor control PCB	Keeps flashing	5-time flash	
	Outdoor inverter PCB	Yellow LED		
		Stays OFF		

1. Applicable model
All models

2. Error detection method
When it fails to change over to the operation for rotor position detection of compressor motor

3. Condition of error displayed
If the compressor fails to startup for 20 times (10 patterns × 2 times) continuously.

- 4. Presumable cause**
- Outdoor fan motor anomaly
 - Outdoor unit control PCB anomaly
 - Inverter PCB anomaly
 - Anomalous power source voltage
 - Insufficient or excessive refrigerant amount
 - Faulty component for refrigerant circuit
 - Compressor anomaly (Motor or bearing)

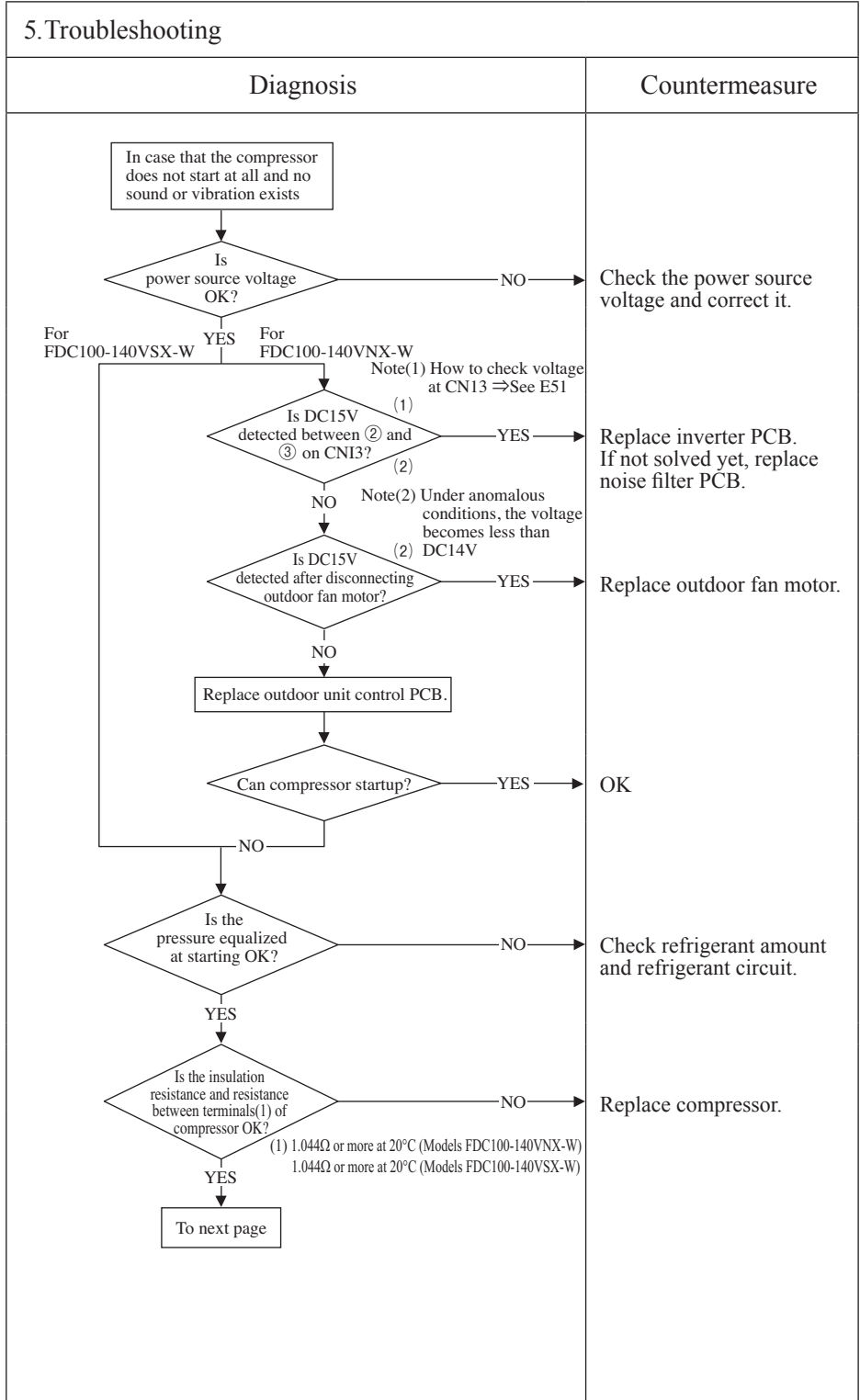

Note: Insulation resistance

- The unit is left for long period without power source or soon after installation, insulation resistance may decrease to several MΩ or lower due to the liquid refrigerant migrated in the refrigerant oil in compressor. If the electric leakage breaker is activated due to low insulation resistance, check followings.
- ① Check whether the insulation resistance can recover or not, after 6 hours has passed since power ON.
(By energize the crankcase heater, liquid refrigerant migrated in the refrigerant oil in compressor can be evaporated)
- ② Check whether the electric leakage breaker conforms to high-harmonic specifications.
(As inverter PAC units has inverter, in order to prevent from improper operation, be sure to use the breaker of high-harmonic type)

Error code Remote control: E59	LED	Green	Red	Content Compressor startup failure (2/2)
	Indoor control PCB	Keeps flashing	Stays OFF	
	Outdoor control PCB	Keeps flashing	5-time flash	
	Outdoor inverter PCB	Yellow LED Stays OFF		

1. Applicable model

2. Error detection method

3. Condition of error displayed

4. Presumable cause

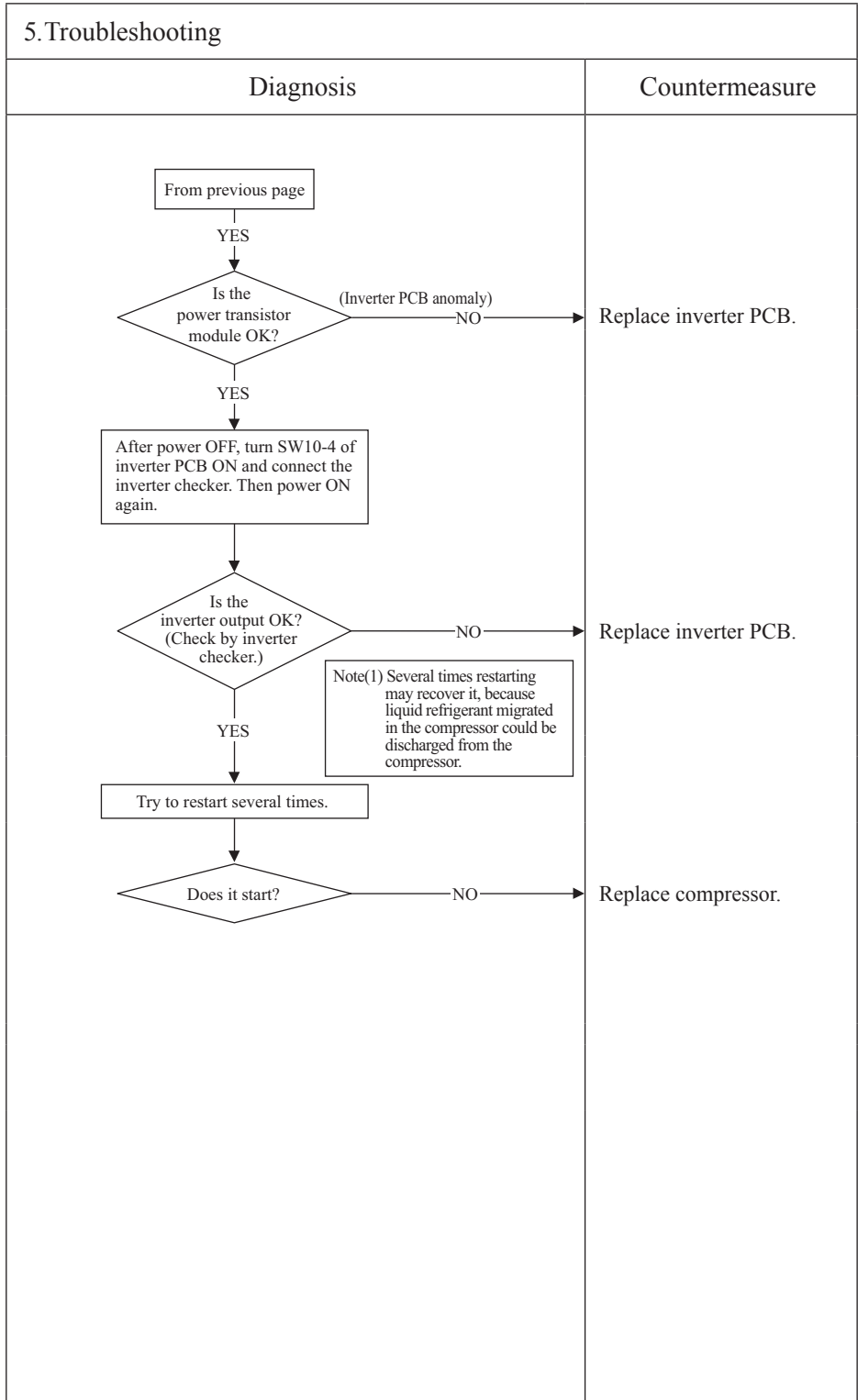

Note:

(b) SRK series

Error code Remote control: None	Indoor display	RUN light —	TIMER light —	Content Operates but does not cool
	Outdoor unit control PCB	Green LED	Red LED	
		Keeps flashing	Stays OFF	

1. Applicable model
All models
2. Error detection method
3. Condition of error displayed
4. Presumable cause
<ul style="list-style-type: none"> Poor compression of compressor Faulty expansion valve operation

5. Troubleshooting				
<table border="1"> <thead> <tr> <th>Diagnosis</th> <th>Countermeasure</th> </tr> </thead> <tbody> <tr> <td> <p>Check the indoor unit fan operation. Check the temperature difference between return and supply air.</p> <p>Is the temperature difference between return and supply air 10-20°C at cooling?</p> <p>NO → Is the compressor operating?</p> <p>NO → Mistake in model selection. Calculate heat load once more.</p> <p>NO → "WAIT" message is displayed (for 3 seconds) when performing cooling, defrost and heating operations from the remote control.</p> <p>NO → Is the compressor rotation speed low?</p> <p>NO →</p> <p>YES → Check which control "Determination control of compressor rotation speed" or "Protective control by controlling compressor rotation speed" is appropriate to this phenomenon.</p> <p>YES → Are the temperature conditions of room and outdoor air close to the rated conditions? (1)</p> <p>NO → The unit is operating normally but is operating under the control for protecting compressor or other respective parts.</p> <p>Note (1) Outdoor: 35°C, Indoor: 27°C</p> </td> <td> <p>It is normal. (This unit is designed to start in the soft start mode by detecting the under dome temperature of compressor when it restart after power reset.)</p> <p>It is necessary to replace to higher capacity one or two install additional unit.</p> <p>Compressor refrigerant oil protection control at starting is activated. For the contents of control, refer to the compressor start control of the microcomputer control functions.</p> <p>Compressor may be stopped by the error detection control. For the contents of control, refer to anomalous stop control by controlling compressor rotation speed of microcomputer control functions.</p> <p>Inspect the followings.</p> <ul style="list-style-type: none"> Minor clogging of filter Minor clogging of heat exchanger Minor short-circuit Minor shortage of refrigerant amount Poor compression of compressor <p>Considering appropriate operation control, check suspicious points. Inspect the followings for reference.</p> <ul style="list-style-type: none"> Major clogging of filter Major clogging of heat exchanger Major short-circuit Major shortage of refrigerant amount Compressor protection ON Indoor fan tap Valid setting of silent mode </td> </tr> </tbody> </table>	Diagnosis	Countermeasure	<p>Check the indoor unit fan operation. Check the temperature difference between return and supply air.</p> <p>Is the temperature difference between return and supply air 10-20°C at cooling?</p> <p>NO → Is the compressor operating?</p> <p>NO → Mistake in model selection. Calculate heat load once more.</p> <p>NO → "WAIT" message is displayed (for 3 seconds) when performing cooling, defrost and heating operations from the remote control.</p> <p>NO → Is the compressor rotation speed low?</p> <p>NO →</p> <p>YES → Check which control "Determination control of compressor rotation speed" or "Protective control by controlling compressor rotation speed" is appropriate to this phenomenon.</p> <p>YES → Are the temperature conditions of room and outdoor air close to the rated conditions? (1)</p> <p>NO → The unit is operating normally but is operating under the control for protecting compressor or other respective parts.</p> <p>Note (1) Outdoor: 35°C, Indoor: 27°C</p>	<p>It is normal. (This unit is designed to start in the soft start mode by detecting the under dome temperature of compressor when it restart after power reset.)</p> <p>It is necessary to replace to higher capacity one or two install additional unit.</p> <p>Compressor refrigerant oil protection control at starting is activated. For the contents of control, refer to the compressor start control of the microcomputer control functions.</p> <p>Compressor may be stopped by the error detection control. For the contents of control, refer to anomalous stop control by controlling compressor rotation speed of microcomputer control functions.</p> <p>Inspect the followings.</p> <ul style="list-style-type: none"> Minor clogging of filter Minor clogging of heat exchanger Minor short-circuit Minor shortage of refrigerant amount Poor compression of compressor <p>Considering appropriate operation control, check suspicious points. Inspect the followings for reference.</p> <ul style="list-style-type: none"> Major clogging of filter Major clogging of heat exchanger Major short-circuit Major shortage of refrigerant amount Compressor protection ON Indoor fan tap Valid setting of silent mode
Diagnosis	Countermeasure			
<p>Check the indoor unit fan operation. Check the temperature difference between return and supply air.</p> <p>Is the temperature difference between return and supply air 10-20°C at cooling?</p> <p>NO → Is the compressor operating?</p> <p>NO → Mistake in model selection. Calculate heat load once more.</p> <p>NO → "WAIT" message is displayed (for 3 seconds) when performing cooling, defrost and heating operations from the remote control.</p> <p>NO → Is the compressor rotation speed low?</p> <p>NO →</p> <p>YES → Check which control "Determination control of compressor rotation speed" or "Protective control by controlling compressor rotation speed" is appropriate to this phenomenon.</p> <p>YES → Are the temperature conditions of room and outdoor air close to the rated conditions? (1)</p> <p>NO → The unit is operating normally but is operating under the control for protecting compressor or other respective parts.</p> <p>Note (1) Outdoor: 35°C, Indoor: 27°C</p>	<p>It is normal. (This unit is designed to start in the soft start mode by detecting the under dome temperature of compressor when it restart after power reset.)</p> <p>It is necessary to replace to higher capacity one or two install additional unit.</p> <p>Compressor refrigerant oil protection control at starting is activated. For the contents of control, refer to the compressor start control of the microcomputer control functions.</p> <p>Compressor may be stopped by the error detection control. For the contents of control, refer to anomalous stop control by controlling compressor rotation speed of microcomputer control functions.</p> <p>Inspect the followings.</p> <ul style="list-style-type: none"> Minor clogging of filter Minor clogging of heat exchanger Minor short-circuit Minor shortage of refrigerant amount Poor compression of compressor <p>Considering appropriate operation control, check suspicious points. Inspect the followings for reference.</p> <ul style="list-style-type: none"> Major clogging of filter Major clogging of heat exchanger Major short-circuit Major shortage of refrigerant amount Compressor protection ON Indoor fan tap Valid setting of silent mode 			

Note:

Error code Remote control: None	Indoor display	RUN light -	TIMER light -	Content Operates but does not heat
	Outdoor unit control PCB	Green LED	Red LED	
		Keeps flashing	Stays OFF	

1. Applicable model
All models
2. Error detection method
3. Condition of error displayed
4. Presumable cause
<ul style="list-style-type: none"> Faulty 4-way valve operation Poor compression of compressor Faulty expansion valve operation

5. Troubleshooting	
Diagnosis	Countermeasure
<p>Check the indoor unit fan operation. Check the temperature difference between return and supply air.</p> <pre> graph TD Start[Check indoor unit fan operation and temperature difference] --> D1{Is the temperature difference between return and supply air 10-30°C at heating?} D1 -- YES --> D2{Does the heat load increase after installation?} D1 -- NO --> D3{Is the compressor operating?} D2 -- YES --> Box1[Mistake in model selection. Calculate heat load once again.] D2 -- NO --> D4{Compressor refrigerant oil protection control message is displayed for 3 seconds?} Box1 --> D4 D3 -- NO --> D4 D3 -- YES --> D5{Is the compressor rotation speed low?} D4 -- YES --> Box2[Compressor refrigerant oil protection control... refer to microcomputer control functions.] D4 -- NO --> D5 D5 -- NO --> Box3[Inspect the followings: Minor clogging of filter, Minor clogging of heat exchanger, Minor short-circuit, Minor shortage of refrigerant amount, Poor compression of compressor.] D5 -- YES --> Box4[Check which control "Determination control of compressor rotation speed" or "Protective control by controlling compressor rotation speed" is appropriate to this phenomenon.] Box4 --> D6{Are the temperature conditions of room and outdoor air close to the rated conditions? (1)} D6 -- YES --> Box5[Considering appropriate operation control, check suspicious points. Inspect the followings for reference: Major clogging of filter, Major clogging of heat exchanger, Major short-circuit, Major shortage of refrigerant amount, Compressor protection ON, Indoor fan tap, Valid setting of silent mode.] D6 -- NO --> Box6[The unit is operating normally but is operating under the control for protecting compressor or other respective parts.] </pre>	
<p>It is normal. (This unit is designed to start in the soft start mode by detecting the under dome temperature of compressor when it restart after power reset.)</p> <p>It is necessary to replace to higher capacity one or two install additional unit.</p> <p>Compressor refrigerant oil protection control at starting is activated. For the contents of control, refer to the compressor start control of the microcomputer control functions.</p> <p>Compressor may be stopped by the error detection control. For the contents of control, refer to anomalous stop control by controlling compressor rotation speed of microcomputer control functions.</p> <p>Inspect the followings.</p> <ul style="list-style-type: none"> Minor clogging of filter Minor clogging of heat exchanger Minor short-circuit Minor shortage of refrigerant amount Poor compression of compressor <p>Considering appropriate operation control, check suspicious points. Inspect the followings for reference.</p> <ul style="list-style-type: none"> Major clogging of filter Major clogging of heat exchanger Major short-circuit Major shortage of refrigerant amount Compressor protection ON Indoor fan tap Valid setting of silent mode 	

Note:

Error code Remote control: None	Indoor display	RUN light -	TIMER light -	Content Earth leakage breaker activated
	Outdoor unit control PCB	Green LED Stays OFF	Red LED Stays OFF	

<p>1. Applicable model</p> <p>All models</p>	<p>5. Troubleshooting</p> <table border="1" style="width: 100%;"> <thead> <tr> <th style="width: 50%;">Diagnosis</th> <th style="width: 50%;">Countermeasure</th> </tr> </thead> <tbody> <tr> <td style="text-align: center;"> </td> <td style="vertical-align: top;"> <p>Replace compressor.*</p> <p>Secure insulation resistance.</p> </td> </tr> <tr> <td colspan="2" style="vertical-align: top;"> <p>Check of the outdoor unit grounding wire/earth leakage breaker</p> <p>① Run an independent grounding wire from the grounding screw of outdoor unit to the grounding terminal on the distribution panel. (Do not connect to another grounding wire.)</p> <p>② In order to prevent malfunction of the earth leakage breaker itself, confirm that it is conformed to higher harmonic regulation.</p> <p>* Insulation resistance of compressor</p> <ul style="list-style-type: none"> Immediately after installation or when the unit has been left for long time without power source, the insulation resistance may drop to a few MΩ because of refrigerant migrated in the compressor. <p>When the earth breaker is activated at lower insulation resistance, check the following points.</p> <p>① 6 hours after power ON, check if the insulation resistance recovers to normal.</p> <p>When power ON, crankcase heater heat up compressor and evaporate the refrigerant migrated in the compressor.</p> <p>② Check if the earth leakage breaker is conformed to higher harmonic regulation or not.</p> <p>Since the unit is equipped with inverter, it is necessary to use components conformed to higher harmonic regulation in order to prevent malfunction of earth leakage breaker.</p> </td> </tr> </tbody> </table>		Diagnosis	Countermeasure		<p>Replace compressor.*</p> <p>Secure insulation resistance.</p>	<p>Check of the outdoor unit grounding wire/earth leakage breaker</p> <p>① Run an independent grounding wire from the grounding screw of outdoor unit to the grounding terminal on the distribution panel. (Do not connect to another grounding wire.)</p> <p>② In order to prevent malfunction of the earth leakage breaker itself, confirm that it is conformed to higher harmonic regulation.</p> <p>* Insulation resistance of compressor</p> <ul style="list-style-type: none"> Immediately after installation or when the unit has been left for long time without power source, the insulation resistance may drop to a few MΩ because of refrigerant migrated in the compressor. <p>When the earth breaker is activated at lower insulation resistance, check the following points.</p> <p>① 6 hours after power ON, check if the insulation resistance recovers to normal.</p> <p>When power ON, crankcase heater heat up compressor and evaporate the refrigerant migrated in the compressor.</p> <p>② Check if the earth leakage breaker is conformed to higher harmonic regulation or not.</p> <p>Since the unit is equipped with inverter, it is necessary to use components conformed to higher harmonic regulation in order to prevent malfunction of earth leakage breaker.</p>	
Diagnosis	Countermeasure							
	<p>Replace compressor.*</p> <p>Secure insulation resistance.</p>							
<p>Check of the outdoor unit grounding wire/earth leakage breaker</p> <p>① Run an independent grounding wire from the grounding screw of outdoor unit to the grounding terminal on the distribution panel. (Do not connect to another grounding wire.)</p> <p>② In order to prevent malfunction of the earth leakage breaker itself, confirm that it is conformed to higher harmonic regulation.</p> <p>* Insulation resistance of compressor</p> <ul style="list-style-type: none"> Immediately after installation or when the unit has been left for long time without power source, the insulation resistance may drop to a few MΩ because of refrigerant migrated in the compressor. <p>When the earth breaker is activated at lower insulation resistance, check the following points.</p> <p>① 6 hours after power ON, check if the insulation resistance recovers to normal.</p> <p>When power ON, crankcase heater heat up compressor and evaporate the refrigerant migrated in the compressor.</p> <p>② Check if the earth leakage breaker is conformed to higher harmonic regulation or not.</p> <p>Since the unit is equipped with inverter, it is necessary to use components conformed to higher harmonic regulation in order to prevent malfunction of earth leakage breaker.</p>								
<p>2. Error detection method</p>								
<p>3. Condition of error displayed</p>								
<p>4. Presumable cause</p> <ul style="list-style-type: none"> Defective compressor Noise 								

Note:

Error code Remote control: None	Indoor display	RUN light -	TIMER light -	Content Excessive noise/vibration (1/3)
	Outdoor unit control PCB	Green LED -	Red LED -	

1. Applicable model
All models

2. Error detection method

3. Condition of error displayed

- 4. Presumable cause**
- ① Improper installation work
 - Improper anti-vibration work at installation
 - Insufficient strength of mounting face
 - ② Defective product
 - Before/after shipping from factory
 - ③ Improper adjustment during commissioning
 - Excess/shortage of refrigerant, etc.

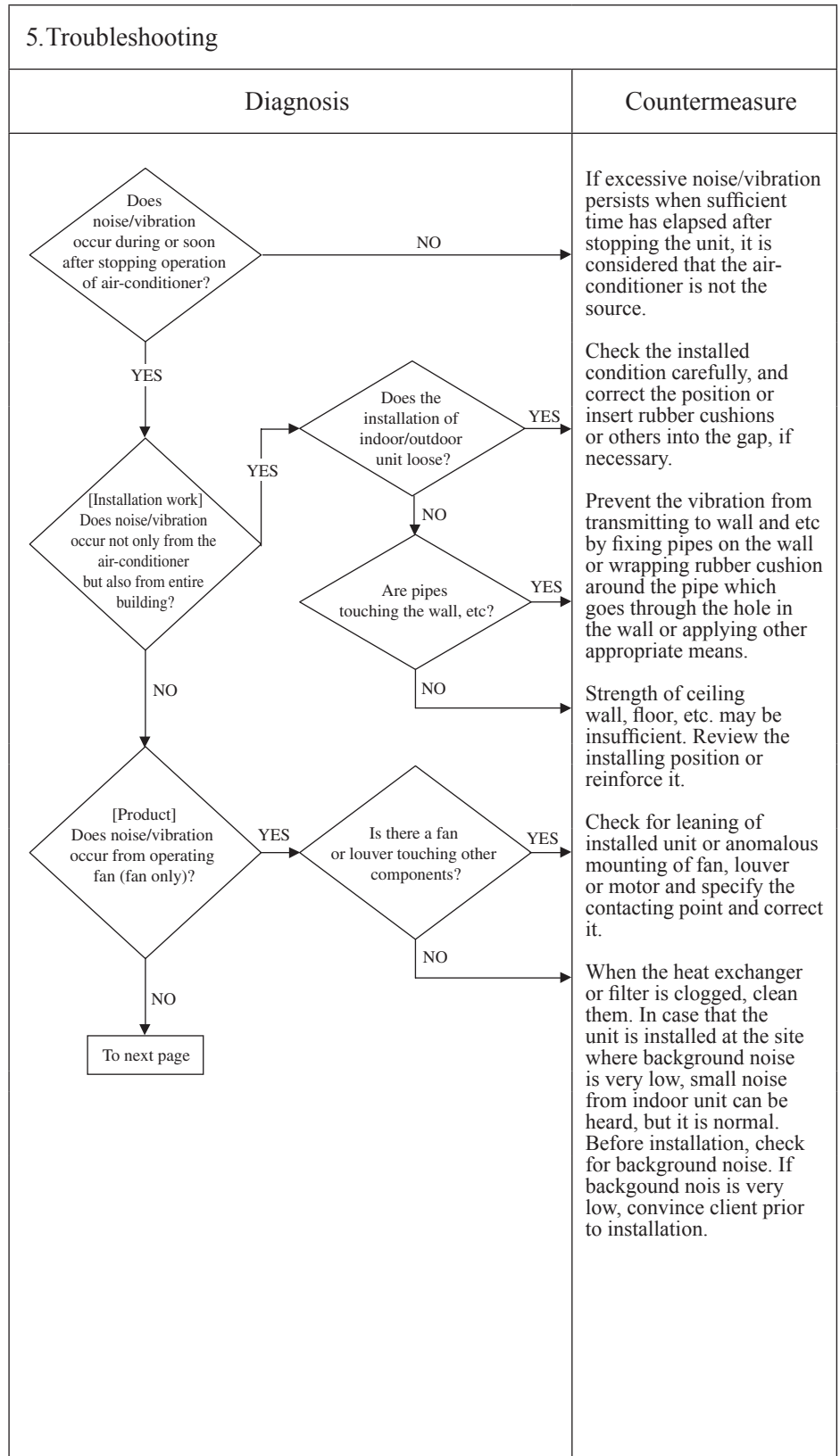

Note:

Error code Remote control: None	Indoor display	RUN light -	TIMER light -	Content Excessive noise/vibration (2/3)
	Outdoor unit control PCB	Green LED -	Red LED -	

1. Applicable model All models
2. Error detection method
3. Condition of error displayed
4. Presumable cause

5. Troubleshooting	
Diagnosis	Countermeasure
<pre> graph TD Start([From previous page]) --> D1{[Unit side] Does noise/vibration occur when the cooling/heating operation is performed normally?} D1 -- YES --> D2{Are the pipes contacting the casing?} D1 -- NO --> End1([To next page]) D2 -- YES --> C1[Rearrange the piping to avoid contact with the casing.] D2 -- NO --> D3{Is it heard continuous hissing or roaring sound?} D3 -- YES --> C2[It is noise/vibration that is generated when the refrigerant gas or liquid flow through inside of piping of air-conditioner. It is likely to occur particularly during cooling or defrost operation in the heating mode. It is normal.] D3 -- NO --> D4{Are hissing sounds heard at the startup or stopping?} D4 -- YES --> C3[The noise/vibration occurs when the refrigerant starts or stops flowing. It is normal.] D4 -- NO --> D5{Is blowing sound heard at the start/stop of defrost operation during heating?} D5 -- YES --> C4[When the defrost operation starts or stops during heating, the refrigerant flow is reversed due to switching 4-way valve. This causes a large change in pressure which produces a blowing sound. It may accompany also the hissing sounds as mentioned above. They are normal.] D5 -- NO --> D6{Is cracking noise heard during heating operation?} D6 -- YES --> C5[After the start or stop of heating operation or during defrost operation, abrupt changes in temperature cause resin parts to shrink or expand. This is normal.] D6 -- NO --> D7{Hissing noise is heard during cooling operation or after stopping.} D7 -- YES --> C6[It is the sound produced by the drain pump that discharges drain from the indoor unit. The pump continues to run for 5 minutes after stopping the cooling operation. This is normal.] D7 -- NO --> C7[Apply the damper sealant at places considered to be the sources such as the pressure reducing mechanism (expansion valve), capillary, etc.] </pre>	<p>Rearrange the piping to avoid contact with the casing.</p> <p>It is noise/vibration that is generated when the refrigerant gas or liquid flow through inside of piping of air-conditioner. It is likely to occur particularly during cooling or defrost operation in the heating mode. It is normal.</p> <p>The noise/vibration occurs when the refrigerant starts or stops flowing. It is normal.</p> <p>When the defrost operation starts or stops during heating, the refrigerant flow is reversed due to switching 4-way valve. This causes a large change in pressure which produces a blowing sound. It may accompany also the hissing sounds as mentioned above. They are normal.</p> <p>After the start or stop of heating operation or during defrost operation, abrupt changes in temperature cause resin parts to shrink or expand. This is normal.</p> <p>It is the sound produced by the drain pump that discharges drain from the indoor unit. The pump continues to run for 5 minutes after stopping the cooling operation. This is normal.</p> <p>Apply the damper sealant at places considered to be the sources such as the pressure reducing mechanism (expansion valve), capillary, etc.</p>

Note:

Error code Remote control: None	Indoor display	RUN light -	TIMER light -	Content Excessive noise/vibration (3/3)
	Outdoor unit control PCB	Green LED -	Red LED -	

<p>1. Applicable model</p> <p>All models</p>	5. Troubleshooting	
<p>2. Error detection method</p>	Diagnosis	Countermeasure
<p>3. Condition of error displayed</p>	<pre> graph TD A[From previous page] --> B{[Adjustment during commissioning] Does noise/vibration occur when the cooling/heating operation is in anomalous condition?} B -- YES --> C[Countermeasure] </pre>	
<p>4. Presumable cause</p>	<p>If insufficient cooling/heating problem happens due to anomalous operating conditions at cooling/heating, followings are suspicious.</p> <ul style="list-style-type: none"> • Overcharge of refrigerant • Insufficient charge of refrigerant • Intrusion of air, nitrogen, etc. <p>In such occasion, it is necessary to recover refrigerant, vacuum-dry and recharge refrigerant.</p> <p>* Since there could be many causes of noise/vibration, the above do not cover all. In such case, check the conditions when, where, how the noise/vibration occurs according to following check point.</p> <ul style="list-style-type: none"> • Indoor/outdoor unit • Cooling/heating/fan mode • Startup/stop/during operation • Operating condition (Indoor/outdoor air temperatures, pressure) • Time it occurred • Operation data retained by the remote control such as compressor rotation speed, heat exchanger temperature, EEV opening degree, etc. • Tone (If available, record the noise) • Any other anomalies 	

Note:

Error code Remote control: None	Indoor display	RUN light -	TIMER light -	Content <h2>Louver motor failure</h2>
	Outdoor unit control PCB	Green LED	Red LED	
		Keeps flashing	Stays OFF	

1. Applicable model
All models

2. Error detection method

3. Condition of error displayed

4. Presumable cause
<ul style="list-style-type: none"> • Defective LM • LM wire breakage • Faulty indoor unit control PCB

5. Troubleshooting	
Diagnosis	Countermeasure
<p>▲ Check at the indoor unit side.</p> <pre> graph TD Start[Operate after waiting for more than 1 minute.] --> Q1{Does the louver operate at the power on?} Q1 -- NO --> Q2{Is LM wiring broken?} Q2 -- YES --> C1[Repair wiring.] Q2 -- NO --> Q3{Is LM locked?} Q3 -- NO --> C2[Defective indoor unit control PCB → Replace.] Q3 -- YES --> C3[Replace LM.] Q1 -- YES --> Q4{Is the louver operable with the remote control?} Q4 -- YES --> C4[Normal] Q4 -- NO --> C5[Adjust LM lever and then check again.] </pre> <p style="text-align: center;">LM: louver motor</p>	

Note:

Error code Remote control: None	Indoor display	RUN light —	TIMER light —	Content Power source system error (Power source to indoor unit control PCB)
	Outdoor unit control PCB	Green LED Stays OFF	Red LED 2-time flash	

1. Applicable model
All models

2. Error detection method

3. Condition of error displayed

4. Presumable cause
<ul style="list-style-type: none"> • Misconnection or breakage of connecting wires • Blown fuse • Faulty indoor unit control PCB • Broken harness • Faulty outdoor unit control PCB (Noise filter)

5. Troubleshooting	
Diagnosis	Countermeasure
<pre> graph TD Q1{Is AC220/240V detected between 1 and 2 on the terminal block of indoor unit?} Q2{Are fuse OK (250V 3.15A)?} Q3{Is AC380/415V for 3-phase unit detected between 1, 2 and 3 on the terminal block of outdoor unit or is AC220/240V for 1-phase unit detected between 1 and 2 on the terminal block of outdoor unit?} C1[Defective outdoor unit control PCB (Noise filter) -> Replace.] C2[Misconnection or breakage of connecting wires] C3[Replace fuse.] C4[Defective indoor unit control PCB -> Replace.] Q1 -- YES --> Q2 Q1 -- NO --> Q3 Q2 -- NO --> C3 Q2 -- YES --> C4 Q3 -- YES --> C2 Q3 -- NO --> C1 </pre>	<p>Defective outdoor unit control PCB (Noise filter) → Replace.</p> <p>Misconnection or breakage of connecting wires</p> <p>Replace fuse.</p> <p>Defective indoor unit control PCB → Replace.</p>

Note:

Error code Remote control: None	Indoor display	RUN light -	TIMER light -	Content Power source system error (Power source to remote control)
	Outdoor unit control PCB	Green LED	Red LED	
		Keeps flashing	Stays OFF	

1. Applicable model
All models
2. Error detection method
3. Condition of error displayed
4. Presumable cause
<ul style="list-style-type: none"> • Remote control wire breakage/short-circuit • Defective remote control • Malfunction by noise • Broken harness • Faulty indoor unit control PCB • Faulty interface kit

5. Troubleshooting	
Diagnosis	Countermeasure
<pre> graph TD D1{Is there any loose connection of remote control wires?} -- YES --> C1[Correct. -> Insert connector securely.] D1 -- NO --> D2{Is remote control wire broken or short-circuited?} D2 -- YES --> C2[Replace wires.] D2 -- NO --> P1[Disconnect remote control wires.] P1 --> D3{Is DC15V or higher detected between X-Y of interface kit terminal block?} D3 -- YES --> C3[Replace remote control.] D3 -- NO --> P2[Disconnect connecting wires.] P2 --> D4{Is DC15V or higher detected between X-Y of indoor unit terminal block?} D4 -- YES --> C4[Replace interface kit.] D4 -- NO --> C5[Defective indoor unit control PCB -> Replace.] </pre>	

Note:

Error code Remote control: None	Indoor display	RUN light Stays OFF	TIMER light Keeps flashing	Content <h2 style="text-align: center;">Limit switch anomaly</h2>
	Outdoor unit control PCB	Green LED Keeps flashing	Red LED Stays OFF	

1. Applicable model
All models
2. Error detection method
The limit switch operates when the indoor unit is stopped.
3. Condition of error displayed
Same as above
4. Presumable cause
<ul style="list-style-type: none"> • Defective limit switch • Faulty indoor unit control PCB

5. Troubleshooting	
Diagnosis	Countermeasure
<pre> graph TD A{Is the inlet panel set correctly?} -- NO --> B[Correction, re-set] A -- YES --> C{Are limit switch OK? (1)} C -- NO --> D[Defective limit switch -> Replace.] C -- YES --> E[Defective indoor unit control PCB -> Replace. (Defective limit switch input circuit)] </pre>	
<p>Note (1) Check the operation of limit switch by checking if the error can be reset or not by pushing the limit switch by finger when the inlet panel is removed.</p>	

Note:

Error code Remote control: INSPECT I/U	Indoor display	RUN light -	TIMER light -	Content INSPECT I/U (When 1 or 2 remote controls are connected)
	Outdoor unit control PCB	Green LED	Red LED	
		Keeps flashing	2-time flash	

1. Applicable model
All models
2. Error detection method
Communication between indoor unit and remote control is disabled for more than 30 minutes after the power on.
3. Condition of error displayed
Same as above
4. Presumable cause
<ul style="list-style-type: none"> • Improper setting • Surrounding environment • Defective remote control communication circuit • Faulty interface kit PCB

5. Troubleshooting	
Diagnosis	Countermeasure
<pre> graph TD Q1{Are 2 units of remote control connected?} Q2{Is it set at the slave remote control?} Q3{Does it become normal?} Q4{Do more than one interface kit have the same address?} Q5{Are remote control wires laid along high voltage wires?} Q6{Is approx. DC20V detected between ②-③ on the interface kit terminal block?} Q7{Is approx. DC20V detected between ②-③ on the remote control terminal block?} Q1 -- YES --> S1[Set one remote control for "Master" and the other for "Slave"] S1 --> Q3 Q3 -- YES --> C1[Normal] Q3 -- NO --> Q4 Q1 -- NO --> Q2 Q2 -- YES --> C2[Set SW1 on remote control PCB at "Master".] Q2 -- NO --> Q3 Note1[Note (1) Use SW1 to set at master or slave.] Note2[Note (2) "Slave" is displayed on the remote control LCD.] Q4 -- YES --> C3[Set address again. (SW3 on interface kit PCB)] Q4 -- NO --> Q5 Q5 -- YES --> C4[Separate remote control wires from high voltage wires.] Q5 -- NO --> Q6 Q6 -- YES --> C5[Broken connecting wire -> Correct.] Q6 -- NO --> Q7 Q7 -- YES --> C6[Defective remote control PCB -> Replace.] Q7 -- NO --> C7[Defective interface kit PCB -> Replace.] </pre>	<p>Set SW1 on remote control PCB at "Master".</p> <p>Normal</p> <p>Set address again. (SW3 on interface kit PCB)</p> <p>Separate remote control wires from high voltage wires.</p> <p>Defective interface kit PCB → Replace.</p> <p>Broken connecting wire → Correct.</p> <p>Defective remote control PCB → Replace.</p>

Note: If any error is detected 30 minutes after displaying "WAIT" on the remote control, the display changes to "INSPECT I/U".

Error code Remote control: INSPECT I/U	Indoor display	RUN light -	TIMER light -	Content INSPECT I/U (Connection of 3 units or more remote control)
	Outdoor unit control PCB	Green LED	Red LED	
		Keeps flashing	2-time flash	

1. Applicable model
All models
2. Error detection method
Indoor unit cannot communicate for more than 30 minutes after the power on with remote control.
3. Condition of error displayed
Same as above
4. Presumable cause
<ul style="list-style-type: none"> • Improper setting • Surrounding environment • Defective remote control communication circuit • Faulty indoor unit control PCB • Faulty outdoor unit control PCB • Faulty interface kit PCB

5. Troubleshooting	
Diagnosis	Countermeasure

Note: If any error is detected 30 minutes after displaying “WAIT” on the remote control, the display changes to “INSPECT I/U”.

Error code Remote control: 🏠WAIT🏠	Indoor display	RUN light -	TIMER light -	Content Communication error at initial operation (1/3)
	Outdoor unit control PCB	Green LED Keeps flashing	Red LED 2-time flash	

1. Applicable model
All models

2. Error detection method

3. Condition of error displayed

4. Presumable cause
<ul style="list-style-type: none"> • Faulty indoor unit control PCB • Defective remote control • Broken remote control wire • Faulty outdoor unit control PCB • Broken connection wires

5. Troubleshooting	
Diagnosis	Countermeasure
<p>“🏠WAIT🏠” is still displayed on the remote control LED 2 minutes after power ON.</p> <p>YES</p> <p>Is the outdoor unit control green LED flashing?</p> <p>NO → To next page</p> <p>YES</p> <p>Is the outdoor unit control red LED flashing twice?</p> <p>NO → Defective indoor unit control PCB → Replace. Defective remote control → Replace. Broken remote control wire X or Y → Replace.</p> <p>YES</p> <p>Are wires connected properly between indoor/outdoor units?</p> <p>NO → Correct connection wires between indoor and outdoor units.</p> <p>YES</p> <p>Is approx. DC20V detected between ②-③ on the outdoor unit terminal block?</p> <p>NO → Defective outdoor unit control PCB → Replace.</p> <p>YES</p> <p>Is approx. DC20V detected between ②-③ on the indoor unit terminal block?</p> <p>NO → Defective connection wire (Broken) Noise</p> <p>YES → Defective indoor unit control PCB → Replace.</p>	

Note:

Error code Remote control: 🏠 WAIT 🏠	Indoor display	RUN light -	TIMER light -	Content Communication error at initial operation (2/3)
	Outdoor unit control PCB	Green LED Keeps flashing	Red LED 2-time flash	

1. Applicable model
All models

2. Error detection method

3. Condition of error displayed

4. Presumable cause
<ul style="list-style-type: none"> • Faulty noise filter • Faulty indoor unit control PCB • Faulty outdoor unit control PCB • Faulty inverter PCB • Faulty fan motor

5. Troubleshooting	
Diagnosis	Countermeasure
<p>Diagnosis for when the outdoor unit control PCB LED is turned off</p> <pre> graph TD Start[From previous page] --> Step1[Shut down the breaker and back on again the breaker 3 minutes later.] Step1 --> Dec1{Does it reset normally?} Dec1 -- YES --> C1[Normal (Malfunction by noise)] Dec1 -- NO --> Dec2{Is the outdoor unit control power source fuse (30A) blown?} Dec2 -- YES --> Note1[Note (1) 1-phase model only] Note1 --> Step2[To check method for inverter PCB before replacment of blown power source fuse.] Step2 --> Dec3{Is AC220/240V or AC380/415V detected at the noise filter secondary side?} Dec3 -- NO --> C2[Replace noise filter.] Dec3 -- YES --> Dec4{Is DC255-310V detected at CNA2?} Dec4 -- NO --> C3[Check connection of diode stack and electrolytic capacitor by refering main electrical circuit diagram.] Dec4 -- YES --> Dec5{Is fuse [250V, 2A] on the outdoor unit control PCB blown?} Dec5 -- YES --> C4[Defective outdoor unit control PCB → Replace.] Dec5 -- NO --> Dec6{Is DC5V detected on the outdoor unit control PCB (Between ①-② of CNV)?} Dec6 -- NO --> C5[Defective outdoor unit control PCB → Replace.] Dec6 -- YES --> Dec7{Is DC5V detected if the connector of outdoor unit fan motor is disconnected?} Dec7 -- NO --> C6[Defective outdoor unit fan motor] Dec7 -- YES --> Dec8{Is DC5V detected if the inverter power source connector (CN2) is disconnected?} Dec8 -- NO --> C7[Defective inverter PCB → Replace.] Dec8 -- YES --> C8[Defective outdoor unit control PCB → Replace.] </pre>	

Note:

Error code Remote control: 🏠 WAIT 🏠	Indoor display	RUN light -	TIMER light -	Content Communication error at initial operation (3/3)
	Outdoor unit control PCB	Green LED Keeps flashing	Red LED 2-time flash	

1. Applicable model
All models

2. Error detection method

3. Condition of error displayed

4. Presumable cause
<ul style="list-style-type: none"> • Blown fuse • Faulty noise filter • Faulty inverter PCB • Faulty reactor • Faulty electrolytic capacitor

5. Troubleshooting	
Diagnosis	Countermeasure
<p>Method to check for inverter PCB before replacement of blown power source fuse.</p> <pre> graph TD Start[From previous page] --> D1{Is there a short-circuit between phases of the noise filter?} D1 -- YES --> C1[Replace the noise filter.] D1 -- NO --> D2{Is there a short-circuit between phases of inverter PCB input terminals?} D2 -- YES --> C2[Replace the inverter PCB.] D2 -- NO --> D3{Is there any crack, burning on the power transistor module?} D3 -- YES --> C2 D3 -- NO --> D4{Is the reactor OK?} D4 -- NO --> C3[Replace the reactor.] D4 -- YES --> D5{Is the electrolytic capacitor OK?} D5 -- NO --> C4[Replace the electrolytic capacitor.] D5 -- YES --> C5[Replace the power source fuse.] </pre>	

Note:

Error code Remote control: None	Indoor display	RUN light -	TIMER light -	Content No display
	Outdoor unit control PCB	Green LED	Red LED	
		Stays OFF	Stays OFF	

1. Applicable model
All models

2. Error detection method

3. Condition of error displayed

4. Presumable cause
<ul style="list-style-type: none"> • Faulty indoor unit control PCB • Defective remote control • Broken remote control wire • Defective interface kit

5. Troubleshooting	
Diagnosis	Countermeasure
<pre> graph TD Start[Remote control does not display anything after the power on.] --> D1{Is DC10V or higher detected at remote control connection terminals?} D1 -- YES --> C1[Defective remote control] D1 -- NO --> D2{Is DC10V or higher detected on remote control wires if the remote control is removed?} D2 -- YES --> C2[Defective remote control] D2 -- NO --> D3{Is DC10V or higher detected at interface kit connection terminals?} D3 -- YES --> C3[Defective interface kit] D3 -- NO --> D4{Is DC10V or higher detected on connecting wires if the interface kit is removed?} D4 -- YES --> C4[Defective interface kit] D4 -- NO --> D5{Are wires connected properly between the indoor/outdoor units?} D5 -- NO --> C5[Defective connecting wire Defective remote control wire (Short-circuit, etc.)] D5 -- YES --> C6[Defective indoor unit control PCB → Replace.] </pre>	

Note:

Error code Remote control: E1	Indoor display	RUN light —	TIMER light —	Content Remote control communication circuit error
	Outdoor unit control PCB	Green LED	Red LED	
		Keeps flashing	Stays OFF	

1. Applicable model
All models
2. Error detection method
When normal communication between the remote control and the indoor unit is interrupted for more than 2 minutes. (Detectable only with the remote control)
3. Condition of error displayed
Same as above
4. Presumable cause
<ul style="list-style-type: none"> • Defective communication circuit between remote control-indoor unit • Noise • Defective remote control • Faulty indoor unit control PCB • Defective interface kit

5. Troubleshooting	
Diagnosis	Countermeasure
<pre> graph TD D1{Is it possible to reset normally by the power reset?} -- YES --> C1[Malfunction by noise Check peripheral environment.] D1 -- NO --> D2{Is DC10V or higher detected at remote control connection terminals?} D2 -- YES --> C2[Defective remote control] D2 -- NO --> D3{Is DC10V or higher detected on remote control wires if the remote control is removed?} D3 -- YES --> C3[Defective remote control] D3 -- NO --> D4{Is DC10V or higher detected at interface kit connection terminals?} D4 -- YES --> C4[Defective interface kit] D4 -- NO --> D5{Is DC10V or higher detected on connecting wires if the interface kit is removed?} D5 -- YES --> C5[Defective interface kit] D5 -- NO --> D6{Are wires connected properly between the indoor/outdoor units?} D6 -- NO --> C6[Defective connecting wire Defective remote control wire (Short-circuit, etc.)] D6 -- YES --> C7[Defective indoor unit control PCB -> Replace.] </pre> <p>Note (1) Does the remote control still display “ WAIT ” even after 3 minutes?</p>	

Note: If the indoor unit cannot communicate normally with the remote control for 180 seconds, the indoor unit PCB starts to reset automatically.

Error code Remote control: E5	Indoor display	RUN light ON	TIMER light 6-time flash	Content Communication error during operation
	Outdoor unit control PCB	Green LED Keeps flashing	Red LED See below	

1. Applicable model
All models
2. Error detection method
When normal communication between indoor and outdoor unit is interrupted for more than 2 minutes.
3. Condition of error displayed
Same as above is detected during operation.
4. Presumable cause
<ul style="list-style-type: none"> • Unit No. setting error • Broken remote control wire • Faulty remote control wire connection • Faulty outdoor unit control PCB

5. Troubleshooting	
Diagnosis	Countermeasure
<p>In case that the outdoor unit red LED flashes 2-time</p> <p>Note (1) Inspect faulty connections (disconnection, looseness) on the outdoor unit terminal block.</p> <p>Is the connection of signal wires at the outdoor unit side OK?</p> <p>NO → Repair signal wires.</p> <p>YES</p> <p>Note (2) Check for faulty connection or breakage of signal wires between indoor-outdoor units.</p> <p>Is the connection of signal wires between indoor-outdoor units OK?</p> <p>NO → Repair signal wires.</p> <p>YES</p> <p>Power source reset</p> <p>Has the remote control LCD returned to normal state?</p> <p>NO → To the diagnosis of “WAIT”</p> <p>YES → Unit is normal. (Malfunction by temporary noise, etc.)</p> <p>In case that the outdoor unit red LED stays OFF</p> <p>Power source reset</p> <p>Has the remote control LCD returned to normal state?</p> <p>NO → Defective outdoor unit control PCB (Defective network communication circuit) → Replace.</p> <p>YES → Unit is normal. (Malfunction by temporary noise, etc.)</p>	

Note: Pressing the pump-down switch cancels communications between indoor and outdoor unit so that “communication error-E5” is displayed on indoor unit and remote control, but it is normal.

Error code Remote control: E6	Indoor display	RUN light 1(3)-time flash ⁽¹⁾	TIMER light ON	Content Indoor heat exchanger temperature sensor anomaly
	Outdoor unit control PCB	Green LED	Red LED	
		Keeps flashing	Stays OFF	

Note(1) Value in () are the Th2.

1. Applicable model
All models
2. Error detection method
Anomalously low temperature or high temperature (resistance) is detected on the indoor heat exchanger sensor (Th2 ₁ , Th2 ₂).
3. Condition of error displayed
<ul style="list-style-type: none"> When the temperature sensor detects -28°C or lower for 15 seconds continuously, the compressor stops. After 3-minutes delay, the compressor starts again automatically, but if this error occurs again within 60 minutes after the initial detection.
4. Presumable cause
<ul style="list-style-type: none"> Defective indoor heat exchanger sensor connector Indoor heat exchanger temperature sensor anomaly Faulty indoor unit control PCB

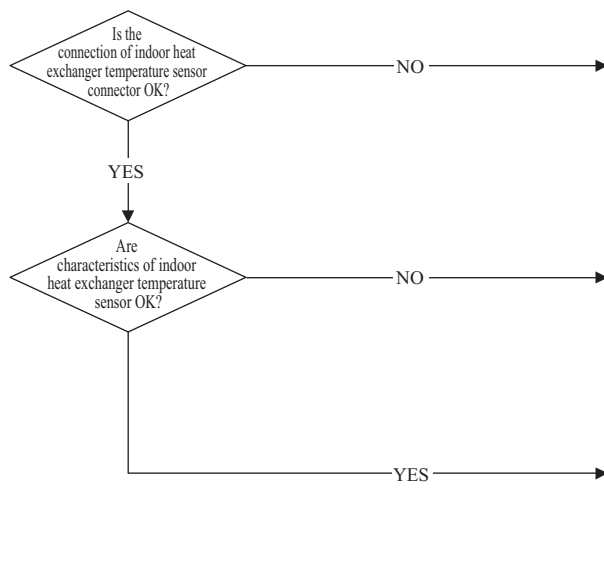
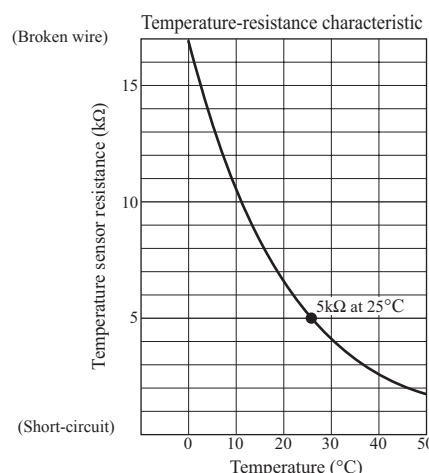
5. Troubleshooting	
Diagnosis	Countermeasure
	<p>Correct. → Insert connector securely.</p> <p>Defective indoor heat exchanger temperature sensor → Replace.</p> <p>Defective indoor unit control PCB → Replace. (Defective indoor heat exchanger temperature sensor input circuit)</p>
<p>(Broken wire)</p> <p style="text-align: center;">Temperature-resistance characteristic</p>  <p>(Short-circuit)</p>	

Note:

Error code Remote control: None	Indoor display	RUN light 2-time flash	TIMER light ON	Content Room temperature sensor anomaly
	Outdoor unit control PCB	Green LED Keeps flashing	Red LED Stays OFF	

1. Applicable model
All models

2. Error detection method
Anomalously low temperature or high temperature (resistance) is detected by indoor room temperature sensor (Th1)

3. Condition of error displayed
<ul style="list-style-type: none"> When the temperature sensor detects -45°C or lower for 15 seconds continuously, the compressor stops. After 3-minute delay, the compressor starts again automatically, but if this error occurs again within 60 minutes after the initial detection.

4. Presumable cause
<ul style="list-style-type: none"> Defective room temperature sensor connector Defective room temperature sensor Faulty indoor unit control PCB

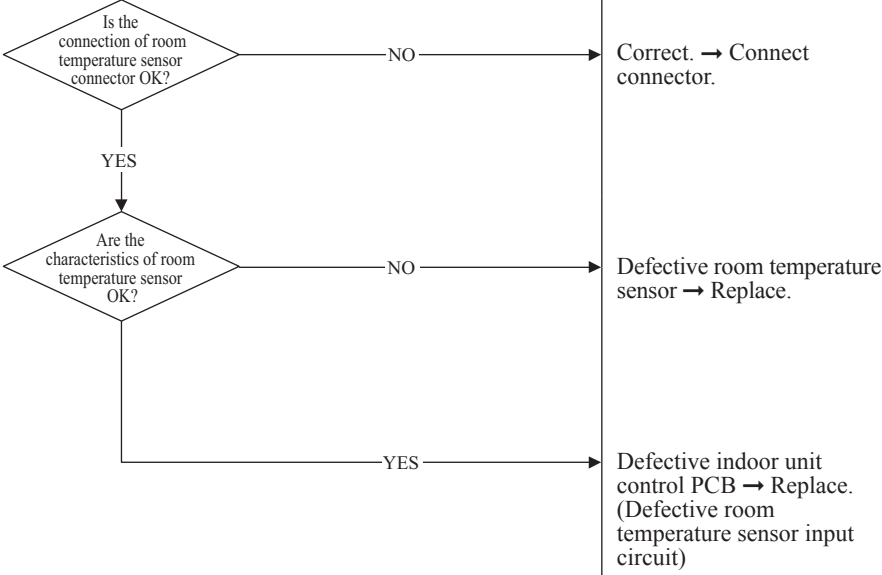
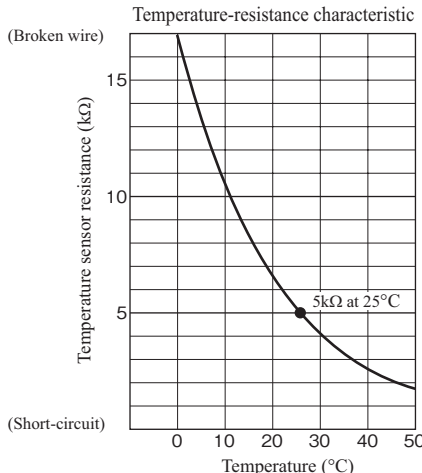
5. Troubleshooting																	
Diagnosis	Countermeasure																
 <pre> graph TD Q1{Is the connection of room temperature sensor connector OK?} Q2{Are the characteristics of room temperature sensor OK?} C1[Correct. -> Connect connector.] C2[Defective room temperature sensor -> Replace.] C3[Defective indoor unit control PCB -> Replace. (Defective room temperature sensor input circuit)] Q1 -- NO --> C1 Q1 -- YES --> Q2 Q2 -- NO --> C2 Q2 -- YES --> C3 </pre>																	
<p style="text-align: center;">Temperature-resistance characteristic</p>  <table border="1"> <caption>Temperature-resistance characteristic data points</caption> <thead> <tr> <th>Temperature (°C)</th> <th>Temperature sensor resistance (kΩ)</th> </tr> </thead> <tbody> <tr> <td>0</td> <td>15</td> </tr> <tr> <td>10</td> <td>10</td> </tr> <tr> <td>20</td> <td>7</td> </tr> <tr> <td>25</td> <td>5</td> </tr> <tr> <td>30</td> <td>4</td> </tr> <tr> <td>40</td> <td>3</td> </tr> <tr> <td>50</td> <td>2</td> </tr> </tbody> </table>		Temperature (°C)	Temperature sensor resistance (kΩ)	0	15	10	10	20	7	25	5	30	4	40	3	50	2
Temperature (°C)	Temperature sensor resistance (kΩ)																
0	15																
10	10																
20	7																
25	5																
30	4																
40	3																
50	2																

Note:

Error code Remote control: E10	Indoor display	RUN light -	TIMER light -	Content Excessive number of connected indoor units (more than 17 units) by controlling with one remote control
	Outdoor unit control PCB	Green LED	Red LED	
		Keeps flashing	Stays OFF	

1. Applicable model	5. Troubleshooting		
All models	Diagnosis		Countermeasure
	<pre> graph LR A{Are more than 17 indoor units connected to one remote control?} -- NO --> B[Defective remote control -> Replace.] A -- YES --> C[Reduce to 16 or less units.] </pre>		
2. Error detection method			
When it detects more than 17 of indoor units connected to one remote control			
3. Condition of error displayed			
Same as above			
4. Presumable cause			
<ul style="list-style-type: none"> • Excessive number of indoor units connected • Defective remote control 			

Note:

Error code Remote control: E14	Indoor display	RUN light —	TIMER light —	Content Communication error between master and slave indoor units
	Outdoor unit control PCB	Green LED Keeps flashing	Red LED Stays OFF	

1. Applicable model
All models

2. Error detection method
When communication error between master and slave indoor units occurs

3. Condition of error displayed
Same as above

4. Presumable cause

- Unit address setting error
- Broken remote control wire
- Defective remote control wire connection
- Broken interface kit wire
- Defective interface kit wire connection
- Defective indoor unit control PCB

5. Troubleshooting

Diagnosis	Countermeasure																	
<pre> graph TD D1{Is it OK the unit address setting for master and slave interface kit?} D2{Is the remote control wiring between interface kit defective?} D3{Is the interface kit wiring between indoor units defective?} D4{Is it restored by resetting the power source?} D1 -- NO --> C1[Correct unit address setting.] D1 -- YES --> D2 D2 -- YES --> C2[Correct wiring.] D2 -- NO --> D3 D3 -- YES --> C3[Correct wiring.] D3 -- NO --> D4 D4 -- NO --> C4[Defective indoor unit control PCB -> Replace.] D4 -- YES --> C5["• Malfunction by noise • Check surrounding environment."] </pre>																		
<p>Note (1) Set dip switches SW3-1 and SW3-2 as shown in the following table. (Factory default setting – “Master”)</p> <table border="1"> <thead> <tr> <th colspan="2" rowspan="2"></th> <th colspan="3">Interface kit</th> </tr> <tr> <th>Master</th> <th>Slave1</th> <th>Slave2</th> </tr> </thead> <tbody> <tr> <th rowspan="2">Dip switch</th> <th>SW3-1</th> <td>OFF</td> <td>OFF</td> <td>ON</td> </tr> <tr> <th>SW3-2</th> <td>OFF</td> <td>ON</td> <td>OFF</td> </tr> </tbody> </table>				Interface kit			Master	Slave1	Slave2	Dip switch	SW3-1	OFF	OFF	ON	SW3-2	OFF	ON	OFF
				Interface kit														
		Master	Slave1	Slave2														
Dip switch	SW3-1	OFF	OFF	ON														
	SW3-2	OFF	ON	OFF														

Note:

Error code Remote control: E16	Indoor display	RUN light 6-time flash	TIMER light ON	Content Indoor fan motor anomaly
	Outdoor unit control PCB	Green LED	Red LED	
		Keeps flashing	Stays OFF	

1. Applicable model
All models

2. Error detection method
Detected by rotation speed of indoor fan motor

3. Condition of error displayed
<ul style="list-style-type: none"> When actual rotation speed of indoor fan motor drops to lower than 300min⁻¹ for 30 seconds continuously, the compressor and the indoor fan motor stop.

4. Presumable cause
<ul style="list-style-type: none"> Defective indoor unit control PCB Foreign material at rotational area of fan propeller Defective fan motor Dust on indoor unit control PCB External noise, surge

5. Troubleshooting	
Diagnosis	Countermeasure
<pre> graph TD D1{Does any foreign material intervene in rotational area of fan propeller?} D2{Does the fan rotate smoothly when turned by hand?} D3{Is DC280V detected between ①-③ of fan motor connector CNU?} R1[Remove foreign material.] R2[Replace the fan motor.] R3[Replace indoor unit control PCB] R4[Replace fan motor. (If the error persists after replacing the fan motor, replace the indoor unit control PCB.)] R5[Malfunction by temporary noise] PR[Power source reset] D1 -- YES --> R1 D1 -- NO --> D2 D2 -- NO --> R2 D2 -- YES --> D3 D3 -- NO --> R3 D3 -- YES --> PR PR --> D4{Is it normalized?} D4 -- NO --> R4 D4 -- YES --> R5 </pre>	

Note:

Error code Remote control: E28	Indoor display	RUN light -	TIMER light -	Content Remote control temperature sensor anomaly
	Outdoor unit control PCB	Green LED	Red LED	
		Keeps flashing	Stays OFF	

1. Applicable model
All models

2. Error detection method
Detection of anomalously low temperature (resistance) of remote control temperature sensor (The)

3. Condition of error displayed
When the temperature sensor detects -50°C or lower for 5 seconds continuously, the compressor stops. After 3-minute delay, the compressor starts again automatically, but if this error occurs again within 60 minutes after the initial detection.

4. Presumable cause

- Faulty connection of remote control temperature sensor
- Defective remote control temperature sensor
- Defective remote control PCB

5. Troubleshooting

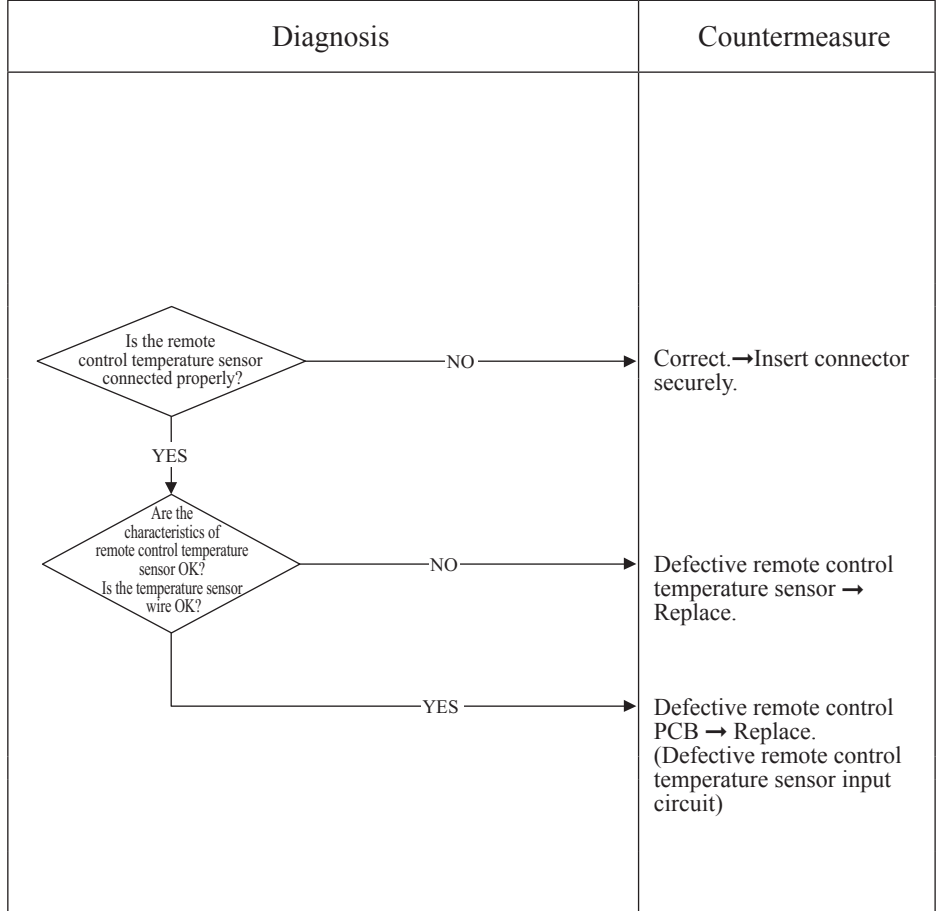

Temperature-resistance characteristics of remote control temperature sensor (The)

Temperature (°C)	Resistance value (kΩ)	Temperature (°C)	Resistance value (kΩ)
0	65	30	16
1	62	32	15
2	59	34	14
4	53	36	13
6	48	38	12
8	44	40	11
10	40	42	9.9
12	36	44	9.2
14	33	46	8.5
16	30	48	7.8
18	27	50	7.3
20	25	52	6.7
22	23	54	6.3
24	21	56	5.8
26	19	58	5.4
28	18	60	5.0

Note: After 10 seconds has passed since remote control temperature sensor was switched from invalid to valid, E28 will not be displayed even if the temperature sensor harness is disconnected. At same time the temperature sensor, which is effective, is switched from remote control temperature sensor to indoor return air temperature sensor. Even though the remote control temperature sensor is set to be effective, the return air temperature displayed on remote control for checking still shows the value detected by indoor return air temperature sensor, not by remote control temperature sensor.

Error code Remote control: E35	Indoor display	RUN light ON	TIMER light Keeps flashing	Content Cooling overload operation
	Outdoor unit control PCB	Green LED Keeps flashing	Red LED 1-time flash	
		Yellow LED Keeps flashing		
	Outdoor unit inverter PCB			

1. Applicable model
All models

2. Error detection method
For the error detection method, refer to cooling high pressure protective control in the protective control by controlling compressor rotation speed of micro computer control function for corresponding models.

3. Condition of error displayed
When outdoor heat exchanger temperature anomaly is detected 5 times within 60 minutes or this anomalous state is detected 60 minutes continuously including compressor stop.

4. Presumable cause
<ul style="list-style-type: none"> • Defective outdoor heat exchanger temperature sensor • Defective outdoor unit control PCB • Indoor, outdoor unit installation spaces • Short-circuit of air on indoor, outdoor units • Fouling, clogging of heat exchanger • Excessive refrigerant amount

5. Troubleshooting	
Diagnosis	Countermeasure
<pre> graph TD Q1{Are the characteristics of outdoor heat exchanger temperature sensor normal?} Q2{Is the unit operating in the state of cooling overload?} Q3{Is the high pressure control normal?} Q4{Is the temperature (measured actually) at detection of error correct?} Q1 -- NO --> C1[Replace outdoor heat exchanger temperature sensor.] Q1 -- YES --> Q2 Q2 -- YES --> C2["Check unit side. • Isn't the air circulation of outdoor unit short-circuited? • Are installation spaces adequate? • Isn't there any fouling or clogging on heat exchanger?"] Q2 -- NO --> Q3 Q3 -- NO --> C3[Control operation check *] Q3 -- YES --> Q4 Q4 -- NO --> C4[Defective outdoor unit control PCB → Replace.] Q4 -- YES --> C5["Excessive refrigerant amount : Recharge refrigerant by weighing proper amount on a scale."] </pre> <p>* For the characteristics of outdoor heat exchanger temperature sensor, refer to E37.</p> <p>* For the contents of control, refer to cooling high pressure protective control in the protective control by controlling compressor rotation speed of micro computer control function for corresponding models.</p>	

Note:

Error code Remote control: E36	Indoor display	RUN light ON	TIMER light 5-time flash	Content Discharge pipe temperature error
	Outdoor unit control PCB	Green LED Keeps flashing	Red LED 1-time flash	
		Yellow LED Keeps flashing		
	Outdoor unit inverter PCB			

1. Applicable model
All models

2. Error detection method
For the error detection method, refer to compressor overheat protective control in the protective control by controlling compressor rotation speed of micro computer control function for corresponding models.

3. Condition of error displayed
When discharge pipe temperature anomaly is detected 2 times within 60 minutes or this anomalous state is detected 60 minutes continuously including compressor stop.

4. Presumable cause
<ul style="list-style-type: none"> • Defective outdoor unit control PCB • Defective discharge pipe temperature sensor • Clogged filter • Indoor, outdoor unit installation spaces • Short-circuit of air on indoor, outdoor units • Fouling, clogging of heat exchanger

5. Troubleshooting	
Diagnosis	Countermeasure
<p style="text-align: right;">* For the characteristics of discharge pipe temperature sensor, refer to E39.</p> <pre> graph TD Q1{Are the characteristics of discharge pipe temperature sensor normal?} Q2{Is the discharge pipe temperature error persisted during cooling/heating operation?} Q3{Is the discharge pipe temperature control normal?} Q4{Is the temperature (measured actually) at detection of error correct?} Q1 -- NO --> C1[Replace discharge pipe temperature sensor.] Q1 -- YES --> Q2 Q2 -- YES --> C2[Insufficient refrigerant amount : Recharge refrigerant by weighing proper amount on a scale.] Q2 -- NO --> Q3 Q3 -- NO --> C3[Control operation check *] Q3 -- YES --> Q4 Q4 -- NO --> C4[Defective outdoor unit control PCB → Replace.] Q4 -- YES --> C5[Check unit side: • Isn't filter clogged? • Are indoor, outdoor unit installation spaces adequate? • Isn't there any short-circuit of air? • Isn't there any fouling, clogging on indoor heat exchanger?] </pre>	
<p>* For the contents of control, refer to compressor overheat protective control in the protective control by controlling compressor rotation speed of micro computer control function for corresponding models.</p>	

Note:

Error code Remote control: E37	Indoor display	RUN light Keeps flashing	TIMER light 2-time flash	Content Outdoor heat exchanger temperature sensor anomaly
	Outdoor unit control PCB	Green LED Keeps flashing	Red LED 1-time flash	
		Yellow LED Keeps flashing		
	Outdoor unit inverter PCB			

1. Applicable model
All models

2. Error detection method
Detection of anomalously low temperature (resistance) on the outdoor heat exchanger temperature sensor

3. Condition of error displayed
<ul style="list-style-type: none"> When the temperature sensor detects -50°C or lower for 5 seconds continuously within 2 minutes to 2 minutes 20 seconds after the compressor ON, the compressor stops. After 3-minute delay, the compressor starts again automatically, but if this anomalous temperature is detected 3 times within 40 minutes. When -50°C or lower is detected for 5 seconds continuously within 20 seconds after compressor ON.

4. Presumable cause
<ul style="list-style-type: none"> Defective outdoor unit control PCB Broken sensor harness or temperature sensing section Disconnected wire connection (connector)

5. Troubleshooting																	
Diagnosis	Countermeasure																
<p style="text-align: center;">Is the outdoor heat exchanger temperature sensor connector connected properly?</p> <p style="text-align: center;">NO → Correct connector.</p> <p style="text-align: center;">YES</p> <p style="text-align: center;">For the characteristics of outdoor heat exchanger temperature sensor, see the following graph.</p> <p style="text-align: center;">Are the characteristics of outdoor heat exchanger temperature sensor OK?</p> <p style="text-align: center;">NO → Defective outdoor heat exchanger temperature sensor → Replace.</p> <p style="text-align: center;">YES → Defective outdoor unit control PCB → Replace. (Defective outdoor heat exchanger temperature sensor input circuit)</p>																	
<p style="text-align: center;">Temperature-resistance characteristics</p> <table border="1"> <caption>Temperature-resistance characteristics data</caption> <thead> <tr> <th>Temperature (°C)</th> <th>Temperature sensor resistance (kΩ)</th> </tr> </thead> <tbody> <tr> <td>0</td> <td>15</td> </tr> <tr> <td>10</td> <td>10</td> </tr> <tr> <td>20</td> <td>7</td> </tr> <tr> <td>25</td> <td>5</td> </tr> <tr> <td>30</td> <td>4</td> </tr> <tr> <td>40</td> <td>3</td> </tr> <tr> <td>50</td> <td>2</td> </tr> </tbody> </table>		Temperature (°C)	Temperature sensor resistance (kΩ)	0	15	10	10	20	7	25	5	30	4	40	3	50	2
Temperature (°C)	Temperature sensor resistance (kΩ)																
0	15																
10	10																
20	7																
25	5																
30	4																
40	3																
50	2																

Note:

Error code Remote control: E38	Indoor display	RUN light Keeps flashing	TIMER light 1-time flash	Content Outdoor air temperature sensor anomaly
	Outdoor unit control PCB	Green LED Keeps flashing	Red LED 1-time flash	
		Yellow LED Keeps flashing		
	Outdoor unit inverter PCB			

1. Applicable model
All models

2. Error detection method
Detection of anomalously low temperature (resistance) on outdoor air temperature sensor

3. Condition of error displayed
<ul style="list-style-type: none"> When the temperature sensor detects -45°C or lower for 5 seconds continuously within 2 minutes to 2 minutes 20 seconds after the compressor ON, the compressor stops. After 3-minute delay, the compressor starts again automatically, but if this anomalous temperature is detected 3 times within 40 minutes. When -45°C or lower is detected for 5 seconds continuously within 20 seconds after compressor ON.

4. Presumable cause
<ul style="list-style-type: none"> Defective outdoor unit control PCB Broken sensor harness or temperature sensing section (Check molding.) Disconnected wire connection (connector)

5. Troubleshooting															
Diagnosis	Countermeasure														
<p style="text-align: center;">Is the outdoor air temperature sensor connector connected properly?</p> <p style="text-align: center;">NO → Correct connector.</p> <p style="text-align: center;">YES</p> <p style="text-align: center;">For the characteristics of outdoor air temperature sensor, see the following graph.</p> <p style="text-align: center;">Is the characteristics of the outdoor air temperature sensor OK?</p> <p style="text-align: center;">NO → Defective outdoor air temperature sensor → Replace.</p> <p style="text-align: center;">YES → Defective outdoor unit control PCB → Replace. (Defective outdoor air temperature sensor input circuit)</p>															
<p style="text-align: center;">Temperature-resistance characteristics</p> <table border="1"> <caption>Temperature-resistance characteristics data</caption> <thead> <tr> <th>Temperature (°C)</th> <th>Temperature sensor resistance (kΩ)</th> </tr> </thead> <tbody> <tr><td>0</td><td>35</td></tr> <tr><td>10</td><td>25</td></tr> <tr><td>20</td><td>15</td></tr> <tr><td>30</td><td>10</td></tr> <tr><td>40</td><td>7</td></tr> <tr><td>50</td><td>5</td></tr> </tbody> </table>		Temperature (°C)	Temperature sensor resistance (kΩ)	0	35	10	25	20	15	30	10	40	7	50	5
Temperature (°C)	Temperature sensor resistance (kΩ)														
0	35														
10	25														
20	15														
30	10														
40	7														
50	5														

Note:

Error code Remote control: E39	Indoor display	RUN light Keeps flashing	TIMER light 4-time flash	Content Discharge pipe temperature sensor anomaly
	Outdoor unit control PCB	Green LED Keeps flashing	Red LED 1-time flash	
		Yellow LED Keeps flashing		
	Outdoor unit inverter PCB			

1. Applicable model
All models

2. Error detection method
Detection of anomalously low temperature (resistance) on the discharge pipe temperature sensor

3. Condition of error displayed
When the temperature sensor detects -10°C or lower for 5 seconds continuously within 10 minutes to 10 minutes 20 seconds after the compressor ON, the compressor stops. After 3-minute delay, the compressor starts again automatically, but if this anomalous temperature is detected 3 times within 40 minutes.

4. Presumable cause

- Defective outdoor unit control PCB
- Broken sensor harness or temperature sensing section (Check molding.)
- Disconnected wire connection (connector)

5. Troubleshooting

Diagnosis	Countermeasure
<pre> graph TD Q1{Is the discharge pipe temperature sensor connector connected properly?} -- NO --> C1[Correct connector.] Q1 -- YES --> Q2{Are the characteristics of discharge pipe temperature sensor OK?} Q2 -- NO --> C2[Defective discharge pipe temperature sensor -> Replace.] Q2 -- YES --> C3[Defective outdoor unit control PCB -> Replace. (Defective discharge pipe temperature sensor input circuit)] </pre>	
<p>(Broken wire) Temperature-resistance characteristics</p> <p>(Short-circuit)</p>	

Note:

Error code Remote control: E40	Indoor display	RUN light	TIMER light	Content High pressure error (63H1 activated)
	Outdoor unit control PCB	Green LED	Red LED	
		Keeps flashing	1-time flash	
	Outdoor unit inverter PCB	Yellow LED		

1. Applicable model
All models

2. Error detection method
When the high pressure switch 63H1 is activated.
<p>Compressor ON</p> <p>Compressor OFF</p> <p>3.15 4.15 High pressure (MPa)</p>

3. Condition of error displayed
If 63H1 turns OFF (opened), the compressor stops. After 3-minute delay, the compressor restarts. If this anomaly occurs 5 times within 60 minutes or continues for 60 minutes continuously.

4. Presumable cause
<ul style="list-style-type: none"> • Short-circuit of air flow, disturbance of air flow and clogging filter at outdoor heat exchanger/Breakdown of fan motor • Defective outdoor unit control PCB • Defective 63H1 connector • Defective electronic expansion valve connector • Closed service valve • Mixing of non-condensing gas (nitrogen, etc.)

5. Troubleshooting	
Diagnosis	Countermeasure
<p>If the power source breaker is turned OFF and ON too quickly, E40 may be displayed. (This is normal.)</p>	
<p>Is the service valve fully opened?</p> <p>NO → Open the service valve.</p> <p>YES</p> <p>Has 63H1 activated?</p> <p>NO → Is 63H1 connector connected properly?</p> <p>NO → Correct 63H1 connector.</p> <p>YES</p> <p>Is the electronic expansion valve connector connection OK?</p> <p>NO → Correct electronic expansion valve connector.</p> <p>YES</p> <p>If any anomaly exists on the electronic expansion valve connector connection, the power source must be reset.</p> <p>YES → Defective outdoor unit control PCB → Replace. (Defective 63H1 input circuit)</p>	
<p>On operation of 63H1</p> <p>1. During cooling</p> <ul style="list-style-type: none"> • Is the outdoor fan motor running? • Isn't any short-circuit of air on the outdoor unit? • Are sufficient return air/supply air space secured? <p>2. During heating</p> <ul style="list-style-type: none"> • Isn't the indoor heat exchanger temperature sensor disconnected from the sensor casing? • Isn't the filter clogged? <p>* Under the condition of overcharging refrigerant, 63H1 may activate due to delay of starting the preventive control by compressor speed control, because detected heat exchanger temperature, which conducts compressor speed control, becomes lower than normal condition due to excess sub-cooling degree.</p>	

Note: In the protective control range for compressor startup (initial startup after power ON), even if 63H1 is activated only once (63H1 turns OFF), immediately the error is displayed.

Error code Remote control: E41	Indoor display	RUN light	TIMER light	Content Power transistor overheat
	Outdoor unit control PCB	Green LED	Red LED	
		Keeps flashing	1-time flash	
	Outdoor unit inverter PCB	Yellow LED		
6-time flash				

1.Applicable model
All models

2.Error detection method
When less than DC14V of the output voltage is detected between ② and ③ on CNI3, E41 is displayed. (See "Note" mentioned below.)

3.Condition of error displayed
Same as above.

4.Presumable cause
<ul style="list-style-type: none"> • Defective inverter PCB • Defective outdoor fan motor • Defective outdoor unit control PCB • Defective noise filter PCB

5.Troubleshooting	
Diagnosis	Countermeasure
<p>• Single phase models (FDC100-140VNX-W)</p> <pre> graph TD Q1{Is DC15V detected between ② and ③ on CNI3? (1) (2)} Q1 -- YES --> C1[Replace inverter PCB. If not solved, replace noise filter PCB as well.] Q1 -- NO --> N1[Note(1) Under anomalous conditions, the voltage becomes less than DC14V.] N1 --> Q2{Is DC15V detected after disconnecting outdoor fan motor? (1)} Q2 -- YES --> C2[Replace outdoor fan motor.] Q2 -- NO --> C3[Replace outdoor unit control PCB. If not solved, replace inverter PCB as well.] </pre> <p>Note(2) How to check the voltage between ② and ③ of CNI3? ⇒See E51</p> <p>• 3 phase models (FDC100-140VSX-W) E41⇒Replace inverter PCB</p>	

Note: The "Single phase models" of inverter PAC have no function to output the signal for the power transistor overheat. However since the power source for the power transistor and the outdoor fan motor is in the same line, when the anomaly of the outdoor fan motor occurs, E41 is displayed.

Error code Remote control: E42	Indoor display	RUN light ON	TIMER light 1-time flash	Content Current cut (1/2)
	Outdoor unit control PCB	Green LED Keeps flashing	Red LED 1-time flash	
		Yellow LED 1-time flash		
	Outdoor unit inverter PCB			

1. Applicable model
All models

2. Error detection method
In order to prevent from overcurrent of inverter, if the current exceeds the specifications, it makes the compressor stopping.

3. Condition of error displayed
<ul style="list-style-type: none"> • If the output current of inverter exceeds the specifications, it makes the compressor stopping. • After 3-minute delay, the compressor restarts, but if this anomaly occurs 4 times within 30 minutes after the initial detection.

4. Presumable cause
<ul style="list-style-type: none"> • The service valves closed • Faulty power source • Insufficient refrigerant amount • Faulty compressor • Faulty power transistor module

5. Troubleshooting	
Diagnosis	Countermeasure
<pre> graph TD Q1{Is the Power source voltage OK?} -- NO --> C1[Check power source.] Q1 -- YES --> Q2{Are the service valves opened?} Q2 -- NO --> C2[Open the service valves.] Q2 -- YES --> Q3{Is the high pressure during operation OK?} Q3 -- NO --> C3[Check refrigerant amount and refrigerant circuit *In case of transitional increase of high pressure and/or test run, several times restarting may recover it, because liquid refrigerant (migrated) in the compressor is discharged from the compressor.] Q3 -- YES --> Q4{Is the checked result of insulation resistance and resistance between terminals (1) of compressor motor OK?} Q4 -- NO --> C4[Replace compressor.] Q4 -- YES --> E[To next page.] </pre>	

Note:

Error code Remote control: E42	Indoor display	RUN light ON	TIMER light 1-time flash	Content Current cut (2/2)
	Outdoor unit control PCB	Green LED Keeps flashing	Red LED 1-time flash	
		Yellow LED 1-time flash		
	Outdoor unit inverter PCB			

1. Applicable model
All models

2. Error detection method
In order to prevent from overcurrent of inverter, if the current exceeds the specifications, it makes the compressor stopping.

3. Condition of error displayed

- If the output current of inverter exceeds the specifications, it makes the compressor stopping.
- After 3-minute delay, the compressor restarts, but if this anomaly occurs 4 times within 30 minutes after the initial detection.

4. Presumable cause

- Defective inverter PCB
- Faulty power source
- Insufficient refrigerant amount
- Faulty compressor
- Faulty power transistor module

5. Troubleshooting

Diagnosis	Countermeasure
<p>From previous page</p> <p>Is the checked result of power transistor module OK?</p> <p>NO → Defective inverter PCB → Replace.</p> <p>YES</p> <div style="border: 1px dashed black; padding: 5px;"> <ul style="list-style-type: none"> • Is the space for installation of indoor and/or outdoor unit enough? • Is there any short-circuit of air on indoor and/or outdoor unit? • At cooling, does the outdoor fan motor run? Are the service valves fully opened? Is the filter clogged? • At heating, does the indoor fan motor run? Are the service valves fully opened? Is the filter clogged? • Is there any liquid flooding? Is the superheat within normal range? Is the low pressure sensor and suction pipe temperature sensor normal? • Is there any anomalous sound on the compressor? </div> <p>YES</p> <p>After resetting power for several times does it become normal?</p> <p>NO → Defective inverter PCB → Replace.</p> <p>YES</p> <p>Temporary noise may cause of anomaly. If noise source can be found, take countermeasure.</p>	

Note:

Error code Remote control: E45	Indoor display	RUN light	TIMER light	Content Communication error between inverter PCB and outdoor unit control PCB
	Outdoor unit control PCB	Green LED	Red LED	
		Keeps flashing	1-time flash	
	Outdoor unit inverter PCB	Yellow LED		

1. Applicable model
All models

2. Error detection method
When the communication between inverter PCB and outdoor unit control PCB is not established.

3. Condition of error displayed
Same as above.

4. Presumable cause
<ul style="list-style-type: none"> • Defective inverter PCB • Defective connector between the outdoor unit control PCB and inverter PCB • Defective outdoor unit control PCB • Defective outdoor fan motor

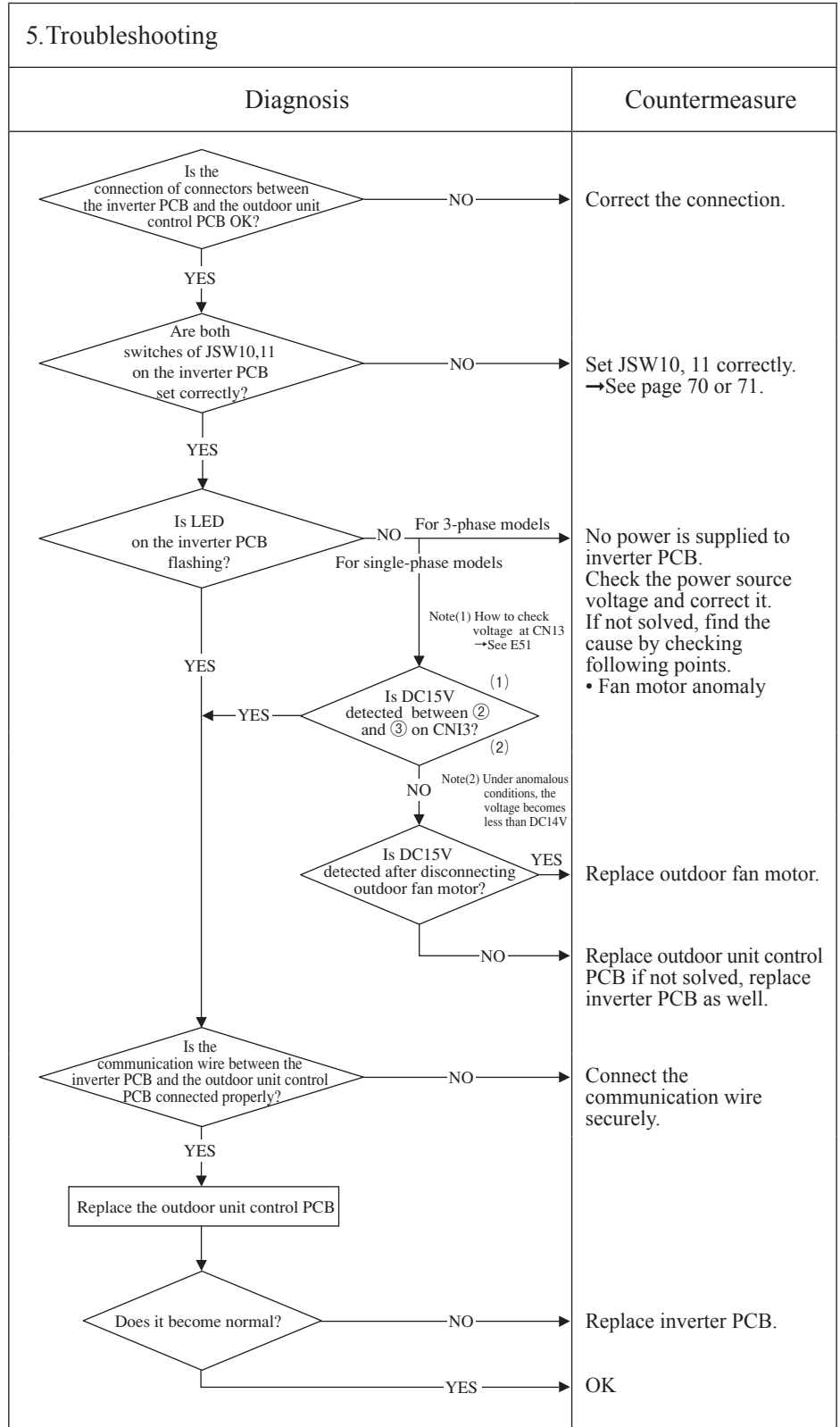

Note:

Error code Remote control: E48	Indoor display	RUN light ON	TIMER light 7-time flash	Content Outdoor fan motor anomaly
	Outdoor unit control PCB	Green LED Keeps flashing	Red LED 1-time flash	
		Yellow LED Keeps flashing		
	Outdoor unit inverter PCB			

1. Applicable model
All models

2. Error detection method
Detected by rotation speed of outdoor fan motor

3. Condition of error displayed
When actual rotation speed of outdoor fan motor (FMo1, 2) drops to 100min ⁻¹ or lower for 30 seconds continuously, the compressor and the outdoor fan motor stop. After 3-minute delay, it starts again automatically, but if this anomaly occurs 5 times within 60 minutes after the initial detection.

4. Presumable cause
<ul style="list-style-type: none"> • Defective outdoor unit control PCB • Foreign material at rotational area of fan propeller • Defective fan motor • Dust on outdoor unit control PCB • Blow fuse • External noise, surge

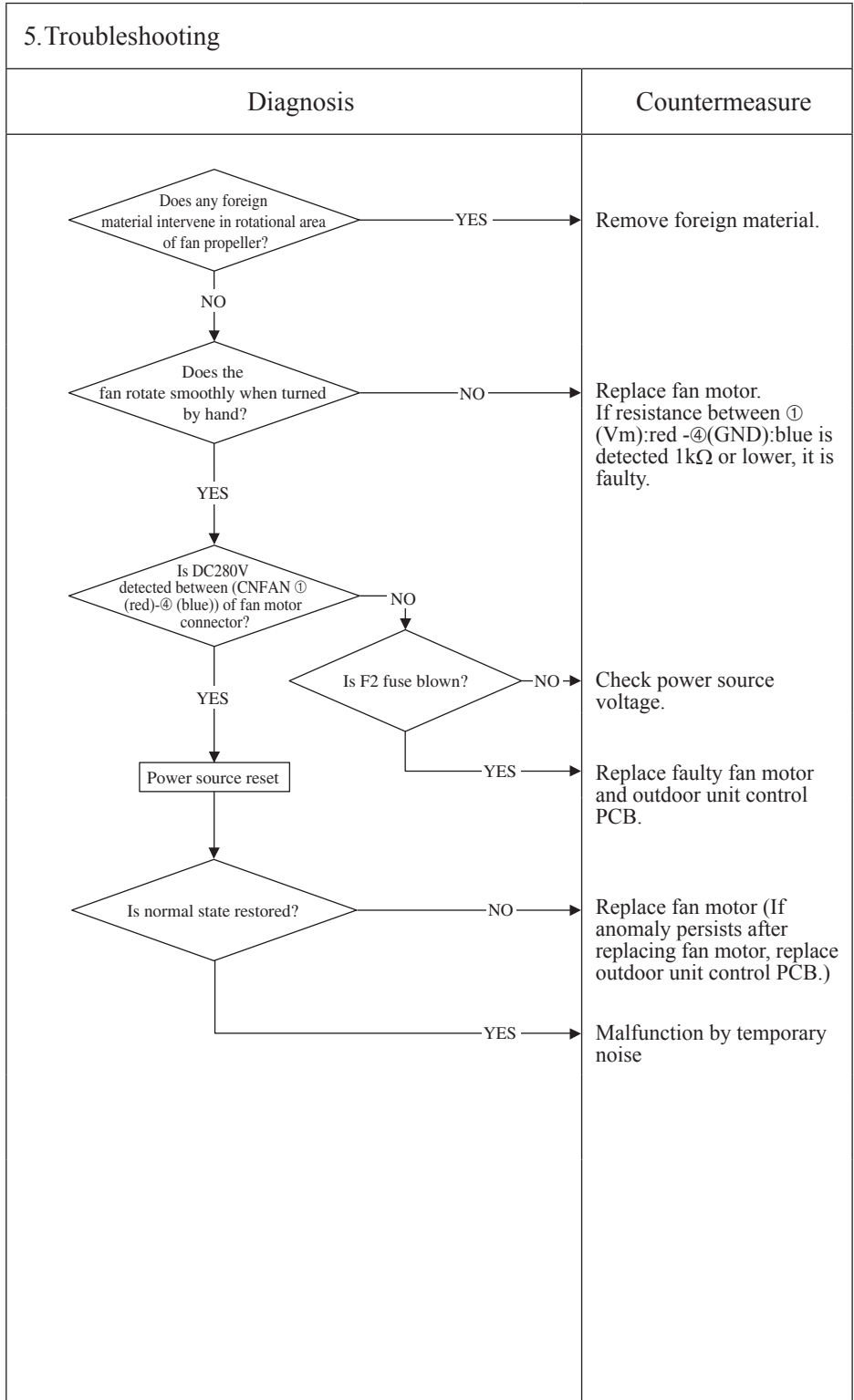

Note: When E48 error occurs, in almost cases F2 fuse (4A) on the outdoor unit control PCB is blown. There are a lot of cases that fuse is blown and E48 occurs due to defective fan motor. And even though only the outdoor unit control PCB (or fuse) is replaced, another trouble (*1) could occur. Therefore when fuse is blown, check whether the fan motor is OK or not.
 After confirming the fan motor normal, check by power ON. (Don't power ON without confirming the fan motor normal.)
 *1 The error which does not seem to relate E48 may occur like as "WAIT", Stay OFF of LED on outdoor unit control PCB, inverter communication error (E45) and etc.

Error code Remote control: E49	Indoor display	RUN light	TIMER light	Content Low pressure error or low pressure sensor anomaly (1/2)
	Outdoor unit control PCB	Green LED	Red LED	
		Keeps flashing	1-time flash	
	Outdoor unit inverter PCB	Yellow LED		
		Keeps flashing		

1. Applicable model
All models

2. Error detection method
Detected by low pressure drop and suction superheat

3. Condition of error displayed

- ① When the low pressure sensor detects 0.079MPa or lower for 15 seconds continuously, compressor stops and it restarts automatically after 3-minute delay. And if this anomaly occurs 3 times within 60 minutes,
- ② 10 minutes after the compressor starts, if the low pressure sensor detects 0.15MPa or lower for 60 seconds continuously and compressor suction superheat is detected 30degC or higher for 60 seconds continuously. And if this anomaly occurs 3 times within 60 minutes,
- ③ If low pressure sensor detects 0.079MPa or lower for 5 minutes continuously (including the compressor stop status),

4. Presumable cause

- Defective outdoor unit control PCB
- Defective low pressure sensor connector
- Defective low pressure sensor
- Defective suction pipe temperature sensor connector
- Defective suction pipe temperature sensor

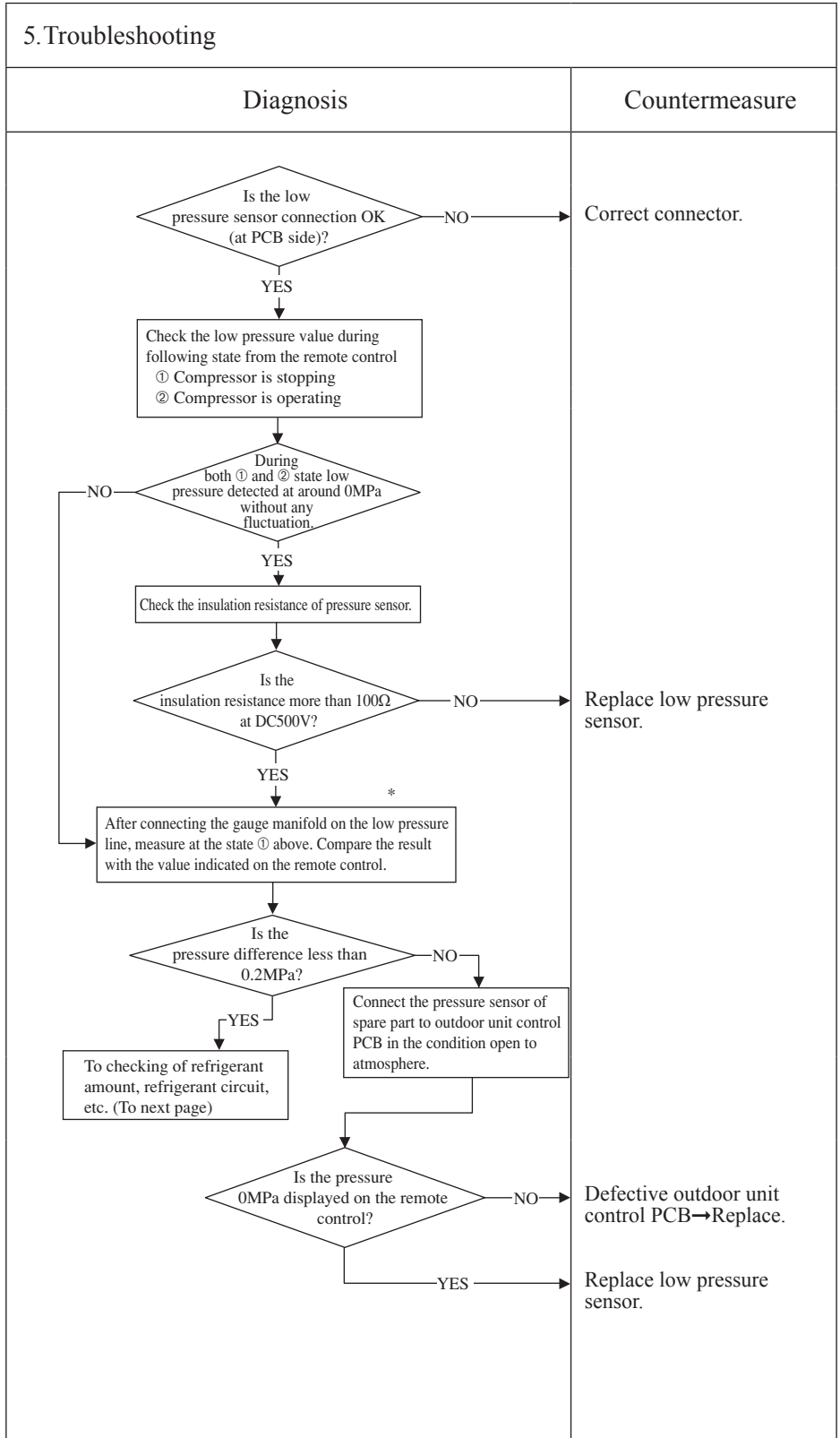

Note: * Connect the gauge manifold to the service valve check joint during cooling, or connect it to the check joint at internal piping of outdoor unit during heating.

Error code Remote control: E49	Indoor display	RUN light	TIMER light	Content Low pressure error or low pressure sensor anomaly (2/2)
	Outdoor unit control PCB	Green LED	Red LED	
		Keeps flashing	1-time flash	
	Outdoor unit inverter PCB	Yellow LED		
		Keeps flashing		

1.Applicable model
All models

2.Error detection method

3.Condition of error displayed

4.Presumable cause

5.Troubleshooting	
Diagnosis	Countermeasure
<pre> graph TD Start[From previous page.] --> D1{Is the service valve fully opened?} D1 -- NO --> C1[Open fully.] D1 -- YES --> D2{Are the connections of low pressure sensor and suction pipe temperature sensor connector OK?} D2 -- NO --> C2[Correct connector.] D2 -- YES --> D3{Are the characteristics of low pressure sensor, suction pipe temperature sensor OK?} D3 -- NO --> C3["Defective low pressure sensor, suction pipe temperature sensor → Replace."] D3 -- YES --> D4{Is the low pressure normal during operation?} D4 -- NO --> C4[Charge refrigerant.] D4 -- YES --> C5["Defective outdoor unit control PCB → Replace. (Defective low pressure sensor, suction pipe temperature sensor circuits)"] </pre>	

Note:

Error code Remote control: E51	Indoor display	RUN light ON	TIMER light 4-time flash	Content Inverter and fan motor anomaly
	Outdoor unit control PCB	Green LED Keeps flashing	Red LED 1-time flash	
		Yellow LED 6-time flash		
	Outdoor unit inverter PCB			

1. Applicable model
All models

2. Error detection method
When power transistor anomaly is detected for 15 minutes continuously

3. Condition of error displayed
Same as above

4. Presumable cause
<ul style="list-style-type: none"> • Defective outdoor fan motor • Defective inverter PCB • Defective outdoor unit control PCB

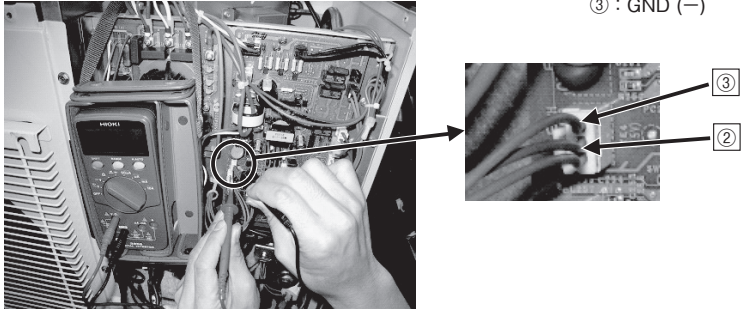
5. Troubleshooting	
Diagnosis	Countermeasure
<p>• Model FDC100-140VNX-W</p> <pre> graph TD Q1{Is DC15V detected between ② and ③ on CNI3? (1) (2)} Q2{Is DC15V detected after disconnecting outdoor fan motor? (1)} Q1 -- YES --> C1[Replace inverter PCB. If not solved, replace noise filter PCB as well.] Q1 -- NO --> Q2 Q2 -- YES --> C2[Replace outdoor fan motor.] Q2 -- NO --> C3[Replace outdoor unit control PCB. If not solved, replace inverter PCB as well.] </pre> <p>Note(1) Under anomalous conditions, the voltage becomes less than DC14V.</p> <p>• Model FDC100-140VSX-W Replace immediately the inverter PCB and the power transistor.</p> <p>Note(2) How to check the voltage between ② and ③ of CNI3</p>	
 <p>② : DC15V (+) ③ : GND (-)</p>	

Note:

Error code Remote control: E53	Indoor display	RUN light Keeps flashing	TIMER light 5-time flash	Content Suction pipe temperature sensor anomaly
	Outdoor unit control PCB	Green LED Keeps flashing	Red LED 1-time flash	
		Yellow LED Keeps flashing		
	Outdoor unit inverter PCB			

1. Applicable model
All models

2. Error detection method
When the suction pipe temperature sensor detects anomalously low temperature

3. Condition of error displayed
If the temperature sensor detects -50°C or lower for 5 seconds continuously within 10 minutes to 10 minutes 20 seconds after compressor ON, the compressor stops. When the compressor is restarted automatically after 3-minute delay, if this anomaly occurs 3 times within 40 minutes.

4. Presumable cause
<ul style="list-style-type: none"> • Defective suction pipe temperature sensor connection • Defective suction pipe temperature sensor • Defective outdoor unit control PCB

5. Troubleshooting	
Diagnosis	Countermeasure
<p style="text-align: center;">Temperature-resistance characteristics</p>	

Note:

Error code Remote control: E54	Indoor display	RUN light	TIMER light	Content Low pressure sensor anomaly
	Outdoor unit control PCB	Green LED	Red LED	
		Keeps flashing	1-time flash	
	Outdoor unit inverter PCB	Yellow LED		
Keeps flashing				

1. Applicable model
All models

2. Error detection method
When anomalous voltage (pressure) is detected

3. Condition of error displayed
If the pressure sensor detects DC0V or lower and DC4.0V or higher for 5 seconds continuously within 2 minutes to 2 minutes 20 seconds after compressor ON, the compressor stops. When the compressor is restarted automatically after 3-minute delay, if this anomaly occurs 3 times within 40 minutes.

4. Presumable cause
<ul style="list-style-type: none"> • Defective low pressure sensor connection • Defective low pressure sensor • Defective outdoor unit control PCB • Improper amount of refrigerant • Anomalous refrigeration circuit

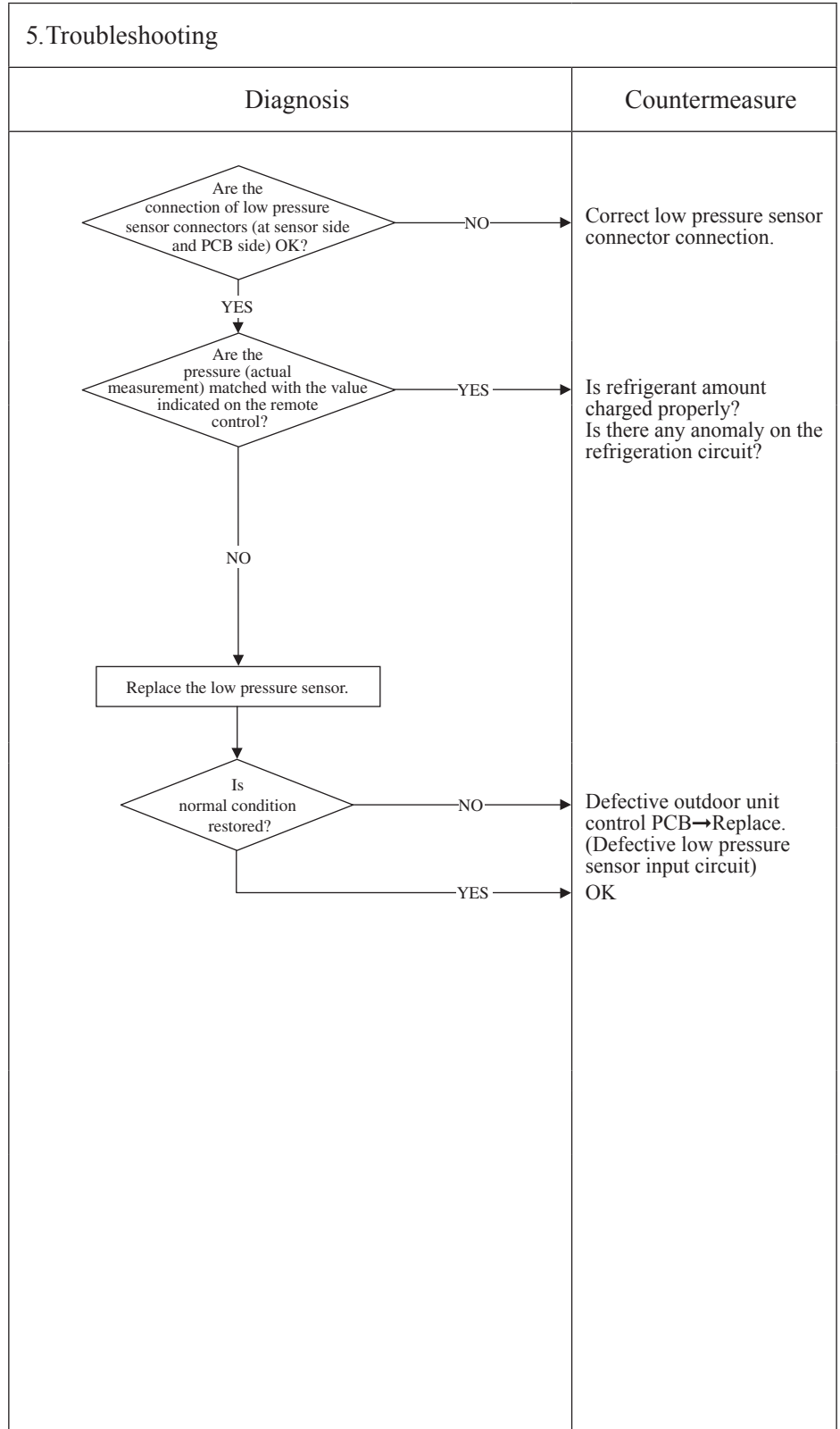

Note:

Error code Remote control: E57	Indoor display	RUN light 7-time flash	TIMER light ON	Content Insufficient refrigerant amount or detection of service valve closure
	Outdoor unit control PCB	Green LED Keeps flashing	Red LED 1-time flash	
		Yellow LED Keeps flashing		
	Outdoor unit inverter PCB			

1. Applicable model
All models

2. Error detection method
<ul style="list-style-type: none"> • Judge insufficient refrigerant amount by detecting the temperature difference between indoor heat exchanger (Th2) and indoor room (Th1). • It detects at initial startup in cooling or dehumidifying mode after power ON.

3. Condition of error displayed
Anomalous stop at initial detection

4. Presumable cause
<ul style="list-style-type: none"> • Defective indoor heat exchanger temperature sensor • Defective indoor room temperature sensor • Defective indoor unit control PCB • Insufficient refrigerant amount

5. Troubleshooting

Diagnosis	Countermeasure
<p>Indoor heat exchanger, room temperature sensor Temperature-resistance characteristics</p> <p>(Broken wire)</p> <p>(Short-circuit)</p>	

Note: Insufficient refrigerant amount preventive control makes compressor stopped, if it judges insufficient refrigerant amount by detecting the temperature difference between indoor heat exchanger (Th2) and room temperature (Th1) for 5 minutes after compressor ON in cooling or dehumidifying mode and for 9 minutes after compressor ON in heating mode. [in cooling mode: (Th1)-(Th2)<4degC, in heating mode: (Th2)-(Th1)<4degC]

Error code Remote control: E59	Indoor display	RUN light	TIMER light	Content Compressor startup failure (1/2)
	Outdoor unit control PCB	Green LED	Red LED	
		Keeps flashing	5-time flash	
	Outdoor unit inverter PCB	Yellow LED		
		Stays OFF		

1. Applicable model
All models

2. Error detection method
When it fails to change over to the operation for rotor position detection of compressor motor

3. Condition of error displayed
If the compressor fails to startup for 20 times (10 patterns × 2 times) continuously.

4. Presumable cause
<ul style="list-style-type: none"> Faulty outdoor fan motor Faulty outdoor unit control PCB Faulty inverter PCB Anomalous power source voltage Insufficient or excessive refrigerant amount Faulty component for refrigerant circuit Compressor anomaly (Motor or bearing)

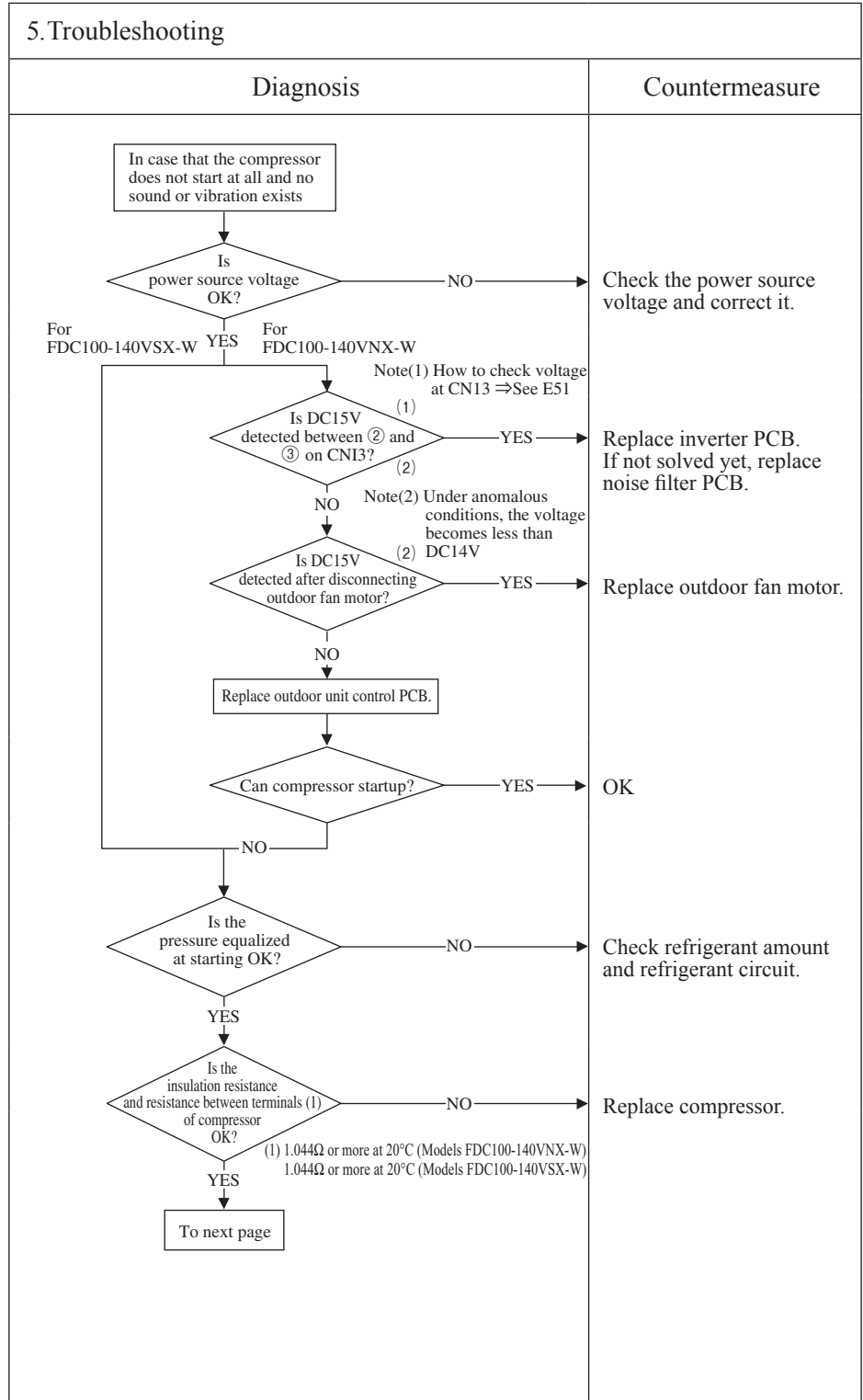

Note: Insulation resistance

- The unit is left for long period without power source or soon after installation, insulation resistance may decrease to several MΩ or lower due to the liquid refrigerant migrated in the refrigerant oil in compressor. If the electric leakage breaker is activated due to low insulation resistance, check followings.
 - ① Check whether the insulation resistance can recover or not, after 6 hours has passed since power ON.
(By energize the crankcase heater, liquid refrigerant migrated in the refrigerant oil in compressor can be evaporated)
 - ② Check whether the electric leakage breaker conforms to high-harmonic specifications
(As INVERTER PAC units has inverter, in order to prevent from improper operation, be sure to use the breaker of high-harmonic type)

Error code Remote control: E59	Indoor display	RUN light	TIMER light	Content Compressor startup failure (2/2)
	Outdoor unit control PCB	Green LED	Red LED	
		Keeps flashing	5-time flash	
	Outdoor unit inverter PCB	Yellow LED		
Stays OFF				

1. Applicable model
All models

2. Error detection method

3. Condition of error displayed

4. Presumable cause

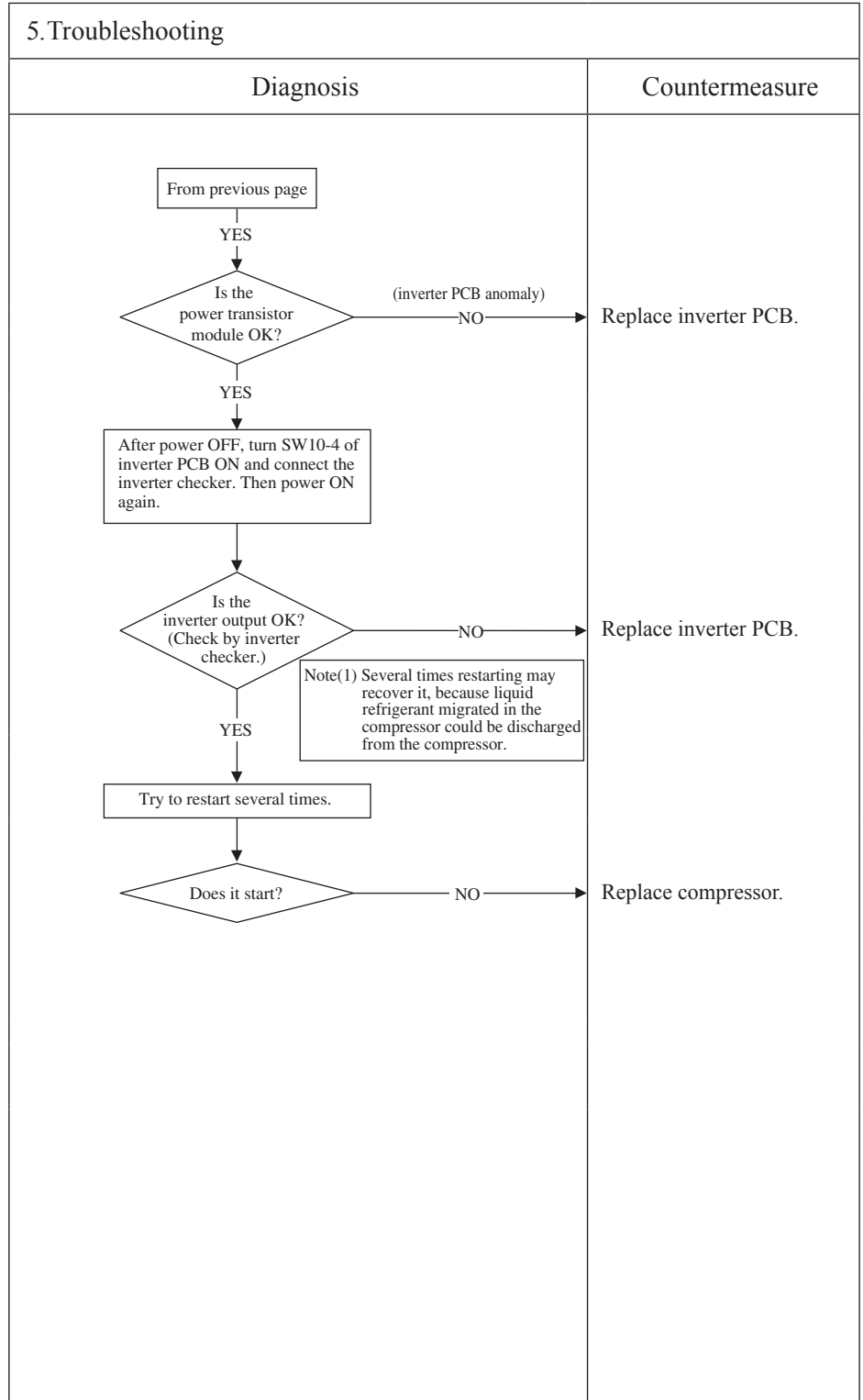

Note:

1.3 DISASSEMBLY PROCEDURE

WARNING **Precautions for safety**

- Read these "Precautions for safety" carefully before starting disassembly work and do it in the proper way.
- When disassembling, be sure to turn off the power. When disassembling the electrical components, check the electrical wiring diagram.
- The electrical components are under high voltage by the operation of the booster capacitor.
Fully discharge the capacitor before commencing a repair work. Failure to observe this warning could result in electric shock.
- When parts of refrigerant cycle is disassembled by welding, be sure to work after collecting a refrigerant, if the refrigerant isn't collected, the unit might explode.
- Be sure to collect refrigerant without spreading it in the air.
- These contents are an example. Please refer to a similar part of actual unit.

(1) Indoor units
(a) FDT series

PJF012D045



- 1. To remove the lid of control box**
(1) Remove 2 lid fixing screws and remove it.

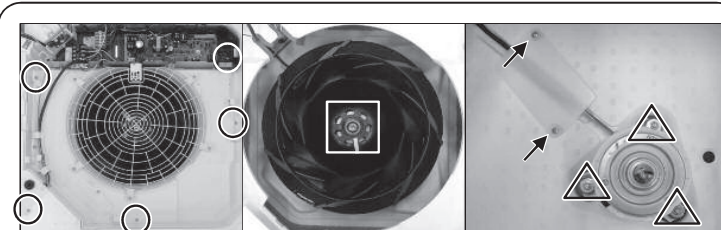

- 3. To remove the impeller and motor (FM)**
(1) Remove the lid of control box.(See No.1)
(2) Disconnect the motor connector(CNMx) on PCB in control box.
(3) Remove 5 bellmouth fixing screws and remove it.(○ mark)
(4) Remove the impeller fixing nut and remove it.(□ mark)
(5) Remove 2 plate fixing screws and remove it.(← mark)
(6) Remove 3 motor fixing nuts and remove it.(△ mark)

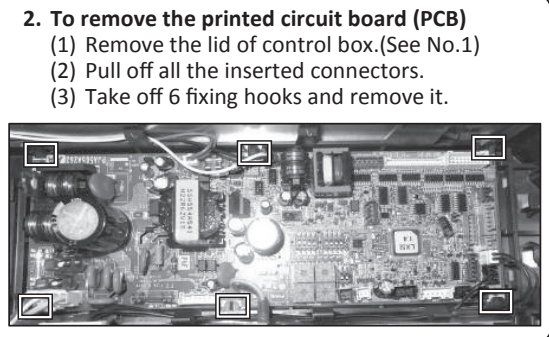

- 2. To remove the printed circuit board (PCB)**
(1) Remove the lid of control box.(See No.1)
(2) Pull off all the inserted connectors.
(3) Take off 6 fixing hooks and remove it.

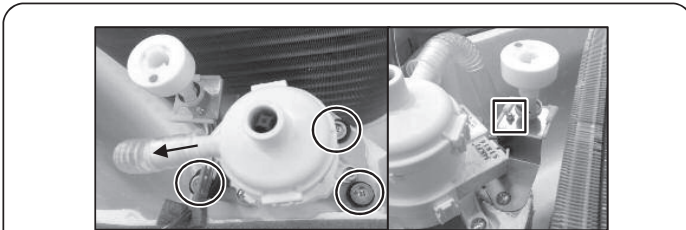

- 5. To remove drain pump (DM) and flot switch (FS)**
(1) Remove the drain pan.(See No.4)
(2) Pull the hose to the arrow direction and remove it.
(3) Remove 3 drain pump fixing screws and remove it.(○ mark)
(4) Remove the flot switch fixing screw and remove it.(□ mark)

- 4. To remove the drain pan**
(1) Remove the lid of control box.(See No.1)
(2) Pull off all the inserted connectors.
(3) Remove 2 plate fixing screws and remove it.
(○ mark)
(4) Remove 2 lid fixing screws and remove it.
(□ mark)
(5) Remove 4 drain pan fixing screws and remove it.
(← mark)

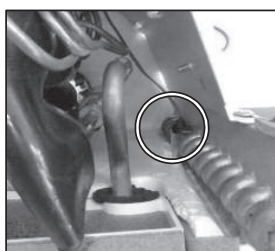
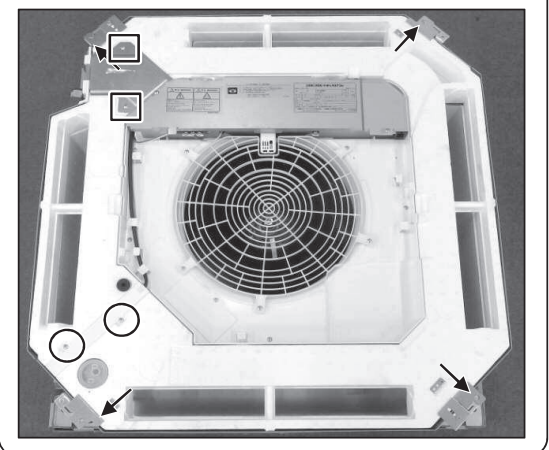

- 6. To remove the temperature sensors (example"Thi-R1")**
(1) Remove the drain pan.(See No.4)
(2) Pull out the temperature sensor"Thi-R1" from the sensor holder.

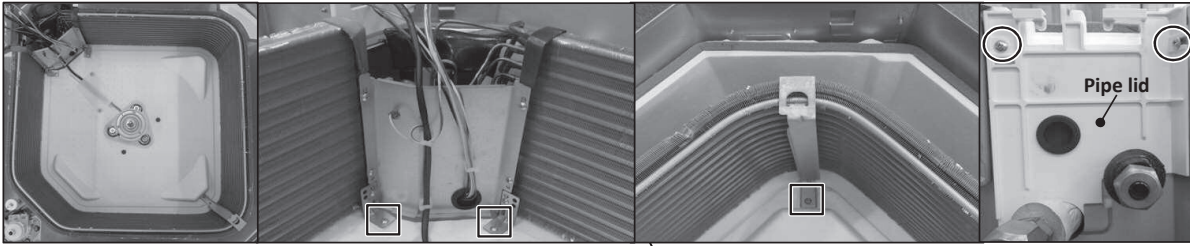

7. To remove the heat exchanger assembly

- (1) Remove the drain pan.(See No.4)
- (2) Remove 2 pipe lid fixing screws and remove it.(○ mark)
- (3) Remove 3 heat exchanger assembly fixing screws and remove it.(□ mark)

8. To remove the Electronic Expansion Valve (EEV)

- (1) Remove the heat exchanger assembly.(See No.7)
- (2) Remove the coil of EEV by pull out on the top.
- (3) Remove welded part of EEV by welding.(○ mark)

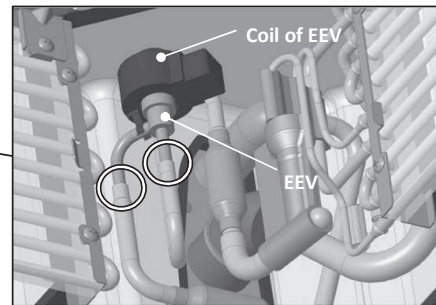

General view

(b) FDTC series

PJA012D792A 

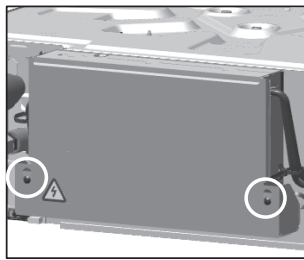

1. To remove the lid of control box
 (1) Remove 2 lid fixing screws then remove the lid.

2. To remove the printed circuit board (PCB)
 (1) Remove the lid of control box. (See No.1)
 (2) Pull off all the inserted connectors.
 (3) Take off 6 fixing hooks then remove the PCB.

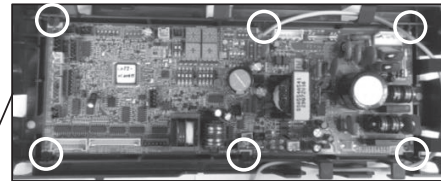

3. To remove the impeller and motor (FM)

- (1) Remove 4 bellmouth fixing screws then remove the bellmouth. (○ mark)
- (2) Remove the turbo fan fixing nut then remove the turbo fan. (□ mark)
- (3) Remove 2 plate fixing screws then remove the plate. (← mark)
- (4) Disconnect the motor connector (CNMx) in the middle of wiring.
- (5) Remove 3 motor fixing nuts then remove the motor. (△ mark)

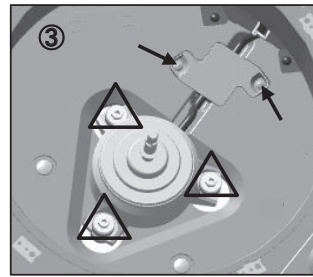
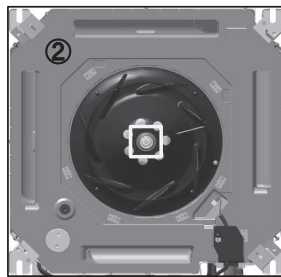
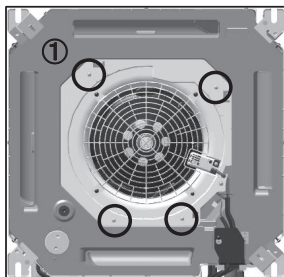

4. To remove the drain pan

- (1) Remove the lid of control box. (See No.1)
- (2) Remove the plate fixing screw then remove the plate. (○ mark)
- (3) Remove the sensor holder screw then remove the sensor holder. (□ mark)
- (4) Remove 4 drain pan fixing screws then remove the drain pan. (← mark)



5. To remove drain pump (DM) and float switch (FS)

- (1) Remove the lid of control box. (See No.1)
- (2) Disconnect the drain pump connector (CNRx) and float switch connector (CNlx).
- (3) Remove the drain pan. (See No.4)
- (4) Pull the hose to the arrow direction then remove the hose.
- (5) Remove 3 drain pump fixing screws then remove the drain pump. (○ mark)
- (6) Remove the float switch fixing screw then remove the float switch. (□ mark)

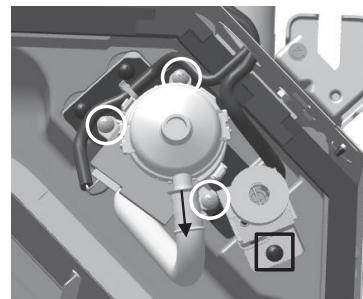

6. To remove the temperature sensors (example "Thi-R1")

- (1) Remove the lid of control box.(See No.1)
- (2) Disconnect the temperature sensor connector(CNNx).
- (3) Remove the drain pan.(See No.3)
- (4) Pull out the temperature sensor "Thi-R1" from the sensor holder.

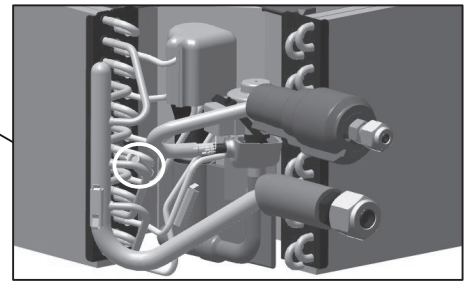

7. To remove the heat exchanger assembly

- (1) Remove the drain pan.(See No.4)
- (2) Remove 2 pipe lid fixing screws then remove the pipe lid.(□ mark)
- (3) Remove the fan motor wiring from clip and grommet.(← mark)
- (4) Remove 3 heat exchanger assembly fixing screws then remove the heat exchanger assembly.(○ mark)

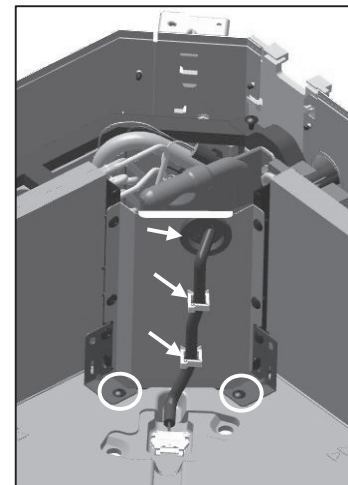
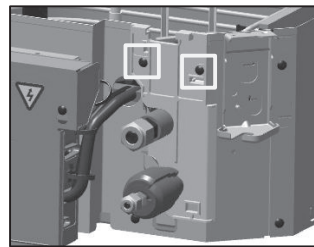
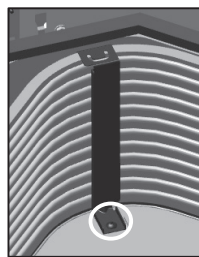
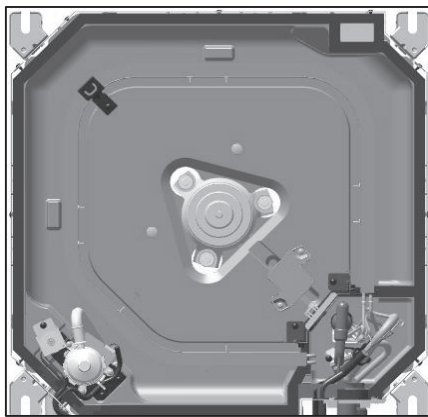

8. To remove the Electronic Expansion Valve (EEV)

- (1) Remove the heat exchanger assembly.(See No.7)
- (2) Remove the damper sealant from EEV.
- (3) Remove the coil of EEV by pull out on the top.
- (4) Remove welded part of EEV by welding.(○ mark)

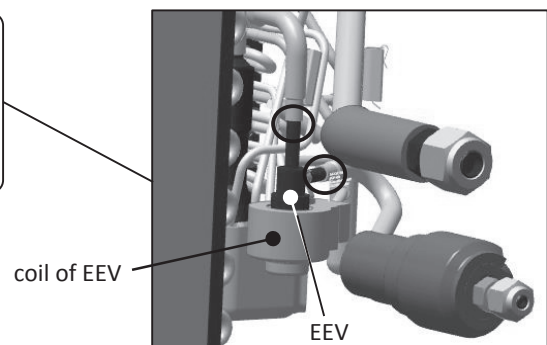

General view

(c) FDU, FDUM series

PJG012D019

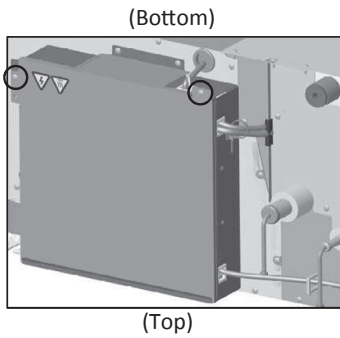

1. To remove the lid of control box
 (1) Remove 2 lid fixing screws and remove it.

2. To remove the printed circuit board (PCB)
 (1) Remove the lid of control box.(See No.1)
 (2) Pull off all the inserted connectors.
 ▪ **Control PCB**
 (3) Take off 4 control PCB fixing locking supports(○ mark) and remove it.
 ▪ **Power PCB**
 (4) Take off 6 power PCB fixing locking supports(○ mark) and remove it.

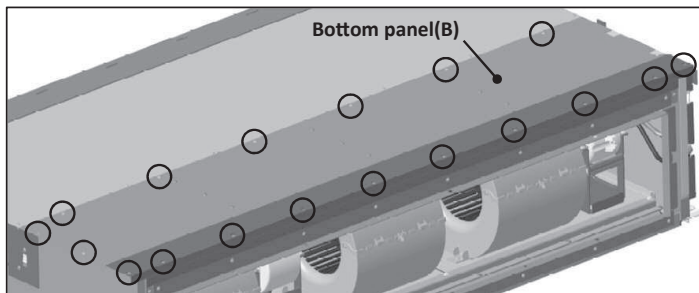
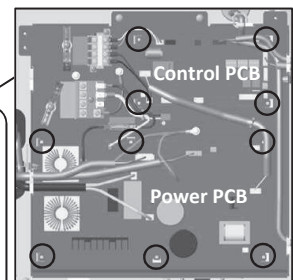

3. To remove the bottom panel(B)
 (1) Remove 18 panel fixing screws and remove it.

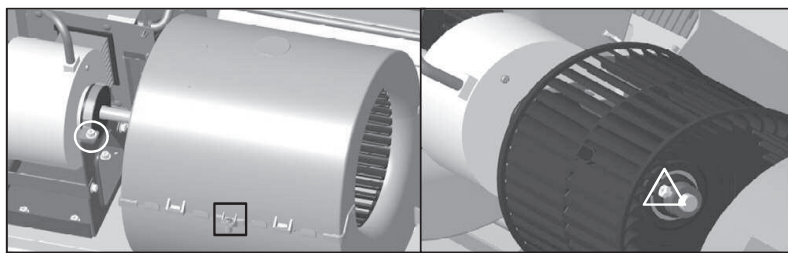

4. To remove the impellers and motors(FM)
 (1) Remove the lid of control box.(See No.1)
 (2) Remove the bottom panel(B).(See No.3)
 (3) Disconnect the motor connector(CNFMx or CNMx) on PCB in control box.
 (4) Remove the motor fixing screw and remove it.
 (○ mark/right and left side)
 (5) Remove the fan casing fixing screw and remove it.(□ mark)
 (6) Remove the sirocco fan fixing bolt and remove it.(△ mark)

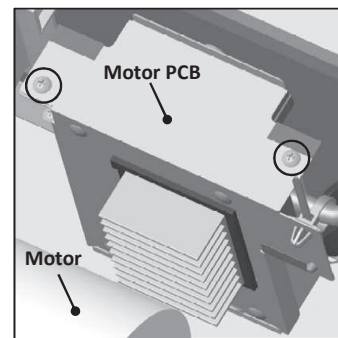

5. To remove the motor PCB
 (1) Remove the lid of control box.
 (See No.1)
 (2) Remove the bottom panel(B).
 (See No.3)
 (3) Disconnect the motor PCB connector
 (CNFMx or CNMx)on PCB in control box.
 (4) Remove 2 motor PCB fixing screws
 and remove it.

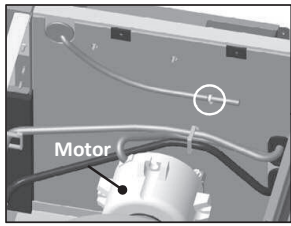

6. To remove the temperature sensors (example"Thi-A")
 (1) Remove the lid of control box.(See No.1)
 (2) Remove the bottom panel(B).(See No.3)
 (3) Disconnect the Thi-A connector(CNH) on PCB in control box.
 (4) Pull the temperature sensor fixing clip and remove it.(○ mark)

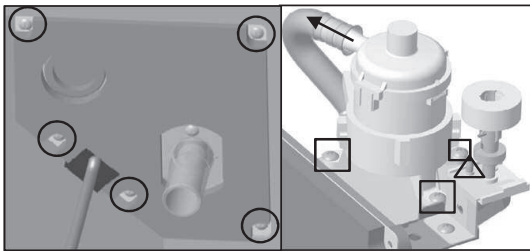

- 7. To remove the drain pump(DM) and float switch(FS)**
- (1) Remove the lid of control box.(See No.1)
 - (2) Remove 5 drain pump assembly fixing screws and remove it. (O mark)
 - (3) Disconnect the drain pump connector(CNR) on PCB in control box.
 - (4) Pull a hose to the arrow direction and remove it.
 - (5) Remove 3 drain pump fixing screws and remove it.(□ mark)
 - (6) Disconnect the float switch connector(CNI) on PCB in control box.
 - (7) Remove the float switch fixing screw and remove it.(Δ mark)

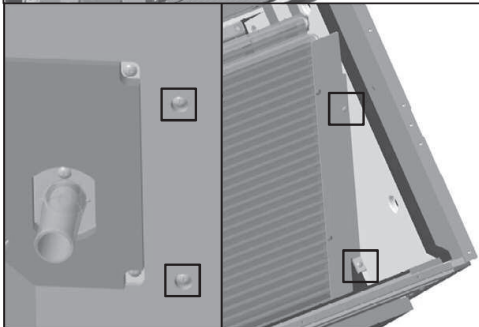
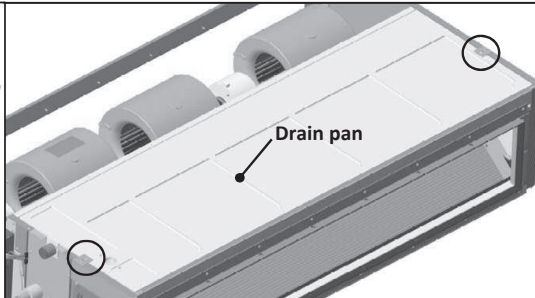
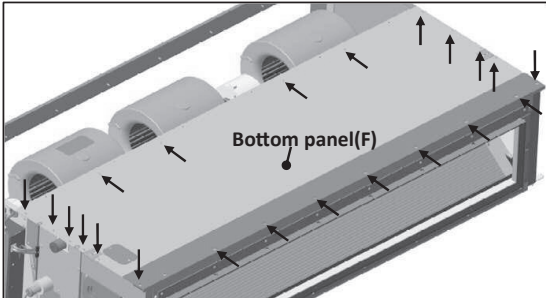

- 8. To remove the heat exchanger assembly**
- (1) Remove the bottom panel(B).(See No.3)
 - (2) Remove 22 bottom panel(F) fixing screws and remove it.(← mark)
 - (3) Remove 2 drain pan fixing screws and remove it.(O mark)
 - (4) Remove 4 heat exchanger assy fixing screws and remove it.(□ mark)

- 9. To remove the Electronic Expansion Valve (EEV)**
- (1) Remove the heat exchanger assembly.(See No.8)
 - (2) Remove the coil of EEV by pull out on the top.
 - (3) Remove welded part of EEV by welding.(O mark)

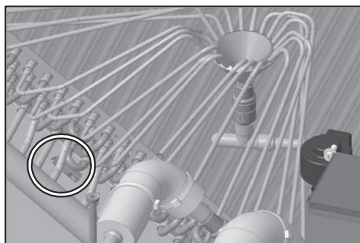
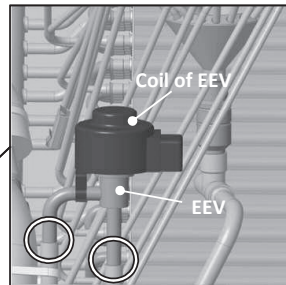

- 10. To remove the temperature sensors (example"Thi-R3")**
- (1) Remove the lid of control box.(See No.1)
 - (2) Disconnect the Thi-R3 connector(CNN) on PWB in control box.
 - (3) Remove the drain pan.(See No.8)
 - (4) Pull out the temperature sensor"Thi-R3" from the sensor holder.



(d) FDE series

PFA012D631

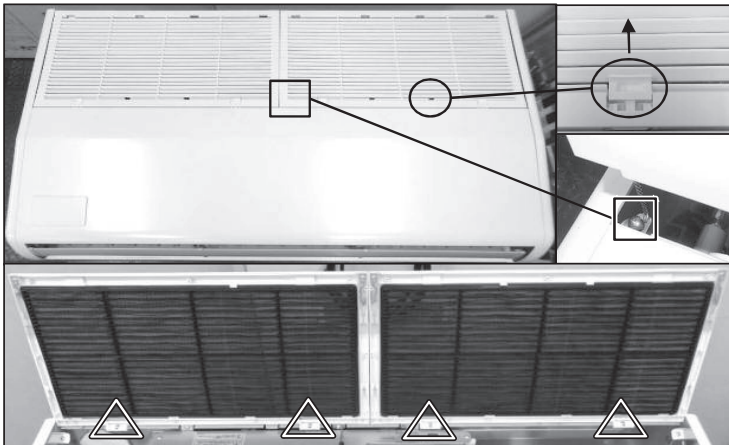

1. To remove air inlet grille.
 (1) Slide the hook in the direction of the arrow.(○ mark)
 (2) Remove 4 wire fixing screws.(□ mark)
 (3) Remove 4 air inlet grille fixing screws.(△ mark)

2. To remove the lid of control box
 (1) To remove air inlet grille.(See.No.1)
 (2) Remove 2 wire fixing screws and remove it.(← mark)
 (3) Remove 2 lid fixing screws and remove it.(○ mark)

3. To remove the control box
 (1) Remove the lid of control box.(See No.2)
 (2) Pull off all the inserted connectors.
 (3) Remove 2 control box fixing screws and remove it.(□ mark)
 (4) Pull out the control box.

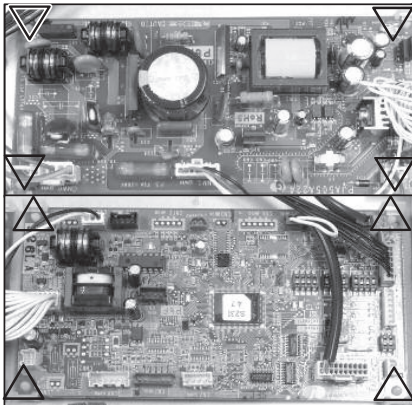

4. To remove the printed circuit board (PCB)
 (1) Remove the lid of control box.(See No.2)
 (2) Pull off all the inserted connectors.
 ▪ **Control PCB**
 (3) Take off 4 control PCB fixing locking supports and remove it.(△ mark)
 ▪ **Power PCB**
 (4) Take off 4 power PCB fixing locking supports and remove it.(▽ mark)

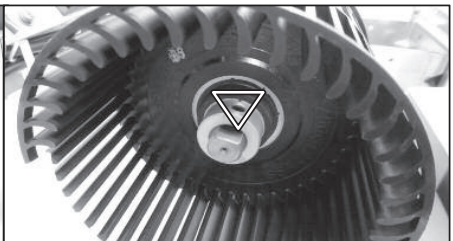
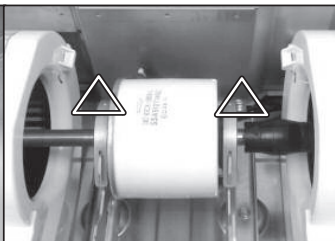
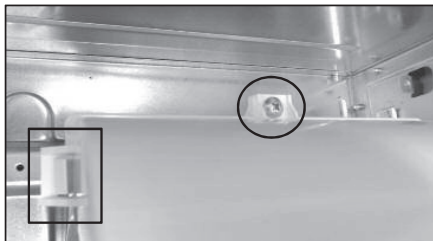

5. To remove the impeller and motor (FM)
 (1) Remove the lid of control box.(See No.1)
 (2) Disconnect the motor connector(CNFx) in the middle way of wiring.
 (3) Remove the fan casing fixing screw.(○ mark) Take off the fan casing fixing hook and remove it.(□ mark)
 (4) Remove the impeller fixing screw and remove it.(▽ mark) (5) Remove 2 motor fixing screws and remove it.(△ mark)

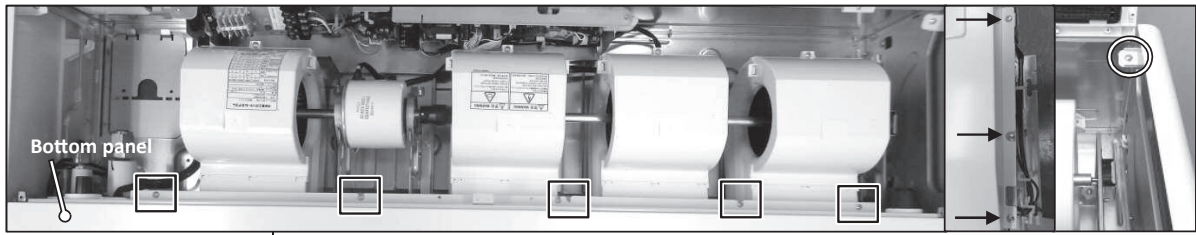

6. To remove side panel and bottom panel
 (1) Remove air inlet grille.(See No.1)
 (2) Remove the right and left side panel fixing screws and remove it.(○ mark)
 (3) Remove 5 bottom panel fixing screws.(□ mark)
 Remove 6 bottom panel fixing screws and remove it. (← mark, left and right side)

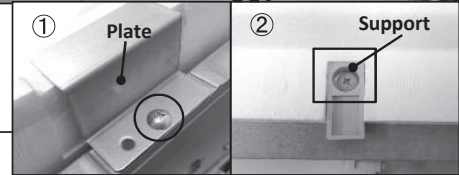
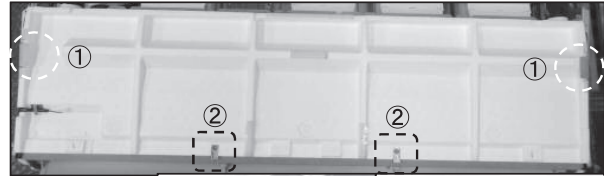

7. To remove drain pan
 (1) Remove side panel and bottom panel.(See No.5)
 (2) Remove 2 plate fixing screws and remove it.(○ mark, Pic.①)
 (3) Remove 2 support fixing screws and remove it.(□ mark, Pic.②)
 (4) Pull out the drain pan.

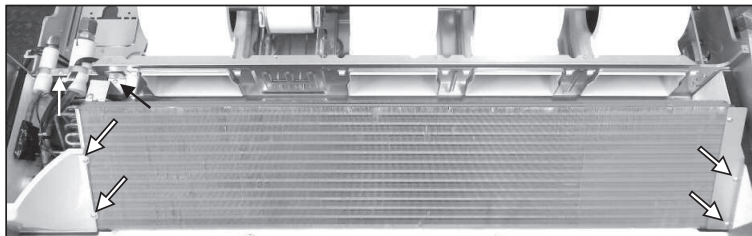

8. To remove the heat exchanger assembly
 (1) Remove the drain pan.(See No.6)
 (2) Remove 6 heat exchanger assy fixing screws and remove it.(← mark)

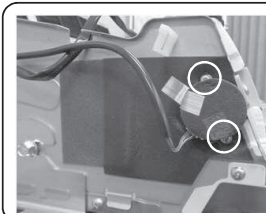
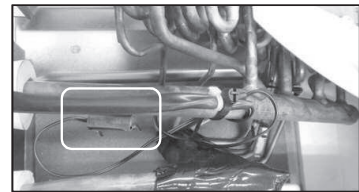

9. To remove the louver motor (LM)
 (1) Remove the lid of control box.(See No.1)
 (2) Disconnect the louver motor connector (CNJ) on PCB in control box.
 (3) Remove side panel.(See No.5)
 (4) Remove 2 louver motor fixing screws and remove it.

10. To remove the temperature sensors (example"Thi-R3")
 (1) Remove the lid of control box.(See No.1)
 (2) Disconnect the Tho-R3 connector(CNNx) on PCB in control box.
 (3) Remove the drain pan.(See No.3)
 (4) Pull out the temperature sensor"Thi-R1" from the sensor holder.

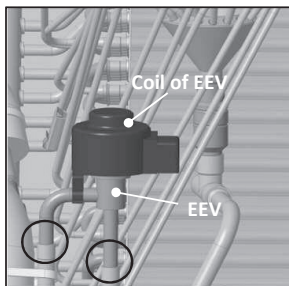

11. To remove the Electronic Expansion Valve (EEV)
 (1) Remove the heat exchanger assembly.(See No.9)
 (2) Remove the coil of EEV by pull out on the top.
 (3) Remove welded part of EEV by welding.(○ mark)



General view

(e) SRK series

PHA012D402

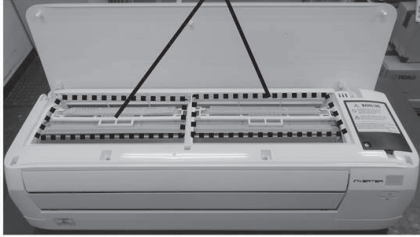
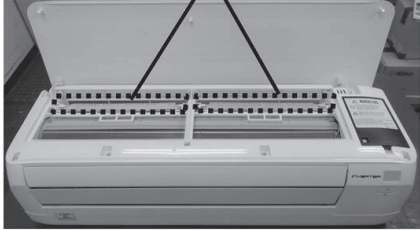
Item	Illustration	Operating procedure
①	<p style="text-align: center;">Air inlet panel</p> 	<p>[Removing the air inlet panel] 1. Hold lower edge of the air inlet panel, and then open it to about 80°.</p>
②	<p style="text-align: center;">Air filter</p>  <p style="text-align: center;">Air cleaning filter</p> 	<p>[Removing the filter] 1. Remove the air filter ×2.</p> <p>2. Remove the air-cleaning filter ×2</p> <p>3. Holding both sides of the air inlet panel, pull the left and right sides forward at the same time to remove the panel.</p>

Item	Illustration	Operating procedure
<p style="writing-mode: vertical-rl; transform: rotate(180deg);">③ Removing the front panel</p>		<p>1. Open the caps, and then remove the screw ×2 (circled in the illustration below)</p> <p>2. Draw the front panel above after removing 4 hooks</p> <p>Caution</p> <ul style="list-style-type: none"> • Be sure to use a fine-tipped tool (such as a precision screwdriver) to open the cap. • Be careful not to damage the panel surface when opening the caps.
<p style="writing-mode: vertical-rl; transform: rotate(180deg);">④ Removing the electrical controller and peripheral parts</p>		<p>[Removing the Controller]</p> <p>1. Remove screw x1 so as to remove a metal lid.</p> <p>2. Remove a metal lid then unplug the following connector x7</p> <ul style="list-style-type: none"> CNU(White) CNG(Black) CNF(White) CNE(Black) CNX(Black) CNY(Red) CNW(Blue) <p>3. Pull the each sensor out from the case into the indicated directions in red arrows.</p> <p>4. Remove screw x3 then draw the control toward right direction.</p>

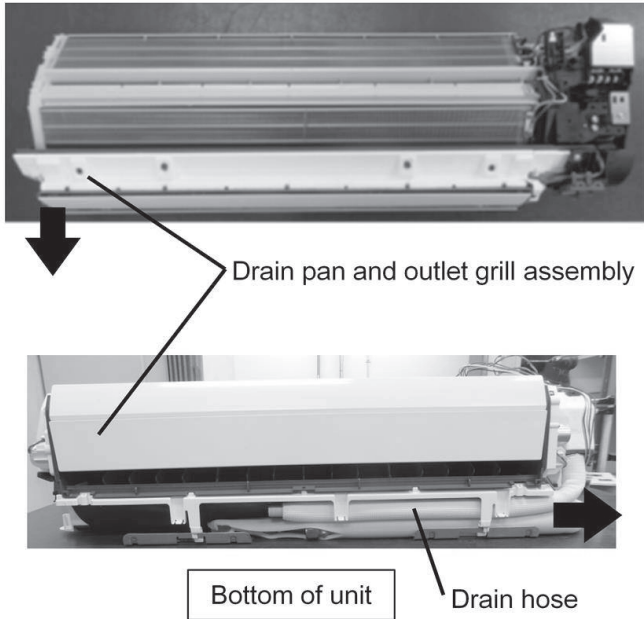
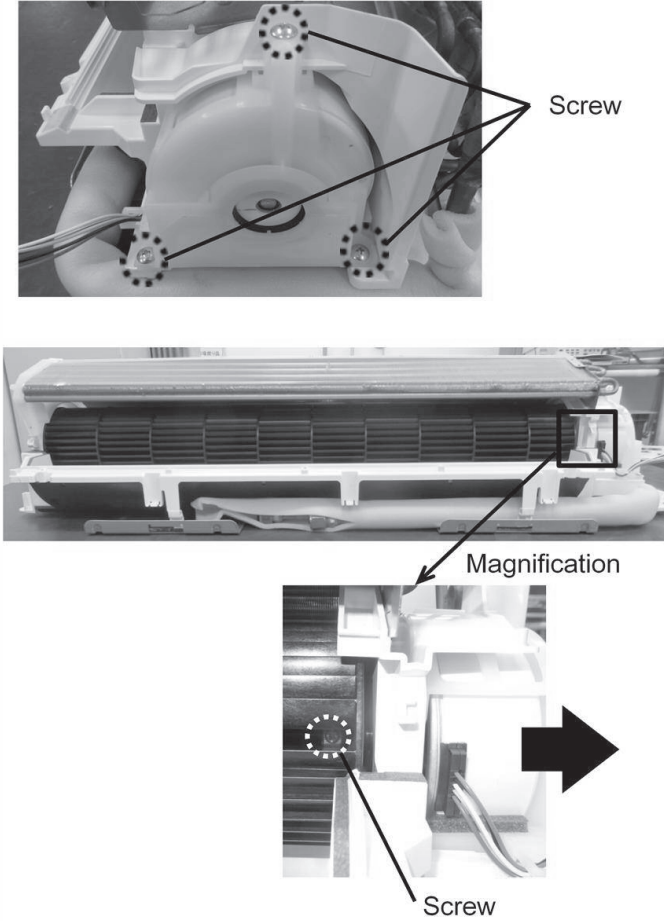
Item	Illustration	Operating procedure
<p style="writing-mode: vertical-rl; transform: rotate(180deg);">⑤ Removing drain pan & outlet grill assembly</p>		<p>[Removing the drain pan] 1. Draw the left of the drain pan and outlet grill assembly toward lower side so as to come off it from heat exchanger assembly.</p> <p>2. Draw the drain pan and outlet grill assembly toward the right with drawing the drain hose.</p>
<p style="writing-mode: vertical-rl; transform: rotate(180deg);">⑥ Removing fan & motor</p>		<p>[Removing fan & motor] 1. Remove screw x3</p> <p>2. Look into the area surrounded the black rectangle, adjust the screw position with rotating the cross flow fan, then remove a screw.</p> <p>3. Draw the motor and its bracket toward the right.</p>

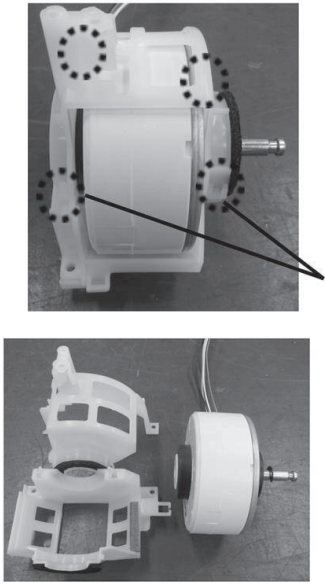
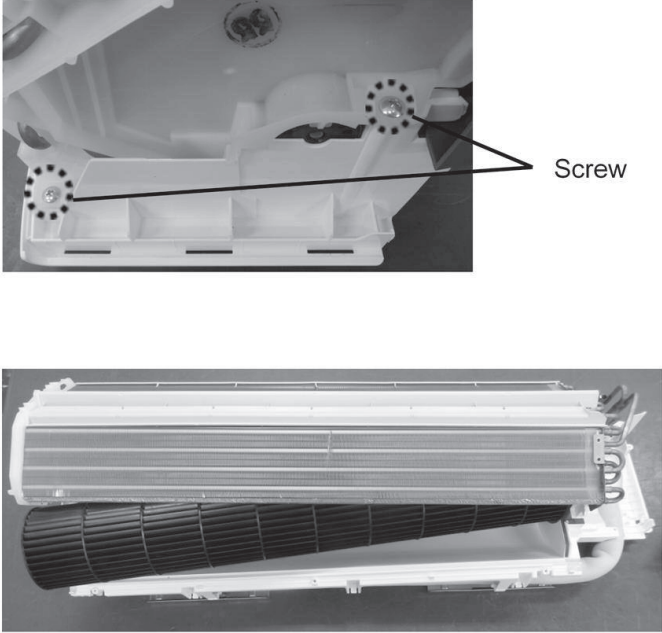
Item	Illustration	Operating procedure
<p style="text-align: center;">⑦</p> <p style="writing-mode: vertical-rl; transform: rotate(180deg);">Disassemble the motor</p>	 <p style="text-align: right;">Hook</p>	<p>[Removing the motor case] 1. Release the hook ×4 (circled in the illustration), and then remove the motor case (U).</p>
<p style="text-align: center;">⑧</p> <p style="writing-mode: vertical-rl; transform: rotate(180deg);">Removing the fan and heat exchanger</p>	 <p style="text-align: right;">Screw</p>	<p>1. Remove the screw ×2 (circled in the illustration) on the left side of the heat exchanger.</p> <p>2. While lifting up and supporting the left side of the heat exchanger, pull out the fan to the left, keeping it angled down.</p>

(2) Outdoor units

PCA012D087

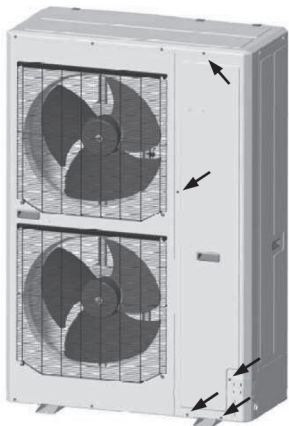

1. To remove the service panel
 (1) Remove 5 service panel fixing screws and remove it.

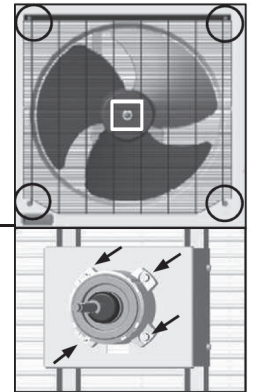

2. To remove the fan motor (FM)
 (1) Remove the service panel.(See No.1)
 (2) Disconnect the motor connector(FMxx) on PCB in control box.
 (3) Remove 4 fan guard fixing screws and remove it.(○ mark)
 (4) Remove the propeller fan fixing nut and remove it.(□ mark)
 (5) Remove 4 fan motor fixing nuts and remove it.(← mark)

3. To remove the 4-way valve (20S)
 (1) Remove the service panel.(See No.1)
 (2) Disconnect the coil of 4-way valve connector (CNS,CNNx) on PCB in control box.
 (3) Remove the coil of 4-way valve fixing screws (← mark) and remove it.
 (4) Remove welded part of 4-way valve by welding. (□ mark)

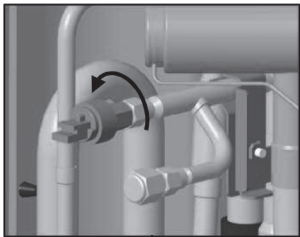
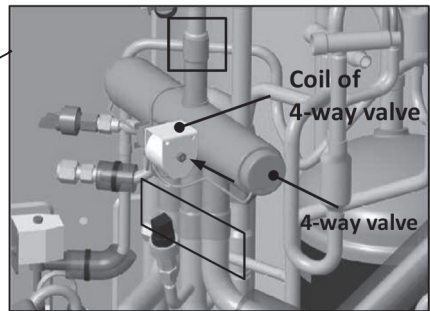

4. To remove the high pressure sensor (PSH)
 (1) Remove the service panel.(See No.1)
 (2) Disconnect the PSH connector(CNLx) on PCB in control box.
 (3) Turn PSH to the left and remove it.
 (Double spanners are needed.)

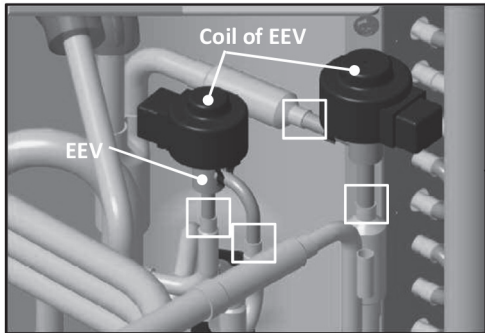

5. To remove the electronic expansion valve (EEV)
 (1) Remove the service panel.(See No.1)
 (2) Disconnect the EEV connector(CNEEVx) on PCB in control box.
 (3) Remove the coil of EEV by pull out on the top.
 (4) Remove welded part of EEV by welding. (□ mark)

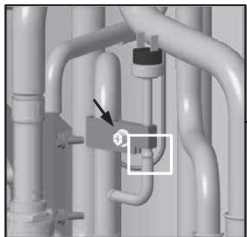
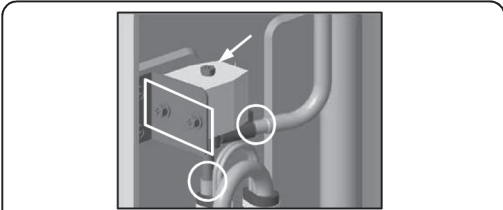

6. To remove the high pressure switch (63H)
 (1) Remove the service panel.(See No.1)
 (2) Disconnect the 63H connector(CNH or CNQx) on PCB in control box.
 (3) Remove the metal fitting fixing screws and remove it. (← mark)
 (4) Remove welded part of high pressure switch by welding. (□ mark)

7. To remove bypass valve (SV)
 (1) Remove the service panel.(See No.1)
 (2) Disconnect the SV connector(CNNxx) on PCB in control box.
 (3) Remove the coil of SV fixing screws. (← mark)
 (4) Remove 2 coil of SV fixing screws and remove it.(□ mark)
 (5) Remove welded part of SV by welding. (○ mark)

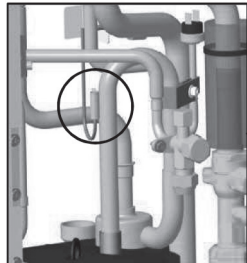

8. To remove the temperature sensors (example"Tho-D1")
 (1) Remove the service panel.(See No.1)
 (2) Disconnect the Tho-D1 connector(CNTH) on PCB in control box.
 (4) Pull out the temperature sensor "Tho-D1 , THxx" from the sensor holder.

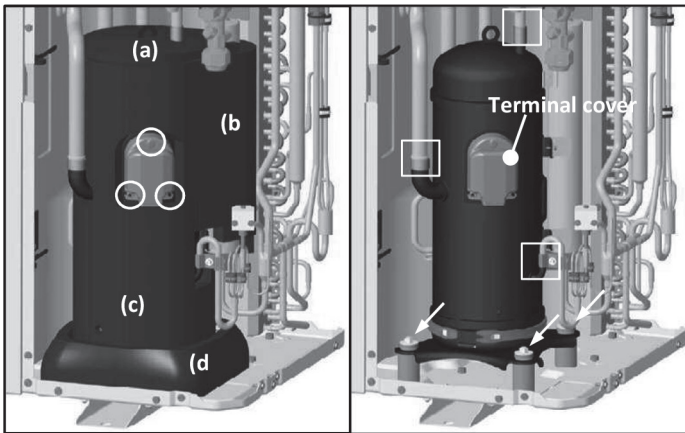

9. To remove the compressor (CM)

- (1) Remove the service panel.(See No.1)
- (2) Remove the insulation which covers compressors. (Strings (a)~(d) should be loosen.)
- (3) Remove 3 terminal cover fixing bolts(○ mark) and remove it and disconnect the power wiring.
- (4) Remove welded part of compressor by welding. (□ mark)
- (5) Remove 3 compressor fixing nuts(← mark) using spanner or adjustable wrench.

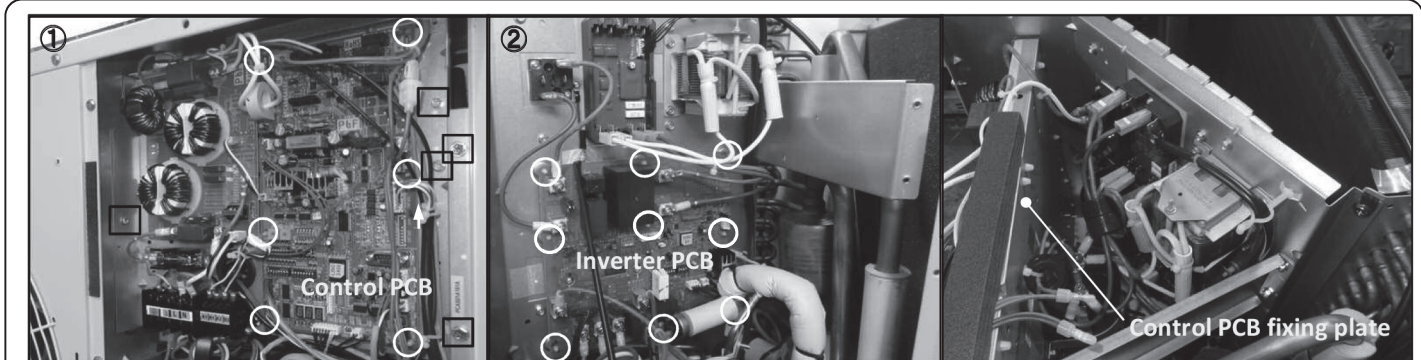

10. To remove the printed circuit board (PCB)

- (1) Remove the service panel and top panel.
- (2) Pull off all the inserted connectors of control PCB.(Pic.①)
- (3) Take off 6 control PCB fixing locking support and remove it.(○ mark, Pic.①)
- (4) Remove 5 plate fixing screws and open it.(□ mark, Pic.①)
- (5) Pull off all the inserted connectors of inverter PCB.(Pic.②)
- (6) Take off 9 inverter PCB fixing locking support and remove it.(○ mark, Pic.②)

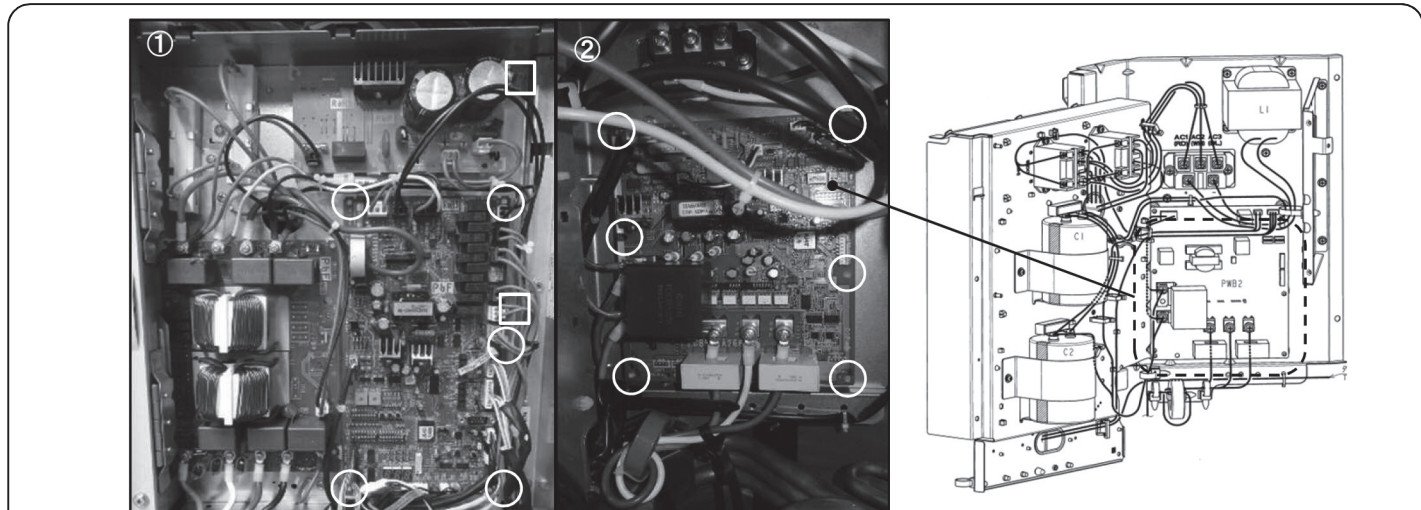

**11. To remove the printed circuit board (PCB)
«Hinge control type»**

- (1) Remove the service panel.
- (2) Pull off all the inserted connectors of control PCB.(Pic.①)
- (3) Take off 5 control PCB fixing locking supports and remove it.(○ mark, Pic.①)
- (4) Remove 2 plate fixing screws and open it.(□ mark, Pic.①)
- (5) Pull off all the inserted connectors of inverter PCB.(Pic.②)
- (6) Take off 6 inverter PCB fixing locking supports and remove it.(○ mark, Pic.②)

1.4 ELECTRICAL WIRING

(1) Indoor units

(a) Ceiling cassette-4 way type (FDT)

Models FDT50VH, 60VH, 71VH, 100VH, 125VH, 140VH

Item	Description
AM1-4	Draft prevention function motor
CNB-Z	Connector
DM	Drain pump motor
F1,2	Fuse
FMi	Fan motor
FS	Float switch
HS	Humidity sensor
L	Reactor
LED-2	Indication lamp (Green-Normal operation)
LED-3	Indication lamp (Red-Inspection)
LM1-4	Louver motor
PIS	Motion sensor
SW2	Remote control communication address
SW5	Plural units Master / Slave setting
SW6	Model capacity setting
SW7-1	Operation check drain pump motor test run
TB1	Terminal block (Power source) (□ mark)
TB2	Terminal block (Signal line) (□ mark)
Thc	Temperature sensor (Remote control)
Thi-A	Temperature sensor (Return air)
Thi-R1,2,3	Temperature sensor (Heat exchanger)

Color marks	Mark	Color	Mark	Color
	BK	Black	WH	White
	BL	Blue	YE	Yellow
	BR	Brown	GY	Gray
	OR	Orange	YE / GN	Yellow / Green
	RD	Red		

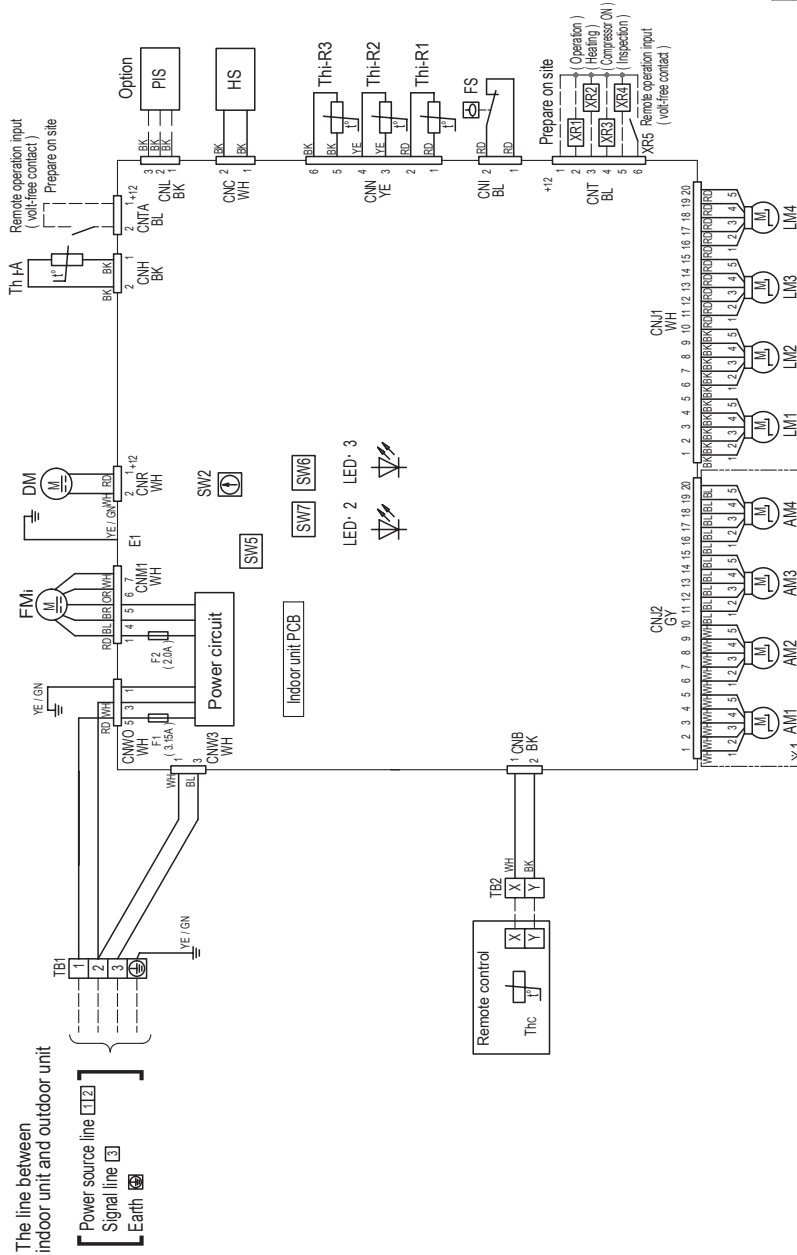

- The line between indoor unit and outdoor unit
- 1. — indicates wiring on site.
 - 2. See the wiring diagram of outside unit about the line between indoor unit and outdoor unit.
 - 3. Use twin core cord (0.3mm²) at remote control line.
 - 4. See spec. sheet of remote control in case that the total length is more than 100m.
 - 5. Do not put remote control line alongside power source line.
 - 6. Section 1 (※1) is provided on the panel T-PSAE-SAW-E only.

PJF000Z554

(b) Ceiling cassette-4 way compact type (FDTC)
 Models FDTC50VH, 60VH

Meaning of marks

Item	Description
AM1-4	Draft prevention function motor
CNB-Z	Connector
DM	Drain pump motor
F1,2	Fuse
FMI	Fan motor
FS	Float switch
HS	Humidity sensor
LED-2	Indication lamp (Green-Normal operation)
LED-3	Indication lamp (Red-Inspection)
LM1-4	Lower motor
PIS	Motion sensor
SW2	Remote control communication address
SW5	Plural units Master/ Slave setting
SW6	Model capacity setting
SW7-1	Operation check, drain pump motor test run
TB1	Terminal block (Power source) (□:mark)
TB2	Terminal block (Signal line) (□:mark)
Thc	Temperature sensor (Remote control)
Thi-A	Temperature sensor (Return air)
Thi-R1,2,3	Temperature sensor (Heat exchanger)

Color marks

Mark	Color	Mark	Color
BK	Black	WH	White
BL	Blue	YE	Yellow
BR	Brown	GY	Gray
OR	Orange	YE/GN	Yellow/Green
RD	Red		

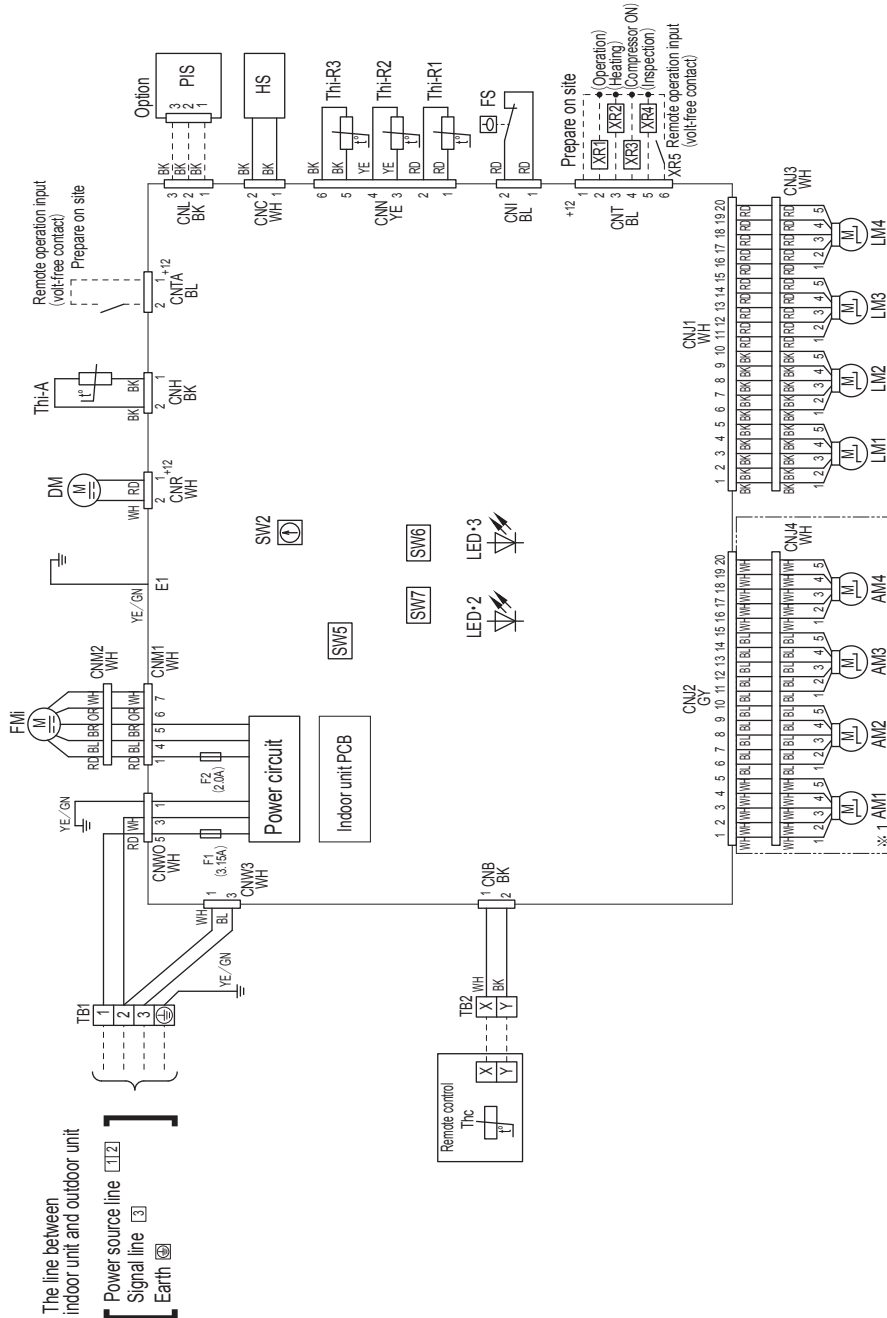

- Notes
1. - - - - indicates wiring on site.
 2. See the wiring diagram of outdoor unit about the line between indoor unit and outdoor unit.
 3. Use twin core cord (0.3mm²) at remote control line.
 4. Do not put remote control line alongside power source line.
 5. Draft prevention function (※ 1) is provided on the panel TC-PSAE-5AW-E only.

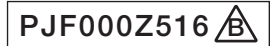

(c) Duct connected-High static pressure type (FDU)

Models FDU100VH, 125VH, 140VH

Meaning of marks

Item	Description
CNB-Z	Connector
DM	Drain pump motor
F1,3,4	Fuse
FMI1,2	Fan motor
FS	Float switch
L	Reactor
LED-2	Indication lamp (Green-Normal operation)
LED-3	Indication lamp (Red-Inspection)
PIS	Motion sensor
SW2	Remote control communication address
SW5	Plural units Master / Slave setting
SW6	Model capacity setting
SW7-1	Operation check drain pump motor test run
TB1	Terminal block (Power source) (□mark)
TB2	Terminal block (Signal line) (□mark)
Thc	Temperature sensor (Remote control)
Th-A	Temperature sensor (Return air)
Th-R1,2,3	Temperature sensor (Heat exchanger)
□mark	Closed-end connector

Color Marks	Color
BK	Black
BL	Blue
RD	Red
WH	White
YE	Yellow
YE/GN	Yellow/Green

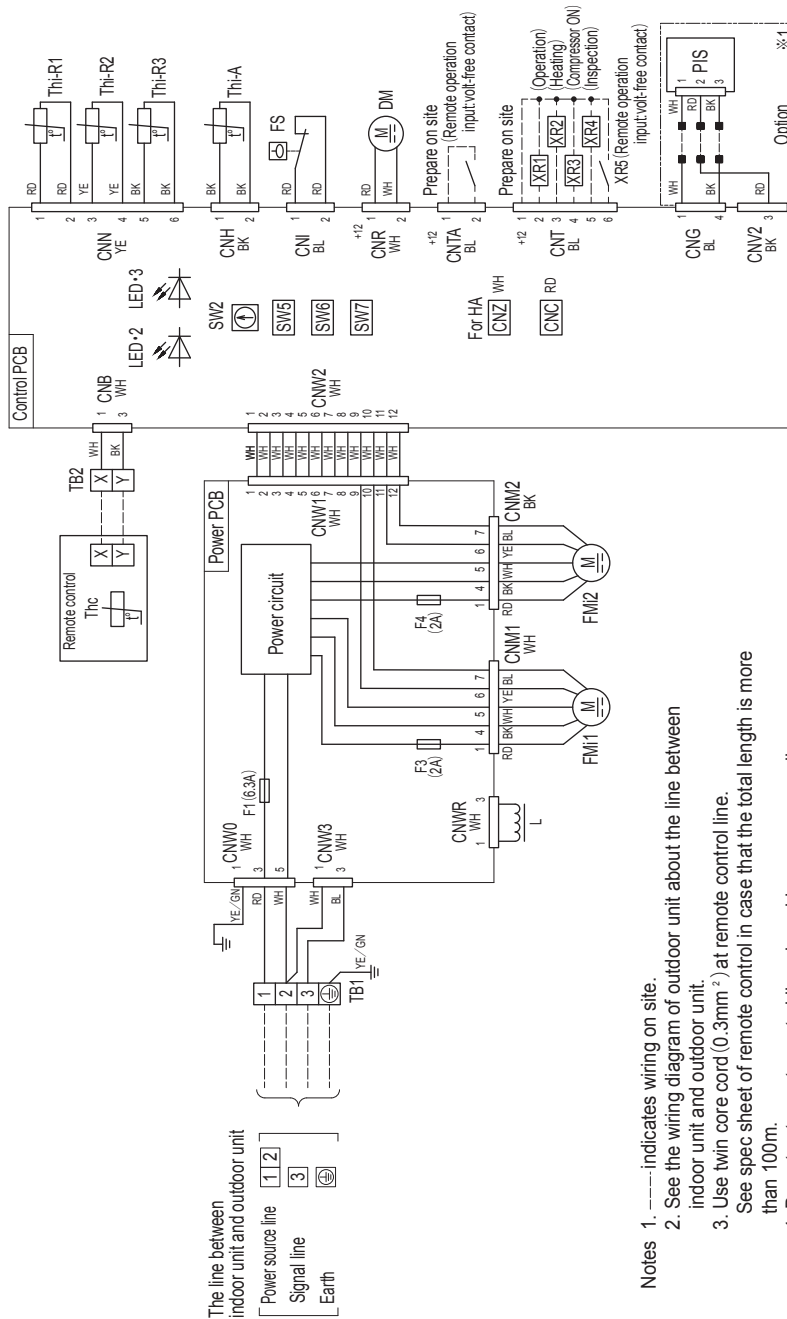

- The line between indoor unit and outdoor unit
- 1. --- indicates wiring on site.
 - 2. See the wiring diagram of outdoor unit about the line between indoor unit and outdoor unit.
 - 3. Use twin core cord (0.3mm²) at remote control line. See spec sheet of remote control in case that the total length is more than 100m.
 - 4. Do not put remote control line alongside power source line.
 - 5. Section 1 (※1) shows electric circuit of motion sensor (Option).

PJG000Z580

(d) Duct connected-Low / Middle static pressure type (FDUM)

Model FDUM50VH

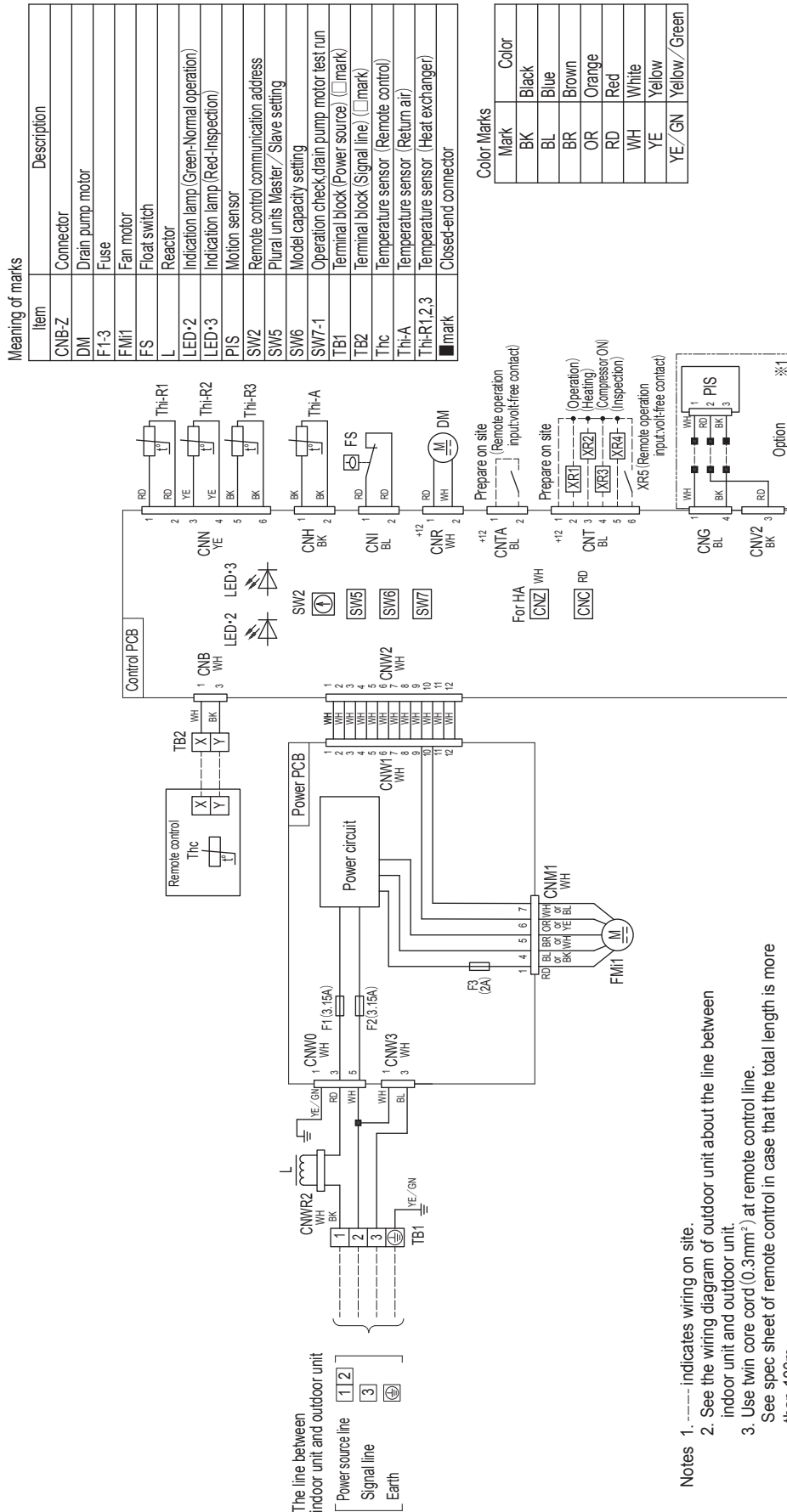

- Notes
1. --- indicates wiring on site.
 2. See the wiring diagram of outdoor unit about the line between indoor unit and outdoor unit.
 3. Use twin core cord (0.3mm²) at remote control line. See spec sheet of remote control in case that the total length is more than 100m.
 4. Do not put remote control line alongside power source line.
 5. Section 1 (※1) shows electric circuit of motion sensor (Option).

PJG000Z488

Models FDUM60VH, 71VH

Meaning of marks

Item	Description
CNB-Z	Connector
DM	Drain pump motor
F1.4	Fuse
FM2	Fan motor
FS	Float switch
LED-2	Indication lamp (Green-Normal operation)
LED-3	Indication lamp (Red-Inspection)
PIS	Motion sensor
SW2	Remote control communication address
SW5	Plural units Master / Slave setting
SW6	Model capacity setting
SW7-1	Operation check, drain pump motor test run
TB1	Terminal block (Power source) (□mark)
TB2	Terminal block (Signal line) (□mark)
Thc	Temperature sensor (Remote control)
Thi-A	Temperature sensor (Return air)
Thi-R1,2,3	Temperature sensor (Heat exchanger)
■mark	Closed-end connector

Mark	Color
BK	Black
BL	Blue
BR	Brown
OR	Orange
RD	Red
WH	White
YE	Yellow
YE/GN	Yellow/Green

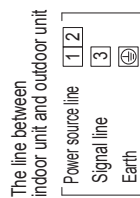
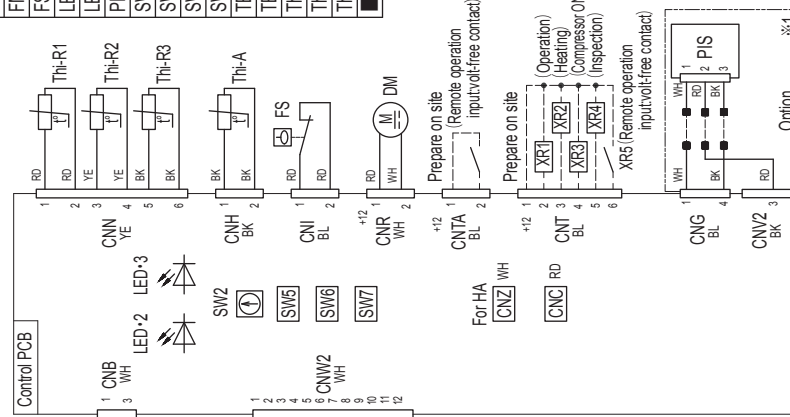

The line between indoor unit and outdoor unit

- Notes
1. --- indicates wiring on site.
 2. See the wiring diagram of outdoor unit about the line between indoor unit and outdoor unit.
 3. Use twin core cord (0.3mm²) at remote control line. See spec sheet of remote control in case that the total length is more than 100m.
 4. Do not put remote control line alongside power source line.
 5. Section 1 (※1) shows electric circuit of motion sensor (Option).

PJG000Z489

Models FDUM100VH, 125VH, 140VH

Meaning of marks

Item	Description
CNB-Z	Connector
DM	Drain pump motor
F1.3.4	Fuse
FMI1,2	Fan motor
FS	Float switch
L	Reactor
LED•2	Indication lamp (Green-Normal operation)
LED•3	Indication lamp (Red-Inspection)
PIS	Motion sensor
SW2	Remote control communication address
SW5	Plural units Master / Slave setting
SW6	Model capacity setting
SW7-1	Operation check drain pump motor test run
TB1	Terminal block (Power source) (□ mark)
TB2	Terminal block (Signal line) (□ mark)
Thc	Temperature sensor (Remote control)
Thi-A	Temperature sensor (Return air)
Thi-R1,2,3	Temperature sensor (Heat exchanger)
■ mark	Closed-end connector

Color Marks	Mark	Color
	BK	Black
	BL	Blue
	BR	Brown
	OR	Orange
	RD	Red
	WH	White
	YE	Yellow
	YE/GN	Yellow/Green

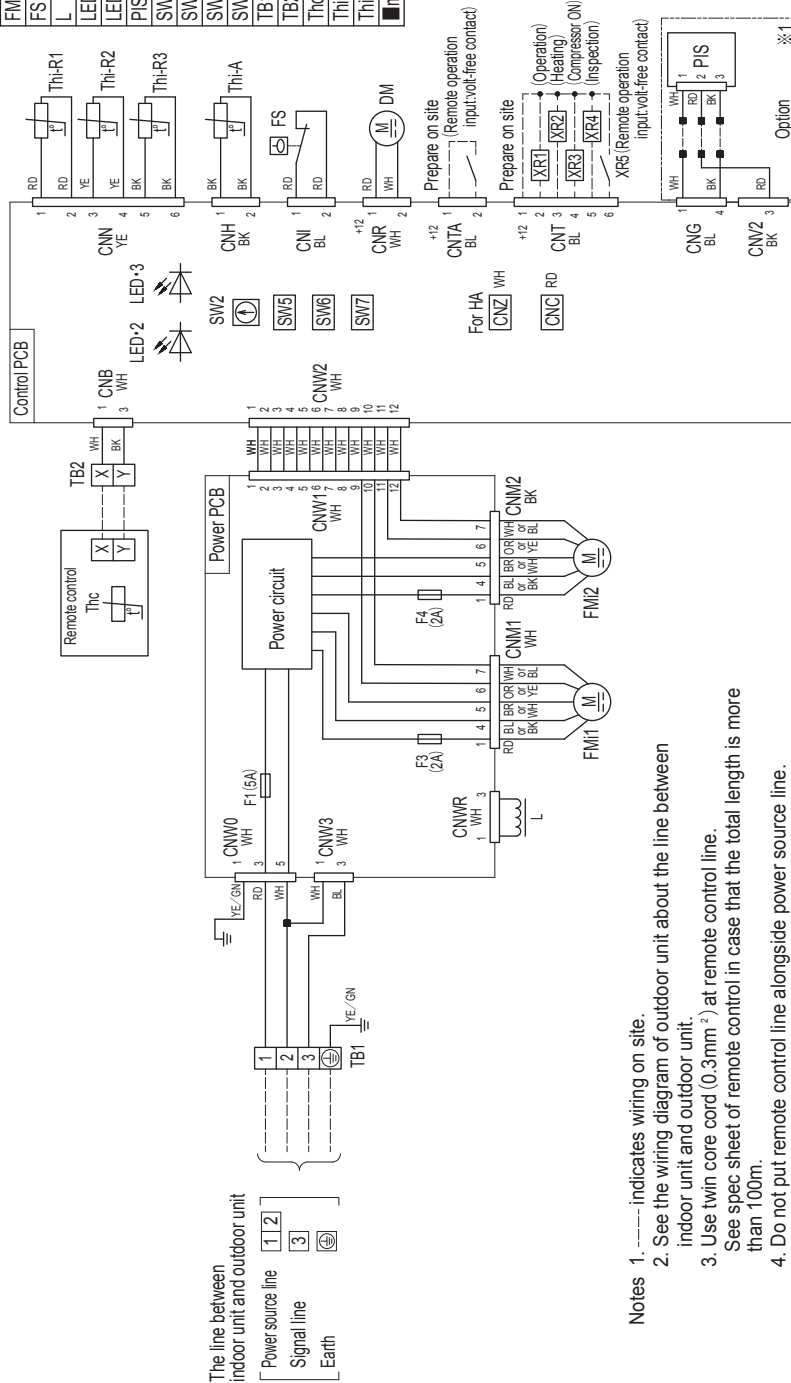

- The line between indoor unit and outdoor unit
- 1 Power source line
 - 2 Signal line
 - 3 Earth
- Notes
1. ----- indicates wiring on site.
 2. See the wiring diagram of outdoor unit about the line between indoor unit and outdoor unit.
 3. Use twin core cord (0.3mm²) at remote control line. See spec sheet of remote control in case that the total length is more than 100m.
 4. Do not put remote control line alongside power source line.
 5. Section 1 (※1) shows electric circuit of motion sensor (Option).

PJG000Z490

(e) Ceiling suspended type (FDE)

Models FDE50VH, 60VH, 71VH, 100VH, 125VH, 140VH

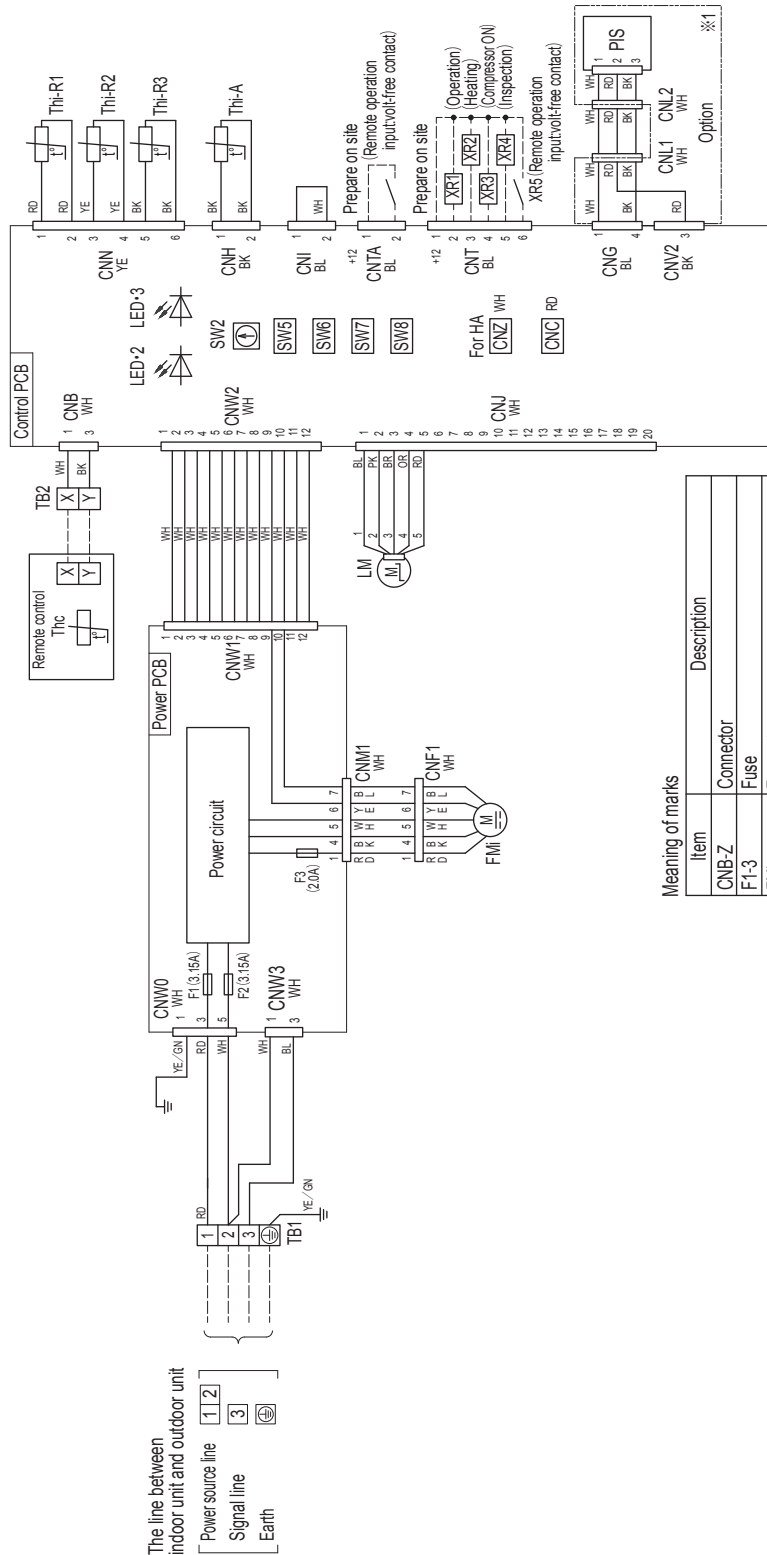

Color marks

Mark	Color
BK	Black
BL	Blue
BR	Brown
OR	Orange
PK	Pink
RD	Red
WH	White
YE	Yellow
YE/GN	Yellow/Green

Meaning of marks

Item	Description
CNB-Z	Connector
F1-3	Fuse
FMi	Fan motor
L	Reactor
LED-2	Indication lamp (Green-Normal operation)
LED-3	Indication lamp (Red-Inspection)
LM	Louver motor
PIS	Motion sensor
SW2	Remote control communication address
SW5	Plural units Master/ Slave setting
SW6	Model capacity setting
SW7-1	Operation check drain pump motor test run
SW8-1	Anti-freeze control
TB1	Terminal block (Power source) (□mark)
TB2	Terminal block (Signal line) (□mark)
Thc	Temperature sensor (Remote control)
Thi-A	Temperature sensor (Return air)
Thi-R1,2,3	Temperature sensor (Heat exchanger)

- Notes
1. --- indicates wiring on site.
 2. See the wiring diagram of outdoor unit about the line between indoor unit and outdoor unit.
 3. Use twin core cord (0.3mm²) at remote control line.
See spec sheet of remote control in case that the total length is more than 100m.
 4. Do not put remote control line alongside power source line.
 5. Section 1 (※1) shows electric circuit of motion sensor (Option).

PFA004Z087

(f) Wall mounted type (SRK)

Models SRK50ZSX-W, 60ZSX-W

Item	Description
CNE	Connector
CNF	
CNG	
CNJ	
CNL	
CNM	
CNP	
CNS	
CNU	
CNX	
CNY	
CNZ	

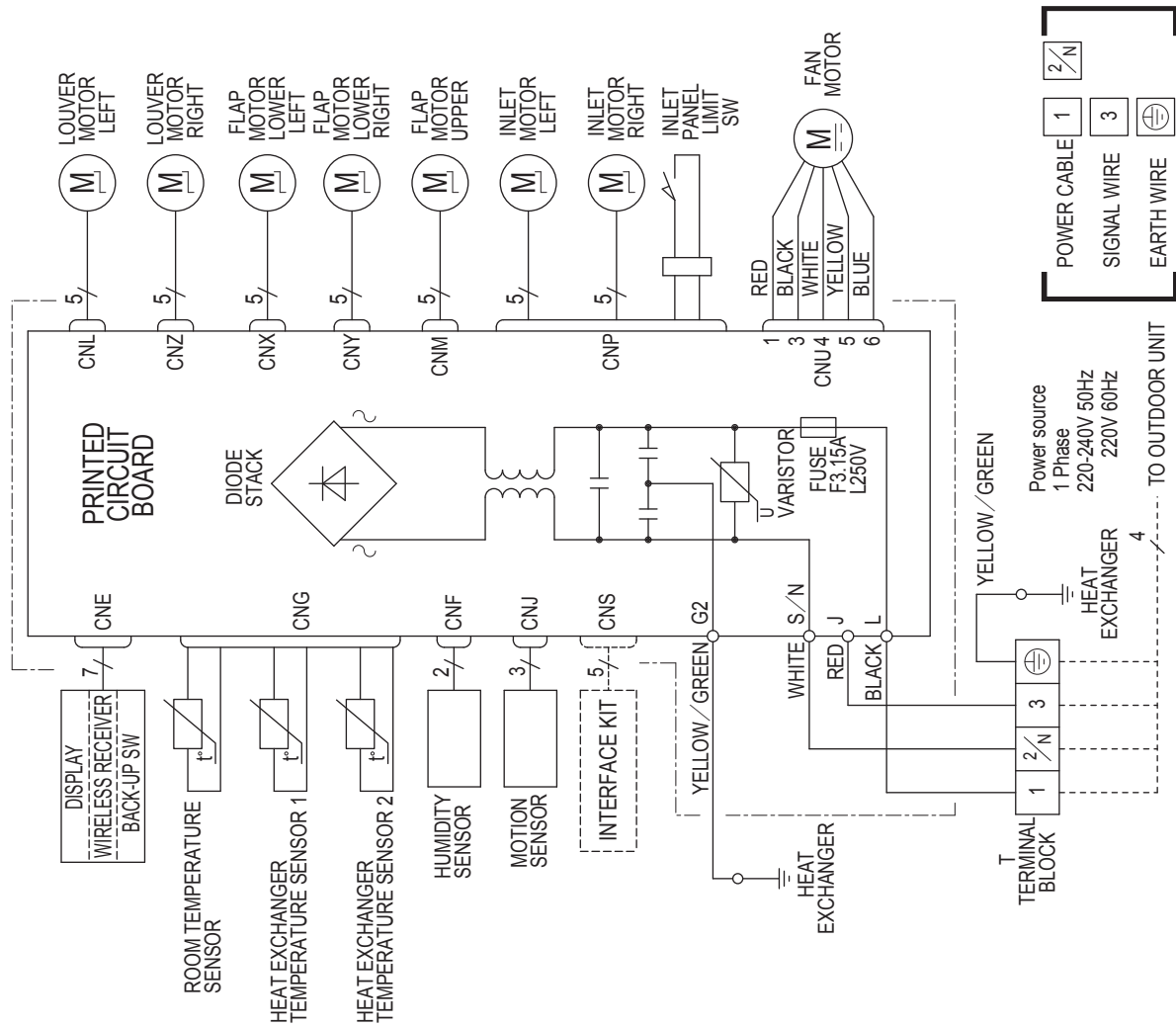

RWA000Z413

Model SRK100ZR-W

Item	Description
CNE	Connector
CNF	
CNG	
CNM	
CNS	
CNU	
CNX	
CNY	
FMi	Fan motor
SM ₁	Flap motor
LM _{1,2}	Louver motor
Th1	Room temperature sensor
Th2 _{1,2}	Heat exchanger temperature sensor
Th3	Humidity sensor
DS	Diode stack
F	Fuse
TB	Terminal block
Va	Varistor

Color Marks	Mark	Color
	BK	Black
	BL	Blue
	RD	Red
	WH	White
	Y	Yellow
	Y/G	Yellow / Green

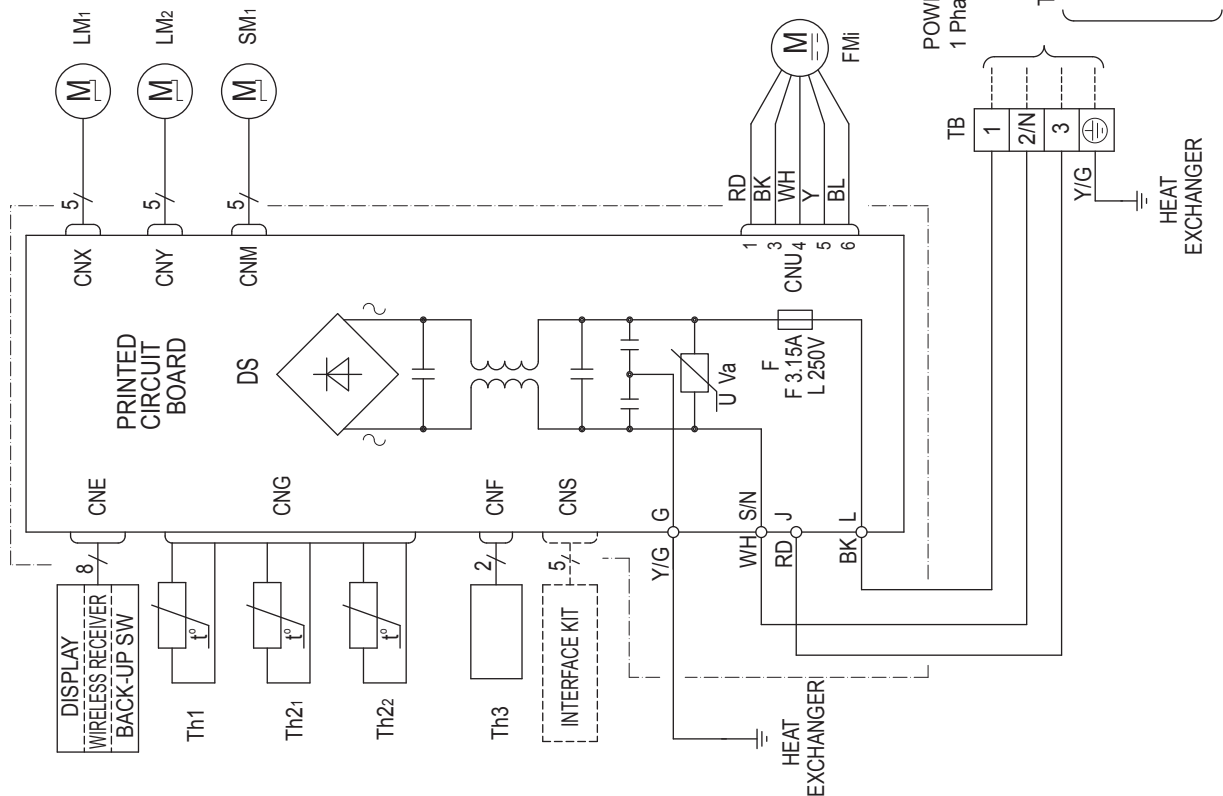

RWA000Z417

(2) Outdoor units
Models FDC100VNX-W, 125VNX-W, 140VNX-W

Item	Description
CH	Crankcase heater
CM	Compressor motor
CN	Connector
CT	Current sensor
DH	Drain pan heater
DM	Diode module
EEVC	Expansion valve for cooling
EEVH	Expansion valve for heating
F	Fuse
FM1,2	Fan motor
IPM	Intelligent power module
L	Reactor
LED1	Indication lamp (GREEN)
LED2	Indication lamp (RED)
PSL	Low pressure sensor
SW1	Pump down switch
SW3,4,5,7	Local setting switch
TB	Terminal block
THo-A	Temperature sensor (Outdoor air)
THo-D	Temperature sensor (Discharge pipe)
THo-R1,2	Temperature sensor (Heat exchanger pipe)
THo-S	Temperature sensor (Suction pipe)
THo-P	Temperature sensor (IPM)

Item	Description
20S	Solenoid valve for 4-way valve
52X1	Auxiliary relay (for CH)
52X2	Auxiliary relay (for DH)
52X3	Auxiliary relay (for 20S)
63H1	High pressure switch

Mark	Color
BK	Black
BL	Blue
BR	Brown
GN	Green
GR	Gray
P	Pink
OR	Orange
RD	Red
WH	White
Y	Yellow
Y/GN	Yellow/Green

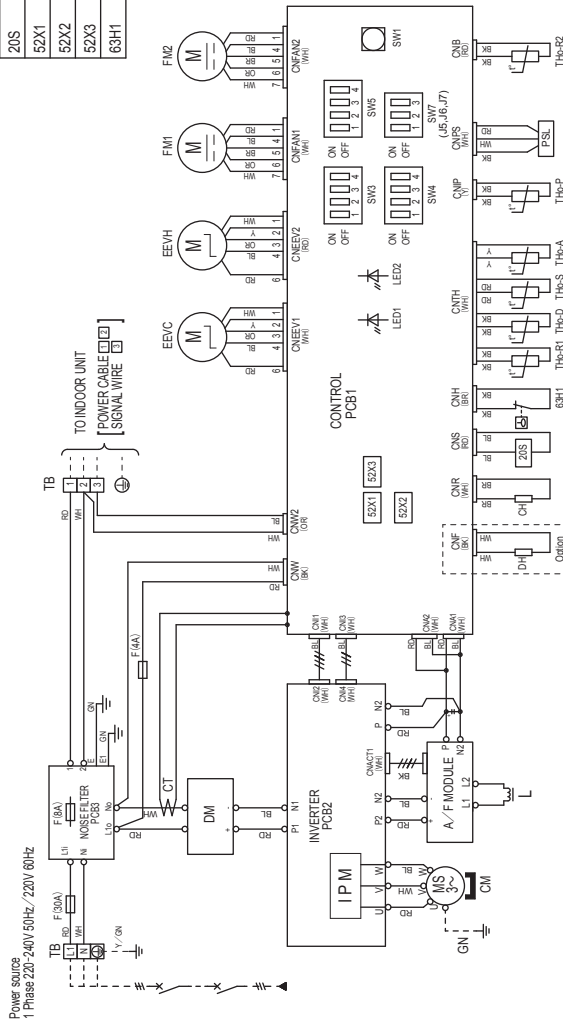

Local setting switch SW3,4,5 (Set up at shipment OFF)

Item	Description
SW3-1	Defrost control change
SW3-2	Snow guard fan control
SW3-3,4	Trial operation
SW4-1	Lower noise silent mode
SW5-2	High height difference operation control

Model	MAX over current (A)	Power cable size (mm ²)	Power cable length (m)	Indoor-outdoor wire size × number	Earth wire size (mm)
100	25	5.5	21	φ 1.6mm × 3	φ 1.6
125	27		20		
140					

Model	MAX over current (A)	Power cable size (mm ²)	Power cable length (m)	Indoor-outdoor wire size × number	Earth wire size (mm)
100	26	5.5	20	φ 1.6mm × 3	φ 1.6
125	28		28		
140	30	8	26		

※At the connection with the duct type indoor unit

- The specifications shown in the above table are for units without heaters. For units with heaters, refer to the installation instructions or the construction instructions of the indoor unit.
- Switchgear of circuit breaker capacity which is calculated from MAX. over current should be chosen along the regulations in each country.
- Power source cable: Use the cable which is conformed with 60245 IEC57.
- When selecting the power source cable length, make sure that voltage drop is less than 2%. If the wire length gets longer, increase the wire diameter.
- Indoor-outdoor connecting wires: Use the wires which is conformed with 60245 IEC57.

PCA001Z886

Models FDC100VSX-W, 125VSX-W, 140VSX-W

Item	Description
CH	Crankcase heater
CM	Compressor motor
CN	Connector
CT	Current sensor
DH	Drain pan heater
DM	Diode module
EEVC	Expansion valve for cooling
EEVH	Expansion valve for heating
F	Fuse
FM1 2	Fan motor
IPM	Intelligent power module
L	Reactor
LED1	Indication lamp (GREEN)
LED2	Indication lamp (RED)
PSL	Low pressure sensor
SW1	Pump down switch
SW3 4.5.7	Local setting switch
TB	Terminal block
THb-A	Temperature sensor (Outdoor air)
THb-D	Temperature sensor (Discharger pipe)
THb-R1.2	Temperature sensor (Heat exchanger pipe)
THb-S	Temperature sensor (Suction pipe)
THb-P	Temperature sensor (IPM)
20S	Solenoid valve for 4-way valve
52C	Relay

Item	Description
52X1	Auxiliary relay (for CH)
52X2	Auxiliary relay (for DH)
52X3	Auxiliary relay (for 20S)
52X6	Auxiliary relay (for 52C)
63H1	High pressure switch

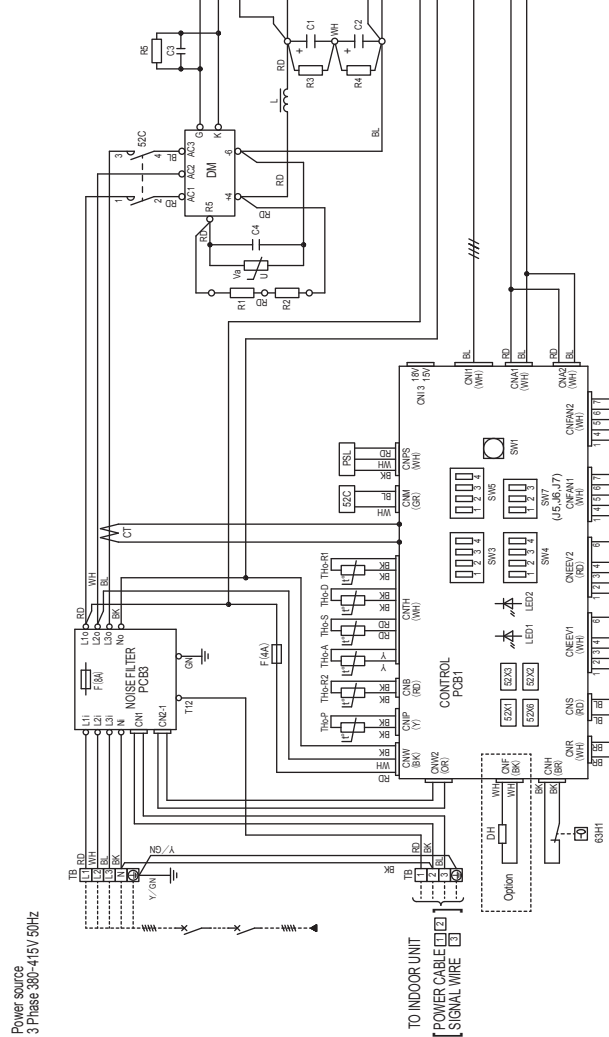

Local setting switch SW3.4.5 (Set up at shipment OFF)

Item	Description
SW3-1	Defrost control change
SW3-2	Snow guard fan control
SW3-3.4	Trial operation
SW4-1	Lower noise silent mode
SW5-2	High height difference operation control

Model	MAX over current (A)	Power cable size (mm ²)	Power cable length (m)	Indoor-outdoor wire size × number	Earth wire size (mm)
100	14	3.5	49	φ 1.6mm × 3	φ 1.6
125	15	3.5	46	φ 1.6mm × 3	φ 1.6
140	16		43		
	17		40		

※At the connection with the duct type indoor unit.

- The specifications shown in the above table are for units without heaters. For units with heaters, refer to the installation instructions or the construction instructions of the indoor unit.
- Switchgear of circuit breaker capacity which is calculated from MAX. over current should be chosen along the regulations in each country.
- Power source cable: Use the cable which is conformed with 60245 IEC57. If the wire length gets longer, make sure that voltage drop is less than 2%.
- Indoor-outdoor connecting wires: Use the wires which is conformed with 60245 IEC57.

Mark	Color
BK	Black
BL	Blue
BR	Brown
OR	Orange
RD	Red
WH	White
Y	Yellow
Y/GN	Yellow/Green
GR	Gray
P	Pink

Meaning of marks

Power source
3 Phase 380-415V 50Hz

1.5 PIPING SYSTEM

(1) Single type

Models 100, 125, 140

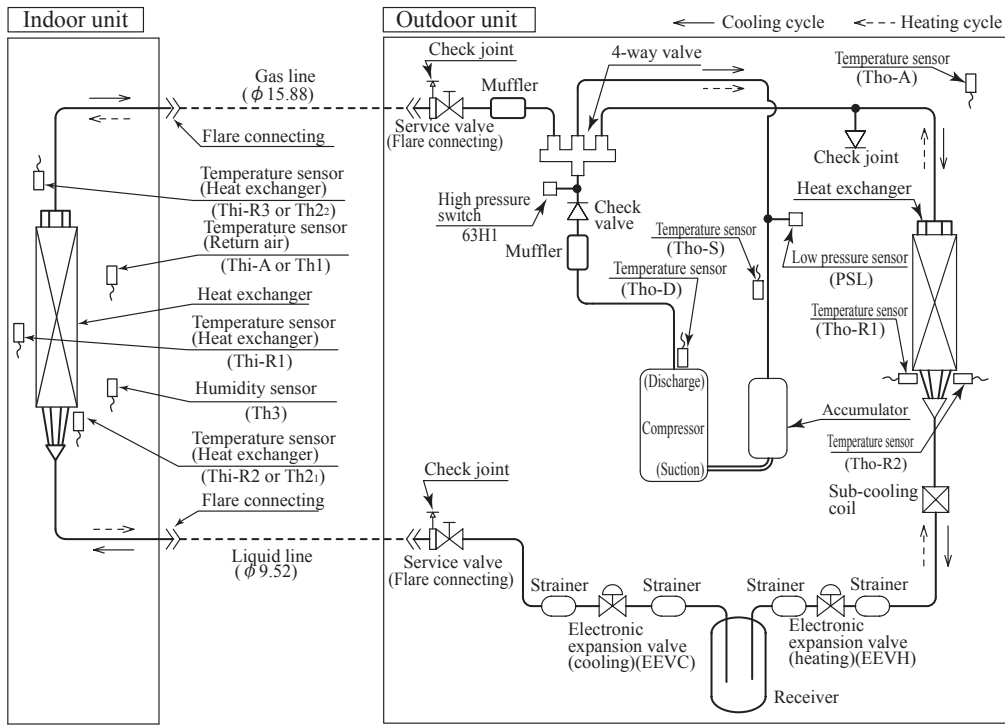

(2) Twin type

Models 100, 125, 140

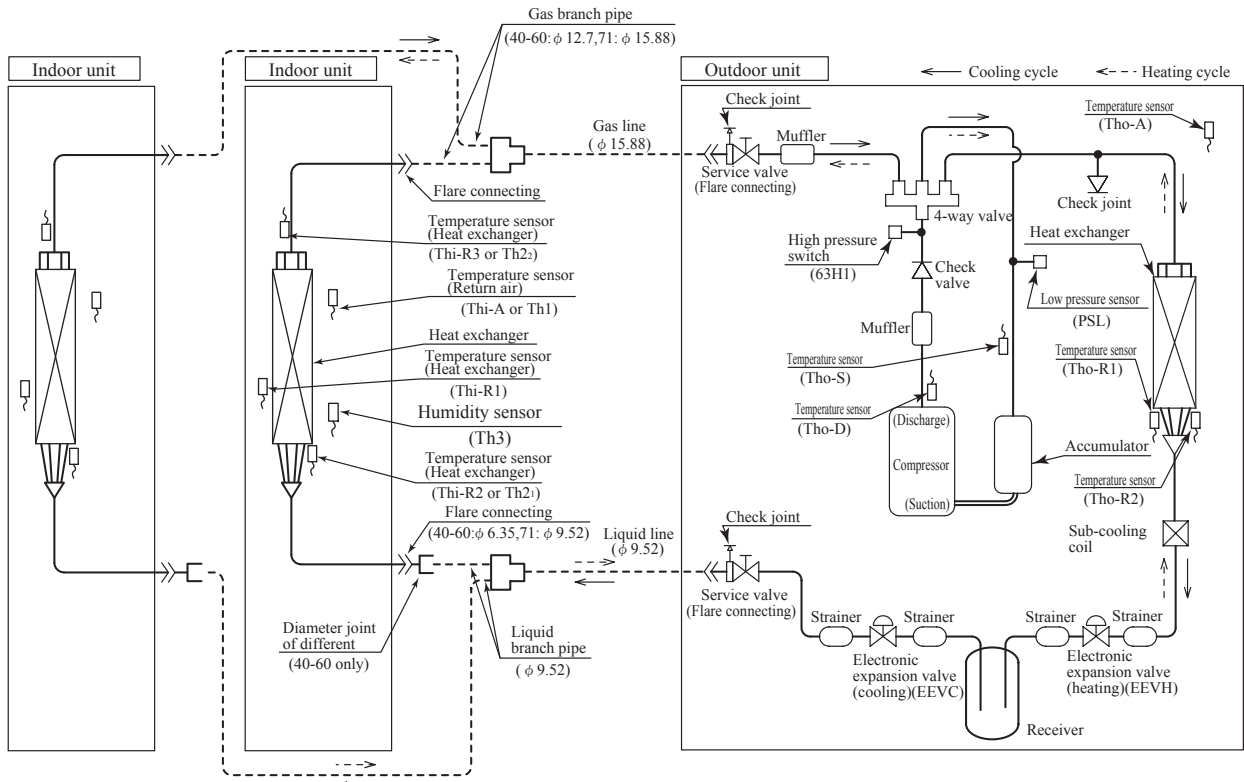

**(3) Triple type
Model 140**

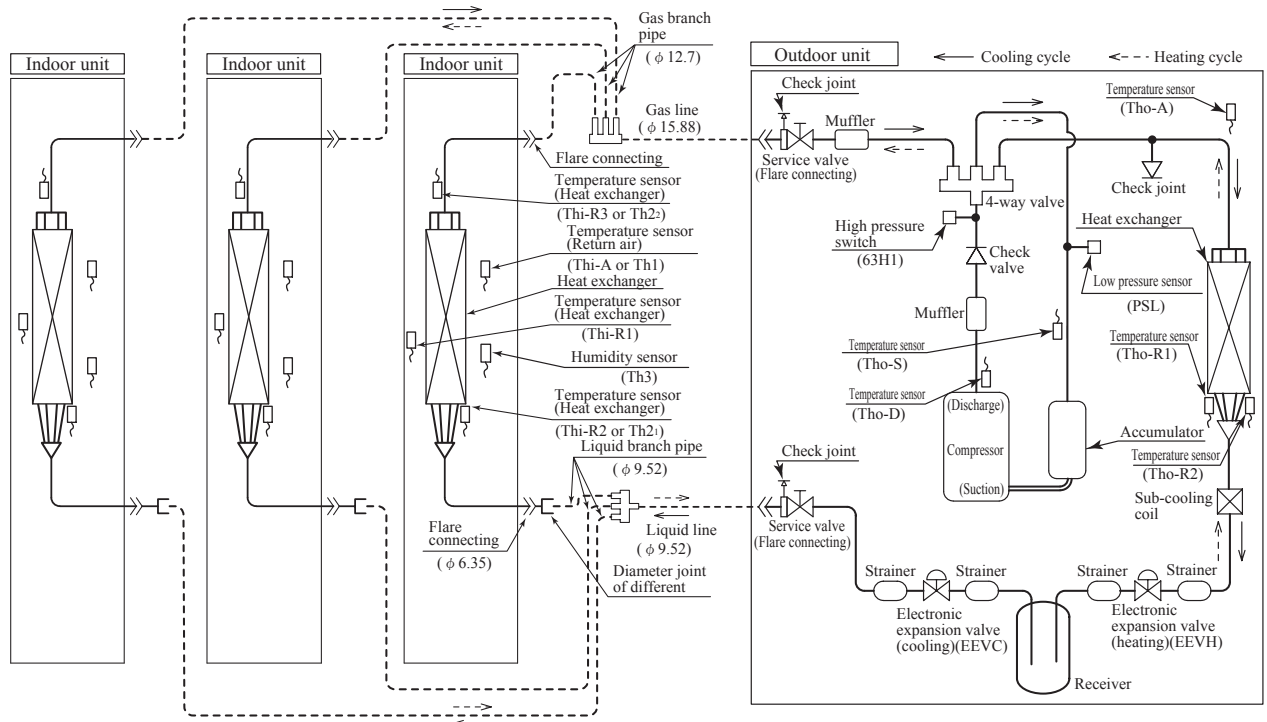

Preset point of the protective devices

Parts name	Mark	Equipped unit	Protective control activation 100, 125, 140 model
Temperature sensor (for protection overloading in heating)	Thi-R (Tho-A)	Indoor unit (Outdoor unit)	Active 63°C (Active 17°C) Inactive 56°C (Inactive 16°C)
Temperature sensor (for frost prevention)	Thi-R (Th2)	Indoor unit	Active 1.0°C (Active 2.5°C) Inactive 10°C (Inactive 8°C)
Temperature sensor (for protection high pressure in cooling.)	Tho-R	Outdoor unit	Active 63°C Inactive 51°C
Temperature sensor (for detecting discharge pipe temp.)	Tho-D	Outdoor unit	Active 115°C Inactive 85°C
High pressure switch (for protection)	63H1	Outdoor unit	Active 4.15MPa Inactive 3.15MPa
Low pressure sensor (for protection)	PSL	Outdoor unit	Active 0.079MPa Inactive 0.227MPa

Note (1) Values in () are for the SRK models.

2. V MULTI SYSTEM

CONTENTS

2.1 OUTLINE OF OPERATION CONTROL BY MICROCOMPUTER	200
2.2 MAINTENANCE DATA	200
2.3 DISASSEMBLY PROCEDURE	200
2.4 ELECTRICAL WIRING	200
2.5 PIPING SYSTEM	200

2.1 OUTLINE OF OPERATION CONTROL BY MICROCOMPUTER See page 5
2.2 MAINTENANCE DATA See page 51
2.3 DISASSEMBLY PROCEDURE See page 172
2.4 ELECTRICAL WIRING See page 186
2.5 PIPING SYSTEM See page 197

HYPER INVERTER PACKAGED AIR-CONDITIONERS



MITSUBISHI HEAVY INDUSTRIES THERMAL SYSTEMS, LTD.

2-3, Marunouchi 3-chome, Chiyoda-ku, Tokyo, 100-8332, Japan
<http://www.mhi-mth.co.jp/en/>

Because of our policy of continuous improvement, we reserve the right to make changes in all specifications without notice.

© Copyright MITSUBISHI HEAVY INDUSTRIES THERMAL SYSTEMS, LTD.