



SERVICE MANUAL

INVERTER WALL MOUNTED TYPE RESIDENTIAL AIR-CONDITIONERS (Split system, air to air heat pump type)

SRK25ZSP-S

SRK35ZSP-S

SRK45ZSP-S

CONTENTS

1. OUTLINE OF OPERATION CONTROL BY MICROCOMPUTER	2
(1) Operation control function by wireless remote control	2
(2) Unit ON/OFF button	3
(3) Auto restart function	3
(4) Installing two air-conditioners in the same room	3
(5) High power operation	4
(6) Economy operation	4
(7) Air flow direction adjustment	4
(8) Timer operation	5
(9) Outline of heating operation	5
(10) Outline of cooling operation	7
(11) Outline of automatic operation	7
(12) Protection control function	8
2. MAINTENANCE DATA	16
(1) Cautions	16
(2) Items to check before troubleshooting	16
(3) Troubleshooting procedure (If the air-conditioner does not run at all)	16
(4) Troubleshooting procedure (If the air-conditioner runs)	17
(5) Self-diagnosis table	18
(6) Service mode (Trouble mode access function)	19
(7) Inspection procedures corresponding to detail of trouble	27
(8) Phenomenon observed after short-circuit, wire breakage on sensor	31
(9) Checking the indoor electrical equipment	32
(10) How to make sure of wireless remote control	33
(11) Outdoor unit inspection points	34

1. OUTLINE OF OPERATION CONTROL BY MICROCOMPUTER

(1) Operation control function by wireless remote control

Remote control

◆ Operation section

FAN SPEED button

Each time the button is pressed, the fan speed changes.

HI POWER/ECONO button

This button changes the HIGH POWER/ECONOMY mode.

ON TIMER button

This button selects ON TIMER operation.

SLEEP button

This button selects SLEEP operation.

CLEAN switch

This switch selects the SELF CLEAN mode.

CANCEL button

This button cancels the ON timer, OFF timer, and SLEEP operation.

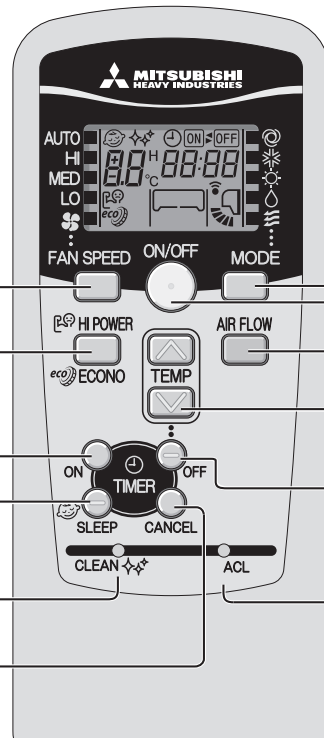

OPERATION MODE select button

Each time the button is pressed, the mode changes.

ON/OFF (luminous) button

Press to start operation, press again to stop.

AIR FLOW (UP/DOWN) button

This button changes the air flow (up/down) direction.

TEMPERATURE button

These buttons set the room temperature. (These buttons are used for setting the current time and timer function as well.)

OFF TIMER button

This button selects OFF TIMER operation.

ACL switch

This switch resets the program to default state.

- The above illustration shows all controls, but in practice only the relevant parts are shown.

Unit display section

Unit ON/OFF button

This button can be used for turning on/off the unit when a remote control is not available.

Wireless remote control signal receiver

ON/OFF

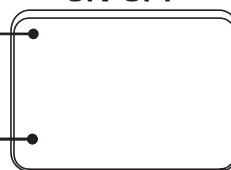

RUN light (green)

- Illuminates during operation.
- Blinks slowly when SELF CLEAN operation (3 seconds ON, 1 second OFF).
- Blinks when air flow is stopped to prevent blowing out of cold air in heating operation. (1.5 seconds ON, 0.5 seconds OFF)

RUN



TIMER

TIMER light (yellow)

Illuminates during TIMER operation.

(2) Unit ON/OFF button

When the wireless remote control batteries become weak, or if the wireless remote control is lost or malfunctioning, this button may be used to turn the unit on and off.

(a) Operation

Push the button once to place the unit in the automatic mode. Push it once more to turn the unit off.

(b) Details of operation

The unit will go into the automatic mode in which it automatically determines, from room temperature (as detected by sensor), whether to go into the COOL, DRY or Heat modes.

Function	Room temperature setting	Fan speed	Flap	Timer switch
COOL	About 24°C	Auto	Auto	Continuous
DRY	About 24°C			
HEAT	About 26°C			

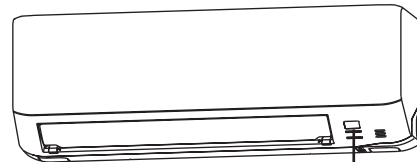

Unit ON/OFF button

(3) Auto restart function

(a) Auto restart function records the operational status of the air-conditioner immediately prior to be switched off by a power cut, and then automatically resumes operations after the power has been restored.

(b) The following settings will be cancelled:

- (i) Timer settings
- (ii) HIGH POWER operation

- Notes
- (1) Auto restart function is set at on when the air-conditioner is shipped from the factory. Consult with your dealer if this function needs to be switched off.
 - (2) When power failure occurs, the timer setting is cancelled. Once power is resumed, reset the timer.
 - (3) If the jumper wire (J1) "AUTO RESTART" is cut, auto restart is disabled. (See the diagram at right.)

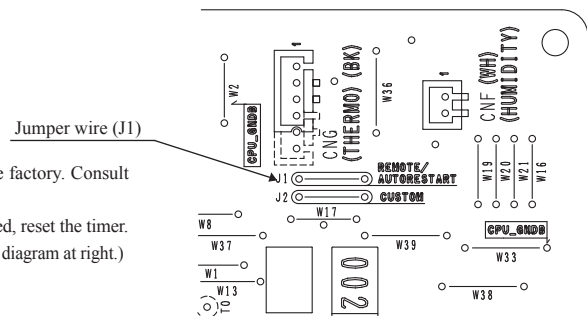

(4) Installing two air-conditioners in the same room

When two air-conditioners are installed in the room, set the wireless remote control and indoor unit as follows to prevent operating air-conditioners with one wireless remote control.

(a) Setting an indoor unit's printed circuit board

- (i) Take out the printed circuit board from the control box.
- (ii) Disconnect jumper wire (J2) with wire cutters.
- (iii) Install a printed circuit board.

(b) Setting a wireless remote control

- (i) Pull out the cover and take out batteries.
- (ii) Disconnect the switching line next to the battery with wire cutters.
- (iii) Insert batteries. Close the cover.

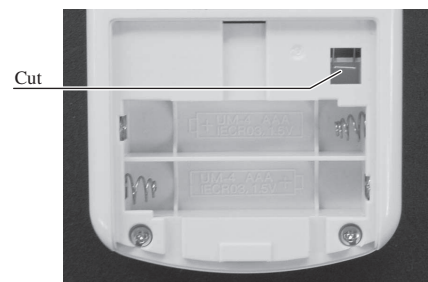
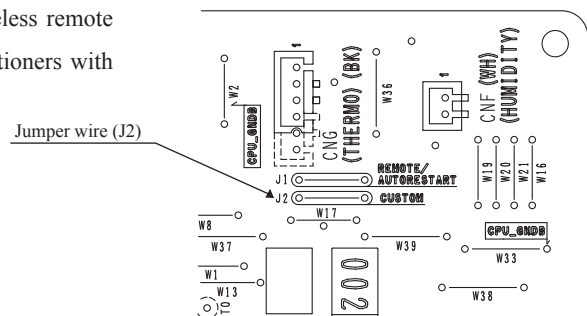

(5) High power operation

Pressing the HI POWER/ECONO button intensifies the operating power and initiates powerful cooling and heating operation for 15 minutes continuously. The wireless remote control displays HIGH POWER mark and the FAN SPEED display disappears.

- (a) During the HIGH POWER operation, the room temperature is not controlled. When it causes an excessive cooling and heating, press the HI POWER/ECONO button again to cancel the HIGH POWER operation.
- (b) HIGH POWER operation is not available during the DRY and the ON timer to OFF timer operations.
- (c) When HIGH POWER operation is set after ON TIMER operation, HIGH POWER operation will start from the set time.
- (d) When the following operation are set, HIGH POWER operation will be canceled.
 - ① When the HI POWER/ECONO button is pressed again.
 - ② When the operation mode is changed.
 - ③ When it has been 15 minutes since HIGH POWER operation has started.
- (e) Not operable while the air-conditioner is OFF.

(6) Economy operation

Pressing the HI POWER/ECONO button initiates a soft operation with the power suppressed in order to avoid an excessive cooling or heating. The unit operates 1.5°C higher than the setting temperature during cooling or 2.5°C lower than that during heating. The wireless remote control displays ECONO mark and the FAN SPEED display disappears.

- (a) It will go into ECONOMY operation at the next time the air-conditioner runs in the following cases.
 - ① When the air-conditioner is stopped by ON/OFF button during ECONOMY operation.
 - ② When the air-conditioner is stopped in SLEEP or OFF TIMER operation during ECONOMY operation.
 - ③ When the operation is retrieved from CLEAN operation.
- (b) When the following operation are set, ECONOMY operation will be canceled.
 - ① When the HI POWER/ECONO button is pressed again.
 - ② When the operation mode is changed DRY to FAN.
- (c) Not operable while the air-conditioner is OFF.
- (d) The setting temperature is adjusted according to the following table.

Item \ Mode	Cooling	Heating
Temperature adjustment	① +0.5	① -1.0
	② +1.0	② -2.0
	③ +1.5	③ -2.5

- ① at the start of operation.
- ② one hour after the start of operation.
- ③ two hours after the start of operation.

(7) Air flow direction adjustment



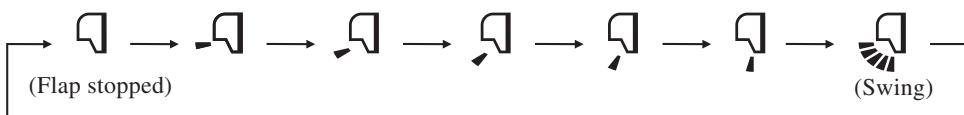

Air flow direction can be adjusted with by AIR FLOW  (UP/DOWN) button on the wireless remote control.

(a) Flap

Each time when you press the AIR FLOW  (UP/DOWN) button the mode changes as follows.



• Angle of flap from horizontal

Remote control display					
COOL, DRY, FAN	Approx. 15°	Approx. 25°	Approx. 35°	Approx. 45°	Approx. 59°
HEAT	Approx. 25°	Approx. 35°	Approx. 50°	Approx. 59°	Approx. 65°

(b) Swing

Flap moves in upward and downward directions continuously.

- ◆ In HEAT operation
- ◆ In COOL, DRY, FAN operation

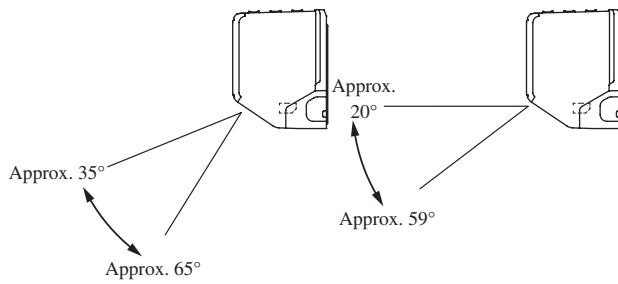

(c) Memory flap

When you press the AIR FLOW (UP/DOWN) button once while the flap is operating, it stops swinging at the position. Since this angle is memorized in the microcomputer, the flap will automatically be set at this angle when the next operation is started.

(d) When not operating

The flap returns to the position of air flow directly below, when operation has stopped.

(8) Timer operation

(a) Comfortable timer setting (ON timer)

If the timer is set at ON when the operation select switch is set at the cooling or heating, or the cooling or heating in auto mode operation is selected, the comfortable timer starts and determines the starting time of next operation based on the initial value of 15 minutes and the relationship between the room temperature at the setting time (temperature of room temperature sensor) and the setting temperature.

(b) Sleep timer operation

Pressing the SLEEP button causes the temperature to be controlled with respect to the set temperature.

(c) OFF timer operation

The Off timer can be set at a specific time (in 10-minute units) within a 24-hour period.

(9) Outline of heating operation

(a) Operation of major functional components in heating mode

	Heating			
	Thermostat ON	Thermostat OFF	Defrost	Failure
Compressor	ON	OFF	OFF	OFF
Indoor fan motor	ON	ON(HOT KEEP)	OFF	OFF
Outdoor fan motor	ON	OFF (few minutes ON)	OFF	OFF
4-way valve	ON	ON	OFF	OFF (3 minutes ON)

(b) Details of control at each operation mode (pattern)

(i) Fuzzy operation

Deviation between the room temperature setting correction temperature and the suction air temperature is calculated in accordance with the fuzzy rule, and used for control of the air capacity and the compressor speed.

Model	SRK25ZSP-S	SRK35ZSP-S	SRK45ZSP-S
Fan speed			
AUTO	20-115rps		12-110rps
HI	20-115rps		12-110rps
MED	20-72rps	20-84rps	12-78rps
LO	20-54rps	20-62rps	12-50rps

When the defrost operation, protection device, etc. is actuated, operation is performed in the corresponding mode.

(ii) Hot keep operation

During the heating operation, the indoor fan speed can be controlled based on the temperature of the indoor heat exchanger (Th2) to prevent blowing of cold air.

(c) Defrost operation

(i) Starting conditions (Defrost operation can be started only when all of the following conditions are satisfied.)

- 1) After start of heating operation
When it elapsed 35 (model SRK35 : 45) minutes. (Total compressor operation time)
- 2) After end of defrost operation
When it elapsed 35 (model SRK35 : 45) minutes. (Total compressor operation time)
- 3) Outdoor heat exchanger sensor (TH1) temperature
When the temperature has been -5°C or less for 3 minutes continuously.
- 4) The difference between the outdoor air sensor temperature and the outdoor heat exchanger sensor temperature is as follows.
 - $0^{\circ}\text{C} \leq \text{TH2}$: $\text{TH2} - \text{TH1} \geq 7^{\circ}\text{C}$, $\text{TH1} \leq \text{TH2} - 7^{\circ}\text{C}$ (model SRK45:-10 $^{\circ}\text{C}$)
 - $-15^{\circ}\text{C} \leq \text{TH2} < 0^{\circ}\text{C}$: $\text{TH2} - \text{TH1} \geq 2/15 \times \text{TH2} + 7^{\circ}\text{C}$, $\text{TH1} \leq 13/15 \times \text{TH2} - 7^{\circ}\text{C}$ (model SRK45:-10 $^{\circ}\text{C}$)
 - $\text{TH2} < -15^{\circ}\text{C}$: $\text{TH2} - \text{TH1} \geq -5^{\circ}\text{C}$, $\text{TH1} \leq \text{TH2} + 5^{\circ}\text{C}$

Models SRK25, 35ZSP-S

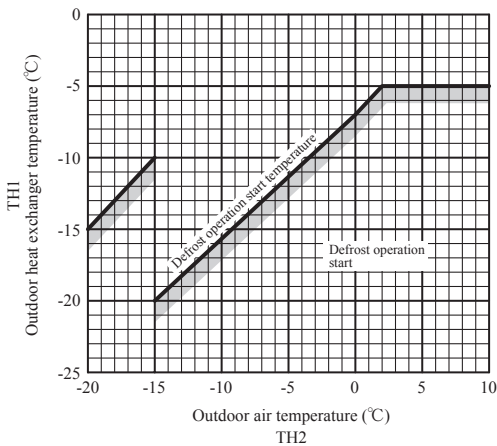

Model SRK45ZSP-S

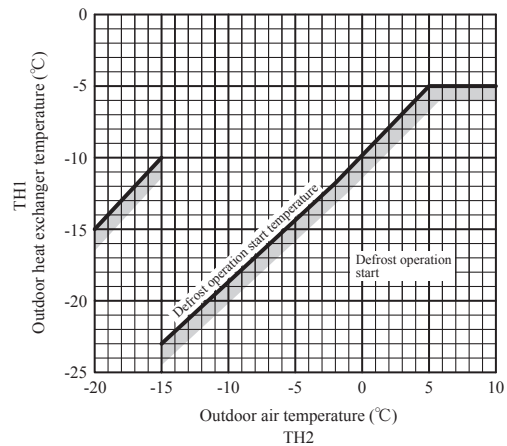

- 5) During continuous compressor operation
In case satisfied all of following conditions.
 - Connect compressor speed 0 rps 10 times or more.
 - Satisfy 1), 2) and 3) conditions above.
 - Outdoor air temperature is 3°C or less.

(ii) Ending conditions (Operation returns to the heating cycle when either one of the following is satisfied.)

- 1) Outdoor heat exchanger sensor (TH1) temperature: 13°C or higher
- 2) Continued operation time of defrost operation → For more than 16 minutes and 50 seconds (model SRK45 : 17 minutes).

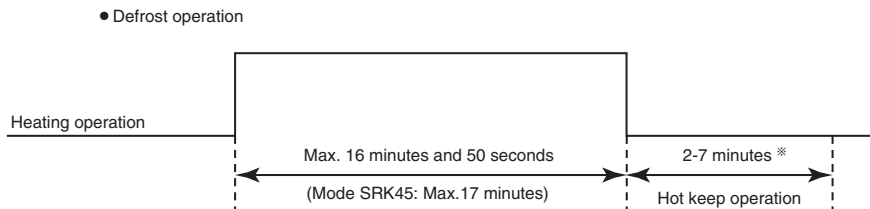

※Depends on an operation condition, the time can be longer than 7 minutes.

(10) Outline of cooling operation

(a) Operation of major functional components in cooling mode

	Cooling		
	Thermostat ON	Thermostat OFF	Failure
Compressor	ON	OFF	OFF
Indoor fan motor	ON	ON	ON
Outdoor fan motor	ON	OFF (few minutes ON)	OFF (few minutes ON)
4-way valve	OFF	OFF	OFF

(b) Detail of control in each mode (Pattern)

(i) Fuzzy operation

During the fuzzy operation, the air flow and the compressor speed are controlled by calculating the difference between the room temperature setting correction temperature and the suction air temperature.

Fan speed	Model	SRK25ZSP-S	SRK35ZSP-S	SRK45ZSP-S
AUTO		20-74rps	20-98rps	12-96rps
HI		20-74rps	20-98rps	12-96rps
MED		20-52rps	20-74rps	12-62rps
LO		20-38rps	20-46rps	12-38rps

(11) Outline of automatic operation

(a) Determination of operation mode

The unit checks the indoor air temperature and the outdoor air temperature, determines the operation mode, and then begins in the automatic operation.

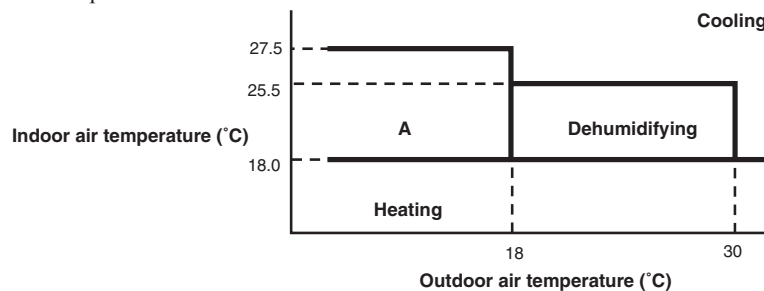

(b) The unit checks the temperature every hour after the start of operation and, if the result of check is not same as the previous operation mode, changes the operation mode.

- (i) If the setting temperature is changed with the remote control, the operation mode is judged immediately.
- (ii) When both the indoor and the outdoor air temperatures are in the range “A”, cooling or heating is switched depending on the difference between the setting temperature and the indoor air temperature.
- (iii) When the operation mode has been judged following the change of setting temperature with the remote control, the hourly judgment of operation mode is cancelled.

(c) When the unit is started again within one hour after the stop of automatic operation or when the automatic operation is selected during heating, cooling or dehumidifying operation, the unit is operated in the previous operation mode.

(d) Setting temperature can be adjusted within the following range. There is the relationship as shown below between the signals of the wireless remote control and the setting temperature.

		Signals of wireless remote control (Display)												
		-6	-5	-4	-3	-2	-1	±0	+1	+2	+3	+4	+5	+6
Setting temperature	Cooling	18	19	20	21	22	23	24	25	26	27	28	29	30
	Dehumidifying	19	20	21	22	23	24	25	26	27	28	29	30	31
	Heating	20	21	22	23	24	25	26	27	28	29	30	31	32

(e) When the unit is operated automatically with the wired remote control connected, the cooling operation is controlled according to the display temperatures while the setting temperature is compensated by +1°C during dehumidifying or by +2°C during heating.

(12) Protection control function

(a) Dew prevention control I [Cooling]

Prevents dewing on the indoor unit.

(i) Operating conditions

When the following conditions have been satisfied.

- 1) Humidity is 78% or higher.

(ii) Contents of operation

	Maximum compressor speed
SRK25ZSP-S	74 rps
SRK35ZSP-S	79 rps
SRK45ZSP-S	76 rps

(iii) Reset condition

When either of the following condition is satisfied.

- 1) Humidity is 73% or less.
- 2) Dew prevention control II has been satisfied.

(b) Dew prevention control II [Cooling]

Prevents dewing on the indoor unit.

(i) Operating conditions

When the following conditions have been satisfied for more than 30 minutes after starting operation

- 1) Compressor speed is 32 rps or higher. (SRK25, 35 only)
- 2) Humidity is 68% or higher.

(ii) Contents of operation

- 1) Air capacity control

		Model	SRK25, 35ZSP-S	SRK45ZSP-S
LO	Upper limit of compressor speed		RangeA: 45rps, RangeB: 45rps	RangeA: 50rps, RangeB: 34rps
	Indoor fan		4th speed	
AUTO,HI,MED	Upper limit of compressor speed		RangeA: 45rps, RangeB: 45rps	RangeA: 50rps, RangeB: 34rps
	Indoor fan		Adaptable to compressor speed (Lower limit 4th speed)	

Note (1) Ranges A and B are as shown below.

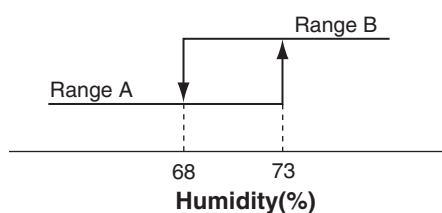

- 2) When this control has continued for more than 30 minutes continuously, the following wind direction control is performed.

- a) When the vertical wind direction is set at other than the vertical swing, the flaps change to the horizontal position.
- b) When the horizontal wind direction is set at other than the horizontal swing, the louver changes to the vertical position.

(iii) Reset condition

When any of followings is satisfied.

- 1) Compressor speed is less than 32 rps. (SRK25, 35 only)
- 2) Humidity is less than 63%.

(c) Frost prevention control (During cooling or dehumidifying)

(i) Operating conditions

- 1) Indoor heat exchanger temperature (Th2) is lower than 5°C.
- 2) 5 minutes after reaching the compressor speed except 0 rps.

(ii) Detail of anti-frost operation

Item	Indoor heat exchanger temperature	
	5°C or lower	2.5°C or lower
Lower limit of compressor speed	22 rps	0 rps
Indoor fan	Depends on operation mode	Protects the fan tap just before frost prevention control
Outdoor fan	Depends on compressor speed	Depends on stop mode
4-way valve	OFF	

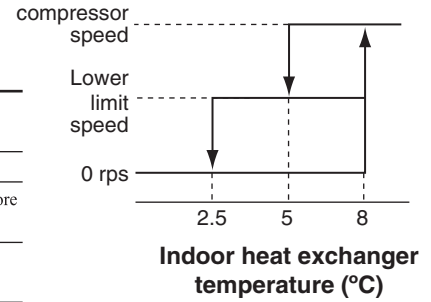

- Notes
- (1) When the indoor heat exchanger temperature is in the range of 2.5-5°C, the speed is reduced by 4 rps at each 20 seconds.
 - (2) When the temperature is lower than 2.5°C, the compressor is stopped.
 - (3) When the indoor heat exchanger temperature is in the range of 5-8°C, the compressor speed is been maintained.

(iii) Reset conditions

When either of the following condition is satisfied.

- 1) The indoor heat exchanger temperature (Th2) is 8°C or higher.
- 2) The compressor speed is 0 rps.

(d) Cooling overload protective control

(i) Operating conditions

When the outdoor air temperature (TH2) has become continuously for 30 seconds at 41°C or more, or 47°C or more (Model SRK45: 41°C or more) with the compressor running, the lower limit speed of compressor is brought up.

Item	Model	SRK25, 35ZSP-S		SRK45ZSP-S
Outdoor air temperature		41°C or more	47°C or more	41°C or more
Lower limit speed		30 rps	40 rps	30 rps

(ii) Detail of operation

- 1) The outdoor fan is stepped up by 3 speed step. (Upper limit; models SRK25, 45 : 8th speed, model SRK35 : 9th speed.)
- 2) The lower limit of compressor speed is set to 30 or 40 (model SRK45 : 30) rps. However, when the thermo OFF, the speed is reduced to 0 rps.

(iii) Reset conditions

When either of the following condition is satisfied.

- 1) The outdoor air temperature is lower than 40°C.
- 2) The compressor speed is 0 rps.

(e) Cooling high pressure control

(i) Purpose

Prevents anomalous high pressure operation during cooling.

(ii) Detector

Outdoor heat exchanger sensor (TH1)

(iii) Detail of operation

(Example) Fuzzy

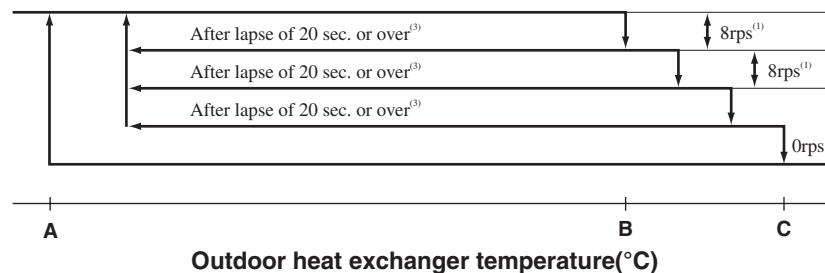

- Notes (1) When the outdoor heat exchanger temperature is in the range of B-C °C, the speed is reduced by 8 rps at each 20 seconds.
 (2) When the temperature is C °C or higher, the compressor is stopped.
 (3) When the outdoor heat exchanger temperature is in the range of A-B °C, if the compressor speed is been maintained and the operation has continued for more than 20 seconds at the same speed, it returns to the normal cooling operation.

● **Temperature list**

	A	B	C
Outdoor air temperature ≥ 32 °C	50	52	56
Outdoor air temperature < 32 °C	42	44	50

(f) **Cooling low outdoor air temperature protective control**

(i) **Operating conditions**

When the outdoor air temperature (TH2) is 22°C or lower continues for 20 seconds while the compressor speed is other than 0 rps.

(ii) **Detail of operation**

- It controls the upper and lower limit values for the compressor speed according to the following table.
- It checks the outdoor temperature (TH2) once every hour to judge the operation range.

	Compressor speed: Upper/lower limit (rps)					
	Lower 1	Upper 1	Lower 2	Upper 2	Lower 3	Upper 3
SRK25, 35	30	60	44	50	50	50
SRK45	30	60	44	50	44	50

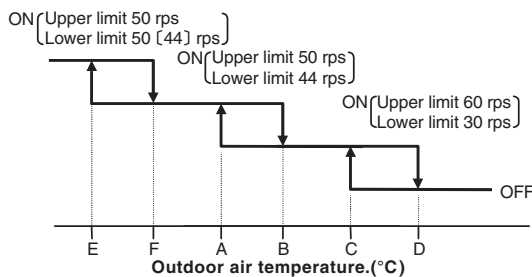

● **Values of A, B, C, D, E, F (Models SRK25, 35)**

	Outdoor air temperature (°C)					
	E	F	A	B	C	D
First time	-8	-5	0	3	22	25
After the second times	-2	1	5	8	25	28

● **Values of A, B, C, D, E, F (Model SRK45)**

	Outdoor air temperature (°C)					
	E	F	A	B	C	D
First time	0	2	9	11	22	25
After the second times	5	7	16	19	25	28

(iii) **Reset conditions**

When either of the following condition is satisfied.

- The outdoor air temperature (TH2) is D °C or higher.
- The compressor speed is 0 rps.

(g) **Heating high pressure control**

(i) **Purpose**

Prevents anomalous high pressure operation during heating.

(ii) **Detector**

Indoor heat exchanger sensor (Th2)

(iii) **Detail of operation**

(Example) **Fuzzy**

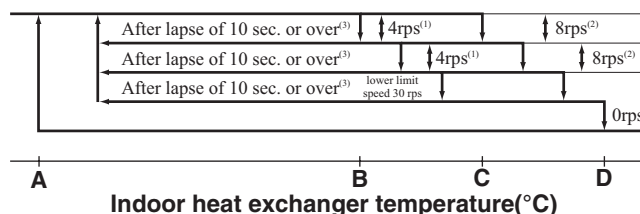

- Notes (1) When the indoor heat exchanger temperature is in the range of B-C °C, the speed is reduced by 4 rps at each 10 seconds.
 (2) When the indoor heat exchanger temperature is in the range of C-D °C, the speed is reduced by 8 rps at each 10 seconds. When the temperature is D °C or higher continues for 1 minute, the compressor is stopped.
 (3) When the indoor heat exchanger temperature is in the range of A-B °C, if the compressor speed is been maintained and the operation has continued for more than 10 seconds at the same speed, it returns to the normal heating operation.
 (4) Indoor fan retains the fan speed when it enters in the high pressure control. Outdoor fan is operated in accordance with the speed.

● **Temperature list**

Models SRK25, 35 Unit : °C

	A	B	C	D
RPSmin < 50	48	52	54	55
50 ≤ RPSmin < 91	48.5	54.5	58	61
91 ≤ RPSmin < 97	48.5	54.5-51.5	58	61
97 ≤ RPSmin < 100	48.5	51.5-50	58-56	61
100 ≤ RPSmin < 115	48.5-40.1	50-42	56-47.3	61
115 ≤ RPSmin	40.1	42	47.3	61

Model SRK45 Unit : °C

	A	B	C	D
RPSmin < 80	46	54	56	58-62
80 ≤ RPSmin < 102	46-33.5	54-38.5	56-39.5	58-51
102 ≤ RPSmin < 120	33.5	38.5	39.5	51
120 ≤ RPSmin	33.5	38.5	39.5	51

Note (1) RPSmin: The lower one between the compressor speed

(h) Heating overload protective control

(i) Indoor unit side

1) Operating conditions

When the outdoor air temperature (TH2) is 17°C or higher continues for 30 seconds while the compressor speed other than 0 rps.

2) Detail of operation

The indoor fan speed is stepped up by 1 speed step. (Upper limit 8th speed)

3) Reset conditions

The outdoor air temperature (TH2) is lower than 16°C.

(ii) Outdoor unit side

1) Operating conditions

When the outdoor air temperature (TH2) is 17 or 22 (14 or 20)°C or higher continues for 30 seconds while the compressor speed other than 0 rps.

2) Detail of operation

Upper and lower limits of compressor speed and the outdoor unit fan speed are restricted.

Models SRK25, 35

	Compressor command speed (rps)		Outdoor fan speed
	Lower limit	Upper limit	
ON1	–	–	2nd speed
ON2	40	60	1st speed

Model SRK45

	Compressor command speed (rps)		Outdoor fan speed
	Lower limit	Upper limit	
ON1	30	78	(1)
ON2	30	51	2nd speed

Note (1) Outdoor fan speed
 Lower limit : 4th speed
 Upper limit : 7th speed

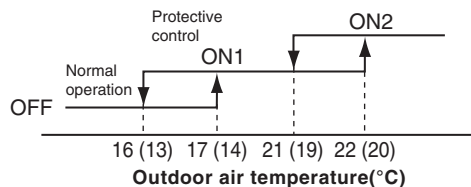

3) Reset conditions

When the outdoor air temperature drops below 16 (13)°C.

Note (1) Values in () are for the model SRK45.

(i) Heating low outdoor temperature protective control

(i) Protective control I

1) Operating conditions

When the outdoor air temperature (TH2) is 2 (4)°C or lower continues for 30 seconds while the compressor speed is other than 0 rps.

2) Detail of operation

The lower limit compressor speed is changed as shown in the figure below.

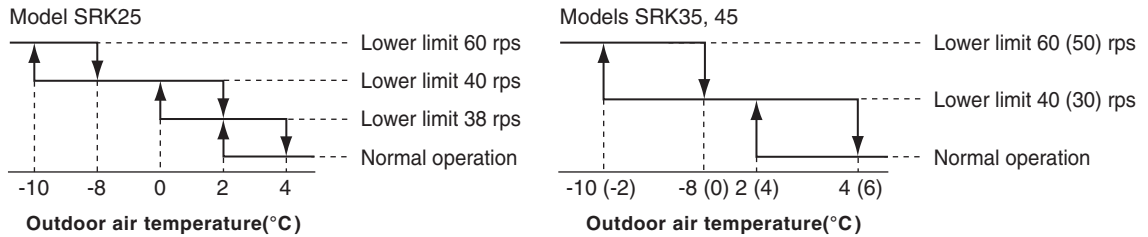

3) Reset conditions

When either of the following condition is satisfied.

- a) The outdoor air temperature (TH2) becomes 4 (6)°C.
- b) The compressor speed is 0 rps.

Note (1) Values in () are for the model SRK45.

(ii) Protective control II (Models SRK25, 35 only)

1) Operating conditions

When the outdoor heat exchanger sensor (TH1) is -10°C or lower continuously for 10 minutes while the compressor speed is other than 0 rps.

2) Detail of operation

Upper limit of compressor speed is 115rps.

3) Reset conditions

When the either of the following condition is satisfied.

- a) When the outdoor heat exchanger sensor (TH1) becomes -8°C or higher.
- b) When the compressor speed is 0 rps.

(j) Compressor overheat protection

(i) Purpose

It is designed to prevent deterioration of oil, burnout of motor coil and other trouble resulting from the compressor overheat.

(ii) Detail of operation

- 1) Speeds are controlled with temperature detected by the sensor mounted on the discharge pipe.

(Example) Fuzzy

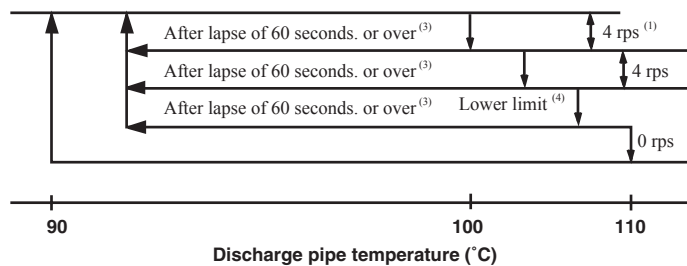

- Notes (1) When the discharge pipe temperature is in the range of 100 to 110 °C, the speed is reduced by 4 rps.
- (2) When the discharge pipe temperature is raised and continues operation for 20 seconds without changing, then the speed is reduced again by 4 rps.
- (3) If the discharge pipe temperature is in the range of 90-100°C even when the compressor speed is maintained for 60 second when the temperature is in the range of 90-100°C, the speed is raised by 1 rps and kept at that speed for 60 second. This process is repeated until the compressor speed is reached.
- (4) Lower limit speed

	Cooling	Heating
Models SRK25, 35, 45	20 rps	30 rps

- 2) If the temperature of 110°C is detected by the sensor on the discharge pipe, then the compressor will stop immediately. When the discharge pipe temperature drops and 3 minutes has elapsed, the unit starts again within 1 hour but there is no start at the third time.

(k) Current safe

(i) Purpose

Current is controlled not to exceed the upper limit of the setting operation current.

(ii) Detail of operation

Input current to the converter is monitored with the current sensor fixed on the printed circuit board of the outdoor unit and, if the operation current value reaches the limiting current value, the compressor speed is reduced.

If the mechanism is actuated when the compressor speed is less than 30 rps, the compressor is stopped immediately. Operation starts again after 3 minutes.

(l) Current cut

(i) Purpose

Inverter is protected from overcurrent.

(ii) Detail of operation

Output current from the inverter is monitored with a shunt resistor and, if the current exceeds the setting value, the compressor is stopped immediately. Operation starts again after 3 minutes.

(m) Outdoor unit failure

This is a function for determining when there is trouble with the outdoor unit during air-conditioning.

The compressor is stopped if any one of the following in item (i), (ii) is satisfied. Once the unit is stopped by this function, it is not restarted.

- (i) When the input current is measured at 1 A or less for 3 continuous minutes or more.
- (ii) If the outdoor unit sends a 0 rps signal to the indoor unit 3 times or more within 20 minutes of the power being turned on.

(n) Indoor fan motor protection

When the air-conditioner is operating and the indoor fan motor is turned ON, if the indoor fan motor has operated at 300 min⁻¹ or under for more than 30 seconds, the unit enters first in the stop mode and then stops the entire system.

(o) Serial signal transmission error protection

(i) Purpose

Prevents malfunction resulting from error on the indoor ↔ outdoor signals.

(ii) Detail of operation

If the compressor is operating and a serial signal cannot be received from the indoor control with outdoor control having serial signals continues for 7 minutes and 35 seconds, the compressor is stopped.

After the compressor has been stopped, it will be restarted after the compressor start delay if a serial signal can be received again from the indoor control.

(p) Rotor lock

If the motor for the compressor does not turn after it has been started, it is determined that a compressor lock has occurred and the compressor is stopped.

(q) Outdoor fan motor protection

If the outdoor fan motor has operated at 75 min⁻¹ or under for more than 30 seconds, the compressor and fan motor are stopped.

(r) **Outdoor fan control at low outdoor temperature**

(i) **Cooling**

1) **Operating conditions**

When the outdoor air temperature (TH2) is 22°C or lower continues for 30 seconds while the compressor speed is other than 0 rps.

2) **Detail of operation**

After the outdoor fan operates at A speed for 60 seconds; the corresponding outdoor heat exchanger temperature shall implement the following controls.

● Value of A

	Outdoor fan
Outdoor temperature > 10°C	2nd speed
Outdoor temperature ≤ 10°C	1st speed

a) Outdoor heat exchanger temperature (TH1) ≤ 21°C

After the outdoor fan speed drops (down) to 1 speed for 60 seconds; if the outdoor heat exchanger temperature is lower than 21°C, gradually reduce the outdoor fan speed by 1 speed. (Lower limit 1st speed)

b) 21°C < Outdoor heat exchanger temperature (TH1) ≤ 38°C

After the outdoor fan speed maintains at A speed for 20 seconds; if the outdoor heat exchanger temperature is 21°C-38°C, maintain outdoor fan speed.

c) Outdoor heat exchanger temperature (TH1) > 38°C

After the outdoor fan speed rises (up) to 1 speed for 60 seconds; if the outdoor heat exchanger temperature is higher than 38°C, gradually increase outdoor fan speed by 1 speed. (Upper limit 3rd speed)

3) **Reset conditions**

When either of the following conditions is satisfied.

a) The outdoor air temperature (TH2) is 25°C or higher.

b) The compressor speed is 0 rps.

(ii) **Heating**

1) **Operating conditions**

When the outdoor air temperature (TH2) is 4°C (model SRK45:0°C) or lower continues for 30 seconds while the compressor speed is other than 0 rps.

2) **Detail of operation**

The outdoor fan is stepped up by 2 speed step at each 20 seconds. (Upper limit; model SRK25 : refer to belows, models SRK35, 45 : 8th speed)

SRK25	Th1 < 21°C	Th1 ≥ 21°C
ON1	8th speed	8th speed
ON2	9th speed	8th speed

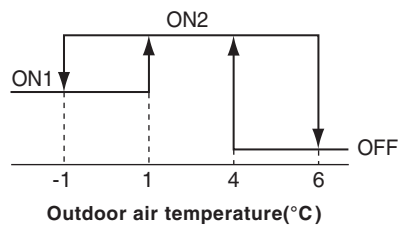

3) **Reset conditions**

When either of the following conditions is satisfied.

a) The outdoor air temperature (TH2) is 6°C (model SRK45:2°C) or higher.

b) The compressor speed is 0 rps.

(s) Refrigeration cycle system protection**(i) Starting conditions**

- 1) When 5 minutes have elapsed after the compressor ON or the completion of the defrost operation
- 2) Other than the defrost operation
- 3) When, after satisfying the conditions of 1) and 2) above, the compressor speed, indoor air temperature (Th1) and indoor heat exchanger temperature (Th2) have satisfied the conditions in the following table for 10 (SRK45:5) minutes:

Operation mode	Compressor speed (N)	Indoor air temperature (Th1)	Room temperature (Th1)/ Indoor heat exchanger temperature (Th2)
Cooling	$50 \leq N$	$10 \leq Th1 \leq 40$	$Th1 - 4 < Th2$
Heating(1)	$50 \leq N$	$0 \leq Th1 \leq 40$	$Th2 < Th1 + 6$

Note (1) Except that the fan speed is HI in heating operation.

(ii) Contents of control

- 1) When the conditions of (i) above are satisfied, the compressor stops.
- 2) Error stop occurs when the compressor has stopped 3 times within 60 minutes.

(iii) Reset condition

When the compressor has been turned OFF.

2. MAINTENANCE DATA

(1) Cautions

- (a) If you are disassembling and checking an air-conditioner, be sure to turn off the power before beginning. When working on indoor units, let the unit sit for about 1 minute after turning off the power before you begin work. When working on an outdoor unit, there may be an electrical charge applied to the main circuit (electrolytic condenser), so begin work only after discharging this electrical charge (to DC 10 V or lower).
- (b) When taking out printed circuit boards, be sure to do so without exerting force on the circuit boards or package components.
- (c) When disconnecting and connecting connectors, take hold of the connector housing and do not pull on the lead wires.

(2) Items to check before troubleshooting

- (a) Have you thoroughly investigated the details of the trouble which the customer is complaining about?
- (b) Is the air-conditioner running? Is it displaying any self-diagnosis information?
- (c) Is a power source with the correct voltage connected?
- (d) Are the control lines connecting the indoor and outdoor units wired correctly and connected securely?
- (e) Is the outdoor unit's service valve open?

(3) Troubleshooting procedure (If the air-conditioner does not run at all)

If the air-conditioner does not run at all, diagnose the trouble using the following troubleshooting procedure. If the air-conditioner is running but breaks down, proceed to troubleshooting step (4).

Important When all the following conditions are satisfied, we say that the air-conditioner will not run at all.

- (a) The RUN light does not light up.
- (b) The flaps do not open.
- (c) The indoor unit fan motors do not run.
- (d) The self-diagnosis display does not function.

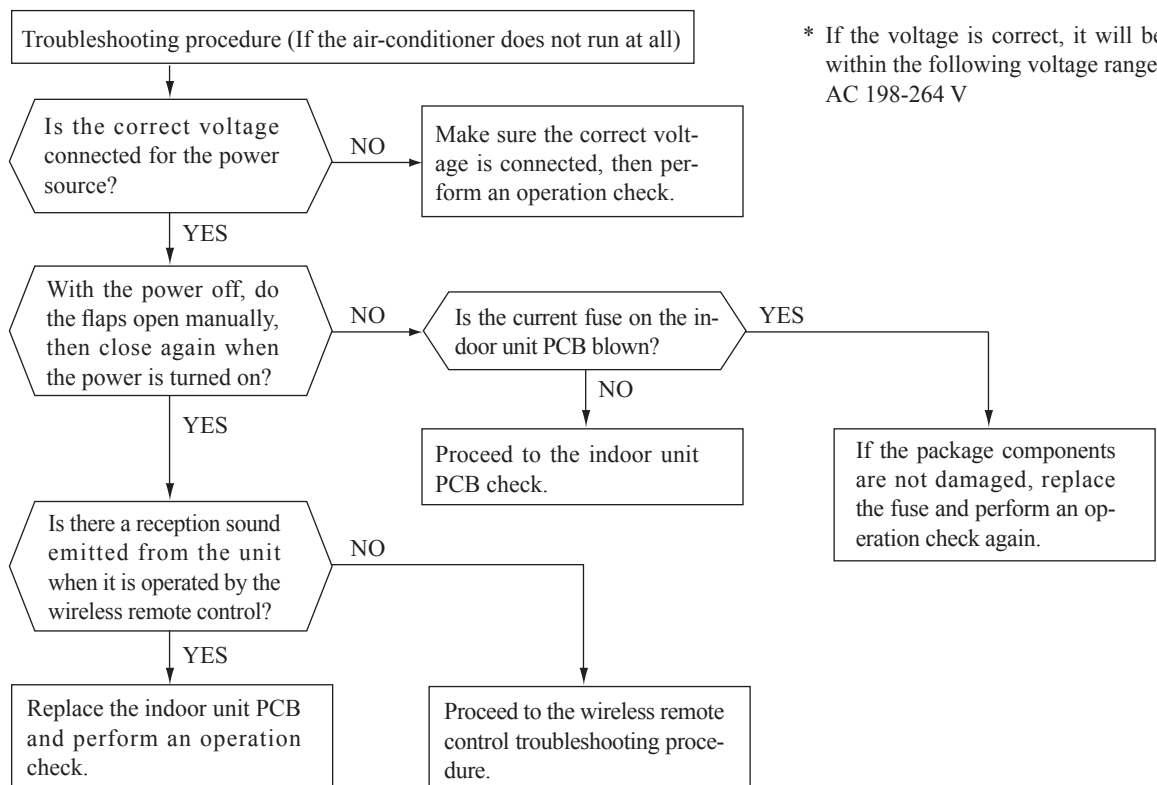

(4) Troubleshooting procedure (If the air-conditioner runs)

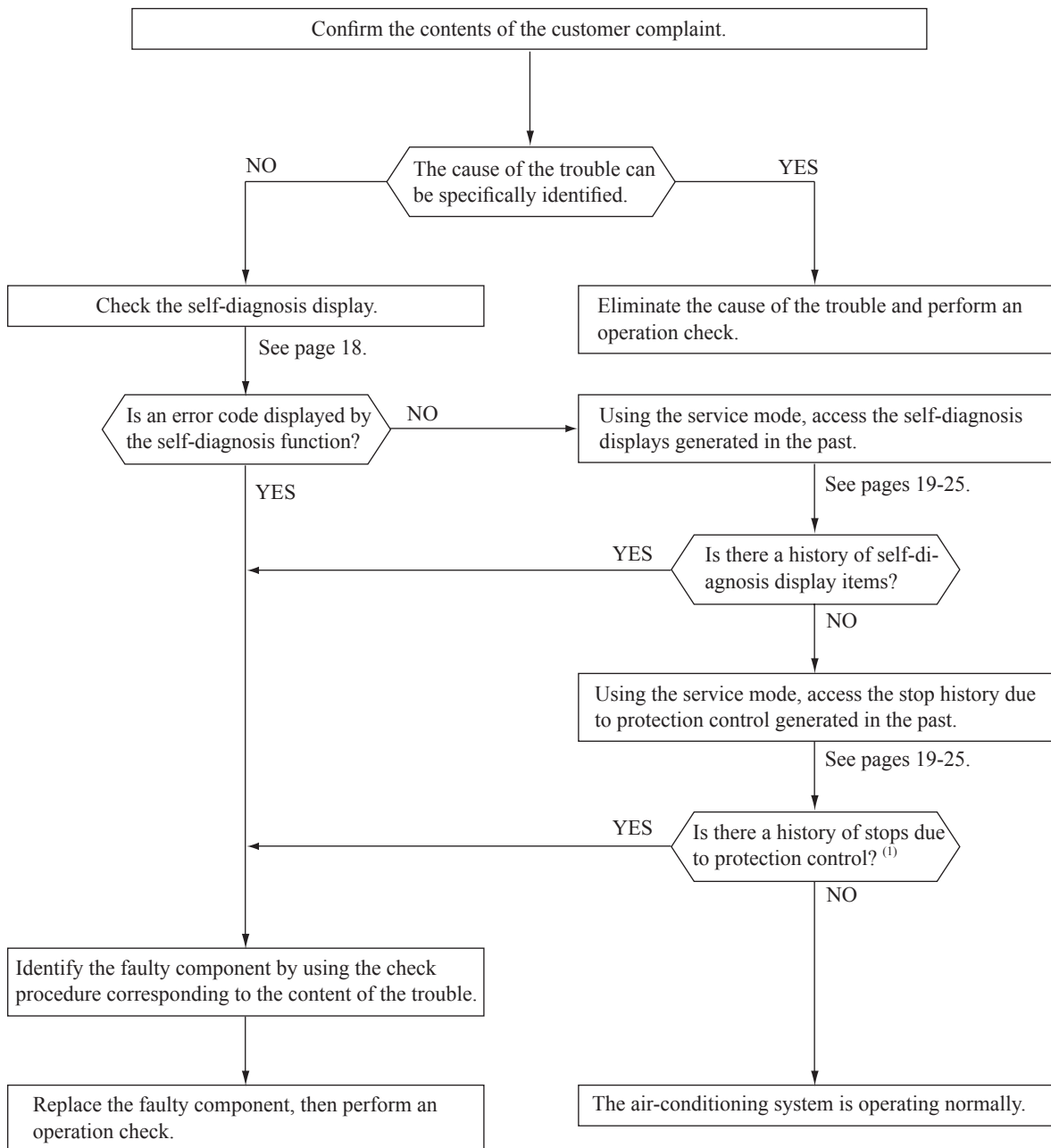

Note (1) Even in cases where only intermittent stop data are generated, the air-conditioning system is normal. However, if the same protective operation recurs repeatedly (3 or more times), it will lead to customer complaints. Judge the conditions in comparison with the contents of the complaints.

(5) Self-diagnosis table

When this air-conditioner performs an emergency stop, the reason why the emergency stop occurred is displayed by the flashing of display lights. If the air-conditioner is operated using the wireless remote control 3 minutes or more after the emergency stop, the trouble display stops and the air-conditioner resumes operation. ⁽¹⁾

Indoor unit display section		Description of trouble	Cause	Display (flashing) condition
RUN light	TIMER light			
1 - time flash	ON	Indoor heat exchanger sensor error	<ul style="list-style-type: none"> Broken heat exchanger sensor wire, poor connector connection Indoor unit PCB is faulty 	When a heat exchanger sensor wire disconnection is detected while operation is stopped. (If a temperature of -28°C or lower is detected for 15 seconds, it is judged that the wire is disconnected.) (Not displayed during operation.)
2 - time flash	ON	Room temperature sensor error	<ul style="list-style-type: none"> Broken room temperature sensor wire, poor connector connection Indoor unit PCB is faulty 	When a room temperature sensor wire disconnection is detected while operation is stopped. (If a temperature of -45°C or lower is detected for 15 seconds, it is judged that the wire is disconnected.) (Not displayed during operation.)
5 - time flash	ON	Active filter voltage error	<ul style="list-style-type: none"> Defective active filter 	When the wrong voltage connected for the power source. When the outdoor unit PCB is faulty.
6 - time flash	ON	Indoor fan motor error	<ul style="list-style-type: none"> Defective fan motor, poor connector connection 	When conditions for turning the indoor unit's fan motor on exist during air-conditioner operation, an indoor unit fan motor speed of 300 min^{-1} or lower is measured for 30 seconds or longer. (The air-conditioner stops.)
7 - time flash	ON	Refrigeration cycle system protective control	<ul style="list-style-type: none"> Service valve is closed. Refrigerant is insufficient 	When refrigeration cycle system protective control operates.
Keeps flashing	1 - time flash	Outdoor air temperature sensor error	<ul style="list-style-type: none"> Broken outdoor air temperature sensor wire, poor connector connection Outdoor unit PCB is faulty 	-55°C or lower is detected for 5 seconds continuously 3 times within 40 minutes after initial detection of this anomalous temperature. Or -55°C or higher is detected for within 20 seconds after power ON. (The compressor is stopped.)
Keeps flashing	2 - time flash	Outdoor heat exchanger sensor error	<ul style="list-style-type: none"> Broken heat exchanger sensor wire, poor connector connection Outdoor unit PCB is faulty 	-55°C or lower is detected for 5 seconds continuously 3 times within 40 minutes after initial detection of this anomalous temperature. Or -55°C or higher is detected for within 20 seconds after power ON. (The compressor is stopped.)
Keeps flashing	4 - time flash	Discharge pipe sensor error	<ul style="list-style-type: none"> Broken discharge pipe sensor wire, poor connector connection Outdoor unit PCB is faulty 	-25°C or lower is detected for 5 seconds continuously 3 times within 40 minutes after initial detection of this anomalous temperature. (The compressor is stopped.)
ON	1 - time flash	Current cut	<ul style="list-style-type: none"> Compressor locking, open phase on compressor output, shortcircuit on power transistor, closed service valve 	The compressor output current (compressor motor current) exceeds the set value during compressor start. (The air-conditioner stops.)
ON	2 - time flash	Trouble of outdoor unit	<ul style="list-style-type: none"> Broken compressor wire Compressor blockage 	When there is an emergency stop caused by trouble in the outdoor unit, or the input current value is found to be lower than the set value. (The air-conditioner stops.)
ON	3 - time flash	Current safe stop	<ul style="list-style-type: none"> Overload operation Overcharge Compressor locking 	When the compressor speed is lower than the set value and the current safe has operated. (The compressor is stopped.)
ON	4 - time flash	Power transistor error	<ul style="list-style-type: none"> Broken power transistor 	When there is an emergency stop caused by trouble in the outdoor unit, or the input current value is found to be lower than the set value continuously for 3 minutes or longer. (The compressor is stopped.)
ON	5 - time flash	Over heat of compressor	<ul style="list-style-type: none"> Gas shortage, defective discharge pipe sensor, closed service valve 	When the value of the discharge pipe sensor exceeds the set value. (The air-conditioner stops.)
ON	6 - time flash	Error of signal transmission	<ul style="list-style-type: none"> Defective power source, Broken signal wire, defective indoor/outdoor unit PCB 	When there is no signal between the indoor unit PCB and outdoor unit PCB for 10 seconds or longer (when the power is turned on), or when there is no signal for 7 minutes 35 seconds or longer (during operation) (The compressor is stopped).
ON	7 - time flash	Outdoor fan motor error	<ul style="list-style-type: none"> Defective fan motor, poor connector connection 	When the outdoor unit's fan motor speed continues for 30 seconds or longer at 75 min^{-1} or lower. (3 times) (The air-conditioner stops.)
ON	Keeps flashing	Cooling high pressure protection	<ul style="list-style-type: none"> Overload operation, overcharge Broken outdoor heat exchange sensor wire Service valve is closed. 	When the value of the outdoor heat exchanger sensor exceeds the set value.
2 - time flash	2 - time flash	Rotor lock	<ul style="list-style-type: none"> Defective compressor Open phase on compressor Defective outdoor unit PCB 	If the compressor motor's magnetic pole positions cannot be correctly detected when the compressor starts. (The air-conditioner stops.)

Notes (1)The air-conditioner cannot be restarted using the wireless remote control for 3 minutes after operation stops.

(6) Service mode (Trouble mode access function)

This air-conditioner is capable of recording error displays and protective stops (service data) which have occurred in the past. If self-diagnosis displays cannot be confirmed, it is possible to get a grasp of the conditions at the time trouble occurred by checking these service data.

(a) Explanation of terms

Term	Explanation
Service mode	The service mode is the mode where service data are displayed by flashing of the display lights when the operations in item (b) below are performed with the indoor control.
Service data	These are the contents of error displays and protective stops which occurred in the past in the air-conditioner system. Error display contents and protective stop data from past anomalous operations of the air-conditioner system are saved in the indoor unit control's non-volatile memory (memory which is not erased when the power goes off). There are two types of data, self-diagnosis data and stop data, described below.
Self-diagnosis data	These are the data which display the reason why a stop occurred when an error display (self-diagnosis display) occurred in an indoor unit. Data are recorded for up to 5 previous occurrences. Data which are older than the 5th previous occurrence are erased. In addition, data on the temperature of each sensor (room temperature, indoor heat exchanger, outdoor heat exchanger, outdoor air temperature, discharge pipe), wireless remote control information (operation switching, fan speed switching) are recorded when trouble occurs, so more detailed information can be checked.
Stop data	These are the data which display the reason by a stop occurred when the air-conditioning system performed protective stops, etc. in the past. Even if stop data alone are generated, the system restarts automatically. (After executing the stop mode while the display is normal, the system restarts automatically.) Data for up to 10 previous occasions are stored. Data older than the 10th previous occasion are erased. (Important) In cases where transient stop data only are generated, the air-conditioner system may still be normal. However, if the same protective stop occurs frequently (3 or more times), it could lead to customer complaints.

(b) Service mode display procedure

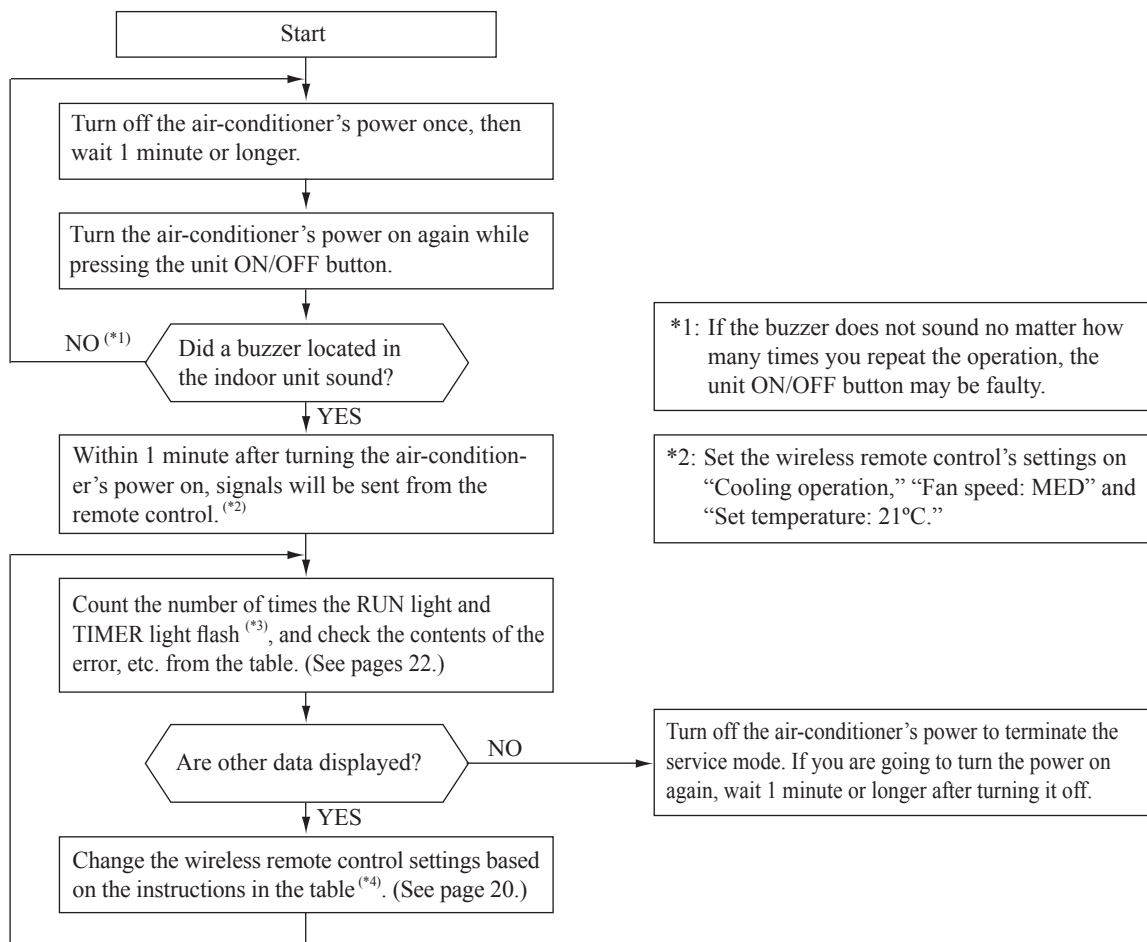

*3: To count the number of flashes in the service mode, count the number of flashes after the light lights up for 1.5 second initially (start signal). (The time that the light lights up for 1.5 second (start signal) is not counted in the number of flashes.)

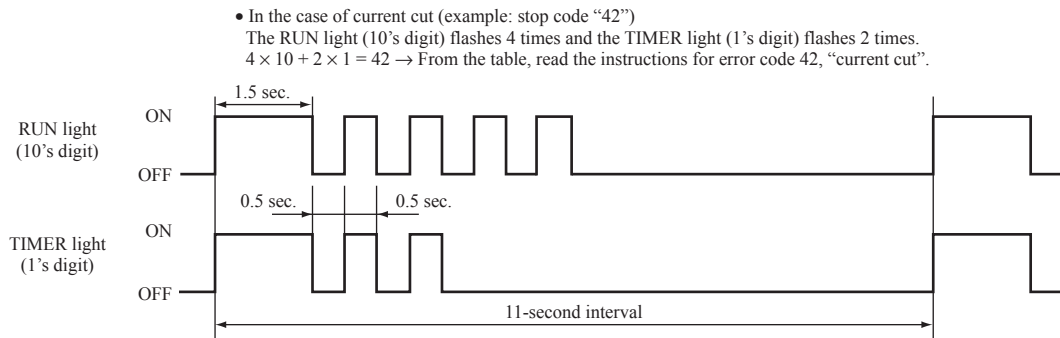

*4: When in the service mode, when the remote control settings (operation switching, fan speed switching, temperature setting) are set as shown in the following table and sent to the air-conditioner unit, the unit switches to display of service data.

① **Self-diagnosis data**

What are Self-diagnosis Data?

These are control data (reasons for stops, temperature at each sensor, wireless remote control information) from the time when there were error displays (abnormal stops) in the indoor unit in the past. Data from up to 5 previous occasions are stored in memory. Data older than the 5th previous occasion are erased. The temperature setting indicates how many occasions previous to the present setting the error display data are and the operation switching and fan speed switching data show the type of data.

Remote control setting		Contents of output data
Operation switching	Fan speed switching	
Cooling	MED	Displays the reason for stopping display in the past (error code).
	HI	Displays the room temperature sensor temperature at the time the error code was displayed in the past.
	AUTO	Displays the indoor heat exchanger sensor temperature at the time the error code was displayed in the past.
Heating	LO	Displays the remote control information at the time the error code was displayed in the past.
	MED	Displays the outdoor air temperature sensor temperature at the time the error code was displayed in the past.
	HI	Displays the outdoor heat exchanger sensor temperature at the time the error code was displayed in the past.
	AUTO	Displays the discharge pipe sensor temperature at the time the error code was displayed in the past.

Remote control setting	Indicates the number of occasions previous to the present the error display data are from.
Temperature setting	
21°C	1 time previous (previous time)
22°C	2 times previous
23°C	3 times previous
24°C	4 times previous
25°C	5 times previous

(Example)

Remote control setting			Displayed data
Operation switching	Fan speed switching	Temperature setting	
Cooling	MED	21°C	Displays the reason for the stop (error code) the previous time an error was displayed.
		22°C	Displays the reason for the stop (error code) 2 times previous when an error was displayed.
		23°C	Displays the reason for the stop (error code) 3 times previous when an error was displayed.
		24°C	Displays the reason for the stop (error code) 4 times previous when an error was displayed.
		25°C	Displays the reason for the stop (error code) 5 times previous when an error was displayed.

② Stop data

Remote control setting			Displayed data
Operation switching	Fan speed switching	Temperature setting	
Cooling	LO	21°C	Displays the reason for the stop (stop code) the previous time when the air-conditioner was stopped by protective stop control.
		22°C	Displays the reason for the stop (stop code) 2 times previous when the air-conditioner was stopped by protective stop control.
		23°C	Displays the reason for the stop (stop code) 3 times previous when the air-conditioner was stopped by protective stop control.
		24°C	Displays the reason for the stop (stop code) 4 times previous when the air-conditioner was stopped by protective stop control.
		25°C	Displays the reason for the stop (stop code) 5 times previous when the air-conditioner was stopped by protective stop control.
		26°C	Displays the reason for the stop (stop code) 6 times previous when the air-conditioner was stopped by protective stop control.
		27°C	Displays the reason for the stop (stop code) 7 times previous when the air-conditioner was stopped by protective stop control.
		28°C	Displays the reason for the stop (stop code) 8 times previous when the air-conditioner was stopped by protective stop control.
		29°C	Displays the reason for the stop (stop code) 9 times previous when the air-conditioner was stopped by protective stop control.
		30°C	Displays the reason for the stop (stop code) 10 times previous when the air-conditioner was stopped by protective stop control.

(c) **Error code, stop code table** (Assignment of error codes and stop codes is done in common for all models.)

Number of flashes when in service mode		Stop code or Error code	Error content	Cause	Occurrence conditions	Error display	Auto recovery
RUN light (10's digit)	TIMER light (1's digit)						
OFF	OFF	0	Normal	—	—	—	—
	5 - time flash	05	Can not receive signals for 35 seconds (if communications have recovered)	Power source is faulty. Power source cables and signal lines are improperly wired. Indoor or outdoor unit PCB are faulty.	When 35 seconds passes without communications signals from either the outdoor unit or the indoor unit being detected correctly.	○	—
3 - time flash	5 - time flash	35	Cooling high pressure control	Cooling overload operation. Outdoor unit fan speed drops. Outdoor heat exchanger sensor is short circuit.	When the outdoor heat exchanger sensor's value exceeds the set value.	○ (5 times)	○
	6 - time flash	36	Compressor overheat 110°C	Refrigerant is insufficient. Discharge pipe sensor is faulty. Service valve is closed.	When the discharge pipe sensor's value exceeds the set value.	○ (2 times)	○
	7 - time flash	37	Outdoor heat exchanger sensor is abnormal	Outdoor heat exchanger sensor wire is disconnected. Connector connections are poor. Outdoor unit PCB is faulty.	-55°C or lower is detected for 5 seconds continuously 3 times within 40 minutes after initial detection of this anomalous temperature. Or -55°C higher is detected for 5 seconds continuously within 20 seconds after power ON.	○ (3 times)	○
	8 - time flash	38	Outdoor air temperature sensor is abnormal	Outdoor air temperature sensor wire is disconnected. Connector connections are poor. Outdoor PCB is faulty.	-55°C or lower is detected for 5 seconds continuously 3 times within 40 minutes after initial detection of this anomalous temperature. Or -55°C higher is detected for 5 seconds continuously within 20 seconds after power ON.	○ (3 times)	○
	9 - time flash	39	Discharge pipe sensor is abnormal (anomalous stop)	Discharge pipe sensor wire is disconnected. Connector connections are poor. Outdoor unit PCB is faulty.	-25°C or lower is detected for 5 seconds continuously 3 times within 40 minutes after initial detection of this anomalous temperature.	○ (3 times)	○
4 - time flash	2 - time flash	42	Current cut	Compressor lock. Compressor wiring short circuit. Compressor output is open phase. Outdoor unit PCB is faulty. Service valve is closed. Electronic expansion valve is faulty. Compressor is faulty.	Compressor start fails 42 times in succession and the reason for the final failure is current cut.	○ (2 times)	○
	7 - time flash	47	Active filter voltage error	Defective active filter.	When the wrong voltage connected for the power source. When the outdoor unit PCB is faulty.	○	—
	8 - time flash	48	Outdoor unit's fan motor is abnormal	Outdoor fan motor is faulty. Connector connections are poor. Outdoor unit PCB is faulty.	When a fan speed of 75 min ⁻¹ or lower continues for 30 seconds or longer.	○ (3 times)	○
5 - time flash	1 - time flash	51	Short circuit in the power transistor (high side) Current cut circuit breakdown	Outdoor unit PCB is faulty. Power transistor is damaged.	When it is judged that the power transistor was damaged at the time the compressor started.	○	—
	7 - time flash	57	Refrigeration cycle system protective control	Service valve is closed. Refrigerant is insufficient.	When refrigeration cycle system protective control operates.	○ (3 times)	○
	8 - time flash	58	Current safe	Refrigerant is overcharge. Compressor lock. Overload operation.	When there is a current safe stop during operation.	—	○
	9 - time flash	59	Compressor wiring is unconnection Voltage drop Low speed protective control	Compressor wiring is disconnected. Power transistor is damaged. Power source construction is defective. Outdoor unit PCB is faulty. Compressor is faulty.	When the current is 1A or less at the time the compressor started. When the power source voltage drops during operation. When the compressor command speed is lower than 32 rps for 60 minutes.	○	○
6 - time flash	OFF	60	Rotor lock	Compressor is faulty. Compressor output is open phase. Electronic expansion valve is faulty. Overload operation. Outdoor unit PCB is faulty.	After the compressor starts, when the compressor stops due to rotor lock.	○ (2 times)	○
	1 - time flash	61	Connection lines between the indoor and outdoor units are faulty	Connection lines are faulty. Indoor or outdoor unit PCB are faulty.	When 10 seconds passes after the power is turned on without communications signals from the indoor or outdoor unit being detected correctly.	○	—
	2 - time flash	62	Serial transmission error	Indoor or outdoor unit PCB are faulty. Noise is causing faulty operation.	When 7 minutes 35 seconds passes without communications signals from either the outdoor unit or the indoor unit being detected correctly.	○	—
8 - time flash	OFF	80	Indoor unit's fan motor is abnormal	Indoor fan motor is faulty. Connector connections are poor. Indoor unit PCB is faulty.	When the indoor unit's fan motor is detected to be running at 300 min ⁻¹ or lower speed with the fan motor in the ON condition while the air-conditioner is running.	○	—
	2 - time flash	82	Indoor heat exchanger sensor is abnormal (anomalous stop)	Indoor heat exchanger sensor wire is disconnected. Connector connections are poor.	When a temperature of -28°C or lower is sensed continuously for 40 minutes during heating operation. (The compressor stops.)	○	—
	4 - time flash	84	Anti-condensation control	High humidity condition. Humidity sensor is faulty.	Anti-condensation prevention control is operating.	—	○
	5 - time flash	85	Anti-frost control	Indoor unit fan speed drops. Indoor heat exchanger sensor is broken wire.	When the anti-frost control operates and the compressor stops during cooling operation.	—	○
	6 - time flash	86	Heating high pressure control	Heating overload operation. Indoor unit fan speed drops. Indoor heat exchanger sensor is short-circuit.	When high pressure control operates during heating operation and the compressor stops.	—	○

Note (1) The number of flashes when in the service mode do not include the 1.5 second period when the lights light up at first (start signal). (See the example shown below.)

- In the case of current cut (example: stop code “42”)
 - The RUN light (10’s digit) flashes 4 times and the TIMER light (1’s digit) flashes 2 times.
 - $4 \times 10 + 2 \times 1 = 42 \rightarrow$ From the table, read the instructions for error code 42, “Current cut”.

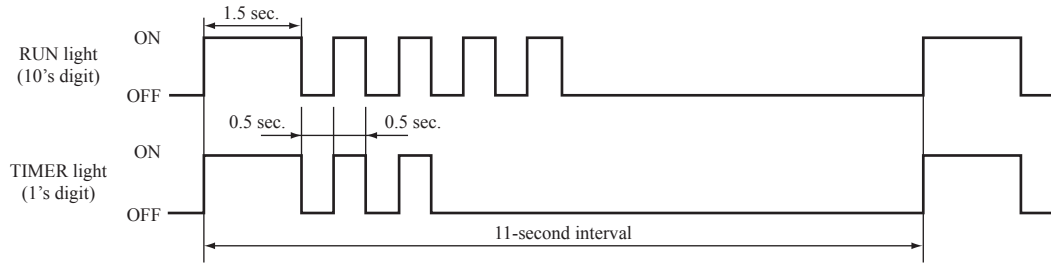

- (2) Abnormal Stop: – Is not displayed. (automatic recovery only)
 ○Displayed.
 If there is a () displayed, the error display shows the number of times that an automatic recovery occurred for the same reason has reached the number of times in ().
 If no () is displayed, the error display shows that the trouble has occurred once.
- (3) Automatic Recovery: – Does not occur.
 ○Automatic recovery occurs.

(d) **Wireless remote control information tables**

1) Operation switching

Display pattern when in service mode	Operation switching when there is an abnormal stop
RUN light (Operation switching)	
0	AUTO
1	DRY
2	COOL
3	FAN
4	HEAT

2) Fan speed switching

Display pattern when in service mode	Fan speed switching when there is an abnormal stop
TIMER light (Fan speed switching)	
0	AUTO
2	HI
3	MED
4	LO
6	HI POWER
7	ECONO

* If no data are recorded (error code is normal), the information display in the wireless remote control becomes as follows.

Wireless remote control setting	Display when error code is normal.
Operation switching	AUTO
Fan speed switching	AUTO

(Example): Operation switching, fan speed switching, cooling: HI

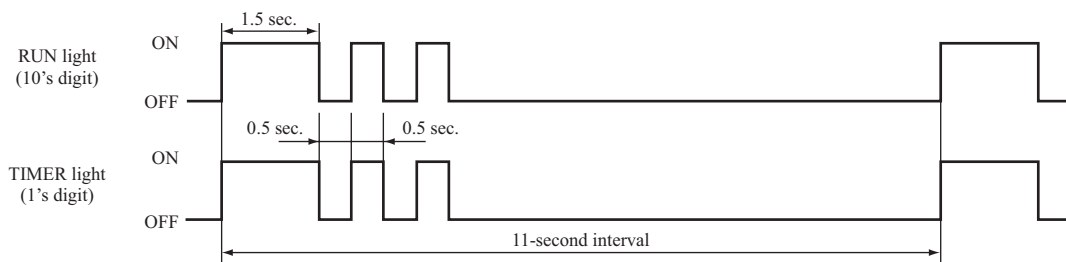

(e) Room temperature sensor temperature, indoor heat exchanger sensor temperature, outdoor air temperature sensor temperature, outdoor heat exchanger sensor temperature table

Unit: °C

Buzzer sound	RUN light (10's digit)	TIMER light (1's digit)									
		0	1	2	3	4	5	6	7	8	9
Yes (sounds for 0.1 second)	6	-60	-61	-62	-63	-64					
	5	-50	-51	-52	-53	-54	-55	-56	-57	-58	-59
	4	-40	-41	-42	-43	-44	-45	-46	-47	-48	-49
	3	-30	-31	-32	-33	-34	-35	-36	-37	-38	-39
	2	-20	-21	-22	-23	-24	-25	-26	-27	-28	-29
	1	-10	-11	-12	-13	-14	-15	-16	-17	-18	-19
	0	/	-1	-2	-3	-4	-5	-6	-7	-8	-9
No (does not sound)	0	0	1	2	3	4	5	6	7	8	9
	1	10	11	12	13	14	15	16	17	18	19
	2	20	21	22	23	24	25	26	27	28	29
	3	30	31	32	33	34	35	36	37	38	39
	4	40	41	42	43	44	45	46	47	48	49
	5	50	51	52	53	54	55	56	57	58	59
	6	60	61	62	63	64	65	66	67	68	69
	7	70	71	72	73	74	75	76	77	78	79
	8	80	81	82	83	84	85	86	87	88	89
	9	90	91	92	93	94	95	96	97	98	99

* If no data are recorded (error code is normal), the display for each sensor becomes as shown below.

Sensor name	Sensor value displayed when the error code is normal
Room temperature sensor temperature	-19°C
Indoor heat exchanger sensor temperature	-64°C
Outdoor air temperature sensor temperature	-64°C
Outdoor heat exchanger sensor temperature	-64°C

(Example) Room temperature, indoor heat exchanger, outdoor air temperature, outdoor heat exchanger: “-9°C”

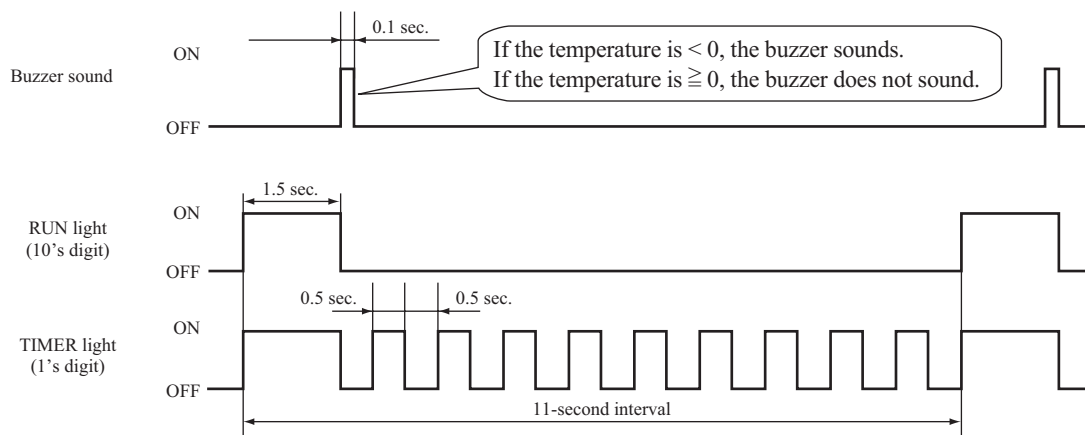

(f) Discharge pipe temperature table

Unit: °C

RUN light (10's digit)		TIMER light (1's digit)									
		0	1	2	3	4	5	6	7	8	9
Buzzer sound											
Yes (sounds for 0.1 second)	3	-60	-62	-64							
	2	-40	-42	-44	-46	-48	-50	-52	-54	-56	-58
	1	-20	-22	-24	-26	-28	-30	-32	-34	-36	-38
	0	/	-2	-4	-6	-8	-10	-12	-14	-16	-18
No (does not sound)	0	0	2	4	6	8	10	12	14	16	18
	1	20	22	24	26	28	30	32	34	36	38
	2	40	42	44	46	48	50	52	54	56	58
	3	60	62	64	66	68	70	72	74	76	78
	4	80	82	84	86	88	90	92	94	96	98
	5	100	102	104	106	108	110	112	114	116	118
	6	120	122	124	126	128	130	132	134	136	138
	7	140	142	144	146	148	150				

* If no data is recorded (error code is normal), the display for sensor becomes as shown below.

Sensor name	Sensor value displayed when the error code is normal
Discharge pipe sensor temperature	-64°C

(Example) Discharge pipe temperature: "122°C"

* In the case of discharge pipe data, multiply the reading value by 2. (Below, 61 x 2 = "122°C")

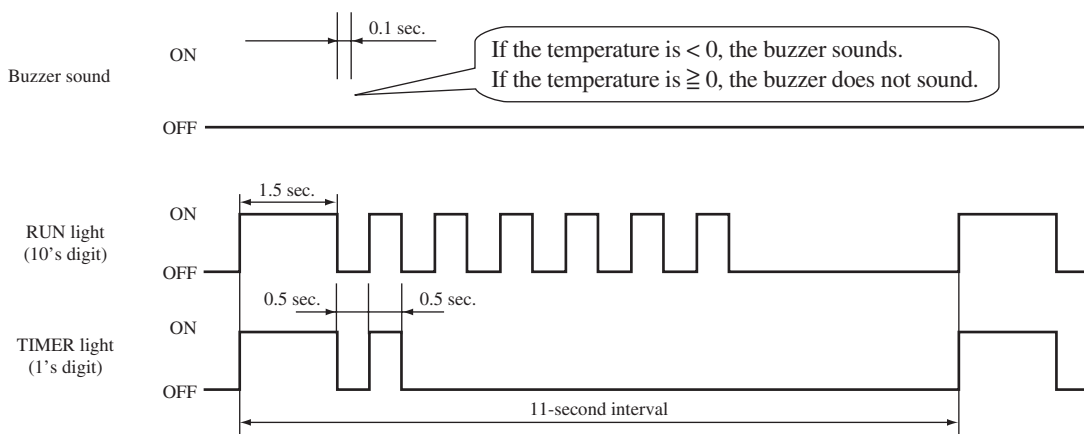

Service data record form

Customer			Model				
Date of investigation							
Machine name							
Content of complaint							
Remote control settings			Content of displayed data	Display results			Display content
Temperature setting	Operation switching	Fan speed switching		Buzzer (Yes/No.)	RUN light (Times)	TIMER light (Times)	
21	Cooling	MED	Error code on previous occasion.	/			
		HI	Room temperature sensor temperature on previous occasion.				
		AUTO	Indoor heat exchanger sensor temperature on previous occasion.				
	Heating	LO	Remote control information on previous occasion.	/			
		MED	Outdoor air temperature sensor temperature on previous occasion.				
		HI	Outdoor heat exchanger sensor temperature on previous occasion.				
22	Cooling	MED	Error code on second previous occasion.	/			
		HI	Room temperature sensor temperature on second previous occasion.				
		AUTO	Indoor heat exchanger sensor temperature on second previous occasion.				
	Heating	LO	Remote control information on second previous occasion.	/			
		MED	Outdoor air temperature sensor temperature on second previous occasion.				
		HI	Outdoor heat exchanger sensor temperature on second previous occasion.				
23	Cooling	MED	Error code on third previous occasion.	/			
		HI	Room temperature sensor temperature on third previous occasion.				
		AUTO	Indoor heat exchanger sensor temperature on third previous occasion.				
	Heating	LO	Remote control information on third previous occasion.	/			
		MED	Outdoor air temperature sensor temperature on third previous occasion.				
		HI	Outdoor heat exchanger sensor temperature on third previous occasion.				
24	Cooling	MED	Error code on fourth previous occasion.	/			
		HI	Room temperature sensor temperature on fourth previous occasion.				
		AUTO	Indoor heat exchanger sensor temperature on fourth previous occasion.				
	Heating	LO	Remote control information on fourth previous occasion.	/			
		MED	Outdoor air temperature sensor temperature on fourth previous occasion.				
		HI	Outdoor heat exchanger sensor temperature on fourth previous occasion.				
25	Cooling	MED	Error code on fifth previous occasion.	/			
		HI	Room temperature sensor temperature on fifth previous occasion.				
		AUTO	Indoor heat exchanger sensor temperature on fifth previous occasion.				
	Heating	LO	Remote control information on fifth previous occasion.	/			
		MED	Outdoor air temperature sensor temperature on fifth previous occasion.				
		HI	Outdoor heat exchanger sensor temperature on fifth previous occasion.				
21	Cooling	LO	Stop code on previous occasion.				
22			Stop code on second previous occasion.				
23			Stop code on third previous occasion.				
24			Stop code on fourth previous occasion.				
25			Stop code on fifth previous occasion.				
26			Stop code on sixth previous occasion.				
27			Stop code on seventh previous occasion.				
28			Stop code on eighth previous occasion.				
29			Stop code on ninth previous occasion.				
30			Stop code on tenth previous occasion.				
Judgment							Examiner
Remarks							

(7) Inspection procedures corresponding to detail of trouble

Sensor error

[Broken sensor wire, connector poor connection]

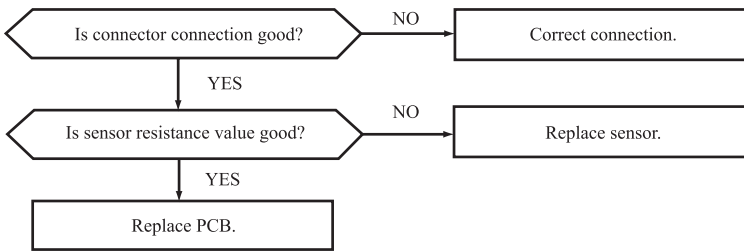

◆ Discharge pipe sensor temperature characteristics

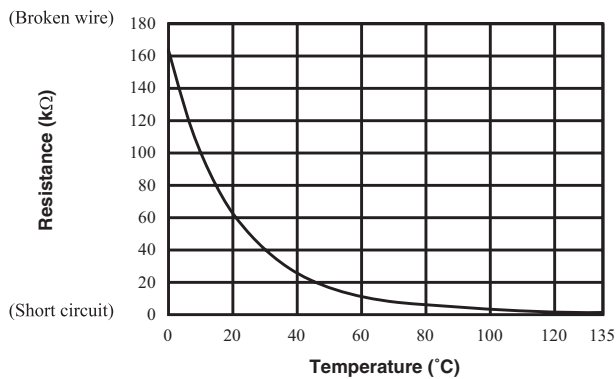

◆ Sensor temperature characteristics (Room temp., indoor heat exchanger temp., outdoor heat exchanger temp., outdoor air temp.)

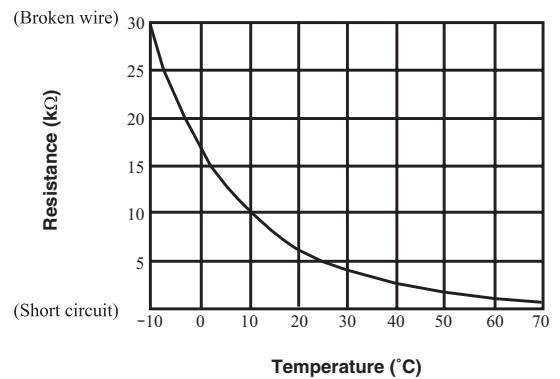

Indoor fan motor error

[Defective fan motor, connector poor connection, defective indoor unit PCB]

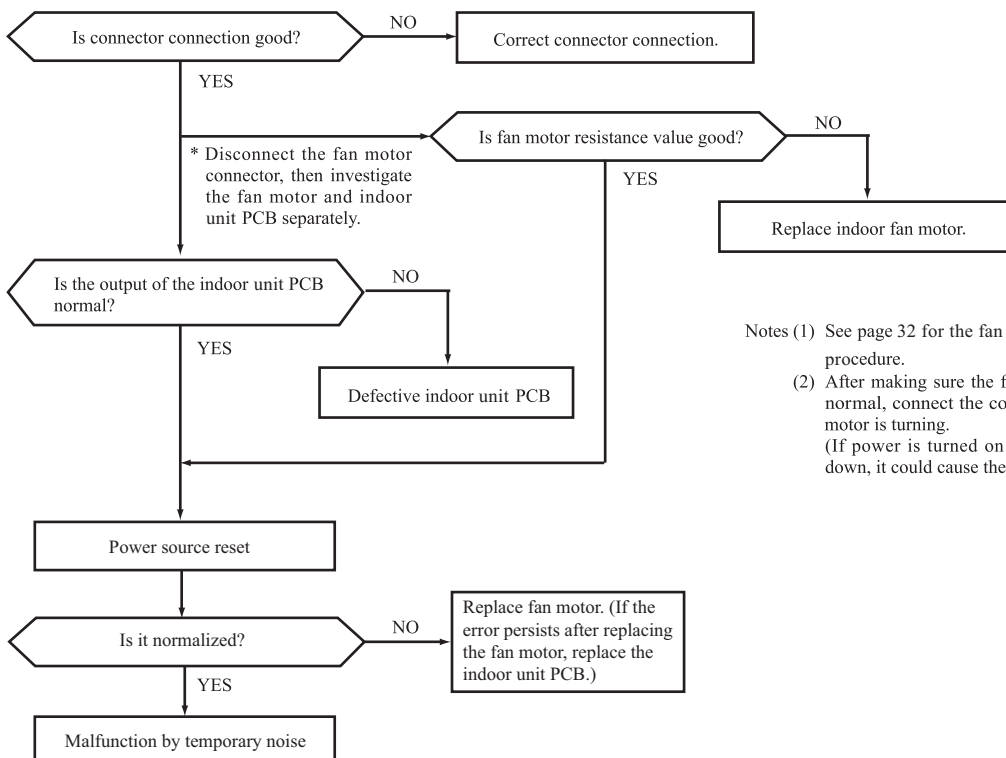

Notes (1) See page 32 for the fan motor and indoor unit PCB check procedure.

(2) After making sure the fan motor and indoor unit PCB are normal, connect the connectors and confirm that the fan motor is turning.

(If power is turned on while one or the other is broken down, it could cause the other to break down also.)

Current cut

[Compressor lock, Compressor wiring short circuit, Compressor output is open phase, Outdoor unit PCB is faulty, Service valve is closed, EEV is faulty, Compressor faulty.]

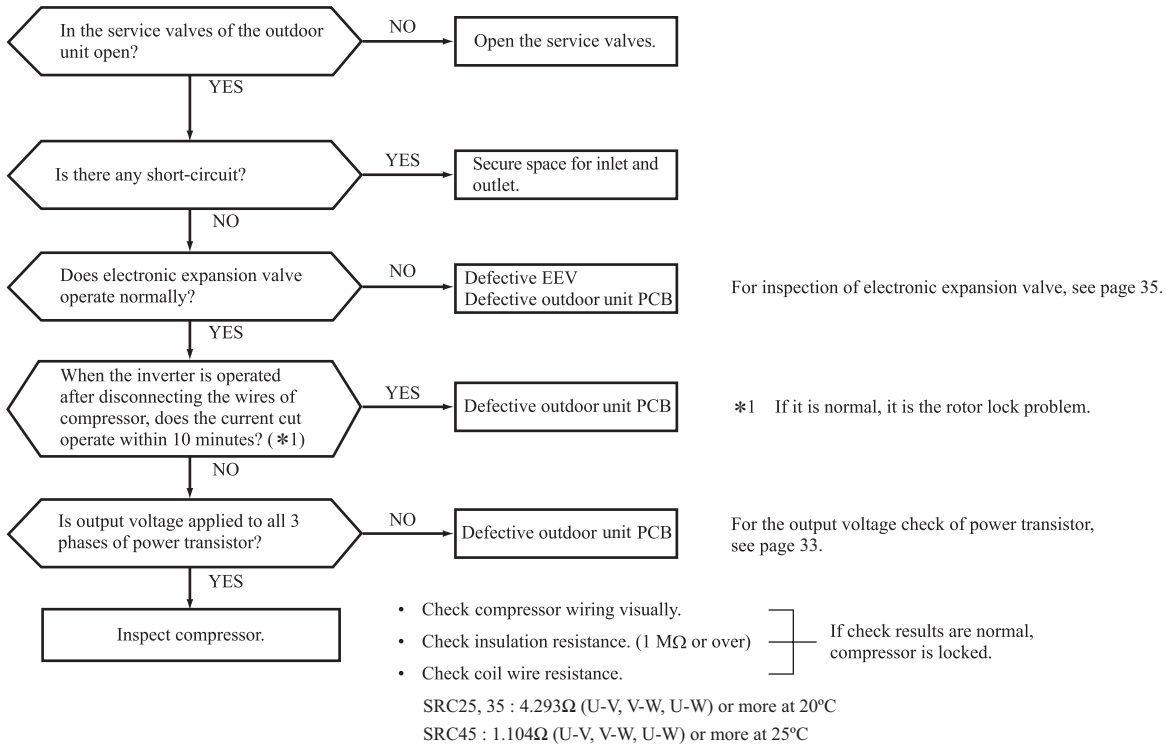

Current safe stop

[Overload operation, compressor lock, overcharge]

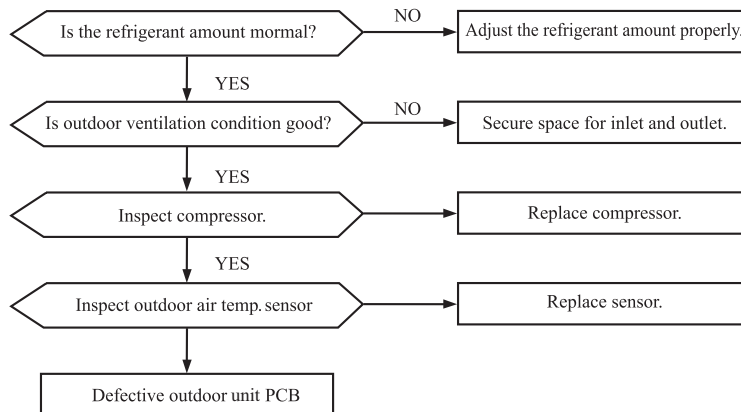

Over heat of compressor

[Gas shortage, defective discharge pipe sensor]

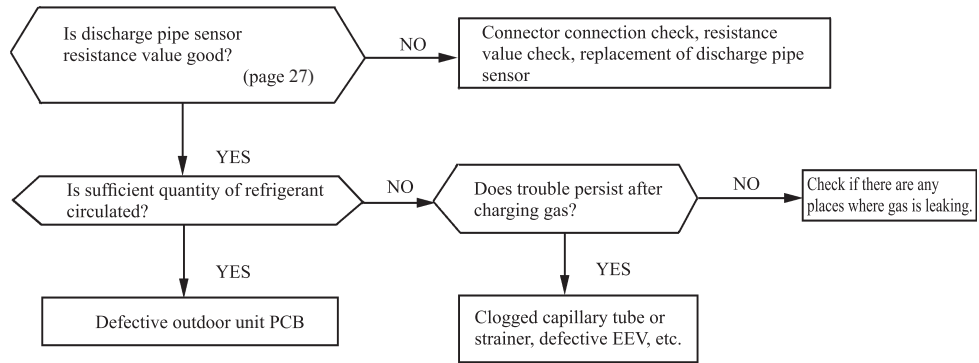

Error of signal transmission

[Wiring error including power cable, defective indoor/ outdoor unit PCB]

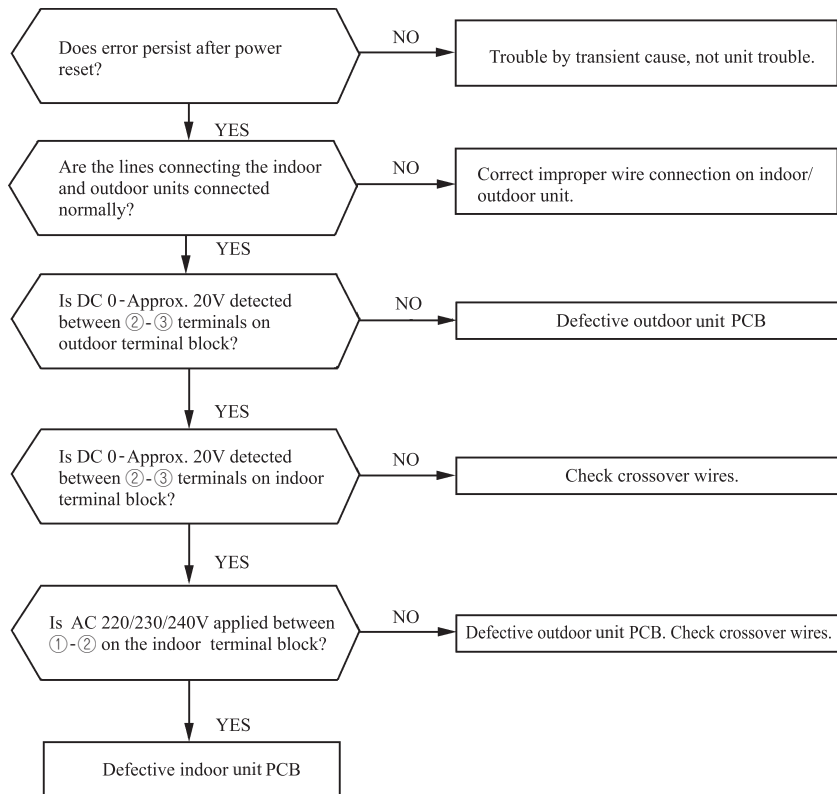

Trouble of outdoor unit

[Insufficient refrigerant amount, Faulty power transistor, Broken compressor wire]
 [Service valve close, Defective EEV, Defective outdoor unit PCB]

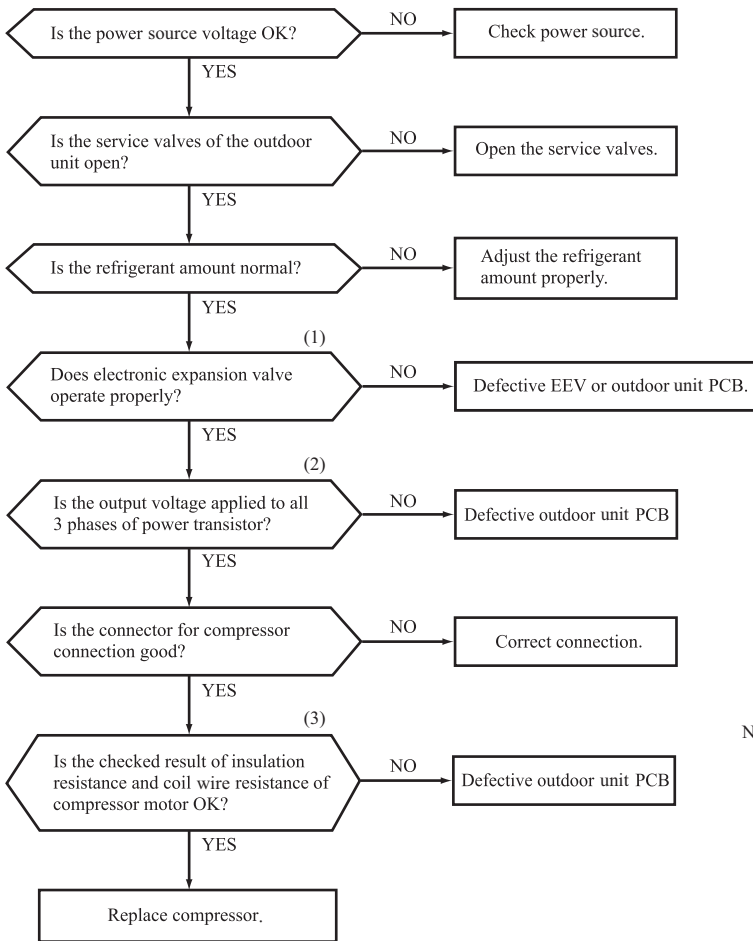

Proper power source voltages are as follows.
 (At the power source outlet)
 AC 220V : AC 198-242V
 AC 230V : AC 207-253V
 AC 240V : AC 216-264V

- ◆ Judgment of refrigerant quantity
- (1) Phenomenon of insufficient refrigerant
 - (a) Loss of capacity
 - (b) Poor defrost operation
(Frost is not removed completely.)
 - (c) Longer time of hot keep
(5 minute or more)
(Normal time: Approx. 1 – 1 minute and 30 seconds)

- Notes (1) For inspection of electronic expansion valve, see page 35.
 (2) For the output voltage check of power transistor, see page 33.
 (3) Check coil wire resistance, see page 28.

Outdoor fan motor error

[Defective fan motor, connector poor connection, defective outdoor unit PCB]

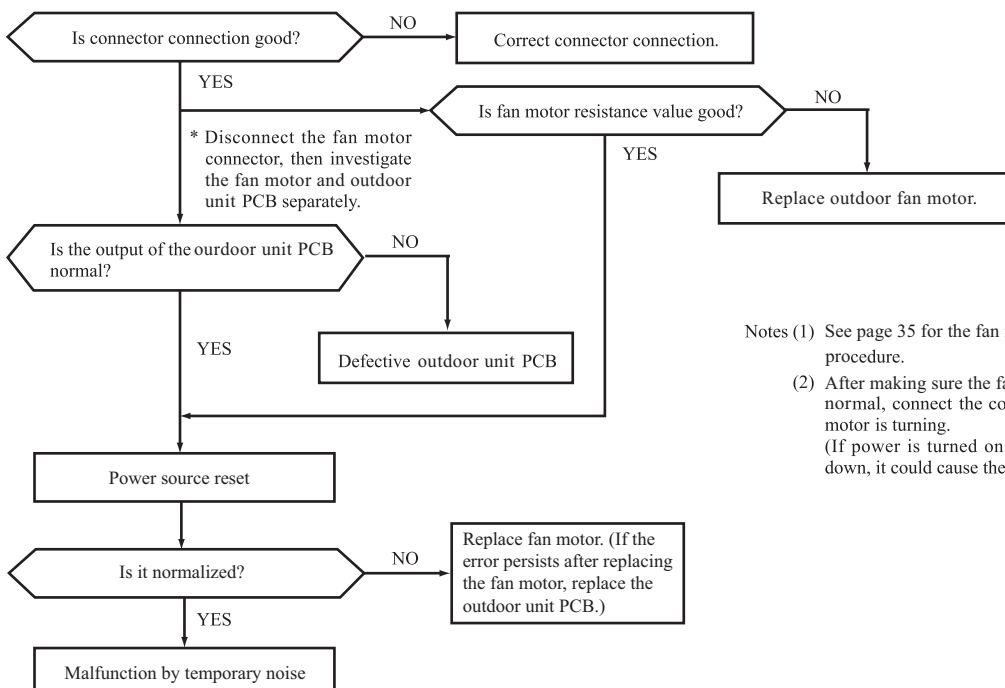

- Notes (1) See page 35 for the fan motor and outdoor unit PCB check procedure.
 (2) After making sure the fan motor and outdoor unit PCB are normal, connect the connectors and confirm that the fan motor is turning.
 (If power is turned on while one or the other is broken down, it could cause the other to break down also.)

Rotor lock

[Defective compressor, defective outdoor unit PCB]

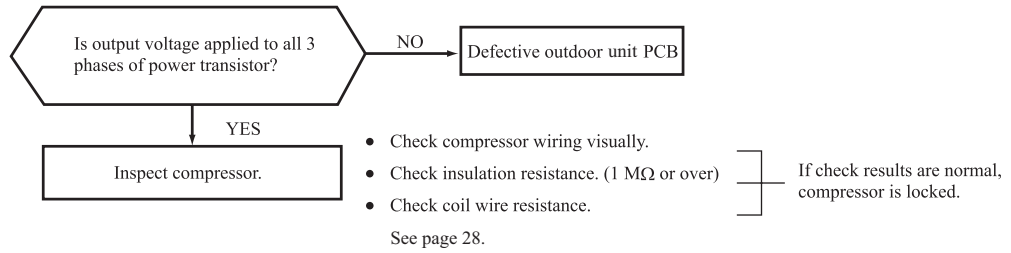

(8) Phenomenon observed after short-circuit, wire breakage on sensor

(a) Indoor unit

Sensor	Operation mode	Phenomenon	
		Short-circuit	Disconnected wire
Room temperature sensor	Cooling	Release of continuous compressor operation command.	Continuous compressor operation command is not released.
	Heating	Continuous compressor operation command is not released.	Release of continuous compressor operation command.
Heat exchanger sensor	Cooling	System can be operated normally.	Continuous compressor operation command is not released. (Anti-frosting)
	Heating	High pressure control mode (Compressor stop command)	Hot keep (Indoor fan stop)
Humidity sensor	Cooling	Refer to the table below.	Refer to the table below.
	Heating	Normal system operation is possible.	

■ Humidity sensor operation

Failure mode	Control input circuit reading	Air conditioning system operation
Disconnected wire	① Disconnected wire	Humidity reading is 0% Anti-condensation control is not done.
	② Disconnected wire	
	①② Disconnected wire	
Short-circuit	① and ② are short-circuited.	Humidity reading is 100% Anti-condensation control keep doing.

Remark: Do not perform a continuity check of the humidity sensor with a tester. If DC current is applied, it could damage the sensor.

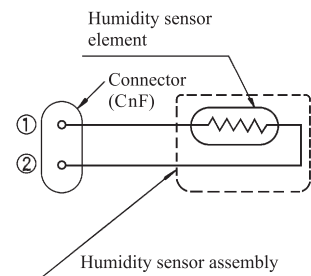

(b) Outdoor unit

Sensor	Operation mode	Phenomenon	
		Shortcircuit	Disconnected wire
Heat exchanger sensor	Cooling	System can be operated normally.	Compressor stop
	Heating	Defrost operation is not performed.	Defrost operation is performed for 10 minutes at approx. 35 (model SRC35:45) minutes.
Outdoor air temperature sensor	Cooling	System can be operated normally.	Compressor stop
	Heating	Defrost operation is not operated.	Defrost operation is performed for 10 minutes at approx. 35 (model SRC35:45) minutes.
Discharge pipe sensor	All modes	Compressor overload protection is disabled. (Can be operated.)	Compressor stop

(9) Checking the indoor electrical equipment

(a) Indoor unit PCB check procedure

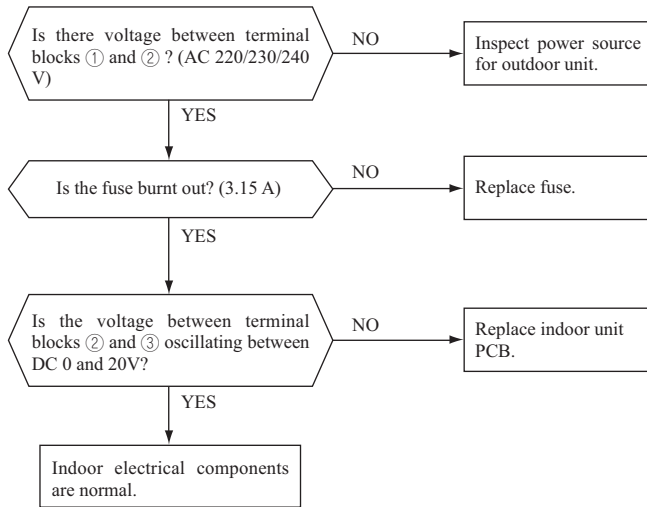

(b) Indoor unit fan motor check procedure

This is a diagnostic procedure for determining if the indoor unit’s fan motor or the indoor unit PCB is broken down.

1) Indoor unit PCB output check

- a) Turn off the power.
- b) Remove the front panel, then disconnect the fan motor lead wire connector.
- c) Turn on the power. If the unit operates when the ON/OFF button is pressed, if trouble is detected after the voltages in the following figure are output for approximately 30 seconds, it means that the indoor unit PCB is normal and the fan motor is broken down.

If the voltages in the following figure are not output at connector pins No. ①, ④ and ⑤, the indoor unit PCB has failed and the fan motor is normal.

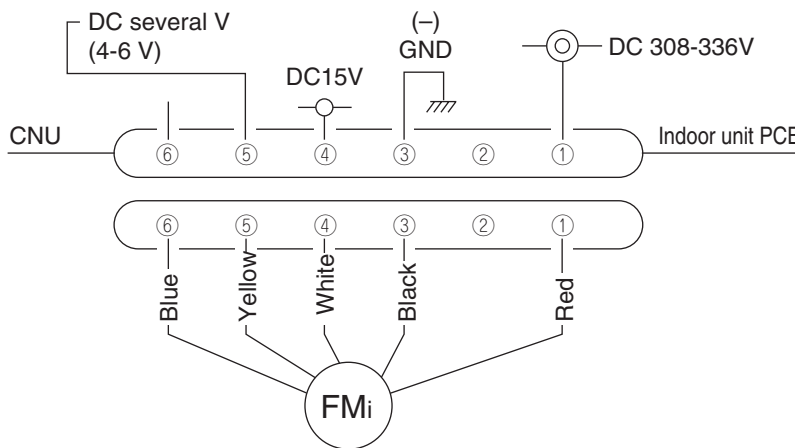

Measuring point	Voltage range when normal
① - ③	DC 308-336V
④ - ③	DC 15V
⑤ - ③	DC several V (4-6V)

2) Fan motor resistance check

Measuring point	Resistance when normal
① - ③ (Red - Black)	20 MΩ or higher
④ - ③ (White - Black)	20 kΩ or higher

- Notes (1) Remove the fan motor and measure it without power connected to it.
 (2) If the measured value is below the value when the motor is normal, it means that the fan motor is faulty.

(c) Power transistor inspection procedure

[Use a tester with a needle indicator for the inspection. (Do not use a digital tester. Check in the AC 300 volt range.)]

(1) If there is a self-diagnosis display, inspect the compressor system (burns, wiring mistakes, etc.) If no problems are found, check the output of the power transistor.

(2) Output inspection procedure

Disconnect the terminals for the compressor.

If an output such as the one shown in the figure on the below can be measured, the power transistor and the circuit board for the outdoor unit are normal.

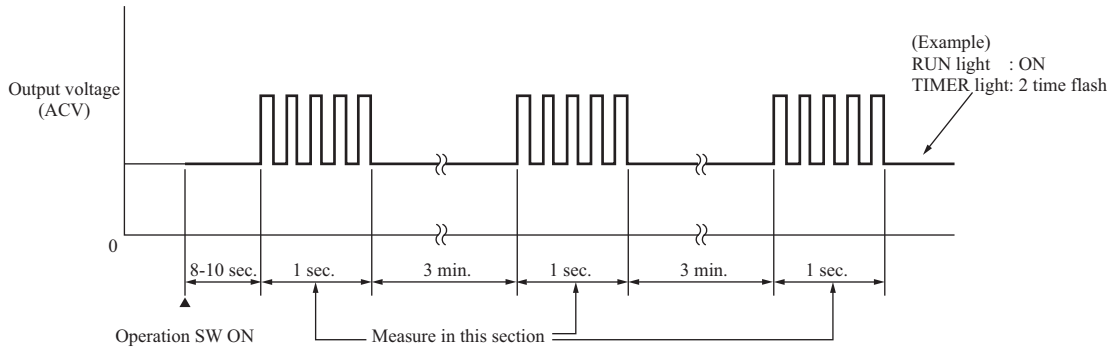

(10) How to make sure of wireless remote control

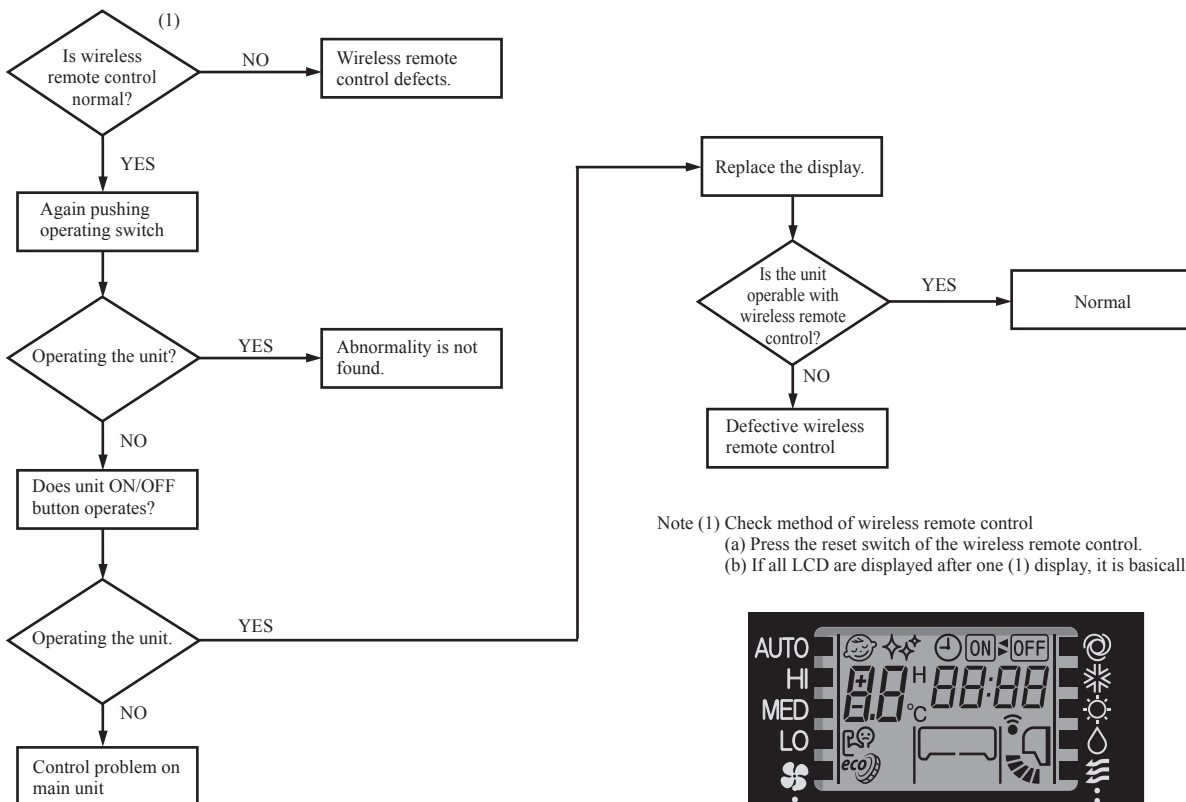

Note (1) Check method of wireless remote control
 (a) Press the reset switch of the wireless remote control.
 (b) If all LCD are displayed after one (1) display, it is basically normal.



(11) Outdoor unit inspection points
Models SRC25ZSP-S, 35ZSP-S, 45ZSP-S

◆ **Check point of outdoor unit**

⚠ CAUTION – HIGH VOLTAGE

High voltage is produced in the control box. Don't touch electrical parts in the control box for 5 minutes after the unit is stopped.

Power source
 1 Phase
 220-240V 50Hz

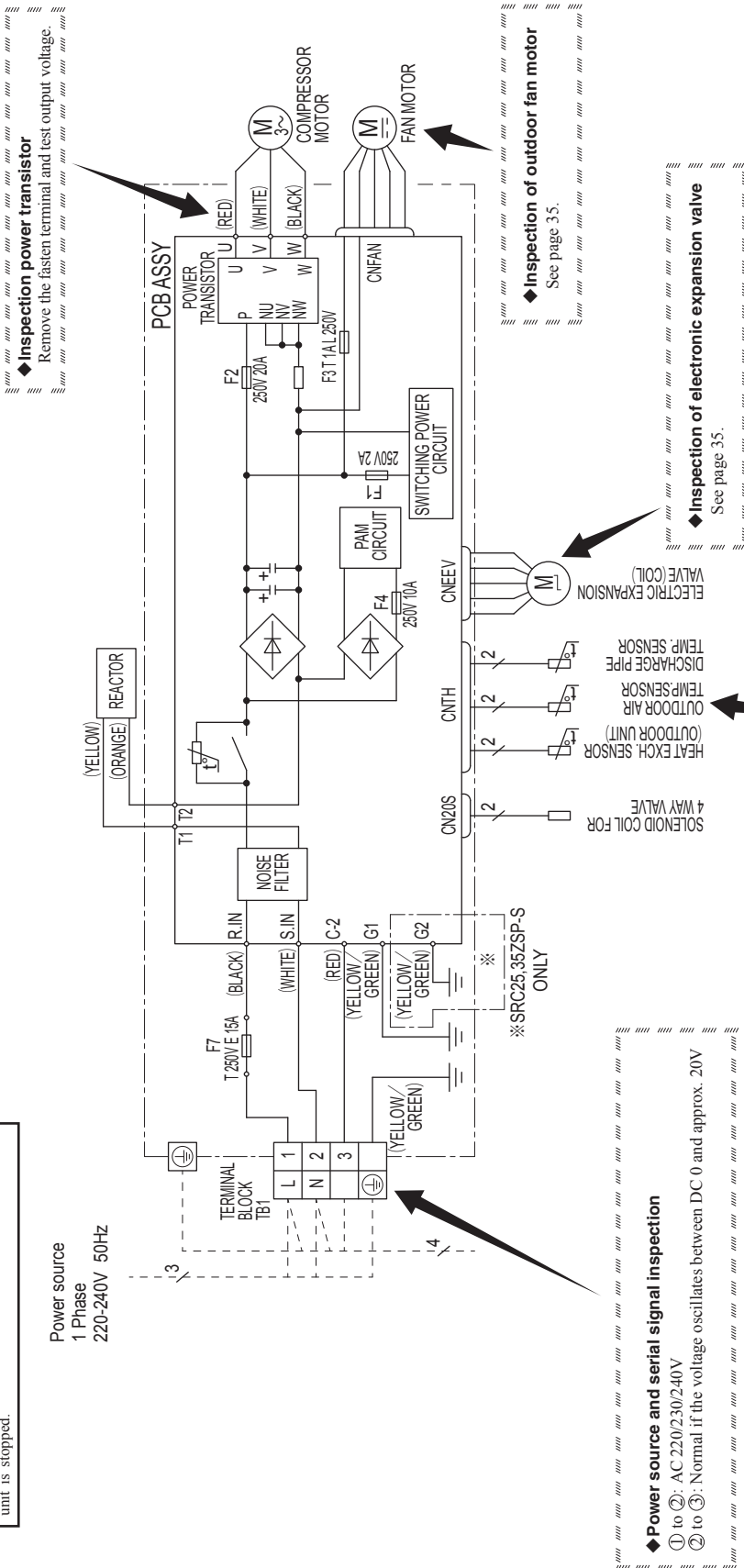

◆ **Inspection power transistor**
 Remove the fasten terminal and test output voltage.

◆ **Inspection of outdoor fan motor**
 See page 35.

◆ **Inspection of electronic expansion valve**
 See page 35.

◆ **Inspection of resistance value of sensor**
 Remove the connector and check the resistance value.
 See the section of sensor characteristics on page 27.

◆ **Power source and serial signal inspection**

- ① to ②: AC 220/230/240V
- ② to ③: Normal if the voltage oscillates between DC 0 and approx. 20V

(a) Inspection of electronic expansion valve

Electronic expansion valve operates for approx. 10 seconds after the power on, in order to determine its aperture. Check the operating sound and voltage during the period of time. (Voltage cannot be checked during operation in which only the aperture change occurs.)

- (i) If it is heard the sound of operating electronic expansion valve, it is almost normal.
- (ii) If the operating sound is not heard, check the output voltage.

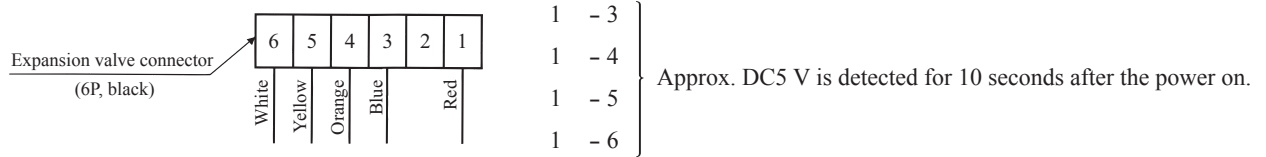

- (iii) If voltage is detected, the outdoor unit PCB is normal.
- (iv) If the expansion valve does not operate (no operating sound) while voltage is detected, the expansion valve is defective.

• Inspection of electronic expansion valve as a separate unit

Measure the resistance between terminals with an analog tester.

Measuring point	Resistance when normal
1-6	46 ± 4Ω (at 20°C)
1-4	
1-3	
1-5	

(b) Outdoor unit fan motor check procedure

- When the outdoor unit fan motor error is detected, diagnose which of the outdoor unit fan motor or outdoor unit PCB is defective.
- Diagnose this only after confirming that the indoor unit is normal.

(i) Outdoor unit PCB output check

- 1) Turn off the power.
- 2) Disconnect the outdoor unit fan motor connector CNFAN.
- 3) When the indoor unit is operated by inserting the power source plug and pressing (ON) the backup switch for more than 5 seconds, if the voltage of pin No. ② in the following figure is output for 30 seconds at 20 seconds after turning “ON” the backup switch, the outdoor unit PCB is normal but the fan motor is defective.

If the voltage is not detected, the outdoor unit PCB is defective but the fan motor is normal.

Note (1) The voltage is output 3 times repeatedly. If it is not detected, the indoor unit displays the error message.

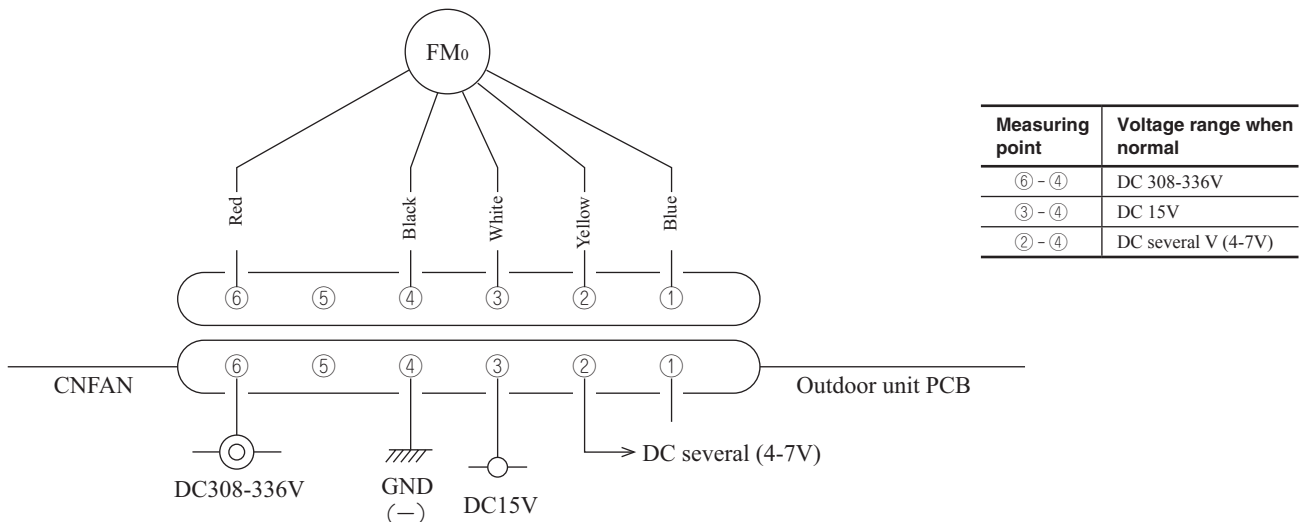

(ii) Fan motor resistance check

Measuring point	Resistance when normal
⑥ - ④ (Red - Black)	20 MΩ or higher
③ - ④ (White - Black)	20 kΩ or higher

- Notes (1) Remove the fan motor and measure it without power connected to it.
- (2) If the measured value is below the value when the motor is normal, it means that the fan motor is faulty.

INVERTER WALL MOUNTED TYPE RESIDENTIAL AIR-CONDITIONERS



MITSUBISHI HEAVY INDUSTRIES THERMAL SYSTEMS, LTD.

16-5 Konan 2-chome, Minato-ku, Tokyo, 108-8215, Japan

<http://www.mhi-mth.co.jp/en/>

Because of our policy of continuous improvement, we reserve the right to make changes in all specifications without notice.

© Copyright MITSUBISHI HEAVY INDUSTRIES THERMAL SYSTEMS, LTD.