

# 04.

 Impafri

## CÁMARA POLAR MAX

POLAR MAX COLD-ROOM

La gama POLAR MAX cámara frigorífica es el resultado de importantes esfuerzos en investigación.

Es un producto de una gran calidad, debido a las nuevas ventajas que incluye y añadiendo el modularidad de 200 en 200 mm.

*This cold-room is the result of important research efforts.*

*It is a product of great quality, due to the new advantages that it includes and adding the modularity of 200 in 200 mm.*



## Panel

Revestimiento chapa de acero galvanizado y prelacado poliéster con un film de protección, color blanco ral 9010 y calidad alimentaria.

## Panel suelo

Suelo standard cara interior en tablero fenólico antideslizante de 9 mm. Cara exterior chapa de acero galvanizado prelacado con poliéster

Tránsito* Traffic	Carga estática kg/m <sup>2</sup> Static load kg/m <sup>2</sup>	Carga dinámica kg/m <sup>2</sup> Dinamic load	Tipo de suelo Soil type
1, 2	4150*** 2490****	415** 250****	Fenólico Phenolic

## Espesor

Aislamiento 80mm [Ta +] 100mm [Ta -].

Espuma de poliuretano libre de CFC inyectado a alta presión con densidad de 45 kg/m<sup>3</sup>.

## Dimensiones interiores

Fondo y largo 120 x 120 cm a 440 x 240 cm (módulos de 20 cm)

Altura 192 cm - 212 cm - 232 cm - 252 cm - 272cm

## Dimensiones exteriores

Fondo y largo dimensiones interiores + 16 cm [e=80] + 20cm [e=100]

Altura con suelo dimensiones interiores + 16 cm [e=80] + 20cm [e=100]

Altura sin suelo dimensiones interiores + 8 cm [e=80] + 10cm [e=100]

## Puerta

Puerta pivotante estándar con luz libre 800x1830 mm, cierre con llave y sistema de apertura interior.



\* 1: Peatonal; 2: Carretilla de mano ruedas de goma. 1: Pedestrian; 2: Wheelbarrow.

\*\* Se estima un 10% de la carga estática. It is estimated that 10 per cent of the static load.

\*\*\* Uso previsto cámara: Refrigeración Intended use for refrigerations.

\*\*\*\* Uso previsto cámara: Congelación. Intended use for freezing.

## Panel

Standard coating of galvanized metal plate painted with white food-certified paint, colour ral 9010 and protective film.

## Floor panel

Standard floor inside with phenolic board outside white painted galvanized metal.

## Thickness

80Mm [t<sup>o</sup> +] 100mm [t<sup>o</sup> -]. Cfc-free polyurethane injected at high pressure to a density of 43-45 kg/m<sup>3</sup>

## Inside dimensions

Length and width 120 x 120 cm a 440 x 240 cm (modules of 20 cm)

Height 192 cm - 212 cm - 232 cm - 252 cm - 272cm

## Outside dimensions

Length and width inside dimensions + 16 cm [e=80] + 20cm [e=100]

Height with floor inside dimensions + 16 cm [e=80] + 20cm [e=100]

Height without floor inside dimensions + 8 cm [e=80] + 10cm [e=100]

## Door

Pivoting with standard dimensions for door of 800x1830 mm, interior opening system and key lock.

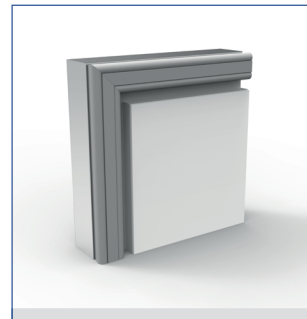

**Burlete magnético**  
Magnetic gasket

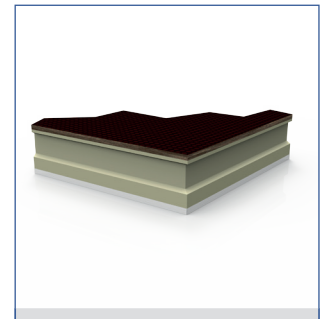

**Panel suelo fenólico**  
Floor panel phenolic

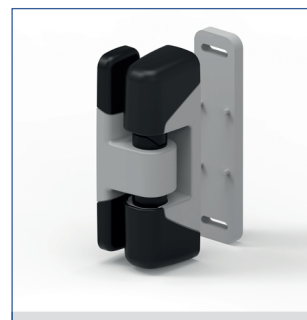

**Bisagras regulables**  
**[en las tres dimensiones].**  
Height and depth adjustable hinges



**Cierre llave Sfera.**  
Interior opening system Sfera

## Panel Machihembrado / Tongue and groove panel

# MAX

**El panel machihembrado es una de las principales diferenciaciones de la cámara Polar Max.**

**1.**  
Panel modular con perfil machihembrado que dota al conjunto de una hermeticidad absoluta dando lugar a unas juntas perfectas en su totalidad.

**2.**  
Innovador sistema de unión "clipart" el cual no incorpora piezas metálicas.

*The tongue and groove panel is one of the main differentiations of the Polar Max range.*

**1.**  
*Modular panel with tongue and groove profile that gives a perfect tightness.*

**2.**  
*Innovative union system "clip art" which does not incorporate metal parts.*



**Panel Machihembrado**

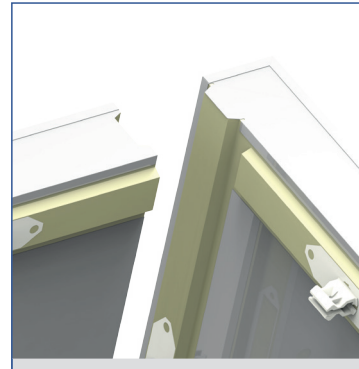

**Clipart**





### Alturas estándar de cámaras / Standard height of coldroom

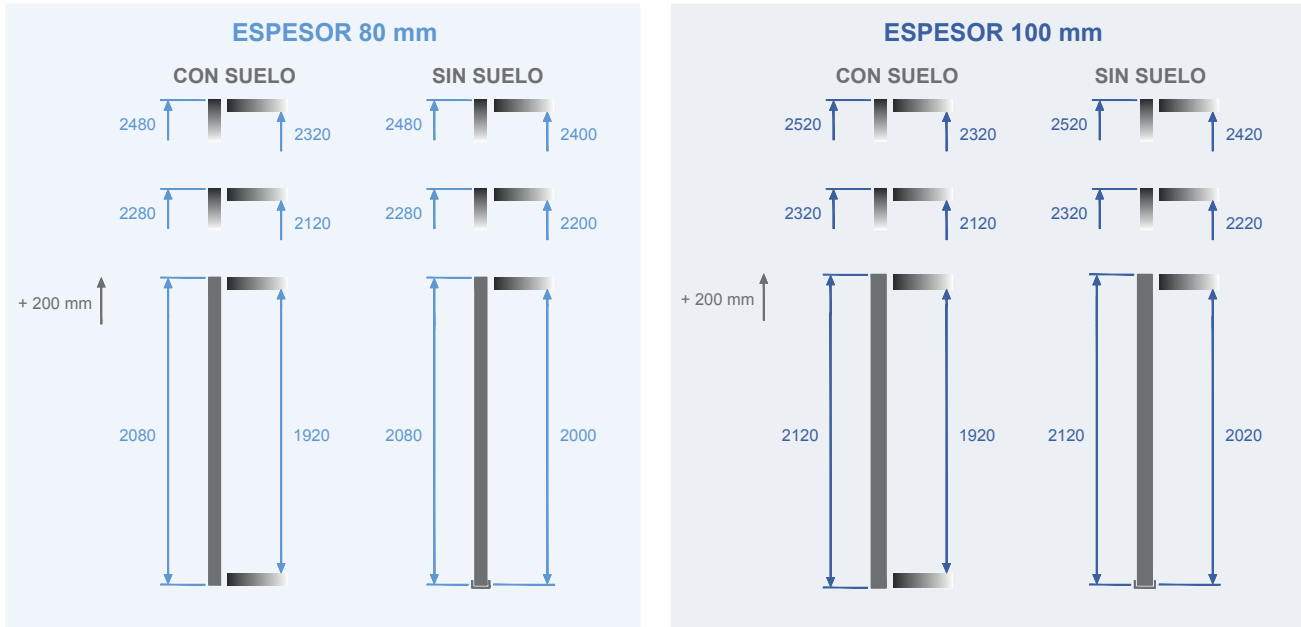

### Fondo y largo / Length and width

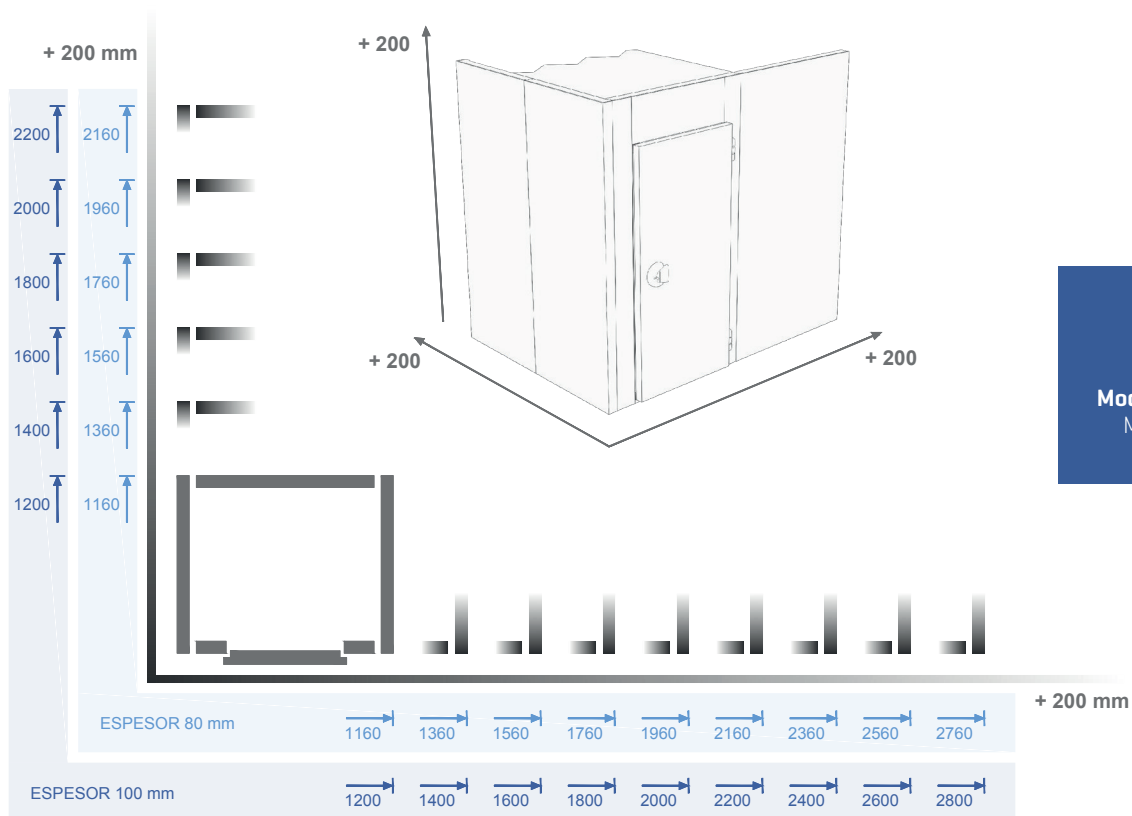

Para cualquier otra medida de fondo, largo o altura exterior de una Cámara Frigorífica Gama polar Max, multirrecinto de cámaras, rogamos consulten nuestro departamento técnico comercial.

For other measures in Polar Range modular cold-room, consult with our Technical Department.

## Información adicional y opciones / Additional Information and options

# MAX

### Diseñamos, fabricamos y comercializamos cualquier cámara frigorífica Gama Polar Max

- Fabricación totalmente a medida.
- Distintas alturas, por debajo de 2.080 mm y hasta 3.080 mm.
- Diferentes acabados del panel, tanto exterior como interior.
- Otros acabados de panel suelo: Acero inoxidable y cámara sin suelo.
- Diferentes tipos de puertas: Pivotantes de otro claro luz libre, correderas, vaivén, de paso, etc.
- Multirrecinto de cámaras de cualquier forma geométrica.
- Recubrimientos de pilar

### We design, manufacture and commercialize any cold room Polar Max Range

- Customizable dimensions
- Heights different from the standard ones, below 2080 and up to 3080mm
- Different options of panel quality, exterior and interior.
- Different finish of floor panel or cold rooms without floor.
- Doors of different sizes or type of doors like sliding doors, swinging doors, passing doors...
- Multi enclosures of any geometric shape
- Pillar covering



Bisagras Acero FH2B.

Cierre FH2C.  
(Palanca acero inox giro 90°)

### Opcionales / Options

Alarma / Alarm

Hacha bombero UNE 16599 (1,9 kg, LT 1,20 m) / Axe

Soporte hacha / axe's support

Rampa / Ramp

Kit de congelación [válvula de compensación de presiones y resistencia marco-puerta]

Freezing kit [frame heater door and compensation valve of pressure]

Cambio de puerta estándar / Change of door:

- Puerta pivotante especial [hasta 1000 mm ancho]

Special hinger door [up to 1000 mm lenght]

- Puerta corredera estándar (800x1830 mm)

Standard sliding door

- Puerta corredera especial [hasta 1000 mm de ancho]

Special sliding door [up to 1000mm]

- Incremento por cambio de herraje estándar [cierre y bisagras] a cierre FH2C y Bisagras Acero FH2B.

Price increase to change the standard door closure and hinges to the closure FH2C and steel hinges FH2B.

### OPCIONAL

Como opcional ofrecemos la cámara polar convencional. Cuyo sistema de unión permite el montaje de las cámaras en recintos con medidas muy justas sin tener que dejar espacio adicional para su montaje.

### AS AN OPTION

We offer the conventional polar camera. This connection system allows the assembly of the cameras in enclosures with very tight spaces without having to leave additional space for assembly

### EXCÉNTRICAS DE UNIÓN

Sistema de Ensamblaje a base de Cajas excéntricas de ABS dotadas de piezas excéntricas de alta resistencia de doble efecto y gancho reforzado asegurando la unión entre paneles.

### CONNECTING SYSTEM

Especially designed structure with a very high resistance made ABS plastic. Made up of prefabricated interlocked sandwich panels complete with cam-lock hooks ensuring a quick and easy assembly.



**Bisagras regulables**  
(en altura y profundidad).  
Height and depth adjustable hinges

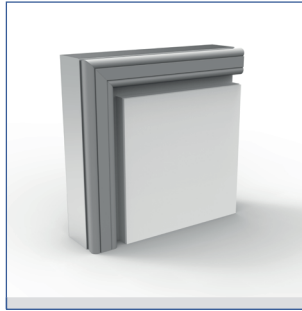

**Burlete magnético**  
Magnetic gasket

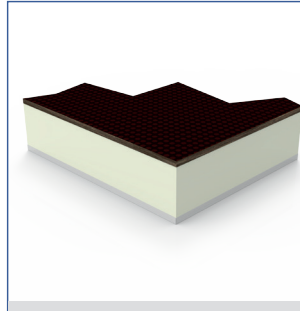

**Panel suelo fenólico**  
Floor panel phenolic



**Cierre llave Sfera.**  
Interior opening system Sfera



**Excéntrica de unión**  
Union's system



**Pieza alineación**  
Alignment piece



Tránsito* Traffic	Carga estática kg/m <sup>2</sup> Static load kg/m <sup>2</sup>	Carga dinámica kg/m <sup>2</sup> Dinamic load	Tipo de suelo Soil type
1, 2	4150*** 2490****	415** 250****	Fenólico Phenolic



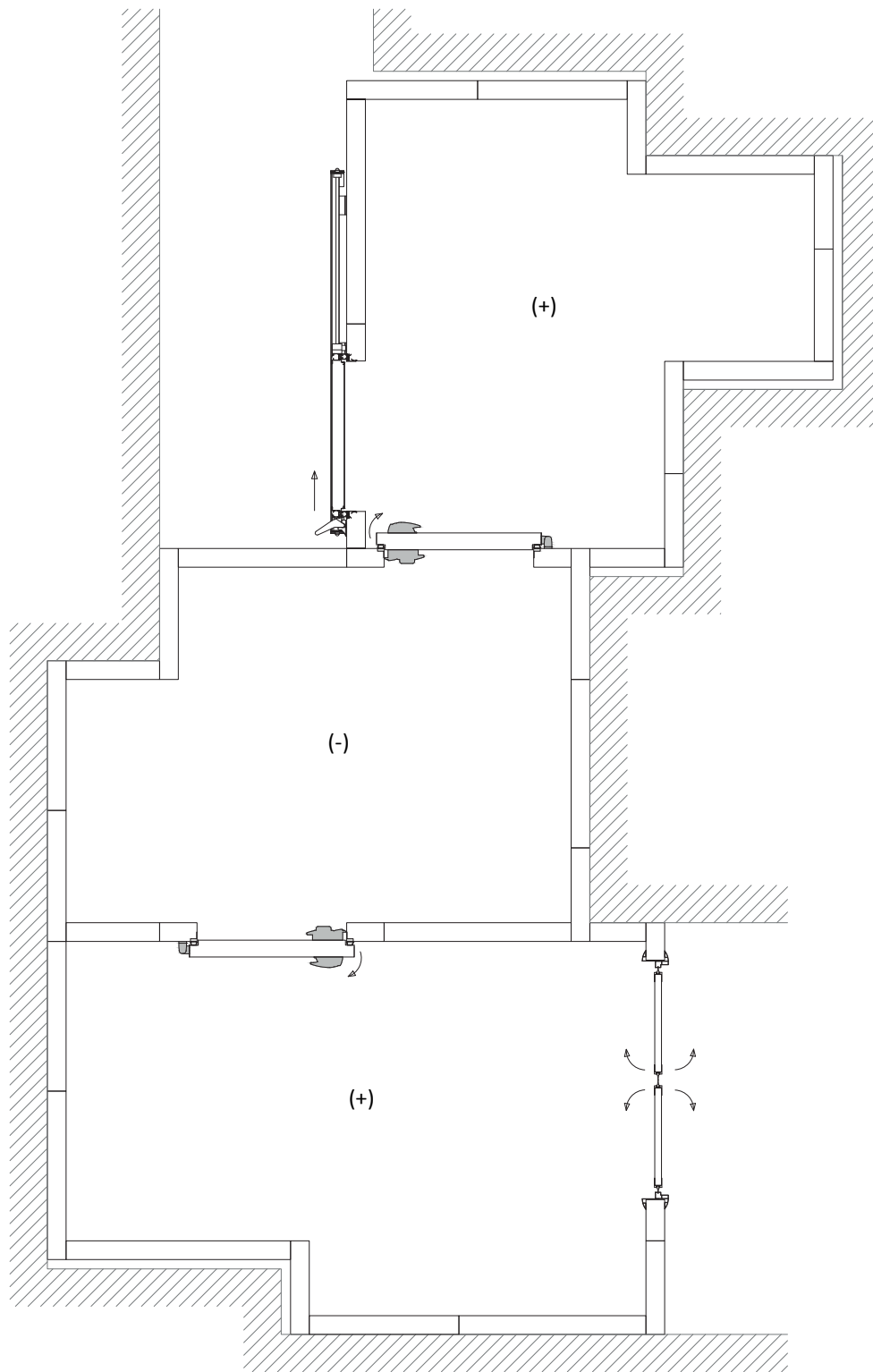

**Se realiza revestimiento de pilar sin tener que hacer ningún corte en obra, quedando todo perfectamente rematado.**

*Pilar covering will be made without a cut in the work. This way everything Will be finished off.*

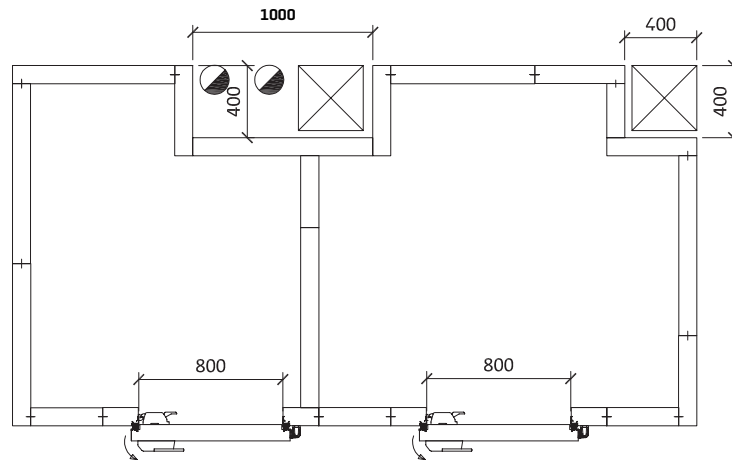

**Se realiza revestimiento de pilar sin tener que hacer ningún corte en obra, quedando todo perfectamente rematado.**  
*Pilar covering will be made without a cut in the work. This way everything will be finished off.*



Ejemplos de composición / Composition examples

**MAX**

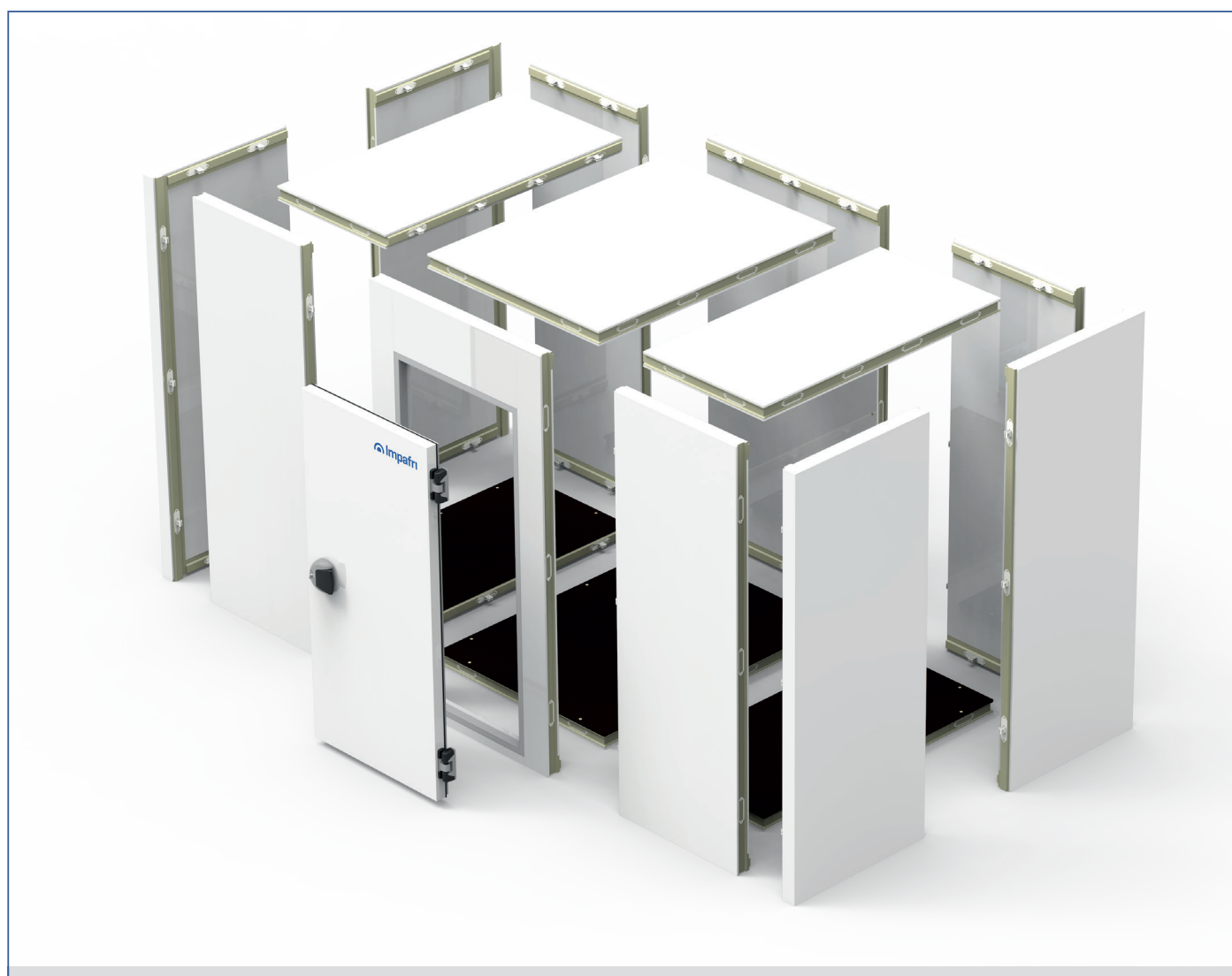
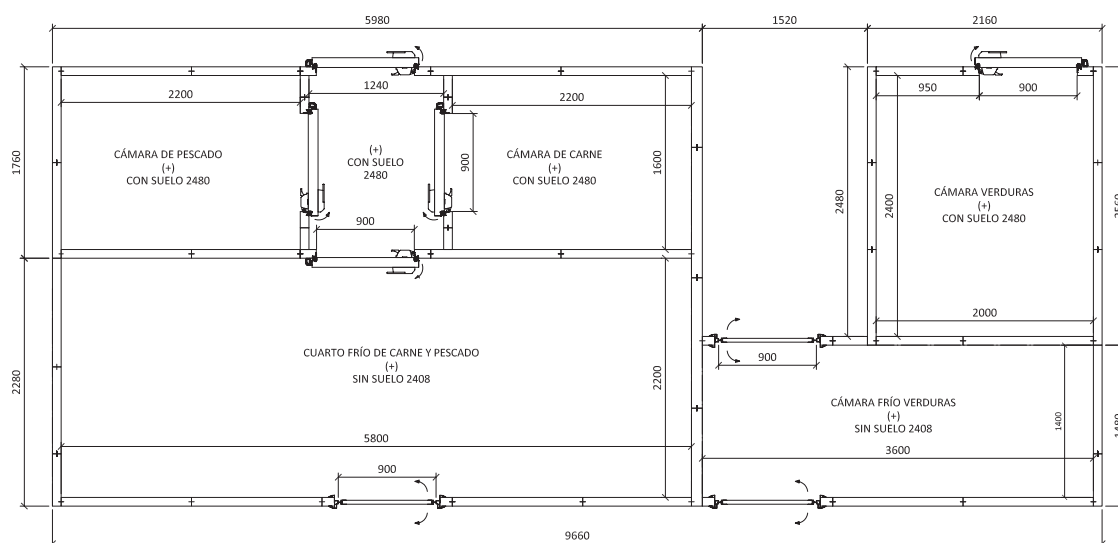

POLAR MAX

Espesor de aislamiento 80 mm / Temperature positiva [0°+6°C] / Altura exterior 2280 mm / Estanterías fondo 370 mm, 4 niveles, altura 1670 mm  
 Thickness of 80 mm insulation / Positive temperature [0°+6°C] / Outside height 2280 mm / Shelves shaped width 370 mm, 4 levels, height 1670 mm

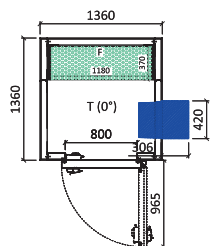

Cámara y estantería  
 Equip. MCV-NY-0015

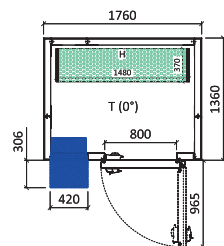

Cámara y estantería  
 Equip. MCV-NY-0015

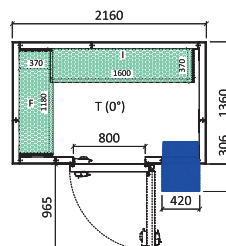

Cámara y estantería  
 Equip. MCV-NY-1015

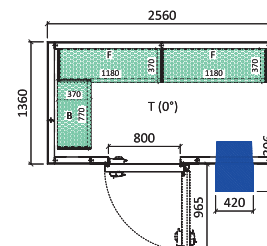

Cámara y estantería  
 Equip. MCV-NY-1015

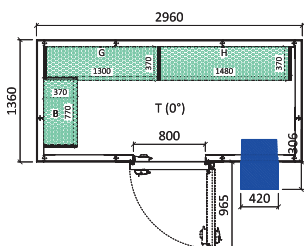

Cámara y estantería  
 Equip. MCV-NY-1026

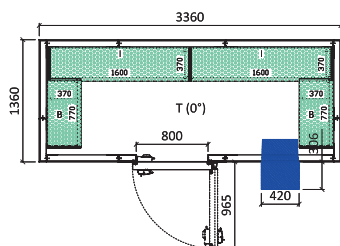

Cámara y estantería  
 Equip. MCV-NY-1026

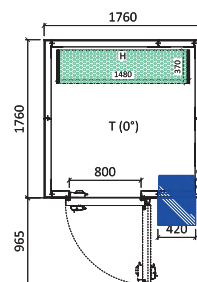

Cámara y estantería  
 Equip. MCV-NY-0015

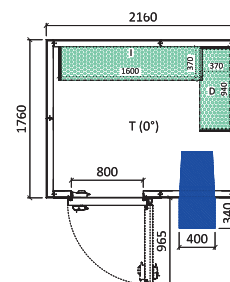

Cámara y estantería  
 Equip. MCV-NY-1026

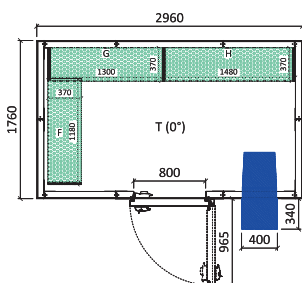

Cámara y estantería  
 Equip. MCV-NY-1026

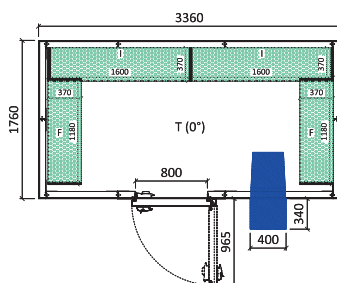

Cámara y estantería  
 Equip. MCV-NY-1033

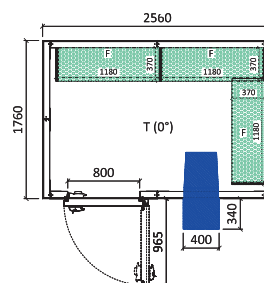

Cámara y estantería  
 Equip. MCV-NY-1026



## Ejemplos de packs / packs examples

**MAX**

**Espesor de aislamiento 80 mm / Temperature positiva [0°+6°C] / Altura exterior 2280 mm / Estanterías fondo 370 mm, 4 niveles, altura 1670 mm**  
 Thickness of 80 mm insulation / Positive temperature [0°+6°C] / Outside height 2280 mm / Shelves shaped width 370 mm, 4 levels, height 1670 mm

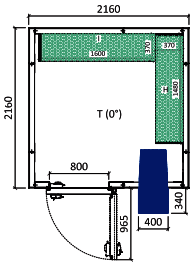

Cámara y estantería  
Equip. MCV-NY-1026

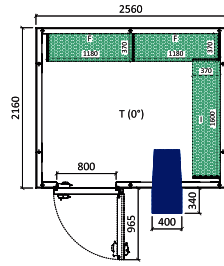

Cámara y estantería  
Equip. MCV-NY-1033

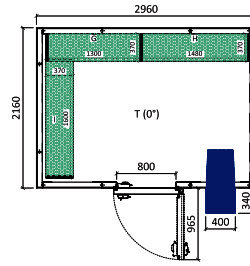

Cámara y estantería  
Equip. MCV-NY-1033

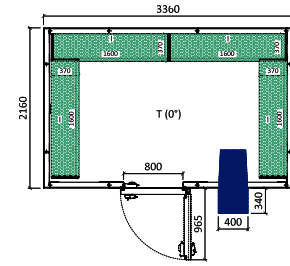

Cámara y estantería  
Equip. MCV-NY-2033

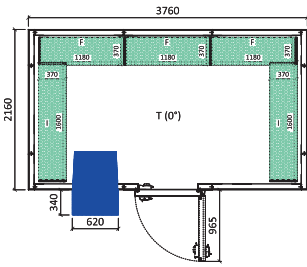

Cámara y estantería  
Equip. MCV-NY-2033

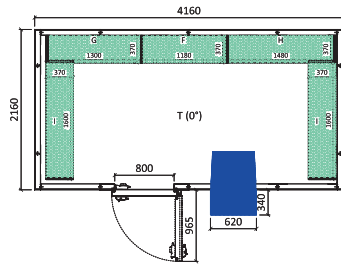

Cámara y estantería  
Equip. MCV-NY-2053

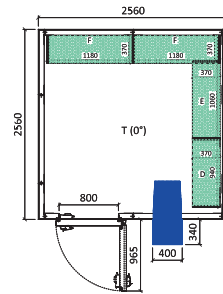

Cámara y estantería  
Equip. MCV-NY-1033

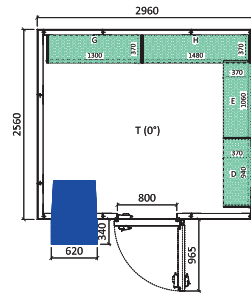

Cámara y estantería  
Equip. MCV-NY-2033

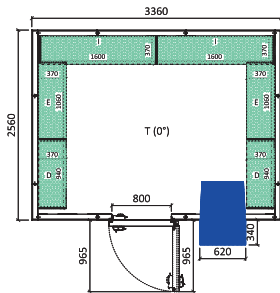

Cámara y estantería  
Equip. MCV-NY-2033

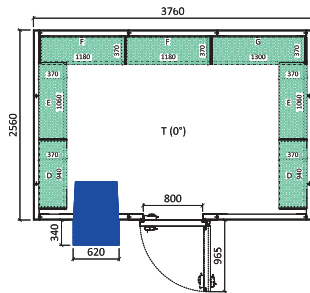

Cámara y estantería  
Equip. MCV-NY-2053

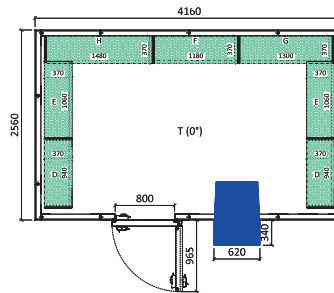

Cámara y estantería  
Equip. MCV-NY-2053



**Espesor de aislamiento 100 mm / Temperature negativa [-18-22°C] / Altura exterior 2320 mm / Estanterías fondo 370 mm, 4 niveles, altura 1670 mm**  
 Thickness of 100 mm insulation / Negative temperature [-18-22°C] / Outside height 2320 mm / Shelves shaped width 370 mm, 4 levels, height 1670 mm

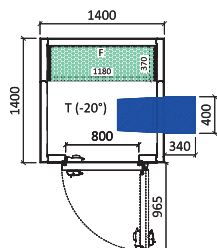

Cámara y estantería  
Equip. BCV-NG-1026

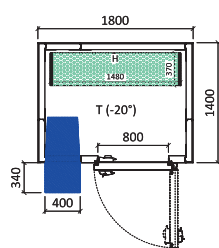

Cámara y estantería  
Equip. BCV-NG-1034

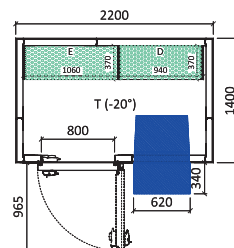

Cámara y estantería  
Equip. BCV-NG-2034

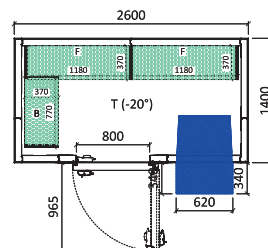

Cámara y estantería  
Equip. BCV-NG-2034

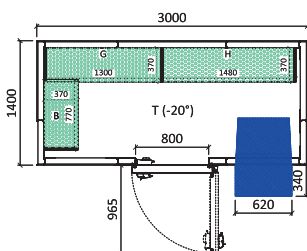

Cámara y estantería  
Equip. BCV-NG-2054

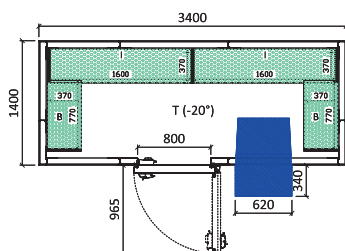

Cámara y estantería  
Equip. BCV-NG-2054

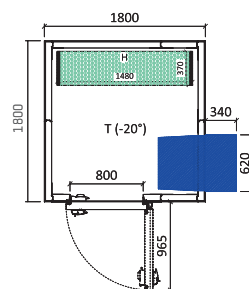

Cámara y estantería  
Equip. BCV-NG-2034

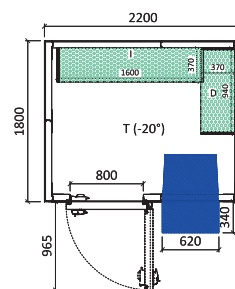

Cámara y estantería  
Equip. BCV-NG-2034

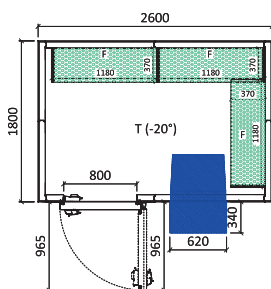

Cámara y estantería  
Equip. BCV-NG-2054

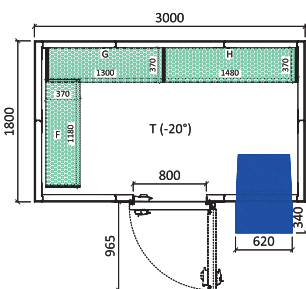

Cámara y estantería  
Equip. BCV-NG-3074

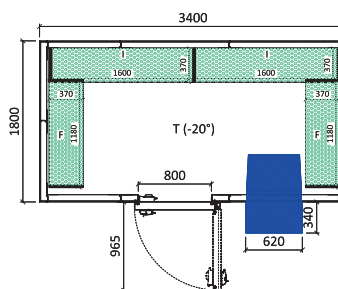

Cámara y estantería  
Equip. BCV-NG-3074

## Ejemplos de packs / packs examples

**MAX**

**Espesor de aislamiento 100 mm / Temperature negativa [-18-22°C] / Altura exterior 2320 mm / Estanterías fondo 370 mm, 4 niveles, altura 1670 mm**  
 Thickness of 100 mm insulation / Negative temperature [-18-22°C] / Outside height 2320 mm / Shelves shaped width 370 mm, 4 levels, height 1670 mm

 **Congelación**  
Freezing

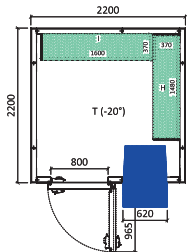

Cámara y estantería  
Equip. BCV-NG-2054

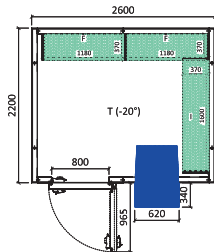

Cámara y estantería  
Equip. BCV-NG-2054

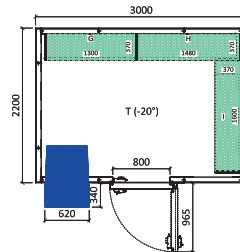

Cámara y estantería  
Equip. BCV-NG-2074

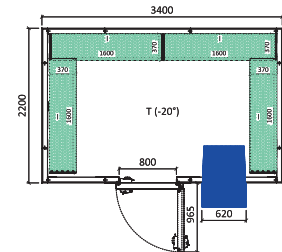

Cámara y estantería  
Equip. BCV-NG-2074

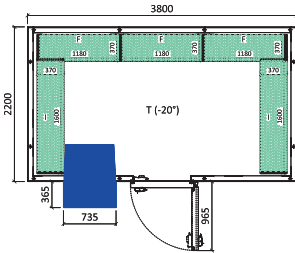

Cámara y estantería  
Equip. BCV-NG-3074

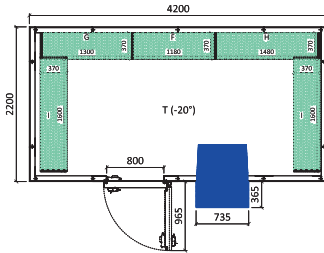

Cámara y estantería  
Equip. BCV-NG-3074

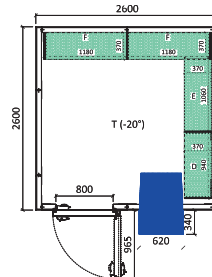

Cámara y estantería  
Equip. BCV-NG-2074

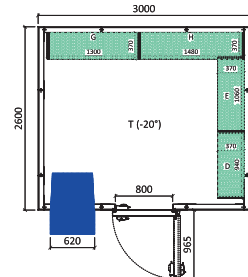

Cámara y estantería  
Equip. BCV-NG-2074

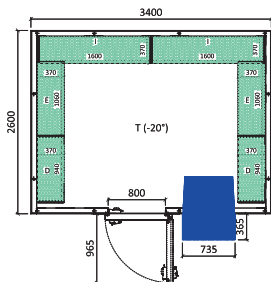

Cámara y estantería  
Equip. BCV-NG -3074

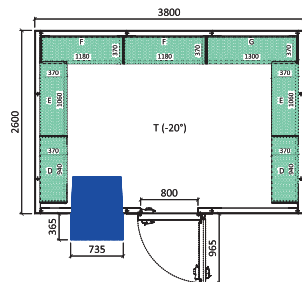

Cámara y estantería  
Equip. BCV-NG -3074

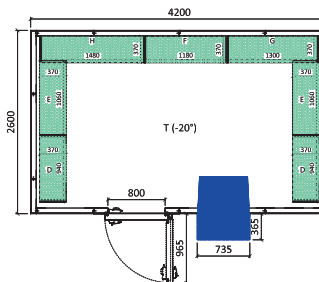

Cámara y estantería  
Equip. BCV-NG -3086

**Espesor del panel 80 mm**

Thickness of 80 mm

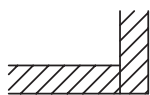
**Con suelo / With floor**

Fondo ext.	Largo ext.	H ext. 2080 mm / H int. 1920 mm			H ext. 2280 mm / H int. 2120 mm			H ext. 2480 mm / H int. 2320 mm		
		Código	Volumen int.	PVP	Código	Volumen int.	PVP	Código	Volumen int.	PVP
1160	1160	PME2081111	1,9		PME2281111	2,1		PME2481111	2,3	
1160	1360	PME2081113	2,3		PME2281113	2,5		PME2481113	2,8	
1160	1560	PME2081115	2,7		PME2281115	3,0		PME2481115	3,2	
1160	1760	PME2081117	3,1		PME2281117	3,4		PME2481117	3,7	
1160	1960	PME2081119	3,5		PME2281119	3,8		PME2481119	4,2	
1160	2160	PME2081121	3,8		PME2281121	4,2		PME2481121	4,6	
1160	2360	PME2081123	4,2		PME2281123	4,7		PME2481123	5,1	
1160	2560	PME2081125	4,6		PME2281125	5,1		PME2481125	5,6	
1160	2760	PME2081127	5,0		PME2281127	5,5		PME2481127	6,0	
1160	2960	PME2081129	5,4		PME2281129	5,9		PME2481129	6,5	
1160	3160	PME2081131	5,8		PME2281131	6,4		PME2481131	7,0	
1360	1360	PME2081313	2,8		PME2281313	3,1		PME2481313	3,3	
1360	1560	PME2081315	3,2		PME2281315	3,6		PME2481315	3,9	
1360	1760	PME2081317	3,7		PME2281317	4,1		PME2481317	4,5	
1360	1960	PME2081319	4,1		PME2281319	4,6		PME2481319	5,0	
1360	2160	PME2081321	4,6		PME2281321	5,1		PME2481321	5,6	
1360	2360	PME2081323	5,1		PME2281323	5,6		PME2481323	6,1	
1360	2560	PME2081325	5,5		PME2281325	6,1		PME2481325	6,7	
1360	2760	PME2081327	6,0		PME2281327	6,6		PME2481327	7,2	
1360	2960	PME2081329	6,5		PME2281329	7,1		PME2481329	7,8	
1360	3160	PME2081331	6,9		PME2281331	7,6		PME2481331	8,4	
1360	3360	PME2081333	7,4		PME2281333	8,1		PME2481333	8,9	
1560	1560	PME2081515	3,8		PME2281515	4,2		PME2481515	4,5	
1560	1760	PME2081517	4,3		PME2281517	4,7		PME2481517	5,2	
1560	1960	PME2081519	4,8		PME2281519	5,3		PME2481519	5,8	
1560	2160	PME2081521	5,4		PME2281521	5,9		PME2481521	6,5	
1560	2360	PME2081523	5,9		PME2281523	6,5		PME2481523	7,1	
1560	2560	PME2081525	6,5		PME2281525	7,1		PME2481525	7,8	
1560	2760	PME2081527	7,0		PME2281527	7,7		PME2481527	8,4	
1560	2960	PME2081529	7,5		PME2281529	8,3		PME2481529	9,1	
1560	3160	PME2081531	8,1		PME2281531	8,9		PME2481531	9,7	
1560	3360	PME2081533	8,6		PME2281533	9,5		PME2481533	10,4	
1560	3560	PME2081535	9,1		PME2281535	10,1		PME2481535	11,0	

## Listado de precios / Price list

# MAX

### Espesor del panel 80 mm

Thickness of 80 mm

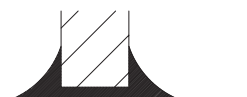

Sin suelo / Without floor



Fondo ext.	Largo ext.	H ext. 2080 mm / H int. 2000 mm			H ext. 2280 mm / H int. 2200 mm			H ext. 2480mm / H int. 2400 mm		
		Código	Volumen int.	PVP	Código	Volumen int.	PVP	Código	Volumen int.	PVP
1160	1160	PME2001111	1,9		PME2201111	2,1		PME2401111	2,3	
1160	1360	PME2001113	2,3		PME2201113	2,5		PME2401113	2,8	
1160	1560	PME2001115	2,7		PME2201115	3,0		PME2401115	3,2	
1160	1760	PME2001117	3,1		PME2201117	3,4		PME2401117	3,7	
1160	1960	PME2001119	3,5		PME2201119	3,8		PME2401119	4,2	
1160	2160	PME2001121	3,8		PME2201121	4,2		PME2401121	4,6	
1160	2360	PME2001123	4,2		PME2201123	4,7		PME2401123	5,1	
1160	2560	PME2001125	4,6		PME2201125	5,1		PME2401125	5,6	
1160	2760	PME2001127	5,0		PME2201127	5,5		PME2401127	6,0	
1160	2960	PME2001129	5,4		PME2201129	5,9		PME2401129	6,5	
1160	3160	PME2001131	5,8		PME2201131	6,4		PME2401131	7,0	
1360	1360	PME2001313	2,8		PME2201313	3,1		PME2401313	3,3	
1360	1560	PME2001315	3,2		PME2201315	3,6		PME2401315	3,9	
1360	1760	PME2001317	3,7		PME2201317	4,1		PME2401317	4,5	
1360	1960	PME2001319	4,1		PME2201319	4,6		PME2401319	5,0	
1360	2160	PME2001321	4,6		PME2201321	5,1		PME2401321	5,6	
1360	2360	PME2001323	5,1		PME2201323	5,6		PME2401323	6,1	
1360	2560	PME2001325	5,5		PME2201325	6,1		PME2401325	6,7	
1360	2760	PME2001327	6,0		PME2201327	6,6		PME2401327	7,2	
1360	2960	PME2001329	6,5		PME2201329	7,1		PME2401329	7,8	
1360	3160	PME2001331	6,9		PME2201331	7,6		PME2401331	8,4	
1360	3360	PME2001333	7,4		PME2201333	8,1		PME2401333	8,9	
1560	1560	PME2001515	3,8		PME2201515	4,2		PME2401515	4,5	
1560	1760	PME2001517	4,3		PME2201517	4,7		PME2401517	5,2	
1560	1960	PME2001519	4,8		PME2201519	5,3		PME2401519	5,8	
1560	2160	PME2001521	5,4		PME2201521	5,9		PME2401521	6,5	
1560	2360	PME2001523	5,9		PME2201523	6,5		PME2401523	7,1	
1560	2560	PME2001525	6,5		PME2201525	7,1		PME2401525	7,8	
1560	2760	PME2001527	7,0		PME2201527	7,7		PME2401527	8,4	
1560	2960	PME2001529	7,5		PME2201529	8,3		PME2401529	9,1	
1560	3160	PME2001531	8,1		PME2201531	8,9		PME2401531	9,7	
1560	3360	PME2001533	8,6		PME2201533	9,5		PME2401533	10,4	
1560	3560	PME2001535	9,1		PME2201535	10,1		PME2401535	11,0	

## Espesor del panel 80 mm

Thickness of 80 mm

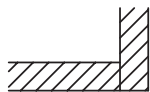

Con suelo / With floor



Fondo ext.	Largo ext.	H ext. 2080 mm / H int. 1920 mm			H ext. 2280 mm / H int. 2120 mm			H ext. 2480 mm / H int. 2320 mm		
		Código	Volumen int.	PVP	Código	Volumen int.	PVP	Código	Volumen int.	PVP
1760	1760	PME2081717	4,9		PME2281717	5,4		PME2481717	5,9	
1760	1960	PME2081719	5,5		PME2281719	6,1		PME2481719	6,7	
1760	2160	PME2081721	6,1		PME2281721	6,8		PME2481721	7,4	
1760	2360	PME2081723	6,8		PME2281723	7,5		PME2481723	8,2	
1760	2560	PME2081725	7,4		PME2281725	8,1		PME2481725	8,9	
1760	2760	PME2081727	8,0		PME2281727	8,8		PME2481727	9,7	
1760	2960	PME2081729	8,6		PME2281729	9,5		PME2481729	10,4	
1760	3160	PME2081731	9,2		PME2281731	10,2		PME2481731	11,1	
1760	3360	PME2081733	9,8		PME2281733	10,9		PME2481733	11,9	
1760	3560	PME2081735	10,4		PME2281735	11,5		PME2481735	12,6	
1760	3760	PME2081737	11,1		PME2281737	12,2		PME2481737	13,4	
1960	1960	PME2081919	6,2		PME2281919	6,9		PME2481919	7,5	
1960	2160	PME2081921	6,9		PME2281921	7,6		PME2481921	8,4	
1960	2360	PME2081923	7,6		PME2281923	8,4		PME2481923	9,2	
1960	2560	PME2081925	8,3		PME2281925	9,2		PME2481925	10,0	
1960	2760	PME2081927	9,0		PME2281927	9,9		PME2481927	10,9	
1960	2960	PME2081929	9,7		PME2281929	10,7		PME2481929	11,7	
1960	3160	PME2081931	10,4		PME2281931	11,4		PME2481931	12,5	
1960	3360	PME2081933	11,1		PME2281933	12,2		PME2481933	13,4	
1960	3560	PME2081935	11,8		PME2281935	13,0		PME2481935	14,2	
1960	3760	PME2081937	12,4		PME2281937	13,7		PME2481937	15,0	
1960	3960	PME2081939	13,1		PME2281939	14,5		PME2481939	15,9	
2160	2160	PME2082121	7,7		PME2282121	8,5		PME2482121	9,3	
2160	2360	PME2082123	8,4		PME2282123	9,3		PME2482123	10,2	
2160	2560	PME2082125	9,2		PME2282125	10,2		PME2482125	11,1	
2160	2760	PME2082127	10,0		PME2282127	11,0		PME2482127	12,1	
2160	2960	PME2082129	10,8		PME2282129	11,9		PME2482129	13,0	
2160	3160	PME2082131	11,5		PME2282131	12,7		PME2482131	13,9	
2160	3360	PME2082133	12,3		PME2282133	13,6		PME2482133	14,8	
2160	3560	PME2082135	13,1		PME2282135	14,4		PME2482135	15,8	
2160	3760	PME2082137	13,8		PME2282137	15,3		PME2482137	16,7	
2160	3960	PME2082139	14,6		PME2282139	16,1		PME2482139	17,6	
2160	4160	PME2082141	15,4		PME2282141	17,0		PME2482141	18,6	
2360	2360	PME2082323	9,3		PME2282323	10,3		PME2482323	11,2	
2360	2560	PME2082325	10,1		PME2282325	11,2		PME2482325	12,2	
2360	2760	PME2082327	11,0		PME2282327	12,1		PME2482327	13,3	
2360	2960	PME2082329	11,8		PME2282329	13,1		PME2482329	14,3	
2360	3160	PME2082331	12,7		PME2282331	14,0		PME2482331	15,3	
2360	3360	PME2082333	13,5		PME2282333	14,9		PME2482333	16,3	
2360	3560	PME2082335	14,4		PME2282335	15,9		PME2482335	17,4	
2360	3760	PME2082337	15,2		PME2282337	16,8		PME2482337	18,4	
2360	3960	PME2082339	16,1		PME2282339	17,7		PME2482339	19,4	
2360	4160	PME2082341	16,9		PME2282341	18,7		PME2482341	20,4	
2360	4360	PME2082343	17,7		PME2282343	19,6		PME2482343	21,4	

## Listado de precios / Price list

# MAX

### Espesor del panel 80 mm

Thickness of 80 mm

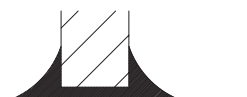

Sin suelo / Without floor



Fondo ext.	Largo ext.	H ext. 2080 mm / H int. 2000 mm			H ext. 2280 mm / H int. 2200 mm			H ext. 2480mm / H int. 2400 mm		
		Código	Volumen int.	PVP	Código	Volumen int.	PVP	Código	Volumen int.	PVP
1760	1760	PME2001717	4,9		PME2201717	5,4		PME2401717	5,9	
1760	1960	PME2001719	5,5		PME2201719	6,1		PME2401719	6,7	
1760	2160	PME2001721	6,1		PME2201721	6,8		PME2401721	7,4	
1760	2360	PME2001723	6,8		PME2201723	7,5		PME2401723	8,2	
1760	2560	PME2001725	7,4		PME2201725	8,1		PME2401725	8,9	
1760	2760	PME2001727	8,0		PME2201727	8,8		PME2401727	9,7	
1760	2960	PME2001729	8,6		PME2201729	9,5		PME2401729	10,4	
1760	3160	PME2001731	9,2		PME2201731	10,2		PME2401731	11,1	
1760	3360	PME2001733	9,8		PME2201733	10,9		PME2401733	11,9	
1760	3560	PME2001735	10,4		PME2201735	11,5		PME2401735	12,6	
1760	3760	PME2001737	11,1		PME2201737	12,2		PME2401737	13,4	
1960	1960	PME2001919	6,2		PME2201919	6,9		PME2401919	7,5	
1960	2160	PME2001921	6,9		PME2201921	7,6		PME2401921	8,4	
1960	2360	PME2001923	7,6		PME2201923	8,4		PME2401923	9,2	
1960	2560	PME2001925	8,3		PME2201925	9,2		PME2401925	10,0	
1960	2760	PME2001927	9,0		PME2201927	9,9		PME2401927	10,9	
1960	2960	PME2001929	9,7		PME2201929	10,7		PME2401929	11,7	
1960	3160	PME2001931	10,4		PME2201931	11,4		PME2401931	12,5	
1960	3360	PME2001933	11,1		PME2201933	12,2		PME2401933	13,4	
1960	3560	PME2001935	11,8		PME2201935	13,0		PME2401935	14,2	
1960	3760	PME2001937	12,4		PME2201937	13,7		PME2401937	15,0	
1960	3960	PME2001939	13,1		PME2201939	14,5		PME2401939	15,9	
2160	2160	PME2002121	7,7		PME2202121	8,5		PME2402121	9,3	
2160	2360	PME2002123	8,4		PME2202123	9,3		PME2402123	10,2	
2160	2560	PME2002125	9,2		PME2202125	10,2		PME2402125	11,1	
2160	2760	PME2002127	10,0		PME2202127	11,0		PME2402127	12,1	
2160	2960	PME2002129	10,8		PME2202129	11,9		PME2402129	13,0	
2160	3160	PME2002131	11,5		PME2202131	12,7		PME2402131	13,9	
2160	3360	PME2002133	12,3		PME2202133	13,6		PME2402133	14,8	
2160	3560	PME2002135	13,1		PME2202135	14,4		PME2402135	15,8	
2160	3760	PME2002137	13,8		PME2202137	15,3		PME2402137	16,7	
2160	3960	PME2002139	14,6		PME2202139	16,1		PME2402139	17,6	
2160	4160	PME2002141	15,4		PME2202141	17,0		PME2402141	18,6	
2360	2360	PME2002323	9,3		PME2202323	10,3		PME2402323	11,2	
2360	2560	PME2002325	10,1		PME2202325	11,2		PME2402325	12,2	
2360	2760	PME2002327	11,0		PME2202327	12,1		PME2402327	13,3	
2360	2960	PME2002329	11,8		PME2202329	13,1		PME2402329	14,3	
2360	3160	PME2002331	12,7		PME2202331	14,0		PME2402331	15,3	
2360	3360	PME2002333	13,5		PME2202333	14,9		PME2402333	16,3	
2360	3560	PME2002335	14,4		PME2202335	15,9		PME2402335	17,4	
2360	3760	PME2002337	15,2		PME2202337	16,8		PME2402337	18,4	
2360	3960	PME2002339	16,1		PME2202339	17,7		PME2402339	19,4	
2360	4160	PME2002341	16,9		PME2202341	18,7		PME2402341	20,4	

**Espesor del panel 80 mm**

Thickness of 80 mm

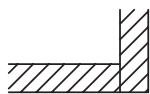
**Con suelo / With floor**Refrigeración  
Refrigeration

Fondo ext.	Largo ext.	H ext. 2080 mm / H int. 1920 mm			H ext. 2280 mm / H int. 2120 mm			H ext. 2480 mm / H int. 2320 mm		
		Código	Volumen int.	PVP	Código	Volumen int.	PVP	Código	Volumen int.	PVP
2560	2560	PME2082525	11,1		PME2282525	12,2		PME2482525	13,4	
2560	2760	PME2082527	12,0		PME2282527	13,2		PME2482527	14,5	
2560	2960	PME2082529	12,9		PME2282529	14,2		PME2482529	15,6	
2560	3160	PME2082531	13,8		PME2282531	15,3		PME2482531	16,7	
2560	3360	PME2082533	14,7		PME2282533	16,3		PME2482533	17,8	
2560	3560	PME2082535	15,7		PME2282535	17,3		PME2482535	18,9	
2560	3760	PME2082537	16,6		PME2282537	18,3		PME2482537	20,0	
2560	3960	PME2082539	17,5		PME2282539	19,3		PME2482539	21,2	
2560	4160	PME2082541	18,4		PME2282541	20,4		PME2482541	22,3	
2560	4360	PME2082543	19,4		PME2282543	21,4		PME2482543	23,4	
2560	4560	PME2082545	20,3		PME2282545	22,4		PME2482545	24,5	
2760	2760	PME2082727	13,0		PME2282727	14,3		PME2482727	15,7	
2760	2960	PME2082729	14,0		PME2282729	15,4		PME2482729	16,9	
2760	3160	PME2082731	15,0		PME2282731	16,5		PME2482731	18,1	
2760	3360	PME2082733	16,0		PME2282733	17,6		PME2482733	19,3	
2760	3560	PME2082735	17,0		PME2282735	18,7		PME2482735	20,5	
2760	3760	PME2082737	18,0		PME2282737	19,8		PME2482737	21,7	
2760	3960	PME2082739	19,0		PME2282739	20,9		PME2482739	22,9	
2760	4160	PME2082741	20,0		PME2282741	22,0		PME2482741	24,1	
2760	4360	PME2082743	21,0		PME2282743	23,2		PME2482743	25,3	
2760	4560	PME2082745	22,0		PME2282745	24,3		PME2482745	26,5	
2760	4760	PME2082747	23,0		PME2282747	25,4		PME2482747	27,7	
2960	2960	PME2082929	15,1		PME2282929	16,6		PME2482929	18,2	
2960	3160	PME2082931	16,1		PME2282931	17,8		PME2482931	19,5	
2960	3360	PME2082933	17,2		PME2282933	19,0		PME2482933	20,8	
2960	3560	PME2082935	18,3		PME2282935	20,2		PME2482935	22,1	
2960	3760	PME2082937	19,4		PME2282937	21,4		PME2482937	23,4	
2960	3960	PME2082939	20,4		PME2282939	22,6		PME2482939	24,7	
2960	4160	PME2082941	21,5		PME2282941	23,7		PME2482941	26,0	
2960	4360	PME2082943	22,6		PME2282943	24,9		PME2482943	27,3	
2960	4560	PME2082945	23,7		PME2282945	26,1		PME2482945	28,6	
2960	4760	PME2082947	24,7		PME2282947	27,3		PME2482947	29,9	
2960	4960	PME2082949	25,8		PME2282949	28,5		PME2482949	31,2	

## Listado de precios / Price list

# MAX

### Espesor del panel 80 mm

Thickness of 80 mm

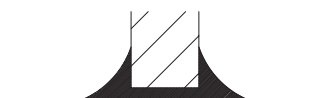

Sin suelo / Without floor



Fondo ext.	Largo ext.	H ext. 2080 mm / H int. 2000 mm			H ext. 2280 mm / H int. 2200 mm			H ext. 2480mm / H int. 2400 mm		
		Código	Volumen int.	PVP	Código	Volumen int.	PVP	Código	Volumen int.	PVP
2560	2560	PME2002525	11,1		PME2202525	12,2		PME2402525	13,4	
2560	2760	PME2002527	12,0		PME2202527	13,2		PME2402527	14,5	
2560	2960	PME2002529	12,9		PME2202529	14,2		PME2402529	15,6	
2560	3160	PME2002531	13,8		PME2202531	15,3		PME2402531	16,7	
2560	3360	PME2002533	14,7		PME2202533	16,3		PME2402533	17,8	
2560	3560	PME2002535	15,7		PME2202535	17,3		PME2402535	18,9	
2560	3760	PME2002537	16,6		PME2202537	18,3		PME2402537	20,0	
2560	3960	PME2002539	17,5		PME2202539	19,3		PME2402539	21,2	
2560	4160	PME2002541	18,4		PME2202541	20,4		PME2402541	22,3	
2560	4360	PME2002543	19,4		PME2202543	21,4		PME2402543	23,4	
2560	4560	PME2002545	20,3		PME2202545	22,4		PME2402545	24,5	
2760	2760	PME2002727	13,0		PME2202727	14,3		PME2402727	15,7	
2760	2960	PME2002729	14,0		PME2202729	15,4		PME2402729	16,9	
2760	3160	PME2002731	15,0		PME2202731	16,5		PME2402731	18,1	
2760	3360	PME2002733	16,0		PME2202733	17,6		PME2402733	19,3	
2760	3560	PME2002735	17,0		PME2202735	18,7		PME2402735	20,5	
2760	3760	PME2002737	18,0		PME2202737	19,8		PME2402737	21,7	
2760	3960	PME2002739	19,0		PME2202739	20,9		PME2402739	22,9	
2760	4160	PME2002741	20,0		PME2202741	22,0		PME2402741	24,1	
2760	4360	PME2002743	21,0		PME2202743	23,2		PME2402743	25,3	
2760	4560	PME2002745	22,0		PME2202745	24,3		PME2402745	26,5	
2760	4760	PME2002747	23,0		PME2202747	25,4		PME2402747	27,7	
2960	2960	PME2002929	15,1		PME2202929	16,6		PME2402929	18,2	
2960	3160	PME2002931	16,1		PME2202931	17,8		PME2402931	19,5	
2960	3360	PME2002933	17,2		PME2202933	19,0		PME2402933	20,8	
2960	3560	PME2002935	18,3		PME2202935	20,2		PME2402935	22,1	
2960	3760	PME2002937	19,4		PME2202937	21,4		PME2402937	23,4	
2960	3960	PME2002939	20,4		PME2202939	22,6		PME2402939	24,7	
2960	4160	PME2002941	21,5		PME2202941	23,7		PME2402941	26,0	
2960	4360	PME2002943	22,6		PME2202943	24,9		PME2402943	27,3	
2960	4560	PME2002945	23,7		PME2202945	26,1		PME2402945	28,6	
2960	4760	PME2002947	24,7		PME2202947	27,3		PME2402947	29,9	
2960	4960	PME2002949	25,8		PME2202949	28,5		PME2402949	31,2	



**Espesor del panel 100 mm**

Thickness of 100 mm

**Con suelo / With floor**

**De serie: Resistencia eléctrica en el marco-puerta y válvula de compensación de presiones para todas las cámaras de congelación (espesor de panel e= 100 mm).**

*As standard: Door heater and pressure compensation valve included for negative temperatures (panel thickness of 100 mm). For other dimensions and options, contact our sales department.*



Fondo ext.	Largo ext.	H ext. 2120 mm / H int. 1920 mm			H ext. 2320 mm / H int. 2120 mm			H ext. 2520 mm / H int. 2320 mm		
		Código	Volumen int.	PVP	Código	Volumen int.	PVP	Código	Volumen int.	PVP
1200	1200	PMG2021212	1,9		PMG2321212	2,1		PMG2521212	2,3	
1200	1400	PMG2021214	2,3		PMG2321214	2,5		PMG2521214	2,8	
1200	1600	PMG2021216	2,7		PMG2321216	3,0		PMG2521216	3,2	
1200	1800	PMG2021218	3,1		PMG2321218	3,4		PMG2521218	3,7	
1200	2000	PMG2021220	3,5		PMG2321220	3,8		PMG2521220	4,2	
1200	2200	PMG2021222	3,8		PMG2321222	4,2		PMG2521222	4,6	
1200	2400	PMG2021224	4,2		PMG2321224	4,7		PMG2521224	5,1	
1200	2600	PMG2021226	4,6		PMG2321226	5,1		PMG2521226	5,6	
1200	2800	PMG2021228	5,0		PMG2321228	5,5		PMG2521228	6,0	
1200	3000	PMG2021230	5,4		PMG2321230	5,9		PMG2521230	6,5	
1200	3200	PMG2021232	5,8		PMG2321232	6,4		PMG2521232	7,0	
1400	1400	PMG2021414	2,8		PMG2321414	3,1		PMG2521414	3,3	
1400	1600	PMG2021416	3,2		PMG2321416	3,6		PMG2521416	3,9	
1400	1800	PMG2021418	3,7		PMG2321418	4,1		PMG2521418	4,5	
1400	2000	PMG2021420	4,1		PMG2321420	4,6		PMG2521420	5,0	
1400	2200	PMG2021422	4,6		PMG2321422	5,1		PMG2521422	5,6	
1400	2400	PMG2021424	5,1		PMG2321424	5,6		PMG2521424	6,1	
1400	2600	PMG2021426	5,5		PMG2321426	6,1		PMG2521426	6,7	
1400	2800	PMG2021428	6,0		PMG2321428	6,6		PMG2521428	7,2	
1400	3000	PMG2021430	6,5		PMG2321430	7,1		PMG2521430	7,8	
1400	3200	PMG2021432	6,9		PMG2321432	7,6		PMG2521432	8,4	
1400	3400	PMG2021434	7,4		PMG2321434	8,1		PMG2521434	8,9	
1600	1600	PMG2021616	3,8		PMG2321616	4,2		PMG2521616	4,5	
1600	1800	PMG2021618	4,3		PMG2321618	4,7		PMG2521618	5,2	
1600	2000	PMG2021620	4,8		PMG2321620	5,3		PMG2521620	5,8	
1600	2200	PMG2021622	5,4		PMG2321622	5,9		PMG2521622	6,5	
1600	2400	PMG2021624	5,9		PMG2321624	6,5		PMG2521624	7,1	
1600	2600	PMG2021626	6,5		PMG2321626	7,1		PMG2521626	7,8	
1600	2800	PMG2021628	7,0		PMG2321628	7,7		PMG2521628	8,4	
1600	3000	PMG2021630	7,5		PMG2321630	8,3		PMG2521630	9,1	
1600	3200	PMG2021632	8,1		PMG2321632	8,9		PMG2521632	9,7	
1600	3400	PMG2021634	8,6		PMG2321634	9,5		PMG2521634	10,4	
1600	3600	PMG2021636	9,1		PMG2321636	10,1		PMG2521636	11,0	

## Listado de precios / Price list

# MAX

### Espesor del panel 100 mm

Thickness of 100 mm

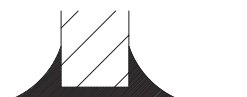

Sin suelo / Without floor

**De serie: Resistencia eléctrica en el marco-puerta y válvula de compensación de presiones para todas las cámaras de congelación (espesor de panel e= 100 mm).**

*As standard: Door heater and pressure compensation valve included for negative temperatures (panel thickness of 100 mm). For other dimensions and options, contact our sales department.*



Fondo ext.	Largo ext.	H ext. 2120mm / H int. 2020 mm			H ext. 2320 mm / H int. 2220mm			H ext. 2520mm / H int. 2420 mm		
		Código	Volumen int.	PVP	Código	Volumen int.	PVP	Código	Volumen int.	PVP
1200	1200	PMG2021212	1,9		PMG2221212	2,1		PMG2421212	2,3	
1200	1400	PMG2021214	2,3		PMG2221214	2,5		PMG2421214	2,8	
1200	1600	PMG2021216	2,7		PMG2221216	3,0		PMG2421216	3,2	
1200	1800	PMG2021218	3,1		PMG2221218	3,4		PMG2421218	3,7	
1200	2000	PMG2021220	3,5		PMG2221220	3,8		PMG2421220	4,2	
1200	2200	PMG2021222	3,8		PMG2221222	4,2		PMG2421222	4,6	
1200	2400	PMG2021224	4,2		PMG2221224	4,7		PMG2421224	5,1	
1200	2600	PMG2021226	4,6		PMG2221226	5,1		PMG2421226	5,6	
1200	2800	PMG2021228	5,0		PMG2221228	5,5		PMG2421228	6,0	
1200	3000	PMG2021230	5,4		PMG2221230	5,9		PMG2421230	6,5	
1200	3200	PMG2021232	5,8		PMG2221232	6,4		PMG2421232	7,0	
1400	1400	PMG2021414	2,8		PMG2221414	3,1		PMG2421414	3,3	
1400	1600	PMG2021416	3,2		PMG2221416	3,6		PMG2421416	3,9	
1400	1800	PMG2021418	3,7		PMG2221418	4,1		PMG2421418	4,5	
1400	2000	PMG2021420	4,1		PMG2221420	4,6		PMG2421420	5,0	
1400	2200	PMG2021422	4,6		PMG2221422	5,1		PMG2421422	5,6	
1400	2400	PMG2021424	5,1		PMG2221424	5,6		PMG2421424	6,1	
1400	2600	PMG2021426	5,5		PMG2221426	6,1		PMG2421426	6,7	
1400	2800	PMG2021428	6,0		PMG2221428	6,6		PMG2421428	7,2	
1400	3000	PMG2021430	6,5		PMG2221430	7,1		PMG2421430	7,8	
1400	3200	PMG2021432	6,9		PMG2221432	7,6		PMG2421432	8,4	
1400	3400	PMG2021434	7,4		PMG2221434	8,1		PMG2421434	8,9	
1600	1600	PMG2021616	3,8		PMG2221616	4,2		PMG2421616	4,5	
1600	1800	PMG2021618	4,3		PMG2221618	4,7		PMG2421618	5,2	
1600	2000	PMG2021620	4,8		PMG2221620	5,3		PMG2421620	5,8	
1600	2200	PMG2021622	5,4		PMG2221622	5,9		PMG2421622	6,5	
1600	2400	PMG2021624	5,9		PMG2221624	6,5		PMG2421624	7,1	
1600	2600	PMG2021626	6,5		PMG2221626	7,1		PMG2421626	7,8	
1600	2800	PMG2021628	7,0		PMG2221628	7,7		PMG2421628	8,4	
1600	3000	PMG2021630	7,5		PMG2221630	8,3		PMG2421630	9,1	
1600	3200	PMG2021632	8,1		PMG2221632	8,9		PMG2421632	9,7	
1600	3400	PMG2021634	8,6		PMG2221634	9,5		PMG2421634	10,4	
1600	3600	PMG2021636	9,1		PMG2221636	10,1		PMG2421636	11,0	

**Espesor del panel 100 mm**

Thickness of 100 mm



Con suelo / With floor

**De serie: Resistencia eléctrica en el marco-puerta y válvula de compensación de presiones para todas las cámaras de congelación (espesor de panel e= 100 mm).**

*As standard: Door heater and pressure compensation valve included for negative temperatures (panel thickness of 100 mm). For other dimensions and options, contact our sales department.*



Fondo ext.	Largo ext.	H ext. 2120 mm / H int. 1920 mm			H ext. 2320 mm / H int. 2120 mm			H ext. 2520 mm / H int. 2320 mm		
		Código	Volumen int.	PVP	Código	Volumen int.	PVP	Código	Volumen int.	PVP
1800	1800	PMG2121818	4,9		PMG2321818	5,4		PMG2521818	5,9	
1800	2000	PMG2121820	5,5		PMG2321820	6,1		PMG2521820	6,7	
1800	2200	PMG2121822	6,1		PMG2321822	6,8		PMG2521822	7,4	
1800	2400	PMG2121824	6,8		PMG2321824	7,5		PMG2521824	8,2	
1800	2600	PMG2121826	7,4		PMG2321826	8,1		PMG2521826	8,9	
1800	2800	PMG2121828	8,0		PMG2321828	8,8		PMG2521828	9,7	
1800	3000	PMG2121830	8,6		PMG2321830	9,5		PMG2521830	10,4	
1800	3200	PMG2121832	9,2		PMG2321832	10,2		PMG2521832	11,1	
1800	3400	PMG2121834	9,8		PMG2321834	10,9		PMG2521834	11,9	
1800	3600	PMG2121836	10,4		PMG2321836	11,5		PMG2521836	12,6	
1800	3800	PMG2121838	11,1		PMG2321838	12,2		PMG2521838	13,4	
2000	2000	PMG2122020	6,2		PMG2322020	6,9		PMG2522020	7,5	
2000	2200	PMG2122022	6,9		PMG2322022	7,6		PMG2522022	8,4	
2000	2400	PMG2122024	7,6		PMG2322024	8,4		PMG2522024	9,2	
2000	2600	PMG2122026	8,3		PMG2322026	9,2		PMG2522026	10,0	
2000	2800	PMG2122028	9,0		PMG2322028	9,9		PMG2522028	10,9	
2000	3000	PMG2122030	9,7		PMG2322030	10,7		PMG2522030	11,7	
2000	3200	PMG2122032	10,4		PMG2322032	11,4		PMG2522032	12,5	
2000	3400	PMG2122034	11,1		PMG2322034	12,2		PMG2522034	13,4	
2000	3600	PMG2122036	11,8		PMG2322036	13,0		PMG2522036	14,2	
2000	3800	PMG2122038	12,4		PMG2322038	13,7		PMG2522038	15,0	
2000	4000	PMG2122040	13,1		PMG2322040	14,5		PMG2522040	15,9	
2200	2200	PMG2122222	7,7		PMG2322222	8,5		PMG2522222	9,3	
2200	2400	PMG2122224	8,4		PMG2322224	9,3		PMG2522224	10,2	
2200	2600	PMG2122226	9,2		PMG2322226	10,2		PMG2522226	11,1	
2200	2800	PMG2122228	10,0		PMG2322228	11,0		PMG2522228	12,1	
2200	3000	PMG2122230	10,8		PMG2322230	11,9		PMG2522230	13,0	
2200	3200	PMG2122232	11,5		PMG2322232	12,7		PMG2522232	13,9	
2200	3400	PMG2122234	12,3		PMG2322234	13,6		PMG2522234	14,8	
2200	3600	PMG2122236	13,1		PMG2322236	14,4		PMG2522236	15,8	
2200	3800	PMG2122238	13,8		PMG2322238	15,3		PMG2522238	16,7	
2200	4000	PMG2122240	14,6		PMG2322240	16,1		PMG2522240	17,6	
2200	4200	PMG2122242	15,4		PMG2322242	17,0		PMG2522242	18,6	
2400	2400	PMG2122424	9,3		PMG2322424	10,3		PMG2522424	11,2	
2400	2600	PMG2122426	10,1		PMG2322426	11,2		PMG2522426	12,2	
2400	2800	PMG2122428	11,0		PMG2322428	12,1		PMG2522428	13,3	
2400	3000	PMG2122430	11,8		PMG2322430	13,1		PMG2522430	14,3	
2400	3200	PMG2122432	12,7		PMG2322432	14,0		PMG2522432	15,3	
2400	3400	PMG2122434	13,5		PMG2322434	14,9		PMG2522434	16,3	
2400	3600	PMG2122436	14,4		PMG2322436	15,9		PMG2522436	17,4	
2400	3800	PMG2122438	15,2		PMG2322438	16,8		PMG2522438	18,4	
2400	4000	PMG2122440	16,1		PMG2322440	17,7		PMG2522440	19,4	
2400	4200	PMG2122442	16,9		PMG2322442	18,7		PMG2522442	20,4	
2400	4400	PMG2122444	17,7		PMG2322444	19,6		PMG2522444	21,4	

## Listado de precios / Price list

# MAX

### Espesor del panel 100 mm

Thickness of 100 mm

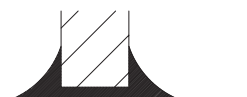

Sin suelo / Without floor

De serie: Resistencia eléctrica en el marco-puerta y válvula de compensación de presiones para todas las cámaras de congelación (espesor de panel e= 100 mm).

As standard: Door heater and pressure compensation valve included for negative temperatures (panel thickness of 100 mm). For other dimensions and options, contact our sales department.



Fondo ext.	Largo ext.	H ext. 2120mm / H int. 2020 mm			H ext. 2320 mm / H int. 2220mm			H ext. 2520mm / H int. 2420 mm		
		Código	Volumen int.	PVP	Código	Volumen int.	PVP	Código	Volumen int.	PVP
1800	1800	PMG2021818	4,9		PMG2221818	5,4		PMG2421818	5,9	
1800	2000	PMG2021820	5,5		PMG2221820	6,1		PMG2421820	6,7	
1800	2200	PMG2021822	6,1		PMG2221822	6,8		PMG2421822	7,4	
1800	2400	PMG2021824	6,8		PMG2221824	7,5		PMG2421824	8,2	
1800	2600	PMG2021826	7,4		PMG2221826	8,1		PMG2421826	8,9	
1800	2800	PMG2021828	8,0		PMG2221828	8,8		PMG2421828	9,7	
1800	3000	PMG2021830	8,6		PMG2221830	9,5		PMG2421830	10,4	
1800	3200	PMG2021832	9,2		PMG2221832	10,2		PMG2421832	11,1	
1800	3400	PMG2021834	9,8		PMG2221834	10,9		PMG2421834	11,9	
1800	3600	PMG2021836	10,4		PMG2221836	11,5		PMG2421836	12,6	
1800	3800	PMG2021838	11,1		PMG2221838	12,2		PMG2421838	13,4	
2000	2000	PMG2022020	6,2		PMG2222020	6,9		PMG2422020	7,5	
2000	2200	PMG2022022	6,9		PMG2222022	7,6		PMG2422022	8,4	
2000	2400	PMG2022024	7,6		PMG2222024	8,4		PMG2422024	9,2	
2000	2600	PMG2022026	8,3		PMG2222026	9,2		PMG2422026	10,0	
2000	2800	PMG2022028	9,0		PMG2222028	9,9		PMG2422028	10,9	
2000	3000	PMG2022030	9,7		PMG2222030	10,7		PMG2422030	11,7	
2000	3200	PMG2022032	10,4		PMG2222032	11,4		PMG2422032	12,5	
2000	3400	PMG2022034	11,1		PMG2222034	12,2		PMG2422034	13,4	
2000	3600	PMG2022036	11,8		PMG2222036	13,0		PMG2422036	14,2	
2000	3800	PMG2022038	12,4		PMG2222038	13,7		PMG2422038	15,0	
2000	4000	PMG2022040	13,1		PMG2222040	14,5		PMG2422040	15,9	
2200	2200	PMG2022222	7,7		PMG2222222	8,5		PMG2422222	9,3	
2200	2400	PMG2022224	8,4		PMG2222224	9,3		PMG2422224	10,2	
2200	2600	PMG2022226	9,2		PMG2222226	10,2		PMG2422226	11,1	
2200	2800	PMG2022228	10,0		PMG2222228	11,0		PMG2422228	12,1	
2200	3000	PMG2022230	10,8		PMG2222230	11,9		PMG2422230	13,0	
2200	3200	PMG2022232	11,5		PMG2222232	12,7		PMG2422232	13,9	
2200	3400	PMG2022234	12,3		PMG2222234	13,6		PMG2422234	14,8	
2200	3600	PMG2022236	13,1		PMG2222236	14,4		PMG2422236	15,8	
2200	3800	PMG2022238	13,8		PMG2222238	15,3		PMG2422238	16,7	
2200	4000	PMG2022240	14,6		PMG2222240	16,1		PMG2422240	17,6	
2200	4200	PMG2022242	15,4		PMG2222242	17,0		PMG2422242	18,6	
2400	2400	PMG2022424	9,3		PMG2222424	10,3		PMG2422424	11,2	
2400	2600	PMG2022426	10,1		PMG2222426	11,2		PMG2422426	12,2	
2400	2800	PMG2022428	11,0		PMG2222428	12,1		PMG2422428	13,3	
2400	3000	PMG2022430	11,8		PMG2222430	13,1		PMG2422430	14,3	
2400	3200	PMG2022432	12,7		PMG2222432	14,0		PMG2422432	15,3	
2400	3400	PMG2022434	13,5		PMG2222434	14,9		PMG2422434	16,3	
2400	3600	PMG2022436	14,4		PMG2222436	15,9		PMG2422436	17,4	
2400	3800	PMG2022438	15,2		PMG2222438	16,8		PMG2422438	18,4	
2400	4000	PMG2022440	16,1		PMG2222440	17,7		PMG2422440	19,4	
2400	4200	PMG2022442	16,9		PMG2222442	18,7		PMG2422442	20,4	
2400	4400	PMG2022444	17,7		PMG2222444	19,6		PMG2422444	21,4	

**Espesor del panel 100 mm**

Thickness of 100 mm

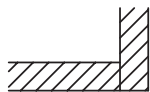

Con suelo / With floor

**De serie: Resistencia eléctrica en el marco-puerta y válvula de compensación de presiones para todas las cámaras de congelación (espesor de panel e= 100 mm).**

*As standard: Door heater and pressure compensation valve included for negative temperatures (panel thickness of 100 mm). For other dimensions and options, contact our sales department.*



Fondo ext.	Largo ext.	H ext. 2120 mm / H int. 1920 mm			H ext. 2320 mm / H int. 2120 mm			H ext. 2520 mm / H int. 2320 mm		
		Código	Volumen int.	PVP	Código	Volumen int.	PVP	Código	Volumen int.	PVP
2600	2600	PMG2122626	11,1		PMG2322626	12,2		PMG2522626	13,4	
2600	2800	PMG2122628	12,0		PMG2322628	13,2		PMG2522628	14,5	
2600	3000	PMG2122630	12,9		PMG2322630	14,2		PMG2522630	15,6	
2600	3200	PMG2122632	13,8		PMG2322632	15,3		PMG2522632	16,7	
2600	3400	PMG2122634	14,7		PMG2322634	16,3		PMG2522634	17,8	
2600	3600	PMG2122636	15,7		PMG2322636	17,3		PMG2522636	18,9	
2600	3800	PMG2122638	16,6		PMG2322638	18,3		PMG2522638	20,0	
2600	4000	PMG2122640	17,5		PMG2322640	19,3		PMG2522640	21,2	
2600	4200	PMG2122642	18,4		PMG2322642	20,4		PMG2522642	22,3	
2600	4400	PMG2122644	19,4		PMG2322644	21,4		PMG2522644	23,4	
2600	4600	PMG2122646	20,3		PMG2322646	22,4		PMG2522646	24,5	
2800	2800	PMG2122828	13,0		PMG2322828	14,3		PMG2522828	15,7	
2800	3000	PMG2122830	14,0		PMG2322830	15,4		PMG2522830	16,9	
2800	3200	PMG2122832	15,0		PMG2322832	16,5		PMG2522832	18,1	
2800	3400	PMG2122834	16,0		PMG2322834	17,6		PMG2522834	19,3	
2800	3600	PMG2122836	17,0		PMG2322836	18,7		PMG2522836	20,5	
2800	3800	PMG2122838	18,0		PMG2322838	19,8		PMG2522838	21,7	
2800	4000	PMG2122840	19,0		PMG2322840	20,9		PMG2522840	22,9	
2800	4200	PMG2122842	20,0		PMG2322842	22,0		PMG2522842	24,1	
2800	4400	PMG2122844	21,0		PMG2322844	23,2		PMG2522844	25,3	
2800	4600	PMG2122846	22,0		PMG2322846	24,3		PMG2522846	26,5	
2800	4800	PMG2122848	23,0		PMG2322848	25,4		PMG2522848	27,7	
3000	3000	PMG2123030	15,1		PMG2323030	16,6		PMG2523030	18,2	
3000	3200	PMG2123032	16,1		PMG2323032	17,8		PMG2523032	19,5	
3000	3400	PMG2123034	17,2		PMG2323034	19,0		PMG2523034	20,8	
3000	3600	PMG2123036	18,3		PMG2323036	20,2		PMG2523036	22,1	
3000	3800	PMG2123038	19,4		PMG2323038	21,4		PMG2523038	23,4	
3000	4000	PMG2123040	20,4		PMG2323040	22,6		PMG2523040	24,7	
3000	4200	PMG2123042	21,5		PMG2323042	23,7		PMG2523042	26,0	
3000	4400	PMG2123044	22,6		PMG2323044	24,9		PMG2523044	27,3	
3000	4600	PMG2123046	23,7		PMG2323046	26,1		PMG2523046	28,6	
3000	4800	PMG2123048	24,7		PMG2323048	27,3		PMG2523048	29,9	
3000	5000	PMG2123050	25,8		PMG2323050	28,5		PMG2523050	31,2	

## Listado de precios / Price list

# MAX

### Espesor del panel 100 mm

Thickness of 100 mm

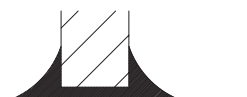

Sin suelo / Without floor

**De serie: Resistencia eléctrica en el marco-puerta y válvula de compensación de presiones para todas las cámaras de congelación (espesor de panel e= 100 mm).**

As standard: Door heater and pressure compensation valve included for negative temperatures (panel thickness of 100 mm). For other dimensions and options, contact our sales department.



Fondo ext.	Largo ext.	H ext. 2120mm / H int. 2020 mm			H ext. 2320 mm / H int. 2220mm			H ext. 2520mm / H int. 2420 mm		
		Código	Volumen int.	PVP	Código	Volumen int.	PVP	Código	Volumen int.	PVP
2600	2600	PMG2022626	11,1		PMG2222626	12,2		PMG2422626	13,4	
2600	2800	PMG2022628	12,0		PMG2222628	13,2		PMG2422628	14,5	
2600	3000	PMG2022630	12,9		PMG2222630	14,2		PMG2422630	15,6	
2600	3200	PMG2022632	13,8		PMG2222632	15,3		PMG2422632	16,7	
2600	3400	PMG2022634	14,7		PMG2222634	16,3		PMG2422634	17,8	
2600	3600	PMG2022636	15,7		PMG2222636	17,3		PMG2422636	18,9	
2600	3800	PMG2022638	16,6		PMG2222638	18,3		PMG2422638	20,0	
2600	4000	PMG2022640	17,5		PMG2222640	19,3		PMG2422640	21,2	
2600	4200	PMG2022642	18,4		PMG2222642	20,4		PMG2422642	22,3	
2600	4400	PMG2022644	19,4		PMG2222644	21,4		PMG2422644	23,4	
2600	4600	PMG2022646	20,3		PMG2222646	22,4		PMG2422646	24,5	
2800	2800	PMG2022828	13,0		PMG2222828	14,3		PMG2422828	15,7	
2800	3000	PMG2022830	14,0		PMG2222830	15,4		PMG2422830	16,9	
2800	3200	PMG2022832	15,0		PMG2222832	16,5		PMG2422832	18,1	
2800	3400	PMG2022834	16,0		PMG2222834	17,6		PMG2422834	19,3	
2800	3600	PMG2022836	17,0		PMG2222836	18,7		PMG2422836	20,5	
2800	3800	PMG2022838	18,0		PMG2222838	19,8		PMG2422838	21,7	
2800	4000	PMG2022840	19,0		PMG2222840	20,9		PMG2422840	22,9	
2800	4200	PMG2022842	20,0		PMG2222842	22,0		PMG2422842	24,1	
2800	4400	PMG2022844	21,0		PMG2222844	23,2		PMG2422844	25,3	
2800	4600	PMG2022846	22,0		PMG2222846	24,3		PMG2422846	26,5	
2800	4800	PMG2022848	23,0		PMG2222848	25,4		PMG2422848	27,7	
3000	3000	PMG2023030	15,1		PMG2223030	16,6		PMG2423030	18,2	
3000	3200	PMG2023032	16,1		PMG2223032	17,8		PMG2423032	19,5	
3000	3400	PMG2023034	17,2		PMG2223034	19,0		PMG2423034	20,8	
3000	3600	PMG2023036	18,3		PMG2223036	20,2		PMG2423036	22,1	
3000	3800	PMG2023038	19,4		PMG2223038	21,4		PMG2423038	23,4	
3000	4000	PMG2023040	20,4		PMG2223040	22,6		PMG2423040	24,7	
3000	4200	PMG2023042	21,5		PMG2223042	23,7		PMG2423042	26,0	
3000	4400	PMG2023044	22,6		PMG2223044	24,9		PMG2423044	27,3	
3000	4600	PMG2023046	23,7		PMG2223046	26,1		PMG2423046	28,6	
3000	4800	PMG2023048	24,7		PMG2223048	27,3		PMG2423048	29,9	
3000	5000	PMG2023050	25,8		PMG2223050	28,5		PMG2423050	31,2	